



**HAL**  
open science

# Learning to automatically detect features for mobile robots using second-order Hidden Markov Models

Olivier Aycard, Jean-François Mari, Richard Washington

► **To cite this version:**

Olivier Aycard, Jean-François Mari, Richard Washington. Learning to automatically detect features for mobile robots using second-order Hidden Markov Models. [Research Report] RR-4659, INRIA. 2002, pp.32. inria-00071926

**HAL Id: inria-00071926**

**<https://inria.hal.science/inria-00071926>**

Submitted on 23 May 2006

**HAL** is a multi-disciplinary open access archive for the deposit and dissemination of scientific research documents, whether they are published or not. The documents may come from teaching and research institutions in France or abroad, or from public or private research centers.

L'archive ouverte pluridisciplinaire **HAL**, est destinée au dépôt et à la diffusion de documents scientifiques de niveau recherche, publiés ou non, émanant des établissements d'enseignement et de recherche français ou étrangers, des laboratoires publics ou privés.

*Learning to automatically detect features for mobile robots using second-order Hidden Markov Models*

Olivier Aycard , Jean-François Mari, , Richard Washington

**N° 4659**

Novembre 2002

THÈME 3



*Rapport  
de recherche*



# Learning to automatically detect features for mobile robots using second-order Hidden Markov Models

Olivier Aycard <sup>\*</sup>, Jean-François Mari, <sup>†</sup>, Richard Washington <sup>‡</sup>

Thème 3 — Interaction homme-machine,  
images, données, connaissances  
Projets Sharp et Orpailleur

Rapport de recherche n° 4659 — Novembre 2002 — 32 pages

**Abstract:** *In this paper, we propose a new method based on Hidden Markov Models to interpret temporal sequences of sensor data from mobile robots to automatically detect features.*

*Hidden Markov Models have been used for a long time in pattern recognition, especially in speech recognition. Their main advantages over other methods (such as neural networks) are their ability to model noisy temporal signals of variable length.*

*We show in this paper that this approach is well suited for interpretation of temporal sequences of mobile-robot sensor data. We present two distinct experiments and results: the first one in an indoor environment where a mobile robot learns to detect features like open doors or T-intersections, the second one in an outdoor environment where a different mobile robot has to identify situations like climbing a hill or crossing a rock.*

**Key-words:** *sensor data interpretation, Hidden Markov Models, mobile robots*

<sup>\*</sup> IMAG - Université Joseph Fourier, 38 000 Grenoble, France, Olivier.Aycard@imag.fr

<sup>†</sup> LORIA - Université Nancy2, 54 506 Vandœuvre Cedex, France, jfmari@loria.fr

<sup>‡</sup> NASA contractor with RIACS, NASA Ames Research Center, MS 269-3, Moffett Field, CA 94035, USA, richw@email.arc.nasa.gov

# Détection automatique de balises par un robot mobile à l'aide de modèles de Markov cachés du second ordre

**Résumé :** *Dans cet article, nous proposons une nouvelle méthode fondée sur l'utilisation de modèles de Markov cachés pour interpréter des séquences de données capteurs d'un robot mobile afin de détecter des balises naturelles. Les modèles de Markov cachés sont utilisés depuis très longtemps en reconnaissance de formes spécialement en reconnaissance de la parole. Leur principale avantage par rapport aux autres méthodes (tel que les réseaux de neurones) sont leur capacité à modéliser des signaux bruités temporels de longueur variable.*

*Nous montrons dans cet article que cette approche est bien adaptée pour l'interprétation de séquences temporelles de données capteurs d'un robot mobile. Nous présentons deux expériences et des résultats : la première dans un environnement intérieur structuré où un robot mobile apprend à détecter des balises naturelles telles que des portes ouvertes ou des intersections, la deuxième dans un environnement extérieur où un autre robot mobile doit identifier des situations telles que la montée d'une colline ou le franchissement d'un caillou.*

**Mots-clés :** *interprétation de données capteurs, modèles de Markov cachés, robots mobiles*

# 1 Introduction

A mobile robot operating in a dynamic environment is provided with sensors (infrared sensors, ultrasonic sensors, tactile sensors, cameras...) in order to perceive its environment. Unfortunately, the numeric, noisy data furnished by these sensors are not directly useful; they must first be interpreted to provide accurate and usable information about the environment. This interpretation plays a crucial role, since it makes it possible for the robot to detect pertinent features in its environment and to use them for various tasks.

For instance, for a mobile robot, the automatic recognition of features is an important issue for the following reasons:

1. For successful navigation in large-scale environments, mobile robots must have the capability to localize themselves in their environment. Almost all existing localization approaches (Borenstein, Everett, & Feng, 1996) extract a small set of features. During navigation, mobile robots detect features and match them with known features of the environment in order to compute their position;
2. Feature recognition is the first step in the automatic construction of maps. For instance, at the topological level of his “spatial semantic hierarchy” system, Kuipers (2000) incrementally builds a topological map by first detecting pertinent features while the robot moves in the environment and then determining the link between a new detected feature and features contained in the current map;
3. Features can be used by a mobile robot as subgoals for a navigation plan (Lazanas & Latombe, 1995).

In semi-autonomous or remote, teleoperated robotics, automatic detection of features is a necessary ability. In the case of limited and delayed communication, such as for planetary rovers, human interaction is restricted, so feature detection can only be practically performed through on-board interpretation of the sensor information. Moreover, feature detection from raw sensor data, especially when based on a combination of sensors, is a complex task that generally cannot be done in real time by humans, which would be necessary even if teleoperation were possible given the communication constraints. For all these reasons, feature detection has received considerable attention over the past few years. This problem can be classified with the following criteria:

**Natural/artificial.** The first criterion is the nature of the feature. The features can be artificial, that is, added to the existing environment. Becker et al (1995) define a set of artificial features<sup>†</sup> located on the ceiling and use a camera to detect them. Other techniques use natural features, that is, features already existing in the environment. For instance, Kortenkamp, Baker, and Weymouth (1992) use ultrasonic sensors to detect natural features like open doors and T-intersections.

Using artificial features makes the process of detection and distinction of features easier, because the features are designed to be simple to detect. But this approach can be time-consuming, because the features have to be designed and to be positioned in the environment. Moreover, using artificial features is impossible in unknown or remote environments.

---

<sup>†</sup>The features are patterns composed of 3x3 squares, and each square is colored in black or white

**Analytical/statistical methods.** Feature detection has been addressed by different approaches such as analytical methods or pattern classification methods. In the analytical approach, the problem is studied as a reasoning process. A knowledge based system uses rules to build a representation of features. For instance, Kortenkamp, Baker, and Weymouth (1992) use rules about the variation of the sonar sensors to learn different types of features and adds visual information to distinguish two features of the same type. In contrast, a statistical pattern-classification system attempts to describe the observations coming from the sensors as a random process. The recognition process consists of the association of the signal acquired from sensors with a model of the feature to identify. For instance, Yamauchi (1995) uses ultrasonic sensors to build evidence grids (Elfes, 1989). An evidence grid is a grid corresponding to a discretization of the local environment of the mobile robot. In this grid, Yamauchi's method updates the probability of occupancy of each grid tile with several sensor data. To perform the detection, he defines an algorithm to match two evidence grids.

These two approaches are complementary. In the analytical approach, we aim to understand the sensor data and build a representation of these data. But as the sensor data may be noisy, so their interpretation may not be straightforward; moreover, overly simple descriptions of the sensor data (e.g., "current rising, steady, then falling") may not directly correspond to the actual data.

In the second approach, we build models that represent the statistical properties of the data. This approach naturally takes into account the noisy data, but it is generally difficult to understand the correspondence between detected features and the sensor data.

A solution that combines the two approaches could build models corresponding to human's understanding of the sensor data, and adjust the model parameters according to the statistical properties of the data.

**Automatic/manual feature definition.** The set of features to detect could be given manually or discovered automatically (Thrun, 1998). In the manual approach, the set is defined by humans using the perception they have of the environment. Since high level robotic systems are generally based loosely on human perception, the integration of feature detection in such a system is easier than for automatically-discovered features. Moreover, in teleoperated robotics, where humans interact with the robot, the features must correspond to the high level perception of the operator to be useful. These are the main reasons the set is almost always defined by humans. However, properly defining the features so that they can be recognized robustly by a robot remains a difficult problem; this paper proposes a method for this problem. In contrast, when features are discovered automatically, humans must find the correspondence between features perceived by the robot and features they perceive. The difficulty now rests on the shoulders of the humans.

**Temporally extended/instantaneous features.** Some features can only be identified by considering a temporal sequence of sensor information, not simply a snapshot, especially with telemetric sensors. Consider for example the detection of a feature in (Kortenkamp et al., 1992) or the construction of an evidence grid in (Yamauchi, 1995): these two operations use a temporal sequence of sensor information. In general, instantaneous (i.e., based over a simple snapshot) detection is less robust than temporal detection.

This paper describes an approach that combines an analytical approach for the high-level topology of the environment with a statistical approach to feature detection. The approach

is designed to detect natural, temporally extended features that have been manually defined. The feature detection uses Hidden Markov Models (HMMs). HMMs are a particular type of probabilistic automata. The topology of these automata corresponds to a human’s understanding of sequences of sensor data characterizing a particular feature in the robot’s environment. We use HMMs for pattern recognition. From a set of training data produced by its sensors and collected at a feature that it has to identify — a door, a rock, . . . — the robot adjusts the parameters of the corresponding model to take into account the statistical properties of the sequences of sensor data. At recognition time, the robot chooses the model whose probability given the sensor data — the *a posteriori* probability — is maximized. We combine analytical methods to define the topology of the automata with statistical pattern-classification methods to adjust the parameters of the model.

The HMM approach is a flexible method for handling the large variability of complex temporal signals; for example, it is a standard method for speech recognition (Rabiner, 1989). In contrast to dynamic time warping, where heuristic training methods for estimating templates are used, stochastic modeling allows probabilistic and automatic training for estimating models. The particular approach we use is the second-order HMM (HMM2), which have been used in speech recognition (Mari, Haton, & Kriouile, 1997), often out-performing first-order HMMs.

This paper is organized as follow. We first define the HMM2 and describe the algorithms used for training and recognition. Section 3 is the description of our method for feature detection combining HMM2s with a grammar-based analytical method describing the environment. In section 4, we present an experiment of our method to detect natural features like open doors or T-intersections in an indoor structured environment for an autonomous mobile robot. A second experiment on a semi-autonomous mobile robot in an outdoor environment is described in section 5. Then we report related work in section 6. We give some conclusions and perspectives in section 7.

## 2 Second-order Hidden Markov Models

In this section, we only present second-order Hidden Markov Models in the special case of multi dimensional continuous observations (representing the data of several sensors). We also detail the second-order extension of the learning algorithm (Viterbi algorithm) and the recognition algorithm (Baum-Welch algorithm). A very complete tutorial on first order Hidden Markov Models can be found in Rabiner (1989).

### 2.1 Definition

In an HMM2, the underlying state sequence is a second-order Markov chain. Therefore, the probability of a transition between two states at time  $t$  depends on the states in which the process was at time  $t - 1$  and  $t - 2$ .

A second order Hidden Markov Model  $\lambda$  is specified by:

- a set of  $N$  states called  $S$  containing at least one final state;
- a 3 dimensional matrix  $a_{ijk}$  over  $S \times S \times S$

$$\begin{aligned} a_{ijk} &= Prob(q_t = s_k / q_{t-1} = s_j, q_{t-2} = s_i) \\ &= Prob(q_t = s_k / q_{t-1} = s_j, q_{t-2} = s_i, q_{t-3} = \dots) \end{aligned} \tag{1}$$



with the constraints

$$\sum_{k=1}^N a_{ijk} = 1 \quad \text{with } 1 \leq i \leq N, 1 \leq j \leq N$$

where  $q_t$  is the actual state at time  $t$  ;

- each state  $s_i$  is associated with a mixture of Gaussian distributions :

$$b_i(O_t) = \sum_{m=1}^M c_{im} \mathcal{N}(O_t; \mu_{im}, \Sigma_{im}), \quad (2)$$

$$\text{with } \sum_{m=1}^M c_{im} = 1$$

where  $O_t$  is the input vector (the frame) at time  $t$ . The mixture of Gaussian distributions is one of the most powerful probability distribution to represent complex and multi-dimensional probability space.

The probability of the state sequence  $Q = q_1, q_2, \dots, q_T$  is defined as

$$Prob(Q) = \pi_{q_1} a_{q_1 q_2} \prod_{t=3}^T a_{q_{t-2} q_{t-1} q_t} \quad (3)$$

where  $\Pi_i$  is the probability of state  $s_i$  at time  $t = 1$  and  $a_{ij}$  is the probability of the transition  $s_i \rightarrow s_j$  at time  $t = 2$ .

Given a sequence of observed vectors  $O = o_1, o_2, \dots, o_T$ , the joint state-output probability  $Prob(Q, O/\lambda)$ , is defined as :

$$Prob(Q, O/\lambda) = \Pi_{q_1} b_{q_1}(O_1) a_{q_1 q_2} b_{q_2}(O_2) \prod_{t=3}^T a_{q_{t-2} q_{t-1} q_t} b_{q_t}(O_t) \quad (4)$$

## 2.2 The Viterbi algorithm

The recognition is carried out by the Viterbi algorithm (Forney, 1973) which determines the most likely state sequence given a sequence of observations.

In Hidden Markov Models, many state sequences may generate the same observed sequence  $O = o_1, \dots, o_T$ . Given one such output sequence, we are interested in determining the most likely state sequence  $Q = q_1, \dots, q_T$  that could have generated the observed sequence.

The extension of the Viterbi algorithm to HMM2 is straightforward. We simply replace the reference to a state in the state space  $\mathbf{S}$  by a reference to an element of the 2-fold product space  $\mathbf{S} \times \mathbf{S}$ . The most likely state sequence is found by using the probability of the partial alignment ending at transition  $(s_j, s_k)$  at times  $(t-1, t)$

$$\begin{aligned} \delta_t(j, k) = & \quad (5) \\ & Prob(q_1, \dots, q_{t-2}, q_{t-1} = s_j, q_t = s_k, o_1, \dots, o_t/\lambda) \\ & 2 \leq t \leq T, \quad 1 \leq j, k \leq N. \end{aligned}$$

Recursive computation is given by equation

$$\begin{aligned} \delta_t(j, k) &= \max_{1 \leq i \leq N} [\delta_{t-1}(i, j) \cdot a_{ijk}] \cdot b_k(O_t) \\ &3 \leq t \leq T, \quad 1 \leq j, k \leq N. \end{aligned} \quad (6)$$

The Viterbi algorithm is a dynamic programming search that computes the best partial state sequence up to time  $t$  for all states. The most likely state sequence  $q_1, \dots, q_T$  is obtained by keeping track of back pointers for each computation of which previous transition leads to the maximal partial path probability. By tracing back from the final state, we get the most likely state sequence.

### 2.3 The Baum-Welch algorithm

The learning of the models is performed by the Baum-Welch algorithm using the maximum likelihood estimation criteria that determines the best model's parameters according to the corpus of items. Intuitively, this algorithm counts the number of occurrences of each transition between the states and the number of occurrences of each observation in a given state in the training corpus. Each count is weighted by the probability of the alignment (state, observation). It must be noted that this criteria does not try to separate models like a neural network does, but only tries to increase the probability that a model generates its corpus independently of what the other models can do.

Since many state sequences may generate a given output sequence, the probability that a model  $\lambda$  generates a sequence  $o_1, \dots, o_T$  is given by the sum of the joint probabilities (given in equation 4) over all state sequences (i.e, the marginal density of output sequences). To avoid combinatorial explosion, a recursive computation similar to the Viterbi algorithm can be used to evaluate the above sum. The forward probability  $\alpha_t(j, k)$  is :

$$prob((O_1, \dots, O_t = o_1, \dots, o_t), q_{t-1} = s_j, q_t = s_k / \lambda) \quad (7)$$

This probability represents the probability of starting from state 0 and ending with the transition  $(s_j, s_k)$  at time  $t$  and generating output  $o_1, \dots, o_t$  using all possible state sequences in between. The Markov assumption allows the recursive computation of the forward probability as :

$$\begin{aligned} \alpha_{t+1}(j, k) &= \sum_{i=1}^N \alpha_t(i, j) \cdot a_{ijk} \cdot b_k(O_{t+1}), \\ &2 \leq t \leq T - 1, \quad 1 \leq j, k \leq N \end{aligned} \quad (8)$$

This computation is similar to Viterbi decoding except that summation is used instead of max. The value  $\alpha_T(j, k)$  where  $s_k = N$  is the probability that the model  $\lambda$  generates the sequence  $o_1, \dots, o_t$ . Another useful quantity is the backward function  $\beta_t(i, j)$ , defined as the probability of the partial observation sequence from  $t+1$  to  $T$ , given the model  $\lambda$  and the transition  $(s_i, s_j)$  between times  $t-1$  and  $t$ , can be expressed as :

$$\begin{aligned} \beta_t(i, j) &= Prob(O_{t+1}, \dots, O_T / q_{t-1} = s_i, q_t = s_j, \lambda), \\ &2 \leq t \leq T - 1, \quad 1 \leq i, j \leq N \end{aligned} \quad (9)$$

The Markov assumption allows also the recursive computation of the backward probability as :

## 1. Initialization

$$\beta_T(i, j) = 1 \text{ if } 1 \leq i, j \leq N$$

2. Recursion for  $2 \leq t \leq T - 1$ 

$$\beta_t(i, j) = \sum_{k=1}^N \beta_{t+1}(j, k) \cdot a_{ijk} \cdot b_k(O_{t+1}) \text{ if } 1 \leq i, j \leq N$$

Given a model  $\lambda$  and an observation sequence  $O$ , we define  $\eta_t(i, j, k)$  as the probability of the transition  $s_i \rightarrow s_j \rightarrow s_k$  between  $t - 1$  and  $t + 1$  during the emission of the observation sequence.

$$\eta_t(i, j, k) = P(q_{t-1} = s_i, q_t = s_j, q_{t+1} = s_k / O, \lambda), \quad 2 \leq t \leq T - 1.$$

We deduce:

$$\eta_t(i, j, k) = \frac{\alpha_t(i, j) a_{ijk} b_k(O_{t+1}) \beta_{t+1}(j, k)}{P(O | \lambda)}, \quad 2 \leq t \leq T - 1. \quad (10)$$

As in the first order, we define  $\xi_t(i, j)$  and  $\gamma_t(i)$ :

$$\xi_t(i, j) = \sum_{k=1}^N \eta_t(i, j, k), \quad (11)$$

$$\gamma_t(i) = \sum_{j=1}^N \xi_t(i, j). \quad (12)$$

$\xi_t(i, j)$  represents the *a posteriori* probability that the stochastic process accomplishes the transition  $s_i \rightarrow s_j$  between  $t - 1$  and  $t$  assuming the whole utterance.

$\gamma_t(i)$  represents the *a posteriori* probability that the process is in the state  $i$  at time  $t$  assuming the whole utterance.

At this point, to get the new maximum likelihood estimation (ML) of the  $HMM_2$ , we can choose two ways of normalizing: one way gives an  $HMM_1$ , the other an  $HMM_2$ .

The transformation in  $HMM_1$  is done by averaging the counts  $\eta_t(i, j, k)$  over all the states  $i$  that have been visited at time  $t - 1$ .

$$\eta_t^1(j, k) = \sum_{i=1}^N \eta_t(i, j, k) \quad (13)$$

is the classical first order count of transitions between 2  $HMM_1$  states between  $t$  and  $t + 1$ .

Finally, the first-order maximum likelihood (ML) estimate of  $\overline{a_{ijk}}$  is:

$$\overline{a_{ijk}} = \frac{\sum_t \eta_t^1(j, k)}{\sum_{k,t} \eta_t^1(j, k)} = \frac{\sum_{i,t} \eta_t(i, j, k)}{\sum_{i,k,t} \eta_t(i, j, k)}. \quad (14)$$

This value is independent of  $i$  and can be written as  $\overline{a_{jk}}$ .

The second-order ML estimate of  $\overline{a_{ijk}}$  is given by the equation:

$$\begin{aligned} \overline{a_{ijk}} &= \frac{\sum_t \eta_t(i, j, k)}{\sum_{k,t} \eta_t(i, j, k)} \\ &= \frac{\sum_{t=1}^{T-2} \eta_{t+1}(i, j, k)}{\sum_{t=1}^{T-2} \xi_t(i, j)}. \end{aligned} \quad (15)$$

The ML estimates of the mean and covariance are given by the formulas:

$$\overline{\mu}_i = \frac{\sum_t \gamma_t(i) O_t}{\sum_t \gamma_t(i)}, \quad (16)$$

$$\overline{\Sigma}_i = \frac{\sum_t \gamma_t(i) (O_t - \mu_i)(O_t - \mu_i)^t}{\sum_t \gamma_t(i)}. \quad (17)$$

### 3 Application to mobile robotics

The method presented in this paper performs feature detection by combining HMM2s with a grammar-based description of the environment. To apply second order Hidden Markov Models to automatically detect features, we must accomplish a number of steps. In this section we review these steps and our approach for treating the issues arising in each of them. In the following sections we expand further on the specifics for each experiment.

The steps necessary to apply HMM2s to detect features are the following:

1. Defining the number of distinct features to identify and their characterization.

As Hidden Markov Models have the ability to model signals whose properties change with time, we choose a set of sensors (as the observations) that have noticeable variations when the mobile robot is observing a particular feature. The features are chosen for the fact that they are repeatable and human-observable (for the purposes of labeling and validation). So, we define coarse rules to identify each feature, based on the variation of the sensors constituting the observation to identify each feature. These rules are for human use, for segmentation and labeling of the data stream of the training corpus. The set of chosen features is a complete description of what the mobile robot can see during its run. All other unforeseen features are treated as noise.

2. Finding the most appropriate model to represent a specific feature.

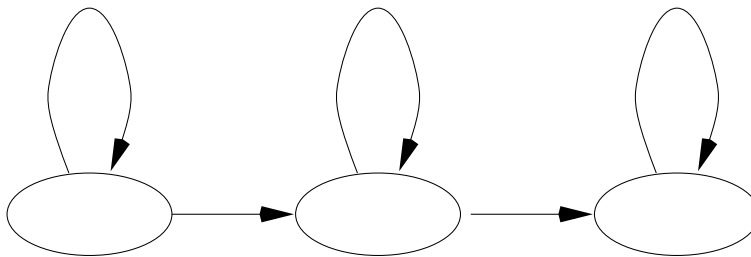

Figure 1: Topology of states used for each model of feature

Designing the right model in pattern recognition is known as the model selection problem and is still an open area of research. Based on our experience in speech recognition, we used the well known left-right model (figure 1), which efficiently performs temporal segmentation of the data. Recognition begins in the leftmost state, and each time an event characterizing the feature is recognized it advances to the next state to the right. When the rightmost state has been reached, the recognition of the feature is complete.

The number of states is generally chosen as a monotone function of the length of the pattern to be identified according to the state duration probabilities.

In the model depicted in figure 1, the duration in state  $j$  may be defined as :

$$\begin{aligned} d_j(0) &= 0 \\ d_j(1) &= a_{ijk}, \quad i \neq j \neq k \\ d_j(n) &= (1 - a_{ijk}) \cdot a_{jjj}^{n-2} \cdot (1 - a_{jjj}), \quad n \geq 2 \end{aligned}$$

The state duration in a HMM2 is governed by two parameters: the probability of entering a state only once, and the probability of visiting a state at least twice, with the latter modeled as a geometric decay. This distribution fits a probability density of durations (Crystal & House, 1988) better than the classical exponential distribution of an HMM1. This property is of great interest in speech recognition when a HMM2 models a phoneme in which a state captures only 1 or 2 frames.

This choice gives generally high rate of recognition. Sometimes, adding or suppressing one or two states has been experimentally observed to increase the rate of recognition. The number of states is generally chosen to be the same for all the models.

3. Collecting and labeling a corpus of sequence of observations during several runs to perform learning.

The corpus is used to adjust the parameters of the model to take into account the statistical properties of the sequences of sensor data. Typically, the corpus consists of a set of sequences of features collected during several runs of the mobile robot. So, these runs should be as representative as possible of the set of situations in which features could be detected. The construction of the corpus is time-consuming, but is crucial to effective learning.

A model is trained with sequences of sensor data corresponding to the particular feature it represents. Since a run is composed of a sequence of features (and not only one feature), we need to segment and label each run. To perform this operation, we use the previously defined coarse rules to identify each feature and extract the relevant sequences of data. Finally, we group the segments of the runs corresponding to the same feature to form a corpus to train the model of that feature.

4. Defining a way to be able to detect all the features seen during a run of the robot.

For this, the robot's environment is described by means of a grammar that restricts the set of possible sequences of models. Using this grammar, all the HMM2s are merged in a bigger HMM on which the Viterbi algorithm is used. This grammar is a regular expression describing the legal sequences of HMM2s; it is used to know the possible ways of merging the HMM2s and their likelihood. More formally, this grammar represents all possible Markov chains corresponding to the hidden part of the merged models. In these chains, nodes correspond to HMM2s associated with a particular feature. Edges between two HMM2s correspond to a merge between the last state of one HMM2 and the first state of the other HMM2. The probability associated with each edge represents the likelihood of the merge.

Then, the most likely sequence of states, as determined by the Viterbi algorithm, determines the ordered list of features that the robot saw during its run. It must be noted that the list of models is known only when the run is completed. We make the hypothesis that two or more of the features cannot overlap. The use of a grammar has another important

advantage. It allows the elimination of some sequences that will never happen in the environment. From a computational point of view, the grammar will avoid some useless calculations.

The grammar can be given a priori or learned. To learn the grammar, we use the former models and estimate them on unsegmented data like in the recognition phase. Specifically, we merge all the models seen by the robot during a complete run into a larger model corresponding to the sequence of observed items and train the resulting model with the unsegmented data. In the two following experiments, we experimentally saw that we obtain better results by defining the grammar a priori.

#### 5. Evaluating the rate of recognition.

For this, we define a test corpus composed of several runs. For each run, a human compares the sequence of features composing the run, using knowledge of the environment, with what has been detected by the Viterbi algorithm. A feature is recognized if it is detected by the corresponding model close to its real geometric position. A few types of errors can occur:

**Insertion:** the robot has seen a non-existing feature (false positive). This corresponds to an over-segmentation in the recognition process. Insertions are currently considered when the width of the inserted feature is more than 80 centimeters;

**Deletion:** the robot has missed the feature (false negative);

**Substitution:** the robot has confused the feature with another.

In the experiments that we have run, the results are summarized first as confusion matrices, where an element  $c_{ij}$  is the number of times the model  $j$  has been recognized when the right answer was feature  $i$ , and second with the global rate of recognition, insertion, substitution and deletion.

In the two following sections, we present two experiments where we used second-order Hidden Markov Models to detect features using sequence of mobile-robot sensor data. In each section, after a brief description of the problem and the mobile robot used, we explain the specific solution to each of the issues introduced in this section.

## 4 First experiment: Learning and recognition of features in an indoor structured environment

In this first experiment, we used second order Hidden Markov Models to learn and to recognize indoor features such as T-intersections and open doors given sequences of data from ultrasonic sensors of an autonomous mobile robot. These features are generally called *places*. This experiment is divided in two parts: first, we explain how we use HMM2s to learn to detect these particular features, and second, by analyzing the results, we give some improvements to increase the rate of recognition.

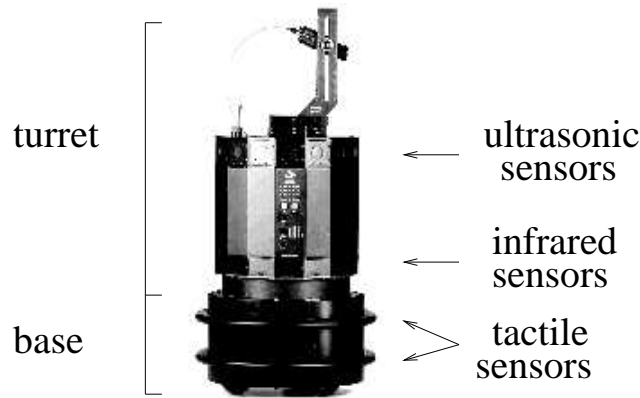

Figure 2: Our mobile robot

## 4.1 The Nomad200 mobile robot

In this experiment, we used a Nomad200 (figure 2) manufactured by Nomadic Technologies\*. It is composed of a base and a turret. The base consists of 3 wheels and tactile sensors. The turret is an uniform 16-sided polygon. On each side, there is an infrared and an ultrasonic sensor. The turret can rotate independently of the base.

**Tactile Sensors:** A ring of 20 tactile sensors surrounds the base. They detect contact with objects. They are just used for emergency situations. They are associated with low-level reflexes such as emergency stop and backward movement.

**Ultrasonic Sensors:** The angle between two ultrasonic sensors is 22.5 degrees, and each ultrasonic sensor has a beam width of approximately 23.6 degrees. By examining all 16 sensors, we can obtain a 360 degree panoramic view fairly rapidly. The ultrasonic sensors give range information from 17 to 255 inches. But the quality of the range information greatly depends on the surface of reflection and the angle of incidence between the ultrasonic sensor and the object.

**Infrared Sensors:** The infrared sensors measure the light differences between an emitted light and an reflected light. They are very sensitive to the ambient light, the object color, and the object orientation. We assume that for short distances the range information is acceptable, so we just use infrared sensors for the areas shorter than 17 inches, where the ultrasonic sensors are not usable.

## 4.2 Specifics of HMM2 application to indoor place identification

Here we discuss the specific issues arising from applying HMM2s to the problem of indoor place identification, along with our solutions to those issues. The numbering corresponds to the numbering of the steps in section 3.

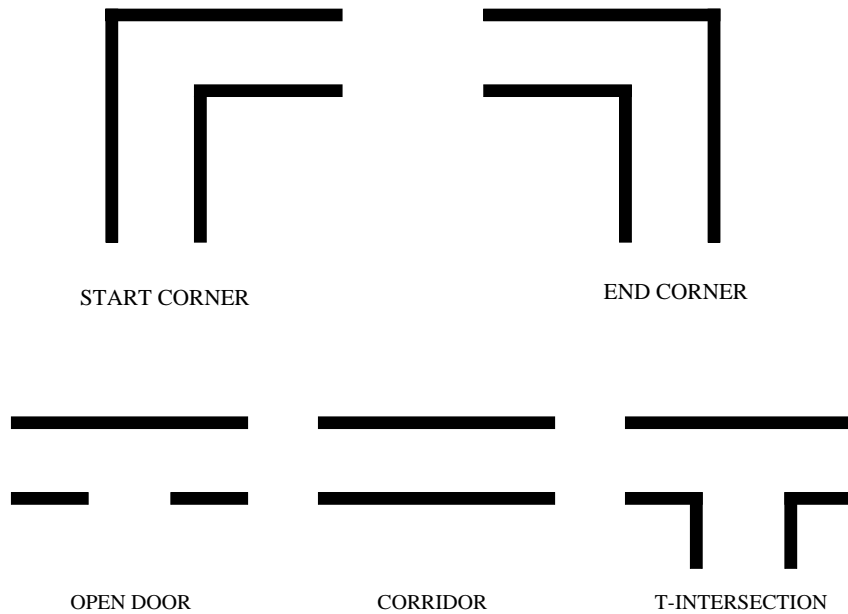

Figure 3: The places to learn

#### 4.2.1 The set of places

Currently, we model five distinctive places that are representative of an office environment: a corridor, a T-intersection, a “starting” corner when the robot moves away from the corner, an “ending” corner when the robot arrives at this corner, and an open door (figure 3). This set of items is a complete description of what the mobile robot can see during its run. All other unforeseen objects, like people wandering along in a corridor, are treated as noise.

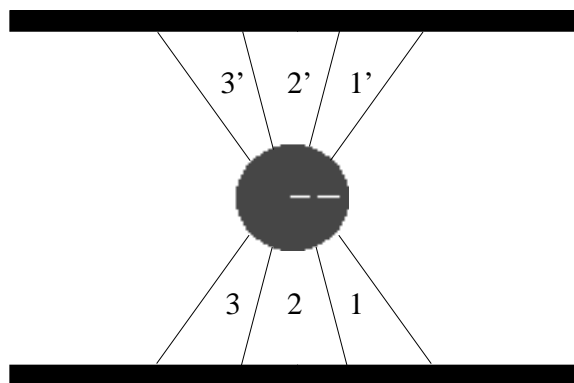

Figure 4: The six sonars used for the characterization on each side

To characterize each feature, we need to select the pertinent sensor measures to observe a place. This task is complex because the sensor measures are noisy and because at the same time that there is a place on the right side of the robot, there is another place on the left side of the robot. For these reasons, we choose to characterize features separately for each side, using the sensors perpendicular to each wall of the corridor and its two neighbor sensors (figure 4) . These three sensors normally give valid measures.

\*<http://www.robots.com>



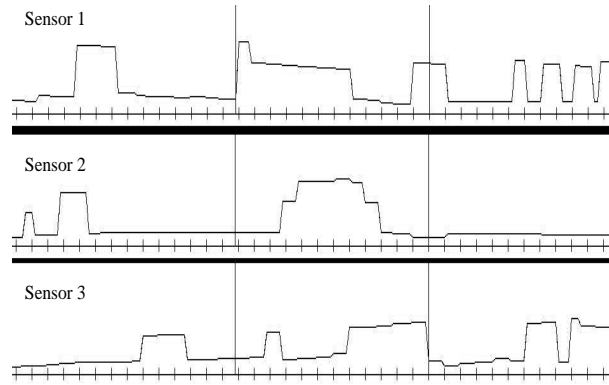

Figure 5: The characterization corresponding to a T-intersection on the right side of the robot

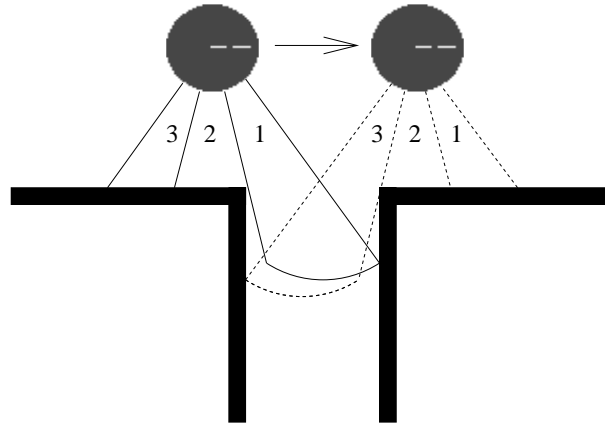

Figure 6: The three sonars used for the segmentation of a T-intersection

Since all places except the corridor cause a noticeable variation on these three sensors over time, we define the beginning of a place when the first sensor's measure suddenly increases and the end of a place when the last sensor's measure suddenly decreases. Figure 5 shows an example of the segmentation on the right side with these three sensors of a part of an acquisition corresponding to a T-intersection. The first line segment is the beginning of the T-intersection (sudden increase on the first sensor), and the second line segment is the end of the T-intersection (sudden decrease on the third sensor). To the left of the first line and to the right of the second line are corridors. Figure 6 shows the position of the robot at the beginning and at the end of the T-intersection and the measures of the three sensors used at these two positions for the characterization.

#### 4.2.2 The model to represent each place

In the formalism described in section 2, each place to be recognized is modeled by an HMM2 whose topology is depicted in figure 1.

Each model has three states. Intuitively, we can think that the first state will contain the strong increase of the signals corresponding to the beginning of the place, the second state will contain the stationary part of the signals (where the derivative is nearly equal to zero) and the third state will contain the end of the place where the signal decreases strongly. This is

why we choose to model each place by a three-state model. The observations used as input of each model consist of the first derivative of the value of the three sensors used to characterize a particular place.

### 4.2.3 Corpus collecting and labeling

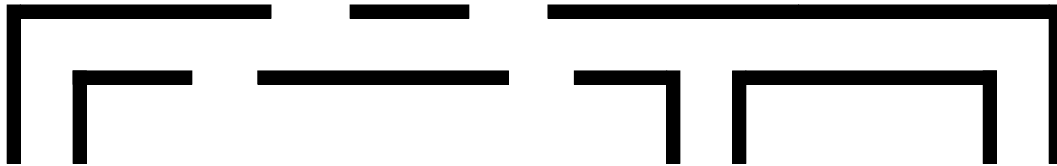

Figure 7: The corridor used to make the learning corpus

We built a corpus to train a model for each of the 5 places. For this, our mobile robot made 50 passes (back and forth) in a very long corridor (approximately 30 meters). This corridor (figure 7) contains two corners (one at the start of the corridor and one at the end), a T-intersection and some open doors (at least four, and not always the same). The robot ran with a simple navigation algorithm (Aycard, Charpillet, & Haton, 1997) to stay in the middle of the corridor in a direction parallel to the two walls constituting the corridor. While running, the robot stored all of its ultrasonic sensor measures. The acquisitions were done in real conditions with people wandering in the lab, doors completely or partially opened and static obstacles like shelves.

A pass in the corridor contains not only one place but all the places seen while running in the corridor. To learn a particular place, we must manually segment and label passes in distinctive places. The goal of the segmentation and the labeling is to identify the sequence of places the robot saw during a given pass. To perform this task, we use the rules defined to characterize a place. We segment and label independently the sonar measures from each side of the robot. Finally, we group the segments from each pass corresponding to the same place. Each learning corpus associated with a model contains sequences of observations on both sides of the robot.

### 4.2.4 The recognition phase

The goal of the recognition process is to identify the 4 places (start-corner, end-corner, open-door and T-intersection) in the corridor. We use a fifth model for the corridor because the Viterbi algorithm needs to map each frame to a model during recognition. The corridor model connects 2 items much like a silence between 2 words in speech recognition. During this experiment, the robot uses its own reactive algorithm to navigate in the corridor and must decide which places have been encountered during the run. We took 40 acquisitions and used the five models trained to perform the recognition. The recognition is independently processed on each side.

### 4.2.5 Preliminary results and discussion

The results of the recognition are presented in tables 1 and 2, using the error types defined in section 3, step 5. Insertions are shown in the last column, and deletions in the fifth row. The rate of recognition is for existing places (capturing true positives and false negatives), measured independently from insertions (false positives).

	start corner	end corner	T-inter.	open door	Ins.
Start corner	15	0	0	0	8
End corner	0	19	0	0	17
T-inter.	1	1	16	38	67
open door	0	0	2	77	0
deletions	0	0	0	1	0
Total	16	20	18	116	92
% reco.	93	95	89	63	

Table 1: Confusion matrix

	number	%
Seen places	170	100
Recognized places	127	75
Substituted places	42	24
Deleted places	1	1
Inserted places	92	54

Table 2: Global rate of recognition

The “start corner” place and “end corner” place are very well recognized. These places have a very particular pattern, and can only rarely be confused with another.

T-intersections are sometimes confused with open doors and open doors with T-intersections. In fact, one could argue that it is unfair to expect them to be reliably distinguished, because the signal provided by the sensors does not carry the information necessary for discriminating these two models. The corridors are nearly as narrow as the doors. A level incorporating knowledge about the environment could resolve this problem.

Most of the insertions are due to the inaccuracy of the navigation algorithm and to unexpected obstacles. Sometimes the mobile robot has to avoid people or obstacles, and in these cases it does not always run parallel to the two walls, and in the middle of the corridor. These conditions cause reflections on the three sensors which are interpreted as places.

### 4.3 Improvement of the recognition rate

To improve the recognition, we have to solve two major problems. First, we must reduce the confusion rate between open-doors and T-intersections. For this, we have to find a way to improve the discriminating power of these two HMM2s. These two types of places have a similar pattern but slightly different widths. An open door has a width of 90 centimeters, whereas a T-intersection has a width of 120 centimeters.

For the results in the previous subsection, observations were produced with respect to time. Because the robot has a variable speed depending on its local environment, the distance traveled between two observations is not constant. We can transform these temporal observations into spatial information by taking into account the robot’s speed. The goal of the transformation

is to help the HMM2s to discriminate between T-intersections and open doors using a width criteria.

The second issue is the excessive insertion rate. At the present time, learning and recognition of places is performed on each side independently using only the three lateral sensors (i.e., six sensors in all). This technique has two drawbacks:

- We lose information about the environment using only 2 sets of 3 sensors. Our mobile robot has 16 sensors. Information provided by front and rear sensors are not currently taken into account. We have insertions of the start or end of the corridor in the middle of the corridor, which makes no sense. Front and rear sensors could avoid these insertions.
- The learning and recognition are performed on each side independently. This does not permit learning and recognition of places in a global way. A more global learning and recognition could be useful for several reasons. For example, the influence of one side's recognition on the other could be taken in account, to eliminate some obvious insertions.

Our idea is to process all of the 16 sensors' observations. The two next subsections present the two major modifications we used to improve the recognition rate. In the next section, we discuss the new results.

#### 4.3.1 Transformation of observations

To easily discriminate the open-door place and T-intersection place by their widths, it's necessary that the distance traveled by the robot between two acquisitions remains constant. Our mobile robot, unfortunately, is not capable of sampling the observations as a function of the traveled distance, so we apply a variable time sampling rate depending on the robot's speed to emulate a spatial sampling rate in which the distance between two acquisitions is constant.

We analyzed the traveled distance between two acquisitions assuming that the error of the odometric position estimate is negligible during short durations. We noticed that:

- In a cluttered area, the robot approximatively moves 1 centimeter between two acquisitions ;
- In a free area, the robot, approximatively, moves 5 centimeters between two acquisitions.

We decided to have the robot sample data each 7.5 centimeters. We choose a distance larger than 5 centimeters to have enough data to reliably interpolate a spatial observation. We estimate a spatial sample by averaging all the data coming from each sensor during the time it lasts for the robot to traverse a 7.5 centimeter step.

#### 4.3.2 Using 16 sensors for learning and recognition

The expanded HMM2 now models the 16-dimensional, real-valued signal coming from the battery of ultrasonic sensors. Next, we must define "global places" taking into account what can be seen on the right side and on the left side simultaneously.

To build the new global places, we combine the 5 previous places observable on the right side with the 5 places observable on the left side. These 25 models can be broken down into the 10 following models as shown in figure 8:

- a corridor ;

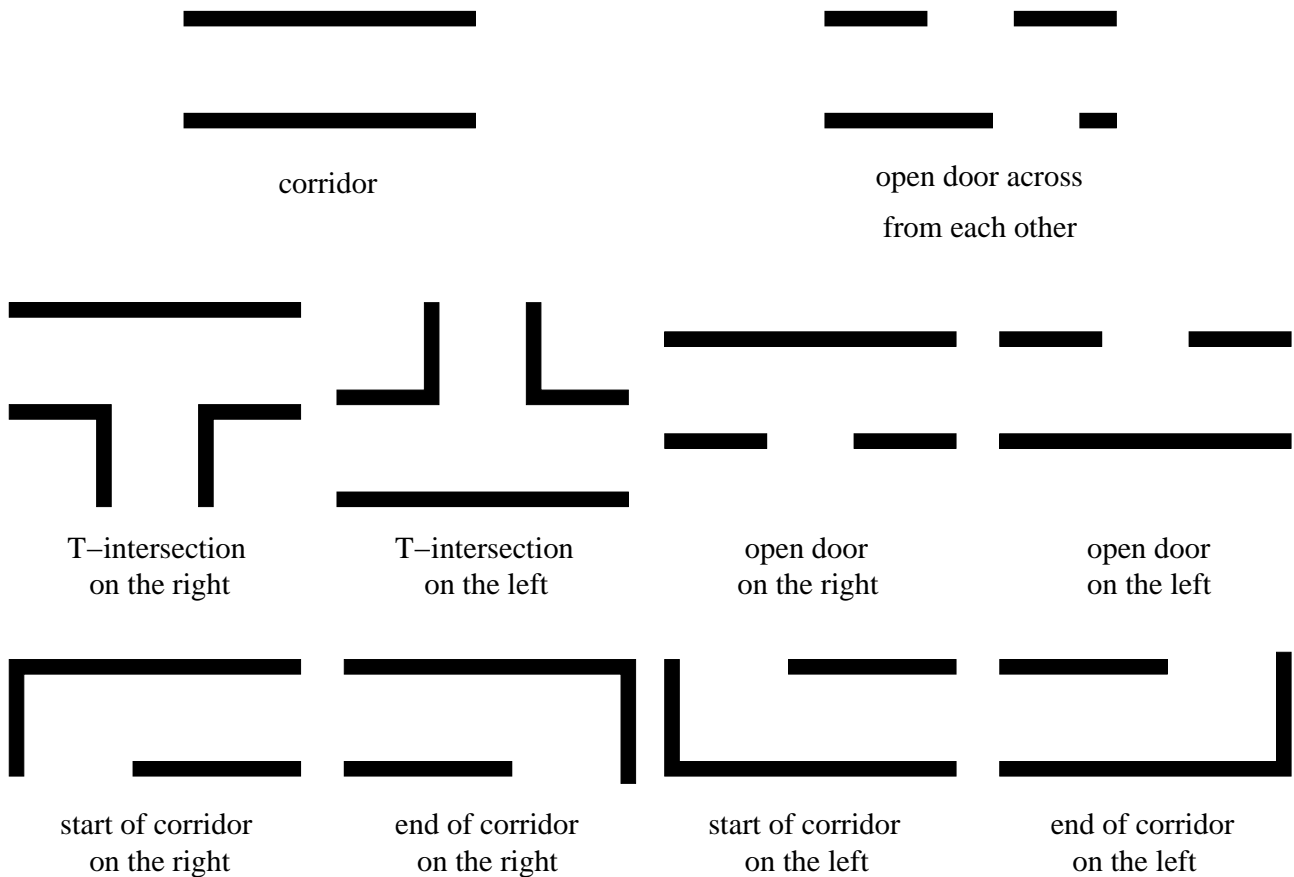

Figure 8: The 10 models to recognize

- a T-intersection on the right (resp. left) ;
- an open door on the right (resp. left) ;
- a start of corridor on the right (resp. left) ;
- an end of corridor on the right (resp. left) ;
- two open doors across from each other.

Other combinations, although geometrically legal, are impossible in our environment.

An example of the characterization of these 10 places is given in figure 9.

#### 4.4 New results and discussion

Results are given in matrix 3 and 4.

As before, training and recognition are done with the first derivative of the 16 sensors' measure as inputs of each HMM2.

We label the same previous learning corpus using the classes defined in section 4.3.2. We perform the learning phase of the 10 new places using the new segmentation. The recognition phase is performed using the same previous recognition corpus (section 4.2.4). The goal of the recognition process is to identify the 9 places in the corridor between its start and its end.

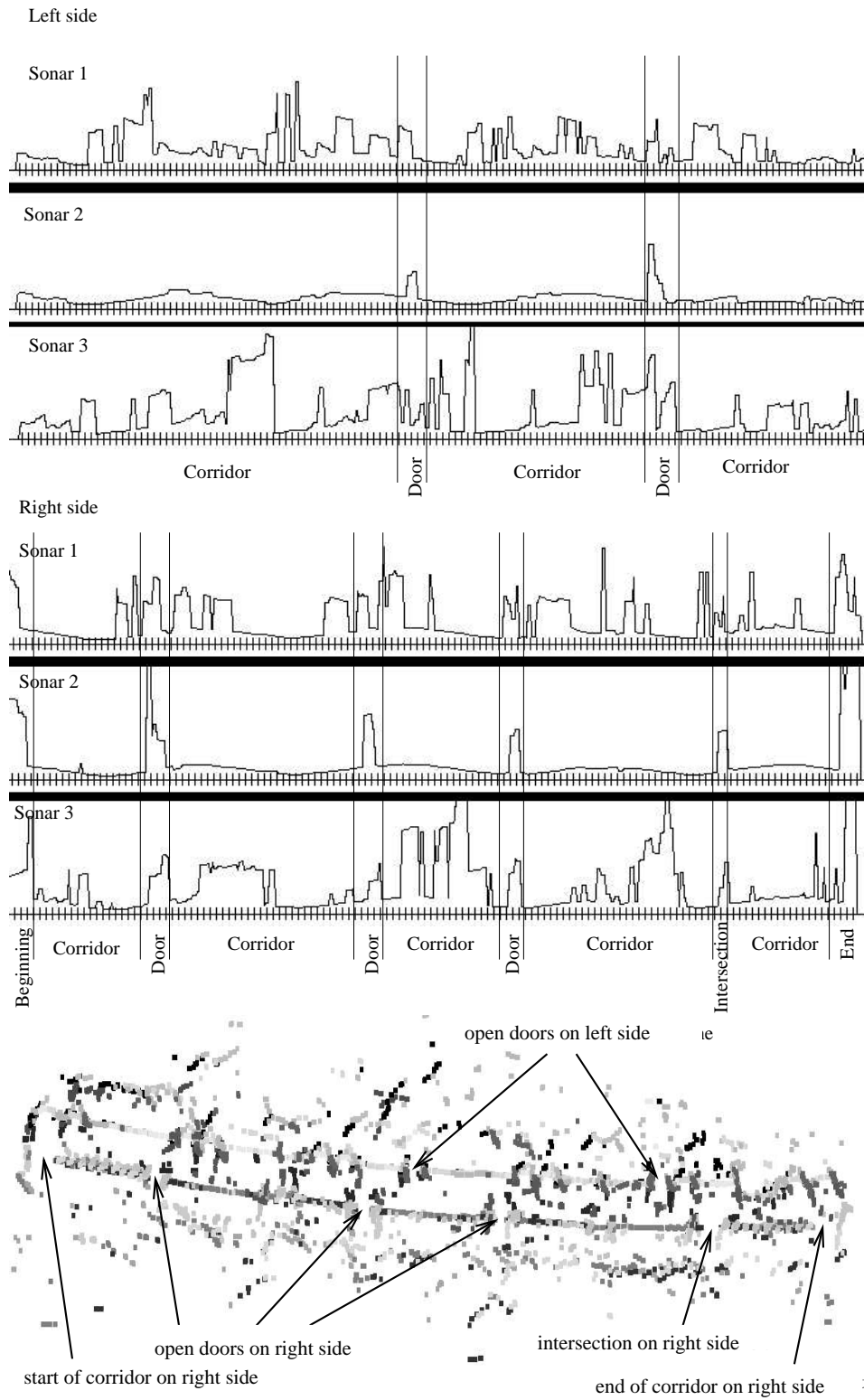

Figure 9: Example of characterization of the 10 new places

	right start	right end	right inter.	right door	left start	left end	left inter.	left door	door door	Ins.
right start	7	0	0	0	0	0	0	0	0	0
right end	0	7	0	0	0	1	0	1	0	0
right inter.	0	0	7	0	0	0	0	0	0	0
right door	0	0	0	42	0	0	0	1	1	25
left start	0	0	0	0	8	0	0	0	0	0
left end	0	0	0	0	0	6	0	0	0	0
left inter.	0	0	0	0	0	0	8	0	0	0
left door	1	0	0	4	0	0	1	43	1	34
door door	0	0	1	0	0	0	0	1	2	1
deletions	0	1	0	0	0	0	0	0	0	0
Total	8	8	8	46	8	7	9	46	4	60
% reco.	88	88	88	91	100	86	89	93	50	

Table 3: New results

	number	%
Seen	144	100
Recognized	130	90
Substituted	11	9
Deleted	2	1
Inserted	60	42

Table 4: Global rate of recognition

We notice that the rate of confusion between open doors (on the left or on the right) and T-intersections (on the left or on the right) decreases with the expanded sensor suite. Due to the transformation of observations from temporal to spatial information, the length of a sequence<sup>†</sup> of observations labeled as an open door (resp. T-intersection) is nearly always the same. The goal of the transformation was to emulate a spatial sampling rate in which the distance between two acquisitions is constant in order to use a width (of places) criteria to discriminate between places. As the width of open doors is different from the width of intersections, the discrimination between these two types of places is improved because of the duration modeling capabilities of the HMM2, as presented above and as shown by (Mari et al., 1997).

In the previous experimental results, we had a significant number of insertions of T-intersections. We now have no more insertions of T-intersection, but a higher number of insertions of open doors. In fact, a T-intersection has a higher width than an open door, and so insertions of small width, corresponding to erroneous sensor reflections, would not be recognized as T-intersections, but rather as open doors. On the other hand, we had 67 insertions of T-intersections before the transformation of the observations, against currently 59 insertions of open doors. Now,

<sup>†</sup>The length of a sequence is defined as the number of observations composing the sequence.

reflections of very small duration are assimilated as noise and will not be recognized as open doors or intersections, so the global rate of insertions has decreased.

The use of the 16 sensors during the learning phase has eliminated insertions of the start and end of the corridor when the robot is not at one extremity of the corridor. Observations of sensors situated on the front of the robot are very different when the robot is in the middle of the corridor than at the end of the corridor. So, the models of start of corridor (resp. end of corridor) could be recognized only when observations of front and rear sensors correspond to the start of a corridor (resp. the end of a corridor), which will rarely occur when the robot is in the middle of the corridor. So, it is nearly impossible to have insertions of the start of a corridor (resp. end of corridor) in the middle of the corridor.

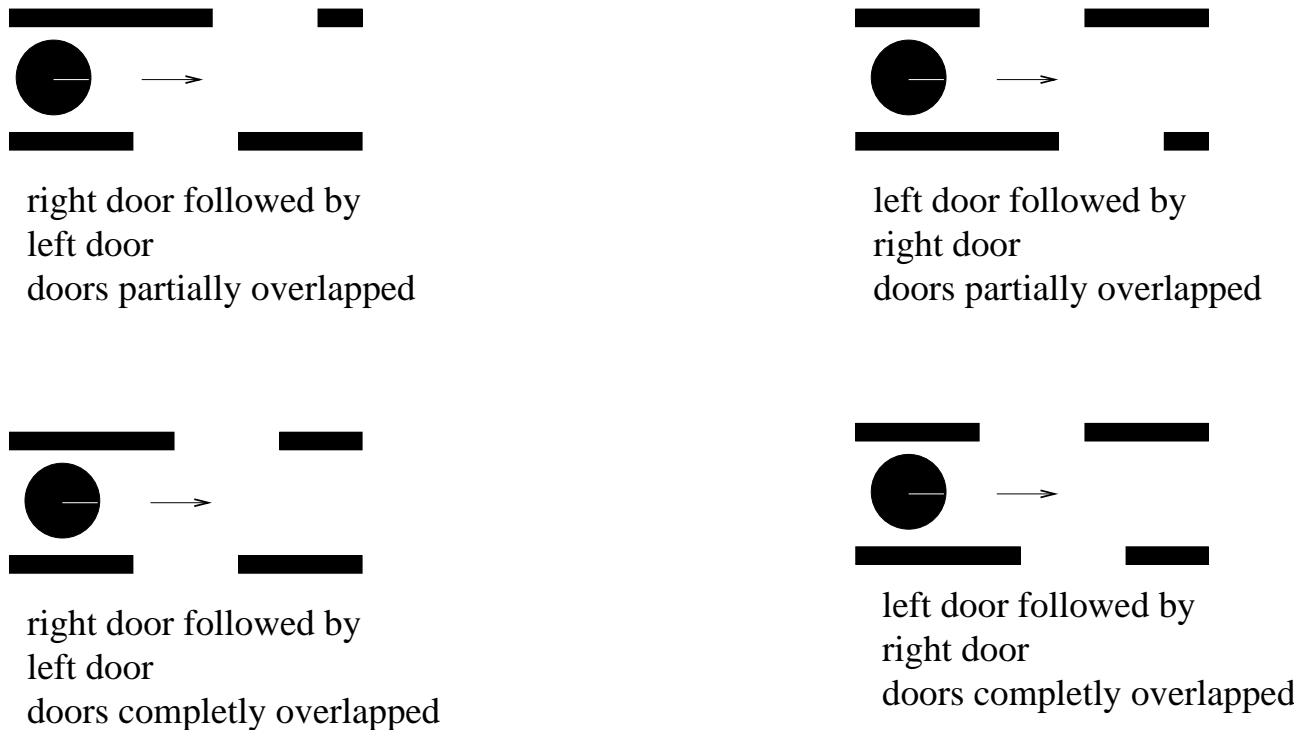

Figure 10: The 4 situations corresponding to two open doors across from each other

The rate of recognition of two open doors across from each other is mediocre (50%) for several reasons. There exists a great variety of doors that can overlap:

- The two open doors may be directly across from each other or not. If they are directly across from each other, they will appear together in the sensor data for many observations. Otherwise, they will appear together in the data for only a few observations.
- The first door that the robot will encounter can be on the left or on the right side.

Actually there exists at least four situations corresponding to the “two open doors across from each other” place. Figure 10 is an illustration of these situations when the robot is moving from the left side of the figure to the right side. The model was trained with a corpus containing all these 4 situations. The trained model is only an average of these 4 situations and is thus not very specific. Moreover, as this place doesn’t appear very often in the environment, the learning corpus contains very few data. A good strategy to solve this problem is to use a general model (for instance a model of 1 of the 4 situations) as an a priori model and to adapt it depending



of the position and of overlapping of the two doors. A priori estimation can ameliorate the problem of the lack of the training corpus inherent in the great number of models.

Finally, the global rate of recognition is increased from 75% to 92%. Insertions of places decreases from 54% to 42%. Deletions remain at a very low probability level (less than 1.5%).

## 5 Second experiment: Situation identification for planetary rovers: Learning and Recognition

In a second experiment, we want to detect particular features (which we call *situations*) when an outdoor teleoperated robot is exploring an unknown environment.

This experiment has three main differences with the previous one:

1. the robot is an outdoor robot;
2. the sensors used as the observation are of a different type than in the indoor experiment;
3. we performed multiple learning and recognition scenarios using different set of sensors. These experiments have been done to test the robustness of the detection if some sensors break down.

### 5.1 Marsokhod rover



Figure 11: The Marsokhod rover

The rover used in this experiment is a Marsokhod rover (see figure 11), a medium-sized planetary rover originally developed for the Russian Mars exploration program; in the NASA Marsokhod, the instruments and electronics have been changed from the original. The rover has six wheels, independently driven,<sup>‡</sup> with three chassis segments that articulate independently. It is configured with imaging cameras, a spectrometer, and an arm. The Marsokhod platform has been demonstrated at field tests from 1993–99 in Russia, Hawaii, and deserts of Arizona

<sup>‡</sup>For the experiments, the right rear wheel had a broken gear, so it rolled passively.

and California; the field tests were designed to study user interface issues, science instrument selection, and autonomy technologies.

The Marsokhod is controlled either through sequences or direct tele-operation. In either case the rover is sent discrete commands that describe motion in terms of translation and rotation rate and total time/distance. The Marsokhod is instrumented with sensors that measure body, arm, and pan/tilt geometry, wheel odometry and currents, and battery currents. The sensors that are used in this paper are roll (angle from vertical in direction perpendicular to travel), pitch (angle from vertical in direction of travel), and motor currents in each of the 6 wheels.

The experiments in this paper were performed in an outdoor “sandbox,” which is a gravel and sand area about 20m x 20m, with assorted rocks and some topography. This space is used to perform small-scale tests in a reasonable approximation of a planetary (Martian) environment. We distinguish between the small (less than approx. 15cm high) and large rocks (greater than approx. 15cm high). We also distinguish between the one large hill (approx. 1m high) and the three small hills (0.3-0.5m high).

## 5.2 Specifics of HMM2 application to outdoor situation identification

Here we discuss the specific issues arising from applying HMM2s to the problem of outdoor situation identification, along with our solutions to those issues. The numbering corresponds to the numbering of the steps in section 3.

### 5.2.1 The set of situations

Currently, we model six distinct situations that are representative of a typical outdoor exploration environment: when the robot is climbing a small rock on its left (resp. right) side, a big rock on its left side,<sup>§</sup> a small (resp. big) hill, and a default situation of level ground.

This set of items is considered to be a complete description of what the mobile robot can see during its runs. All other unforeseen situations, like flat rocks or holes, are treated as noise.

One possible application of this technique would be to identify internal faults of the rover (e.g., broken encoders, stuck wheels). This would require instrumenting the rover to cause faults on command, which is not currently possible on the Marsokhod. Instead, the situations used in this experiment were chosen to illustrate the possibility of using a limited sensor suite to identify situations, and in fact some sensors were not used (such as joint angles) so that the problem would become more challenging.

As Hidden Markov Models have the ability to model signals whose properties change with time, we have to choose a set of sensors (as the observation) that have noticeable variations when the Marsokhod is crossing a rock or a hill. From the sensors described in section 5.1, we identified eight such sensors: roll, pitch, and the six wheel currents. We define coarse rules to identify each situation (used by humans for segmentation and labeling the corpus for training and evaluation):

- When the robot crosses a small (resp. big) rock on its left, we notice a distinct sensor pattern. In all cases, the roll sensor shows a small (resp. big) increase when climbing the rock, then a small (resp. big), sudden decrease when descending from the rock. These two variations usually appear sequentially on the front, middle, and rear left wheels. The

---

<sup>§</sup>The situation of a big rock on the right side was not considered because of the non-functional right-side wheel.

pitch sensor always shows a small (resp. big) increase, then a small (resp. big), sudden decrease, and finally a small (resp. big) increase. There is little variation on the right wheels.

- When the robot crosses a small rock on its right side, we observe variations symmetric to the case of a small rock on the left side.
- When the robot crosses a small (resp. big) hill, the pitch sensor usually shows a small (resp. big) increase, then a small (resp. big) decrease, and finally a small (resp. big) increase. There is not always variation in the roll sensor. However, there is a gradual, small (resp. big) increase followed by a gradual, small (resp. big) decrease on all (or almost all) the six wheel current sensors.

### 5.2.2 The model to represent each situation

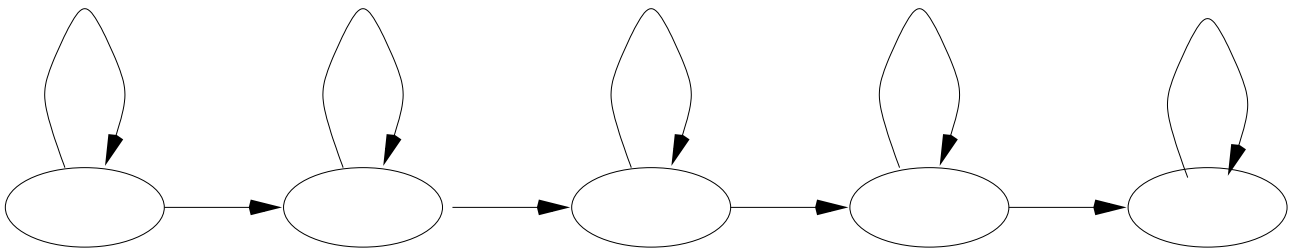

Figure 12: Topology of states used for each model of situation

In the formalism described in section 2, each situation to be recognized is modeled by a HMM2 whose topology is depicted in figure 12. This topology is well suited for the type of recognition we want to perform. In this experiment, each model has five states to model the successive events characterizing a particular situation. This choice has been experimentally shown to give the best rate of recognition.

### 5.2.3 Corpus collecting and labeling

We built six corpora to train a model for each situation. For this, our mobile robot made approximately fifty runs in the sandbox. For each run, the robot received one discrete translation command ranging from three meters to twenty meters. Rotation motions are not part of the corpus. Each run contains different situations, but each run is unique (i.e., the area traversed and the sequence of situations during the run is different each time). A run contains not only one situation but all the situations seen while running. For each run, we noted the situations seen during the run, for later segmentation and labeling purposes.

The rules defined to characterize a situation are used to segment and label each run. An example of segmentation and labeling is given in figure 13. The sensors are in the following order (from the top): roll, pitch, the three left wheel currents, and the three right wheel currents. A vertical line marks the beginning or the end of a situation. The default situation alternates with the other situations. The sequence of situations in the figure is the following (as labeled in the figure): small rock on the left side, default situation, big rock on the right side, default situation, small hill, default situation, and big hill.

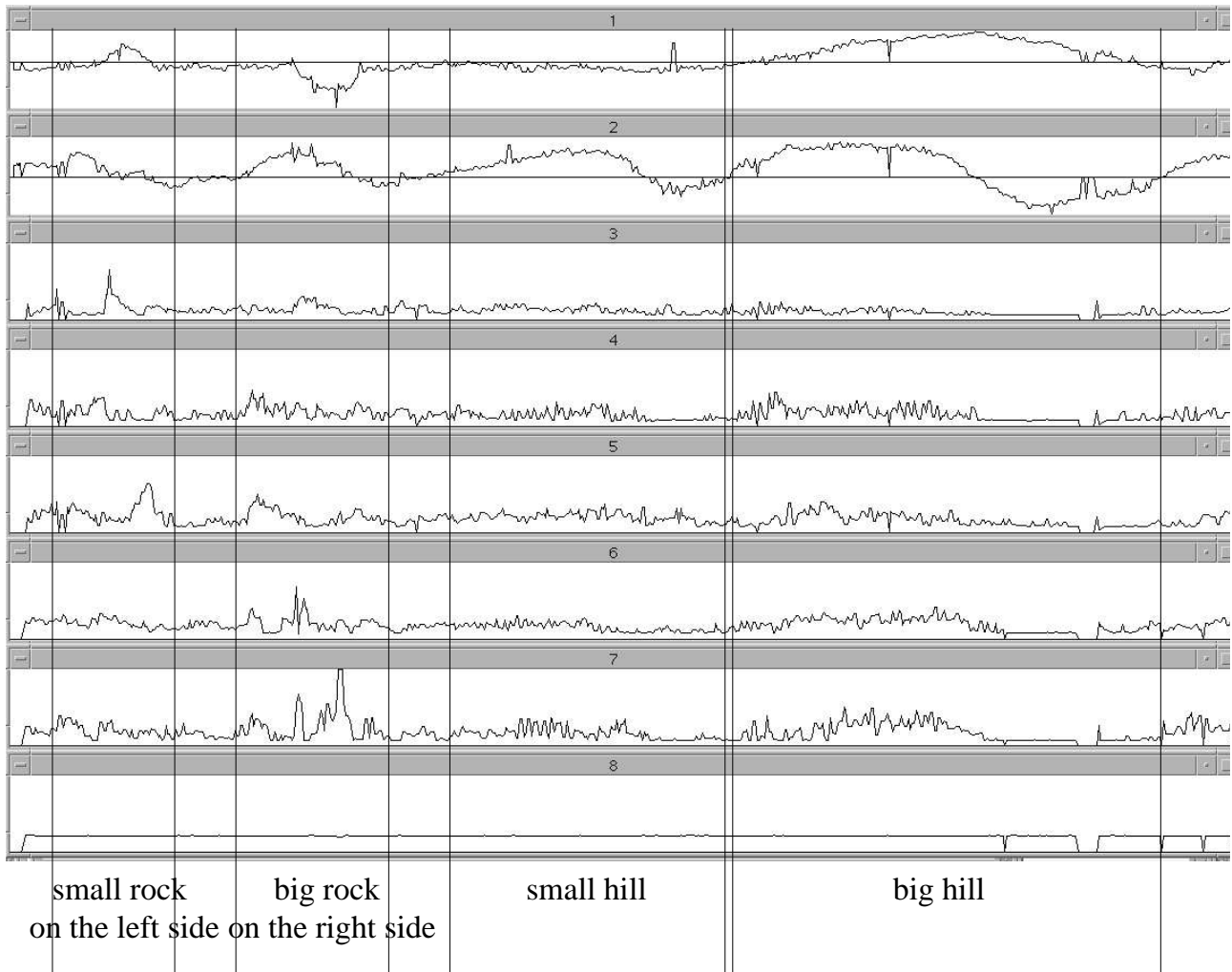

Figure 13: Segmentation and labeling of a run.

#### 5.2.4 Model training

In this experiment, we do not need to interpolate the observations done by the robot, because it always moves at approximately the same translation speed. As we want to compare different possibilities and test if the detection is usable even if some sensors break down, we train a separate model for each of three sets of input data. The observations used as input of each model to train consist of:

- eight coefficients: the first derivative (i.e., the variation) of the values of the eight sensors used for segmentation.
- six coefficients: the first derivative (i.e., the variation) of the values of the six wheel current sensors.
- two coefficients: the first derivative (i.e., the variation) of the values of the roll and the pitch sensors.

Each training uses segmented data, and each model is trained independently with its corpus.

There are two reasons for training three different models. First is to check whether the eight sensors used for the segmentation are necessary to learn and recognize situations, or whether

a subset is sufficient. Second, we want to be able to recognize situations even if one or more sensors do not work; e.g., if some wheel sensors do not work it will affect (during recognition) the models using the six wheel current sensors or the eight sensors but not the models using just the roll and pitch sensors.

### 5.2.5 The recognition phase

The goal of recognition is to identify the five situations (small rock on the left or right; big rock on the left; small or big hill) while the robot moves in the sandbox. The default situation model connects two items much like silence between two words in speech recognition.

During the recognition phase, the robot was operated as for corpus collecting. We took approximately 40 acquisitions and used the six trained models to perform the recognition. We perform three independent recognitions, corresponding to the three learning situations.

### 5.2.6 Results and discussion

In each confusion matrix, the acronyms used are: BL = big rock on the left, SL = small rock on the left, SR = small rock on the right, BH = big hill, and SH = small hill. The results of the three independent experiments are shown and analyzed in the three next subsections. In the fourth subsection, we present a global analysis of the results.

	BL	SL	SR	BH	SH	Ins
BL	19	3	1	-	-	9
SL	3	25	-	-	-	12
SR	1	2	31	-	1	26
BH	1	-	-	20	2	15
SH	-	-	-	1	23	28
Del	1	1	-	-	-	-
Total	25	31	32	21	26	90
Reco	76%	81%	97%	95%	88%	

Table 5: Confusion matrix of situations, eight sensors.

	number	%
Seen	135	100
Recognized	118	87
Substituted	15	11
Deleted	2	2
Inserted	90	67

Table 6: Global rate of recognition, eight sensors.

**Experiment with eight sensors** For eight sensors, as each situation can be easily distinguished from the others, the global rate of recognition is excellent (87%) (see tables 5, 6). Small (resp. big) rocks on the left are sometimes confused with big (resp. small) rocks on the left; the signal provided by the sensors does not contain the information necessary to discriminate these

two models. In fact, the variations on the sensors are nearly the same. The only criterion which distinguishes these two models is the amplitude of the variation on the three left wheels, and visibly it is not sufficient. The small rocks on the right are perfectly recognized. This situation has a very distinctive pattern, and only with difficulty can it be confused with another. The fact that we could not learn and recognize a situation where the robot is crossing a big rock on its right avoids any confusion.

The major problem is the high rate of insertion. This rate is due to the noise of the sensors being recognized as a situation. This is especially the case for situations characterized only by small variations on a part (or all) of the set of sensors, in particular the crossing of a small hill.

	BL	SL	SR	BH	SH	Ins
BL	17	5	1	-	-	10
SL	4	24	2	-	1	19
SR	3	-	29	-	1	44
BH	-	1	-	20	1	19
SH	1	-	-	1	23	32
Del	-	1	-	-	-	-
Total	25	31	32	21	26	124
Reco	68%	77%	91%	95%	88%	

Table 7: Confusion matrix of situations, six sensors.

	number	%
Seen	135	100
Recognized	113	84
Substituted	21	15
Deleted	1	1
Inserted	124	92

Table 8: Global rate of recognition, six sensors.

**Experiment with six sensors** With six sensors, the global rate of recognition is still very good (see tables 7, 8). There is only four more percent of substitutions due to the loss of information used to distinguish situations. On the other hand, the rate of insertion increased by 25%. With only the six wheel current sensors, nearly one recognition out of two is an insertion. The six wheel current sensors are very noisy, and the roll and pitch sensors are useful to distinguish between simple noise and real situations. This explains the increase of the insertions.

**Experiment with two sensors** With only the roll and pitch sensors, the global rate of recognition remains good, and the rate of insertions significantly decreases (see tables 9, 10). In fact, these two sensors are not too noisy, and when there is a variation on these sensors it generally corresponds to a real situation. But these two sensors do not provide sufficient information to distinguish between situations, which is why there is a high rate of substitution.

	BL	SL	SR	BH	SH	Ins
BL	15	4	-	6	1	1
SL	2	17	1	-	9	15
SR	2	1	27	1	5	8
BH	5	-	-	14	2	6
SH	-	7	4	-	9	12
Del	1	2	-	-	-	-
Total	25	31	32	21	26	42
Reco	60%	55%	84%	67%	35%	

Table 9: Confusion matrix of situations, two sensors.

	number	%
Seen	135	100
Recognized	82	61
Substituted	50	37
Deleted	3	2
Inserted	42	31

Table 10: Global rate of recognition, two sensors.

**Global analysis** From the results of experiments, we can draw some conclusions. The best way to perform recognition is with eight sensors: the rate of recognition is a little bit better than for six sensors and the rate of insertion is very smaller. This can be explained by the fact that the six wheels current sensors are very noisy, and the use of the roll and pitch sensors, which are not too noisy, can distinguish between a situation to recognize and a simple noise on the current wheel sensors. Nonetheless, the models learned in the two last experiments could be useful in long exploration where sensors can fail, since they provide usable, albeit less reliable, recognition.

This experiment can be extended to fault detection, for example broken wheels or sensor failure. In fact, we can build one model of a particular situation where all sensors work and several models of this situation where one or several sensors are broken: for example a model of a big rock on the right side and a model of a big rock on the right when the front left wheel is broken. Using these models, we can recognize situations associated with the state of the sensors of the robot, and detect failing of sensors or motors.

## 6 Related work

A variety of approaches to state estimation and fault diagnosis have been proposed in the control systems, artificial intelligence, and robotics literature.

Techniques for state estimation of continuous values, such as Kalman filters, can track multiple possible hypotheses (Rauch, 1994; Willsky, 1976). However, they must be given an *a priori* model of each possible state. One of the strengths of the approach presented in this paper is its ability to construct models from training data and then use them for state identification.

Qualitative model-based diagnosis techniques (de Kleer & Williams, 1987; Muscettola, Nayak, Pell, & Williams, 1998) consider a snapshot of the system rather than its history.

In addition, the system state is assumed to be consistent with a propositional description of one of a set of possible states. The presence of noisy data and temporal patterns negates these assumptions.

Hidden Markov Models have been applied to fault detection in continuous processes (Smyth, 1994); the model structure is supplied, with only the transition probabilities learned from data. In the approach in this paper, the HMM learns without prior knowledge of the models.

Markov models have been widely used in mobile robotics. Thrun (2001) reviews techniques based on Markov models for three main problems in mobile robotics: localization, map building and control. In these techniques, a Markov model represents the environment, and a specific algorithm is used to solve the problem. Our approach is different in a number of ways. We address a different problem: the interpretation of temporal sequences of mobile-robot sensor data to automatically detect features. Moreover, we use very little *a priori* knowledge: in particular, the topology of the model reflecting the human's understanding about sequences of sensor data characterizing a particular feature. All the other parameters of the model are estimated by learning. On the contrary, the techniques presented in (Thrun, 2001) need some *preliminary knowledge*: a map of the environment, a sensor model and an actuator model. Usually, there is no learning component in these techniques.

The most well-known work including a learning component is by Koenig and Simmons (1996). They start with an *a priori* topological map that is translated into a Markov model before any navigation takes place. An extension of the Baum-Welch algorithm reestimates the Markov model representing the environment, the sensor and actuator models. There are a number of differences with this work:

- They use a Markov model to model the environment, whereas we use a Markov model to model the sequence of events composing a particular feature;
- They need some *a priori* knowledge: a topological map of the environment, and sensor and actuator models;
- They make hypotheses on the value of some parameters to reduce the number of parameters to estimate; we do not make any such hypothesis;
- The observations they use are discrete, symbolic and unidimensional. There are obtained by an abstraction (based on some hypothesis) of the raw data of several sensors. Discrete symbolic and unidimensional observations are the result of our method. They are obtained by interpretation of a sequence of raw data from several sensor without any prior hypothesis.

Our work can be seen as a preliminary step for all of the work presented in (Thrun, 2001). We have previously built a sensor model based on the recognition rates reported in this article; the model allowed robust localization in dynamic environments (Aycard, Laroche, & Charpillat, 1998).

Hidden Markov Models have been used for interpretation of temporal sequences in robotics (B. Hannaford, 1991; J. Yang, 1994). The approach presented in this paper is more robust for the following reasons:

- Yang, Xu, and Chen (1994) make some restrictions and hypotheses on the observations they used: each component of the observation is discretized, since he uses a HMM with



discrete observations. Moreover, each component of the observation is presumed independent from the other. In our work, the probability of an observation given a particular state is represented by a mixture of Gaussians. Thus we are able to deal with observations constituted by noisy continuous data of different types<sup>¶</sup> of sensors without any *a priori* assumption about the independence of these data and without any discretization of the data;

- The particular approach we use is the second-order HMM (HMM2). HMM2s have been shown to be effective models to capture temporal variations in speech (Mari et al., 1997), in many cases surpassing first-order HMMs when the trajectory in the state space has to be accounted for. For instance in the first experiment, due to the duration-modeling capabilities of HMM2, the Viterbi algorithm was able to distinguish an open door from a T-intersection.

## 7 Conclusion and future directions

In this paper, we have presented a new method to learn to automatically detect features for mobile robots using second-order Hidden Markov Models. This method gives very good results, and has a good robustness to noise, verifying that HMM2s are well suited for this task. We showed that the process of recognition is robust to dynamic environment. Features are detected even if they are quite different from learned features: for instance, an open door is recognized even if it is completely or partially opened. Moreover, features are detected even if they are seen from a different point of view. For instance, in contrast to Kortenkamp et al (1992), features are detected even if the robot is not at a given distance from a wall and doesn't move in a direction perfectly parallel to the two walls constituting the corridor. Finally, our approach has been successfully tested in an outdoor environment.

The results can be improved by adding more models to decrease the intra-class variability (especially for open doors across from each other) and to take into account contextual information. Another criterion that could improve the results is to choose a different number of states for each feature.

Moreover, the method takes advantage of analytical methods and pattern classification methods. First, we analyze the sensor data and define a model to represent the patterns in the data. Secondly, the learning algorithm automatically adjusts the parameters of the model using a learning corpus. Moreover, the learning algorithm was able to extract more complex characteristics of a feature than simple variations of sensor data between two consecutive moments. For instance:

- The length of a sequence<sup>||</sup> of observations was taken into account in the first experiment to detect the difference between a T-intersection and an open door;
- In the first experiment, the gradual decrease (resp. increase) of the value of sensors located in front (resp. in the rear) of the robot during time has been used to characterize a start (resp. an end) of corridor;

---

<sup>¶</sup>In the second experiment, the observation is composed of three types of sensors.

<sup>||</sup>the number of observations composing the sequence

- The algorithm can find correlation between data from sensors of different types to characterize a feature. For example, the correlation of the roll, pitch and wheel current sensors is used to characterize a situation in the second experiment.

However, our method has two drawbacks:

- As in Kortenkamp et al (1992), a feature can only be recognized when it has been completely visited. For example, the robot would have to go back to turn at a T-intersection after it had recognized it.
- Moreover, using the current technique, the list of places is known only when the run has been completed. To detect features online during navigation, we can use a variant of the Viterbi algorithm called Viterbi-block (Kriouile, Mari, & Haton, 1990). This algorithm is based on a local optimum comparison of the different probabilities computed by the Viterbi algorithm during time-warping of a shift-window of fixed length in the signal and the different HMMs. This algorithm can detect features a few meters after they have been seen. We have used this algorithm to perform localization in dynamic environment (Aycard et al., 1998).

## References

- Aycard, O., Charpillet, F., & Haton, J.-P. (1997). A new approach to design fuzzy controllers for mobile robots navigation. In *proceedings of IEEE International Symposium on Computational Intelligence in Robotics and Automation*, pp. 68–73.
- Aycard, O., Laroche, P., & Charpillet, F. (1998). Mobile robot localization in dynamic environment using place recognition. In *Proc. of ICRA '98*.
- B. Hannaford, P. L. (1991). Hidden markov model analysis of force/torque information in telemanipulation. *The International journal of robotics research*.
- Becker, C., Salas, J., Tokusei, K., & Latombe, J.-C. (1995). Reliable navigation using landmarks. In *IEEE Int. Conf. on Robotics and Automation*.
- Borenstein, J., Everett, B., & Feng, L. (1996). *Navigating Mobile Robots: Systems and Techniques*. A. K. Peters, Ltd., Wellesley, MA.
- Crystal, T., & House, A. (1988). Segmental Durations in Connected Speech Signals: Current Results. *Journal of Acoustical Society of America*, 83(4), 1553 – 1573.
- de Kleer, J., & Williams, B. C. (1987). Diagnosing multiple faults. *Artif. Intelligence*, 32, 100–117.
- Elfes, A. (1989). Using occupancy grids for mobile robot perception and navigation. *IEEE Computer*, 22(6), 46–57.
- Forney, G. (1973). The Viterbi Algorithm. *IEEE Transactions*, 61, 268–278.
- J. Yang, Y. Xu, C. C. (1994). Hidden markov model approach to skill learning and its application to telerobotics. *IEEE transactions on robotics and automation*.
- Koenig, S., & Simmons, R. (1996). Unsupervised learning of probabilistic models for robot navigation. In *proceedings of the International Conference on Robotics and Automation*, pp. 2301–2308.

- Kortenkamp, D., Douglas Baker, L., & Weymouth, T. (1992). Using gateways to build a route map. In *proceedings of the 1992 IEEE International Conference on Intelligent Robots and Systems*.
- Kriouile, A., Mari, J.-F., & Haton, J.-P. (1990). Some Improvements in Speech Recognition Algorithms based on HMM. In *Proceedings IEEE ICASSP'90 (International Conference Acoustics Speech and Signal Processing)*, pp. 545 – 548, Albuquerque.
- Kuipers, B. (2000). The spatial semantic hierarchy. *Artificial Intelligence*.
- Lazanas, A., & Latombe, J.-C. (1995). Landmark-based robot navigation. *Algorithmica*.
- Mari, J.-F., Haton, J.-P., & Kriouile, A. (1997). Automatic Word Recognition Based on Second-Order Hidden Markov Models. *IEEE Transactions on Speech and Audio Processing*, 5.
- Muscettola, N., Nayak, P. P., Pell, B., & Williams, B. C. (1998). Remote agent: To boldly go where no AI system has gone before. *Artificial Intelligence*, 103(1/2).
- Rabiner, L. R. (1989). A Tutorial on Hidden Markov Models and Selected Applications in Speech recognition. *IEEE Trans. on ASSP*, 77(2), 257 – 286.
- Rauch, H. E. (1994). Intelligent fault diagnosis and control reconfiguration. *IEEE Ctrl. Sys.*, 14(3).
- Smyth, P. (1994). Hidden Markov models for fault detection in dynamic systems. *Pattern Recognition*, 27(1), 149–164.
- Thrun, S. (1998). Bayesian landmark learning for mobile robot localization. *Machine Learning*.
- Thrun, S. (2001). Probabilistic algorithms in robotics. *AI Magazine*.
- Willsky, A. S. (1976). A survey of design methods for failure detection in dynamic systems. *Automatica*, 12, 601–611.
- Yamauchi, B. (1995). *Exploration and spatial learning in dynamic environnements*. Ph.D. thesis, Case Western Reserve University.



---

Unité de recherche INRIA Rhône-Alpes  
655, avenue de l'Europe - 38330 Montbonnot-St-Martin (France)

Unité de recherche INRIA Futurs : Domaine de Voluceau - Rocquencourt - BP 105 - 78153 Le Chesnay Cedex (France)

Unité de recherche INRIA Lorraine : LORIA, Technopôle de Nancy-Brabois - Campus scientifique  
615, rue du Jardin Botanique - BP 101 - 54602 Villers-lès-Nancy Cedex (France)

Unité de recherche INRIA Rennes : IRISA, Campus universitaire de Beaulieu - 35042 Rennes Cedex (France)

Unité de recherche INRIA Rocquencourt : Domaine de Voluceau - Rocquencourt - BP 105 - 78153 Le Chesnay Cedex (France)

Unité de recherche INRIA Sophia Antipolis : 2004, route des Lucioles - BP 93 - 06902 Sophia Antipolis Cedex (France)

---

Éditeur  
INRIA - Domaine de Voluceau - Rocquencourt, BP 105 - 78153 Le Chesnay Cedex (France)  
<http://www.inria.fr>  
ISSN 0249-6399