



HAL
open science

Tracking Control of Complementarity Lagrangian Systems

Jean-Matthieu Bourgeot, Bernard Brogliato

► **To cite this version:**

Jean-Matthieu Bourgeot, Bernard Brogliato. Tracking Control of Complementarity Lagrangian Systems. [Research Report] RR-5384, INRIA. 2004, pp.51. <inria-00070619>

HAL Id: inria-00070619

<https://inria.hal.science/inria-00070619v1>

Submitted on 19 May 2006

HAL is a multi-disciplinary open access archive for the deposit and dissemination of scientific research documents, whether they are published or not. The documents may come from teaching and research institutions in France or abroad, or from public or private research centers.

L'archive ouverte pluridisciplinaire **HAL**, est destinée au dépôt et à la diffusion de documents scientifiques de niveau recherche, publiés ou non, émanant des établissements d'enseignement et de recherche français ou étrangers, des laboratoires publics ou privés.



HAL Authorization



INSTITUT NATIONAL DE RECHERCHE EN INFORMATIQUE ET EN AUTOMATIQUE

Tracking Control of Complementarity Lagrangian Systems

Jean-Matthieu Bourgeot — Bernard Brogliato

N° 5384

Novembre 2004

THÈME 4

A large blue rectangular area containing the text 'Rapport de recherche' in a white serif font. To the left of the text is a large, light grey 'R' logo. A horizontal grey brushstroke is positioned below the text.

*Rapport
de recherche*



Tracking Control of Complementarity Lagrangian Systems

Jean-Matthieu Bourgeot , Bernard Brogliato

Thème 4 — Simulation et optimisation
de systèmes complexes
Projets Bipop

Rapport de recherche n° 5384 — Novembre 2004 — 51 pages

Abstract: In this paper we study the tracking control of Lagrangian systems subject to frictionless unilateral constraints. The stability analysis incorporates the hybrid and non-smooth dynamical feature of the overall system. The difference between tracking control for unconstrained systems and unilaterally constrained ones, is explained in terms of closed-loop desired trajectories and control signals. This work provides details on the conditions of existence of controllers which guarantee stability. It is shown that the design of a suitable transition phase desired trajectory, is a crucial step. Some simulation results provide information on the convergence of such controller. Finally the extension towards the case of multiple impacts, is considered.

Key-words: Unilateral Constraint, Nonsmooth Mechanics, Hybrid System, Lyapunov Stability

This work was partially supported by the European project SICONOS IST2001-37172 (<http://maply.univ-lyon1.fr/siconos>)

Poursuite de trajectoires pour systèmes lagrangiens de complémentarité

Résumé : Dans ce papier nous étudions la poursuite de trajectoires pour des systèmes mécaniques Lagrangiens soumis à des contraintes unilatérales sans frottements. L'analyse de la stabilité de tels systèmes doit prendre en compte le caractère hybride (ou non régulier) de la dynamique du système complet. Les différences entre la poursuite de trajectoires pour un système non contraint et un système soumis à une contrainte unilatérale sont expliquées en termes de trajectoires désirées et de signaux de commande. Ces travaux donnent des détails sur les conditions d'existence de lois de commande asymptotiquement stables. Il est montré que la conception des trajectoires de référence lors d'une phase de transition est un point crucial. Des résultats numériques donnent quelques informations sur la convergence des tels contrôleurs. Finalement nous donnons quelques extensions possibles au cas des impacts multiples.

Mots-clés : Contrainte Unilatérale, Mécanique Non-Régulière, Système Hybride, Stabilité de Lyapunov

1 Introduction

The focus of this paper is the tracking control of a class of nonsmooth fully actuated Lagrangian systems subject to frictionless unilateral constraints on the position. Let $X \in \mathbb{R}^n$ denote the vector of generalized coordinates. Roughly speaking, *trajectory tracking* means that when properly initialized, all trajectories $X(\cdot)$ have to converge, or remain close to, some desired trajectory $X_d(\cdot)$ which is designed off-line. The Lyapunov stability of the fixed point of the transformed *error system* with state vector the tracking error $(X - X_d, \dot{X} - \dot{X}_d)$ is often required to get a robust and implementable scheme. The *stabilisation* problem consists of choosing X_d constant. For nonlinear mechanical systems, tracking is known to be significantly more difficult than stabilisation, even for unconstrained systems [Lozano *et al.*, 2000]. The stabilisation problem for a class of nonsmooth systems, including Lagrangian systems with unilateral constraints, has been analysed in [Brogliato, 2003a] [Goeleven *et al.*, 2003]. Applications may be found in manipulators performing tasks such as grinding, deburring [Komanduri, 1993] [Ramachandran *et al.*, 1994], filamentary brushing tools for surface finishing [Shia *et al.*, 1998], which have considerable importance in machining, disassembly robotic systems [Studny *et al.*, 1999], etc, and more generally all mechanical systems performing tasks involving contact/impact phenomena.

The nonsmooth complementarity systems we deal with in this paper, may *a priori* evolve in three different phases of motion :

- **i)** A free motion phase, where the mechanical system is not subject to any constraints (i.e. $F(X) > 0$, where $F(\cdot)$ is some (m -vector) function representing the “distance” between the system and the constraint).
- **ii)** A permanently constraint phase where the dynamical system is subject to holonomic constraints ($F_i(X) = 0$ during a non-zero time interval and for some indexes $i \in \{1, \dots, m\}$).
- **iii)** A transition phase whose goal is to stabilize the system on some surface $\Sigma_{\mathcal{I}} = \bigcap_{i \in \mathcal{I}} \Sigma_i$, where \mathcal{I} is some subset of $\{1, \dots, m\}$ and $\Sigma_i = \{X | F_i(x) = 0\}$. In other words a transition control has to assure that $F_i(X(t)) = 0$ and $\nabla F_i(t) \dot{X}(t^+) = 0$ for all $i \in \mathcal{I}$ ⁽¹⁾, where t is a *finite* time for obvious practical reasons.

In the first phase the system is described by a set of ordinary differential equations (ODE). The tracking control problem has been solved by several feedback controllers assuring the global asymptotic stability (feedback linearization, adaptive control, robust control, passivity-based control, etc [Lozano *et al.*, 2000]). The second phase concerns the control of a differential-algebraic equation (DAE) by so-called force/position controllers, and has been solved in [McClamroch & Wang, 1988] and [Yoshikawa, 1987]. It reduces to a motion control problem plus an algebraic equality for contact force equilibrium when suitable coordinates are chosen. During the transition phase the system is subject to unilateral constraints, and

¹The reason why the right limit of the velocity is indicated will be made clear later when solutions are given a precise meaning.

collisions occur. These collisions will generate rebounds, which are generally seen as disturbances. On the contrary, in the control framework that is studied in this paper (following [Brogliato *et al.*, 1997] and [Brogliato *et al.*, 2000]) impacts are provoked intentionally to dissipate energy and contribute towards stabilizing the system.

The aim of this paper is to study a control scheme which guarantees some stability properties of the closed-loop system during general motions involving the three above phases. It provides an interpretation of the specific feature of tracking control for unilaterally constrained systems in terms of some invariant closed-loop trajectories and some signals entering the control input (usually known as the desired trajectory). With respect to the results in [Brogliato *et al.*, 1997] [Brogliato *et al.*, 2000] we give accurate conditions under which various types of stability are assured, which were missing in these references. For instance the n -degree-of-freedom case with $n \geq 2$ is solved in [Brogliato *et al.*, 1997] only if a certain matrix is a Jacobian, which is quite restrictive as simple examples show [Brogliato, 1999, §8.6]. In [Brogliato *et al.*, 2000] the existence of a specific transition phase closed-loop trajectory is assumed, without proof. These two points are addressed in this paper, as well as the transition between permanent constraint phases and free-motion phases. We also study the robustness of this control scheme with respect to : the knowledge of constraints position.

Finally we extend this work to the case of nonscalar frictionless unilateral constraints, which may generate so-called *multiple impacts*.

Glossary:

ODE: Ordinary Differential Equation, **DAE**: Differential Algebraic Equation, **LCP**: Linear Complementarity Problem, **DES**: Discrete Event System.

For a m -vector X , $X \geq 0$ means that $X_i \geq 0$ for all components of X , $1 \leq i \leq m$. The maximum and minimum eigenvalues of a matrix M are denoted as $\lambda_{max}(M)$ and $\lambda_{min}(M)$ respectively. If a function $F(\cdot)$ has a simple discontinuity at t , the right and left-limits are denoted as $F(t^+)$ and $F(t^-)$ respectively. The jump is denoted as $\sigma_F(t) = F(t^+) - F(t^-)$. The Lebesgue measure of an interval $[a, b]$ is denoted as $\lambda[a, b]$.

1.1 Dynamics

The systems we study in this paper belong to the complementarity hybrid dynamical systems [Van der Schaft & Schumacher, 2000], a class of systems which generalizes that of nonsmooth mechanical systems [Moreau, 1983]. They are complementarity Lagrangian systems, with Lagrangian function $\mathcal{L} = \frac{1}{2}\dot{X}^T M(X)\dot{X} - U(X)$, where $T(X, \dot{X}) = \frac{1}{2}\dot{X}^T M(X)\dot{X}$ is the kinetic energy, $U(X)$ is the differentiable potential energy. The dynamics may be written as:

$$\begin{cases} M(X)\ddot{X} + C(X, \dot{X})\dot{X} + G(X) = u + \nabla F(X)\lambda_X \\ F(X) \geq 0, \quad F(X)^T \lambda_X = 0, \quad \lambda_X \geq 0 \\ \text{Collision rule} \end{cases} \quad (1)$$

where $X \in \mathbb{R}^n$ is a vector of generalized coordinates, $M(X) = M^T(X) \in \mathbb{R}^{n \times n}$ is the positive definite inertia matrix, $F(X) \in \mathbb{R}^m$ represent the distance to the constraints, $\lambda_X \in \mathbb{R}^m$ are the Lagrangian multipliers associated to the constraints, $u \in \mathbb{R}^n$ is the vector of generalized torque inputs, $C(X, \dot{X})$ is the matrix of Coriolis and centripetal forces, $G(X)$ contains conservative forces. ∇ denotes the Euclidean gradient, i.e. $\nabla F_i(X) = \left(\frac{\partial F_i}{\partial x_1}, \dots, \frac{\partial F_i}{\partial x_n} \right)^T \in \mathbb{R}^n$ and $\nabla F(X) = (\nabla F_1(X), \dots, \nabla F_m(X)) \in \mathbb{R}^{n \times m}$. The impact times will be denoted generically as t_k in the following. We assume that the functions $F_i(\cdot)$ are continuously differentiable and that $\nabla F_i(X(t_k)) \neq 0$ for all t_k .

A major discrepancy of complementarity systems compared to systems with switching vector fields, is that their state may be discontinuous, and that they may live on lower-dimensional spaces. This creates serious difficulties in their study [Brogliato, 2003b] [Heemels & Brogliato, 2003].

The Lagrangian system in (1) is *fully actuated*, i.e. $\dim(u) = \dim(X)$. This excludes for instance lumped joint flexibilities. In case $\dim(u) < \dim(X)$ the system is said to be *underactuated* and the control problem is much harder to solve. The first instance in the Control and Robotics literature where such a complementarity model has been used, is in [Huang & McClamroch, 1988]. One very specific feature of systems as in (1) is their intrinsic nonsmoothness, which hampers one to tangentially linearize them in the neighborhood of trajectories. Consequently linear controllers generally fail to stabilise such complementarity systems, and nonlinear feedback controllers have to be designed.

1.2 Admissible domain

The admissible domain Φ is a closed domain in the configuration space where the system can evolve, i.e.

$$\Phi = \{X | F(X) \geq 0\} = \bigcap_{1 \leq i \leq m} \Phi_i, \quad \Phi_i = \{X | F_i(X) \geq 0\}$$

For obvious reasons it is assumed that $\Phi \neq \emptyset$, and even more: it contains a closed ball of positive radius. This allows us to get rid of meaningless models. A motion like the one in items i), ii), iii) above can then be defined. The boundary of Φ is denoted as $\partial\Phi$.

Definition 1 A singularity of $\partial\Phi$ is the intersection of two (or more) surfaces $\Sigma_i = \{X | F_i(X) = 0\}$.

As alluded to above, the goal of the control problem during transition phases is to stabilise the system on the boundary $\partial\Phi$. When $m \geq 2$ this may be a singularity (i.e. a codimension $\alpha \geq 2$ surface) of the boundary. In this study we restrict ourselves to domains which have non-differentiable boundaries but which are convex around such non-differentiable points (like on Fig. 1.a). The unilateral constraints are expressed by the relation $F(X) \geq 0$, which can be translated locally into : $CX + D \geq 0$ for some matrices C and D . Clearly the non-convex example of Fig. 1.(b) cannot be expressed as the intersection of convex domains

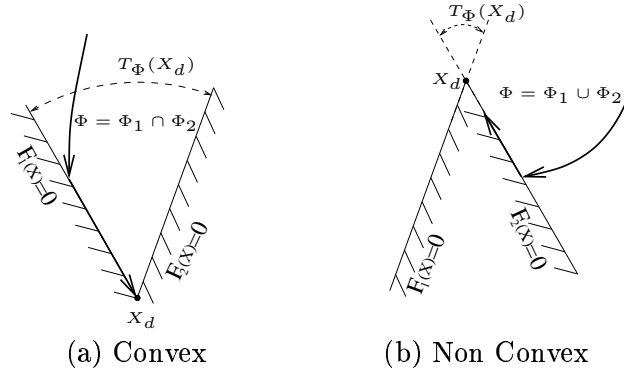

Figure 1: Non-differentiable points.

Φ_i . This case is named a reentrant corner in the literature, and modelling issues are not yet fixed for reentrant corners [Glocker, 2001] [Frémond, 2002]. This restriction on singular non-convex points does not mean that the whole space must be convex. For example the domain of the Fig. 2 is non-convex but can be described as Φ above. Such sets are called *regular* [Clarke, 1990]. For regular sets convexity holds locally and can be recovered by a suitable generalized coordinates change (diffeomorphic hence preserving the Lagrangian structure).

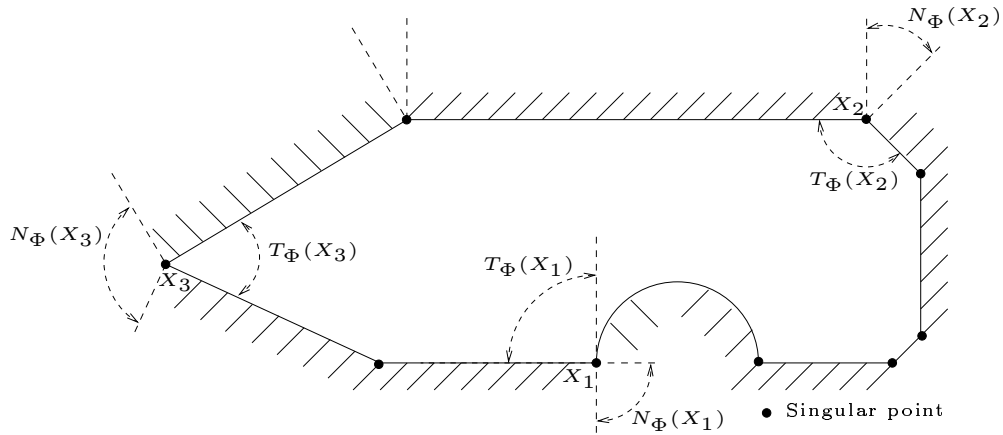

Figure 2: Example of a regular non-convex domain

1.3 Impact model

A collision rule is needed to integrate the system in (1) and to render the set Φ invariant. A collision rule is a relation between the post-impact velocities and the pre-impact velocities. In this work, it is chosen as in [Moreau, 1988]:

$$\begin{aligned} \dot{X}(t_k^+) = & -e_n \dot{X}(t_k^-) \\ & + (1 + e_n) \arg \min_{z \in T_\Phi(X(t_k))} \frac{1}{2} [z - \dot{X}(t_k^-)]^T M(X(t_k)) [z - \dot{X}(t_k^-)] \end{aligned} \quad (2)$$

where $\dot{X}(t_k^+)$ is the post impact velocity, $\dot{X}(t_k^-)$ is the pre-impact velocity, $T_\Phi(X(t))$ the tangent cone to the set Φ at $X(t)$ (see Figs. 1-2 where the sets X , $T_\Phi(X)$ are depicted) and e_n is the restitution coefficient, $e_n \in [0, 1]$. Notice that if the angle $(\Sigma_1, \Sigma_2) \leq \pi$ then in the neighborhood of X one has $\Phi \approx T_\Phi(X)$ when $X \in \Sigma_1 \cap \Sigma_2$. The tangent cone is defined as the cone which is polar to the normal cone $N_\Phi(X(t))$, see [Clarke, 1990] [Hiriart-Urruty & Lemaréchal, 1996] [Moreau, 1988]. Both are always convex sets. They generalize the tangent and normal subspaces to the configuration space to which velocities and contact forces belong, in bilaterally constrained systems. When $m = 1$, the rule in (2) is the Newton's law $\dot{X}_n(t_k^+) = -e_n \dot{X}_n(t_k^-)$, where \dot{X}_n is the normal component of the velocity. The restitution mapping in (2) can be equivalently rewritten as [Mabrouk, 1998]:

$$\dot{X}(t_k^+) = \dot{X}(t_k^-) - (1 + e_n) \text{prox}_{M(X(t_k))} [M^{-1}(X(t_k)) N_\Phi(X(t_k)); \dot{X}(t_k^-)] \quad (3)$$

where the $\text{prox}_{M(X(t_k))}$ means the proximation in the metric defined by the kinetic energy at time t_k , and $N_\Phi(X(t_k))$ is the normal cone to Φ at $X(t_k)$. The form in (3) will be useful for some calculations in stability proofs. It can also be written using a suitable generalized momentum transformation [Brogliato, 1999, Chapter 6]. See also [Glocker, 2002] for a nice geometrical interpretation of this rule. The restitution mapping in (2) yields a kinetic energy loss at the impact times given by [Mabrouk, 1998]:

$$T_L(t_k) = -\frac{1}{2} \frac{1 - e_n}{1 + e_n} [\dot{X}(t_k^+) - \dot{X}(t_k^-)]^T M(q(t_k)) [\dot{X}(t_k^+) - \dot{X}(t_k^-)] \leq 0 \quad (4)$$

Clearly this particular choice is arbitrary, and other models exist in the literature. However Moreau's collision rule is chosen here because it is mathematically sound, numerically tractable because it relies on Gauss' principle of Mechanics [Brogliato *et al.*, 2002], and is a direct extension of Newton's law (which is quite valid as long as friction is not considered). Moreover it lends itself very well to possible extensions towards more complex collision rules as the ones developed in [Frémond, 2002], which are based on the use of super-potentials of dissipation [Moreau, 1968].

1.4 Model well-posedness

The most general result on existence and uniqueness of solutions for mechanical systems as in (1) can be found in [Ballard, 2000] [Ballard, 2001]. Under the condition that all data entering

(1) are piecewise real analytic, then existence and uniqueness of a solution to (1) with $X(\cdot)$ absolutely continuous and $\dot{X}(\cdot)$ right-continuous of local bounded variation, is assured. Then the acceleration is a measure and so is the multiplier λ_X . We shall always assume that the required conditions are fulfilled in this paper. Multiple impacts (see definitions 1 and 5) generally render solutions discontinuous with respect to the initial conditions $(X(0), \dot{X}(0^+))$, except in particular cases (plastic impacts and kinetic angle between the constraint surfaces less or equal to $\frac{\pi}{2}$ [Paoli, 2002], or kinetic angle equal to $\frac{\pi}{2}$ [Ballard, 2000]). When $m = 1$ then continuity holds whatever e_n [Schatzman, 1998].

Due to the fact that velocities may be time discontinuous, but that their right-limit (and left-limit as well) exist everywhere, models as in (1) may be named *prospective*, because during the integration one looks for $\dot{X}(t^+)$ [Moreau, 2003].

1.5 Cyclic task

In this paper we restrict ourselves to a specific task, or trajectory: a succession of free and constrained phases Ω_k . During the transition between a free and a constrained phase, the dynamic system passes into a transition phase I_k . As we shall see, transitions between constrained and free motion are monitored by a Linear Complementarity Problem (see Appendix C for a definition).

$$\Omega_{2k} \xrightarrow{I_k} \Omega_{2k+1} \xrightarrow{\text{LCP}(\lambda)} \Omega_{2k+2}$$

In the time domain one gets a representation as :

$$\mathbb{R}^+ = \underbrace{\Omega_0 \cup I_0 \cup \Omega_1}_{\text{cycle 0}} \cup \Omega_2 \cup I_1 \cup \dots \cup \Omega_{2k-1} \cup \underbrace{\Omega_{2k} \cup I_k \cup \Omega_{2k+1}}_{\text{cycle k}} \cup \dots \quad (5)$$

where Ω_{2k} denotes the time intervals associated to free-motion phases and Ω_{2k+1} those for constrained-motion phases. The transition $\Omega_{2k+1} \rightarrow \Omega_{2k+2}$, does not define a specific phase (or DES mode) because it does not give rise to a new type of dynamical system, as we shall see in Sec. 3.3. The order of the phases is important but the initial phase may be Ω_0 or I_0 or Ω_1 , see remark 2. Before passing to the description of the stability framework which will enable us to design a feedback controller for tracking, let us investigate more deeply how (5) may be seen as a consequence of the basic control objectives i), ii) and iii) listed in the introduction.

First of all, let us notice that despite the problem involves contact and consequently generalized forces in the control objectives (during phases Ω_{2k+1} the contact force should have some desired value), the control problem remains primarily a motion control problem. Indeed the contact force, i.e. the Lagrange multiplier λ_X in (1), is not part of the system's state (X, \dot{X}) . Its value is only a consequence of the motion (in fact its value has to be calculated with a LCP, which is assured to always possess at least one solution for frictionless constraints, see [Brogliato, 1999, theorem 5.4]). For instance in a one degree-of-freedom system the contact force control simply reduces to an algebraic equation $\lambda = \lambda_d$ for some

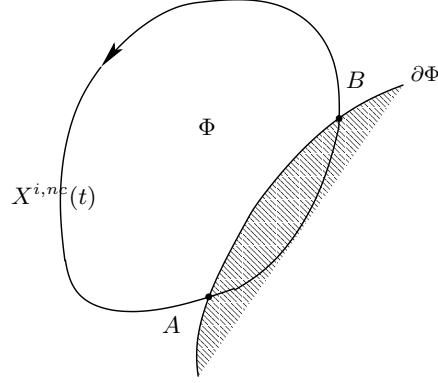

Figure 3: Unconstrained trajectory.

signal λ_d (possibly time-varying). However this is not a stabilisation problem, this is a static equilibrium. Therefore the force/position control problem should rather be called a *motion-control/force-equilibrium* problem in such a case. During such a static equilibrium phase, motion tracking drastically simplifies to triviality. This is going to be the same in higher dimensions, in the normal direction to $\partial\Phi$.

More precisely, the items **i)** and **ii)** in the introduction imply that the trajectory of the unconstrained system that has to be tracked, denoted as $X^{i,nc}(\cdot)$ possesses the generic form shown in Fig. 3. More exactly the orbit of this trajectory in the configuration space is depicted on Fig. 3. It is clear that in particular item **ii)** implies that $F(X^{i,nc}(t)) < 0$ for some $t \in \Omega_{2k+1}$, otherwise there would be a zero contact force when the system perfectly tracks the desired motion. Roughly speaking, the system has to have the tendency to violate the constraints in order to assure a non-zero contact force. In the same spirit item **i)** implies that $F(X^{i,nc}(t)) > 0$ for some $t \in \Omega_{2k}$. Consequently there exists a point A in the configuration space, at which contact is made with $\partial\Phi$. This gives rise to a transition phase whose role is as in item **iii)**. In the same way there is a point B at which $F(X^{i,nc}(t)) = 0$ and detachment is monitored by a LCP. *The central issue in the present control problem, is the design of such transition phases.* A first idea is to impose a tangential contact, i.e. with $\nabla F(X_d^*)^T \dot{X}_d^* = 0$, where $X_d^*(\cdot)$ is a signal entering the control input and playing the role of the desired trajectory during some parts of the motion (the difference between $X_d^*(\cdot)$, and $X^{i,nc}(\cdot)$ will be made clear below). However

- α) Due to non-zero initial tracking errors $X(0) - X_d^*(0) \neq 0$, $\dot{X}(0) - \dot{X}_d^*(0) \neq 0$, impacts may occur.
- β) This is not a robust strategy since a bad estimation of the constraint position, may result to no stabilisation at all on $\partial\Phi$. Consequently it is a much better strategy to impose collisions for stabilisation on $\partial\Phi$.

- γ) In any case, collisions have to be incorporated into the stability analysis.
- δ) The best strategy for stabilisation on $\partial\Phi$ is to impose closed-loop dynamics which mimics the bouncing-ball dynamics $\ddot{X} = -g$, $X \geq 0$:
 - δ_1) This is very robust with respect to the constraint position uncertainties.
 - δ_2) As we will see it lends itself very well to Lyapunov stability of some closed-loop Poincaré map.

Secondly, we will see in the next section that the type of stability we desire is based on a single Lyapunov-like function $V(X, \dot{X}, t)$. Then difficulties arise due to the following:

- **a**) There are non-zero couplings between “tangential” and “normal” coordinates in the inertia matrix $M(X)$ (this will be formulated more rigorously later).
- **b**) This unique function $V(X, \dot{X}, t)$ has to work for all phases, i.e. for Ω_{2k} (ODE), Ω_{2k+1} (DAE), and I_k (the dynamics may then be seen as a Measure Differential Equation [Brogliato, 1999]).
- **c**) If $V \equiv 0$ then any velocity jump $\dot{q}(t_k^+) \neq \dot{q}(t_k^-)$ implies a positive jump $V(t_k^+) - V(t_k^-) > 0$ in the Lyapunov function. This means that impacts will generally preclude asymptotic stability ⁽²⁾, except in very particular cases of no inertia couplings, in which case things greatly simplify.
- **d**) The function V has to satisfy $V = 0$ when the desired trajectory of the closed-loop system is perfectly tracked, according to the definition of a Lyapunov function. This implies that the desired set of the complete (constrained) system must be used in the definition of V .

One therefore realises that the control problem is itself subject to many constraints. The proposed strategy has to cope with these various and sometime antagonist facts (like β) and **c**). Item **c**) hampers the use as time goes to infinity of any controller that would switch at time t_s between a free-motion feedback input with $F(X_d^*(t_s^-)) > 0$ to a transition phase controller with a “bouncing-ball” dynamics (i.e. such that $F(X^{i,nc}(t_s^+)) < 0$). However such a discontinuous input can be used during the transient period. The idea of using a desired motion that would mimic the impacts so that $V(t_k^+) - V(t_k^-) = 0$ even when $V(0) = 0$ is not a good one. First of all items β) and δ) are in force, and such a strategy requires also a perfect knowledge of e_n in (2). Secondly, proving the stability of such a trajectory is a hard task. We therefore disregard this sort of signals $X_d^*(\cdot)$ for transition phases I_k . In order to clarify these various notions let us consider a one degree-of-freedom system:

$$\begin{cases} (\ddot{X} - \ddot{X}_d^*) + \gamma_2(\dot{X} - \dot{X}_d^*) + \gamma_1(X - X_d^*) = \lambda \\ 0 \leq X \perp \lambda \geq 0 \\ \dot{X}(t_k^+) = -e_n \dot{X}(t_k^-) \end{cases} \quad (6)$$

²This is mainly due to the fact that the controllers used on phases Ω_k assure asymptotic convergence of the tracking errors towards zero, but do not possess any finite-time convergence properties.

where $X_d^*(\cdot)$ is some twice differentiable function, $\gamma_2 > 0$, $\gamma_1 > 0$. The " \perp " means that X and λ are orthogonal, i.e. $X\lambda = 0$. It is clear that $X^{i,nc} \equiv X_d^*$. If $X_d^*(t) < 0$ on some interval of time I , then the desired trajectory of the constrained system cannot be $X_d^*(\cdot)$. Rather, this is going to be simply 0 on I . Item **d**) means that the function V used for stability purpose (e.g. a quadratic function of the tracking error) is zero on Ω_{2k+1} (constrained-motion phases). Therefore the Lyapunov function will be defined such that on I_k and on Ω_{2k+1} one has $V(X, \dot{X}, t) = 0$. Since this is a tracking control problem and since the desired trajectory is equal to 0 on such phases (even the rebound phase), we conclude that the tracking error $\tilde{X}(\cdot)$ entering $V(\cdot)$ has to satisfy $\tilde{X}(\cdot) = 0$, so that $V(\tilde{X} = 0, \dot{\tilde{X}} = 0) = 0$. Thus $\tilde{X}(\cdot)$ cannot be defined from $X_d^*(\cdot)$ neither from $X^{i,nc}$ but from a third signal which we shall denote as $X_d(\cdot)$. Let us again clarify the difference between $X_d^*(\cdot)$ and $X_d(\cdot)$. Let us take a constant $X_d^* < 0$ in (6). Then $X^{i,nc} = X_d^*$ but since the fixed point of the complementarity system is $(X, \dot{X}) = (0, 0)$, we must have $V(X = 0, \dot{X} = 0) = 0$ so that the restriction of V to the Poincaré section $\Sigma^+ = \{X | X = 0, \dot{X} > 0\}$ is a Lyapunov function for the corresponding Poincaré impact mapping P_Σ . Consequently we shall define $X_d = 0$ during these periods of time. In the following we shall denote $\tilde{X} = X - X_d$ and $\bar{X} = X - X_d^*$. Finally in general $X^{i,nc} \neq X_d^*$ because X_d^* may be chosen to evolve from one transition phase I_k to the next one I_{k+1} whereas $X^{i,nc}(\cdot)$ does not depend on the cycle index k .

Such conditions appear quite stringent. Actually we are looking for the most direct extension of Lyapunov's second method for complementarity systems as in (1) evolving as in (5). If the task is less complex than (5) and/or the dynamics possess some strong properties (see [Brogliato, 1999, chapter 8]) then the stability analysis may simplify.

The control strategy which is developed in the sequel, takes all these features into account and especially imposes an desired trajectory $X^{i,nc}$ as depicted in Fig. 4. The orbits of the trajectories are depicted. Tangential contact is made at A'' when force control starts so that $X^{i,nc}$ jumps at B . In addition item β) is taken into account by imposing a "bouncing-ball" dynamics only during the transient period, i.e. on I_k with $k < +\infty$. In other words the trajectory $X^{i,nc}(t)$ makes a tangential contact with $\partial\Phi$ because if initial data satisfy $X(0) - X_d^*(0) = 0$ and $\dot{X}(0) - \dot{X}_d^*(0) = 0$ on Ω_{2k} , then $X(t) \equiv X^{i,nc}(t)$ for $t \in \Omega_{2k}$, but during the transient period the controller assures the existence of collisions on phases I_k . Therefore between points A and B on figure 4, one may have $X_d^*(\cdot)$ which violates the constraint during the transient period, and converges towards a tangential approach trajectory after a finite or infinite number of transition phases (or cycles $\Omega_{2k} \cup I_k \cup \Omega_{2k+1}$). Between B and C the phase Ω_{2k+1} occurs during which objective ii) is fulfilled. The dashed orbit $AA'B'$ on Fig. 4 represents $X_d^*(\cdot)$ during a transition phase with impacts. The system stabilizes on $\partial\Phi$ between A and B' when the controller is switched to a force control so that $X^{i,nc}(\cdot)$ and $X_d^*(\cdot)$ may jump to B . In the control scheme described later, the point B' will converge (in a finite or infinite number of cycles) towards A'' . We finally define the closed-loop desired trajectory of the complementarity system as $X^{i,c}(\cdot)$. On Fig. 4, $X^{i,c}(\cdot)$ is the curve $(CAA''C)$ and $X^{i,c}(\cdot) \in \partial\Phi$ on $(A''C)$. It is an impactless trajectory. Let us assume that a periodic motion is desired. Then on Fig. 4 only the orbits of $X^{i,nc}(\cdot)$ (i.e. $AA''BCA$) and $X^{i,c}(\cdot)$ (i.e. $AA''CA$) are fixed. The other two orbits may vary with the

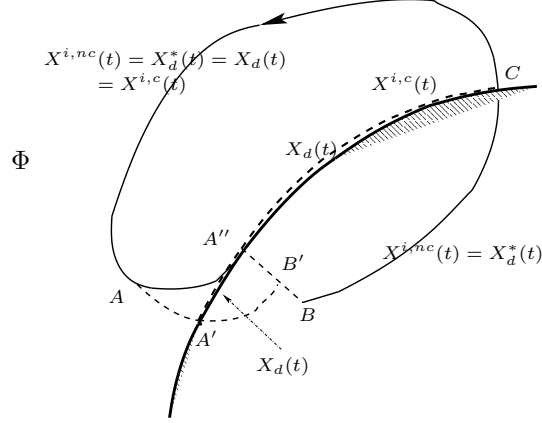

Figure 4: The closed-loop desired trajectories and control signals.

cycle index k . But on a single phase I_k the fixed point of the closed-loop error system may indeed be a signal $X_d \in \partial\Phi$ ($A'A''$) which differs from $X_d^* \notin \Phi$ ($A'B'$). The orbits ($AA'B'$) and the point A' generally vary from one cycle $\Omega_{2k} \cup I_k \cup \Omega_{2k+1}$ to the next cycle $\Omega_{2k+2} \cup I_{k+1} \cup \Omega_{2k+3}$. One can also interpret this as defining a desired trajectory $X_d^*(\cdot)$ on each cycle $\Omega_{2k} \cup I_k \cup \Omega_{2k+1}$, which is iterated from cycle k to cycle $k+1$ so that it converges towards $X^{i,c}(\cdot)$. The mixture between the DES and continuous dynamics clearly appears.

In summary the control strategy and stability analysis are led with four different trajectories: $X_d^*(\cdot)$ in the control input, $X_d(\cdot)$ in the Lyapunov function, $X^{i,c}(\cdot)$ and $X^{i,nc}(\cdot)$. Still referring to Fig. 4: when the system is initialised on $X^{i,c}(\cdot)$ between C and A (i.e. on Ω_0), then $X_d(t) = X^{i,c}(t)$ on (CA'') and $X_d(t) \in \partial\Phi$ on $(A''C)$. If initially $X(0) \neq X^{i,c}(0)$ and/or $\dot{X}(0) \neq \dot{X}^{i,c}(0)$, then $X_d(\cdot)$ differs and is set to zero in the Lyapunov function at a time corresponding to the first impact. This is the major discrepancy compared to unconstrained motion control in which all four trajectories are the same, usually denoted as $X_d(\cdot)$ (see remark 3).

2 Stability Framework

The stability criterion used in this paper is an extension of the Lyapunov second method adapted to closed loop mechanical system with unilateral constraints and has been proposed in [Brogliato *et al.*, 1997] and [Brogliato *et al.*, 2000]. Let $x(\cdot)$ denote the state of the closed-loop system in (1) with some feedback controller $u(X, \dot{X}, t)$.

Definition 2 (Ω -weakly stable system) *The closed-loop system is Ω -weakly stable if for each $\epsilon > 0$, there exists $\delta(\epsilon) > 0$ such that $\|x(0)\| \leq \delta(\epsilon) \Rightarrow \|x(t)\| \leq \epsilon$ for all $t \geq 0$, $t \in \Omega = \cup_{k \geq 0} \Omega_k$. Asymptotic weak stability holds if in addition $x(t) \rightarrow 0$ as $t \rightarrow +\infty$,*

$t \in \Omega$. Practical Ω -weak stability holds if there is a ball centered at $x = 0$, with radius $R > 0$, and such that $x(t) \in B(0, R)$ for all $t \geq T$; $T < +\infty$, $t \in \Omega$, $R < +\infty$. ■

Let us define the closed-loop impact Poincaré map that corresponds to the section $\Sigma_{\mathcal{I}}^- = \{x | F_i(X) = 0, \dot{X}^T \nabla F_i(X) < 0, i \in \mathcal{I}\}$, which is a hypersurface of codimension $\alpha = \text{card}(\mathcal{I})$. The pre-impact velocities are chosen to define $P_{\Sigma_{\mathcal{I}}}$ for a reason given after claim 3. We define:

$$P_{\Sigma_{\mathcal{I}}} : \Sigma_{\mathcal{I}}^- \rightarrow \Sigma_{\mathcal{I}}^- \quad (7)$$

$$x_{\Sigma_{\mathcal{I}}}(k) \mapsto x_{\Sigma_{\mathcal{I}}}(k+1).$$

where $x_{\Sigma_{\mathcal{I}}}$ is the state of $P_{\Sigma_{\mathcal{I}}}$. Let us introduce the positive function $V(\cdot)$ that will serve in the subsequent analysis. Let $V_{\Sigma_{\mathcal{I}}}$ denote the restriction of V to $\Sigma_{\mathcal{I}}$.

Definition 3 (Strongly stable system) *The system is said strongly stable if: (i) it is Ω -weakly stable, (ii) on phases I_k , $P_{\Sigma_{\mathcal{I}}}$ is Lyapunov stable with Lyapunov function $V_{\Sigma_{\mathcal{I}}}$, and (iii) the sequence $\{t_k\}_{k \in \mathbb{N}}$ has a finite accumulation point $t_\infty < +\infty$.* ■

Clearly $P_{\Sigma_{\mathcal{I}}}$ has a fixed point $x_{\Sigma_{\mathcal{I}}}^* \in \partial\Phi$. Let $V(\cdot)$ satisfy $\beta(\|x\|) \geq V(x, t) \geq \alpha(\|x\|)$, $\alpha(0) = 0$, $\beta(0) = 0$, $\alpha(\cdot)$ and $\beta(\cdot)$ strictly increasing. Let $I_k = [\tau_0^k, t_f^k]$.

Claim 1 (Ω -Weak Stability [Brogliato *et al.*, 1997]) *Assume that the task is as in (5), and that*

- (a) - $\lambda[\Omega] = +\infty$,
- (b) - for each $k \in \mathbb{N}$, $\lambda[I_k] < +\infty$,
- (c) - $V(x(t_f^k), t_f^k) \leq V(x(\tau_0^k), \tau_0^k)$,
- (d) - $V(x(\cdot), \cdot)$ uniformly bounded on each I_k .

If on Ω , $\dot{V}(x(t), t) \leq 0$ and $\sigma_V(t_k) \leq 0$ for all $k \geq 0$, then the closed-loop system is Ω -weakly stable. If $\dot{V}(x(t), t) \leq -\gamma(\|X\|)$, $\gamma(0) = 0$, $\gamma(\cdot)$ strictly increasing, then the system is asymptotically Ω -weakly stable. ■

This accomodates for other types of motions than the one as in (5), see [Brogliato *et al.*, 1997]. Let us assume that $t_\infty < +\infty$. It is noteworthy that from [Ballard, 2001, proposition 4.11] this implies $e_n < 1$ (because if $e_n = 1$ impact times satisfy $t_{k+1} - t_k \geq \beta_k > 0$ with $\sum_{k \geq 0} \beta_k$ unbounded, so that $t_\infty = +\infty$).

Claim 2 (Ω -Weak Stability) *Let us assume that (a) and (b) in claim (1) hold, and that*

- (a) - outside phases I_k one has $\dot{V}(t) \leq -\gamma V(t)$ for some $\gamma > 0$,
- (b) - inside phases I_k one has $V(t_{k+1}^-) - V(t_k^+) \leq 0$, for all $k \geq 0$,

- (c) - the system is initialized on Ω_0 with $V(\tau_0^0) \leq 1$,
 (d) - $\sum_{k \geq 0} \sigma_V(t_k) \leq KV^\kappa(\tau_0^k) + \epsilon$ for some $\kappa \geq 0$, $K \geq 0$ and $\epsilon \geq 0$.

Then there exists a constant $N < +\infty$ such that $\lambda[t_\infty^k, t_f^k] = N$, for all $k \geq 0$ (the cycle index), and such that:

- (i) - If $\kappa \geq 1$, $\epsilon = 0$ and $N = \frac{1}{\gamma} \ln(\frac{1+K}{\delta})$ for some $0 < \delta < 1$, then $V(\tau_0^{k+1}) \leq \delta V(\tau_0^k)$. The system is asymptotically weakly stable.
 (ii) - If $\kappa < 1$, then $V(\tau_0^k) \leq \delta(\gamma)$, where $\delta(\gamma)$ is a function which can be made arbitrarily small by increasing γ . The system is practically Ω -weakly stable with $R = \alpha^{-1}(\delta(\gamma))$.

■

Let us notice that the upperbound in (d) is the key point of the analysis. It characterizes the uncertainty that is allowed in the variation of function $V(\cdot)$

Proof

From assumption (a) of claim 2, one has

$$V(t_f^k) \leq V(t_\infty) e^{-\gamma(t_f^k - t_\infty)} \quad (8)$$

From assumptions (b) and (d) of claim 2, one has

$$\begin{aligned} V(t_\infty) &\leq V(\tau_0^k) + \sum_{k=0}^{\infty} \sigma_V(t_k) + \sum_{k=0}^{\infty} V(t_{k+1}^-) - V(t_k^+) \\ &\leq V(\tau_0^k) + KV^\kappa(\tau_0^k) + \epsilon \end{aligned} \quad (9)$$

Inequalities (9) and (8) give

$$V(t_f^k) \leq e^{-\gamma(t_f^k - t_\infty)} [V(\tau_0^k) + KV^\kappa(\tau_0^k) + \epsilon] \quad (10)$$

Let us now analyse two cases:

- (i) If $\kappa \geq 1$, then $V(\tau_0^k) \geq V^\kappa(\tau_0^k)$. If $\epsilon = 0$, Eq. (10) becomes

$$V(t_f^k) \leq e^{-\gamma(t_f^k - t_\infty)} (1 + K) V(\tau_0^k) \quad (11)$$

If we want to have $V(t_f^k) \leq \delta V(\tau_0^k)$, we must choose $\lambda[t_f^k - t_\infty]$ such that:

$$e^{-\gamma(t_f^k - t_\infty)} (1 + K) \leq \delta \quad (12)$$

This is assured by choosing $\lambda[t_f^k - t_\infty] = N$ with

$$N = \frac{1}{\gamma} \ln\left(\frac{1+K}{\delta}\right) \quad (13)$$

Clearly if $\delta > 0$, then $N < +\infty$, which proves the first item.

(ii) If $\kappa \leq 1$ then $V(\tau_0^k) \leq V^\kappa(\tau_0^k) \leq 1$. Inequality (10) becomes

$$V(t_f^k) \leq e^{-\gamma(t_f^k - t_\infty)}(1 + K + \epsilon) = \delta(\gamma) \quad (14)$$

The term $\delta(\gamma)$ can be made as small as desired by increasing γ (or increasing $\lambda[t_f^k - t_\infty]$). The proof is complete since $\alpha(\|x\|) \leq V(x, t)$ for all x and t . ■

Claim 3 (Strong Stability) *The system is strongly stable if in addition to the conditions in claim 1 one has:*

- $V(t_{k+1}^-) \leq V(t_k^-)$;
- V is uniformly bounded and time continuous on $I_k - \cup_k \{t_k\}$.

Then the system is strongly stable in the sense of definition 3. ■

Sufficient conditions for strong stability are that $\sigma_V(t_k) \leq 0$ and $V(t_{k+1}^-) \leq V(t_k^+)$, but this framework permits $\sigma_V(t_k) \geq 0$ provided $V(t_{k+1}^-) < V(t_k^+) - \delta$ for some large enough $\delta > 0$. Notice also that $\dot{V}(t)$ needs not to be ≤ 0 along the system's trajectories on the whole of (t_k, t_{k+1}) . The reason why we have chosen $\Sigma_{\mathcal{I}}^-$ and not $\Sigma_{\mathcal{I}}^+$ in (7) is that it allows us to take into account the value $V(t_0^-)$ in the stability analysis. Notice that $\dot{q}(t_\infty^+) = \dot{q}(t_\infty^-)$.

In order to summarize the consequences of what is stated in Secs. 1-2, let us propose the following:

Proposition 1 *Let the Lagrangian complementarity system as in (1) perform a motion as in (5), with the closed-loop requirements as in i), ii), iii). Let us assume that asymptotic tracking controllers are used on phases Ω_k . Then the asymptotic stability in the sense of definitions 2 and 3 implies that:*

- *The asymptotically stable closed-loop desired trajectory $X^{i,c}(\cdot)$ is impactless.*
- *During the transient period the feedback controller has to guarantee the existence of collisions with $\partial\Phi$ and a finite-time stabilisation on $\partial\Phi$.*
- *Contrary to the unconstrained motion case ($\Phi = \mathbb{R}^n$), the signals $X_d(\cdot)$ entering the Lyapunov function, $X_d^*(\cdot)$ in the controller, and $X^{i,c}(\cdot)$, are not equal to a single so-called desired trajectory.* ■

This proposition is a consequence of items i), ii), iii), α) through δ), **a**) through **d**), as well as of definitions 2 and 3.

3 Tracking Controller Framework

3.1 Controller structure

To make the controller design easier the dynamical equations (1) are considered in the generalized coordinates introduced in [McClamroch & Wang, 1988]. After transformation

in the new coordinates $q = \begin{bmatrix} q_1 \\ q_2 \end{bmatrix}$, $q_1 = \begin{bmatrix} q_1^1 \\ \vdots \\ q_1^m \end{bmatrix}$, $q = Q(X) \in \mathbb{R}^n$, the dynamic system is as follows :

$$\left\{ \begin{array}{l} M_{11}(q)\ddot{q}_1 + M_{12}(q)\ddot{q}_2 + C_1(q, \dot{q})\dot{q} + g_1(q) = T_1(q)u + \lambda \\ M_{21}(q)\ddot{q}_1 + M_{22}(q)\ddot{q}_2 + C_2(q, \dot{q})\dot{q} + g_2(q) = T_2(q)u \\ q_1^i \geq 0, \quad q_1^i \lambda_i = 0, \quad \lambda_i \geq 0, \quad 1 \leq i \leq m \\ \text{Collision rule} \end{array} \right. \quad (15)$$

where the set of complementarity relations can be written more compactly as $0 \leq \lambda \perp Dq \geq 0$ with $D = [I_m; 0] \in \mathbb{R}^{m \times n}$, I_m is the identity matrix. Clearly $M_{21}(q) = M_{12}^T(q) \in \mathbb{R}^{(n-m) \times m}$, $M_{11}(q) \in \mathbb{R}^{m \times m}$, $M_{22}(q) \in \mathbb{R}^{(n-m) \times (n-m)}$. In the new coordinates q one therefore has $\Phi = \{q | Dq \geq 0\}$. The tangent cone $T_\Phi(q_1 = 0) = \{v | Dv \geq 0\}$ is the space of admissible velocities on the boundary of Φ . The polar cone to $T_\Phi(\cdot)$ is the normal cone $N_\Phi(q) = \{v | \forall z \in T_\Phi, z^T v \leq 0\}$. In case $q \in \partial\Phi$, one gets $N_\Phi(q) = \{v | v = D^T \bar{\lambda}, \bar{\lambda} \leq 0\}$ [Hiriart-Urruty & Lemaréchal, 1996]. Obviously from (15) the generalized contact force $P_q = D^T \lambda \in -N_\Phi(q)$. The controller developed in this paper uses three different low-level control laws for each phase Ω_{2k} , Ω_{2k+1} and I_k ⁽³⁾:

$$T(q)u = \begin{cases} U_{nc} & \text{for } t \in \Omega_{2k} \\ U_t & \text{for } t \in I_k \\ U_c & \text{for } t \in \Omega_{2k+1} \end{cases}$$

where $T(q) = \begin{pmatrix} T_1(q) \\ T_2(q) \end{pmatrix} \in \mathbb{R}^{n \times n}$. A supervisor switches between this three control laws, and is described below (see Fig. 8). The stability of this controller is analyzed by using the criteria proposed in Sec. 2. The asymptotic stability of this scheme makes the system land on the constraint surfaces tangentially after enough cycles of constraints/free motions (one cycle = $\Omega_{2k} \cup I_k \cup \Omega_{2k+1}$). Asymptotically the transitions between free motion phases and permanently constraint phases are done without any collision.

³With some abuse of notations we assimilate the time domains to the modes that correspond to the three phases in (5).

Remark 1 (Dynamic coupling effects) From (15) it follows that $\sigma_{\dot{q}_2}(t_k) = M_{22}^{-1}M_{21}\sigma_{\dot{q}_1}(t_k)$. Apply for instance a feedback linearizing input u in (15) so as to get the dynamics

$$\begin{cases} \ddot{q}_1 = v_1 + \lambda \\ \ddot{q}_2 = v_2 \end{cases} \quad (16)$$

where v_1 and v_2 are the new inputs. One is then tempted to mimick the one degree-of-freedom case, see [Brogliato *et al.*, 1997]. However except if $V(t) = T(t)$ (the kinetic energy) at time $t = t_k$, then there is few chance to get $\sigma_V(t_k) \leq 0$ (because the controller does not decouple the dynamics at impact times!). This precludes the use of any controller with Lyapunov function not resembling the system's mechanical energy. In the sequel we will use a Lyapunov function which is very close to the nonsmooth global energy of the system. This will help us a lot in the stability analysis. ■

Let us choose:

$$V(t, \tilde{q}, \dot{\tilde{q}}) = \frac{1}{2} \dot{\tilde{q}}^T M(q) \dot{\tilde{q}} + \frac{1}{2} \gamma_1 \tilde{q}^T \tilde{q} \quad (17)$$

with $\tilde{q}(\cdot) = q(\cdot) - q_d(\cdot)$. The control law used in this scheme is based on the controller presented in [Paden & Panja, 1988], originally designed for free-motion position and velocity global asymptotic tracking. Let us propose:

$$T(q)u = \begin{cases} U_{nc} = M(q)\ddot{q}_d^* + C(q, \dot{q})\dot{q}_d^* + g(q) - \gamma_1(q - q_d^*) - \gamma_2(\dot{q} - \dot{q}_d^*) \\ U_t = U_{nc} & \text{before the first impact} \\ U_t = g(q) - \gamma_1(q - q_d^*) - \gamma_2\dot{q} & \text{after the first impact} \\ U_c = U_{nc} - P_d + K_f(P_q - P_d) \end{cases} \quad (18)$$

where $\gamma_1 > 0$, $\gamma_2 > 0$, $K_f > 0$, $P_d = D^T \lambda_d$ is the desired force we want for the permanently constraint motion. The signals q_d^* and \dot{q}_d^* will be defined later, as well as the switching conditions between the controllers in (18). The overall structure of the controller is depicted in Fig. 5. One sees that the controller structure is constant. Discontinuities are a consequence of the feedforward part only. The switchings may be event-based, or open-loop, see Fig. 8 which depicts how the supervisor is designed. The interest for choosing this controller is that the function $V(t, \tilde{q}, \dot{\tilde{q}})$ in (17) is very close to the total energy of the system. Notice that u in (18) is independent of the restitution coefficient e_n . From (18) the third condition in claim 1 can be replaced by $V(t_f^k) \leq V(t_0^-)$ since $V(t_0^-) \leq V(\tau_0^k)$.

Remark 2 It is noteworthy that in order for the system to track a sequence of modes as in (5), some conditions on the initial state and the selected input are required. This is called *synchronicity of the high-level controller and the system's modes* defined in (5) in [Brogliato *et al.*, 2000].

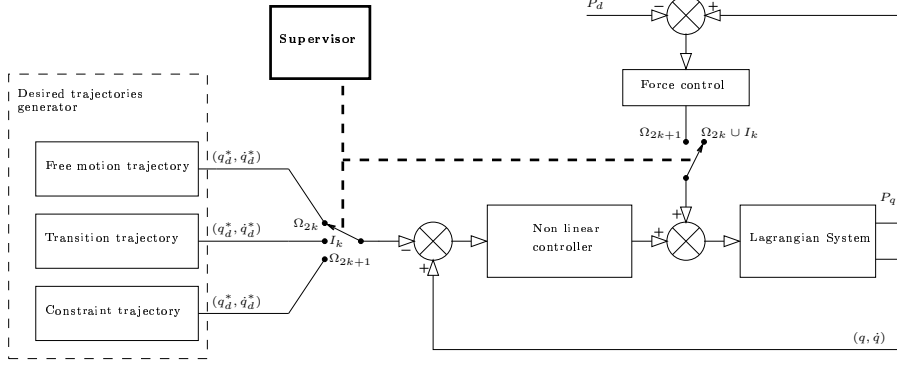

Figure 5: Structure of the controller

■

As observed in the introduction, a control strategy which consists of attaining the surface $\partial\Phi$ tangentially and without incorporating impacts in the stability analysis, cannot work in practice due to its lack of robustness. In view of this, the control law for the transition phase is defined in order :

- To make the system hit the constraint surface (and then dissipate energy during impacts) if the tracking error is not zero.
- To make the system approach the constraint surface tangentially (without rebound) if the tracking is perfect.

These two situations are conflicting. On the other hand the coupling between q_1 and q_2 in (15), and the stability framework in claims 1 and 3, make the asymptotic stability quite difficult to obtain if velocities are subject to discontinuities. Indeed as indicated in item c) in Sec. 1.5, any velocity jump at t_k implies $\sigma_V(t_k) > 0$ when $V \equiv 0$. Hence if the transition phase is constructed with impacts, one has to find a manner to get $V(t_f^k) = 0$ in order to force the system to remain on the desired trajectory $X_d(\cdot)$ (here $q_d(\cdot)$). This is not obvious in general (see remark 1) and defining $q_d^*(\cdot)$ as done below is a way to get the result.

Remark 3 If the system is unconstrained (i.e. $\Phi = \mathbb{R}^n$) then motion control is assured by setting $T(q)u \equiv U_{nc}$ and the trajectory $q_d^*(\cdot)$ is the unique closed-loop invariant. It is globally uniformly asymptotically stable in this case, see [Paden & Panja, 1988]. As we indicated in the introduction, many other controllers can be used in this case which all guarantee the same tracking properties.

3.2 Design of the desired trajectory on phases I_k .

During the transition phase $q_d^*(t)$ is defined as follows (see figure 6 for $q_{1d}^*(\cdot)$, where A, A', B', B and C correspond to Fig. 4):

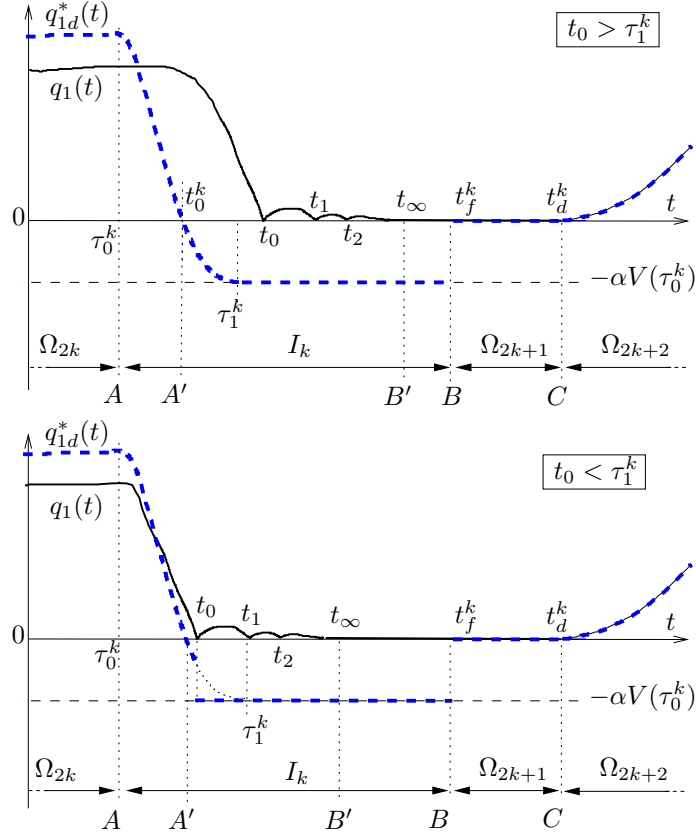

Figure 6: Trajectory $q_{1d}^*(t)$

Let us note that the indices k for the phases Ω_k and I_k and for the impact times t_k , are not related. They are dummy variables. To avoid possible confusion, all superscripts $(\cdot)^k$ will refer to cycle k in (5). Let us define:

- τ_0^k is the chosen by the designer as the start of the transition phase I_k ,
- t_0^k is the time corresponding to $q_{1d}^*(t_0^k)=0$,
- t_0 is the first impact,

- t_∞ is the finite accumulation point of the sequence $\{t_k\}_{k \geq 0}$,
- t_f^k is the end of the transition phase I_k ,
- τ_1^k is such that $q_{1d}^*(\tau_1^k) = -\alpha V(\tau_0^k)$ and $\dot{q}_{1d}^*(\tau_1^k) = 0$ ⁽⁴⁾.
- $\Omega_{2k+1} = [t_f^k, t_d^k]$, t_d^k will be defined in Sec. 3.3 (see Fig. 7).

One has $I_k = [\tau_0^k, t_f^k]$, $\Omega_{2k+1} = [t_f^k, t_d^k]$. On $[\tau_0^k, t_0)$, we impose that $q_d^*(t)$ is twice differentiable, and $q_{1d}^*(t)$ decreases towards $-\alpha V(\tau_0^k)$ on $[\tau_0^k, \tau_1^k]$. In order to cope with the coupling between q_1 and q_2 , the signal $q_{2d}^*(t) \in C^2(\mathbb{R}^+)$ is frozen during the transition phase, i.e.:

- $q_{2d}^*(t) = q_{2d}^*$, $\dot{q}_{2d}^*(t) = 0$ on $[\tau_0^k, t_\infty]$
- $q_{2d}^*(t)$ is defined on $[\tau_0^k, t_0^k]$ such that $\dot{q}_{2d}^*(t_0^k) = 0$.

On $(t_0, t_f^k]$, we define q_d and q_d^* as follows :

$$q_d = \begin{pmatrix} 0 \\ q_{2d}^* \end{pmatrix}, q_d^* = \begin{pmatrix} -\alpha V(\tau_0^k) \\ q_{2d}^* \end{pmatrix} \quad (19)$$

On $[t_f^k, t_d^k]$ we set $q_d = \begin{pmatrix} 0 \\ q_{2d}(t) \end{pmatrix}$ and $q_{1d}^* = 0$. Therefore on (t_f^k, t_d^k) one has $q_d(t) = q_d^*(t)$. The purpose of q_d^* is to create a ‘‘virtual’’ potential force which stabilizes the system on $\partial\Phi$ even if the position of the constraint is uncertain. Consequently the fixed point (q_d, \dot{q}_d) of the complementarity system is used in the expression of the Lyapunov function ($\tilde{q} = q - q_d$), whereas the unreachable fixed point q_d^* is used in the control law ($\bar{q} = q - q_d^*$ with q_d^* as in (19)). In U_{nc} in (18) we have $q_d^*(\cdot) = q_d(\cdot)$ since $q_d^*(t) = q_d(t)$ for $t \in \Omega_{2k} \cup [\tau_0^k, t_0]$. In summary, after the first impact at t_0 , $q_{1d}(\cdot)$ is set to zero while in case $\tau_1^k > t_0$, $q_{1d}^*(\cdot)$ is set to $-\alpha V(\tau_0^k)$ (in other words U_t switches as indicated in(18)). Since $\dot{q}_{1d}(t_0^-) \neq 0$ and $q_{1d}(t_0^-) \neq 0$ in general, the trajectory $q_{1d}(\cdot)$ behaves like in a sort of plastic collision ($e_n = 0$). With respect to Fig. 4, one has τ_0^k at A , t_∞ at B' , t_0^k at A' , t_d^k at C , and B at t_f^k (the term $-P_d - K_f P_d$ defines the signal $X_d^*(\cdot)$ between B and C on Fig. 4). If $V(\tau_0^k) = 0$ then A'' corresponds to the time τ_1^k .

The piece of curve AA' on Fig. 4 is normal to $\partial\Phi$ (which in coordinates q is the codimension- m plane $q_1 = 0$). The closed-loop desired trajectory $X^{i,c}(\cdot)$ is defined as $q^{i,c}(t) = q_d^*(t)$ on Ω_{2k} , $q^{i,c}(t) = q_d^*(t)$ with $\alpha = 0$ on I_k , and $q_1^{i,c}(t) = 0$ on Ω_{2k+1} , $q_2^{i,c}(t) = q_{2d}^*(t)$ on \mathbb{R}^+ . It is impactless.

The choice for $q_d^(\cdot)$ is done essentially to get $\sigma_V(t_k) \leq 0$ on I_k .*

⁴In [Brogliato, 1999] [Brogliato *et al.*, 2000] it is implicitly assumed in the stability proofs that $\tau_1^k < t_0$, which is a shortcoming that we avoid in this paper.

Remark 4 It is noteworthy that the proposed strategy implies that U_c is switched only after stabilisation on $\partial\Phi$ is achieved. This implies that the period at which a cycle $\Omega_{2k} \cup I_k \cup \Omega_{2k+1}$ is performed, is lower-bounded by $|t_\infty - t_0|$. If impacts are plastic ($e_n = 0$) then the speed of a cycle can be increased while if e_n is close to 1 the programmed speed must be smaller. This is logical from an intuitive point of view since this is a consequence on how much kinetic energy impacts dissipate.

Remark 5 Due to the fact that we want V_{Σ_X} to act as a Lyapunov function for P_{Σ_X} in (7) and since the Poincaré mapping fixed point satisfies $q_{\Sigma_X,1}^* = 0$, we have to set q_{1d} to zero and q_{2d} constant on the transition phase. However the approach trajectory (AA') on Fig. 4 is not so easy to design. This is what claim 5 below solves.

3.3 Conditions for take-off

In the previous subsection we designed the trajectory $q_d^*(\cdot)$ to stabilize the system on $\partial\Phi$. We now deal with the conditions on the control signal $U_c(q_d, \dot{q}_d, \ddot{q}_d, P_d)$ for take-off at the end of Ω_{2k+1} . On $[t_f^k, t_d^k]$, the dynamics of the system is defined by:

$$M(q)\ddot{q} + F(q, \dot{q}) = U_c + D^T \lambda \quad (20a)$$

$$0 \leq q_1 \perp \lambda \geq 0 \quad (20b)$$

with $F(q, \dot{q}) = C(q, \dot{q})\dot{q} + G(q)$. On $[t_f^k, t_d^k]$, the system is permanently constrained, i.e. $q_1(\cdot) = 0$ and $\dot{q}_1(\cdot) = 0$. Then (20b) implies [Glocker, 2001]:

$$0 \leq \ddot{q}_1 \perp \lambda \geq 0 \quad (22)$$

There is take-off at t_d^k if $\ddot{q}_1(t_d^{k+}) > 0$. From (22) a necessary condition to have $\ddot{q}_1(t_d^{k+}) > 0$ is that $\lambda(t_d^{k-}) = 0$.

Claim 4 Consider the closed-loop system (20) (18), during the permanently constraint phase $[t_f^k, t_d^k]$. Detachment is assured if

$$b(q, \dot{q}, U_{nc}, \lambda_d) > 0$$

with $b(q, \dot{q}, U_{nc}, \lambda_d) = DM^{-1}(q)[-F(q, \dot{q}) + U_{nc} - D^T(1 + K_f)\lambda_d]$. ■

Proof.

Let us detail the expression of the Linear Complementarity Problem (LCP) in (22). With the notation of Sec. 3.1, (22) can be rewritten as

$$0 \leq D\ddot{q} \perp \lambda \geq 0 \quad (23)$$

From (20a) and (18), one has:

$$\begin{aligned}\ddot{q} &= M^{-1}(q)[-F(q, \dot{q}) + U_c + D^T \lambda] \\ &= M^{-1}(q)[-F(q, \dot{q}) + U_{nc} + (1 + K_f)(D^T \lambda - P_d)]\end{aligned}\quad (24)$$

By inserting (24) in (23), one obtains the following LCP:

$$0 \leq \underbrace{DM^{-1}(q)[-F(q, \dot{q}) + U_{nc} - (1 + K_f)D^T \lambda_d]}_{b(q, \dot{q}, U, \lambda_d)} + \underbrace{(1 + K_f)DM^{-1}(q)D^T}_{A(q)} \lambda \perp \lambda \geq 0 \quad (25)$$

which we rewrite more compactly as

$$0 \leq b(q, \dot{q}, U_{nc}, \lambda_d) + A(q)\lambda \perp \lambda \geq 0 \quad (26)$$

Let us study the LCP in (26). Since $A(q) > 0$ there is a unique solution:

- If $b(\cdot) > 0$, then $b(\cdot) + A(q)\lambda > 0$ and the orthogonality condition $b(\cdot) + A(q)\lambda \perp \lambda$ implies $\lambda = 0$.
- If $b(\cdot) < 0$ then the condition $0 \leq b(\cdot) + A(q)\lambda_1$ and the orthogonality imply $\lambda = -A^{-1}(q)b(\cdot) > 0$.
- If $b(\cdot) = 0$ then (26) becomes $0 \leq A(q)\lambda \perp \lambda \geq 0$ and $\lambda = 0$.

In conclusion, $\lambda = 0$ if and only if $b(q, \dot{q}, U_{nc}, \lambda_d) \geq 0$. From (24) and (25)

$$\ddot{q}_1(t) = b(q, \dot{q}, U_{nc}, \lambda_d) + A(q)\lambda$$

If $\lambda = 0$, then $\ddot{q}_1(t) = b(q, \dot{q}, U_{nc}, \lambda_d)$, and a sufficient condition for detachment is:

$$b(q, \dot{q}, U_{nc}, \lambda_d) > 0$$

■

3.4 Control strategy to assure detachment

The only parameter we can tune to force take-off without influencing the variation of the Lyapunov function $V(\cdot)$ is $\lambda_d(t)$. By inserting (18) in the expression of $b(q, \dot{q}, U_{nc}, \lambda_d)$, one gets:

$$b(q, \dot{q}, U_{nc}, \lambda_d) = DM^{-1}(q)[M(q)\ddot{q}_d - C(q, \dot{q})\dot{\tilde{q}} - \gamma_1\tilde{q} - \gamma_2\dot{\tilde{q}} - D^T(1 + K_f)\lambda_d] \quad (27)$$

After some computation, (27) and the result of claim 4 provide a sufficient condition for take-off (time argument is dropped in (28)):

$$\begin{aligned} \ddot{q}_1 &= \left([M_{(q)}^{-1}]_{11} C_{11}(q, \dot{q}) + [M_{(q)}^{-1}]_{12} C_{21}(q, \dot{q}) \right) \dot{q}_{1d} + \gamma_2 [M_{(q)}^{-1}]_{11} \dot{q}_{1d} + \gamma_1 [M_{(q)}^{-1}]_{11} q_{1d} \\ &\quad - \left([M_{(q)}^{-1}]_{21} C_{11}(q, \dot{q}) + [M_{(q)}^{-1}]_{22} C_{21}(q, \dot{q}) \right) \dot{\tilde{q}}_2 - \gamma_2 [M_{(q)}^{-1}]_{21} \dot{\tilde{q}}_2 - \gamma_1 [M_{(q)}^{-1}]_{21} \tilde{q}_2 \\ &\quad - [M_{(q)}^{-1}]_{11} (1 + K_f) \lambda_d + \ddot{q}_{1d} > 0 \end{aligned} \quad (28)$$

with the decomposition of matrix $M^{-1}(q)$ and $C(q, \dot{q})$ as:

$$M^{-1}(q) = \begin{pmatrix} [M_{(q)}^{-1}]_{11} & [M_{(q)}^{-1}]_{12} \\ [M_{(q)}^{-1}]_{21} & [M_{(q)}^{-1}]_{22} \end{pmatrix} \quad \text{and} \quad C(q, \dot{q}) = \begin{pmatrix} C_{11}(q, \dot{q}) & C_{12}(q, \dot{q}) \\ C_{21}(q, \dot{q}) & C_{22}(q, \dot{q}) \end{pmatrix}$$

Depending of the sign of \tilde{q}_2 and $\dot{\tilde{q}}_2$, $b(\cdot)$ is not necessarily positive with $\lambda_d = 0$. Therefore we have to choose a profile for $\lambda_d(t)$ which is continuously decreasing until $b(q, \dot{q}, U_{nc}, \lambda_d) > 0$, even if a negative desired force is meaningless because it is not reachable (see Fig. 7). The time t_d^k is defined as the first instant such that $\ddot{q}_1(t_d^k) > 0$. Since all signals are bounded, from (28) t_d^k is guaranteed to be bounded as well.

Now we have to assure that the system does not make contact again with $\partial\Phi$ when the control law switches from $U_c(t_d^{k-})$ to $U_{nc}(t_d^{k+})$ at the take-off. Then $U_{nc}(t_d^{k+})$ has to be chosen to guarantee $\ddot{q}_1(t_d^{k+}) > 0$.

At t_d^{k-} , the control law is U_c and $q_{1d}(t_d^{k-}) = 0$, $\dot{q}_{1d}(t_d^{k-}) = 0$ and $\ddot{q}_{1d}(t_d^{k-}) = 0$. Therefore (28) is simplified to:

$$\begin{aligned} \ddot{q}_1(t_d^{k-}) &= b(q, \dot{q}, U_{nc}, \lambda_d) \\ &= - \left([M_{(q)}^{-1}]_{21} C_{11}(q, \dot{q}) + [M_{(q)}^{-1}]_{22} C_{21}(q, \dot{q}) \right) \dot{\tilde{q}}_2 - \gamma_2 [M_{(q)}^{-1}]_{21} \dot{\tilde{q}}_2 \\ &\quad - \gamma_1 [M_{(q)}^{-1}]_{21} \tilde{q}_2 - [M_{(q)}^{-1}]_{11} (1 + K_f) \lambda_d(t_d^{k-}) > 0 \end{aligned} \quad (29)$$

At t_d^{k+} , the control law is U_{nc} so that $\lambda_d(t_d^{k+}) = 0$ in $b(q, \dot{q}, U_{nc}, \lambda_d)$ evaluated at t_d^k . Since the desired trajectory has to be twice differentiable, let us choose $q_{1d}(t_d^{k+}) = 0$ and $\dot{q}_{1d}(t_d^{k+}) = 0$. We obtain:

$$\begin{aligned} \ddot{q}_1(t_d^{k+}) &= b(q, \dot{q}, U_{nc}, 0) \\ &= - \left([M_{(q)}^{-1}]_{21} C_{11}(q, \dot{q}) + [M_{(q)}^{-1}]_{22} C_{21}(q, \dot{q}) \right) \dot{\tilde{q}}_2 - \gamma_2 [M_{(q)}^{-1}]_{21} \dot{\tilde{q}}_2 \\ &\quad - \gamma_1 [M_{(q)}^{-1}]_{21} \tilde{q}_2 + \ddot{q}_{1d}(t_d^{k+}) \end{aligned} \quad (30)$$

Finally the condition to guarantee $q_1(t) > 0$ on $(t_d^k, t_d^k + \epsilon)$, for some $\epsilon > 0$, is that the term $\ddot{q}_{1d}(t_d^{k+})$ in (30) compensates the loss of the term $-[M_{(q)}^{-1}]_{11}(1 + K_f)\lambda_d$ in (29) due to the switching from U_c to U_{nc} . The condition on the desired trajectories at the beginning of the free-motion phase Ω_{2k+2} is:

$$\ddot{q}_{1d}(t_d^{k+}) \geq \max\left(0, -[M_{(q(t_d^k))}^{-1}]_{11}(1 + K_f)\lambda_d(t_d^{k-})\right) \quad (31)$$

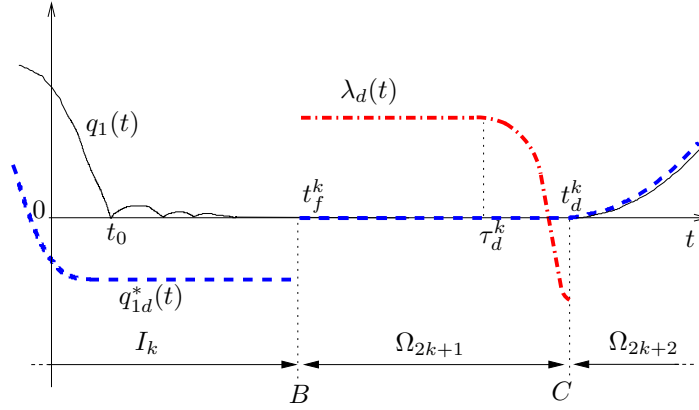

Figure 7: Trajectory $\lambda_d(t)$

Remark 6 *It is interesting to notice that the two transitions $\Omega_{2k} \rightarrow \Omega_{2k+1}$ and $\Omega_{2k+1} \rightarrow \Omega_{2k+2}$, are monitored by desired signals q_{1d}^* and λ_d which violate the complementarity conditions, as shown in Fig. 7.*

3.5 Closed-loop stability analysis

The closed-loop dynamical system is now completely defined. It consists of a somewhat complex dynamical system, with complementarity conditions, impact law, and switching torque input.

$$\begin{array}{ccccccc}
 \Omega_{2k} & \longrightarrow & I_k & \longrightarrow & \Omega_{2k+1} & \longrightarrow & \Omega_{2k+2} \\
 (U_{nc}) & & (U_t) & & (U_c) & & (U_{nc}) \\
 & \uparrow & \uparrow & \uparrow & \uparrow & & \\
 & \text{time-based} & \text{state-based} & \text{state-based} & \text{state-based} & & \\
 & (\tau_0^k) & (t_f^k \geq t_\infty) & (t_d^k = \text{detachment}) & & &
 \end{array}$$

The aim is now to prove that this dynamical system, seen as an error system with state the vector $(\tilde{q}, \dot{\tilde{q}})$, is stable in the sense of definitions 2 and 3. As we saw this means that asymptotically the trajectory $q^{i,c}(\cdot)$ is attained. The closed-loop state can be chosen as $x = (\tilde{q}, \dot{\tilde{q}})$, according to definition 2 which concerns only phases Ω_k .

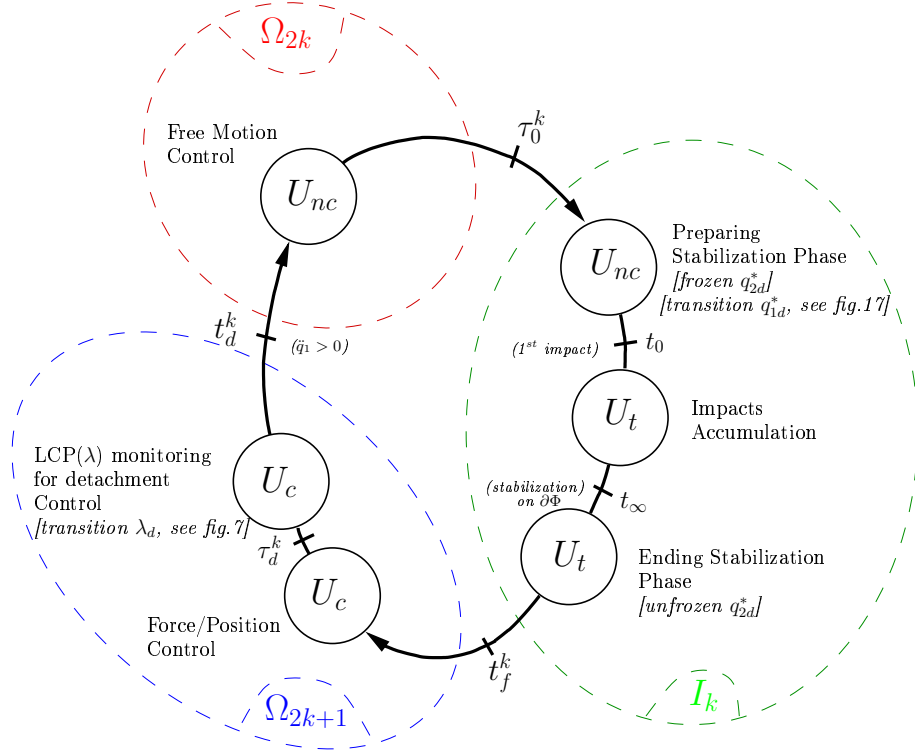

Figure 8: Supervisor evolution.

Definition 4 $\{CI\}$ is the subspace of initial conditions $x(0)$ which assure $t_0 \geq \tau_1^k$ uniformly along a motion as in (5).

The foregoing developments hold independently of m . Let us assume that $m = 1$ now. We will come back to the case $m \geq 2$ later on. $\{CI\}$ contains the initial data guaranteeing that no impact occurs before the signal $q_d^*(\cdot)$ is frozen. This is very useful because it can then be proved that the conditions for asymptotic strong stability are fulfilled. However in general $x(0) \notin \{CI\}$, so that an impact occurs before $q_d^*(\cdot)$ is frozen (i.e. $\dot{q}_d^*(t_0^-) \neq 0$, see figure 6). A specific analysis (completing the one in [Brogliato *et al.*, 2000]) has to be done.

Assumption 1 The controller U_t in (18) assures that a sequence $\{t_k\}_{k \geq 0}$ of impact times exists, with $\lim_{k \rightarrow +\infty} t_k = t_\infty < +\infty$.

One difficulty in the stability analysis along a cycle like in (5), is to assure that initial tracking errors do not increase from one cycle $\Omega_{2k} \cup I_k \cup \Omega_{2k+1}$ to the next, due to the

impacts. As we shall see next, one key point in the stability is the value of the first jump in $V(\cdot)$, i.e. $\sigma_V(t_0)$. Let us calculate the value of the jumps in $V(\cdot)$ at t_k :

$$\sigma_V(t_k) = T_L(t_k) - \frac{1}{2}\gamma_1 q_{1d}^2(t_k^-) - \frac{1}{2}\dot{q}_d(t_k^-)^T M(q(t_k))\dot{q}_d(t_k^-) + \dot{q}(t_k^-)^T M(q(t_k))\dot{q}_d(t_k^-) \quad (32)$$

where $T_L(t_k)$ is the loss of kinetic energy at impact t_k , and we used the fact that $\dot{q}_d(t_k^+) = 0$, $\dot{q}_{2d}(t_k^-) = 0$, $q_{2d}(t_k^+) = q_{2d}(t_k^-) = q_{2d}^*$ and $q_{1d}(t_k^+) = 0$.

For $k \geq 1$, one has $q_{1d}(t_k^+) = 0$ and $\dot{q}_d(t_k^-) = 0$. From the above definition of $q_d(\cdot)$ it is assumed that $t_0^k < t_0$, so that $\dot{q}_{2d}(t_0) = 0$. If this is not the case then $q_{2d}(\cdot)$ can be frozen earlier in the process to assure that at the first impact $\dot{q}_{2d}(t_0) = 0$. Then one has:

$$\begin{cases} \sigma_V(t_k) &= T_L(t_k) \leq 0 \\ \sigma_V(t_0) &= T_L(t_0) - \frac{1}{2}\gamma_1 q_{1d}^2(t_0^-) - \frac{1}{2}\dot{q}_d(t_0^-)^T M(q(t_0))\dot{q}_d(t_0^-) \\ &\quad + M_{11}(q(t_0))\dot{q}_1(t_0^-)\dot{q}_{1d}(t_0^-) + \dot{q}_2(t_0^-)^T M_{21}(q(t_0))\dot{q}_{1d}(t_0^-) \end{cases} \quad (33)$$

It is noteworthy that the equalities in (33) hold independently of the chosen impact rule. The only assumption is that impacts dissipate kinetic energy. The above choice for $q_d^*(\cdot)$ and switching strategy, is done in order to possibly obtain $\sigma_V(t_0) \leq 0$ and $\sigma_V(t_k) \leq 0$ for $k \geq 1$. Let us now state the following:

Claim 5 *Let assumption (1) hold. The system defined by (1) in closed-loop with the controller in (18) and $q_d(\cdot)$, $q_d^*(\cdot)$ as defined above, is :*

- (i) - *Asymptotically strongly stable if $x(0) \in \{CI\}$.*
- (ii) - *Asymptotically strongly stable if $q_d^*(\cdot)$ is designed such that at the first impact time of each phase I_k we have $[M_{11}(q(t_0))\dot{q}_1(t_0^-) + \dot{q}_2(t_0^-)^T M_{21}(q(t_0))]\dot{q}_{1d}(t_0^-) \leq 0$.*
- (iii) - *Asymptotically strongly stable if $M_{12} = 0$ and $e_n = 0$.*
- (iv) - *Asymptotically weakly stable if $M_{12} = 0$ and $0 \leq e_n < 1$.*

Proof. (i) The proof of the first item can be found in [Brogliato *et al.*, 2000]. Instances for which $\{CI\} \neq \emptyset$ can be calculated in simple cases like one degree-of-freedom systems. They occur under somewhat stringent conditions.

(ii) It follows immediately from (33) that if $[M_{11}(q(t_0))\dot{q}_1(t_0^-) + \dot{q}_2(t_0^-)^T M_{21}(q(t_0))]\dot{q}_{1d}(t_0^-) \leq 0$ then $\sigma_V(t_0) \leq 0$. And then we can use the proof done in [Brogliato *et al.*, 2000].

(iii) The proof of the third item follows the same line but in this case $\sigma_V(t_0)$ has to be shown to be negative because it is not equal to the kinetic energy loss. Let us consider Moreau's collision rule as written in (3). Notice that since $m = 1$

$$\text{prox}_{M(q(t_0))}[M^{-1}(q(t_0))N_{\Phi}(q(t_0)); \dot{q}(t_0^-)] = \dot{q}(t_0^-)^T M(q(t_0))n_q n_q \quad (34)$$

where $n_q = \frac{M^{-1}(q(t_0))D^T}{\sqrt{DM(q(t_0))D^T}} \in \mathbb{R}^{n \times 1}$ is the normal vector in the kinetic metric [Brogliato, 1999, chapter 6] and $D = [10 \dots 0] \in \mathbb{R}^{n \times 1}$. One gets from (34) and using for instance the Schur complement to calculate $M^{-1}(q(t_0))$ [Horn & Johnson, 1999, p.472]

$$\text{prox}_{M(q(t_0))}[M^{-1}(q(t_0))N_{\Phi}(q(t_0)); \dot{q}(t_0^-)] = \dot{q}_1(t_0^-) \begin{pmatrix} 1 \\ M_{22}^{-1}(q(t_0))M_{12}^T(q(t_0)) \end{pmatrix} \quad (35)$$

Therefore from (3) one gets

$$\begin{cases} \sigma_{\dot{q}_1}(t_k) = -(1 + e_n)\dot{q}_1(t_k^-) \\ \sigma_{\dot{q}_2}(t_k) = (1 + e_n)M_{22}^{-1}(q(t_k))M_{12}^T(q(t_k))\dot{q}_1(t_k^-) \end{cases} \quad (36)$$

From (36) and (33), after some manipulations we arrive at the following:

$$\begin{cases} \sigma_V(t_0) = \frac{e_n^2 - 1}{2}[M_{11}(q(t_0)) - M_{12}(q(t_0))M_{22}^{-1}(q(t_0))M_{12}^T(q(t_0))]\dot{q}_1^2(t_0^-) \\ \quad - \frac{1}{2}M_{11}(q(t_0))\dot{q}_{1d}^2(t_0^-) + M_{11}(q(t_0))\dot{q}_1(t_0^-)\dot{q}_{1d}(t_0^-) \\ \quad + \dot{q}_2(t_0^-)^T M_{21}(q(t_0))\dot{q}_{1d}(t_0^-) - \frac{1}{2}\gamma_1\dot{q}_{1d}^2(t_0^-) \end{cases} \quad (37)$$

It follows immediately from (37) that if $e_n = 0$ and $M_{21} = 0$ then

$$\sigma_V(t_0) = -\frac{1}{2}M_{11}(q(t_0))\dot{q}_1^2(t_0^-) - \frac{1}{2}\gamma_1\dot{q}_{1d}^2(t_0^-) \leq 0 \quad (38)$$

Hence strong stability is assured and the third item is proved.

(iv) If $M_{12} = 0$ and $0 \leq e_n < 1$, one has

$$\begin{aligned} V(t) = V_1(t) + V_2(t) &= \frac{1}{2}M_{11}(q(t_0))\dot{\tilde{q}}_1^2(t) + \frac{1}{2}\dot{\tilde{q}}_2(t)^T M_{22}(q(t_0))\dot{\tilde{q}}_2(t) \\ &+ \underbrace{\frac{1}{2}\gamma_1\tilde{q}_1^2(t)}_{V_1(t)} + \underbrace{\frac{1}{2}\gamma_1\tilde{q}_2(t)^T \tilde{q}_2(t)}_{V_2(t)} \end{aligned} \quad (39)$$

From (39), $V_2(t)$ and $V_1(t)$ are decoupled, then $V_2(t)$ is a smooth function and $\dot{V}_2(t) \leq 0$ for all t . Therefore $V_2(t_\infty) \leq V_2(\tau_0^k)$. Since $V_1(t_\infty) = 0 \leq V_1(\tau_0^k)$ one has:

$$V(t_\infty) \leq V(\tau_0^k) \quad (40)$$

Then item (iv) of claim 5 is proved. ■

4 A Weakly-Stable Scheme

It is of some interest to design a feedback control strategy whose closed-loop stability can be analyzed with claim 2. The control law used in this section has the same global structure than in Figs. 5-8. However the nonlinear controller block is based on the scheme presented in [Slotine & Li, 1988]. Let us propose the following:

$$T(q)u = \begin{cases} U_{nc} &= M(q)\ddot{q}_r + C(q, \dot{q})\dot{q}_r + g(q) - \gamma_1 s \\ U_t &= U_{nc} \quad \text{before the first impact} \\ U_t &= M(q)\ddot{q}_r + C(q, \dot{q})\dot{q}_r + g(q) - \gamma_1 \bar{s} \quad \text{after the first impact} \\ U_c &= U_{nc} - P_d + K_f(P_q - P_d) \end{cases} \quad (41)$$

where $s = \dot{q} + \gamma_2 \tilde{q}$, $\bar{s} = \dot{q} + \gamma_2 \bar{q}$, $\dot{q}_r = \dot{q}_d - \gamma_2 \tilde{q}$, $\gamma_2 > 0$ and $\gamma_1 > 0$ are two scalar gains, $K_f > 0$, $P_d = D^T \lambda_d$ is the desired contact force during permanently constraint motion.

Assumption 2 *The controller U_t in (41) assures that a sequence $\{t_k\}_{k \geq 0}$ of impact times exists, with $\lim_{k \rightarrow +\infty} t_k = t_\infty < +\infty$.*

Let us consider the following positive functions:

$$\begin{aligned} V_1(t, s) &= \frac{1}{2} s(t)^T M(q) s(t) \\ V_2(t, s) &= \frac{1}{2} s(t)^T M(q) s(t) + \gamma_2 \gamma_1 \tilde{q}(t)^T \tilde{q}(t) \end{aligned} \quad (42)$$

In case $\Phi = \mathbb{R}^n$, any of the two functions $V_1(\cdot)$ and $V_2(\cdot)$ can be used in order to prove the stability of the closed-loop system (15) (41) [Lozano *et al.*, 2000, §6.2.5] [Spong *et al.*, 1990]. In the case of interest here $\Phi \subset \mathbb{R}^n$, things complicate and as we shall see, both functions are needed for the stability analysis. In particular one has $\dot{V}_1(t) \leq 0$ and $\dot{V}_2(t) \leq 0$ along the closed-loop system as long as $T(q)u = U_{nc}$ in (41), see [Lozano *et al.*, 2000] [Slotine & Li, 1988]. It is noteworthy that claim 6 is proved with $V_2(\cdot)$, while claim 7 is based on $V_1(\cdot)$ and the choice of the closed-loop state vector $x(t) = s(t)$.

Claim 6 (upper-bounds) *Consider the closed-loop system (15) (41) on the time interval $[\tau_0^k, t_0]$, and with the particular choice of $q_{1d}^*(\cdot)$ given in (55) (56) (57) in appendix A. One has:*

$$\begin{aligned} (i) \quad |q_{1d}^*(t_0)| &\leq \sqrt{\frac{V_2(\tau_0^k)}{\gamma_2 \gamma_1}} \\ (ii) \quad |\dot{q}_{1d}^*(t_0^-)| &\leq K_0 V_2^{1/4}(\tau_0^k) \end{aligned}$$

where $K_0 \geq 0$. ■

Proof

The proof of claim 6 is provided in appendix A.

Claim 7 Let assumption 2 hold, $e_n \in (0, 1)$ and q_{1d}^* be defined as in (55)-(57). Consider the system defined by (15) in closed-loop with the controller in (41).

- (i) - If the controller $T(q)u$ in (41) assures that $\|\tilde{q}(\tau_0^k)\| < \epsilon$, $\epsilon > 0$ for all k over the cycles, then the system initialized on Ω_0 with $V_2(\tau_0^0) \leq 1$ satisfies the requirements of claim 2 and is therefore practically Ω -weakly stable with closed-loop state $x(\cdot) = s(\cdot)$.
- (ii) - If the controller $T(q)u$ in (41) assures that $\|\tilde{q}_2(t_{k+1})\| \leq \|\tilde{q}_2(t_k)\|$, for all t_k on $[t_0, t_\infty)$, then the system initialized on Ω_0 with $V_2(\tau_0^0) \leq 1$ satisfies the requirements of claim 2 and is therefore practically Ω -weakly stable with closed-loop state $x(\cdot) = [s(\cdot), \tilde{q}(\cdot)]$.

■

Notice that ϵ in (i) need not be small, it is however important that it does not depend on the cycle index in (5). Note also that $V_1(t) \leq V_2(t)$ for all $t \geq 0$ so that $V_1(\tau_0^0) \leq V_2(\tau_0^0) \leq 1$ in (i).

Proof

The proof of claim 7 is provided in appendix B.

Claim 8 Consider the closed-loop system (15) (41). The tracking errors satisfy $\|\tilde{q}(t)\| \leq 2R$ and $\|\dot{\tilde{q}}(t)\| \leq (1 + 2\gamma)R$ for all $t \in \Omega$, and $\|s(t)\| \leq R$ for all $t \in \Omega$, with $R = \left(\frac{2}{\lambda_{\min}(M(q))} e^{-\gamma(t_f^k - t_\infty)} (1 + K + \epsilon')\right)^{\frac{1}{2}}$.

■

Proof

From the definition of $s(t)$ one has $\tilde{q} = \frac{1}{p+1}s$ where $p \in \mathbb{C}$ is the Laplace variable. Then on $[t_f^k, t)$ with $t \in \Omega$, $\tilde{q}(t)$ is the response of a linear filter with input $s(\cdot)$. One obtains:

$$\tilde{q}(t) = e^{-(t-t_f^k)} s(t_f^k) + \int_{(t_f^k, t)} e^{-(t-\tau)} s(\tau) d\tau \quad (43)$$

Equality (43) implies the following inequality:

$$\|\tilde{q}(t)\| \leq \|s(t_f^k)\| + e^{-t}(t - t_f^k)\|s\|_\infty \quad (44)$$

where $\|x\|_\infty = \sup_{t \geq t_f^k} |x(t)|$ is the \mathcal{L}_∞ norm. From claim 7, one has $\|s\| \leq R$ so (44) becomes:

$$\begin{aligned} \|\tilde{q}(t)\| &\leq [1 + e^{-t}(t - t_f^k)] R \\ &\leq 2R \end{aligned} \quad (45)$$

From the definition of $s(t)$ one has $\dot{\tilde{q}}(t) = s(t) - \gamma_2 \tilde{q}(t)$ then

$$\|\dot{\tilde{q}}(t)\| \leq \|s(t)\| + \gamma_2 \|\tilde{q}(t)\| \quad (46)$$

By inserting (45) in (46), and using the fact that $\|s\| \leq R$, one obtains

$$\|\dot{\tilde{q}}(t)\| \leq [1 + 2\gamma_2]R \quad (47)$$

■

Claim 9 (plastic impact) *Let assumption 2 hold, $e_n = 0$ and q_{1d}^* be defined as in (55)-(57). The system defined by (15) in closed-loop with the controller in (41) initialized on Ω_0 with $V_2(\tau_0^0) \leq 1$ satisfies the requirements of claim 2 and is therefore practically Ω -weakly stable with closed-loop state $x(\cdot) = [s(\cdot), \tilde{q}(\cdot)]$.*

■

Proof

As $e_n = 0$, there is only one impact per phase I_k , and then the item (b) of claim 2 is useless. Items (a) and (d) are proved in the proof of claim 7(ii).

Then the system (15) with the controller (41) satisfies all the requirements of claim 2 with $\epsilon \neq 0$. Consequently it is practically Ω -weakly stable with $x(\cdot) = [s(\cdot), \tilde{q}(\cdot)]$.

5 Simulation Examples

The control scheme in (18) is tested in simulation on a 2-link planar manipulator for the simplest case of a scalar constraint. The constraint surface corresponds to the ground ($y = 0$). The natural generalized coordinates so that the dynamics fits with (15), with $m = 1$, are the work-space coordinates (x, y) . We take:

$$q = \begin{bmatrix} q_1 \\ q_2 \end{bmatrix} = \begin{bmatrix} y \\ x \end{bmatrix}, \quad y \geq 0$$

5.1 Asymptotic convergence

Figure 10 shows the evolution of $q_1(t)$ and $q_2(t)$ during cyclic tasks as in (5). On the graph of q_1 , the asymptotic convergence of the controller is exhibited as the value of $\alpha V(\tau_0^k)$ decreases exponentially. The graph of q_2 shows the coupling between q_1 and q_2 . At each impact time a jump in \dot{q}_2 occurs. The periodic step on q_{2d} corresponds to the transition phase during which q_{2d} needs to be frozen.

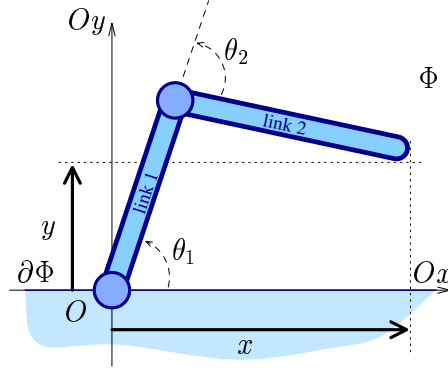

Figure 9: 2-link planar manipulator

5.2 Robustness

In this subsection, we study the robustness of the controller with respect to the uncertainty on the constraint position. The robustness of closed-loop systems is a crucial step towards their implementation. The work that is performed here is essentially numerical, but may provide useful informations on the controller robustness and its performance in practice. The location of the constraint surface is not known accurately. As seen on Fig. 11, two situations may be considered.

- If $c < 0$, the estimated position of the constraint is lower than the real position. In this case the desired trajectories decrease toward $q_{1d}(\tau_1^k) = -\alpha V(\tau_k^0) - |c|$ instead of $q_{1d}(\tau_1^k) = -\alpha V(\tau_k^0)$. The error c can be incorporated in the term $-\alpha V(\tau_k^0)$ and the stability of the transition phase is not changed. During the constraint phase the controller is :

$$U_c = U_{nc}^{ideal} - (P_d + \gamma_1 \begin{bmatrix} |c| \\ 0 \end{bmatrix}) + K_f(P_q - P_d)$$

The error term $\gamma_1|c|$ is added to the desired force P_d and contributes to keep the contact with the surface during the constrained phase.

The system remains stable but it loses its asymptotic stability : If the tracking is perfect $V(\tau_k^0) = 0$ and $q_{1d}^* = -|c|$, so that the system does not approach the surface tangentially and rebounds occur. Due to item **c**) in Sec. 1.5, asymptotic stability is not preserved. An example is depicted on Fig. 12.

- If $c > 0$, the estimated position of the constraint is above the real position. If the tracking is perfect $V(\tau_k^0) = 0$, the desired trajectory decreases toward $q_{1d} = c$ and the system never reaches the constraint. There is no convergence (see Fig. 13).

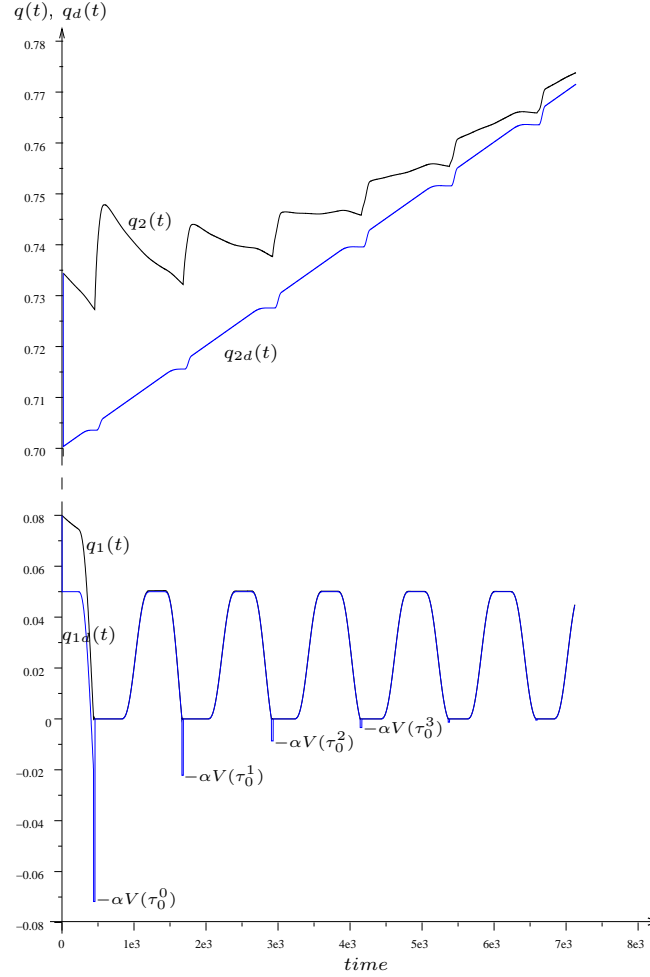
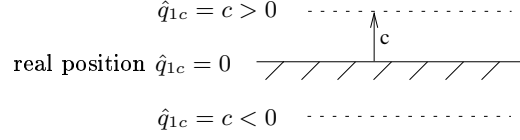
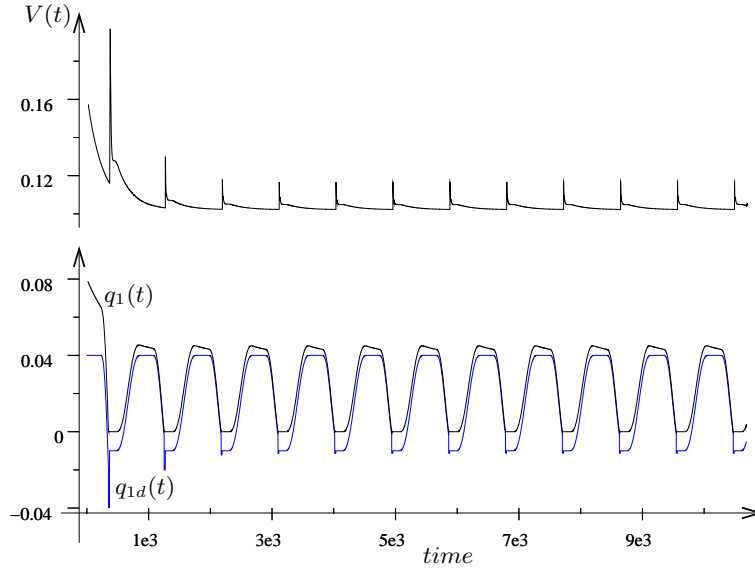

Figure 10: Asymptotic Convergence

This problem can be solved by monitoring the time of stabilization. If there is no stabilization after an estimated time \hat{t}_∞ , the estimated position of the constraint is refreshed as $\hat{q}_{1c}^{new} = \hat{q}_{1c}^{old} - \epsilon$. After a finite number of iterations, one gets $\hat{q}_{1c} < 0$. The system is in the previous situation $c < 0$ and the stability is preserved. Figure 14 shows an example of self-adjustment of the estimated position of the constraint.

Figure 11: estimated position \hat{q}_{1c} Figure 12: Stability if $c < 0$

When tracking is not perfect and $\alpha V(\tau_k^0) > c$, the transition phase is able to stabilize the system on the surface $\partial\Phi$. But during the constraint phase, the control law is:

$$U_c = U_{nc}^{ideal} - (P_d - \gamma_1 \begin{bmatrix} c \\ 0 \end{bmatrix}) + K_f(P_q - P_d)$$

P_d must be chosen large enough compared to $\gamma_1 c$ to be sure that the system keeps the contact with the surface during the whole constraint phase.

6 Mutiple Impacts

This section extends the previous controller framework to the case of multiple impact.

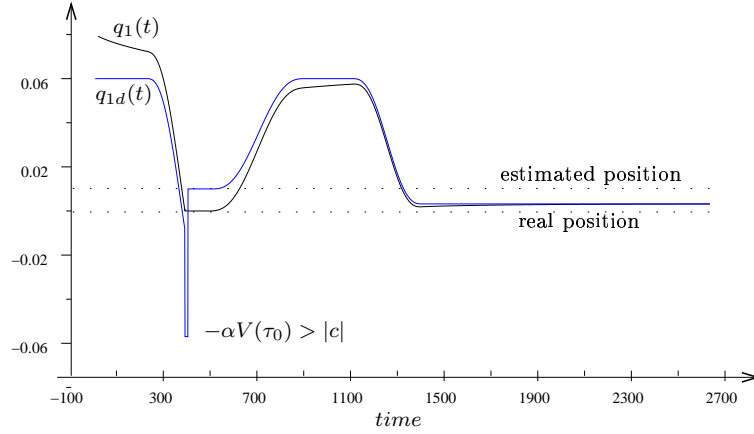
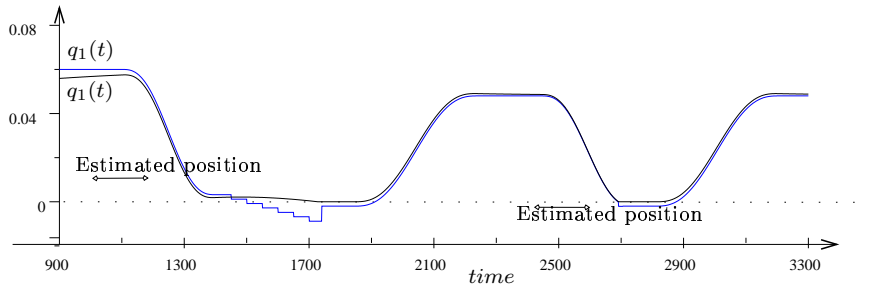
Figure 13: Non-convergence if $c > 0$ Figure 14: Auto-adjustment of \hat{q}_{1c}

Definition 5 (Multiple impact) *A multiple impact is an impact into a singularity as in definition 1. If the singularity has codimension α , the multiple impact is named an α -impact. We also denote the singularity as Σ^α .*

The difficulty created by stabilization at singularities of $\partial\Phi$, is that the way the system attains the singularity, may vary: the system may hit the singularity directly, or hit one or several surfaces Σ_i (through a finite or infinite number of impacts) before attaining the singularity, as depicted on Fig. 15. Let us define θ_{kin}^{ij} as the kinetic angle between two surfaces Σ_i and Σ_j , i.e. the angle in the kinetic metric defined as $x^T M(q)y$ for n -vectors x and y . In the following we shall restrict ourselves to $m = 2$ (two constraints) and $\theta_{kin}^{12} \leq \frac{\pi}{2}$. The reasons for this choice are the following:

- Let us further assume that $e_n = 0$ in (2). As shown in [Paoli, 2002], the conditions $\theta_{kin}^{12} \leq \frac{\pi}{2}$ and $e_n = 0$ imply that trajectories (i.e. solutions of the closed-loop system) are continuous with respect to the initial conditions.
- Let us take $e_n \in [0, 1]$ and assume that the system performs a constrained motion phase on Σ_1 before hitting $\partial\Phi$ at q . Then $\dot{q}(t_k^-) \in N_{\Phi}(q)$ so that from (3) $\dot{q}(t_k^+) = -e_n \dot{q}(t_k^-)$. This means that after the shock the velocity is again tangent to Σ_1 , and the state at t_k^+ is consistent with the constraint $q_1^+ = 0$.

The goal is to stabilize the system on the singularity $\Sigma^2 = \Sigma_1 \cap \Sigma_2$ during the transition phase. Several cases are examined next, and the controller in (18) is used.

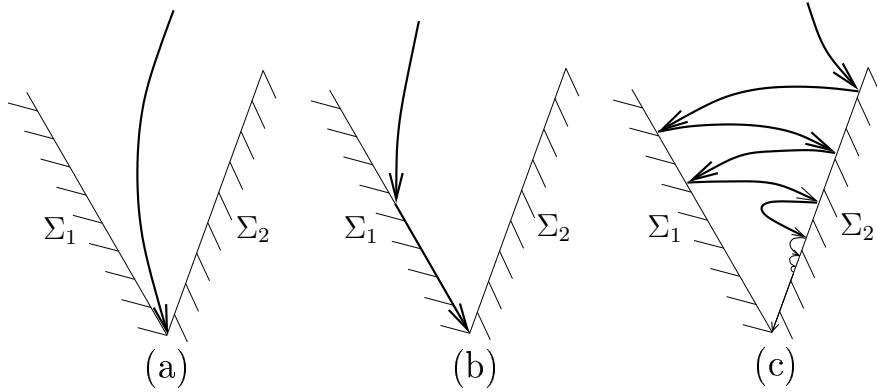

Figure 15: Multiple impact (2-impact)

6.1 Stabilisation with a 2-impact

In this case, the two surfaces are reached simultaneously. This means that at each impact time t_k , one has $q_1^1(t_k) = q_1^2(t_k) = 0$, and the closed-loop analysis made in [Brogliato *et al.*, 2000] for a 1-impact can be adapted immediately to such a 2-impact. If $e_n = 0$ the continuity of solutions with respect to initial data allows us to further conclude that this strategy possesses some robustness properties. Indeed even if the system does not strike right at the singularity Σ^2 , but in a neighborhood of it, then stabilisation still occurs with the same controller as depicted on Fig. 15 (b). If $e_n > 0$ then such a strategy does not seem amenable in practice due to its lack of robustness (because trajectories impacting in a neighborhood of Σ^2 may drastically differ from those impacting on Σ^2).

6.2 Impact on one surface before a 2-impact

In this case the transition phase is decomposed into two main steps: a first subphase during which the system is stabilized on Σ_1 (without impact on Σ_2). And a second subphase during which the system is stabilized on Σ^2 . The property in the second item just above, assures that the system remains on Σ_1 during this second subphase. The proof of stability for the first phase is similar to the 1-impact case if we take $q_1 = [q_1^1]$ and $q_2 = \begin{bmatrix} q_1^2 \\ q_2 \end{bmatrix}$. During the second phase, the system is in a constraint motion, and the closed-loop dynamics is:

$$M(q)\ddot{q} = -C(q, \dot{q})\dot{q} - \gamma_1\bar{q} - \gamma_2\dot{q} + (1 + K_{f1})(\lambda_{q_1} - \lambda_{d_1})\nabla_q q_1^1 \quad (48)$$

The system is stabilized on Σ^2 using the signal $q_{1d}^* = \begin{bmatrix} 0 \\ q_{1d}^{2*} \end{bmatrix}$, where q_{1d}^{2*} has the same form as q_{1d}^{1*} in the previous phase and decreases towards $-\alpha_2 V(\tau_0^k)$.

With the same proof as before, we need to show that the inequality:

$$V(x(t_{k+1}^-), t_{k+1}^-) - V(x(t_k^+), t_k^+) \leq 0 \quad (49)$$

holds. One obtains:

$$\begin{aligned} & V(x(t_{k+1}^-), t_{k+1}^-) - V(x(t_k^+), t_k^+) \\ &= \int_{(t_k, t_{k+1})} \dot{V}(t) dt \\ &= \int_{(t_k, t_{k+1})} \dot{q}^T M \ddot{q} + \dot{q}^T \frac{\dot{M}}{2} \dot{q} + \gamma_1 \tilde{q}^T \tilde{q} dt \\ &= \int_{(t_k, t_{k+1})} \left(\dot{q}^T [-C\dot{q} - \gamma_1\bar{q} - \gamma_2\dot{q} + (1 + k_{f1})(\lambda_{q_1} - \lambda_{d_1})\nabla_q q_1^1] \right. \\ &\quad \left. + \dot{q}^T \frac{\dot{M}}{2} \dot{q} + \gamma_1 \tilde{q}^T \tilde{q} \right) dt \\ &= \int_{(t_k, t_{k+1})} -\gamma_2 \dot{q}^T \dot{q} dt + \gamma_1 \int_{(t_k, t_{k+1})} \dot{q}_1^T q_{1d}^* dt \\ &+ \int_{(t_k, t_{k+1})} \dot{q}^T (1 + k_{f1})(\lambda_{q_1} - \lambda_{d_1}) \nabla_q q_1^1 dt \\ &= \int_{(t_k, t_{k+1})} -\gamma_2 \dot{q}^T \dot{q} dt \leq 0 \end{aligned}$$

The last but one equality is deduced from the preceding one using the property that the matrix $2C(q, \dot{q}) - \dot{M}(q, \dot{q})$ is skew-symmetric [Lozano *et al.*, 2000], and $\dot{q}^T \tilde{q} - \dot{q}^T \bar{q} = \dot{q}^T q_{1d}^*$. The last inequality is deduced from the preceding equality since $\dot{q}^T (1 + k_{f1})(\lambda_{q_1} - \lambda_{d_1}) \nabla_q q_1^1 =$

0 and $[q_1^T q_{1d}^*]_{t_k}^{t_{k+1}} = 0$ since $q_1(t_k) = 0$ during the 2-impact. A proof similar to the 1-impact case allows one to conclude on asymptotic stability of this 2-impact tracking problem. However we have supposed that there is no impact on the second surface during the first transition subphase. This may not always be realizable in practice, and may also be seen as a lack of robustness for stabilisation in a neighborhood of singularities.

6.3 Case (c) : General case

In this case the system can collide indifferently the two surfaces. There are several 1-impacts on both surfaces before the 2-impact occurs. In this situation we do not have $q_1(t_k) = 0$ for all impact (this true only during the 2-impact). The weak stability of the transition phase can be obtained by studying the variation of $V(q(t), \dot{q}(t), t)$ between two impacts on the same surface (Σ_1 or Σ_2).

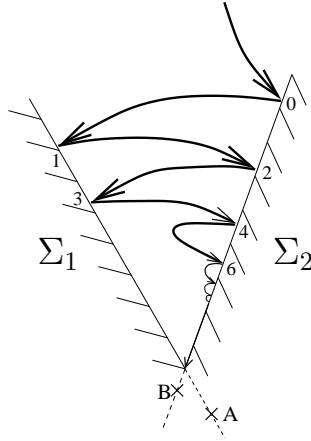

Figure 16: General case

Let us choose the following notations: t_{2k} is for impacts on Σ_2 , and t_{2k+1} is for impacts on Σ_1 . Let us also choose $q_{1d}^* = \begin{bmatrix} q_{1d}^{1*} \\ q_{1d}^{2*} \end{bmatrix} = \begin{bmatrix} -\alpha_1 V(x(\tau_0^k), \tau_0^k) \\ -\alpha_2 V(x(\tau_0^k), \tau_0^k) \end{bmatrix}$. Let us now calculate the following variation:

$$\begin{aligned}
& V(t_{2(k+1)}^-) - V(t_{2k}^+) \\
&= \int_{(t_{2k}, t_{2k+1})} \dot{V}(t) dt + \sigma_V(t_{2k+1}) + \int_{(t_{2k+1}, t_{2(k+1)})} \dot{V}(t) dt \\
&= \sigma_V(t_{2k+1}) - \gamma_2 \int_{(t_{2k}, t_{2k+1})} \dot{q}^T \dot{q} dt - \gamma_2 \int_{(t_{2k+1}, t_{2(k+1)})} \dot{q}^T \dot{q} dt \\
&+ \gamma_1 q_{1d}^{*T} [q_1]_{t_{2k}}^{t_{2k+1}} + \gamma_1 q_{1d}^{*T} [q_1]_{t_{2k+1}}^{t_{2(k+1)}} \tag{50} \\
&= \Delta + \gamma_1 q_{1d}^{*T} (q_1(t_{2(k+1)}) - q_1(t_{2k})) \tag{51} \\
&= \Delta + \gamma_1 q_{1d}^{1*T} (q_1^1(t_{2(k+1)}) - q_1^1(t_{2k})) \tag{52}
\end{aligned}$$

where Δ is the sum of all negative terms in (50). Equality (51) is deduced from (50) since $q_1^2(t_{2k}) = 0$ for all k . With $\alpha_1 = 0$, we have $q_{1d}^{1*} = 0$ and then :

$$V(t_{2(k+1)}^-) - V(t_{2k}^+) < 0$$

The strategy is to take $\alpha_1 = 0$ (target A, see Fig. 16) at the beginning of the transition phase to stabilize the system on Σ_2 , and to switch to $\alpha_2 = 0$, $\alpha_1 > 0$ (target B, see Fig. 16) when the system is on Σ_2 (or to switch to the previous case).

7 Conclusion

This paper deals with the tracking control of fully actuated Lagrangian systems subject to frictionless unilateral constraints. These dynamical systems are named *complementarity systems* because they involve complementarity conditions. They are *nonsmooth* because the velocity may possess discontinuities (at impact times), so that the acceleration and the contact force are measures. They may be seen as a complex mixture of ordinary differential equations, differential-algebraic equations, and measure differential equations. The extension of the tracking control of unconstrained (or persistently constrained) Lagrangian systems, towards complementarity Lagrangian systems, is not trivial. The aim of this paper is to study the design of a feedback controller for these specific nonsmooth systems, supposed to perform a general cyclic impacting task. First the stability framework dedicated to study these systems is recalled, and some definitions and claims are given. Then we focus on the condition of existence of closed-loop trajectories (usually called desired trajectories in unconstrained motion tracking control) which assure the asymptotic stability in closed-loop, i.e. the asymptotic convergence of the generalized coordinates towards some closed-loop invariant trajectory. The second part of this paper is devoted to numerically study an example : a 2-link planar manipulator subject to a single unilateral constraint. This example allows us to exhibit some results on the robustness of this control framework in term of uncertainty of the constraint surface position. The effect of measurement noise is also studied. It is shown that the proposed scheme possesses some interesting robustness

properties. The last part of this paper is devoted to the case of so-called multiple impacts (an accurate definition is provided). Some specific difficulties related to the constraint boundary geometry, are highlighted, and some possible manners to extend the single constraint case are indicated.

References

- Ballard, P. [2000] “The dynamics of discrete mechanical systems with perfect unilateral constraints,” *Arch. Rational Mech. Anal.*, **154**(3), 199–274.
- Ballard, P. [2001] “Formulation and well-posedness of the dynamics of rigid-body systems with perfect unilateral constraints,” *Phil. Trans. Royal Soc. Lond. A*, **359**, 2327–2346.
- Brogliato, B. [1999]. *Nonsmooth Mechanics*. Springer CCES, London, 2nd edn., erratum and addenda available at <http://www.inrialpes.fr/bipop/people/brogliato/erratum.ps>.
- Brogliato, B. [2003a] “Absolute stability and the Lagrange-Dirichlet theorem with monotone multivalued mappings,” *Systems and Control Letters*, **51**(5), 343–353.
- Brogliato, B. [2003b] “Some perspectives on the analysis and control of complementarity systems,” *IEEE Transactions on Automatic Control*, **48**(6), 918–935.
- Brogliato, B., Niculescu, S. & Orhant, P. [1997] “On the control of finite dimensional mechanical systems with unilateral constraints,” *IEEE Transactions on Automatic Control*, **42**(2), 200–215.
- Brogliato, B., Niculescu, S. & Monteiro-Marques, M. [2000] “On tracking control of a class of complementary-slackness mechanical systems,” *Systems and Control Letters*, **39**(4), 255–266.
- Brogliato, B., ten Dam, A., Paoli, L., Génot, F. & Abadie, M. [2002] “Numerical simulation of finite dimensional multibody nonsmooth mechanical systems,” *ASME Applied Mechanics Reviews*, **55**(2), 107–150.
- Clarke, F. [1990]. *Optimization and Nonsmooth Analysis*. SIAM Classics in Applied Mathematics, 5.
- Frémond, M. [2002]. *Non-Smooth Thermomechanics*. Berlin, London: Springer.
- Glocker, C. [2001]. *Set Valued Force Laws: Dynamics of Non-Smooth Systems*, vol. 1 of *Lecture Notes in Applied Mechanics*. Springer.
- Glocker, C. [2002] “The geometry of newtonian impacts with global dissipation index for moving sets,” in C. Baniotopoulos, ed., *Proc. of the Int. Conf. on Nonsmooth/Nonconvex Mechanics*, 283–290, Thessaloniki.

- Goeleven, D., Motreanu, D. & Motreanu, V. [2003] "On the stability of stationary solutions of first order parabolic variational inequalities," *Advances in Nonlinear variational Inequalities*, **6**, 1–30.
- Heemels, W. & Brogliato, B. [2003] "The complementarity class of hybrid dynamical systems," *European Journal of Control, special issue*.
- Hiriart-Urruty, J.B. & Lemaréchal, C. [1996]. *Convex Analysis and Minimization Algorithms*. Springer.
- Horn, R. & Johnson, C. [1999]. *Matrix Analysis*. Cambridge University Press.
- Huang, H. & McClamroch, N. [1988] "Time optimal control for a robotic contour following problem," *IEEE J. Robotics and Automation*, **4**, 140–149.
- Komanduri, R. [1993] "Machining and grinding - a historical review of classical papers," *ASME Applied Mechanics Review*, **46**(3), 80–132.
- Lozano, R., Brogliato, B., Egeland, O. & Maschke, B. [2000]. *Dissipative Systems Analysis and Control. Theory and Applications*. Springer CCES, London.
- Mabrouk, M. [1998] "A unified variational model for the dynamics of perfect unilateral constraints," *European Journal of Mechanics A/Solids*, **17**(5), 819–842.
- McClamroch, N. & Wang, D. [1988] "Feedback stabilization and tracking of constrained robots," *IEEE Transactions on Automatic Control*, **33**(5), 419–426.
- Moreau, J. [1968] "La notion de sur-potentiel et les liaisons unilatérales en élastostatique," *C.R. Acad. Sc. Paris*, **271A**, 954–957.
- Moreau, J. [1983] "Liaisons unilatérales sans frottement et chocs inélastiques," *C.R. Acad. Sc. Paris*, **296**, 1473–1476.
- Moreau, J. [1988] "Unilateral contact and dry friction in finite freedom dynamics," in *Nonsmooth Mechanics and Applications*, CISM Courses and Lectures no 302, Springer-Verlag.
- Moreau, J. [2003] "An introduction to unilateral dynamics," in M. Frémond & F. Macceri, eds., *Novel Approaches in Civil Engineering*, 1–45, Springer Verlag.
- Murty, K.G. [1997]. *Linear Complementarity, Linear and Nonlinear Programming*. Internet Edition, <http://www-personal.engin.umich.edu/~murty/book/LCPbook/>.
- Paden, B. & Panja, R. [1988] "Globally asymptotically stable pd+ controller for robot manipulators," *Int. J. Control*, **47**(6), 1697–1712.
- Paoli, L. [2002] "A numerical scheme for impact problems with inelastic shocks: a convergence result in the multi-constraint case," in C. Baniotopoulos, ed., *Proc. of the Int. Conf. on Nonsmooth/Nonconvex Mechanics*, 269–274, Thessaloniki, Greece.

- Ramachandran, N., Pande, S. & Ramakrishnan, N. [1994] "The role of deburring in manufacturing: A state-of-the-art survey," *Journal of Materials Processing Technology*, **44**, 1–13.
- Schatzman, M. [1998] "Uniqueness and continuous dependence on data for one-dimensional impact problem," *Math. Comp. Modelling*, **28**(4-8), 1–18.
- Shia, C.Y., Stango, R. & Heinrich, S. [1998] "Analysis of contact mechanics for a circular filamentary brush/workpart system," *ASME J. of Manufacturing Science and Engineering*, **120**(4), 715–721.
- Slotine, J.J. & Li, W. [1988] "Adaptive manipulator control: a case study," *IEEE Transactions on Automatic Control*, **33**(11), 995–1003.
- Spong, M., Ortega, R. & Kelly, R. [1990] "Adaptive manipulator control: A case study," *IEEE Transactions on Automatic Control*, **35**(6), 761–762.
- Studny, D., Rittel, D. & Zussman, E. [1999] "Impact fracture of screws for disassembly," *ASME Journal of Manufacturing Science and Engineering*, **121**(1), 118–126.
- van der Schaft, A. & Schumacher, J.M. [2000]. *An Introduction to Hybrid Dynamical Systems*. No. 251 in Lecture Notes in Control and Information Sciences, Springer, London.
- Yoshikawa, T. [1987] "Dynamic hybrid position/force control of robot manipulators description of hand constraints and calculation of joint driving force," *IEEE Trans. on Robotics and Automation*, **3**(5), 386–392.

A Proof of Claim 6

i) On $[\tau_0^k, t_0)$, one has $\dot{V}_2(t) \leq 0$, so that $V_2(t_0^-) \leq V_2(\tau_0^k)$. Therefore from (42)

$$V_2(\tau_0^k) \geq V_2(t_0^-) \geq \gamma_2 \gamma_1 \tilde{q}(t_0^-)^T \tilde{q}(t_0^-) \geq \gamma_2 \gamma_1 \tilde{q}_1^2(t_0^-) \quad (53)$$

so that

$$\sqrt{\frac{V_2(\tau_0^k)}{\gamma_2 \gamma_1}} \geq |q_1(t_0) - q_{1d}^*(t_0^-)| = |q_{1d}^*(t_0^-)| \quad (54)$$

because $q_1(t_0) = 0$. The desired trajectory $q_{1d}^*(\cdot)$ is chosen as a decreasing function, and from inequation (54) we have $t_{min} \leq t_0 \leq t_{max}$, where $q_{1d}^*(t_{min}) = \sqrt{\frac{V_2(\tau_0^k)}{\gamma_2 \gamma_1}}$ and $q_{1d}^*(t_{max}) = -\sqrt{\frac{V_2(\tau_0^k)}{\gamma_2 \gamma_1}}$ (see Fig. 17).

Remark 7 From the value of t_{max} , it follows that if $\alpha V_1(\tau_0^k) > \sqrt{\frac{V_2(\tau_0^k)}{\gamma_2 \gamma_1}}$, then $t_0 \leq \tau_1^k$ on the cycle k . ■

ii) The signal $q_{1d}^*(t)$ is a function decreasing toward $-\alpha V_1(\tau_0^k)$. Let us use a degree 3 polynomial with limit conditions ($t_{ini} = \tau_0^k$ and $t_{end} = \tau_1^k$). After some manipulations we will exhibit an upper-bound of $q_{1d}^*(t)$ on $[t_{min}, t_{max}]$. Since $t_0 \in [t_{min}, t_{max}]$ then:

$$\begin{aligned} q_{1d}^*(t) &= a_3 t^3 + a_2 t^2 + a_1 t + a_0 \\ \dot{q}_{1d}^*(t) &= 3a_3 t^2 + 2a_2 t + a_1 \\ \text{at } t_{ini} = \tau_0^k &: q_{1d}^*(t_{ini}) = q_{1d}(\tau_0^k) \quad \text{and } \dot{q}_{1d}^*(t_{ini}) = 0 \\ \text{at } t_{end} = \tau_1^k &: q_{1d}^*(t_{end}) = -\alpha V_1(\tau_0^k) \quad \text{and } \dot{q}_{1d}^*(t_{end}) = 0 \end{aligned} \quad (55)$$

To compute $\max_{t \in [t_{min}, t_{max}]} |q_{1d}^*(t)|$, let us make a time scaling transformation $t' = t'(t)$, such that $t'(\tau_0^k) = 0$ and $t'(\tau_1^k) = 1$, as $t'(t) = \frac{t - \tau_0^k}{\tau_1^k - \tau_0^k}$. We obtain:

$$\begin{aligned} a_3 &= 2[q_{1d}(\tau_0^k) + \alpha V_1(\tau_0^k)] \\ a_2 &= -3[q_{1d}(\tau_0^k) + \alpha V_1(\tau_0^k)] \\ a_1 &= 0 \\ a_0 &= q_{1d}^*(\tau_0^k) \end{aligned} \quad (56)$$

and the signal $q_{1d}^*(t)$ is :

$$\begin{aligned} q_{1d}^*(t') &= [q_{1d}^*(\tau_0^k) + \alpha V_1(\tau_0^k)](2t'^3 - 3t'^2) + q_{1d}^*(\tau_0^k) \\ \dot{q}_{1d}^*(t') &= -6[q_{1d}^*(\tau_0^k) + \alpha V_1(\tau_0^k)](1 - t')t' \end{aligned} \quad (57)$$

From (57), we see that $q_{1d}^*(t')$ is decreasing on $t' \in [0, 1]$. Consequently

$$q_{1d}^*(t_0) \leq q_{1d}^*(t'_{min}) \leq \sqrt{\frac{V_2(\tau_0^k)}{\gamma_2 \gamma_1}} \quad (58)$$

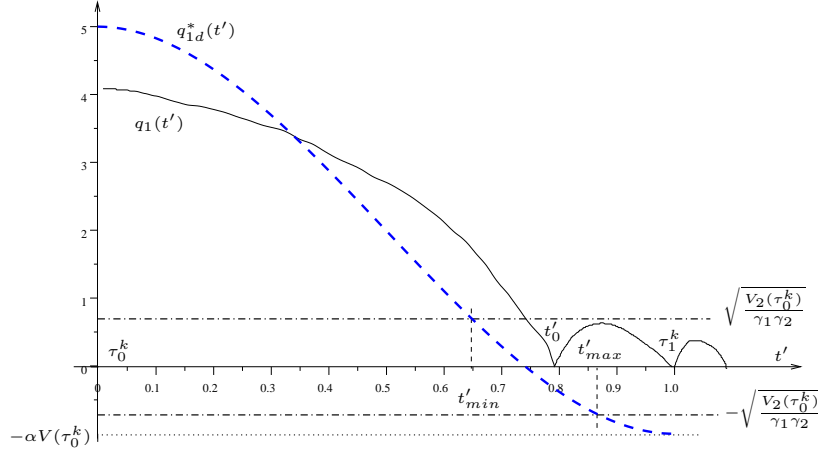
Figure 17: $q_{1d}^*(t)$.

By inserting (57) in (58), one obtains:

$$[q_{1d}^*(\tau_0^k) + \alpha V_1(\tau_0^k)](2t_0'^3 - 3t_0'^2) + q_{1d}^*(\tau_0^k) \leq \sqrt{\frac{V_2(\tau_0^k)}{\gamma_2 \gamma_1}} \quad (59)$$

Then,

$$t_0'^2(3 - 2t_0') \geq \frac{q_{1d}^*(\tau_0^k) - \sqrt{\frac{V_2(\tau_0^k)}{\gamma_2 \gamma_1}}}{q_{1d}^*(\tau_0^k) + \alpha V_1(\tau_0^k)} \quad (60)$$

For $t \geq 0$, one has $t(2-t) \geq t^2(3-2t)$, therefore:

$$t_0'(2 - t_0') \geq \frac{q_{1d}^*(\tau_0^k) - \sqrt{\frac{V_2(\tau_0^k)}{\gamma_2 \gamma_1}}}{q_{1d}^*(\tau_0^k) + \alpha V_1(\tau_0^k)} \quad (61)$$

The root of $t(2-t) = a$ is $t = 1 - \sqrt{1-a}$, from which it follows that:

$$\begin{aligned} t_0' &\geq 1 - \sqrt{1 - \frac{q_{1d}^*(\tau_0^k) - \sqrt{\frac{V_2(\tau_0^k)}{\gamma_2 \gamma_1}}}{q_{1d}^*(\tau_0^k) + \alpha V_1(\tau_0^k)}} \\ &\geq 1 - \sqrt{\frac{\alpha V_1(\tau_0^k) + \sqrt{\frac{V_2(\tau_0^k)}{\gamma_2 \gamma_1}}}{\alpha V_1(\tau_0^k) + q_{1d}^*(\tau_0^k)}} = t'_{min} \end{aligned} \quad (62)$$

On $[t_{min}, t_{max}]$, one has $|\dot{q}_{1d}^*(t')| \leq |\dot{q}_{1d}^*(t'_{min})|$. Thus:

$$\begin{aligned} |\dot{q}_{1d}^*(t'_0)| &\leq -6(q_{1d}^*(\tau_0^k) + \alpha V_1(\tau_0^k))(1 - t'_{min})t'_{min} \\ &\leq 6(q_{1d}^*(\tau_0^k) + \alpha V_1(\tau_0^k))\sqrt{\frac{\alpha V_1(\tau_0^k) + \sqrt{\frac{V_2(\tau_0^k)}{\gamma_2 \gamma_1}}}{\alpha V_1(\tau_0^k) + q_{1d}^*(\tau_0^k)}} \\ &\leq 6\sqrt{(q_{1d}^*(\tau_0^k) + \alpha V_1(\tau_0^k))(\alpha V_1(\tau_0^k) + \sqrt{\frac{V_2(\tau_0^k)}{\gamma_2 \gamma_1}})} \end{aligned} \quad (63)$$

Now we change back the time variable t' to t .

$$|\dot{q}_{1d}^*(t_0)| \leq \frac{6}{\tau_1^k - \tau_0^k} \sqrt{(q_{1d}^*(\tau_0^k) + \alpha V_1(\tau_0^k))(\alpha V_1(\tau_0^k) + \sqrt{\frac{V_2(\tau_0^k)}{\gamma_2 \gamma_1}})} \quad (64)$$

From (42) one has $V_2(t) \geq V_1(t)$. Thus equation (64) becomes:

$$|\dot{q}_{1d}^*(t_0)| \leq \frac{6}{\tau_1^k - \tau_0^k} \sqrt{(q_{1d}^*(\tau_0^k) + \alpha V_2(\tau_0^k))(\alpha V_2(\tau_0^k) + \sqrt{\frac{V_2(\tau_0^k)}{\gamma_2 \gamma_1}})} \quad (65)$$

Let us define the parameter:

$$K_0 = \frac{6}{\tau_1^k - \tau_0^k} \sqrt{\alpha q_{1d}^*(\tau_0^k) + q_{1d}^*(\tau_0^k)} \sqrt{\frac{1}{\gamma_1 \gamma_2} + \alpha^2 + \alpha \sqrt{\frac{1}{\gamma_2 \gamma_1}}} \quad (66)$$

If the system is initialized with $V_2(\tau_0^0) \leq 1$, then $V_2^{1/4} \geq V_2^{1/2} \geq V_2$ and inequality (65) becomes:

$$|\dot{q}_{1d}^*(t_0^-)| \leq K_0 V_2^{1/4}(\tau_0^k) \quad (67)$$

Then item (ii) of claim 6 is proved. ■

B Proof of Claim 7

(i) **Proof of the first result of claim 7:** Let us show that conditions (a) (b) and (d) in claim 2 are satisfied.

(a) Outside phase I_k it can be computed that $\dot{V}_1(t) = -\gamma_1 s(t)^T s(t)$ [Slotine & Li, 1988], then from (42) one has:

$$\|s(t)\|^2 \geq \frac{2}{\lambda_{max}(M(q))} V_1(t) \quad (68)$$

where $\lambda_{min}(\cdot)$ and $\lambda_{max}(\cdot)$ denote the minimum and maximum eigenvalues, respectively. It follows that:

$$\dot{V}_1(t) \leq -\frac{2\gamma_1}{\lambda_{max}(M(q))} V_1(t) \quad (69)$$

Therefore condition (a) of claim 2 is satisfied with $\gamma = \frac{2\gamma_1}{\lambda_{max}(M(q))}$.

(b) After the first impact the closed-loop equation of the system defined by (41) and (15) is:

$$M(q)\dot{s}(t) + Cs(t) + \gamma_1 \bar{s}(t) = 0 \quad (70)$$

Let us calculate $\dot{V}_1(t)$ along trajectories of (70):

$$\dot{V}_1(t) = \frac{1}{2} s(t)^T \dot{M}(t) s(t) + s(t)^T M(q) \dot{s}(t) \quad (71)$$

where $\dot{M}(t) = \frac{d}{dt}[M(q(t))]$. By introducing (70) in (71) and using the fact that $\dot{M}(t) - 2C(q, \dot{q})$ is a skew-symmetric matrix [Lozano *et al.*, 2000, lemma 5.4] one obtains:

$$\dot{V}_1(t) = -\gamma_1 s(t)^T \bar{s}(t) \quad (72)$$

After the first impact q_d^* is constant, \tilde{q} and \bar{q} are defined from (19) as $\tilde{q}(t) = \begin{pmatrix} q_1(t) \\ q_2(t) - q_{2d}^* \end{pmatrix}$

and $\bar{q}(t) = \begin{pmatrix} q_1(t) - q_{1d}^* \\ q_2(t) - q_{2d}^* \end{pmatrix}$. Then $\dot{\tilde{q}}(t) = \dot{\bar{q}}(t)$ and one has:

$$\begin{aligned} \bar{s}(t) &= \dot{\tilde{q}}(t) + \gamma_2 \bar{q}(t) \\ &= \dot{\bar{q}}(t) + \gamma_2 \bar{q}(t) - \gamma_2 \begin{pmatrix} q_{1d}^* \\ 0 \end{pmatrix} \\ &= s(t) - \gamma_2 \begin{pmatrix} q_{1d}^* \\ 0 \end{pmatrix} \end{aligned} \quad (73)$$

Introducing (73) into (72) one obtains:

$$\begin{aligned}
\dot{V}_1(t) &= -\gamma_1 s(t)^T s(t) + \gamma_1 \gamma_2 s(t)^T \begin{pmatrix} q_{1d}^* \\ 0 \end{pmatrix} \\
&= -\gamma_1 s(t)^T s(t) + \gamma_1 \gamma_2 s_1(t) q_{1d}^* \\
&= -\gamma_1 s(t)^T s(t) + \gamma_1 \gamma_2 \dot{q}_1(t) q_{1d}^* + \gamma_1 \gamma_2^2 q_1(t) q_{1d}^* \\
&= -\gamma_1 s(t)^T s(t) + \gamma_1 \gamma_2 \dot{q}_1(t) q_{1d}^* - \gamma_1 \gamma_2^2 q_1(t) |q_{1d}^*|
\end{aligned} \tag{74}$$

Using the fact that $q_1(t) \geq 0$, $q_1(t_k) = 0$ and that $q_{1d}^* = -\alpha V(\tau_0^k) \leq 0$, then between two impacts one has for all $k \geq 0$:

$$\begin{aligned}
V_1(t_{k+1}^-) - V_1(t_k^+) &= \int_{(t_k, t_{k+1})} \dot{V}_1(t) dt \\
&= - \int_{(t_k, t_{k+1})} \gamma_1 s(t)^T s(t) dt - \int_{(t_k, t_{k+1})} \gamma_1 \gamma_2^2 q_1(t) |q_{1d}^*| dt \\
&\quad + \gamma_1 \gamma_2 q_{1d}^* [q_1(t)]_{t_k}^{t_{k+1}} \\
&= - \int_{(t_k, t_{k+1})} \gamma_1 s(t)^T s(t) dt - \int_{(t_k, t_{k+1})} \gamma_1 \gamma_2^2 q_1(t) |q_{1d}^*| dt \\
&\leq 0
\end{aligned} \tag{75}$$

Therefore condition **(b)** of claim 2 is satisfied.

(d) Let us start with the computation of $\sigma_V(t_k)$. For $k \geq 1$, $q_d(t_k^+) = q_d(t_k^-)$ and $\dot{q}_d(t_k^+) = \dot{q}_d(t_k^-) = 0$ see (19). Consequently one has:

$$\begin{aligned}
\sigma_{V_1}(t_k) &= V_1(t_k^+) - V_1(t_k^-) \\
&= \frac{1}{2} [(\dot{\tilde{q}}(t_k^+) + \gamma_2 \tilde{q}(t_k^+))^T M_k (\dot{\tilde{q}}(t_k^+) + \gamma_2 \tilde{q}(t_k^+)) \\
&\quad - (\dot{\tilde{q}}(t_k^-) + \gamma_2 \tilde{q}(t_k^-))^T M_k (\dot{\tilde{q}}(t_k^-) + \gamma_2 \tilde{q}(t_k^-))] \\
&= \frac{1}{2} \dot{q}(t_k^+)^T M_k \dot{q}(t_k^+) - \frac{1}{2} \dot{q}(t_k^-)^T M_k \dot{q}(t_k^-) + \gamma_2 [\dot{q}(t_k^+)^T M_k \tilde{q}(t_k^+) \\
&\quad - \dot{q}(t_k^-)^T M_k \tilde{q}(t_k^-)] \\
&= T_L(t_k) + \gamma_2 [\dot{q}(t_k^+) - \dot{q}(t_k^-)]^T M_k \tilde{q}(t_k)
\end{aligned} \tag{76}$$

where $M_k \triangleq M(q(t_k))$. Using the fact that $q_1(t_k) = 0$ and $q_{1d}(t) = 0$ after the first impact see (19), one gets from (76):

$$\sigma_{V_1}(t_k) = T_L(t_k) + \gamma_2 \tilde{q}_2(t_k)^T [M_{21} \sigma_{\dot{q}_1}(t_k) + M_{22} \sigma_{\dot{q}_2}(t_k)] \tag{77}$$

Introducing (36) in (77) one obtains for all $k \geq 1$:

$$\sigma_{V_1}(t_k) = T_L(t_k) \leq 0 \quad (78)$$

For $k = 0$, two cases have to be examined.

- If $t_0 > \tau_1^k$ then one has also $q_d(t_0^+) = q_d(t_0^-)$ and $\dot{q}_d(t_0^+) = \dot{q}_d(t_0^-) = 0$, and one can use the result of Eq. (78) to obtain:

$$\sigma_{V_1}(t_0) = T_L(t_0) \leq 0 \quad (79)$$

- If $t_0 < \tau_1^k$ then one has $q_{1d}(t_k^-) \neq q_{1d}(t_k^+) = 0$ and $\dot{q}_{1d}(t_k^-) \neq \dot{q}_{1d}(t_k^+) = 0$. One calculates the initial jump as follows:

$$\begin{aligned} \sigma_{V_1}(t_0) &= T_L(t_0) - \frac{1}{2} \dot{q}_d(t_0^-)^T M(q(t_0)) \dot{q}_d(t_0^-) - \frac{1}{2} \gamma_2^2 q_{1d}(t_0^-) M_{11}(q(t_0)) q_{1d}(t_0^-) \\ &\quad + \gamma_2 [(\dot{q}_1(t_0^-) M_{11}(q(t_0)) + \dot{q}_2(t_0^-)^T M_{21}(q(t_0))) q_{1d}(t_0^-) \\ &\quad + \dot{q}_{1d}(t_0^-) M_{12}(q(t_0)) \tilde{q}_2(t_0^-)] + \gamma_2^2 q_{1d}(t_0^-) M_{12}(q(t_0)) \tilde{q}_2(t_0^-) \end{aligned} \quad (80)$$

From (79), (80) and (78) one has:

$$\begin{aligned} \sum_{k=0}^{\infty} \sigma_{V_1}(t_k) &\leq \gamma_2 \|\dot{q}(t_0^-)\| \|q_{1d}(t_0^-)\| \|M_1(q(t_0))\| + \gamma_2 \|\dot{q}_{1d}(t_0^-)\| \\ &\quad \|M_{12}(q(t_0))\| \|\tilde{q}(t_0^-)_2\| + \gamma_2^2 \|q_{1d}(t_0^-)\| \|M_{12}(q(t_0))\| \|\tilde{q}_2(t_0^-)\| \end{aligned} \quad (81)$$

where $M_1 = [M_{11}; M_{12}]^T$. Let us now prove that:

$$\sum_{k=0}^{\infty} \sigma_{V_1}(t_k) \leq K V_2^k(\tau_0^k) \quad (82)$$

where $K > 0$. Let us calculate upper-bounds on $q_{1d}(t_0^-)$, $\dot{q}_{1d}(t_0^-)$, $\dot{q}(t_0^-)$ and $\tilde{q}_2(t_0^-)$. On $[\tau_0^k, t_0)$, one has $\dot{V}_2(t) \leq 0$, so that $V_2(t_0) \leq V_2(\tau_0^k)$. Therefore from (42) we get:

$$V_2(\tau_0^k) \geq V_2(t_0^-) \geq \gamma_2 \gamma_1 \tilde{q}(t_0^-)^T \tilde{q}(t_0^-) \geq \gamma_2 \gamma_1 \|\tilde{q}_2(t_0^-)\|^2 \quad (83)$$

so that

$$\|\tilde{q}_2(t_0^-)\| \leq \|\tilde{q}(t_0^-)\| \leq \sqrt{\frac{V_2(\tau_0^k)}{\gamma_2 \gamma_1}} \quad (84)$$

From (42) one has $V_2(t) \geq \frac{1}{2} s(t)^T M(q) s(t)$. Consequently:

$$\|s(t_0^-)\| \leq \sqrt{\frac{2V_2(\tau_0^k)}{\lambda_{\min}(M)}} \quad (85)$$

From (84), (85) and the definition of $s(t)$ one concludes that

$$\|\dot{\tilde{q}}(t_0^-)\| \leq \|s(t_0^-)\| + \gamma_2 \|\tilde{q}(t_0^-)\| \leq \left[\sqrt{\frac{2}{\lambda_{\min}(M(q))}} + \gamma_2 \sqrt{\frac{1}{\gamma_2 \gamma_1}} \right] V_2^{\frac{1}{2}}(\tau_0^k) \quad (86)$$

From (84), (86), the result of claim 6 and the fact that $V_2(\tau_0^k) \leq 1$ and the fact that $q_d(t_0^-) = q_d^*(t_0^-)$ and $\dot{q}_d(t_0^-) = \dot{q}_d^*(t_0^-)$, inequation (81) becomes:

$$\sum_{k=0}^{\infty} \sigma_{V_1}(t_k) \leq K V_2^{\frac{3}{4}}(\tau_0^k) \quad (87)$$

with

$$K = \left[\sqrt{\frac{2\gamma_2}{\gamma_1 \lambda_{\min}(M(q))}} + \frac{\gamma_2}{\gamma_1} \right] \|M_{11}(q(t_0))\| + \left[K_0 \sqrt{\frac{\gamma_2}{\gamma_1}} + \frac{\gamma_2}{\gamma_1} \right] \|M_{12}(q(t_0))\| \quad (88)$$

By inserting (42) in (87), one gets

$$\sum_{k=0}^{\infty} \sigma_{V_1}(t_k) \leq K V_1^{\frac{3}{4}}(\tau_0^k) + K(\gamma_2 \gamma_1)^{\frac{3}{4}} \|\tilde{q}(\tau_0^k)\|^{\frac{3}{2}} \quad (89)$$

Therefore one has:

$$\sum_{k=0}^{\infty} \sigma_{V_1}(t_k) \leq K V_1^{\frac{3}{4}}(\tau_0^k) + \epsilon' \quad (90)$$

for some $\epsilon' > 0$. Therefore condition **(d)** of claim 2 is satisfied. The system (15) with the controller (41) satisfies all the requirements of claim 2 with $\epsilon \neq 0$. Consequently it is practically Ω -weakly stable with $x(\cdot) = s(\cdot)$, and $R = \left(\frac{2}{\lambda_{\min}(M(q))} e^{-\gamma(t_f^k - t_\infty)} (1 + K + \epsilon') \right)^{\frac{1}{2}}$, $\gamma = \frac{2\gamma_1}{\lambda_{\max}(M(q))}$. ■

(ii) Proof of the second result of claim 7: Let us show that conditions **(a)** and **(d)** in claim 2 are satisfied.

(a) Outside phase I_k it can be computed that [Spong *et al.*, 1990]

$$\dot{V}_2(t) = -\gamma_1 \tilde{q}^T \dot{\tilde{q}} - \gamma_1 \gamma_2^2 \tilde{q}^T \tilde{q} \quad (91)$$

Let us upper bound $V_2(t)$. From (42) one has

$$V_2(t) \leq \frac{\lambda_{\max}(M(q))}{2} \|\dot{\tilde{q}}\|^2 + \frac{\lambda_{\max}(M(q))}{2} \gamma_2^2 \|\tilde{q}\|^2 + \gamma_2 \lambda_{\max}(M(q)) \|\dot{\tilde{q}}\| \|\tilde{q}\| + \gamma_1 \gamma_2 \|\tilde{q}\|^2 \quad (92)$$

Since $\|\dot{\tilde{q}}\|\|\tilde{q}\| \leq \|\tilde{q}\|^2 + \|\dot{\tilde{q}}\|^2$ inequality (92) is rewritten:

$$V_2(t) \leq \lambda_{\max}(M(q)) \frac{1+2\gamma_2}{2\gamma_1} \gamma_1 \|\dot{\tilde{q}}\|^2 + \frac{\lambda_{\max}(M(q))(\gamma_2+2)+2\gamma_1}{2\gamma_1\gamma_2} \gamma_1\gamma_2^2 \|\tilde{q}\|^2 \quad (93)$$

With

$$\gamma^{-1} = \max \left[\lambda_{\max}(M(q)) \frac{1+2\gamma_2}{2\gamma_1} ; \frac{\lambda_{\max}(M(q))(\gamma_2+2)+2\gamma_1}{2\gamma_1\gamma_2} \right] > 0 \quad (94)$$

inequality (93) becomes

$$V_2(t) \leq \gamma^{-1} \left[\gamma_1 \|\dot{\tilde{q}}\|^2 + \gamma_1\gamma_2^2 \|\tilde{q}\|^2 \right] \quad (95)$$

Inserting (91) in (95) yields

$$V_2(t) \leq -\gamma^{-1} \dot{V}_2(t) \quad (96)$$

Then $\dot{V}_2(t) \leq -\gamma V_2(t)$, and condition **(a)** of claim 2 is satisfied.

(d) As $V_2(t) = V_1(t) + \gamma_1\gamma_2\tilde{q}^T\tilde{q}$ then

$$\sigma_{V_2}(t_k) = \sigma_{V_1}(t_k) + \gamma_1\gamma_2\sigma_{\|\tilde{q}\|^2}(t_k) \quad (97)$$

For $k \geq 1$, one has $q_d(t_k^+) = q_d(t_k^-)$, the position $q(t)$ is continuous, so that $\sigma_{\|\tilde{q}\|^2}(t_k) = 0$ and

$$\sigma_{V_2}(t_k) = \sigma_{V_1}(t_k) = T_L(t_k) \leq 0 \quad (98)$$

For $k = 0$, one has $q_d(t_0^+) \neq q_d(t_0^-)$. Let us upper bound $\sigma_{\|\tilde{q}\|^2}(t_0)$. One has

$$\sigma_{\|\tilde{q}\|^2}(t_0) = \|\tilde{q}_1(t_0^+)\|^2 + \|\tilde{q}_2(t_0^+)\|^2 - \|\tilde{q}_1(t_0^-)\|^2 - \|\tilde{q}_2(t_0^-)\|^2 \quad (99)$$

As $q_{2d}(t_0^-) = q_{2d}(t_0^+)$, $q_{1d}(t_0^+) = 0$ and $q_1(t_0) = 0$ one obtains

$$\sigma_{\|\tilde{q}\|^2}(t_0) = -\|q_{1d}(t_0^-)\|^2 \leq 0 \quad (100)$$

From (97), (98), (100) and (87) one has that

$$\sum_{k=0}^{\infty} \sigma_{V_2}(t_k) \leq \sum_{k=0}^{\infty} \sigma_{V_1}(t_k) \leq KV_2^{\frac{3}{4}}(\tau_0^k) \quad (101)$$

Therefore condition **(d)** of claim 2 is satisfied. The system (15) with the controller (41) satisfies all the requirements of claim 2**(ii)**. Consequently it is practically Ω -weakly stable with $x(\cdot) = [s(\cdot), \tilde{q}(\cdot)]$. ■

C Linear Complementarity Problem

A LCP is a system of the form [Murty, 1997]:

$$\begin{cases} \lambda \geq 0 \\ A\lambda + b \geq 0 \\ \lambda^T(A\lambda + b) = 0 \end{cases} \quad (102)$$

which can also be written as

$$0 \leq \lambda \perp A\lambda + b \geq 0 \quad (103)$$

Such a LCP possesses a unique solution for all b , if and only if A is a P-matrix (positive-definite matrices are P-matrices). ■

Contents

1	Introduction	3
1.1	Dynamics	4
1.2	Admissible domain	5
1.3	Impact model	7
1.4	Model well-posedness	7
1.5	Cyclic task	8
2	Stability Framework	12
3	Tracking Controller Framework	16
3.1	Controller structure	16
3.2	Design of the desired trajectory on phases I_k	19
3.3	Conditions for take-off	21
3.4	Control strategy to assure detachment	22
3.5	Closed-loop stability analysis	24
4	A Weakly-Stable Scheme	28
5	Simulation Examples	30
5.1	Asymptotic convergence	30
5.2	Robustness	31
6	Mutiple Impacts	33
6.1	Stabilisation with a 2-impact	35
6.2	Impact on one surface before a 2-impact	36
6.3	Case (c) : General case	37
7	Conclusion	38
A	Proof of Claim 6	42
B	Proof of Claim 7	45
C	Linear Complementarity Problem	50



Unité de recherche INRIA Rhône-Alpes

655, avenue de l'Europe - 38330 Montbonnot-St-Martin (France)

Unité de recherche INRIA Lorraine : LORIA, Technopôle de Nancy-Brabois - Campus scientifique
615, rue du Jardin Botanique - BP 101 - 54602 Villers-lès-Nancy Cedex (France)

Unité de recherche INRIA Rennes : IRISA, Campus universitaire de Beaulieu - 35042 Rennes Cedex (France)

Unité de recherche INRIA Rocquencourt : Domaine de Voluceau - Rocquencourt - BP 105 - 78153 Le Chesnay Cedex (France)

Unité de recherche INRIA Sophia Antipolis : 2004, route des Lucioles - BP 93 - 06902 Sophia Antipolis Cedex (France)

Éditeur

INRIA - Domaine de Voluceau - Rocquencourt, BP 105 - 78153 Le Chesnay Cedex (France)

<http://www.inria.fr>

ISSN 0249-6399