



HAL
open science

From euclidian to hop distance in multi-hop radio networks: a discrete approach

Anthony Busson, Guillaume Chelius, Eric Fleury

► **To cite this version:**

Anthony Busson, Guillaume Chelius, Eric Fleury. From euclidian to hop distance in multi-hop radio networks: a discrete approach. RR-5505, INRIA. 2005, pp.29. inria-00070502

HAL Id: inria-00070502

<https://inria.hal.science/inria-00070502>

Submitted on 19 May 2006

HAL is a multi-disciplinary open access archive for the deposit and dissemination of scientific research documents, whether they are published or not. The documents may come from teaching and research institutions in France or abroad, or from public or private research centers.

L'archive ouverte pluridisciplinaire **HAL**, est destinée au dépôt et à la diffusion de documents scientifiques de niveau recherche, publiés ou non, émanant des établissements d'enseignement et de recherche français ou étrangers, des laboratoires publics ou privés.



!"#\$%\$ " &\$! " &() * +*, - *+, - * * " ! " . ' + / &\$!0 %* *\$ * " &%\$' / &\$!0 %*

! '#\$ %&()*+, -# . #/ *)0+, ' %d, \$ &(-)1 #/ '+*)#
, %2 #'304 + *)0' '%d/d / '#+'.

&123415 678841 9 : 7;<=> ?, 3?<78 9 * @A. <7@

! " ##\$# %&()*'+,

B?@,41 ;1;2=> C=17=@ DEEF GB?@,41 @B;8P #?I 2> J @ DEEF

_____!"\$%\$ &' (_____





! '#\$ %&()*+, -#.#/ *)0+, '%, \$ &(-)1 #/ '+*)# , %2 #'304 +
*)0' '%%/+ / '#+'.

."\$0"OP: 440" 7Q: #28: C &R* &# 47<(#) E2& (O

G* &C &RT @ N BO4&C &)0CC: "#8" \$
U0V&\$. (&

- 8330(\$' &(&* &)* & "0 66M W9&(4#) L*N 9&(4#) # #82&X": 8(OLM6 N 9&(4#) (8#18&
B&3&C A&LMM LY38Z&

5 60-'+'-4 +' \$ #1 8(\$ 2&7[& \0(C 82# & \$ & (828\$0) P(N_d = n) A&[& & \$ * & *03 ' #1\$8") & 8" ' \$ * & & 1
) 2# #8" ' #1\$8") & # KI' #C & 4#) "828" ' LI' #C & 4#) "82' #) (& & ' & [0(^4_ ' & 3(09# &) 204& \0(C: 284
\0(\$ * & C & 8" *03 ' #1\$8") & A&[& & \$ [0 8(A#(8(O"0' & 4' & 3& ' #Z0" \$ * & (&) 2# #8" ' #1\$8") & # A0\$
' #) (& & 8" ')0" \$ # : 0: 4 " & [0(^4_ @0(& Z& & 8207[& 8240 \0(C 8203(09& \$ * 8\$(& 4: 284)0C3: \$ & #
' #) (& & " & [0(^4 # ' :) & A0: " ' 8(#4 #)0" \$ # : 0: 40" & _ @0(809& 784 \$ * & 4\$83 0\ \$ * & ' #) (& & " & [0(^4
[0(^ # 4 ' &) (& 4& 7' #) (& & (& 4: 284)0"9& Z& \$0[8(' 4)0" \$ # : 0: 40" & _ G* #1 3* & 0C & 8 V 4\$# & 4 \$ * &
C & \$ * 0' 020Z0)0" 4#1\$# Z#)0" 4# & # ' Z' #) (& & " & [0(^4 \$0 4\$ ' 03(03& \$ * 4 \$ * 8\$8(& * 8(' 20\$(8) \$A2&
)0" \$ # : 0: 4 " & [0(^4_

7 %812 #' *04 C: 2# #03 (8' #) " & [0(^474\$0) *84\$# Z80C & (07*03 ' #1\$8") &

* R204& \0(C: 284 *89& A& & 8' & # \$ * &) 84&0\)0" \$ # : 0: 4 " & [0(^4

! "\$ %&(\$)*""+*#&(&)" , "-' +)) . / 0- " %' '\$+('1+) "
 \$22-. *3" %&* -4("

5 6+ / 6 1 ! "#\$%&()*+&' & , - . # , (& (+ & # , 0 - 1) / & 1 , & 1 (#2 $P(N_d = n)$ & 2, (& 1 +) / (-2' & & 2#0 \$, & + & / -3(/ & 1 +) / (-2' & & 3' 1) + & 22 & + -2 / + & , & & 35 +) / ' , & / & ' #2(23 / 6 & 78 +) 0 & 2) / #22 & / 9 : #3 , 1 & ' - / 32) 8 +) 0 & 2) / #22 & ; 2#3 / ' #2 /) + & #2 / 1 #2 < 3 & 8 , + " 32 . B / ' #3 , (' = 80) 2 - # , / > 3 & + - 2 / 1 & ' - / \$) 8 +) 0 & 2) / #22 & ; 2#3 / 2#3 / ' #2' & 2 , #2 / 13 , 1 #2 < 3 & 8 , + & , #3 (& ' #2 / (, 3) (& . - , 32 - 18 < # ,) (= 0 & + & , #3 (- < & < # < , - . =) > 3 & 8 ? #3 / & @ B #2 / & < 180 & 2 (1 #2 < 3 & 8 , 0 # & 22 & + & / -3(/ 1 & #2 < + & , #3 (& ' , & & 9 : B / < & & - 180 & 2 ; 2#3 / . , #3 @ 2 / > 3 & 1 & . , # . ,) & & ' - 1 3 1 & & + -2 / + & , & & 35 +) / ' , & /) 2 + 3) / & 2 (+ & \$ # , 2 & > 3 - 2 (- 35 . , # . ,) & & + & , & & 35 ' #2(23 / 9 B & . B / ; # , / > 3 & 1 & . - / + & +) / ' , & / -) #2 & (, & + 3) ; 1 & @ 183 , / ' - 1 3 1 & & + -2 / 1 & , & & 35 +) / ' , & / ' #2 @ < & 2 (@ & / ' & 1 & + & , & & 35 ' #2(23 / 9 C & . = & 2 #0 & & % / () E & 1 - 0 & (= # + # # <) & ' #2 /) / (-2 (D ' #2 /) + & & + & , & & 35 +) / ' , & / . #3 , 1' & (3 + & + & . , # . ,) & & > 3) / #2 (+) ' E ') 180 & 2 (' - 1 3 1 \$ 1 & + -2 / 1 & , & & 35 ' #2(23 / 9

7 . (' 8 * # 6 1 , & & 35 , - +) # 0 3 1(8' - 3(/ ; < # 0 & ,) & / (#' = / () > 3 & 2#0 \$, & + & / -3(/

! '#\$%&()*\$*#&

" # \$ %&()*+, - (/ &### 0/'- +.1# 2./ 3/'(03 \$ +./ 204 \$ +./ #%(4/ 45# , 2'(2&#'+6*2#(6 \$ +4/ &# 204 (0 , 2.'(6%&. .204+\$ 3.2, *#5# , 2'(2& +0' , .+6/### #5#'+6*2#(6 3/+\$ /'.754(#6./' / 204 6+0'(0%#& , / .6+&'(+0 1-2 2 2 , /2. 8/.7 2''.26'(8/ (0 +.4/. '+ \$ +4/ &204 202&9/ '*/ :%042\$ /0'2& , .+, /.'(/ # +: \$ %&()*+, - (/ &### 0/'- +.1# , </8/ .2&- +.1# =>5?5 @A5 @B @C *28/ D/0 4+0/ '+ 202&9/ '*/ 6+00/6'(8('7 +: \$ %&()*+, - (/ &### .24(+0/'- +.1# %#(03 .204+\$ 3.2, *# 2###+6(2'/4 - (* '*/ E+(###+0 F++&20 \$ +4/ &204 , / .6+&'(+0 , .+, /.'(/ #, G (*0 '*(#6+0'/H5'*/ E+(###+0 F++&20 \$ +4/ &2###%\$ / # '*2' '*/ - (/ &### 0+4/ # 2./ '/4 266+.4(03 '+2 , &202. E+(###+0 , +0' , .+6/### 204 '*2' /26* #2'(+0 *2# 20 (04/ , /04/0' , + /.; " \$ +./ 6+\$, &H, *7#(62&\$ +4/ &D2#4 +0 '*/ #302&+(0' /:./ /06/ .2'(+ *2# D/0 , .+, +#4 (0 =C J + /8/.52 :%042\$ /0'2&4(8/.3/06/ - (* , /8(+# # '/ &6+\$ \$ %0(62'(+0 2###%\$, '(+0# (# '*2' '*/ / %6&4/ 20 4(#206/ 620 0+' D 4(/ 6'& %#4 (0 +.4/. '+ 10+ '*/ *+, 4(#206/ - (* (0 '*/ 0/'- +.1 D '- / /0'- +.2. D '.2.7 0+4/ #, K*/ 052&&*/ , .+D&\$ ##+&8/4 (0 2/8/.7 / &320' - 27 D7 #, 2'(2&#'+6*2#(6 \$ +4/ &#) / #, /6(2&& '*+## D2#4 +0 E+(###+0 #, 2'(2& +0' , .+6/### #) #'*+&# D /8(#'/4;

10 '*(# , 2, / . - / 244./## '*(# , 2.'(6%&. , +0' 204 '.7 '+ 6*2.26'/(9/ '*/ ./ &'(+0 '*2' 4+/#/ H# D' - / /0 '*/ / %6&4/ 20 4(#206/ d(u, v) 204 '*/ , .+D2D&7 '*2' '*/ 0%\$ D . +: *+, # D' - / /0 u 204 v (#2' &2# n; K*(#- +.1 2&&- #'+/H/04 '*/ , + / . +: #, 2'(2&#'+6*2#(6 \$ +4/ &# '+- (/ &### %& '*+ , .24(+0/'- +.1# #06/ - / - (&D 2D& :+ /H2\$, &' +4/ .(8/ , 2.2\$ /'.(6 +, '\$ (92'(+0# +: 2.6*('6' %/ # D7 '21(03 (0'+ 266+%0) '*/ 0%\$ D . +: *+, # D' - / /0 '- +0+4/ # 10 +.4/. '+ 202&9/ 2 \$ %&(62# ' / / +. '*/ 0%\$ D . +: 32*'/ .(03 #0#+.# '*2' #'*+&# D 4/ , &7/451-' 2j

K+ 4/ .(8/ 6 :+.\$ %25- / O.# #%47 '*/ 62# +: 4(#6./' / 3.2, *#- *'/ - / %# \$ 2.1+8 6*2(0# '+ 3/' 202&'(62&/#%&#; K*/05- / ##+ '*2' , .+, /.'(/ # +D# .8/4 (0 4(#6./' / 3.2, *# 2./ 2&+ % , / . 204 &- / . D+%04# :+ / P%82&0' , .+, /.'(/ # (0 6+0'(0%+%# 0/'- +.1#, G/ 2&+ ##+ '*2' 4(#6./' / /#%&# 6+08/ .3/ '+ 2.4# 6+0'(0%+%# +0/ #, K*(# 2, , .+26* 3(8/ # %# '*/ +, , +.%0('7 '+ 4/4%6/ 6 :+.\$ %2# (0 6+0'(0%+%# 0/'- +.1#, G/ :+.\$ 2&& , .+8/ '*(# 2, , .+26* (0 2 3/0/ .2&62# - *'/ / '*/ #%(4/ , .+, /.'7 (#0+' 0/6/##2. & '*/ / &'(+0 D' - / /0 '*/ *+, 204 '*/ / %6&4/ 20 4(#206/ ;

K*/ , 2, / . (#.#.%% / 4 2# :+&&- #, </6'(+0 B(0' .+4%6/ #204 4/ #6. (D #' '*/ 6+0'(0%+%# 204 4(#6./' / \$ +4/ &- / 6+0#(4/ .; 10 </6'(+0 ! 204 #6'(+0 >5- / #%47 '*/ @4(\$ /0#(+02&204 B)4(\$ /0#(+02& 4(#6./' / \$ +4/ &# 204 (0 D+'* 62# #5- / 202&9/ '*/ 28/.23/ 4(#206/ (0 ' . \$ +: *+, # 204 '*/ 28/.23/ / %6&4(20 , .+3./### +0 +: 2 *+, ; 10 </6'(+0 C5- / , .+8/ '*2' '*/ 4(#6./' / \$ +4/ &+ : / . # &- / . R6 , / . D+%04# :+ '*/ 6+0'(0%+%# \$ +4/ & </6'(+0 S , .+8/ # '*2' '*/ , .+, /.'(/ # +: 6+0'(0%+%# 0/'- +.1# 620 D' 2, , .+H\$ 2'/4 %#(03 4(#6./' / 0/'- +.1# 204 '*2' 4(#6./' / , .+, /.'(/ # 6+08/ .3/ '+ 2.4# 6+0'(0%+%# +0/ # 2# '*/ 4(#6./' / #/ , (#./4%6/4; </6'(+0 T , / #0' # '*/ 2, , &62'(+0 +: '*/ # &# . / # %&# '+ '*/ # %47 +: '*/ *+, 4(#206/ (0 6+0'(0%+%# 0/'- +.1#, U02&&5- / 4.2- #+\$ / 6+06&#(+0 #204 :% %/ , / . #, /6'(8/ # (0 </6'(+0 I;

!

!"##\$%&'()*+,-./:;<=>?@A

! " # \$ % &

! () * # +, - +. #. ' + % / # 0 1'

" n # \$ % & ' () % (+, - * (. % / * /) (' . 0 * 1 2 ω % + 3 (%) ' . * 4 - * * 1 \$ % + . ') ω = { (i_1^j, ... i_n^j) ∈ [0, 1]^n | j ∈ [0 ... C], C ∈ N } 5

6 % ' (n ∈ N * 8 0 ' - +, Ω_n . 9 ') ' . * 4 +, : *) % , ' n # \$ % & ' () % (+, - * (. % / * /) (' . 0 * 1 2) 5 6 % ' (λ ∈ R + * 8 0 ' - * () % ' 1 . 9 ' : 1 * ; + ; % % %) : + ' (Ω_n , Q , P_λ) 0 9 ' Γ P_λ % . 9 ' : 1 * ; + ; % % % , + 0 = % ' (; < - * () % ' 1 + . % (* 4 + : * %) * % (\$ % . 1 % / . % (* 4 (* \$ ') 0 % @ % . ' () % < λ 5

! (! 2 - ' 3 0 % % @ % / # 0 1'

" n # \$ % & ' () % (+, \$ % - Γ . ' (' . 0 * 1 2 * 4) % ' S % + 4 (- . % (γ : [1 ... S]^n → { 0, 1 } \$ ' 3 (' \$ * 7 ' 1 %) 0 9 * , ' % : / . \$ * & + % 5 6 % ' (+ (' . 0 * 1 2 γ + (\$ +) ' . * 4 % \$ % ') (i_1, ... i_n) ∈ [1 ... S]^n 8 0 ') + < . 9 + . 9 ' - * * 1 \$ % + . ' (i_1, ... i_n) % % - / : % \$ % γ (i_1, ... i_n) = 1 + (\$ ' & : < % γ (i_1, ... i_n) = 0 5

6 % ' (n ∈ N * 8 S ∈ N * + (\$ p ∈ [0, 1] 8 0 ' \$ ' 3 (' . 9 ' : 1 * ; + ; % % %) : + ' (Γ_{(n,S)} , Q' , P_p) 0 9 ' Γ_{(n,S)} % . 9 ') ' . * 4 +, : *) % , ' n # \$ % & ' () % (+, \$ % - Γ . ' (' . 0 * 1 2) * 4) % ' S 5 Q' % . 9 ') ' . * 4 +, , / ;) ' .) * 4 Γ_{(n,S)} ? Q' = 2^{Γ_{(n,S)}} 5 " (\$ P_p ' @ +) ?

$$P_p : Q' \rightarrow [0, 1]$$
$$A \mapsto \sum_{\gamma \in A} P_p(\gamma)$$

0 9 ' Γ P_p (γ) % . 9 ' : 1 * ; + ; % % % * 4 - 9 * *) % = γ % Γ_{(n,S)} = % ' (+ - * * 1 \$ % + . ' * - / : + (- < : 1 * ; + ; % % % < * 4 p 5 A 1 (γ) % ' @ + , . * . 9 ' (/ & ; ' 1 * 4 * - / : % \$ - * * 1 \$ % + . ') + (\$ 0 (γ) % ' @ + , . * . 9 ' (/ & ; ' 1 * 4 ' & : < - * * 1 \$ % + . ') % γ 8 0 ' . 1 % % , , < 9 + 7 ' ?

$$P_p(\gamma) = p^{1(\gamma)} \cdot (1 - p)^{0(\gamma)}$$

A - * () ' @ ' (- ' 8 0 ' - + (@ + , % + % ' , < \$ ' 3 (' P_p (A) 9 +) ; ' % = ' @ + , . * . 9 ' : 1 * ; + ; % % % * 4 . + 2 % = + (' , ' & ' (. * 4 A 0 9 ' (- * () % ' 1 % = + - * * 1 \$ % + . ' * - / : + (- < : 1 * ; + ; % % % * 4 p 5

! (4 5 6 & \$ 7 6, 8 6 + \$ 8 # 7 \$ - , 6 + 3 %

6 % ' (+ \$ % , + (- || % R^n + (\$ = % ' (+ - * & & / (% + % (1 + (= ' T 8 0 ') + < . 9 + . 0 * (* \$ ') + . - * * 1 \$ % + . ') (i_1^1, ... i_n^1) + (\$ (i_1^2, ... i_n^2) - + (- * & & / (% + , ' % | (i_1^1, ... i_n^1) , (i_1^2, ... i_n^2) | ≤ T 5

6 % ' (+ \$ % - Γ . ' (' . 0 * 1 2 γ * 1 + - * (. % / * /) (' . 0 * 1 2 ω + (\$ + - * & & / (% + % (1 + (= ' T 8 + 7 + , % : + 9 ; ' . 0 ' ' (. 0 * - * * 1 \$ % + . ') x + (\$ y % + 3 (%) ' @ ' (- ' * 4 - * * 1 \$ % + . ') J = { (j_1^i, ... j_n^i) | i ∈ [0 ... l] , l ∈ N * }) / - 9 . 9 + . ?

- $\forall i \in [1 \dots l - 1], \gamma(j_1^i, \dots, j_n^i) = 1 \text{ } \forall 0 ' - * () \% ' 1 \gamma$
- $\forall i \in [1 \dots l - 1], (j_1^i, \dots, j_n^i) \in \omega \text{ } \forall 0 ' - * () \% ' 1 \omega$

!

!"###\$%&'()*+,-./:;<=>?@A

! '# \$ %&'()*+,-./:0 1 2 3 4 5 6 7 8 9

" # \$%&'()*+,-./:0 $\mathbb{P}(N_d = n) = (1-p)^n p^n$ / +\$, # | $x, y|_H = n$ 1 +# | $x, y| = d$ 6 7 8 9 - 5 8 1 # +\$, # 9

$$\mathbb{P}(N_0^e = 0) = 1, \forall e$$

$$\mathbb{P}(N_d^e = 0) = 0, \forall d > 0, \forall e$$

$$\mathbb{P}(N_d^e = 1) = 0, \forall d > T, \forall e$$

$$\mathbb{P}(N_d^e = 1) = 1, \forall 0 \leq d \leq T, \forall e < d$$

: ' \$; <=># ')&' \$ - ' # (1 / % 8 (+ #) & 3 #) (1 \$ 5 / 4 . & * \$) + / % # (3 \$ + & / % 2 . % & # - 5) > & 0 % + # (' # & + 4 / % & (+ # * #) (& \$ (& ' * & # 2 (& ' / 0 ' % \$ % (+ # 3 \$ 2 > # (. ' (& 1 # % \$ 2 + (+ # * #) (& \$ (& ' 6 @ @ . # ; * #) 2 % 4 #) (+ & % . (& ? \$ - ? / % & = \$) / 2 & # (# * / (+ # ' / (\$ (& ') & (% * . 2 # * &) # 2 (& ' A B \$ * .) # * & (+ # \$ ' \$ - 5) & 6 7 + # 3 % 4 \$ 4 & 5 / 0 x 4 # & ? \$ (n + / 3) 0 % = y 1 & + |x, y| = d & # C \$ - / 9

$$\mathbb{P}(N_d^e = n) = \sum_{r=e+1}^T \mathbb{P}(N_{d-r}^{T-r} = (n-1)) \cdot (1-p)^{T-r} \quad \text{DE}$$

@ @ . # A & .) (% #) $\mathbb{P}(N_{d,10} = n)$ 0' % \$ ' / * # 3 # # ' 2 # 3 % 4 \$ 4 & 5 / 0 0.56 : (& & (# #) (& ? / / (& # (+ \$ (+ & 3 % 4 \$ 4 & 5 & ' / (2 / ' * & & ' * # 4 5 (+ # 3 % 4 \$ 4 & 5 / 0 \$, \$ - & 3 \$ (+ # F & (# 2 # 4 # (1 # # (+ #) / . % 2 # \$ ' * (+ # * #) (& \$ (& ' 6 G) \$ 2 / ') # C # ' 2 # 8 \sum_{n=1}^{\infty} \mathbb{P}(N_d = n) & ' / (' # 2 #)) % 5 # C \$ - / 1 6

7 % & 8 - 5 8 1 & + | $x, y| = d$ 8 \$) + / % # (3 \$ + 4 # (1 # # ' x \$ * y 2 \$ ' / (4 # - / ' ? # % (+ \$ 2 \frac{(d-1)}{T} + 1 + / 3) 6 : ' 2 / ') # C # ' 2 # 8 . ' * # % (+ #) + / % # (3 \$ + # F & (# 2 # 2 / ' * & & ' 8 (+ # = # \$ ' , \$ - . # / 0 (+ # + / 3 * & (\$ ' 2 # & ? & # ' 4 5 (+ # 0 - / 1 & ? 0 % . - 9

$$\mathbb{E}[N_d] = \sum_{i=0}^{2 \frac{(d-1)}{T} + 1} i \mathbb{P}_c(N_d = i)$$

7 + & 0 % . - \$ & ' / (2 -) # * 6 H / 1 # , # 8 1 # 2 \$ ' ' . = # % 2 \$ - 5 2 / = 3 . (# , \$. #) / 0 $\mathbb{E}[N_d]$ 6 @ @ . # B) + / 1) $\mathbb{E}[N_{(d,10)}]$ * # 3 # * & ? / ' (+ # # . 2 - & 8 ' * & (\$ ' 2 # d 0 % \$ ' / * # 3 # # ' 2 # 3 % 4 \$ 4 & 5 / 0 0.56 : 0 (+ 0 ' 2 (& ' - / / >) - & # \$) (# 3 0 ' 2 (& ' 0 %) + / % , \$. #) / 0 \frac{d}{T} 8 & C & > 5 4 # 2 / = #) - & # % \$) d & 2 # \$) #) 6 7 + & % #) . - (& , # 5 & (# #) (& ? \$) & = # \$ ') (+ \$ ((+ # + / 3 * & (\$ ' 2 # 2 \$ ' 4 # \$ 3 3 % F & \$ (# * 4 5 \$ - & # % 0 ' 2 (& ' / 0 (+ # # . 2 - & 8 ' * & (\$ ' 2 # 1 + & + ? % * & # (& # C \$ - / \$ /) 0 % (\$ 1 %) 2 3 6 7 + & = # \$ ' + / 3 - # ? (+ & ' / (' # 2 #)) % 5 # C \$ - / T \$ * & \$ 0 ' 2 (& ' / 0 p 6 G) \$ ' \$ 3 3 % F & \$ (& ' 8 1 # 3 % 3 /) #

3 4 + 0 +) * % + / # "

$$\mathbb{E}[N_d] \approx \frac{d}{\mathbb{E}[r]}$$

4

" # ' / 1) (. * 5 (+ # , \$. # / 0 $\mathbb{E}[r]$ 6

56" + 786#"! ———

, -./ 0/ 234

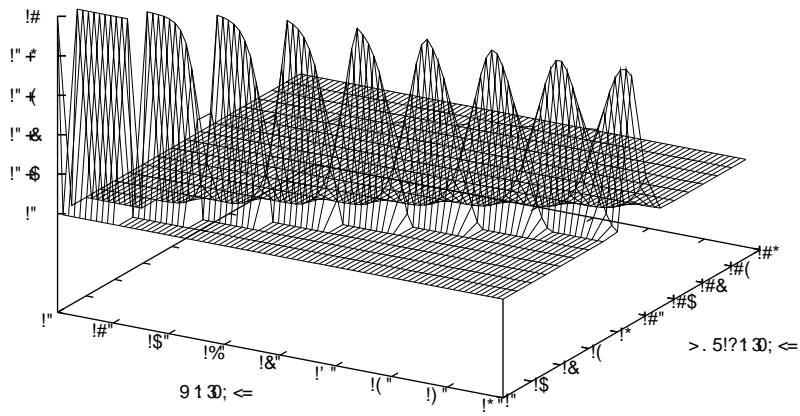

"#\$%& () * &, -, ##0 $\mathbb{P}(N_{(d,T)} = n)$ 1

!

! "##\$%&'()*+,-./:;<=>?@A

!# \$ %& (%) *+, - &+, .

"# \$%&'()*+,-./:;<=>?@A B C D E F G H I J K L M N O P Q R S T U V W X Y Z [\] ^ _ ` a b c d e f g h i j k l m n o p q r s t u v w x y z { | } ~ ¡ ¢ £ ¤ ¥ ¦ § ¨ © ª « ¬ ® ¯ ° ± ² ³ ´ µ ¶ · ¸ ¹ º » ¼ ½ ¾ ¿ À Á Â Ã Ä Å Æ Ç È É Ê Ë Ì Í Î Ï Ñ Ò Ó Ô Õ Ö × Ø Ù Ú Û Ü Ý Þ à á â ã ä å æ ç è é ê ë ì í î ï ð ñ ò ó ô õ ö ÷ ø ù ú û ü ý þ ÿ

\$%&'()*+,-./:;<=>?@A B C D E F G H I J K L M N O P Q R S T U V W X Y Z [\] ^ _ ` a b c d e f g h i j k l m n o p q r s t u v w x y z { | } ~ ¡ ¢ £ ¤ ¥ ¦ § ¨ © ª « ¬ ® ¯ ° ± ² ³ ´ µ ¶ · ¸ ¹ º » ¼ ½ ¾ ¿ À Á Â Ã Ä Å Æ Ç È É Ê Ë Ì Í Î Ï Ñ Ò Ó Ô Õ Ö × Ø Ù Ú Û Ü Ý Þ à á â ã ä å æ ç è é ê ë ì í î ï ð ñ ò ó ô õ ö ÷ ø ù ú û ü ý þ ÿ

<- ' # / (- \$0(- ' nth - \$1 * & (- ' % & # / ' T * 4 9 +, 4 (% & 9 = / , % > * # & & = # ' & 9 4 ' 8 (9 # ? ; @ A ' * 4 4 . ' (- * (- ' & 9 (* # 8 ' : ' (3 ' ' # (- ' 4 \$, % 8 ' * # & (- ' & 4 (9 * (9 # 9 9 = # 9 ' B l = + ∞ C <- * (+ \$ 3 4 , 4 (\$ 8 \$ # 4 9 & % (- ' * 4 5 . 1 (\$ (8 : ' - *) 9 % \$ 0 (- ' 6 * % 7 \$) 8 - * 9 # ; < \$ *) \$ 9 & * (% # 4 9 # (6 * % 7 \$) 8 - * 9 # 2 3 ' 8 \$ # 4 9 & % (- ' 0 * 8 ((- * (- ' % 9 4 * 3 * 5 4 * 1 \$ 9 # (9 (- ' % & 9 \$ % # / ' \$ 0 (- ' 4 , 8 8 ' 4 4 9) ' # \$ & 4 ; D # 8 ' e_n = T - r_n 2 3 ' 8 \$ # 4 9 & % \$ # 5 (- ' 6 * % 7 \$) 8 - * 9 # (e_n)_{n≥0};

/ + % 0 % 1 2 ' / % 0 1 2 3 4) # \$ % 0 * % 5 \$ - 7 8 9 ± () % 0 % 5 3 ; -) # % < ; - \$ = 0 = ± 5 p 0 % 5 0 - 0 % 0 T 8

$$\mathbb{E}[e] = C \left[\frac{T(T-1)}{2} (p-1)^{T-1} + \frac{(-1)^{T-1}}{p^2} ((1-p) - (1-p)^T (Tp+1-p)) \right]$$

6 5

$$C = \frac{p}{Tp(p-1)^T + (-1)^{T-1} (1 - (1-p)^T)}$$

0 % 5

$$\mathbb{E}[r] = T - \mathbb{E}[e]$$

EFGGHI E+ *4' %0 %(\$ *11' #&9 K; □

3' *9. 0%&4 ' ' "# H9 , % @3 ' - *)' # (- . ' *# - \$1 &9 (*#8' # , . ' %8 * + 5 8\$. 1, (& , 49# / 0\$% , * > * 4 * 0 # 8 (9 # \$ 0 (- ' , 8 - 9 * # & 9 (*#8' B p = 0.52T = 10 9 # (- ' = / , % C A ' 8\$. 1 * % (- 9 8 , % ' 3 9 (- . ' 9 # 9 , . # , . : ' % \$ 0 - \$ 1 4 L 9 0 # \$ & 4 3 ' % 1 % 4 ' # (') ' % 3 - ' % L ' J 1 % 4 4 ' & : 5 $\frac{d}{T}$ * # & (- ' 0 \$ % , ± / 9 ' # : 5 (- ' % \$. > * # & 1 % 1 \$ 4 9 (9 # > 2 5) > (- ' 9 # ' $\frac{d}{\mathbb{E}[r]}$; < - 9 4 ± 4 (\$ # ' (# & 4 (\$ - *) ' * 4 9 9 ± % / % & 9 # (* 4 (- ' 8 , % ' 3 - 9 8 - & 4 8 9 ' 4 (- ' % * + . ' * # # , . : ' % \$ 0 - \$ 1 4 ; < - ') * 9 # (9 # : ' (3 ' ' # (- ' 4 ' 8 , % ' 4 9 4 8 \$ # 4 (* # (* # & # / - 9 8 ' ; "(9 4 & ' (\$ * : 9 * 4 9 # (% & 8 ' & : 5 (- ' = 4 (- \$ 1 4 ; A ' 1 \$ 9 # (\$, ((- * ($\frac{|x,y|}{\mathbb{E}[r]}$ / 9 ' 4 * # ' J 8 ' + # (* 1 1 % J 9 * (9 # (\$ (- . ' * # # , . : ' % \$ 0 - \$ 1 4 : ' (3 ' ' # (3 \$ # \$ & 4 x * # & y ; 6 \$ % \$) ' 2 3 ' / 9 ' \mathbb{E}[r] , 4 9 # / * 8 \$ 4 ' & 0 \$ % , ± ;

5 6 4 7 8 0 % 9 / # 9 6 1 , : %

A' # \$ 3 8 \$ # 4 9 & % (- ' 4 1 * 8 ' \$ 0 ? L 8 9 ' # 4 9 # * + & 9 4 8 (' # (3 \$ % 7 4 \Gamma_{(2,S)} * # & 4 (9 + (% \$ ') * ± * ((- ' - \$ 1 & 9 (*#8' |x, y|_H : ' (3 ' ' # (3 \$ # \$ & 4 x * # & y 3 - ' # (- ' 9 % , 8 - 9 9 * # & 9 (*#8' 9 |x, y| = d; M # (% 9 5 (\$ (- ' > L 8 9 ' # 4 9 # # + 8 * 4 2 (- ' 4 * 9 8 - 0 \$ % * 4 \$ % 4 (1 * (- : ' (3 ' ' # (3 \$ # \$ & 4 9 4 * - * % & (* 4 7 * # & 9 #) ' 4 * 8 \$. 1 + J % , (9 # / 1 % 8 ' 4 4 ; "# \$ % & % (\$ 4 9 1 - 9 0 5 (- 9 4 1 % : ± . * # & 4 9 9 ± % 5 (\$ (- ' 3 \$ % 7 & # ' 9 # N > C 3 ' 3 9 + 9 9 \$, % 4 , & 5 (\$ (- ' # / (- \$ 0 % , (' 4 : , 9 (, 4 9 # / * 4 9 1 + / % ' & 5 1 % / % 4 4 L * 4 ' & % , (9 # / * 4 % 9 . 4 9 9 ± % (\$ (- ' 6 H F B \$ # 5 , \$ - 6 0 - 3 @ " 5 9 0 N P C C \$ # ' ;

"QF"K

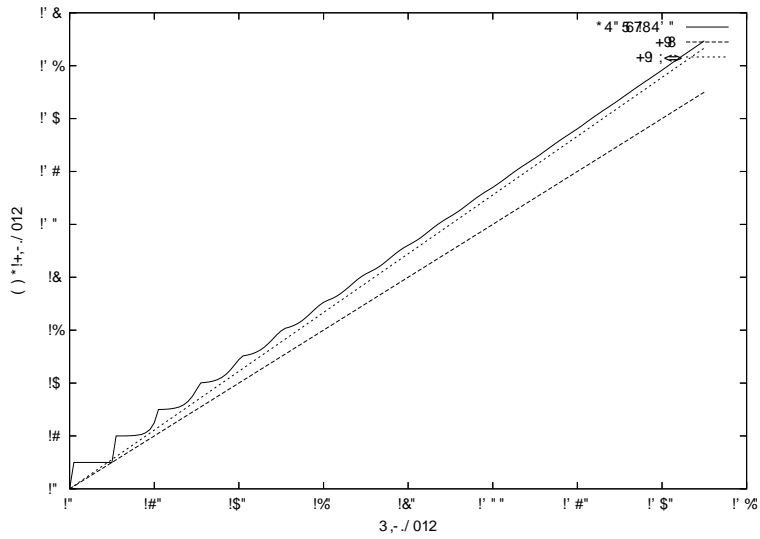

$$!"#$ %&() * +, - . / 0 1 2 3 ' ' 0 \mathbb{E}[N_d] 4 \frac{d}{T} . 05 \frac{d}{\mathbb{E}[r]} 6$$

!"

!"##\$%&'()*+,-./:;<=>?@A

!"# \$%&'()*+,-./:0123456789

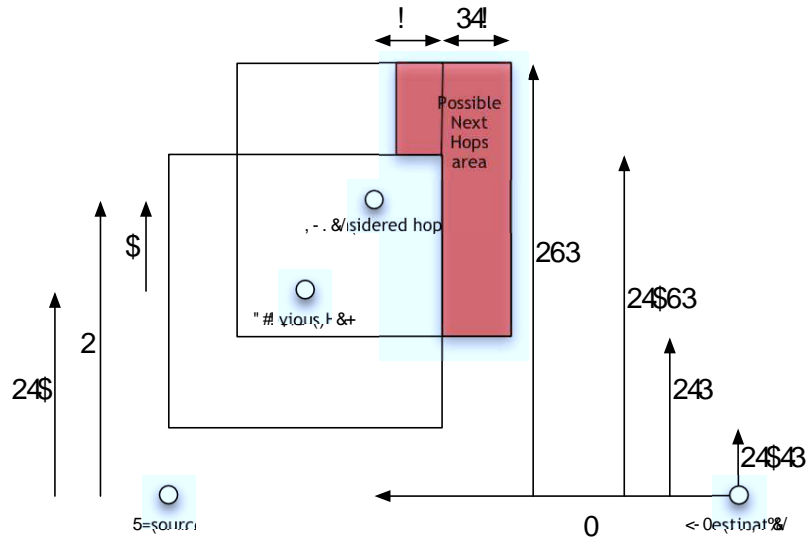

!#\$%&'()*+,-./:0123456789

Let (x, y) be a point in the grid. The distance from the source $(0, 0)$ to (x, y) is $d = |x| + |y|$. The distance from (x, y) to the destination (x_d, y_d) is $d' = |x - x_d| + |y - y_d|$. The total distance is $d + d'$. The grid is $0 \leq x < 62$ and $0 \leq y < 62$. The source is at $(0, 0)$ and the destination is at $(61, 61)$. The grid is divided into four quadrants by $x = 31$ and $y = 31$. The red shaded area is the region where $x \geq 31$ and $y \geq 31$. The blue shaded area is the region where $x < 31$ and $y < 31$.

Let (x, y) be a point in the grid. The distance from the source $(0, 0)$ to (x, y) is $d = |x| + |y|$. The distance from (x, y) to the destination (x_d, y_d) is $d' = |x - x_d| + |y - y_d|$. The total distance is $d + d'$. The grid is $0 \leq x < 62$ and $0 \leq y < 62$. The source is at $(0, 0)$ and the destination is at $(61, 61)$. The grid is divided into four quadrants by $x = 31$ and $y = 31$. The red shaded area is the region where $x \geq 31$ and $y \geq 31$. The blue shaded area is the region where $x < 31$ and $y < 31$.

Let (x, y) be a point in the grid. The distance from the source $(0, 0)$ to (x, y) is $d = |x| + |y|$. The distance from (x, y) to the destination (x_d, y_d) is $d' = |x - x_d| + |y - y_d|$. The total distance is $d + d'$. The grid is $0 \leq x < 62$ and $0 \leq y < 62$. The source is at $(0, 0)$ and the destination is at $(61, 61)$. The grid is divided into four quadrants by $x = 31$ and $y = 31$. The red shaded area is the region where $x \geq 31$ and $y \geq 31$. The blue shaded area is the region where $x < 31$ and $y < 31$.

Let (x, y) be a point in the grid. The distance from the source $(0, 0)$ to (x, y) is $d = |x| + |y|$. The distance from (x, y) to the destination (x_d, y_d) is $d' = |x - x_d| + |y - y_d|$. The total distance is $d + d'$. The grid is $0 \leq x < 62$ and $0 \leq y < 62$. The source is at $(0, 0)$ and the destination is at $(61, 61)$. The grid is divided into four quadrants by $x = 31$ and $y = 31$. The red shaded area is the region where $x \geq 31$ and $y \geq 31$. The blue shaded area is the region where $x < 31$ and $y < 31$.

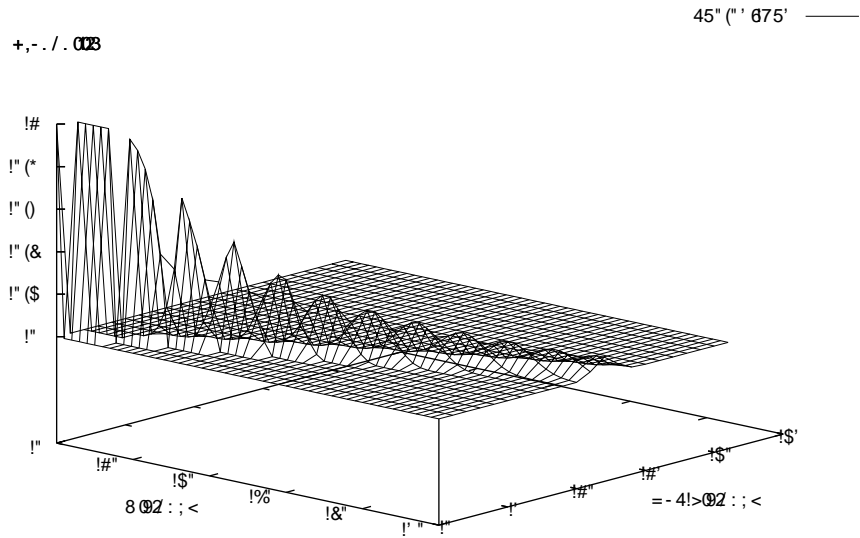

" # \$ % & () * & , - , # # 0 $\mathbb{P}(N_{(d,T)} = n) 1$

!"

!"##\$%&'()*+,-./

#&%(*% ' -'). # * 01(2*0340 &0*5 003 * 0 2%6\$40 ' 3. * 0. 02*(3' *%878(96\$0 : 2/ % 2 E[N_d] . 0#03. (39 %8 * 0 064)(. (' 3 . (2* 340 d ,%\$ ' 3% 0 #020340 #&%(*% 0.05 ' 3. ' *\$ 32; (22(% \$ 390 % 57 < 0\$0 '9' (3=* 0 ,634*(%8)%8>2)(>0 ' 2*0# ,634*(%8 ,%\$ 2/ %8*- ')602 % $\frac{d}{T}$ ' 3. ?6(4>)+ &04% 02)(30' \$ ' 2 d (34\$0' 2027 @; ()' \$)+ *% * 0 !A(; 032(%8') 4' 20=5 0 3%8 0-')6' * 0 * 0 ; 0' 3 #&0\$022(%8 % ' /%# %8 * 0 (x,y) ' 1(2=+)/ E[r] ' 2. 0B30. (3 204*(%8 " T=(3 %\$ 0\$ *% . 0. 640 * 0 / %# . (2* 340 ' 44%\$ (39 *% * 0 / +%#8 02(2. %80 (3 #&#%2(%8 !7

!# \$ %& () * * +, +%-.) ' /) + 0 (%#12 3.-4+%0/5) 3%

D %\$ 0\$ *%02%; ' 0 * 0 #&%(*% # * 01(2*0340 ' 3. * 0 ; 0' 3 #&0\$022(%8 % ' /%# (3 * 0 " AE . (24\$0' 04' 20=5 0 &6). ' F ' \$-% 4/ ' (3 2; ()' \$ *% * 0 !AE . (24\$0' 04' 207G 04%82. 0\$' F ' \$-% H/ ' (3 % * 5 %\$ 3. % - '\$' &02 (e_n, k_n)_{n \ge 0} 7e_n (2 * 0 / %\$1 %8 *). (. , 0\$0340 &0*5 003 * 0 \$. (%\$ 390 J ' 3. * 0 #&0\$022(%8 % * 0 n^{th} / %# ' 2 ()62*\$ 0. (3 8(96\$0 K7 k_n 4%\$02#%8. 2 *% * 0 - 0\$(4'))%4' *%8 % * 0 46\$03*3% 0 , *0\$ n / %#27

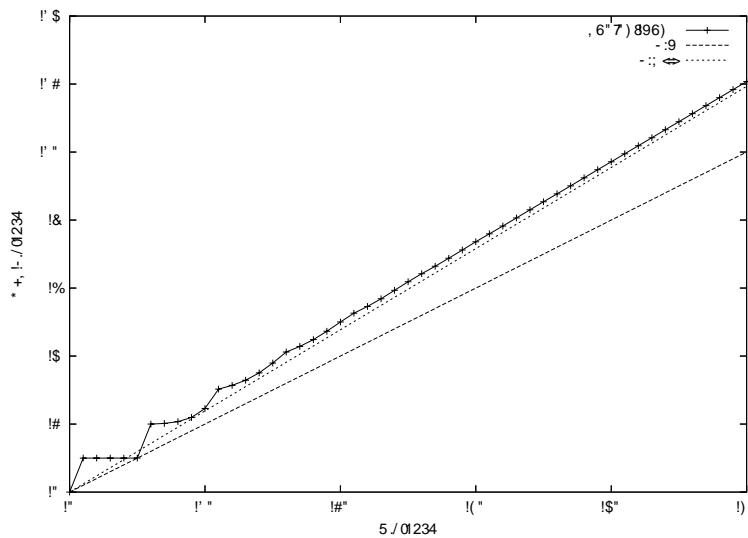

$$8(96$0 : LH\% \# \$2\%8 \&0*5 003 E[N_d]=\frac{d}{T} ' 3. \frac{d}{E[r]} (3 2A(; 032(%8') 30*5 \%>27$$

D %\$ 0\$ *%>00# * 0 F ' \$-% 4/ ' (3 *\$ 4* &0=5 0 26##%20 * ' * * 0 #&0\$022(%8 % * 0 n^{th} / %# r_n ; 62* 01400. e_{n-1} 7 J / 0 36; &0\$ % #%22(%80)%4' *%8 , %\$ * 0 301* / %# (2 * 03 \$0. 640. 5 (* \$09' \$ *% * 0 %8(3') ; % 0)7 M6* =63. 0\$ * (2 ' 226; #*(%8=* 0 36; &0\$ % #%22(%80)%4' *%82 ' * * 0 n^{th} / %#

#%&# (&* (&e_{n-1} +&# ,-\$. +/0(1 2-+3&(e_n, k_n) 2+&4\$ #317#\$# 3&(,5 (3&#%&#&#&# 6 +/0(1 2-+3&7 8-\$ 9/ , (& (e_n)_{n≥0}: 5 3) - \$)% ; ' , (#\$/2/34\$,-\$ - (/3< (&+)% (= '\$ ' 3 & (>+ - (% +&# (k_n)_{n≥0}: 2+&- \$)% ; ' , (' ; ; #* - (5 >+ / ,-\$ %&+ , 3 > (. ,-\$)3& \$ 3&3&= ,-\$ ' (; /2\$ +&# ,-\$ /\$231\$/7 8-\$ ' ; ; #* (>(k_n)_{n≥0} 3 %\$' & \$ \$ # &' \$2, 3 & @ '7

! "#\$%&' (2 + 34*)\$ 1, 0)#, + (, 1-5 # "678)91, + , #*1 / "101, ' 1 / "#: +:)0-; p +, * + "+, 81 T7

$$\mathbb{E}[e] = C \left[\frac{T(T-1)}{2} (-1)^T (1-p)^{(2T+1)T} + \frac{(-1)^{T-1}}{(1-(1-p)^{2T+1})^2} \left((1-p)^{2T+1} - (1-p)^{(2T+1)T} \right) \right]$$

5) <

$$C = \frac{1 - (1-p)^{2T+1}}{A + B}$$

+, *

$$A = T(-1)^T (1 - (1-p)^{2T+1})(1-p)^{(2T+1)T}$$

+, *

$$B = (-1)^{T-1} \left(1 - (1-p)^{(2T+1)T} \right)$$

+, *

$$\mathbb{E}[r] = T - \mathbb{E}[e]$$

ABCCDEA)\$+' / \$/\$/ , (+0%&# F G7

□

)* #0%# + \$*(H&D3; / \$ I: 5 \$ '\$\$, - +, -\$)3& \$ \frac{d}{\mathbb{E}[r]} = 31\$' + 1\$/ * = ((# +0% (F3 +, 3 & (> ,-\$. \$ +& - (% #3 , +&2\$78- \$/\$ 3 ? , + & \$=) 2, 34) \$ 2 (& , +& '\$%&+ , 3&= ,-\$, 5 (2; /1\$' #; \$, (,-\$ 9/ , - (%7J ' > / ,-\$! #3 \$ & 3 &+) 2+ '\$: % (% ' 3 3 & ! 3 1\$/ 3 # +&# \mathbb{E}[r] 3 = 31& ; ' 3&= + 2) ('\$# > / . ;) +7

/ (0 1 # % 2- 33\$ 2- + \$*

H&, - 3 '\$2, 3 & 5 \$ 2(. % , \$,-\$ ' , +, 3 & & / % (4+433* (>+ . +/0(1 2-+3& k_n 5 - 32- # '\$' 2/34\$' ,-\$ 1\$/ , 2+) #3 , +&2\$ 4\$, 5 \$\$\$,-\$ & # \$ (> ,-\$ nth - (% +&# ,-\$)3& \$ 3&3&= ,-\$ ' (; /2\$ +&# ,-\$ # '\$, 3&+ , 3 & 7 8-\$, / +& 3 3 & % (4+4333\$' +/\$ \$+' 3)* # \$ # ; 2\$ # > (. ,-\$ = \$ (= + % 3 / (; , 3&= +) = (/3- . 7L \$ - +1\$,-\$

!"

!"##\$%&'()*+,-./:;<=>@A

##\$%&'()*+,-./:;<=>@A
 ##\$+i > T, (2 - T ≥ k ≤ T,

$$P_{i,i-k} = \mathbb{P}(k_{n+1} = i - k | k_n = i) = \frac{1}{C_i} p(1-p)^{T+k} \quad \&'*3 \quad C_i = \sum_{k=-T}^T p(1-p)^{T+k}$$

, (2 ##\$+i ≤ T

$$P_{i,j} = \frac{1}{C_i} (1-p)^{2j-1} (1 - (1-p)^2) \quad \&'*3 \quad 0 < j \leq T - i$$

$$P_{i,j} = \frac{1}{C_i} p(1-p)^{j+T-i} \quad \&'*3 \quad T - i < j \leq T + i, \quad (2 \quad P_{i,0} = \frac{1}{C_i} p$$

$$\&'*3 \quad C_i = \sum_{j=1}^{T-i} (1-p)^{2j-1} (1 - (1-p)^2) + \sum_{j=T-i+1}^{T+i} p(1-p)^{j+T-i} + p$$

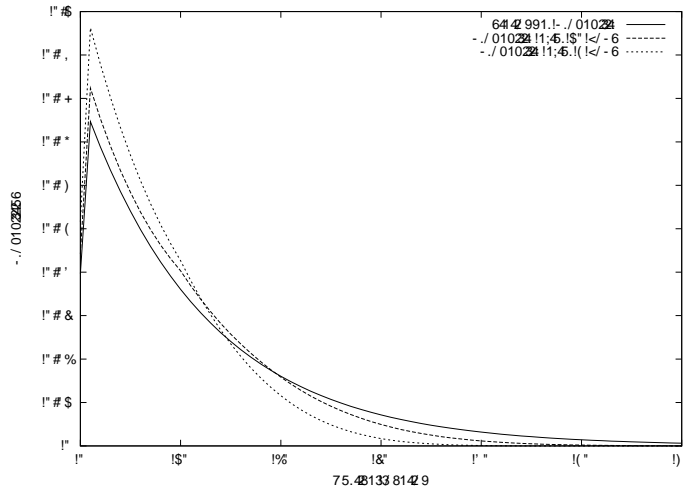

4') 5+0 617*, *\$((, +. +\$/ / '%8 \$ # k_n 92' - *2 / 5 *\$(\$ # v_5, (2 k_10 # \$ + p = 0.039659 T = 10:

; 30 - *, *\$((, +. +\$/ / '%8 <, 8 / 0 - 00 (, - *30 2' - *2 / 5 *\$(\$ # *30 = 0 + * >, %0 >, *\$(, # 0 +, (' (? (' *0
 (5 < / 0 + \$ # 3\$. - : @5 *9' (+0, %&' + 0% - < 5% 3\$. (0 * & \$ + A *30 (5 < / 0 + \$ # 3\$. - ' - % < *02, (2 \$ # 0
 - <, %%; 30 + 0 # \$ + 09 *30 '(*% % >, *\$(k_0 B_k_0 = 0 '(\$ + >, - 0 C3, - , (' < . \$ + *, (*' (D50 (> 09 - '(> 0 *30
 E, + \$ = > 3, '(k_n ' - . 0 + * (0 * \$(% # \$ + - <, % =, % 0 \$ # n: R 4') 5 + 0 6 & 0 > \$ < . , + 0 *30 - *, *\$((, +
 . +\$/ / '%8 \$ # *30 > 3, '(k_n, (2 *30 2' - *2 / 5 *\$(\$ # k_5, (2 k_10 # \$ +, . +\$/ / '%8 p = 0.03965: p 3, -
 / 0 > 3 \$ - 0 (- 5 > 3 *3, *30 + 0 G - *, . , *3 \$ # % () *3 10 & *3 . +\$/ / '%8 0.99 B3' - =, % 0 \$ # p ' - \$ / *, '(02

#\$ %&()*+, -) (/0% 2 3456 7 ')#/' *8' %& %& 9*)#.#1% % # 0-)' % 0 1 : * . %* . / %& 2, + # *) (& 9/ 1 / + . - ; < & 2 %& - ' 2 : %&) (%& 9 . %& 120* . / ' / %& 9*)#.#1% % # 0-)' % %& . = > ' 0* . / ' / , 2% - 1% . 0& / %& . / \$ + 9% % 0 > 1% % # , % 24 ? & / % % 22 . * 9*)#.#1% 1 %& / . 9' // 1 1 % 0 > 1% % # , % 2) (k_n @ P(k_infinity <= k) <= P(k_n <= k) for all n > 04

A. % 1 (%& - ' 2 : %&) (%& 9 . %& 120* . / ' / ; %& 9*)#.#1%) (%& ' = 1% 20') (%& 9 . %& > ' 0* . / ' / 4 7 ' %& 12B %& % 1% / 2) % 8' * \$ 9' * % 12' 2% % 0) 2 / 1 ' * > 1% % # , % 2) (%& 8' * % 10 . - -) 0 . % 2 () * % C 0 % * \$ < & 10 & ' = 1% < 1% & . 8' * \$ / + . - 9*)#.#1% / 4 ? & * () * < ' / % > \$ %& > 1% % # , % 2) (%& * . 2 >) + 8 . * 1 # ' k_n . / %& -) 2 : ' *) (%& 9 . %& n 120* . / ' / . 2 > () * . D = ' > 9*)#.#1%) (' = 1% 20') (%& 9 . %& 4 E) * ' . & 8 . - , ') (n ; < ' 0) + 9 , % %& 9*)#.#1%) () 00 , 9 . 20 \$ p_n / , 0 & %& %& * ' = 1% . 9 . %&) (/ F n < 1% 9*)#.#1% 0.994 ? & 2 ; < ' 0) + 9 , % %& 9*)#.#1% %& % k_n # ' -) 2 : / % [- T , T] ; # ' -) 2 : / % [- 2 T , - T [U] T , 2 T] . 2 > # ' -) 2 : / % [- 2 T , 2 T] 4 ? & / ' 9*)#.#1% / + . \$ # ' 12% * 9* % > . / %& 9*)#.#1% / %& % k_n 1 > 1% 2%) (1 & 9 / ; %) & 9 / . 2 > > 1% 2%) (- / / %& 2 G & 9 / (+) + 04 H E I , * I ; < ' 9 -) % > %& / ' 9*)#.#1% / 4 J / < ' 0.2 / ' ' %& 9*)#.#1% % # ' -) 2 : / % [- 2 T , 2 T] 8 . \$ (+) 0.93 % 0.824 K) > /) (%& 9 . %& & 8' %&) * 1 12 12 %& 1* * . > 1) * . 2 : ' U_n in [T , T] 6 < 1% 9*)#.#1% 8 . \$ 12 : (+) 0.6 % 0.74 ? & 9 . %& 1 / %& / . < . \$ / 0 -) / ' % %& %& . = ' Q 12 : %& /) , * 0' . 2 > %& > / % 12 . % 24 H / 12 % * / % 12 : % + ' 2 % 2 % & 12 . D % % 1 + ' %& / 9*)#.#1% > ' 0* . / ' / < 1% & %& - ' 2 : %&) (%& 9 . %& @) * * . - \$ / + . - 9 . %& %& % C 0 % * \$ 1 %) / & % % % % B' . < . \$ (+) %& . = ' 4 H . / ' 0) 2 > % + ' ; () * . 2 , + # *) (& 9 / : * . % * % 2 50 ; %& / 9*)#.#1% 120* . / ' / @) * * . - \$ -) 2 : 9 . %& %& 9*)#.#1% p_n # ' 0) + ' 1 + 9) * % 2 % 12 / , 0 & . < . \$ %& * ' = 1% 12) > / 12 %& 2' 1 & #) * &) > < & 10 & : ' % %& % C 0 % * \$ 0 -) / ' * % %&) * 1 12 4 ? & * () * ; < & 2 1% = 1% . 9 . %& %& * 1 / . & & 9*)#.#1% %& %& % C 0 % * \$ / % \$ * . - \$ 0 -) / ' % %& . = ' Q 12 : %& /) , * 0' . 2 > %& > / % 12 . % 24

! " # \$ % & (') * + & \$ - + .) / # 0 % (#) . + . \$ +) ' \$

? & * . * . % ' . / % & * ' 12 % * / % 12 / % > 12 : > 10 * % 2' %) * B' . / . 99*) = 1 + . % 2 /) (0) 2 % 12 , /) 2' / 4 ? & D % % 2' 1 / %& % 1% /) (% 2 ' . / F * % / % > \$ 9*) 9' * % / 12 . D 12 % > 10 * % ' 28 % 2 + ' 2 % & 2 12 . 2 12 D 12 % 0) 2 % 12 , /) 2' 4 ? & / ' 0) 2 >) 2' 1 / %& % / , * 9* 12 : - \$; > 10 * % 2' %) * B' & 8' /) + ' 9*) 9' * % / %& % + . \$ # ' +) * * . - 1% 0 % 2 0) 2 % 12 , /) 2' / 4 E) * * . + 9 - ; MIN & / / & < 2 % & % & 2) > ' > : * ' 12 . OP Q J * . > 1) 2' %) * B 1 / #) , 2 > > 4 H / %& 0 . / ' 12 > 10 * % 2' %) * B' < & * . / 12 0) 2 % 12 , /) 2' / ; 2) > / & 8' . 2 , 2 #) , 2 > > > : * ' 4 ? & % 1 >) 2' 1 / %& % / < ' / & < 12 %& / ' 0 % 2 ; * / , - % 12 %& > 10 * % +) > ' - + . \$ 12 > , 0' #) , 2 > . * F / 12 %& 0) 2 % 12 , / <) * > 4

7 ' 0) 2 / 1 ' * S in N* . 2 > 0 . - D_S : Omega_n -> Gamma(n,S) %& / + 9 - 12 :) (Omega_n 12 Gamma(n,S) > ' D 2 ' > . / () -) < / @

$$D_S(\omega)(i_1, \dots, i_n) = \begin{cases} 1 & \text{if } \omega \cap \prod_{k=1}^n [\frac{i_k-1}{S}, \frac{i_k}{S}] \neq \emptyset \\ 0 & \text{otherwise} \end{cases}$$

1 2 ' + & 3 4 5 2 1 ' # , 0) * 1 " lambda in R + * 3 n in N * 3 S in N * 4 2 1 + (0 # ' # , 0) * 1 " - 5 " 11 & ' -) # , 0 V_c : Omega_n -> R + , * V_d^1 , V_d^2 : Gamma(n,S) -> R 0 & 5 - 5 + # " + ((omega in Omega_n 37 1 5 + 81 V_d^1 o D_S(omega) <= V_c(omega) <= V_d^2 o D_S(omega) 4 V_c) 0 + " + , * # \$ 8 + ") + 9 (1) , - 5 1 / " # 9 + 9) 0 0 -) 0 ' + ' 1 (Omega_n , Q , P_lambda) + , * V_d^1 , V_d^2 + " 1 " + , * # \$ 8 + ") + 9 (10) , (Gamma(n,S) , Q' , P_p_lambda) 7 5 1 " 1 p_lambda = 1 - exp(- lambda / S_n) 4 : 5 1 , 37 1 5 + 8 1 ;

$$E[V_d^1] \leq E[V_c] \leq E[V_d^2]$$

!"

!"##\$%&'()*+,-./

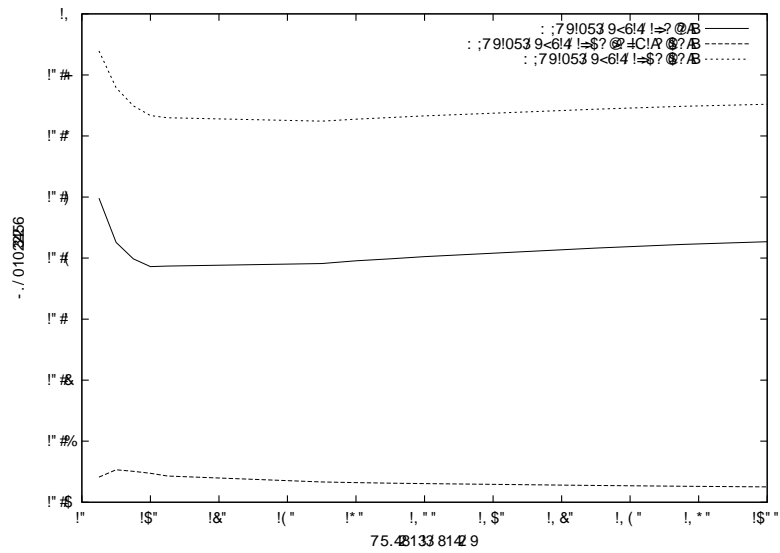

#%&()*+,-.-\$01 2.0 $k_n \in [-T, T]$ $3k_n \in [-2T, -T]$ $U[T, 2T]$.45 $k_n \in [-2T, 2T]$ 67 $n . 45$
6 \$2 . 8', -.-\$01 , 9, :: &8.4: 1 ;& 2 0.02(' (<\$ 0. 8. 0 6 \$2 8', -.-\$01 0.997T = 107

=> ? =@

##%%&'#()*+,)-,./ *00)1234 5 6

□

!"#\$%&'#()*+ 783+.8)/,)9 :3)+<+* =,+ <+>-<./ /(-, .8) +<2>/- ?/ 1.3l</<+ :,*08+0,/0@
),.3)' ,)<(+3l ?/ 1.3l</<+ :,*08+*12 3l 0*,.3?<(*, .8) 9)*1 ;*(<)/- * ,*12/9 ;*,3*A) ?*1 A)
A<12)2 A>,)<(+?/9 0<)2 3l 23?.,) :,*08+*12 3l 0*,.3?<(*, .8) 9)*1 ;*(<+/-)B<3 *0)1. ,*1@
2/9 ;*,3*A)+6 C+*1 *00(3?*.3 1/- .83+.8)/,)9 D3l +)?*3 1 "DE) E3(+<2>.8) (*E /- .8) 8/0
23+.1?) 3l ?/ 1.3l</<+1).E/,F+6

+ , %&- . (/0\$%\$ "\$#1)%2/ # 0) "#('3) 3/) "\$/

G +)?*3 1 H*12 +)?*3 1 I DE) 8*;) ?/9 0<.)2 P(Nd = n)D8+9)*1 ;*(<)*12 .8) *; ,*) 0,/:)+3 1
/- *8/0 3l 23?.,) 1).E/,F+6C +3 3*, +<2>3+.,*?*A) 3l ?/ 1.3l</<+1)+A<. 9 /,) ?/9 00)4 JKD'L6
M/ ,/; ,) ,.8) ?/ 1.3l</<+?*+) A) ?/9 +; ,>?/9 0(3?*.)2 3l n@3) 1+3 1+E38 n ≥ 2 JKL*12 .8*. 3+
E8>E) 0,)-, ./ <+ ,)<(+?/9 0<.)2 3l *23?.,))1; 3/19)1. ./ :).8), E38 .8)/,)9 H./ 2)2<?)
A<12*,3+1 P(Nd = n) 3l ?/ 1.3l</<+1).E/,F+6

G +)?*3 1+H*12 IDE) 8*;) 2)=1)2 .8) ,*12/9 ;*,3*A)+N(d,T) -/, 23) 1+3 1+1 *12 26 N)
:)1),*(3) .83+2)=133 1 ./ .8) n@3) 1+3 1 0,/A*A3+3? +0*?) (Γ(n,S), Q', Pp) 6 N) ?*1 *(+
)4.)12 .83+<1?3 1+ -*9 3> / .8) ?/ 1.3l</<+?*+) E38 .8) 2)=133 1 /- N(d,T) 3l (Ωn, Q, Pλ)6
N(d,T) 3+.8) ,*12/9 ;*,3*A) A)3l:)B<*(./ .8) 8/0 23+.1?) /- .E/ 1/2)+xDy +<?8 .8*. |x, y| = d
3l Ωn E38 *.,*1+9 3+3 1 ,*1:))B<*(./ T6

45\$)%\$- 6* !#" +, 2 n3*)\$ 1, 0#, +(0' + '145)61, T, d ∈]0, 1]4λ ∈ ℝ++ +, * S ∈ ℕ*47 1 0I-
TS = [T.S]4dS = [d.S]89 1 #: +,), (Γ(n,S), Q', Ppλ) +, * (Ωn, Q, Pλ);

E[N(dS,TS+1)] ≤ E[N(d,T)] ≤ E[N(dS,TS)]

##%%&'#()*+,)-,./ *00)1234 P 6

□

!"#\$%&'#()*+ 783+.8)/,)9 3l23?*)+.8* :3)1 .8) *00,/0,3*.) ,*1+/,9 *3 1D8) *; ,*) 8/0
23+.1?) 3l * -*9 3> /- ?/ 1.3l</<+1).E/,F+ 3+ A<12)2 A>.8) *; ,*) 8/0 23+.1?) 3l .E/ ?(/ +)
23?.,) 1).E/,F -*9 33)+6 C+*1)40),3) 1.*(; ,3-*3 1/- .83+.8)/,)9 3l .8) Q@3) 1+3 1 ?*+)D
=: <,) R3(<+,*)+.8) *1*(>.3?*(; *(<+/- E[N(dS,TS)]DE[N(dS,TS+1)] ?/9 0<.)2 <+3l: .8) -/,9 <(*)
:3)1 3l +)?*3 1 I6 *12)40),3) 1.*(; *(<+/- E[N(d,T)] -/, T = 0.2Dλ = 129 *12 S = 506
78) *1*(>.3?*(,)<(+?/9 0<.)2 3l 23?.,) 1).E/,F+?0*(> A3l2 .8) +3 <(*)2 /1)+3l ?/ 1.3l</<+
1).E/,F+6

45\$)%\$- 7* !#" +, 2 n3*)\$ 1, 0#, +(0' + '145)61, T, d ∈]0, 1]4λ ∈ ℝ* +, * S ∈ ℕ*47 1 0I- TS =
[T.S]4dS = [d.S]89 1 <+61), (Γ(n,S), Q', Ppλ) +, * (Ωn, Q, Pλ);

lim S->∞ N(dS,TS) = N(d,T)

!"

!"##\$%&'()*+,-./0123456789:;<=>?@

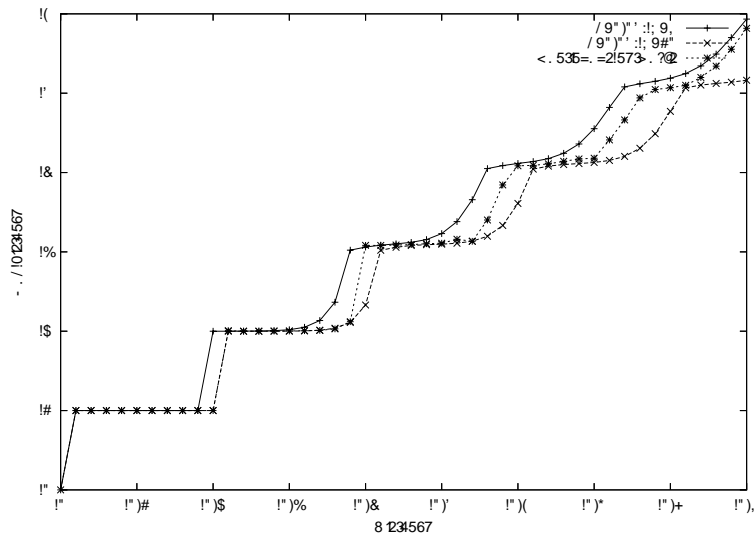

#\$%&'()*+,-./0 $\mathbb{E}[N_{(d,9)}]$ $\mathbb{E}[N_{(d,10)}]$, 23 $\bar{N}_{(d,0.2)}$ θ' , 2/3(4'/5(.. $\lambda = 1291$,
6,2.8\$. \$ 2',% $T = 0.2$, 23, 3\$5'($\alpha = 4/0 \frac{1}{50} 9$

:: <:=

\$ % & ' # () * + , -) , / * 00 1234 5 6

□

!"#\$%&'()* " 783+.8)/,)9 :3)+<+* (*+ <+)-<(./ (./ +<2=>1.3l</<+1).?/, @6 A ?) *,)
*B) ./ 0,/; 2) * >(+)2 -/, 9 <(* -/, .8) 9) *1 8/0 23+*1> 3l 23+>.) 1).?/, @C* ? / , @.8* . ?)
8*;) ,)*(3)2 3l +>.3 1 E *12 +>.3 1 FC?) >*1) *+3(=2)2<> .8) 9) *1 8/0 23+*1> 3l >1.3l</<+
1).?/, @*+* (3 3 / - .8) 23+>.) >*+6783+? / , @3+2/ 1) 3l .8) -/(/? 3l: +>.3 16

A 3+3l.), +3l: ./ 1/ .3> .8* .8)/,)9 F *12 .8)/,)9 G9 *=B) *00(3)2 ./ / .8) , , *12/9 ; * , 3*B) +
.8*1 .8) 8/0 23+*1> B).?) 1 .? / 1/2)+6

+ , &&(. ' #() " #) # \$ /) &0(1# " . \$

A l .83+>.>.3 1C?) *00(= .8) .8)/,) .3*(,) <(+ / - +) >.3 1 G *12 +>.3 1 H. / .8) +<23+ / - +) >.3 1 E
*12 +>.3 1 F 3l 23+>.) : , *08+3l / , 2), ./ 2)2<> >(+)2 -/, 9 <(*+3l .8) >*+ / - >1.3l</<+ : , *08+6

+*2 34l/ ('5 # \$ -(6 (#(" 278 (6 \$'10 "' - .))"#"4) 41 "\$#))%1

I)>.3 1 E 0,) +1. + * >(+)2 -/, 9 <(* -/, E[r] 3l .8) ! K 2 9) 1+3 1*(23+>.) >*+6L) *,) 3l.),) +)2
3l .83+ / - , 9 <(* ? 8) 1 S -> infinity 6 A 2) 2C.8)/,)9 G +*+=.8* . 3 +8/ <2 0*2 <+ / * - / , 9 <(* 3l .8)
>1.3l</<+? / , (26M+S -> infinity C_s^1 -> 0 *12 ?) >*1 <+ + 9) (3 3)2 2);) / 09) 1.+

p = 1 - e^{-lambda/S} = 1 - (1 - lambda/S + o(1/S)) = lambda/S + o(1/S)

; / \$) %6 <* 2 + 34)\$ 1, 0#, +(, 1-5 # "678)91, + - " +, 0\$)00#, " +, 81 T in [0, 1] +, * +, #*1 *1, 0:-
lambda 75 1 ; +91

E[r] = (T - 1/lambda - e^{-lambda T} (lambda T^2 / 2 - 1/lambda)) / (1 - e^{-lambda T} (lambda T + 1))

\$ % & ' L) 3l., / 2<> .8) (3 3)2 2);) / 09) 1. / - p_lambda 3l .8) - / , 9 <(* / - +) >.3 1 F 6

□

!"#\$%&'()* " 78)/,)9 H0,) +1. + * >(+)2 -/, 9 <(* -/, .8) *,) , * .) 8/0 0, / : ,) +3 1 / - * +8 / , .) +
0* .8 3l * ! K 2 9) 1+3 1*(>1.3l</<+1).? / , @ 7 / : .8) , ? 38 0, / 0/ +3 3 1 ! C 3 () *2 + / * ; , = : // 2
*00, / 43 * .3 1 / - .8) 9) *1 8/0 23+*1> 3l +<8 1).? / , @6 & 3 < ,) ! N > 9 0*,) + .8) ; * (< / - E[r]
: 3) 1 B = .83+ / - , 9 <(* ? 38 .8) / 1) . * @ 1 - / , 9 +3 <(* .3 1 + C T = 0.05 C 100000 3), * .3 1 + R 6 M + ?) >*1
+) C + 3 <(* .3 1 + *12 *1*(= .3*(,) <(+ *,) + 3 3 , 6

!"

!"##\$%&'()*+,-./:;<=>?@

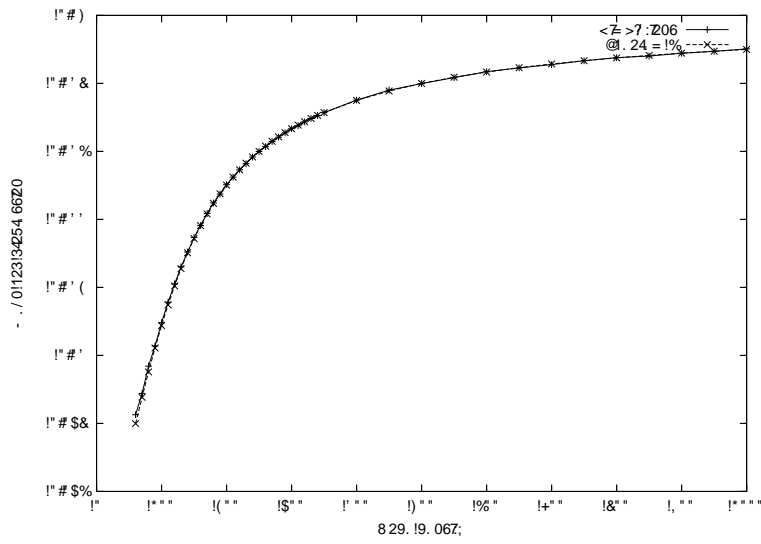

#%&()"+(, - ./0123456789:;<=>?@

4 () 5\$ (- 1\$ -, 72, 1(:T = 0.05;<

⇒ ? =@

!"# \$%&()* +, -.(+0 #/0 (. ,) &1) 2- 31) +0 %1%& , +4 156&

#%\$&()*+, -, /0, 1&. , 3 4(%- & 24. , 1/\$25 67 4(E[r] /28, /0, (+ \$0 ' & %\$, 3 3, 9, &: %, 5/ \$5 /0, !; 3%, 5. \$25' &1'., <

$$p = 1 - e^{-\frac{\lambda}{S^2}} = 1 - \left(1 - \frac{\lambda}{S^2} + o\left(\frac{1}{S^2}\right)\right) = \frac{\lambda}{S^2} + o\left(\frac{1}{S^2}\right)$$

7', 15. !" 2 + 34*\$ 1, 0#, (+, 1-5#"678)91, +-"+, 0\$)00)#, "+, 81 T ∈ [0, 1] +, *+, #*1 *1, 0)-: λ75 1; +91

$$E[r] = \frac{T - \frac{1}{2\lambda T} - e^{-2\lambda T^2}(\lambda T^3 - \frac{1}{2\lambda T})}{1 - e^{-2\lambda T^2}(2\lambda T^2 + 1)}$$

=>?? @<A, \$/(23- 1, /0, & %\$, 3 3, 9, &: %, 5/ 24pλ \$ /0, 4(%- & 24. , 1/\$25 67 7 □

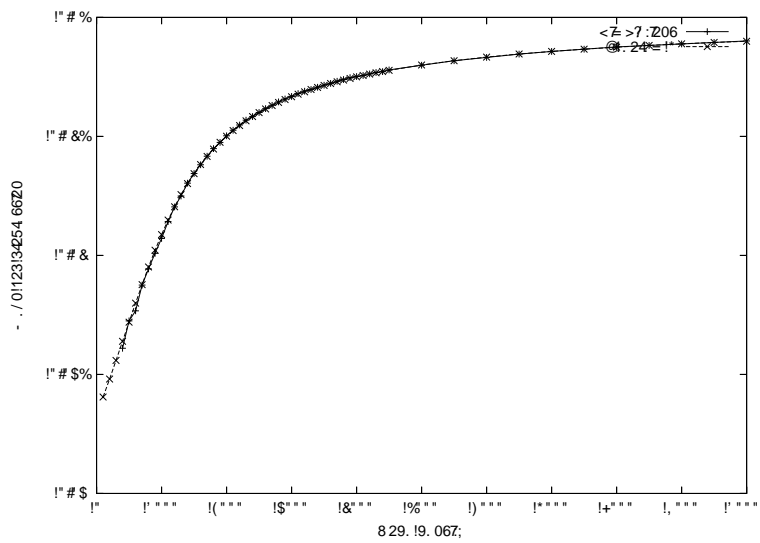

@8- (, ""<B, '5 02: : (28(...\$25 12%: -/, 3 4(2% . \$%- &/\$25. ' 53 4(2% /0, 4(%- & 24/0, 2(, % C\$5 /0, !; 3%, 5. \$25' &1'., T = 0.05E7

8) + 595, +2+(1) " F0, 2(, % C: (, ., 5/. ' 1&. , 3 4(%- & 4(/0, '9, (' 8, 02: : (28(...\$25 24' : ' /0 G \$& - . \$58 /0, : (, ., 5/, 3 8(, , 3) 8, 28(' : 0\$! ' &2(\$0% \$ \$!; 3%, 5. \$25' &125/\$5- 2-. 5, /+ 2(H ' 53 + \$0 ')

!!

! "##\$%&'()*#&,*)"-.

"#\$%& &()*+*, ' &. "\$%&'01"/*&23' 45(6'-'-)*-%89' +*6 : %& 23' % %& 2+&7, %&' " 9)23 23'
*-' " *<23-' (/&6 ")6 \$7&*- "0 =>": &""-2()->. \$& 44 ?T = 0.058100000)2 &2*- "@ A' &
% %&-8")6 \$7&*- ", %&(%& *\$&23' *&6 0

! " # \$ % & () # \$

= 23)" %&+7 89' 3%' "3*9 - 23&23' "23(; */ (")+&2 - '2 *8B')" %. ** (% : &%3 / * &23' "23(
/ + - 2- \$*\$" * - "0 C)&22* .), ' <\$- (%&' " * - 23' : &: ' 23' " */ +* - 2- \$*\$" - '2 *8B' % (" ' +* - (
2* (' &' +7*"" (/ * & \$7%) - +* - 2- \$*\$" - '2 *8B' 9 3' - : \$3)-. () +&2 & "\$72' 2* 23' 76) D D'
3% ' / * & % 7% : &, ' (23)" % : &%30 1 " % () & +2 % : 7+&2* - * / * \$ & % % & ") " 89' 3% ' : &"" - 2 (%
"23(; */ 23' 3* : () "2% + ' < 23' - 23' * - * (" 0 E%) (* - & "\$72' +*6 : \$2 (\$) - . F %8B*, +3% -) -
() +&2 - '2 *8B' 89' 3% ' .), ' - +7*"" (/ * & \$7% 2* % : & G 6 % 2 23' 6 ' % 3* : () "2% + ' < 23' -
23' * - * (') - 45(6'-'-)*-%89' (! 5(6'-'-)*-%89' (* 6 ' 23+ . & 3" 0 H3' "" . & 3" % & 7& 7.
\$"" (2* 6 * (' 7I' 6 \$72 3* : " 9) & 7 "" - '2 *8B' "\$+3 %' % 3+ * &"" - "" & - '2 *8B' 0 H3)" % : &%3
)" */ +* \$&' - * 2 < \$- (2* 23' "23(; */ 23' 3* : () "2% + ' % (+* \$7 7% * < ' % : 7) (2* "23(; * 23' &
: &: ' 23' " */ +* - 2- \$*\$" . & 3" 0

C* & % 7I % 2* - * / E [N_d] 6 % < ' & % 7;) - 2 & " 2- . / * & % 7& ' - \$ 6 < & * / * : 26 I % 2* - : & < 7 6 "
% 9 ' 77 % / * & 23' "23(; */ . ' * . & 3) + & \$ 2- . % 7. * 8236 : ' & * & % + ' 0 1 7& ' - \$ 6 < & * / % & +7 "
?) / 0 / J4K84LM* - ") (' & 23 % 2 E [N_d] = d / T 9 3) + 3 3% < ' - "3*9 -) - 23)" % & +7 2* < ') - % + \$ & 2 0 N \$ &
& "\$72' 9) 77 % 7* 9 2* & > - ' % + ' 23- - \$ 6 < & * / "23() "" "\$+3 % 8 / * & 7 8 23' * : 26 % 7 & . ' / * &
. ' * . & 3) + & \$ 2- . 9 3' - +* - ") (' & . 23' - ' & ; +* - "\$6 : 2* - J4KM

* +, + - \$ % (

J4MCOE%+ 7)8F 007) - 8F 0P' < * \$ & ' " 8% (QOR\$; , 0 Q2* + 3% 2) + . ' * 6 ' 2& % (% & 3) 2 + 2& * /
+ * 6 6 \$ -) + 2* - - ' 23' * 8B' 0 1 / 2) 3 \$ 4 4 " % 356 \$ % 7. # 6 4 # 8ST UVW! S84VWS0

J! MCOE%+ 7)800H+3* \$ 6 % 2+3' - B* 8% (QOR\$; , 0 F % 8B' : % 23' * - 23' X*) "" - 5Y' 7& - % . & 3
9) 23 % : 7+&2* - " 2* & \$ 2- .) - 6 * < 7 - ' 23' * 8B' 0 89 : / 8 ; ; * < - \$ = 5 = 8K! 7 4 @ W Z 8! UUU

JKMCOE%+ 7) % (QOR\$; , 0 Q2* + 3% 2) + . ' * 6 ' 2& 6 * (' 7' * / 6 * < 7 + * 6 6 \$ -) + 2* - - ' 23' * 8B' 0 =
, - \$ % 6) - # % >) ") + 0 8 : % ' " !! SW [K0 \] \ X & "" 8E * + %] % 2* - 8CP84VWS0

J [M \ 0E' 2' 2 2 2 2 N - 23' 6) -) 6 \$ 6 - * (' . & ' % (+* - - ' + 2) 2 * / % 9) & 7 "" 6 \$ 72 3* : - ' 23' * 8B'
= 8' ? ? \$ = @ \$ 3 ABC 8 P % \$ I % - ' 8 Q 9) 1' & % (8 ^ \$ - ' ! U U 0

JLME 0 E ! % I + ; " I ; - % (] 0 Q + 3 * 2 D 1 : : & G 6 % 2 (' + * 6 : *) 2 * - * / " * 6 ' 6 * (\$ 7 2 (5 X *) "" -
_ * & - *) 2 "" 7 7 2 * - " 0 8 9 : / # 8 ; ; * < - \$ = 5 = 8 K L T Z ! 8 ! U K 0

J' M P 0 E 7 1 ,) + 0 7 3 5 * 5 = 2) D \$ " 6 9 0 < - \$ 6 3 \$ # E + (8 ; ; * 3 5 6 \$ # 6 ? \$ = # 6 0 X 3 Y 23') " 8 a + * 7
X * 7 2 + 3 - # \$ ' C b & 7 (' P % " % - ' 8 ! U U 0 H 3') " c * ! L 4 S 0

!"#\$ %&()*+, -# . #/ *)0+, '1

!"

#\$%&'()*+,-./0123456789:;<=>?@ABCDEFGHIJKL

#%&'()*+,-./0123456789:;<=>?@ABCDEFGHIJKL

#%&'()*+,-./0123456789:;<=>?@ABCDEFGHIJKL

#%&'()*+,-./0123456789:;<=>?@ABCDEFGHIJKL

#%&'()*+,-./0123456789:;<=>?@ABCDEFGHIJKL

#%&'()*+,-./0123456789:;<=>?@ABCDEFGHIJKL

#%&'()*+,-./0123456789:;<=>?@ABCDEFGHIJKL

#%&'()*+,-./0123456789:;<=>?@ABCDEFGHIJKL

#%&'()*+,-./0123456789:;<=>?@ABCDEFGHIJKL

! "###\$%&'()*+,-.

/ 0'#\$%1 2- 2 +D*)\$1, 0#, +(, 1-E#"FGHI1, +, #*1 / "101, '1 / "#?+?)0<p+, *+"+, HI TG

$$\mathbb{E}[e] = C \left[\frac{T(T-1)}{2} (p-1)^{Tl} + \frac{(-1)^{T-1}}{p^2} ((1-p) - (1-p)^T (Tp+1-p)) \right]$$

+, *

$$\mathbb{E}[r] = T - \mathbb{E}[e]$$

Ni J J LCL24n ≥ 0., / i ≤ T - 1 6*+ 54, ?52, <423. 37957+. 4+C

$$\mathbb{P}(e_{n+1} = k | e_n = i) = 0 \text{ P}24k > T - i - 1$$

$$\mathbb{P}(e_{n+1} = k | e_n = i) = \frac{p(1-p)^k}{1 - (1-p)^{T-i}}$$

!"

!"###\$%&'()*+,-.

$$e_{n-1} = i^5 \cdot \frac{p}{1 - (1-p)^{T-i}}$$

$$\mathbb{P}(e = i) = \pi_i = C \left[(p-1)^T + (-1)^{(T-1)}(1-p)^i \right]$$

6 & .'

$$C = \frac{p}{Tp(p-1)^T + (-1)^{T-1} (1 - (1-p)^T)}$$

$$r = T - e$$

$$\mathbb{E}[e] = C \left[\frac{T(T-1)}{2} (p-1)^T + \frac{(-1)^{T-1}}{p^2} \left((1-p) - (1-p)^T (Tp + 1 - p) \right) \right]$$

$$\mathbb{E}[r] = T - \mathbb{E}[e]$$

□

!"###\$%&'()*+,-.

$$\mathbb{E}[e] = C \left[\frac{T(T-1)}{2} (-1)^T (1-p)^{(2T+1)T} + \frac{(-1)^{T-1}}{(1 - (1-p)^{2T+1})^2} \left((1-p)^{2T+1} - (1-p)^{(2T+1)T} \right) \right]$$

0%

$$\mathbb{E}[r] = T - \mathbb{E}[e]$$

#DE#F

#\$%%&'()*+*, -./0 12,)13 45 6*7- *6 4 0 45 5*8041- , 5 $T - e$ 9) *:* e 45, ., -61+ ;, :4 <* 9 4) 0* , 5=+ 30108 64504<041- 12 0* ? , :@; 8), 4 (e_n) $_{n \geq 0}$ A B-6*: 0* , 55>+ 3041- 12, 3, 0 *C450*- 8*D0) * 0, -5041- 3:1<, <44#*5 12(e_n) $_{n \geq 0}$, :*

$$\mathbb{P}(e_{n+1} = k | e_n = i) = 0 \quad 2! : k > T - i - 1, -6 k \neq T$$

$$\mathbb{P}(e_{n+1} = k | e_n = i) = \frac{(1 - (1 - p)^{2T+1})(1 - p)^{(2T+1)k}}{1 - (1 - p)^{(T-i)(2T+1)}}$$

2! : $k \leq T - i - 1$ AE 4) $u = (1 - p)^{2T+1}$ D9 * 1 < 0 4

$$\mathbb{P}(e_{n+1} = k | e_n = i) = 0 \quad 2! : k > T - i - 1, -6 k \neq T$$

$$\mathbb{P}(e_{n+1} = k | e_n = i) = \frac{(1 - u)u^k}{1 - u^{T-i}} \quad 2! : k \leq T - i - 1$$

() * 0, -5041- 3:1<, <44#*5, :* 0* 5, +*, 5 0* 1- *5 4 5*8041- FAA() *:* 2! : * 0* 2! : +>, *, <1>0 0* 50 041-- , : 3:1<, <44#*, -6 $\mathbb{E}[e]$ 120 * 5*8041- FA 8, - <* >5*6 9 4) $u = (1 - p)^{2T+1}$ AE * 1 < 0 4 ,

$$\begin{aligned} \mathbb{P}(e = i) &= \pi_i = C \left[(-1)^T (1 - p)^{(2T+1)T} \right. \\ &\quad \left. + (-1)^{(T-1)} (1 - p)^{(2T+1)i} \right] \end{aligned}$$

$$C = \frac{1 - (1 - p)^{2T+1}}{A + B}$$

9 4)

$$A = T(-1)^T (1 - (1 - p)^{2T+1})(1 - p)^{(2T+1)T}$$

, -6

$$B = (-1)^{T-1} \left(1 - (1 - p)^{(2T+1)T} \right)$$

$$\begin{aligned} \mathbb{E}[e] &= C \left[\frac{T(T-1)}{2} (-1)^T (1 - p)^{(2T+1)T} \right. \\ &\quad \left. + \frac{(-1)^{T-1}}{(1 - (1 - p)^{2T+1})^2} \right. \\ &\quad \left. \left((1 - p)^{2T+1} - (1 - p)^{(2T+1)T} \right) \right. \\ &\quad \left. \left(T(1 - (1 - p)^{2T+1}) + (1 - p)^{2T+1} \right) \right] \end{aligned}$$

!"

!"##\$%&'()*+,-.

$$\mathbb{E}[r] = T - \mathbb{E}[e]$$

□

! "\$%&'()*+,-.

\$%&'()*+,-. $D_S : \Omega_n \rightarrow \Gamma_{(n,S)}$ / \$(, 0 1-) 2 & \$\Omega_n\$) $\Gamma_{(n,S)}$ *\$4' \$* , (3&-&5 (6

$$D_S(\omega)(i_1, \dots, i_n) = \begin{cases} 1 & \exists \omega \cap \prod_{k=1}^n [\frac{i_k-1}{S}, \frac{i_k}{S}] \neq \emptyset \\ 0 & \text{&/ \$5} \end{cases}$$

- ' . . / 01 $D_S^{-1}(\gamma) = \{\omega \mid D_S(\omega) = \gamma\}$ # # 2 (\$*) \$" B" 14\$5 / #6) 7 7

$$\forall \gamma \in \Gamma_{(n,S)}, \exists \omega \in \Omega_n, D_S(\omega) = \gamma$$

89: : ; 6 < & 1 + & - \$. /) (\$ ' . \$ ' % > 5 \$ % & () * \$ + \gamma \in \Gamma_{(n,S)} , ' * (/ & 5 . / , . \omega = \{(\frac{i_1}{S}, \dots, \frac{i_n}{S}) \mid \gamma((i_1, \dots, i_n) = 1\} = \$ +) 4 \$ ($D_S(\omega) = \gamma$) \square

$$\# \$ * \$ 4 ' \$ D_S^{-1}(\gamma) = \{\omega \mid D_S(\omega) = \gamma\} 7$$

- ' . . / 21 $\{D_S^{-1}(\gamma) \mid \gamma \in \Gamma_{(n,S)}\}$ # / 7 % 1) 3 / - 11 \$ % \$ 8 \Omega_n 9

89: : ; 6 D_S) (* \$ 4 ' \$ * & - \$ +) . (5 / & \$) ' 1 ? . * & 0 ,) ' , ' * + \$, % \$ () . (5 / & \$ & 2 . 1 ? . * & 0 ,) ' @ \$ \$ - \$ 0 0 , A B 5 /) %) (4 ') . \$ 7 \square

\$ % & () * \$ + \lambda \in \mathbb{R}^{+>n} \in \mathbb{N}^{*} > S \in \mathbb{N}^{*} \# \$, - (& % & () * \$ + . / + \$ \$ 3 ') % & ($V_c : \Omega_n \rightarrow \mathbb{R}$, ' * $V_d^1, V_d^2 : \Gamma_{(n,S)} \rightarrow \mathbb{R}$ (? % . / , . 3 & + , - \omega \in \Omega_n > 5 / , = \$

$$V_d^1(D_S(\omega)) \leq V_c(\omega) \leq V_d^2(D_S(\omega))$$

V_c) (, + ' * & 0 = , +) , C \$) ' . / \$ 1 + & C , C) - (.) % (1 , % \$ (\Omega_n , Q , P_\lambda) , ' * V_d^1, V_d^2 , + \$ + ' * & 0 = , +) , C \$ () ' ($\Gamma_{(n,S)}, Q', P_{p_\lambda}$) 5 / \$ \$ \$ p_\lambda = 1 - \exp(-\frac{\lambda}{S^n}) 7

$$\# \$ * \$ 4 ' . 5 & 3 ') % & (V_{D_S^{-1}}^1, V_{D_S^{-1}}^2 (? % . / , . 6$$

$$V_{D_S^{-1}}^1 : \Omega_n \rightarrow \mathbb{R}$$

$$\omega \mapsto V_d^1 \circ D_S(\omega)$$

, ' *

$$V_{D_S^{-1}}^2 : \Omega_n \rightarrow \mathbb{R}$$

$$\omega \mapsto V_d^2 \circ D_S(\omega)$$

$$V_{D_S^{-1}}^1, ' * V_{D_S^{-1}}^2, + $ + ' * & 0 = , +) , C $ () ' . / $ 1 + & C , C) - (.) % (1 , % $ (\Omega_n , Q , P_\lambda) 7$$

!"# \$ %&'(2)31, -41 / "13)#&0*15,)-)#, 067 1 4+31

$$\mathbb{E}[V_{D_S^{-1}}^1] \leq \mathbb{E}[V_c] \leq \mathbb{E}[V_{D_S^{-1}}^2]$$

#\$%%&' V_c(V_{D_S^{-1}}^1) + V_{D_S^{-1}}^2, - +. * - + / * 01 - 2)3 - 4,56)6/7208 24)8-)+ / *)+ / 05*(95,)7
 $\omega \in \Omega_n(V_{D_S^{-1}}^1(\omega) \leq N_c(\omega) \leq V_{D_S^{-1}}^2(\omega))$; * 85*2-<=>*8-(95,)77*-,)54-,)6,2)*+ 95, 01-
 ->4-80+?)7- / * 4,)08=7, (01- / * -<=>)70@157+2; \square

!"# \$ %' &'(2)31, $\lambda \in \mathbb{R}^{+*} 6n \in \mathbb{N}^* 6S \in \mathbb{N}^* +, * \gamma \in \Gamma_{(n,S)}$ 67 1 4+318

$$P_\lambda(D_S^{-1}(\gamma)) = P_{p_\lambda}(\gamma)$$

#\$%%&' &5,) A?-* $\gamma(B- 853 4=0 P_\lambda(D_S^{-1}(\gamma))$: C- . ,20+/?/+ [0,1]^n / * 23)7-, ?57=3 -2 59
 855,+/*)0 2 [i_1-1, i_1/S, [x... x [i_n, i_n+1/S [B/01 01- +/999, -*0i_j ?), @*A/* [1... S]: D_S^{-1}(\gamma) / 201- 2-0
 59)7785*0*5=2*-(B5, D2=81 01)001-, - / 2 * 5 * 5+ / *)77?57=3 -2 [i_1, i_1+1/S] x ... x [i_n, i_n+1/S] 95,
 B1/81 $\gamma(i_1 \dots i_n) = 0$)*+ 5*- 5, 3 5, - * 5+ 2 / * 01- 501-, 2: E/?-* 01- 45/225*) * 4,58- 22 / * 0 * 2/0@
 $\lambda(01- 4,56)6/70@591)?/*A*5 * 5+ / * 5*- 23)77?57=3 - / 2 \exp(-\frac{\lambda}{S^n})$)*+ 01- 4,56)6/70@591)?/*A
 5*- 5, 3 5, - * 5+ 2 / 2 1 - \exp(-\frac{\lambda}{S^n}); * 85*2-<=>*8-(B- 1)?- 01- 9575B/*A-<=>)05*

$$\begin{aligned} P_\lambda(D_S^{-1}(\gamma)) &= \exp(-\frac{\lambda}{S^n})^{0(\gamma)} \cdot (1 - \exp(-\frac{\lambda}{S^n}))^{1(\gamma)} \\ &= p_\lambda^{1(\gamma)} \cdot (1 - p_\lambda)^{0(\gamma)} \\ &= P_{p_\lambda}(\gamma) \end{aligned}$$

\square

() '*+'# %&' 9 1' #, 0)*1" $\lambda \in \mathbb{R}^{+*} 6n \in \mathbb{N}^* 6S \in \mathbb{N}^*$: 9 1 +(0# ' #, 0)*1" -4"11 ;&' -)#, 0 V_c : $\Omega_n \rightarrow \mathbb{R}$
 +, * V_d^1, V_d^2 : $\Gamma_{(n,S)} \rightarrow \mathbb{R}$ 0&4 -4+ ;#"+(($\omega \in \Omega_n$ 67 1 4+31 V_d^1 o D_S(\omega) \leq V_c(\omega) \leq V_d^2 o D_S(\omega):
 V_c)0+ "+, *#\$ 3+)"<(1), -41 / "#<+<)00)' 0'+ 1 (\Omega_n, Q, P_\lambda) +, * V_d^1, V_d^2 + "1 "+, *#\$ 3+)"<(10),
 (\Gamma_{(n,S)}, Q', P_{p_\lambda}) 7 41"1 p_\lambda = 1 - \exp(-\frac{\lambda}{S^n}): =41, 67 1 4+318

$$\mathbb{E}[V_d^1] \leq \mathbb{E}[V_c] \leq \mathbb{E}[V_d^2]$$

#\$%%&' &53 73 3) !(B- D*5B 01)0{D_S^{-1}(\gamma)|\gamma \in \Gamma_{(n,S)}} / 2) . */0 4, 005* 59 \Omega_n; * 85*2-F
 <=>*8-(

$$\mathbb{E}[V_{D_S^{-1}}^1] = \sum_{\gamma \in \Gamma_{(n,S)}} P_\lambda(D_S^{-1}(\gamma)) \cdot V_d^1(\gamma)$$

&53 73 3) Q(B- 8)* + +=8- 01)0

!"

!"###\$%&'()*#&,*)"-.

$$\begin{aligned} \mathbb{E}[V_{D_S^{-1}}^1] &= \sum_{\gamma \in \Gamma_{(n,S)}} P_{p_\lambda}(\gamma) \cdot V_d^1(\gamma) \\ &= \mathbb{E}[V_d^1] \end{aligned}$$

\$ % & ' () % *) , - & , . / 0 1 . 0

$$\mathbb{E}[V_{D_S^{-1}}^1] \leq \mathbb{E}[V_c] \leq \mathbb{E}[V_{D_S^{-1}}^2]$$

2

3 & 4 (. - 5) 6 0 7

$$\mathbb{E}[V_d^1] \leq \mathbb{E}[V_c] \leq \mathbb{E}[V_d^2]$$

□

! " # \$ % & ' () * + ,

- . ' \$ # / 0 1 , \$ - / % n 0 1 2) # \$ % * # 3 / 4) 5 6 7) % T, d \in]0, 1] \lambda \in \mathbb{R}^{+*} / \% d S \in \mathbb{N}^* 5 8) # 9
T_S = [T.S] 5 d_S = [d.S] ; :) \$ < \mathcal{G} \# \% \Gamma_{(n,S)}, Q', P_{p_\lambda} / \% d (\Omega_n, Q, P_\lambda) =

$$\mathbb{E}[N_{(d_S, T_{S+1})}] \leq \mathbb{E}[\bar{N}_{(d,T)}] \leq \mathbb{E}[N_{(d_S, T_S)}]$$

8 9 ; ; < = > ? @ A > > ? B <) (\$ \mathcal{C} \# n \in \mathbb{N}^* D T, d \in]0, 1] D \lambda \in \mathbb{R}^{+*} . (C S \in \mathbb{N}^* 2 D ;) E \# F \& 0 1 \mathcal{S} 0 1 \& + \mathcal{D} \% \% 7 - \mathcal{G} \& 0 1 \& + \mathcal{S} \mathcal{G} 0 H F \& 6 5 0 1 \& + \mathcal{E} / \% 0 1 V_c 6 \& 7 H \& I G - 0 \bar{N}_{(d,T)} . (C V_1 . (C V_2 6 \& 7 H + \mathcal{S} E \& I O F \& 5 \& I G - 0 N_{(d_S, T_{S+1})} . (C N_{(d_S, T_S)} 2 \# \\$ J) (\mathcal{S} \& I G \& J \& D O \mathcal{S} \&) \mathcal{G} H I 0 \\$ 1) \% 0 1 . 0 *) + . H F \& \omega \in \Omega_n D

$$N_{(d_S, T_{S+1})} \circ D_S(\omega) \leq \bar{N}_{(d,T)}(\omega) \leq N_{(d_S, T_S)} \circ D_S(\omega)$$

<) (\$ \mathcal{C} \# \omega \in \Omega_n 2 K \& J_c = \{ (j_1^i, \dots, j_n^i) \mid i \in [0 \dots l], l \in \mathbb{N}^* \} 6 \& . \\$ 1) + \mathcal{S} 0 E 0 1 6 \& 0 \% \& \& 0 \%) () \mathcal{C} \mathcal{S} x . (C y \in \Omega_n 2 3 \& J) (\$ \mathcal{C} \# \omega' \in \Omega_n \% 1 7 1 \mathcal{S} 0 1 \& (\& 0 \%) \dagger J) , E) \mathcal{S} \& \mathcal{C} 6 5 0 1 \& J) + \mathcal{C} 7 . 0 \mathcal{S} J) (0 7 \& \mathcal{C} 7 J 2 3 \& J) (\$ \mathcal{C} \# J_d = D_S(\omega') 2 3 \& J . (\\$ 1) \% 0 1 . 0 J_d \mathcal{S} . F . - \mathcal{C} E 0 1 \in N_{(d_S, T_{S+1})} \circ D_S(\omega) 2 I (J) (\mathcal{S} \& I G \& J \& D \% \& 1 . F \& N_{(d_S, T_{S+1})} \circ D_S(\omega) \leq \bar{N}_{(d,T)}(\omega) 2

;) \\$ 1) \% 0 1 . 0 \bar{N}_{(d,T)} \leq N_{(d_S, T_S)} \circ D_S \mathcal{D} \% \mathcal{S} \mathcal{G} E \mathcal{S} \& 0 1 . 0 0 1 \& \& \mathcal{M} \mathcal{S} \omega \mathcal{S} \mathcal{G} 1 0 1 . 0 \bar{N}_{(d,T)}(\omega) > N_{(d_S, T_S)} \circ D_S(\omega) 2 3 \& J) (\$ \mathcal{C} \# . \\$ 1) + \mathcal{S} 0 E 0 1 J_d \in D_S(\omega) . (C 6 7 0 *) , J_d . E 0 1 J_c \in \mathcal{S} \mathcal{G} 1 0 1 . 0 |J_c| = |J_d| 2 I 0 - \& \mathcal{C} \mathcal{S} 0 . J) (0 : \mathcal{C} 7 0) (\% 1 7 1 E \# F \& \mathcal{S} 0 1 \& 0 1 \& + \mathcal{E} 2 \quad \square

2 ' / / 3 4 1 , \$ - / % n 0 1 2) # \$ % * 1 # 4 - 9 # 3 / 4) 5 6 7) % T, d \in]0, 1] \lambda \in \mathbb{R}^{+*} / \% d S \in \mathbb{N}^* 5 8) # 9
T_S = [T.S] 5 d_S = [d.S] / \% d 8) (/ 7) \% \Gamma_{(n,S)}, Q', P_{p_\lambda} =

$$\lim_{S \rightarrow \infty} \mathbb{P}(N_{(d_S, T_{S+1})} = N_{(d_S, T_S)}) = 1$$

#\$\$%&'()*+,-./ T ∈]0, 1] 0* - λ ∈ ℝ* 1 2 . 3*) 4 5605 N_{(d_S, T_{S+1})} ≤ N_{(d_S, T_S)} 1 7 6 . 8/) 909, ;, 5
) < 60 =, * > N_{(d_S, T_{S+1})} ≠ N_{(d_S, T_S)} , +, * < / ,) / 5 56 . 8/) 909, ;, 5 5605 56 . /) ? 5 * > 0 : >) / , 56 @ 9 ? , : - + 54)
 - , << / . * 5 80 56 + 4 , 56 T_S 0 * - T_S + 11 7 6 , + 8 6 . *) @ . * 0) A A / + 4 6 . * 56 . / . , +) * . *) - . , * 56 . / 0 * > .
 T_S + 1 5605 , + *) 5 , * 56 . / 0 * > . T_S 0 * - 5605 , + A) + / 5 56 . - . + 5 * 0 5) * 560 * 56 . * . B 5 6) 8 A 6) + *
 , * 56 . / 0 * > . T_S 1 2 . A 0 * 9 , * - 56 , + 8 /) 909 , ;, 5 9 ; 56 .) * .) < 60 =, * >) * . *) - . 0 5 / 0 * > . T_S + 1 '
 (1 - p_λ)^{(2.T_S+1)^{n-1}} 1 C) / .) = / D 4 . 3 *) 4 <) @ 0 + , @ : / . 0 +) * , * > 560 * 56 .) * .) < + A 5) * E I F 5605
 <) / 0 : : d 0 * - T D N_{(d, T)} = O((\frac{d}{T})^n) 1 G 80 / 5 A 2 : 0 / D 2) / d_S 0 * - T_S D

$$N_{(d_S, T_S)} = O\left(\left(\frac{d_S}{T_S}\right)^n\right) = O\left(\left(\frac{\lfloor d.S \rfloor}{\lfloor T.S \rfloor}\right)^n\right) = O(1)$$

G A) * + . H . * A D

$$\begin{aligned} \mathbb{P}(N_{(d_S, T_{S+1})} = N_{(d_S, T_S)}) & \geq ((1 - p_\lambda)^{(2.T_S+1)^{n-1}})^{O(1)} \\ & = N_{(d_S, T_S)} \geq (1 - p_\lambda)^{O(S^{n-1})} \end{aligned}$$

I + p_λ = 1 - exp(-\frac{λ}{S^n}) D 4 . 60 = .

$$\begin{aligned} \mathbb{P}(N_{(d_S, T_{S+1})} = N_{(d_S, T_S)}) & \geq \exp\left(-\frac{\lambda}{S^n}\right)^{O(S^{n-1})} \\ & \geq \exp\left(-\frac{\lambda}{S^n} \cdot O(S^{n-1})\right) \\ & \geq \exp\left(-O\left(\frac{1}{S}\right)\right) \end{aligned}$$

& * 0 : : D

$$\begin{aligned} 1 & \geq \mathbb{P}(N_{(d_S, T_{S+1})} = N_{(d_S, T_S)}) \geq \exp\left(-O\left(\frac{1}{S}\right)\right) \\ 1 & \geq \lim_{S \rightarrow \infty} \mathbb{P}(N_{(d_S, T_{S+1})} = N_{(d_S, T_S)}) \geq 1 \end{aligned}$$

4 6 , A 6 8 /) = , + 56 . : . @ @ 0 1

□

! "\$ % & ' (! # " + , 2 n 3 *) \$ 1 , 0 # , + (0 ' + ' 145) 6 1 , T , d ∈]0, 1] 4 λ ∈ ℝ* + , * S ∈ ℕ* 4 7 1 0 1 - T_S =
 [T . S] 4 d_S = [d . S] + , * 7 1 8 + 6 1) , (Γ_{(n, S)} , Q' , P_{p_λ}) + , * (Ω_n , Q , P_λ) 9

$$\lim_{S \rightarrow \infty} N_{(d_S, T_S)} = \bar{N}_{(d, T)}$$

\$ % % & ' 7 / , = 0 : > , = * 56 .) / . @ J 0 * - : . @ @ 0 K I

□



! "#%&' (&)*&)*&+ , - + - *0" &l. 23&4
566789&: &' &2<: (03&1 =>=? @0" \$A0" "0\$B8# \$14C #& DE(8")&F
! "#%&' (&)*&)*&+ , - + E: \$ (4GH() I 2 AJ (48K! "#&4#&1 L. I ' & MN' &
?7(: &C)P: &4 @0"0' 1QR>Q= J - B. S I & & DE(8")&F
! "#%&' (&)*&)*&+ , - + U0((8# &GUJ - + 7V&* "0302&' &, 8")KIW8A0# 1I 8C3: 44)#& \$&P: &
5R67(: &': G(' # W0\$"#P: &1 WHRYR 16?5YZM#2&412&41, 8")KI & & DE(8")&F
! "#%&' (&)*&)*&+ , - + - &" &4 G+ +B. 7I 8C3: 4: "#&4#&#&' &W&: 2& 1=6Y?Z- &" &4 I & & DE(8")&F
! "#%&' (&)*&)*&+ , - + - 0)P: &)0: (\$G\ 0C8# &' &M02)&: 1- 0)P: &)0: (\$1 WHRY6 1]>R6= U&I *&" 8KI & & DE(8")&F
! "#%&' (&)*&)*&+ , - + B03*#B. "\$B02#4 GZYY?7(0: \$&' &4 U:)#02&4 1WHQ= 1 Y5QYZ B03*#B. "\$B02#4 I & & DE(8")&F

2/6 #&& (
+ , - + 1\ 0C8# &' &M02)&: 1- 0)P: &)0: (\$WHRY6 1]>R6= U&I *&" 8KI & & DE(8")&F
! ""#\$%&' & &') *(+ , *
+BB, YZ? Q15=QQ