



HAL
open science

Evaluation of the Bandwidth Needed at the MAC 802.11b Level

Dang-Quan Nguyen, Pascale Minet

► **To cite this version:**

Dang-Quan Nguyen, Pascale Minet. Evaluation of the Bandwidth Needed at the MAC 802.11b Level. [Research Report] RR-5553, INRIA. 2005, pp.22. inria-00070454

HAL Id: inria-00070454

<https://inria.hal.science/inria-00070454>

Submitted on 19 May 2006

HAL is a multi-disciplinary open access archive for the deposit and dissemination of scientific research documents, whether they are published or not. The documents may come from teaching and research institutions in France or abroad, or from public or private research centers.

L'archive ouverte pluridisciplinaire **HAL**, est destinée au dépôt et à la diffusion de documents scientifiques de niveau recherche, publiés ou non, émanant des établissements d'enseignement et de recherche français ou étrangers, des laboratoires publics ou privés.

*Evaluation of the Bandwidth Needed
at the MAC 802.11b Level*

Dang-Quan Nguyen — Pascale Minet

N° 5553

April 2005

Thème COM



*Rapport
de recherche*



Evaluation of the Bandwidth Needed at the MAC 802.11b Level

Dang-Quan Nguyen, Pascale Minet

Thème COM — Systèmes communicants
Projet Hipercom

Rapport de recherche n° 5553 — April 2005 — 22 pages

Abstract: Mobile ad-hoc networks (MANETs) have many advantages, self-adaptivity for instance, that make them attractive for multiple applications. Most of these networks use the MAC 802.11b protocol for the medium access control. As all nodes use the same transmission frequency, interferences can occur compromising the quality of service (QoS) provided to flows. In this report, we show how to evaluate the bandwidth required at the MAC level for a flow whose characteristics are known at the application level. The bandwidth evaluation on a node accounts for the interferences due to the flow itself and the other flows. This evaluation has been validated by confrontation with results obtained by NS-2 simulations. We then propose an efficient admission control based on this evaluation. An example illustrates the proposed solution and highlights the accuracy of the evaluation.

Key-words: Ad-hoc networks, quality of service, interferences, bandwidth, admission control, IEEE 802.11.

Evaluation de la bande passante nécessaire au niveau MAC 802.11b

Résumé : Les réseaux mobiles ad-hoc (MANET) ont de nombreux avantages dont l'auto-adaptativité qui les rendent attrayants pour de multiples applications. La plupart de ces réseaux utilisent le protocole MAC 802.11b pour gérer l'accès au médium. Comme tous les noeuds utilisent la même fréquence d'émission, des interférences sont possibles dégradant la qualité de service (QoS) offerte aux flux. Dans ce rapport, nous montrons comment évaluer au niveau MAC la bande passante nécessaire à un flux dont les caractéristiques sont connues au niveau applicatif. L'évaluation sur un noeud prend en compte les interférences causées par le flux lui-même et par les autres flux. Cette évaluation a été validée par confrontation aux résultats obtenus par simulation sous NS-2. Nous proposons ensuite un contrôle d'admission efficace basé sur cette évaluation. Un exemple illustre la solution proposée et met en évidence la bonne précision de l'évaluation réalisée.

Mots-clés : Réseaux ad-hoc, qualité de service, interférences, bande passante, contrôle d'admission, IEEE 802.11.

Contents

1	Introduction	4
2	State of the Art	5
3	Bandwidth Evaluation	6
3.1	Definitions and notations	6
3.2	Assumptions	6
3.3	Bandwidth evaluation principles	7
3.4	Traffic in the neighborhood area	8
3.5	Traffic in the interference area	9
3.6	Evaluation of additional bandwidth in the presence of other flows	11
3.7	Algorithm to evaluate the bandwidth consumed at a node	17
4	Admission Control	18
4.1	Principles	18
4.2	Admission control algorithm	18
5	Implementation Example with OLSR	19
6	Accuracy of the Bandwidth Evaluation	20
7	Conclusion	22

1 Introduction

Mobile ad-hoc networks (MANETs) are made of nodes communicating via a wireless medium. Those networks use routing protocols like OLSR [1] and AODV [2] which enable multihop communication. In ad-hoc networks, the limited bandwidth capacity makes it difficult to guarantee the bandwidth in the presence of many flows. That is why it is necessary to have a good estimation of the bandwidth required by a flow. The more exact this estimation is, the more efficient the admission control would be. Figure 1 shows the necessity of an admission control in a network supporting quality of service (QoS). Initially, the network can accept the flow f_1 , CBR at $1500Kbps$. At time $t = 100s$, a new flow f_2 is introduced, also a CBR flow at $1500Kbps$. It degrades the QoS received by f_1 . The bandwidth received by f_1 falls below $800Kbps$, which is unacceptable for this flow. The results illustrated in Figures 1 and 2 have been obtained by simulation under NS-2. The packet size is 1500 bytes. The MAC layer uses the 802.11b protocol without RTS/CTS.

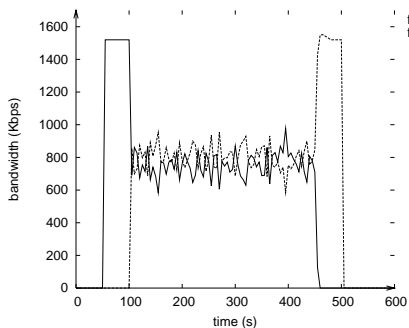

Figure 1: Bandwidth of the flows f_1 and f_2 without admission control.

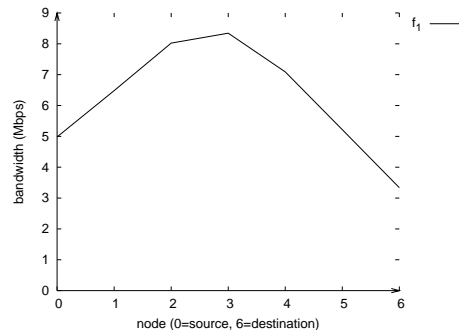

Figure 2: Bandwidth of one flow, measured on each node of the route.

Figure 2 shows the bandwidth consumed at the MAC level by one flow at each node on its route. The flow is CBR at $1Mbps$, visiting the nodes 0 to 6. We can see that the consumed bandwidth depends on the node considered. Besides, we can also see that the consumed bandwidth at the source is not the same as that at the destination. Therefore, we can deduce that the flow's direction has an impact on the consumed bandwidth.

This report presents a method to evaluate with accuracy the bandwidth consumed by a flow at each node on its route, knowing the flow parameters and the state of the traffic in its environment. This method has been validated by confrontation with the results obtained by simulation under NS-2. The accuracy of the results allows to perform an efficient admission control.

This report is organized as follows. Section 2 presents the state of the art on bandwidth evaluation and admission control in ad-hoc networks. Our bandwidth evaluation method is presented in Section 3. We propose in Section 4 an admission control based on this bandwidth evaluation. An implementation example of this mechanism is shown in Section 5. We evaluate the accuracy of our bandwidth evaluation method in Section 6. We conclude the report and propose different perspectives in Section 7.

2 State of the Art

Veres et al. [7] have proposed an estimation of the bandwidth available at a node based on passive listening of the wireless medium. They use a virtual MAC layer to emulate in real-time the real MAC layer's operations. The feasibility of this solution has been proved by an implementation on a 802.11b network. The accuracy of this evaluation is good, even in the saturation region, which is important to judge the admissibility of a new flow. A drawback of this solution is its overhead in resources such as CPU time and battery.

In SWAN [4], the admission control is performed at the source node for all new real-time flows. This admission control is based on the bandwidth required by the flow and the available bandwidth at each node on its route. When a real-time flow requests its admission, the source node issues a bandwidth probe packet which contains at its return the minimum bandwidth available on the route of the flow. In SWAN, the admission control does not take into account the interferences: only nodes on the route check if their available bandwidth is sufficient to accept the new flow.

In BRuIT [3], the *interference area* of a node s is defined as the set of nodes affected by interferences generated by s . It includes only nodes at a distance less than or equal to l hops from s . Therefore, for a flow that requires k bps, BRuIT makes a bandwidth reservation with the quantity of bandwidth k bps not only along the route of that flow but also at all nodes within l hops from the route. This model does not take into account the fact that a node can belong to the interference area of several nodes along the route. Thus, it cannot prevent a new bandwidth reservation from interfering with already accepted reservations.

In [5], it is shown that finding a route from a source to a destination meeting a bandwidth constraint is made NP-complete by the interferences. Two heuristics H_1 and H_2 are proposed to select routes accounting for the available bandwidth on the nodes of the route only (H_1) or on the nodes at a distance less than or equal to 2 hops from a node on the route (H_2). They show that these heuristics accept more flows than Dijkstra algorithm, where the weight of an edge is equal to the local available bandwidth. Moreover, the second heuristic H_2 outperforms the first one, because of its more accurate view of interferences. In our solution, the admission control of a flow accounts for interferences.

3 Bandwidth Evaluation

3.1 Definitions and notations

- A node is said to be *neighbor* of another node iff their distance is less than or equal to the coverage radius.
- A node is said to *interfere* with another node iff their distance is between the coverage radius and the interference radius.
- A node is said to be in the *neighborhood* of a flow iff it is a neighbor of a node visited by the flow.
- A node is said to be in the *interference area* of a flow iff it interferes with a node visited by the flow.
- The *surrounding* of a node N , denoted $S(N)$, is the union of the nodes belonging to its coverage area or its interference area.

Figure 3 shows the possible intersections between the route, the neighborhood and the interference area of a flow.

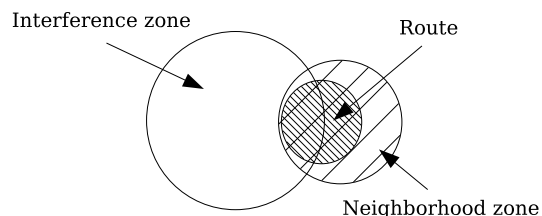

Figure 3: Intersections between route, neighborhood and interference area of a flow.

3.2 Assumptions

To evaluate the bandwidth consumed by a flow, we adopt the following models:

Network model

This model is defined by:

- *Multihop ad-hoc network in the presence of interferences*: The route between any source and any destination can be multihop. Communications are disturbed by interferences due to remote transmissions. More precisely, with regard to interferences, we assume that any node knows all the nodes located in its interference area.
- *802.11b DCF without RTS/CTS*: We assume that the MAC layer uses the IEEE 802.11b protocol in DCF mode without RTS/CTS. Indeed, with the values defined

in the standard of the IEEE 802.11b protocol ($RTSThreshold = 2347$ bytes), the use of the RTS/CTS mechanism is recommended only for frames whose size is higher than 2347 bytes. Hence, by default most ad-hoc networks do not use the RTS/CTS mechanism.

- *Bandwidth as QoS parameter:* In this report, we consider that the main QoS parameter is bandwidth. The interferences due to neighboring flows can compromise the bandwidth guarantee granted to an already accepted flow.

Flow model

- *Each flow follows a fixed route:* This fixed route can be obtained for instance by source routing. We assume that the route is known to all nodes in its surrounding.
- *CBR Flow:* We assume that the flows are constant bit rates, moreover all packets belonging to a flow are supposed to have the same size.

3.3 Bandwidth evaluation principles

As stated in the assumptions (*see* Section 3.2), we consider the bandwidth as the main QoS criterion. The interferences due to surrounding flows can compromise the bandwidth guaranteed to an already accepted flow. This problem is difficult to solve due to lack of an efficient admission control in ad-hoc networks. Indeed, in order to accept a new flow f in a network without compromising the QoS of already accepted flows, the admission control mechanism knowing f 's characteristics must be able to evaluate accurately the impact of f on all nodes in its surrounding, i.e., all nodes in the neighborhood or the interference area of at least one node of f 's route. In this report, we present a method to evaluate the bandwidth consumed at the MAC level by each node in an ad-hoc network. We consider the interferences due to transmissions surrounding a node and the collisions due to concurrent flows. We have validated this bandwidth evaluation method by simulations under NS-2. The results show that this method performs with good accuracy.

In order to evaluate the bandwidth consumed at a node due to interferences, we must know the state of the traffic in its neighborhood and interference area. If we suppose that the interference area is limited to two-hop nodes, then knowing the flows visiting nodes in the neighborhood table of one hop and of two hops is enough.

The evaluation of the bandwidth consumed by any flow f is performed in three steps:

- *Step 1: evaluation of the bandwidth consumed by f at a node in its neighborhood area,* the flow f being considered in isolation. This evaluation is studied in Section 3.4.
- *Step 2: evaluation of the bandwidth consumed by f at a node in its interference area,* the flow f being considered in isolation. This evaluation is studied in Section 3.5.

- *Step 3: evaluation of the additional bandwidth consumed due to collisions.* In this last step, we take into consideration the collisions due to the presence of other flows than the flow f being considered. This evaluation is studied in Section 3.6.

3.4 Traffic in the neighborhood area

We consider a flow f in isolation and evaluate the bandwidth consumed by this flow at a node N in its neighborhood area.

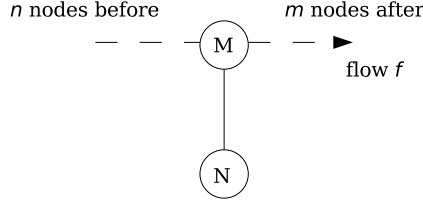

Figure 4: Node N neighbor of a node belonging to flow f 's route.

Now we enounce the property 1 and recall that $\mathbb{1}_{n>0}$ is equal to 1 if $n > 0$ and 0 otherwise.

Property 1 *Let f be a flow, let N be a node in the neighborhood area of the flow f . Let M be a node visited by f , neighbor of node N . The bandwidth B_N consumed by node M 's transmissions relative to f is evaluated at node N as follows:*

$$B_N = \mathbb{1}_{n>0}(ACK) + \mathbb{1}_{m>0}(pck) \quad (1)$$

with

n the number of nodes visited by f before the node M .

m the number of nodes visited by f after the node M .

ACK the bandwidth needed for the transmission of an acknowledgement frame $802.11b_{ACK}$ at the MAC level.

pck the bandwidth needed for the transmission of a data frame at the MAC level.

Moreover, if node N belongs to the route of f and N is not the destination, the following quantity of bandwidth must be added to B_N : $2 \cdot DIFS + \overline{CW_0}$, where $DIFS$ is the bandwidth corresponding to the waiting time equal to $802.11b_{DIFS}$ and $\overline{CW_0}$ is the bandwidth corresponding to the average waiting time due to the contention window at the first collision.

Example 1: For any CBR flow whose bit rate is $1Mbps$ at the application level and packet size is 1500 bytes, the application of Property 1 provides the following results: (see Table 1).

m \ n	0	≥ 1
0	0.0	0.279
≥ 1	1.208	1.487

Table 1: Bandwidth (in *Mbps*) consumed in the neighborhood area of a node.

3.5 Traffic in the interference area

We consider a flow f in isolation and evaluate the bandwidth consumed by this flow at a node N in its interference area.

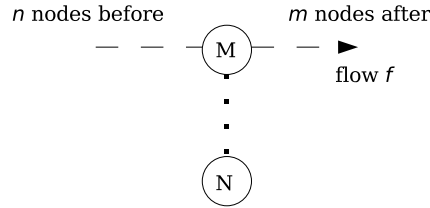
Figure 5: Node N in the interference area of a node belonging to flow f 's route.

Property 2 Let f be a flow, let N be a node in the interference area of the flow f . Let M be a node visited by f , interfering with node N . The bandwidth B_N consumed by node M 's transmissions relative to f is evaluated at node N as follows:

$$B_N = \mathbb{1}_{n>0}(ACK) + \mathbb{1}_{m>0}(pck) + \mathbb{1}_{(n>0)\&(m>0)}(DIFS) \quad (2)$$

If M is the destination of f , or if the node visited after M is neither in the interference area nor in the neighborhood of N , then we must add the quantity of bandwidth equal to $EIFS$ which corresponds to the waiting time of 802.11b $_{EIFS}$.

Example 2: For any CBR flow whose bit rate is 1*Mbps* at the application level and packet size is 1500 bytes, the application of Property 2 gives the following results: (see Table 2).

m \ n	0	≥ 1
0	0.0	0.279
≥ 1	1.208	1.533

Table 2: Bandwidth (in *Mbps*) consumed in the interference area of a node.

Validation by simulations

We have compared our bandwidth calculations by means of Properties 1 and 2 with the simulation results in the presence of one single flow. In order to measure the bandwidth consumed at a node in NS-2, we count at that node the amount of time spent in transmission, in reception and lost due to interferences. We give hereby an example of our results obtained with a 6-hop-long CBR flow (*see* Figure 6). The flows's parameters are described in Table 3. Table 4 gives the parameters used in the simulations. Moreover, we suppose that the interference area is limited to two hops. Figure 7 illustrates the results obtained by calculations and by simulations at each visited node. We can see that the suggested bandwidth evaluation method performs with high accuracy.

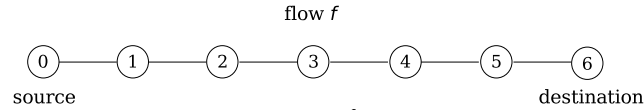

Figure 6: Flow f with 6 hops.

No. hops	6
App. bit rate	1Mbps
Packet size	1500 bytes

Table 3: Flow f 's parameters.

Data frame rate	11Mbps
Control frame rate	1Mbps
DIFS	50 μ s
EIFS	364 μ s
SIFS	10 μ s
ACK frame	14 bytes
Preamble	144 bits
PLCP header	48 bits

Table 4: MAC 802.11b layer parameters.

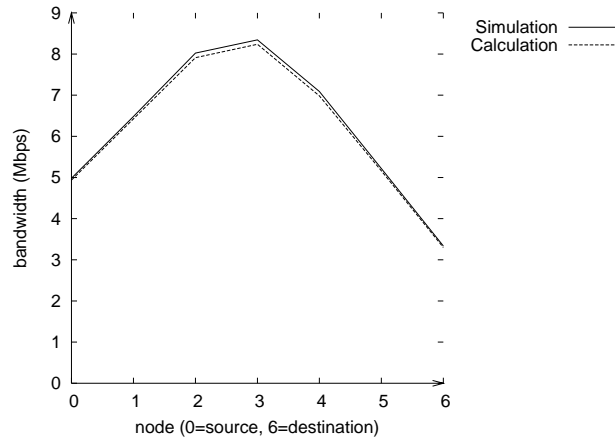

Figure 7: Bandwidth of the flow f , calculated and simulated at each node of the route.

3.6 Evaluation of additional bandwidth in the presence of other flows

We take into consideration the presence of other flows in f 's surrounding in addition to the flow f itself. This presence causes collisions which consume an amount of bandwidth. We now evaluate this amount of additional bandwidth.

We can notice that the bandwidth lost due to internal collisions (i.e., collisions between packets belonging to the same flow) has been accounted for in Property 2.

Property 3 *At a node, the total consumed bandwidth is equal to the sum of the bandwidth consumed by each flow considered in isolation, plus the bandwidth consumed by the collisions.*

In this section, we introduce a collision model allowing to evaluate the additional amount of bandwidth consumed by the collisions.

Collision model

In the presence of several flows in the network, their transmissions can possibly collide with each other and disturb the reception at receiver nodes. Those collisions trigger a succession of events described in the 802.11b protocol: enter in backoff mode, retransmissions, In order to account for this phenomenon, which consumes bandwidth as well, we consider an analytical model for the collisions between concurrent CBR flows. We then deduce a formula computing the quantity of bandwidth lost due to collisions.

Modeling the packet collisions can be complicated without having any particular assumption. Most analytical models (*see* [9] for instance) assume that the packet collision rate is constant, which is perhaps true if every node must, at anytime, access the radio medium to transmit a packet. Otherwise, we can notice that the introduction of a new flow in the network modifies the packet collision rates between already accepted flows. This modification involves the modification between already accepted flows and the new flow as well. Thus, we can deduce a fixed-point formula for the collisions.

Assumption of the collision model: *For any flow f_i , any packet of f_i collides in the surrounding of a given node at most once with any packet belonging to a flow f_j , with $j \neq i$.*

When two transmissions collide with each other, each transmitter chooses a random value of CW (contention window) according to the 802.11b collision resolution procedure. After waiting for an interval of time equal to the chosen value, each transmitter retransmits its packet. The probability that a second collision occurs with the same transmitter is quite low because of the size of CW . This assumption has been verified by simulations under NS-2 for homogeneous CBR flows.

Property 4 *The bandwidth consumed at a node N_e due to collisions of packets transmitted on the link (N_e, N_r) is given by $\mathcal{E}_{N_e, N_r} \cdot D$, with D the nominal bandwidth rate (i.e., 11Mbps), and:*

$$\mathcal{E}_{N_e, N_r} = \frac{\sum_{i=1}^n \Theta_i \delta_i(\mathcal{E}_{N_e, N_r})}{1 + \sum_{i=1}^n \delta_i(\mathcal{E}_{N_e, N_r})} \quad (3)$$

The bandwidth consumed at a node $N^l \in \mathcal{S}(N_e)$ due to collisions of packets transmitted on the link (N_e, N_r) is given by $\mathcal{E}'_{N_e, N_r} \cdot D$, with:

$$\mathcal{E}'_{N_e, N_r} = \frac{\sum_{i=1}^n \Theta'_i \delta_i(\mathcal{E}_{N_e, N_r})}{1 + \sum_{i=1}^n \delta_i(\mathcal{E}_{N_e, N_r})} \quad (4)$$

with

n the number of transmitters in $\mathcal{S}(N_e) \cup \mathcal{S}(N_r)$.

$\Theta_i = i(\alpha + t) + \sum_{j=1}^i \overline{CW}_j$ the channel utilisation factor at node N_e after i collisions of the same packet on the link (N_e, N_r) , \overline{CW}_j is the average value of CW after j collisions.

$\Theta'_i = i(\alpha + t)$ the channel utilisation factor at node N^l after i collisions of the same packet on the link (N_e, N_r) .

$\delta_i(\mathcal{E}_{N_e, N_r}) = \frac{t^i}{\prod_{j=0}^{i-1} (1 - \tilde{b} - \mathcal{E}_{N_e, N_r} - \Theta_j)}$ is the probability of having i collisions of the same packet.

where

$\alpha = \bar{t} + EIFS$ is the bandwidth consumed at a node between the beginning and the end of a collision.

t is the bandwidth amount corresponding to the transmission at the MAC level of a data frame and its acknowledgement frame.

\bar{t} is the average value of t .

\tilde{b} is the bandwidth occupied by the load of nodes in the surrounding of N_e .

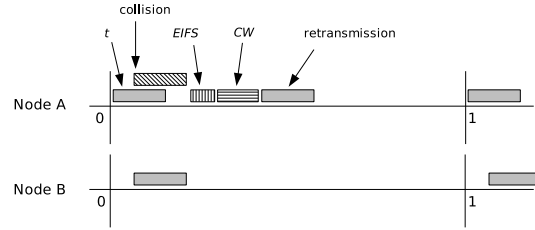

Figure 8: Two nodes enter in collision and retransmit their packet.

Proof: Let A and B be two nodes whose transmissions collide with each other (see Figure 8). Nodes A and B transmit 2 homogeneous CBR flows: those flows have the same bit rate and packet size. In order to normalize the bandwidth computation, we suppose that the time interval between 2 successive transmissions of any flow is one time-unit. In those conditions, the transmission time of a packet, t , is equal to the probability of collision with another flow.

Let n be the number of transmitters in the surrounding of a node N . According to the assumption of the collision model, any packet transmitted by node N collides at most once with any other packet transmitted by a node M , with $M \in \mathcal{S}(N)$. The time lost at node N due to i successive collisions is: $\Theta_i = i(\alpha + t) + \sum_{j=1}^i \overline{CW}_j$, with $\alpha = \bar{t} + EIFS$ and $1 \leq i \leq n$.

By convention, $\Theta_0 = 0$. If we consider a node $N' \in \mathcal{S}(N_e)$ which is not a transmitter, then N' only listens passively to the channel and does not perform any backoff procedure. Thus, the time lost at node N' due to i successive collisions is: $\Theta_i = i(\alpha + t)$.

Let us consider a packet in collision.

Let p_i the probability that this packet meets i collisions knowing that it has already met $i - 1$ collisions, we have:

$$p_i = \begin{cases} 0 & i = 0 \\ \frac{t}{1 - \Theta_{i-1}} & 1 \leq i \leq n \end{cases}$$

We can establish a Markovian string whose states represent the collision sequence met by the packet being considered and transitions are the probabilities of meeting a new collision or a transmission with success (see Figure 9). Notice that the return from state n to state 0 means that either the packet has been correctly transmitted, or it has been rejected.

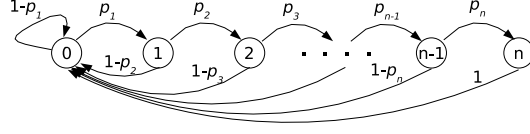

Figure 9: Markovian string representing the collisions.

Let e_i be the probability of being in state i of this string, with $0 \leq i \leq n$:

$$e_i = \begin{cases} \frac{1}{n} & i = 0 \\ 1 + \sum_{i=1}^n \delta_i & \\ e_0 \delta_i & 1 \leq i \leq n \end{cases}$$

$$\text{with } \delta_i = \frac{t^i}{\prod_{j=0}^{i-1} (1 - \Theta_j)}$$

Let \mathcal{E}_{N_e, N_r} be the average value of bandwidth consumed at node N_e by the collisions of packets transmitted from N_e to N_r :

$$\mathcal{E}_{N_e, N_r} = \sum_{i=0}^n e_i \Theta_i = \frac{\sum_{i=1}^n \Theta_i \delta_i}{1 + \sum_{i=1}^n \delta_i}$$

As we have noticed in the collision model, the introduction of a new flow modifies the collision rate of all flows in its surrounding. Therefore, the quantity of bandwidth \mathcal{E}_{N_e, N_r} consumed by the collisions must be removed from the time unit initially supposed to be available in this model. Also, we must remove from this time unit the network load already occupied by other transmitters in the surrounding of the node being considered. Thus, we obtain:

$$\delta_i(\mathcal{E}_{N_e, N_r}) = \frac{t^i}{\prod_{j=0}^{i-1} (1 - \tilde{b} - \mathcal{E}_{N_e, N_r} - \Theta_j)}$$

which gives the equation 3. ■

Property 5 The bandwidth consumed at a transmitter node N_e due to its transmissions's collisions is equal to $\mathcal{E}_{N_e} \cdot D = D \sum_{\substack{\text{link}(N_e, N_r) \\ N_e \in \mathcal{S}(N)}} \mathcal{E}_{N_e, N_r}$. By convention, if the node N being considered is not a transmitter then $\mathcal{E}_N = 0$.

Property 6 The bandwidth consumed at a node N due to collisions is equal to

$$\frac{D}{2} \cdot (\mathcal{E}_N + \sum_{\substack{\text{link}(N_e, N_r) \\ N_e \in \mathcal{S}(N)}} \mathcal{E}'_{N_e, N_r}) \quad (5)$$

Proof: By construction, when a collision takes place, it involves two transmitters, denoted N and N_e . In this collision model, node N accounts for the collision effect twice: once in \mathcal{E}_N and another in \mathcal{E}'_{N_e, N_r} . As a consequence, the sum of bandwidth consumed due to collision computed at node N must be divided by two. ■

Validation by simulations

In order to validate this model, we have simulated several scenarios with NS-2. The results have confirmed the computed bandwidth consumed by the collisions. We now present an example of our simulations with 3 CBR flows at 250Kbps each, the other parameters are identical with those given in Tables 3 and 4. The three flows are located as in Figure 10. Any node is neighbor of nodes that are immediately above, below, at its left and at its right, and in its diagonal lines. Any node is in the interference area of nodes which are two hops away (see node 3). The flow f_1 goes through nodes 0 to 6, the flow f_2 goes through nodes 7 to 13 and the flow f_3 goes through nodes 14 to 20 in that order.

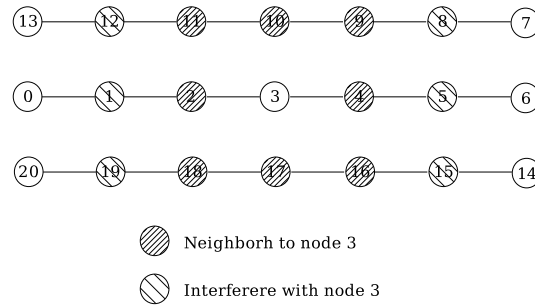

Figure 10: Three CBR flows going through nodes 0 to 6, 7 to 13 and 14 to 20.

We compute the total bandwidth consumed at each node of f_1 , including the collisions due to f_2 and f_3 . Figure 11 compares the results obtained by calculation with those obtained by simulation. We can notice the high accuracy of those results.

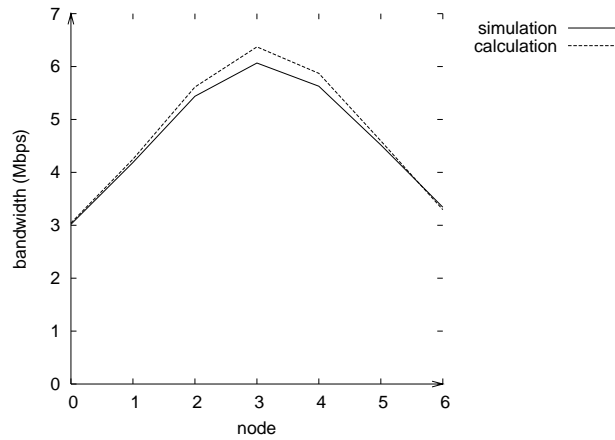

Figure 11: Calculation and simulation results in the presence of 3 CBR flows.

3.7 Algorithm to evaluate the bandwidth consumed at a node

We now present the algorithm used to evaluate the bandwidth B_N consumed at any node N in the network. In this algorithm, lines 4 and 7 correspond to the application of Property 1. Lines 5 and 6 correspond to the application of Property 2. Line 8 corresponds to the application of Property 4.

At node N , the inputs include:

- $\mathcal{N}_1(N)$ list of nodes in the neighborhood area of N .
- $\mathcal{N}_2(N)$ list of nodes in the interference area of N .
- $\mathcal{F} = \{f_1, f_2, \dots\}$ set of CBR flows in the surrounding of N .

The algorithm:

1. $B_N = 0$ /* Bandwidth consumed at N */
/* Computation of the bandwidth consumed by each flow in \mathcal{F} in isolation */
2. for each flow $f_i \in \mathcal{F}$:
3. for each node M_i visited by f_i :
4. if $M_i \in \mathcal{N}_1(N)$, then $B_N = B_N + \mathbb{1}_{n>0}(ACK) + \mathbb{1}_{m>0}(pck)$;
5. if $M_i \in \mathcal{N}_2(N)$, then
 $B_N = B_N + \mathbb{1}_{n>0}(ACK) + \mathbb{1}_{m>0}(pck) + \mathbb{1}_{(n>0)\&(m>0)}(DIFS)$;
6. if M_i is the destination of f_i , or $M_{i+1} \notin \mathcal{N}_1(N) \cup \mathcal{N}_2(N)$, then
 $B_N = B_N + EIFS$;
7. if N is a node of f_i and N is not the destination of f_i , then
 $B_N = B_N + 2 * DIFS + \overline{CW}_0$
/* Computation of the bandwidth consumed due to collisions */
8. $B_N = B_N + \frac{D}{2} \cdot (\mathcal{E}_N + \sum_{\substack{link(N_e, N_r) \\ N_e \in \mathcal{S}(N)}} \mathcal{E}'_{N_e, N_r})$

4 Admission Control

We propose in this section an admission control based on the bandwidth evaluation described in Section 3.

4.1 Principles

A new flow can be accepted only if the following condition is verified: the bandwidth that would be consumed by this flow can be granted to it at every node belonging to its route, its neighborhood area and its interference area, without compromising the bandwidth granted to already accepted flows.

The bandwidth that would be consumed by the new flow is evaluated according to the sub-section 3.7.

4.2 Admission control algorithm

We first recall the assumption concerning the flow in the surrounding of a node. We then briefly describe the admission control algorithm.

Assumption of the admission control: Each node on the route of the flow knows the residual bandwidth of all nodes located in its neighborhood area and its interference area. Each node also knows the number of flows already accepted in these areas.

Algorithm description

- The source sends an admission request message for the flow f_i , containing the route of f_i . This message is forwarded hop-by-hop to the destination. On receipt of this message, each node adds all nodes in its surrounding to the message, for each of them it provides the number of flows already accepted in the surrounding of that node.
- On receipt of this message, the destination knows all nodes in the surrounding of the flow. Thus it can evaluate their bandwidth according to the method described in sub-section 3.7. If all nodes have enough bandwidth to support f_i then the destination sends an acceptance message to the source. Otherwise, it sends a rejection message: the new flow cannot be accepted due to lack of resources.

5 Implementation Example with OLSR

In this section, we propose to implement this admission control by using the features provided by the routing protocol OLSR [1].

Measuring the available bandwidth

We suppose that the bandwidth available at a node is provided by the 802.11b card's driver. This information is not strictly necessary. However, if this information is known, it allows a better adaptability to traffic dynamicity.

Advertising the available bandwidth

The bandwidth available at a node must be advertised to all other nodes. This can be done as follows. Each node advertises in its *Hello* messages its available bandwidth and the number of accepted flows in its surrounding. The multipoint relays (*MPRs*) then advertise in their topology control (*TC*) messages the bandwidth available at their MPR-selectors. We recall that in OLSR, the *Hello* messages are only broadcast to 1 hop whereas the *TC* messages are broadcast to the whole network via the multipoint relays.

MPR selection algorithm

This MPR selection algorithm is modified in order to take into account the available bandwidth. It allows to reach all nodes at 2 hops away by a route with the highest available bandwidth.

Indeed, as it has been stated in [6] and [8], OLSR may not be able to find a route offering the required bandwidth, even when such a route exists. This is because the MPR selection algorithm does not account for the available bandwidth. That is why we adopt the MPR selection algorithm as proposed in [6]. This algorithm can lead to a higher number of selected MPRs than the native algorithm. It has been shown in [8] that in dense networks this number converges towards the number of MPRs selected by the native algorithm.

6 Accuracy of the Bandwidth Evaluation

In this section, we evaluate the accuracy of the computation of the bandwidth consumed at each node. We consider the example illustrated by Figure 12. The network includes 200 nodes randomly located on an area of $1800 \times 1800 m^2$. The coverage radius is $250m$ and the interference area is the corona whose inner radius is $250m$ and outer radius is $550m$. Four CBR flows are randomly chosen and their routes are determined using the routing algorithm provided by the OLSR protocol. Those routes are fixed during the simulations. The 4 flows have the same bit rate of $250Kbps$ each at application level and the same packet size of 1500 bytes. Table 5 sums up the parameters of each flow.

	nb hops	route
f_1	8	9, 109, 10, 159, 69, 138, 62, 57, 143
f_2	4	30, 70, 173, 94, 104
f_3	7	84, 2, 149, 136, 70, 30, 154, 23
f_4	5	71, 19, 73, 42, 87, 162

Table 5: Parameters of 4 CBR flows.

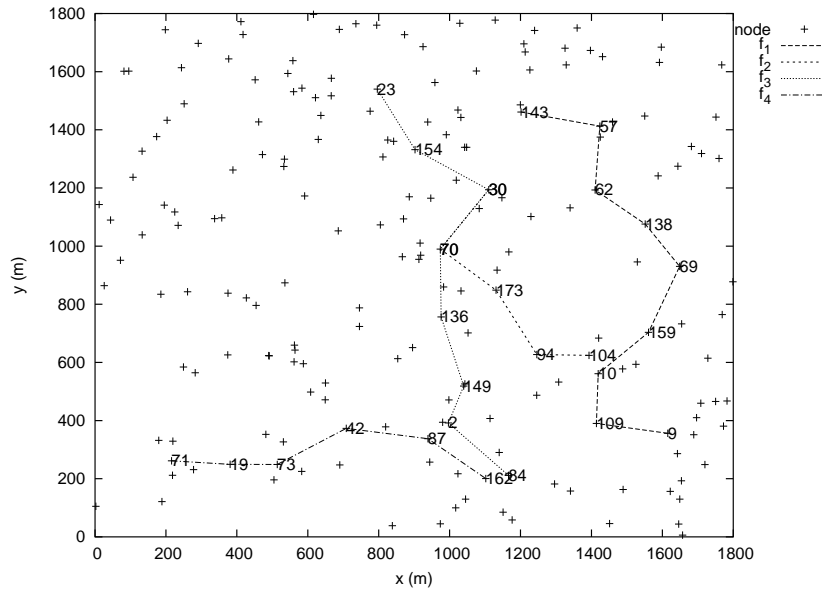

Figure 12: Scenario with 200 nodes and 4 flows.

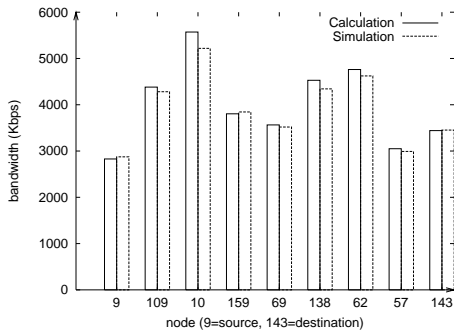

Figure 13: Flow 1.

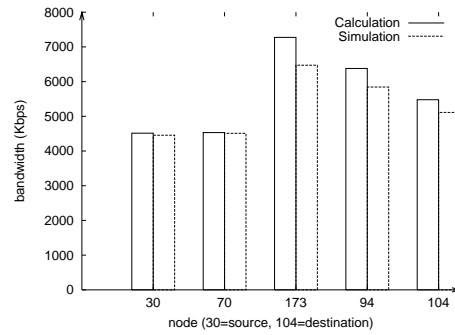

Figure 14: Flow 2.

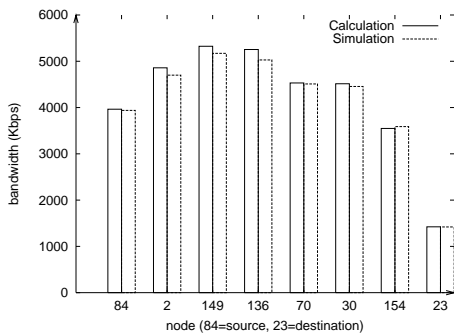

Figure 15: Flow 3.

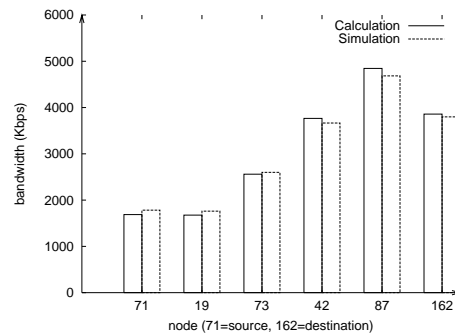

Figure 16: Flow 4.

Figures 13, 14, 15 and 16 respectively illustrate the bandwidth results obtained by calculation and simulation at each node visited by the flows f_1 , f_2 , f_3 and f_4 . Notice that the relative average errors of computation are low: 2.5% for the bandwidth of f_1 , 6.1% for f_2 , 1.8% for f_3 and 3.3% for f_4 .

7 Conclusion

Accounting for interferences is required for the efficiency of an admission control in a multihop ad-hoc network supporting quality of service. In this report, we have shown how to evaluate the bandwidth consumed by a flow at each node in its surrounding. We first performed this evaluation by examining each flow in isolation. We then developed a mathematical model allowing to evaluate the bandwidth lost due to collisions. The simulations under NS-2 confirmed the high accuracy of the results we obtained. To continue this study, two topics can be distinguished: how to extend this evaluation to TCP flows and how to take into account node mobility. The combination of measures and computations of available bandwidth allows to obtain an efficient admission control and a good stability of the network.

References

- [1] Adjih C., Clausen T., Jacquet P., Laouiti A., Minet P., Muhlethaler P., Qayyum A. and Viennot L.: *Optimized Link State Routing Protocol (OLSR)*, RFC 3626, IETF, October 2003.
- [2] Perkins C., Belding-Royer E. and Chakeres I.: *Ad Hoc On-Demand Distance Vector (AODV) Routing*, RFC 3561, IETF, July 2003.
- [3] Chaudet C. and Guérin-Lassous I.: *BRuIT: Bandwidth Reservation under InTerferences influence*, in European Wireless EW'02, pages 466-472, Firenze, Italy, February 2002.
- [4] Ahn G-S., Campbell A., Veres A. and Sun L-H.: *Supporting Service Differentiation for Real-Time and Best Effort Traffic in Stateless Wireless Ad Hoc Networks (SWAN)*, in IEEE Transactions on Mobile Computing, September 2002.
- [5] Allard G., Georgiadis L., Jacquet P. and Mans B.: *Bandwidth Reservation in Multihop Wireless Networks: Complexity, Heuristics and Mechanisms*, to appear in International Journal of Wireless and Mobile Computing, 2004.
- [6] Ge Y., Kunz T., and Lamont L.: *Quality of Service Routing in Ad-Hoc Networks Using OLSR*, in proceedings of the 36th Hawaii International Conference on System Sciences (HICSS'03), Hawaii, USA, January 2003.
- [7] Veres A., Campbell A., Barry M. and Sun L-H.: *Supporting Service Differentiation in Wireless Packet Networks Using Distributed Control*, in IEEE Journal on Selected Areas in Communications, vol. 19, n° 10, October 2001.
- [8] Badis H., Munaretto A., Al Agha K. and Pujolle G.: *Optimal Path Selection on a Link state QoS Routing*, in VTC'2004 Spring, Milan, Italy, May 2004.
- [9] Bianchi G.: *Performance Analysis of the IEEE 802.11 Distributed Coordination Function*, in IEEE Journal on Selected Areas in Communications, vol. 18, n° 3, March 2000.



Unité de recherche INRIA Rocquencourt
Domaine de Voluceau - Rocquencourt - BP 105 - 78153 Le Chesnay Cedex (France)

Unité de recherche INRIA Futurs : Parc Club Orsay Université - ZAC des Vignes
4, rue Jacques Monod - 91893 ORSAY Cedex (France)

Unité de recherche INRIA Lorraine : LORIA, Technopôle de Nancy-Brabois - Campus scientifique
615, rue du Jardin Botanique - BP 101 - 54602 Villers-lès-Nancy Cedex (France)

Unité de recherche INRIA Rennes : IRISA, Campus universitaire de Beaulieu - 35042 Rennes Cedex (France)

Unité de recherche INRIA Rhône-Alpes : 655, avenue de l'Europe - 38334 Montbonnot Saint-Ismier (France)

Unité de recherche INRIA Sophia Antipolis : 2004, route des Lucioles - BP 93 - 06902 Sophia Antipolis Cedex (France)

Éditeur
INRIA - Domaine de Voluceau - Rocquencourt, BP 105 - 78153 Le Chesnay Cedex (France)
<http://www.inria.fr>
ISSN 0249-6399