



HAL
open science

Stochastic Dynamics of Discrete Curves and Exclusion Processes. Part 2: Functional Equations and Continuous Descriptions

Guy Fayolle, Cyril Furtlehner

► **To cite this version:**

Guy Fayolle, Cyril Furtlehner. Stochastic Dynamics of Discrete Curves and Exclusion Processes. Part 2: Functional Equations and Continuous Descriptions. [Research Report] RR-5808, INRIA. 2006, pp.67. inria-00070216

HAL Id: inria-00070216

<https://inria.hal.science/inria-00070216>

Submitted on 19 May 2006

HAL is a multi-disciplinary open access archive for the deposit and dissemination of scientific research documents, whether they are published or not. The documents may come from teaching and research institutions in France or abroad, or from public or private research centers.

L'archive ouverte pluridisciplinaire **HAL**, est destinée au dépôt et à la diffusion de documents scientifiques de niveau recherche, publiés ou non, émanant des établissements d'enseignement et de recherche français ou étrangers, des laboratoires publics ou privés.

***Stochastic Dynamics of Discrete Curves and
Exclusion Processes.***
***Part 2: Functional Equations and Continuous
Descriptions***

Guy Fayolle — Cyril Furtlehner

N° 5808 – version 2

version initiale Janvier 2006 – version révisée Mars 2006

Thème BIO



***rapport
de recherche***

Stochastic Dynamics of Discrete Curves and Exclusion Processes.

Part 2: Functional Equations and Continuous Descriptions

Guy Fayolle *, Cyril Furtlehner *

Thème BIO — Systèmes biologiques

Projet Preval

Rapport de recherche n° 5808 – version 2[†] — version initiale Janvier 2006 —
version révisée Mars 2006 70 pages

Abstract: This report deals with continuous limits of several one-dimensional diffusive systems, obtained from stochastic distortions of discrete curves with different kinds of coding. These systems are indeed special cases of reaction-diffusion. A general functional formalism is set up, allowing to grapple with hydrodynamic limits. We also analyse the steady-state regime, not only in the reversible case, so that the invariant measure can have a non Gibbs form. A link is made between recursion properties, which originate matrix solutions, and particle cycles in the state-graph, by introducing loop currents on the analogy with electric circuits. Also, by means of the aforementioned functional approach, a bridge is established between structural constants involved in the recursions at discrete level and the constants which appear in Lotka-Volterra equations describing the fluid limits of stationary states. Finally the Lagrangian for the current fluctuations is obtained from an iterative scheme, and the related Hamilton-Jacobi equation, leading to the large deviation functional, is solved at least in the reversible case allowing to rediscover some known results.

* INRIA Rocquencourt

† Some definitions were missing in version 1. Stylistic improvements have also been done.

Key-words: Exclusion process, Gibbs state, hydrodynamic limit, functional equation, current, Hamilton-Jacobi.

Dynamique stochastique de courbes discrètes et processus d'exclusion. Partie 2 : Équations fonctionnelles et représentations continues

Résumé : Cette étude est dédiée à l'analyse des limites continues de divers systèmes diffusifs unidimensionnels, qui décrivent notamment les déformations stochastiques de courbes discrètes, codées de différentes façons. Ces systèmes constituent des cas particuliers de réactions-diffusions. Un formalisme fonctionnel général est élaboré pour traiter la limite hydrodynamique. On s'intéresse également au régime stationnaire, les processus n'étant pas nécessairement réversibles et pouvant alors donner lieu à des états de type non-Gibbs. Un lien est établi entre les propriétés récursives à l'origine des solutions matricielles et les cycles dans un graphe d'états, en introduisant des courants de boucle, par analogie avec des circuits électriques. En outre, à l'aide de l'approche fonctionnelle précitée, on peut faire le pont entre les constantes de structure impliquées dans ces relations de récurrence au niveau discret et les constantes apparaissant dans les systèmes de type Lotka-Volterra, lesquels décrivent la limite fluide des états stationnaires. Finalement, à partir d'un schéma itératif, on obtient le Lagrangien qui rend compte des fluctuations de courants de particules. L'équation de Hamilton-Jacobi qui en découle –et dont on extrait la fonctionnelle de grande déviation– est résolue dans le cas réversible, permettant de retrouver certains résultats établis par ailleurs.

Mots-clés : Processus d'exclusion, état de Gibbs, limite hydrodynamique, équation fonctionnelle, courant, Hamilton-Jacobi.

Contents

1	Introduction	6
2	Model definition	8
2.1	A stochastic clock model	8
2.2	Examples	8
3	Transient regime codings	10
3.1	Coding of the generator	10
3.1.1	Fourier transform with boolean variables	10
3.1.2	Generating function for ASEP dynamics	11
3.1.3	The general n model	13
3.2	Coding space-time dynamical constraints with binary variables	14
3.2.1	Constraint coding	15
3.3	Discrete stochastic equations	17
3.3.1	The random telegraph problem	17
3.3.2	The simple exclusion problem	18
4	Hydrodynamic limits	19
4.1	Functional integral equations	19
4.2	About correlations in the ABC model	22
4.2.1	An approximate solution of (4.4)	23
5	Reversible stationary states	25
5.1	The invariant measure	25
5.2	Free energy and metastable configurations	26
5.3	Ehrenfest urn model interpretation	28
5.4	The square lattice model	29
5.4.1	The invariant measure	29
5.4.2	Two continuous descriptions and a functional mapping	31
6	Non-Gibbs steady state regime	33
6.1	The tagged particle	34
6.2	Cycles in the state-graph and matrix-form solutions	37
6.2.1	Tagged particle cycles	37
6.2.2	Cycle combinatorics	39
6.2.3	Cycle currents and matrix solutions	41
6.3	A system of detailed equations for currents	44
6.4	Fluid limits	47
6.4.1	From the hydrodynamic functional	47
6.4.2	Lotka-Volterra systems and out-of-equilibrium stationary states	50
6.5	Permanent currents at steady state	51

6.5.1	A scheme with currents	51
6.5.2	The square-lattice model	55
7	Local equilibrium and stochastic corrections	58
7.1	Time-scale for local equilibrium	58
7.2	Microscopic currents	59
7.2.1	Particle currents	59
7.2.2	An iterative numerical scheme	60
7.2.3	Central limit theorem for currents	61
7.3	Macroscopic fluctuations	64
7.3.1	The Lagrangian	64
7.3.2	Hamilton-Jacobi equation and large deviation functional	65
8	Concluding Remarks	67

1 Introduction

Interplay between discrete and continuous description is a recurrent question in statistical physics, which in some cases can be addressed quite rigorously via probabilistic methods. In the context of reaction-diffusion systems this amounts to studying fluid or hydrodynamics limits, and number of approaches have been proposed, in particular in the framework of exclusion processes, see [24],[7] [30], [22] and references therein. As far as the above limits are at stake, all these methods have in common to be limited to systems having stationary states given in closed product form, or at least to systems for which the invariant measure for finite N is explicitly known. For instance, ASEP with open boundary are described in terms of matrix product form (really a kind of noncommutative product form), and the continuous limits can be understood by means of Brownian bridges [8]. We propose to tackle these problems from a different view-point. The initial objects are discrete sample paths enduring stochastic deformations, and our primary concern is to understand the nature of the limit curves, when N goes to infinity: how do they evolve in time, and which limiting process do they represent as t goes to infinity: in other words, what are the equilibrium curves? Following [14] and [15], we give here some partial answers to these questions.

In [14] a specific model was considered, namely paths on the square lattice, and we could reformulate the problem in terms of coupled exclusion processes, to understand the thermodynamic equilibrium and a phase transition point above which curves reach a deterministic profile, solution of a nonlinear dynamical system which was solved explicitly by means of elliptic functions. Two extensions of this system were introduced in [15] :

- one which comprises multi-type exclusion particle systems appearing in another context (see e.g. [12, 13]), including the *ABC* model for which similar features occur [6];
- a tri-coupled exclusion process to represent the stochastic dynamics of curves in the three dimensional space.

In this extended formulation, we provided a set of general conditions for reversibility, by analyzing cycles in the state space, together with the corresponding invariant measure.

In this paper, we focus on non-Gibbs states and transient regimes. In another work in progress [16], we analyze the asymmetric simple exclusion process (ASEP) on a torus.

Under suitable initial conditions, the usual sequence of empirical measures converges in probability to a deterministic measure, which is the unique weak solution of a Cauchy problem. The method presents some new features, and relies on the analysis of a family of parabolic differential operators, involving variational calculus. This approach let hope for a pretty large level of generalization, and we are working over its general conditions of validity: some of them are anticipated in section 4 of the present report, where we establish the complete hierarchy of hydrodynamic equations for multi-types particle systems.

Sections 5 and 6 are devoted to the stationary regime, for which, from [14] and [15], the limit curves are known to satisfy a differential system of Lotka-Volterra type which is the essence of the fluid limits in our context. Section 5 solves the steady state regime in the reversible case. A geometric interpretation of the free energy is provided (involving the algebraic area enclosed by the curve), as well as an urn model description for the underlying dynamical system, leading precisely to a Lotka-Volterra system.

Non-Gibbs states are considered in section 6. In [15], necessary and sufficient conditions for reversibility were given, by identification of a family of independent cycles in the state graph, for which Kolmogorov's criteria have to be fulfilled. We pursue this analysis, by showing that irreversibility occurs as a result of particle currents attached to these cycles. A connection between recursion properties, originating matrix solutions, and particle cycles in the state-graph is found, with the introduction of loop currents, on the analogy with electric circuits. These recursions at discrete level connect together invariant measures of systems of size N and of size $N - 1$, and they involve coefficients to which we are able to give a meaning in the fluid limit, as $N \rightarrow \infty$. With the help of the functional approach, these structural constants are shown to be mapped onto the constants intervening in the Lotka-Volterra systems describing the fluid limits. We extend the iterative scheme procedure initiated in [14] and developed in [15], which originally concerned only the steady-state regime. In fact, this scheme also allows us to express in transient regime particle-currents in terms of deterministic particle densities: this is a mere consequence of a law of large numbers. At least when the diffusion scale is identical for all particle species, local correlations are found to be absent. In the last section 7, we observe that local equilibrium takes place at a rapid time-scale, compared to the diffusion time which is the natural scale of the system. In the spirit of the study made in [3], we obtain the Lagrangian describing the fluctuations of currents, and we analyze the related Hamilton-Jacobi equations.

2 Model definition

2.1 A stochastic clock model

The system consists of an oriented path embedded in a bidimensional manifold, with N steps of equal size, each one being chosen among a discrete set of n possible orientations, drawn from the set $\{2k\pi/n, k = 0 \dots n - 1\}$ of angles with some given origin. The stochastic dynamics in force consists in displacing one single point at a time without breaking the path, while keeping all links within the set of admissible orientations. In this operation, two links are simultaneously displaced. This constrains quite strongly the possible dynamical rules, which are given in terms of *reactions* between consecutive links.

For any n , we can define

$$X^k X^l \xrightleftharpoons[\lambda_{lk}]{\lambda_{kl}} X^l X^k, \quad k \in [1, n], k \neq l, \quad (2.1)$$

which in the sequel will be sometimes referred to as a local exchange process. It is necessary to discriminate between n odd and n even. Indeed, for $n = 2p$, there is another set of possible stochastic rules:

$$\begin{cases} X^k X^l \xrightleftharpoons[\lambda_{lk}]{\lambda_{kl}} X^l X^k, & k = 1, \dots, n, \quad l \neq k + p, \\ X^k X^{k+p} \xrightleftharpoons[\delta^{k+1}]{\gamma^k} X^{k+1} X^{k+p+1}, & k = 1, \dots, n. \end{cases} \quad (2.2)$$

The distinction is simply due to the presence, for even n , of *folds* (two consecutive links with opposite directions), which may undergo different transition rules, leading to a richer dynamics. The set of transitions rates $\{\lambda_{kl}\}$ represent the rates of exchange between two consecutive links, while the γ_k 's and δ_k 's correspond to the rotation of a fold to the right or to the left.

2.2 Examples

1) *The simple exclusion process*

The first elementary and most studied example is the simple exclusion process, which after mapping particles onto links corresponds to one-dimensional fluctuating interface. In that case, we simply have a binary alphabet. Letting $X^1 = \tau$ and $X^2 = \bar{\tau}$, the reactions rewrite

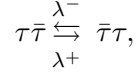

where λ^\pm is the transition rate for the jump of a particle to the right or to the left.

1) *The triangular lattice and the ABC model*

Here the evolution of the random walk is restricted to the triangular lattice. A link (or step) of the walk is either 1, $e^{2i\pi/3}$ or $e^{4i\pi/3}$, and quite naturally will be said to be of type A, B and C, respectively. This corresponds to the so-called *ABC model*, since there is a coding by a 3-letter alphabet. The set of *transitions* (or reactions) is given by

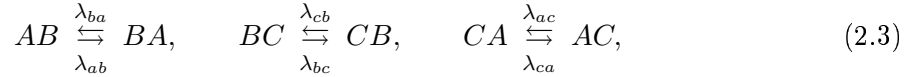

where the rates are arbitrary positive numbers. Also we impose *periodic boundary conditions* on the sample paths. This model was first introduced in [12] in the context of particles with exclusion, and, for some cases corresponding to reversibility, a Gibbs form has been found in [13].

2) *A coupled exclusion model in the square lattice*

This model was introduced in [14] to analyze stochastic distortions of a walk in the square lattice, and from now on will be referred to as the $\{\tau_a\tau_b\}$ model. Assuming links are counterclockwise oriented, the following transitions can take place.

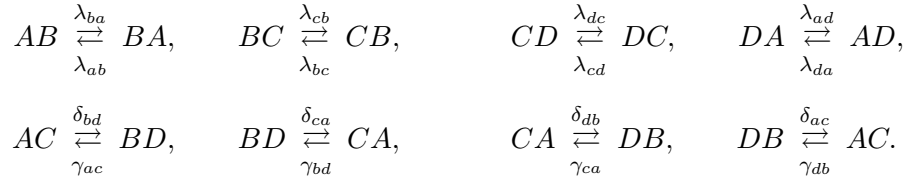

We studied a rotation invariant version of this model, namely when

$$\left\{ \begin{array}{l} \lambda^+ \stackrel{\text{def}}{=} \lambda_{ab} = \lambda_{bc} = \lambda_{cd} = \lambda_{da}, \\ \lambda^- \stackrel{\text{def}}{=} \lambda_{ba} = \lambda_{cb} = \lambda_{dc} = \lambda_{ad}, \\ \gamma^+ \stackrel{\text{def}}{=} \gamma_{ac} = \gamma_{bd} = \gamma_{ca} = \gamma_{db}, \\ \gamma^- \stackrel{\text{def}}{=} \delta_{ac} = \delta_{bd} = \delta_{ca} = \delta_{db}. \end{array} \right. \quad (2.4)$$

Define the mapping $(A, B, C, D) \rightarrow (\tau^a, \tau^b) \in \{0, 1\}^2$, such that

$$\begin{cases} A \rightarrow (0, 0), \\ B \rightarrow (1, 0), \\ C \rightarrow (1, 1), \\ D \rightarrow (0, 1). \end{cases}$$

Then the dynamics can be formulated in terms of coupled exclusion processes. The evolution of the sample path is represented by a Markov process with state space the set of $2N$ -tuples of binary random variables $\{\tau_j^a\}$ and $\{\tau_j^b\}$, $j = 1, \dots, N$, taking the value 1 if a particle is present and 0 otherwise. The jump rates to the right (+) or to the left (-) are then given by

$$\begin{cases} \lambda_a^\pm(i) = \bar{\tau}_i^b \bar{\tau}_{i+1}^b \lambda^\mp + \tau_i^b \tau_{i+1}^b \lambda^\pm + \bar{\tau}_i^b \tau_{i+1}^b \gamma^\mp + \tau_i^b \bar{\tau}_{i+1}^b \gamma^\pm, \\ \lambda_b^\pm(i) = \bar{\tau}_i^a \bar{\tau}_{i+1}^a \lambda^\pm + \tau_i^a \tau_{i+1}^a \lambda^\mp + \bar{\tau}_i^a \tau_{i+1}^a \gamma^\pm + \tau_i^a \bar{\tau}_{i+1}^a \gamma^\mp. \end{cases} \quad (2.5)$$

Notably, one sees the jump rates of a given sequence are locally conditionally defined by the complementary sequence.

3 Transient regime codings

3.1 Coding of the generator

3.1.1 Fourier transform with boolean variables

For boolean variables, the Fourier transform takes a very simple form. Let $s \in \{-1, 1\}$ and $f : s \rightarrow f(s)$ a real valued function. Due to the boolean nature of s , f takes only two values, $f(\pm 1) \stackrel{\text{def}}{=} f_{\pm 1}$, giving rise to the following binary decomposition,

$$f(s) = \frac{s+1}{2} f_1 + \frac{1-s}{2} f_{-1} = \frac{f_1 + f_{-1}}{2} + \frac{f_1 - f_{-1}}{2} s.$$

Call $\tau \in \{0, 1\}$ the dual variable of s , and $g : \tau \rightarrow g(\tau)$, which admits of the decomposition

$$g(\tau) \stackrel{\text{def}}{=} \bar{\tau} g_0 + \tau g_1,$$

with $g(0) = g_0$ and $g_1 = g(1)$. By definition, g is the Fourier transform of f if

$$\begin{cases} g_0 \stackrel{\text{def}}{=} \frac{1}{\sqrt{2}}(f_1 + f_{-1}), \\ g_1 \stackrel{\text{def}}{=} \frac{1}{\sqrt{2}}(f_1 - f_{-1}). \end{cases}$$

The relation between f and g can be rewritten in the form

$$\begin{aligned} f(s) &= \frac{1}{\sqrt{2}} \sum_{\tau \in \{0,1\}} (\bar{\tau} + \tau s) g(\tau), \\ g(\tau) &= \frac{1}{\sqrt{2}} \sum_{s \in \{-1,1\}} (\bar{\tau} + \tau s) f(s). \end{aligned} \tag{3.1}$$

By letting $\tilde{\tau} = \frac{s-1}{2}$, the kernel $\bar{\tau} + \tau s$ takes also the more conventional form

$$\bar{\tau} + \tau s = e^{i\pi\tau\tilde{\tau}},$$

This formalism easily apply to ternary variables, by considering the eigenstates of the permutation operator σ (acting on the values of the variables), s being the corresponding eigenvalue.

3.1.2 Generating function for ASEP dynamics

With the help of the preceding formalism, the following proposition yields an operator representation for the backward generator of the ASEP dynamics.

Proposition 3.1. *Let $\{\tau_i, i = 1 \dots N\}$ and $\{\bar{\tau}_i, i = 1 \dots N\}$ a set of $2N$ boolean variables with the following algebraic properties*

$$\forall i \in \{1 \dots N\} \quad \begin{cases} \tau_i \bar{\tau}_i = \tau_i, \\ \tau_i \bar{\tau}_i = 0, \end{cases}$$

$\mathcal{V}^{(N)}$ denoting the ring of homogeneous polynomials of degree N in these variables. Let also $\{\sigma_i, i = 1 \dots N\}$ be a set of operators acting on $\mathcal{V}^{(N)}$, such that, for any

$P \in \mathcal{V}^{(N)}$, $\sigma_i P$ is obtained by exchanging τ_i and $\bar{\tau}_i$ in P . Let Then any function of the particle sequence is an element of $\mathcal{V}^{(N)}$, and the generator takes the form

$$G = \sum_{i=1}^N g_{i+\frac{1}{2}}, \quad (3.2)$$

with

$$\begin{aligned} g_{i+\frac{1}{2}} &= \lambda^+(\sigma_i \sigma_{i+1} - 1) \tau_i \bar{\tau}_{i+1} + \lambda^-(\sigma_i \sigma_{i+1} - 1) \bar{\tau}_i \tau_{i+1} \\ &= \bar{\tau}_i \tau_{i+1} (\lambda^+ \sigma_i \sigma_{i+1} - \lambda^-) + \tau_i \bar{\tau}_{i+1} (\lambda^- \sigma_i \sigma_{i+1} - \lambda^+), \end{aligned}$$

where λ^\pm are the transition rates of a particle jump to the left(-) or to the right (+). ■

At this point it is useful to introduce the dual space of $\tilde{\mathcal{V}}^{(N)}$ of $\mathcal{V}^{(N)}$, the set of functions of $\{s_i \in \{-1, 1\}, i = 1 \dots N\}$. A given state can be indifferently represented by an element $P \in \mathcal{V}^{(N)}$ or $\tilde{P} \in \tilde{\mathcal{V}}^{(N)}$. Both are related through the Fourier transforms

$$\begin{aligned} \tilde{P}(\{s\}) &= \sum_{\{\tau\}} \prod_{i=1}^N \frac{1}{\sqrt{2}} (\bar{\tau}_i + s_i \tau_i) P(\{\tau\}), \\ P(\{\tau\}) &= \sum_{\{s\}} \prod_{i=1}^N \frac{1}{\sqrt{2}} (\bar{\tau}_i + s_i \tau_i) \tilde{P}(\{s\}). \end{aligned}$$

Using these representations, it is then possible to write a scheme expressing the dynamics of the system.

Lemma 3.2. *Let $P(\tau, t) \in \mathcal{V}^{(N)}$ the state of the system at time t and $\tilde{P}(s, t) \in \tilde{\mathcal{V}}^{(N)}$ its Fourier transform. The Markov evolution of the system is given by the following dynamical scheme:*

$$\begin{cases} P(\{\tau\}, t + \delta t) = \sum e^{i\frac{\pi}{2} \sum_{i=1}^N \tau_i (1+s_i) + \delta t \tilde{G}(\tau, s)} \tilde{P}(\{s\}, t), \\ \tilde{P}(\{s\}, t + \delta t) = \sum_{\tau} e^{i\frac{\pi}{2} \sum_{i=1}^N \tau_i (1+s_i) + \delta t G(s, \tau)} P(\{\tau\}, t), \end{cases}$$

with

$$G(s, \tau) = \sum_{i=1}^N (s_i s_{i+1} - 1) (\lambda^+ \tau_i \bar{\tau}_{i+1} + \lambda^- \bar{\tau}_i \tau_{i+1}),$$

$$\tilde{G}(\tau, s) = \sum_{i=1}^N \bar{\tau}_i \tau_{i+1} (\lambda^+ s_i s_{i+1} - \lambda^-) + \tau_i \bar{\tau}_{i+1} (\lambda^- s_i s_{i+1} - \lambda^+).$$

The invariant measure satisfies the system

$$\begin{cases} \sum e^{i\frac{\pi}{2} \sum_{i=1}^N \tau_i (1+s_i) + \delta t \tilde{G}(\tau, s)} \tilde{G}(\tau, s) \tilde{P}(\{s\}) = 0, \\ \sum_{\tau} e^{i\frac{\pi}{2} \sum_{i=1}^N \tau_i (1+s_i) + \delta t \tilde{G}(\tau, s)} G(s, \tau) P(\{\tau\}) = 0. \end{cases}$$

■

In some situations, the above conditions concerning steady state distribution may prove convenient. For instance, a set of sufficient conditions is given by

$$\sum_s [\tau_{i+1} - \tau_i] [\lambda^- s_{i+1} - \lambda^+ s_i] \tilde{P}(s) = 0, \quad i = 1 \dots N,$$

$$\sum_{\tau} [s_{i+1} - s_i] [\lambda^+ \tau_i \bar{\tau}_{i+1} - \lambda^- \bar{\tau}_i \tau_{i+1}] P(\tau) = 0, \quad i = 1 \dots N.$$

3.1.3 The general n model

For the sake of simplicity, we restrict ourselves to the case of an odd alphabet, where reactions 2.1 consists only in exchanging neighbouring letters. Let σ_i represent the circular permutation among the possible letters at a given site i ,

$$(X_i^1, X_i^2, X_i^3 \dots X_i^n) \rightarrow (X_i^n, X_i^1, X_i^2 \dots X_i^{n-1}).$$

As before, $\mathcal{V}^{(N)}$ is the set of functions of $\{X_i^1, X_i^2, X_i^3 \dots X_i^n, i = 1 \dots N\}$ which actually reduces to a homogeneous polynomial ring, due to the binary nature of all variables and the exclusion constraint

$$\forall i \in \{1 \dots N\}, \quad X_i^k X_i^l = X_i^l \delta_{kl}.$$

Similar properties hold for $\tilde{\mathcal{V}}^{(N)}$ as the set of function of $\{\tilde{X}_i^1, \tilde{X}_i^2, \tilde{X}_i^3 \dots \tilde{X}_i^n, i = 1 \dots N\}$. The Fourier transforms between two representation P and \tilde{P} of the same state now reads

$$\begin{aligned}\tilde{P}(\{\tilde{X}\}) &= \sum_{\{X\}} \prod_{i=1}^N \frac{1}{\sqrt{n}} \exp\left(\frac{2i\pi}{n} \sum_{i=1, k, l=1}^{N, n} klX_i^k \tilde{X}_i^l\right) P(\{X\}), \\ P(\{X\}) &= \sum_{\{\tilde{X}\}} \prod_{i=1}^N \frac{1}{\sqrt{n}} \exp\left(-\frac{2i\pi}{n} \sum_{i=1, k, l=1}^{N, n} klX_i^k \tilde{X}_i^l\right) \tilde{P}(\{\tilde{X}\}).\end{aligned}$$

As for the generator, we get directly, for an odd n ,

$$G = \sum_{i=1}^N \sum_{k, l}^n \lambda_{kl} (\sigma_i \sigma_{i+1} - 1) X_i^l X_{i+1}^k = \sum_{i=1}^N \sum_{k, l}^n X_i^l X_{i+1}^k (\lambda_{kl} \sigma_i \sigma_{i+1} - \lambda_{lk}).$$

The dynamical scheme is then given by

$$\begin{cases} P(\{X\}, t + \delta t) = \sum_{\tilde{X}} e^{-\frac{2i\pi}{n} \sum_{i, kl} klX_i^k \tilde{X}_i^l + \delta t \tilde{G}(X, \tilde{X})} \tilde{P}(\{\tilde{X}\}, t) \\ \tilde{P}(\{\tilde{X}\}, t + \delta t) = \sum_X e^{\frac{2i\pi}{n} \sum_{i, kl} klX_i^k \tilde{X}_i^l + \delta t G(\tilde{X}, X)} P(\{X\}, t), \end{cases}$$

where

$$\begin{aligned}G(\tilde{X}, X) &= \sum_{i=1}^N \sum_{k, l, k', l'}^n \lambda_{kl} \left(e^{\frac{2i(k'+l')\pi}{n}} \tilde{X}_i^{k'} \tilde{X}_{i+1}^{l'} - 1 \right) X_i^k X_{i+1}^l, \\ \tilde{G}(X, \tilde{X}) &= \sum_{i=1}^N \sum_{k, l, k', l'}^n (\lambda_{kl} e^{\frac{2i(k'+l')\pi}{n}} \tilde{X}_i^{k'} \tilde{X}_{i+1}^{l'} - \lambda_{lk}) X_i^l X_{i+1}^k.\end{aligned}$$

We see that this scheme allows to write the transition amplitude for a state at time t , conditionally on the state at time t_0 , as a sum over path in the space (X, \tilde{X}) with exponential weighting factors, which might be suitable for getting asymptotic limits for large N .

3.2 Coding space-time dynamical constraints with binary variables

Another possibility to achieve the same goal, namely to derive a generating function for the dynamical evolution of the system, is to consider space-time samples of binary

variables, and to impose constraints on these variables, so that they correspond to an admissible evolution of the sample path.

3.2.1 Constraint coding

For the sake of simplicity, we will restrict ourselves to the ASEP system for the set-up a space-time formalism. The sums will be taken over all possible processes $\{\tau_i^j \in \{0, 1\}\}$, having 0 or 1 particle at site $i \in \{1 \dots N\}$ and a discretized time-stamp $j \in \{1 \dots M\}$. When considering the partition function, we have to attach a specific weight w^2 each time a particle jumps from one site i to the next one $i + 1$ in the time interval $[j, j + 1]$. There are clearly additional constraints, since all processes are not allowed: the only possible differences between a sequence taken at time j and at time $j + 1$ come only from right jumps, particles entering the system from the left tip $i = 1$ or leaving it through the right tip $i = N$. To cope with these constraints, we introduce two auxiliary fields $s_{i+\frac{1}{2}}^{j+\frac{1}{2}} \in \{-1, 1\}$ and $\sigma_{i+\frac{1}{2}}^{j+\frac{1}{2}} \in \{-1, 1\}$ living on the dual lattice. The purpose of such a field is to correlate transitions at site i and site $i + 1$, between time-stamps j and $j + 1$, when a particle jumps. We have

$$Z = \sum_{\{T\}, \{S\}} F_{\text{edges}} \prod_{i=2, j=0}^{N-1, M} \left(\tau_i^j \tau_i^{j+1} (1 - w \sigma_{i+\frac{1}{2}}^{j+\frac{1}{2}}) + \bar{\tau}_i^j \bar{\tau}_i^{j+1} (1 + w \sigma_{i-\frac{1}{2}}^{j+\frac{1}{2}}) \right. \\ \left. + w \left(\bar{\tau}_i^j \tau_i^{j+1} s_{i-\frac{1}{2}}^{j+\frac{1}{2}} + \tau_i^j \bar{\tau}_i^{j+1} s_{i+\frac{1}{2}}^{j+\frac{1}{2}} \right) \right), \quad (3.3)$$

with F_{edges} depending on the boundary conditions. For open boundary, with particles entering the system at site $i = 0$ and departing at site $i = N$, we obtain

$$F_{\text{edges}} = \prod_{j=0}^M \left(\tau_1^j \tau_1^{j+1} (1 - w \sigma_{\frac{3}{2}}^{j+\frac{1}{2}}) + \bar{\tau}_1^j \bar{\tau}_1^{j+1} (1 - A) + A \bar{\tau}_1^j \tau_1^{j+1} + w \tau_1^j \bar{\tau}_1^{j+1} s_{\frac{3}{2}}^{j+\frac{1}{2}} \right) \\ \left(\tau_N^j \tau_N^{j+1} (1 - B) + \bar{\tau}_N^j \bar{\tau}_N^{j+1} (1 + w \sigma_{N-\frac{1}{2}}^{j+\frac{1}{2}}) + B \tau_N^j \bar{\tau}_N^{j+1} + w \tau_N^j \bar{\tau}_N^{j+1} s_{N-\frac{1}{2}}^{j+\frac{1}{2}} \right) \quad (3.4)$$

As a verification, consider a system with only 2 sites and open boundary conditions, with rates α, β, λ , respectively for input, output and jump. Using the binary variables

to write the matrix elements of the transition operator, we get

$$P(\tau_1, \tau_2, t + dt) = P(\tau_1, \tau_2, t) + dt \sum_{\tau'_1, \tau'_2} \left(\alpha(\bar{\tau}'_1 \tau_1 - \bar{\tau}'_1 \bar{\tau}_1)(\tau'_2 \tau_2 + \bar{\tau}'_2 \bar{\tau}_2) \right. \\ \left. + \lambda(\tau'_1 \bar{\tau}_1 \bar{\tau}'_2 \tau_2 - \tau'_1 \tau_1 \bar{\tau}'_2 \bar{\tau}_2) + \beta(\tau'_2 \bar{\tau}_2 - \tau'_2 \tau_2)(\tau'_1 \tau_1 + \bar{\tau}'_1 \bar{\tau}_1) \right) P(\tau'_1, \tau'_2, t).$$

Letting $N = 2$ and $w^2 = \lambda dt$ in (3.3), $A = \alpha dt$ and $B = \beta dt$ in (3.4) and summing over the auxiliary variables s and σ , one checks readily the correct transition functions are obtained at first order in dt . Again, Z can be recast in an exponential form, by using again properties of binary variables.

$$Z = \sum_{\{T\}, \{S\}} F_{\text{edges}} \\ \exp \left(\sum_{i=2, j=0}^{N-1, M} \tau_i^j \tau_i^{j+1} (w(\sigma_{i-\frac{1}{2}}^{j+\frac{1}{2}} - \sigma_{i+\frac{1}{2}}^{j+\frac{1}{2}}) - 2 \log w + i \frac{\pi}{2} (s_{i-\frac{1}{2}}^{j+\frac{1}{2}} + s_{i+\frac{1}{2}}^{j+\frac{1}{2}} + 2)) \right. \\ \left. + \tau_i^j (2 \log w - w(\sigma_{i-\frac{1}{2}}^{j+\frac{1}{2}} + \sigma_{i-\frac{1}{2}}^{j-\frac{1}{2}}) + i \frac{\pi}{2} (s_{i+\frac{1}{2}}^{j+\frac{1}{2}} + s_{i-\frac{1}{2}}^{j-\frac{1}{2}} + 2)) \right. \\ \left. + w \sigma_{i+\frac{1}{2}}^{j+\frac{1}{2}} \right),$$

where the edges contributions are given by

$$F_{\text{edges}} = \exp \left(\sum_{j=0}^M -\tau_1^j \tau_1^{j+1} (w \sigma_{\frac{3}{2}}^{j+\frac{1}{2}} - A - \log Aw + i \frac{\pi}{2} (s_{\frac{3}{2}}^{j+\frac{1}{2}} + 1)) \right. \\ \left. + \tau_i^j (\log Aw - A - w \sigma_{\frac{3}{2}}^{j+\frac{1}{2}} + i \frac{\pi}{2} (s_{\frac{3}{2}}^{j+\frac{1}{2}} + 1) + w \sigma_{\frac{3}{2}}^{j+\frac{1}{2}} \right. \\ \left. - \tau_N^j \tau_N^{j+1} (w \sigma_{N-\frac{1}{2}}^{j+\frac{1}{2}} + B - \log Bw + i \frac{\pi}{2} (s_{N-\frac{1}{2}}^{j+\frac{1}{2}} + 1)) \right. \\ \left. + \tau_i^j (\log Bw + B - w \sigma_{N-\frac{1}{2}}^{j+\frac{1}{2}} + i \frac{\pi}{2} (s_{N-\frac{1}{2}}^{j+\frac{1}{2}} + 1) + w \sigma_{N-\frac{1}{2}}^{j+\frac{1}{2}}) \right).$$

3.3 Discrete stochastic equations

The third method we propose to depict the dynamics of the system is directly based on stochastic equations coding jump times as independent interacting Poisson processes.

3.3.1 The random telegraph problem

The random telegraph process is a time homogeneous Markov process X_t with states 0 and 1 and rates λ^\pm . The generator, as formulated in section 3.1, is equal to

$$g = \lambda^+(\sigma - 1)\hat{\tau} + \lambda^-(\sigma - 1)\hat{\tau}.$$

Here we have clearly

$$\begin{aligned} G(s, \tau) &= (s - 1)[\lambda + \mu(\bar{\tau} - \tau)], \\ \tilde{G}(\tau, s) &= (s - 1)[\lambda - \mu(\bar{\tau} - \tau)]. \end{aligned} \tag{3.5}$$

In fact, it is possible to write a stochastic equation for this model, by introducing $u(t)$ and $v(t)$ two independent Poisson processes, with respective rates λ^+ and λ^- , so that

$$\frac{\partial \tau}{\partial t}(t) = \bar{\tau}u^+(t) - \tau u^-(t).$$

Discretizing this time-process, with δt the time scale discretization, we get

$$\tau_{j+1} - \tau_j = \bar{\tau}_j u_{j+1/2}^+ - \tau_j u_{j+1/2}^-, \tag{3.6}$$

where

$$u_{j+1/2}^\pm = \begin{cases} 0 & \text{with probability } 1 - \lambda^\pm \delta t, \\ 1 & \text{with probability } \lambda^\pm \delta t. \end{cases}$$

Considering now the sequence $\{\tau_j, j = 1 \dots M\}$, we look for the generating function of an admissible sample path. To this end, from (3.6), we build the quantity

$$L_{j+1/2} = \tau_{j+1} - \tau_j - \bar{\tau}_j u_{j+1/2}^+ + \tau_j u_{j+1/2}^-,$$

which, for arbitrary τ_j , can take the value out of $\{-1, 0, 1\}$, 0 being the value for admissible sequences. The discrete version of the Fourier transform of the indicator

function reads

$$\frac{1}{2} \sum_{s_{j+1/2} \in \{-1, 1\}} e^{\frac{i\pi}{2} s_{j+1/2} L_{j+1/2}} = \begin{cases} 0 & \text{for } L_{j+1/2} \in \{-1, 1\}, \\ 1 & \text{for } L_{j+1/2} = 0. \end{cases}$$

As a result, we get at hand the generating function

$$\mathcal{F}[\{s, \tau, u^\pm\}] = \frac{1}{2^M} \exp\left(\frac{i\pi}{2} \sum_j s_{j+1/2} L_{j+1/2}\right).$$

Summing over the set $\{u^\pm\}$, we recover the generating function obtained directly from (3.5). Another way is to square $L_{j+1/2}$, to take Boltzmann weights

$$(L_{j+1/2})^2 = \tau_j \tau_{j+1} \bar{u}_{j+1/2}^- + \bar{\tau}_j \bar{\tau}_{j+1} \bar{u}_{j+1/2}^+ + \tau_j \bar{\tau}_{j+1} u_{j+1/2}^- + \bar{\tau}_j \tau_{j+1} \bar{u}_{j+1/2}^+,$$

and then to follow the procedure of section 3.2.1.

3.3.2 The simple exclusion problem

For ASEP, we need to introduce to set of Poisson processes $\{u_{i+1/2}(t)\}$ and $\{v_{i+1/2}(t)\}$, corresponding to left and right moves, with respective rates λ^+ and λ^- . The stochastic equation corresponding to this system reads

$$\begin{aligned} \frac{\partial \tau_i}{\partial t}(t) &= \bar{\tau}_i(t) (\tau_{i+1}(t) v_{i+1/2}(t) + \tau_{i-1}(t) u_{i-1/2}(t)) \\ &\quad - \tau_i(t) (\bar{\tau}_{i+1}(t) u_{i+1/2}(t) + \bar{\tau}_{i-1}(t) v_{i-1/2}(t)). \end{aligned}$$

Of course this equation can be discretized as well. Setting

$$J_{i+1/2}^{j+1/2} = \tau_i^j \bar{\tau}_{i+1}^j u_{i+1/2}^{j+1/2} - \bar{\tau}_i^j \tau_{i+1}^j v_{i+1/2}^{j+1/2},$$

we get immediately

$$\tau_i^{j+1} - \tau_i^j = J_{i+1/2}^{j+1/2} - J_{i+1/2}^{j+1/2}.$$

The generating functional then becomes

$$\mathcal{F}[\{s, \tau, u, v\}] = \frac{1}{2^{NM}} \exp\left(\frac{i\pi}{2} \sum_{i,j} s_{j+1/2} (\tau_i^{j+1} - \tau_i^j - J_{i+1/2}^{j+1/2} + J_{i+1/2}^{j+1/2})\right).$$

Summing over the fields u and v leads directly to the formulation of section 3.1.2, using for example the equalities

$$\begin{aligned} & \sum_{u_{i+1/2}(t)} \exp \frac{i\pi}{2} \int dt \tau_i(t) \bar{\tau}_{i+1}(t) s_{i+1/2}(t) u_{i+1/2}(t) \\ &= \exp \int dt \lambda^+ \left(e^{\frac{i\pi}{2} \tau_i(t) \bar{\tau}_{i+1}(t) (s_i(t) - s_{i+1}(t))} - 1 \right) \\ &= \exp \int dt \lambda^+ \tau_i(t) \bar{\tau}_{i+1}(t) (s_i(t) s_{i+1}(t) - 1). \end{aligned}$$

So far, we have listed four different but equivalent formulations on the space-time lattice. An important unanswered question remains: is one of these four methods clearly mostly appropriate to take continuous limits after scaling ?

4 Hydrodynamic limits

Here, we bear on a preliminary study [16], where a new functional method was introduced to handle the hydrodynamic limit of the simple exclusion process. We look into the way this approach could extend in order to systems comprising an arbitrary number of particle types. We will focus this section on the n -type case.

4.1 Functional integral equations

Let $\phi_k, k = 1 \dots n$ a set of arbitrary functions in $\mathbf{C}^2[0, 1]$, $\mathbf{G}^{(N)} \stackrel{\text{def}}{=} \mathbb{Z}/N\mathbb{Z}$ the discrete torus (circle). For $i \in \mathbf{G}^{(N)}$, $X_i^k(t)$ is a binary random variable and, at time t , the presence of a particle of type k at site i is equivalent to $X_i^k(t) = 1$. The exclusion constraint reads

$$\sum_{k=1}^n X_i^k(t) = 1, \quad \forall i \in \mathbf{G}.$$

The whole trajectory is represented by $\eta^{(N)}(t) \stackrel{\text{def}}{=} \{X_i^k(t), i \in \mathbf{G}^{(N)}, k = 1 \dots n\}$ which is a Markov process. $\Omega^{(N)}$ will denote its generator and $\mathcal{F}_t^{(N)} = \sigma(\eta^{(N)}(s), s \leq t)$ is the associated natural filtration.

Define the real-valued positive measure

$$Z_t^{(N)}[\phi] \stackrel{\text{def}}{=} \exp \left[\frac{1}{N} \sum_{k=1, i \in \mathbf{G}^{(N)}}^n \phi_k \left(\frac{i}{N} \right) X_i^k \right],$$

where ϕ denotes the set $\{\phi_k, k = 1 \dots n\}$. In [16] the convergence of this measure was analyzed for $n = 2$. A functional integral operator was used to characterize limit points of this measure, these were shown to be indeed the unique weak solution of a partial differential equation of Cauchy type.

In what follows, we will be interested in the quantities

$$\begin{cases} f_t^{(N)}(\phi) \stackrel{\text{def}}{=} \left[\mathbb{E}(Z_t^{(N)}[\phi]) \right], \\ g_t^{(N)}(\phi) \stackrel{\text{def}}{=} \log \left[\mathbb{E}(Z_t^{(N)}[\phi]) \right], \end{cases}$$

respectively the moment and cumulant generating function. The idea of using $Z_t^{(N)}[\phi]$ is that the generator, when applied to $Z_t^{(N)}$, can be expressed as a differential operator with respect to the arbitrary functions ϕ . Indeed, we have

$$\Omega^{(N)} [Z_t^{(N)}] = L_t^{(N)} Z_t^{(N)},$$

with

$$L_t^{(N)} = N^2 \sum_{k \neq l, i \in \mathbf{G}^{(N)}} \tilde{\lambda}_{kl} \frac{\partial^2}{\partial \phi_k \left(\frac{i}{N} \right) \partial \phi_l \left(\frac{i+1}{N} \right)},$$

after having set

$$\begin{cases} \Delta \psi_{kl} \left(\frac{i}{N} \right) \stackrel{\text{def}}{=} \phi_k \left(\frac{i+1}{N} \right) - \phi_k \left(\frac{i}{N} \right) + \phi_l \left(\frac{i}{N} \right) - \phi_l \left(\frac{i+1}{N} \right), \\ \tilde{\lambda}_{kl}(i, N) \stackrel{\text{def}}{=} 2\lambda_{kl}(N) e^{\frac{\Delta \psi_{kl} \left(\frac{i}{N} \right)}{2N}} \sinh \left(\frac{\Delta \psi_{kl} \left(\frac{i}{N} \right)}{2N} \right). \end{cases}$$

We introduce now the key quantities for hydrodynamic scalings, by assuming an asymptotic expansion of the form

$$\lambda_{kl}(N) = D \left(N^2 + \frac{\alpha_{kl}}{2} N \right) + \mathcal{O}(1), \quad \forall k, l \ k \neq l,$$

where $\alpha_{kl} = -\alpha_{lk}$ are real constants. Here the system is assumed to be *equidiffusive*, which means there exists a constant D such that, for all pairs (k, l) ,

$$\lim_{N \rightarrow \infty} \frac{\lambda_{kl}(N)}{N^2} = D.$$

>From now on we will omit the argument of $\lambda_{kl}(N)$ and retain the initial notation λ_{kl} . The coefficients α_{kl} express the asymmetry between types k and l . Now one can write

$$\frac{\partial f_t^{(N)}}{\partial t} = N^2 \sum_{k \neq l, i \in \mathbf{G}^{(N)}}^n \tilde{\lambda}_{kl}(i, N) \frac{\partial^2 f_t^{(N)}}{\partial \phi_k(\frac{i}{N}) \partial \phi_l(\frac{i+1}{N})}. \quad (4.1)$$

To rearrange the sum in (4.1), in order to select dominant terms in the expansion with respect to $1/N$, we make use of the exclusion property, which is formally equivalent to

$$\sum_{k=1}^n \frac{\partial}{\partial \phi_k(\frac{i}{N})} = \frac{1}{N}.$$

Since we are on the circle $i \in \mathbf{G}^{(N)}$, Abel's summation formula does not produce any boundary term, so that, skipping details, (4.1) can be rewritten as

$$\begin{aligned} \frac{\partial f_t^{(N)}}{\partial t} = & DN^2 \sum_{k=1, i \in \mathbf{G}^{(N)}}^n \left[\phi_k\left(\frac{i+1}{N}\right) - \phi_k\left(\frac{i}{N}\right) \right] \left[\frac{\partial f_t^{(N)}}{\partial \phi_k(\frac{i}{N})} - \frac{\partial f_t^{(N)}}{\partial \phi_k(\frac{i+1}{N})} \right] \\ & + \frac{1}{2} \sum_{l \neq k} \alpha_{kl} \left(\frac{\partial^2 f_t^{(N)}}{\partial \phi_k(\frac{i}{N}) \partial \phi_l(\frac{i+1}{N})} + \frac{\partial^2 f_t^{(N)}}{\partial \phi_l(\frac{i+1}{N}) \partial \phi_k(\frac{i}{N})} \right) \Big] + \mathcal{O}(N^{-1}). \end{aligned} \quad (4.2)$$

It is worth remarking that operators like $\frac{\partial}{\partial \phi_k(\frac{i}{N})}$ and $\phi_k(\frac{i+1}{N}) - \phi_k(\frac{i}{N})$ produce a scale factor $1/N$, while $\frac{\partial}{\partial \phi_k(\frac{i}{N})} - \frac{\partial}{\partial \phi_k(\frac{i+1}{N})}$ and $\frac{\partial}{\partial \phi_k(\frac{i+1}{N})} \frac{\partial}{\partial \phi_l(\frac{i}{N})}$ scale as $1/N^2$: this explains the selection of dominant terms in the above expansion.

Let $N \rightarrow \infty$ and assume the convergence of the sequence $f_0^{(N)}$. Then, from the tightness of the process, together with a zeste of variational and complex variable calculus, as in [16], we claim [the proof is omitted] $f_t^{(N)}$ also converges, in a *good tempered* functional space, and its limit f_t satisfies the functional integral equation

$$\frac{\partial f_t}{\partial t} = D \int_0^1 dx \sum_{k=1}^n \phi_k(x) \frac{\partial}{\partial x} \left[\frac{\partial}{\partial x} \frac{\partial f_t}{\partial \phi_k(x)} - \sum_{l \neq k} \alpha_{kl} \left(\frac{\partial^2 f_t}{\partial \phi_k(x) \partial \phi_l(x)} \right) \right].$$

Similarly, the cumulant characteristic function is a solution of

$$\begin{aligned} \frac{\partial g_t}{\partial t} = D \int_0^1 dx \sum_{k=1}^n \phi_k(x) \frac{\partial}{\partial x} \left[\frac{\partial}{\partial x} \frac{\partial g_t}{\partial \phi_k(x)} \right. \\ \left. - \sum_{l \neq k} \alpha_{kl} \left(\frac{\partial g_t}{\partial \phi_k(x)} \frac{\partial g_t}{\partial \phi_l(x)} - \frac{\partial^2 g_t}{\partial \phi_k(x) \partial \phi_l(x)} \right) \right]. \end{aligned} \quad (4.3)$$

Assume at time 0 the given initial profile $\rho_k(x, 0)$ to be twice differentiable with respect to x . Then (4.3) is given by

$$g_t(\phi) = \int_0^1 dx \sum_{k=1}^n \rho_k(x, t) \phi_k(x),$$

where $\rho_k(x, t)$ satisfy the hydrodynamic system of coupled Burger's equations

$$\frac{\partial \rho_k}{\partial t} = D \left[\frac{\partial^2 \rho_k}{\partial x^2} + \frac{\partial}{\partial x} \left(\sum_{l \neq k} \alpha_{lk} \rho_k \rho_l \right) \right], \quad k = 1 \dots n,$$

with the set of given initial conditions $\rho_k(x, 0), k = 1, \dots, n$.

Remark It is important to note that, without differentiability conditions for the initial profiles $\rho_k(x, 0)$, one can only assert the existence of *weak solutions* (in the sense of Schwartz's distributions) of Burger's system.

4.2 About correlations in the ABC model

In this section, we meet the so-called ABC model, which corresponds to $n = 3$ in our general setting. According to the arguments presented above, the cumulant generating function $g_t(\phi_a, \phi_b, \phi_c)$ can be shown to satisfy the functional integral equation

$$\begin{aligned} \frac{\partial g_t}{\partial t} = D \int_0^1 dx \phi_a(x) \frac{\partial}{\partial x} \left[\frac{\partial}{\partial x} \frac{\partial g_t}{\partial \phi_a(x)} + \left(\beta \frac{\partial^2 g_t}{\partial \phi_a(x) \partial \phi_c(x)} - \gamma \frac{\partial^2 g_t}{\partial \phi_a(x) \partial \phi_b(x)} \right) \right. \\ \left. + \left(\beta \frac{\partial g_t}{\partial \phi_a(x)} \frac{\partial g_t}{\partial \phi_c(x)} - \gamma \frac{\partial g_t}{\partial \phi_a(x)} \frac{\partial g_t}{\partial \phi_b(x)} \right) \right] \\ + \text{ [analogous terms obtained by circular letter permutation]}, \end{aligned} \quad (4.4)$$

where, for the sake of brevity, we introduced $\alpha \stackrel{\text{def}}{=} \alpha_{bc}$, $\beta \stackrel{\text{def}}{=} \alpha_{ca}$, $\gamma \stackrel{\text{def}}{=} \alpha_{ab}$.

Solving (4.4) is a difficult problem, which will be considered in a forthcoming work. For the moment, we shall only present an approximate equivalent system.

4.2.1 An approximate solution of (4.4)

Up to a slight abuse in the vocabulary, g_t is *analytic with respect to the vector function* $\vec{\phi} \stackrel{\text{def}}{=} (\phi_a, \phi_b, \phi_c)$ (think in terms of Radon-Nykodim derivatives and variational calculus). Then we have

$$g_t(\phi_a, \phi_b, \phi_c) = \int \vec{\phi}(x) \cdot \vec{\rho}(x, t) dx + \frac{1}{2} \int_0^1 \vec{\phi}(x) \sigma_t(x, y) \vec{\phi}(y) dx dy + \mathcal{O}(\|\phi\|^3),$$

with

$$\sigma_t(x, y) = \begin{bmatrix} \sigma_{aa}(x, y, t) & \sigma_{ab}(x, y, t) & \sigma_{ac}(x, y, t) \\ \sigma_{ab}(x, y, t) & \sigma_{bb}(x, y, t) & \sigma_{bc}(x, y, t) \\ \sigma_{ac}(x, y, t) & \sigma_{bc}(x, y, t) & \sigma_{cc}(x, y, t) \end{bmatrix}.$$

Let us start from the purely heuristic assumption that cumulants of order ≥ 3 are negligible. Then, identifying coefficients in the ϕ -power expansion of g_t , we derive the following closed system

$$\begin{aligned} \frac{\partial \sigma_{aa}}{\partial t} &= D \left\{ \Delta \sigma_{aa} + \vec{\nabla} \cdot [\beta(\vec{\rho}_a \sigma_{ca} + \vec{\rho}_c \sigma_{aa}) - \gamma(\vec{\rho}_a \sigma_{ba} + \vec{\rho}_b \sigma_{aa})] \right\}, \\ \frac{\partial \sigma_{ab}}{\partial t} &= D \left\{ \Delta \sigma_{ab} + \frac{1}{2} \vec{\nabla} \cdot [\beta(\vec{\rho}_a \sigma_{bc} + \vec{\rho}_c \sigma_{ab}) - \gamma(\vec{\rho}_a \sigma_{bb} + \vec{\rho}_b \sigma_{ab}) \right. \\ &\quad \left. + \gamma(\vec{\rho}_b \sigma_{aa} + \vec{\rho}_a \sigma_{ab}) - \alpha(\vec{\rho}_b \sigma_{ac} + \vec{\rho}_c \sigma_{ab})] \right\}, \\ \frac{\partial \sigma_{ac}}{\partial t} &= D \left\{ \Delta \sigma_{ac} + \frac{1}{2} \vec{\nabla} \cdot [\beta(\vec{\rho}_a \sigma_{cc} + \vec{\rho}_c \sigma_{ac}) - \gamma(\vec{\rho}_a \sigma_{bc} + \vec{\rho}_b \sigma_{ac}) \right. \\ &\quad \left. + \alpha(\vec{\rho}_c \sigma_{ab} + \vec{\rho}_b \sigma_{ac}) - \beta(\vec{\rho}_c \sigma_{aa} + \vec{\rho}_a \sigma_{ac})] \right\}, \end{aligned}$$

where $\vec{\rho}_u$ stands for the vector

$$\vec{\rho}_u = \begin{pmatrix} \rho_u(x) \\ \rho_u(y) \end{pmatrix}.$$

Due to the exclusion constraint $A_i + B_i + C_i = 1$, we have

$$g_t(\phi_a, \phi_b, \phi_c) = g_t(\phi_a - \phi_c, \phi_b - \phi_c, 0),$$

and the following relations hold

$$\begin{aligned}\sigma_{ac} &= -\sigma_{aa} - \sigma_{ab}, \\ \sigma_{bc} &= -\sigma_{ab} - \sigma_{bb}, \\ \sigma_{cc} &= \sigma_{aa} + 2\sigma_{ab} + \sigma_{bb}.\end{aligned}$$

Finally, we obtain the system

$$\begin{aligned}\frac{\partial \sigma_{aa}}{\partial t} &= D \left\{ \Delta \sigma_{aa} + \vec{\nabla} \cdot [\sigma_{aa}(\beta(\vec{\rho}_c - \vec{\rho}_a) - \gamma \vec{\rho}_b) - \sigma_{ab}(\beta + \gamma)\vec{\rho}_a] \right\}, \\ \frac{\partial \sigma_{ab}}{\partial t} &= D \left\{ \Delta \sigma_{ab} + \frac{1}{2} \vec{\nabla} \cdot [\sigma_{aa}(\alpha + \gamma)\vec{\rho}_b - \sigma_{bb}(\beta + \gamma)\vec{\rho}_a \right. \\ &\quad \left. + \sigma_{ab}((\gamma - \beta)\vec{\rho}_a + (\alpha - \gamma)\vec{\rho}_b + (\beta - \alpha)\vec{\rho}_c)] \right\} \\ \frac{\partial \sigma_{bb}}{\partial t} &= D \left\{ \Delta \sigma_{bb} + \vec{\nabla} \cdot [\sigma_{bb}(\alpha(\vec{\rho}_b - \vec{\rho}_c) + \gamma \vec{\rho}_a) + \sigma_{ab}(\alpha + \gamma)\vec{\rho}_b] \right\}.\end{aligned}\tag{4.5}$$

which represents 2-dimensional diffusions submitted to an external field.

At steady state, they can be solved below the transition point when the densities are uniform. Indeed, in this case, the matrix governing the behaviour of the system reads

$$\begin{bmatrix} \beta(\rho_c - \rho_a) - \gamma\rho_b & -(\beta + \gamma)\rho_a & 0 \\ \frac{1}{2}(\alpha + \gamma)\rho_b & \frac{1}{2}[(\gamma - \beta)\rho_a + (\alpha - \gamma)\rho_b + (\beta - \alpha)\rho_c] & -\frac{1}{2}(\beta + \gamma)\rho_a \\ 0 & (\alpha + \gamma)\rho_b & \gamma\rho_a + \alpha(\rho_b - \rho_c) \end{bmatrix}.$$

In the particular case of a reversible system, the average densities are given by

$$\rho_a = \frac{\alpha}{\alpha + \beta + \gamma}, \quad \rho_b = \frac{\beta}{\alpha + \beta + \gamma}, \quad \rho_c = \frac{\gamma}{\alpha + \beta + \gamma},$$

and the above matrix becomes

$$\frac{1}{\alpha + \beta + \gamma} \begin{bmatrix} -\alpha\beta & -\alpha(\beta + \gamma) & 0 \\ \frac{1}{2}\beta(\alpha + \gamma) & 0 & -\frac{1}{2}\alpha(\beta + \gamma) \\ 0 & (\alpha + \gamma)\beta & \alpha\beta \end{bmatrix},$$

with eigenvalues 0 and $\pm i\sqrt{\frac{\alpha\beta\gamma}{\alpha+\beta+\gamma}}$: unstable modes exist, with the same critical value as the one obtained from the deterministic field in [6, 15].

In the general case (i.e. $\vec{\rho}$ not constant), the set of equations (4.5) should be solved along with the exact deterministic system

$$\begin{aligned}\frac{1}{D} \frac{\partial \rho_a}{\partial t} &= \frac{\partial^2 \rho_a}{\partial x^2} + \frac{\partial}{\partial x} \left[\rho_a(\gamma \rho_b - \beta \rho_c) + \gamma \sigma_{ab} - \beta \sigma_{ac} \right], \\ \frac{1}{D} \frac{\partial \rho_b}{\partial t} &= \frac{\partial^2 \rho_b}{\partial x^2} + \frac{\partial}{\partial x} \left[\rho_b(\alpha \rho_c - \gamma \rho_a) + \alpha \sigma_{bc} - \gamma \sigma_{ab} \right], \\ \frac{1}{D} \frac{\partial \rho_c}{\partial t} &= \frac{\partial^2 \rho_c}{\partial x^2} + \frac{\partial}{\partial x} \left[\rho_c(\beta \rho_a - \alpha \rho_b) + \beta \sigma_{ac} - \alpha \sigma_{bc} \right].\end{aligned}$$

Note that correlations σ are taken at coinciding points. Comparison with a finite-size system is in principle allowed, just by computing the value of σ at $t = 0$.

5 Reversible stationary states

5.1 The invariant measure

Up to a slight abuse in the notation, we let $X_i^k \in \{0, 1\}$ denote the binary random variable representing the occupation of site i by a letter of type k . The state of the system is represented by the array $\mathbb{X} \stackrel{\text{def}}{=} \{X_i^k, i = 1, \dots, N; k = 1, \dots, n\}$ of size $N \times n$. The invariant measure of the Markov process of interest is then given by

$$P(\mathbb{X}) = \frac{1}{Z} \exp[-\mathcal{H}(\mathbb{X})], \quad (5.1)$$

where

$$\mathcal{H}(\mathbb{X}) = \frac{1}{N} \sum_{i < j} \sum_{k, l} \alpha_{kl}^{(N)} X_i^k X_j^l, \quad (5.2)$$

with $\alpha_{kl}^{(N)}$ and $\alpha_{lk}^{(N)}$ two N -dependent coefficients related by

$$\alpha_{kl}^{(N)} - \alpha_{lk}^{(N)} = N \log \frac{\lambda_{kl}}{\lambda_{lk}}, \quad (5.3)$$

provided that some *balance* conditions hold. For example, in the clock model (2.1), these conditions take the simple form

$$\sum_{k \neq l} \alpha_{kl}^{(N)} N_k = 0, \quad (5.4)$$

and they follow indeed directly from Kolmogorov's criteria applied to a particle crossing the system.

5.2 Free energy and metastable configurations

We consider again the *ABC* model as a typical example, and the extension to other models will be straightforward. Assume conditions (5.4) hold, so that the invariant measure is given by

$$P(\{A, B, C\}) = \frac{1}{Z} \exp\left[\frac{1}{N} \sum_{i < j} \alpha_{ab}^{(N)} A_i B_j + \alpha_{bc}^{(N)} B_i C_j + \alpha_{ca}^{(N)} C_i A_j\right],$$

where the constants $\alpha_{ab}^{(N)}$, $\alpha_{bc}^{(N)}$ and $\alpha_{ca}^{(N)}$ take the values

$$\alpha_{ab}^{(N)} = N \log \frac{\lambda_{ab}}{\lambda_{ba}}, \quad \alpha_{bc}^{(N)} = N \log \frac{\lambda_{bc}}{\lambda_{cb}}, \quad \alpha_{ca}^{(N)} = N \log \frac{\lambda_{ca}}{\lambda_{ac}},$$

while $\alpha_{ba}^{(N)}$, $\alpha_{cb}^{(N)}$ and $\alpha_{ac}^{(N)}$ are set to zero, to be consistent with (5.3). The constraints (5.4) now become

$$\frac{N_A}{N_B} = \frac{\alpha_{bc}^{(N)}}{\alpha_{ca}^{(N)}}, \quad \frac{N_B}{N_C} = \frac{\alpha_{ca}^{(N)}}{\alpha_{ab}^{(N)}}, \quad \frac{N_C}{N_A} = \frac{\alpha_{ab}^{(N)}}{\alpha_{bc}^{(N)}}. \quad (5.5)$$

Following [6], we want to write a large deviation functional corresponding to the above Gibbs measure when $N \rightarrow \infty$. Set $x = \frac{i}{N}$, $J = \exp(2i\pi/3)$, and let $Z(x)$ denote the complex number given by

$$Z(x) = \frac{1}{N} \sum_{i=1}^{[xN]} \left(\frac{A_i}{\alpha} + J \frac{B_i}{\beta} + J^2 \frac{C_i}{\gamma} \right),$$

where we have introduced the parameters

$$\alpha \stackrel{\text{def}}{=} \lim_{N \rightarrow \infty} \alpha_{bc}^{(N)}, \quad \beta \stackrel{\text{def}}{=} \lim_{N \rightarrow \infty} \alpha_{ca}^{(N)}, \quad \gamma \stackrel{\text{def}}{=} \lim_{N \rightarrow \infty} \alpha_{ab}^{(N)},$$

in agreement with the notation of section 4.2.

The sequence $\{A, B, C\}$ is thus represented by a path $Z(x)$ in the complex plane, consisting of oriented links having only three possible directions

$$\{\theta = 0, \theta = 2\pi/3, \theta = 4\pi/3\},$$

depending on whether a particle A, B or C is present. The length of a link corresponding to A, B, or C is, respectively, $1/(N\alpha)$, $1/(N\beta)$ or $1/(N\gamma)$.

Note that condition (5.5) ensures the path (denoted by Γ) is closed, that is

$$Z(1) = \frac{1}{\alpha + \beta + \gamma}(1 + J + J^2) = 0.$$

Consider now the area \mathcal{A} enclosed by Γ ,

$$\mathcal{A} = \frac{1}{2i} \oint_{\Gamma} (\bar{z}dz - zd\bar{z}).$$

Then, as $N \rightarrow \infty$, we have

$$\mathcal{A} = \lim_{N \rightarrow \infty} \frac{J^2 - J}{2iN^2} \sum_{l < k} \frac{A_l}{\alpha} \left(\frac{B_k}{\beta} - \frac{C_k}{\gamma} \right) + \frac{B_l}{\beta} \left(\frac{C_k}{\gamma} - \frac{A_k}{\alpha} \right) + \frac{C_l}{\gamma} \left(\frac{A_k}{\alpha} - \frac{B_k}{\beta} \right).$$

Finally we obtain

$$\mathcal{H}\{X_i\} = \frac{N\alpha\beta\gamma}{\sqrt{3}} \mathcal{A} + \frac{3N}{\alpha + \beta + \gamma} + O(1)$$

When considering the large deviation functional, an additional entropy term contributes to the free-energy which has the form

$$\mathcal{F}(\rho_a, \rho_b, \rho_c) = \mathcal{S}(\rho_a, \rho_b, \rho_c) + \mathcal{A}(\rho_a, \rho_b, \rho_c). \quad (5.6)$$

In the present case, this entropy term comes from a multinomial combinatorial factor $\frac{n!}{n_a!n_b!n_c!}$, namely the way of arranging a box of $n=[N dx]$ sites, with three species of identical particles having respective populations $n_i = \rho_i(x)Ndx$, $i \in \{a, b, c\}$. Then Stirling's formula for large N yields

$$\mathcal{S}(\rho_a, \rho_b, \rho_c) = N \int_0^1 dx [\rho_a(x) \log \rho_a(x) + \rho_b(x) \log \rho_b(x) + \rho_c(x) \log \rho_c(x)].$$

The large deviation probability of a given profile is thus given by

$$P_N(\rho_a, \rho_b, \rho_c) = \frac{1}{Z} \exp(-N\mathcal{F}(\rho_a, \rho_b, \rho_c)). \quad (5.7)$$

Stable and metastable deterministic profiles correspond to local extrema of the free-energy. According to 5.6, the variational principle can be reformulated by requiring that the optimal profile should realize a combination tendind to maximize both the entropy and the enclosed area. Of course, these two requirements are contradictory. Curves of maximal entropy are typically Brownian, and have an area which scales like $1/\sqrt{N}$; on the contrary, the opposite extreme configuration consisting of an equilateral triangle achieves the maximum area, but belongs to a class of profiles for which the entropy contribution is equal to zero (since $\rho \log \rho$ vanishes both for $\rho = 0$ and $\rho = 1$). Depending on the weight given to this combination, which is fixed by the parameter $\alpha\beta\gamma/\sqrt{3}$, we will obtain profiles which are either Brownian (the degenerate point of the deterministic equations) or deterministic, both regimes being separated by a second order phase transition.

5.3 Ehrenfest urn model interpretation

Consider a kind of Ehrenfest model with three urns (or boxes), denoted by $\{A, B, C\}$, and N indistinguishable balls (or particles). This generalizes the standard Ehrenfest model which comprises only two urns. Each urn contains balls of a given type, $N_a^{(N)}(t)$, $N_b^{(N)}(t)$ and $N_c^{(N)}(t)$ being the corresponding time-dependent populations. Since the system is closed, $N_a + N_b + N_c = N$. At random times taken as exponential events, balls are moved from one box to another one, i.e. individuals are transferred from one population to another. We define the moving rules as follows: a pair of balls pertaining respectively to urns B and C is chosen and the ball pertaining to urn B is moved to the third box C. This process occurs randomly at a rate α . Two other transition rates β and γ are defined in a similar way, by circular permutations of the boxes. This can be summarized by the following set of reactions

$$\left\{ \begin{array}{l} AB \xrightarrow{\gamma} BB, \\ BC \xrightarrow{\alpha} CC, \\ CA \xrightarrow{\beta} AA. \end{array} \right.$$

This zero-range process is of Ehrenfest *Class*, as defined in [18], in the sense that balls, rather than boxes, are chosen at random. When N increases to infinity, we are

lead to consider concentrations instead of integer numbers:

$$C_i(t) \stackrel{\text{def}}{=} \lim_{N \rightarrow \infty} \frac{N_i^{(N)}(t)}{N},$$

for $i = a, b, c$. After a proper scaling limit, the dynamics of the model is described by the following Lotka-Volterra system

$$\begin{cases} \frac{\partial C_a}{\partial x} = C_a(\beta C_c - \gamma C_b), \\ \frac{\partial C_b}{\partial x} = C_b(\gamma C_a - \alpha C_c), \\ \frac{\partial C_c}{\partial x} = C_c(\alpha C_b - \beta C_a), \end{cases}$$

which, after replacing x by t and densities by concentrations, is nothing else but the differential system giving the invariant measure of the (A, B, C) model, in the fluid limit at thermodynamical equilibrium [6].

5.4 The square lattice model

5.4.1 The invariant measure

We turn now to the second case-study, namely the square-lattice model introduced in [14]. It does illustrate the rules (2.1). Instead of handling the problem directly with the natural set of four letters $\{A, B, C, D\}$, we found convenient to represent the degrees of freedom by pairs of binary components. In the symmetric version of the model defined by (2.4), when cycles are absent ($N_a = N_b = 1/2$ and $\gamma^+ = \gamma^-$), we could derive the invariant measure

$$P(\tau_a, \tau_b) = \frac{1}{Z} \exp\left[\beta \sum_{i < j} (\tau_i^a \bar{\tau}_j^b - \tau_i^b \bar{\tau}_j^a)\right], \quad (5.8)$$

with $\beta = \log \frac{\lambda^-}{\lambda^+}$. Let us see how this relates to the original formulation of the model in terms of the four letters A, B, C and D .

Proposition 5.1. *Under the reversibility conditions imposed on the transitions rates $\{\lambda_{kl}, \gamma^k, \delta^k, k = 1 \dots 4, l = 1 \dots 4\}$, the measure given by (5.1) and (5.2) reduces to*

$$P(\mathbb{X}) = \frac{1}{Z} \exp \left\{ \frac{\beta}{2} \sum_{i < j} B_i A_j - A_i B_j + A_i D_j - D_i A_j \right. \\ \left. + C_i B_j - B_i C_j + D_i C_j - C_i D_j \right\},$$

and is equivalent to (5.8).

Proof. We start from the invariant form (5.1), (5.2), together with the reversibility conditions given in theorem 3.2 of [15], and hereafter referred to as *conditions (i), ..., (v)*. We also replace indexes $k = 1, \dots, 4$, by small letters a, b, c, d , in all coefficients, thus writing $\alpha^{ab}, \alpha^{ac}, \dots$, etc.

Then, *condition (iv)* yields

$$\alpha^{bd} - \alpha^{ac} = \log \frac{\gamma^a}{\delta^b}, \quad \alpha^{ca} - \alpha^{bd} = \log \frac{\gamma^b}{\delta^c}, \\ \alpha^{db} - \alpha^{ca} = \log \frac{\gamma^c}{\delta^d}, \quad \alpha^{ac} - \alpha^{db} = \log \frac{\gamma^d}{\delta^a}.$$

Now, using *condition (i)*, we obtain

$$\alpha^{ca} - \alpha^{ac} = \log \frac{\gamma^a \gamma^b}{\delta^b \delta^c} = 0, \quad \alpha^{db} - \alpha^{bd} = \log \frac{\gamma^b \gamma^c}{\delta^c \delta^d} = 0.$$

In order to reduce the number of parameters, we define $\beta \in \mathbb{R}$ such that *condition (v)* rewrites as

$$\beta \stackrel{\text{def}}{=} \alpha^{ab} - \alpha^{ba} = \alpha^{bc} - \alpha^{cb} = \alpha^{cd} - \alpha^{dc} = \alpha^{da} - \alpha^{ad}.$$

This in turn leads to

$$\alpha^{bc} = \alpha^{da}, \quad \alpha^{cb} = \alpha^{ad}, \\ \alpha^{ab} = \alpha^{cd}, \quad \alpha^{ba} = \alpha^{dc}.$$

Similarly, we get the set of identities

$$\alpha^{ad} + \alpha^{da} = 2\alpha - (\alpha^{ab} + \alpha^{ba}), \\ \alpha^{aa} = \alpha^{cc} = \alpha - \alpha^{ac}, \quad \alpha^{bb} = \alpha^{dd} = \alpha - \alpha^{bd},$$

where α is precisely defined by *condition* (v) of the aforementioned theorem. Finally, we are left with a set of parameters $\{\alpha, \beta, \alpha^{ac}, \alpha^{bd}, \alpha^{ab} + \alpha^{ba}\}$ allowing for a complete characterization of the Gibbs form. Indeed,

$$P(\mathbb{X}) = \frac{1}{Z} \exp \left\{ \frac{\beta}{2} \sum_{i < j} B_i A_j - A_i B_j + A_i D_j - D_i A_j \right. \\ \left. + C_i B_j - B_i C_j + D_i C_j - C_i D_j + \Gamma \right\}. \quad (5.9)$$

In (5.9), the quantity

$$\Gamma = \frac{\alpha}{2} [(N_A + N_D)^2 + (N_B + N_C)^2] + \frac{\alpha^{ac}}{2} (N_A - N_C)^2 + \frac{\alpha^{bd}}{2} (N_B - N_D)^2 \\ + \frac{1}{2} (\alpha^{ab} + \alpha^{ba}) (N_A - N_C) (N_B - N_D),$$

is a constant simply contributing to a redefinition of the normalization. Remember $N_A - N_C$ and $N_B - N_D$ are conserved by the dynamical rules, in addition to $N_A + N_B + N_C + N_D$, whence $N_A + N_D$ and $N_B + N_C$ also are kept constant. Let us come back to the mapping between the two representations. It simply states that

$$\begin{cases} \bar{\tau}_i^a = B_i + C_i, & \bar{\tau}_i^a = A_i + D_i, \\ \bar{\tau}_i^b = C_i + D_i, & \bar{\tau}_i^a = A_i + B_i. \end{cases} \quad (5.10)$$

It is now straightforward to check that (5.8) and (5.9) represent the same probability measure, as it was expected. \blacksquare

5.4.2 Two continuous descriptions and a functional mapping

Writing down the large deviation functional $\mathcal{F}(\rho_A, \rho_B, \rho_C, \rho_D)$, [introduced in (5.7) and resulting from (5.9)], together with the conditions ensuring an optimal profile, we obtain a differential system of Lotka-Volterra class

$$\begin{aligned} \frac{\partial \rho_A}{\partial x} &= \eta \rho_A (\rho_B - \rho_D), & \frac{\partial \rho_B}{\partial x} &= \eta \rho_B (\rho_C - \rho_A), \\ \frac{\partial \rho_C}{\partial x} &= \eta \rho_C (\rho_D - \rho_B), & \frac{\partial \rho_D}{\partial x} &= \eta \rho_D (\rho_A - \rho_C), \end{aligned} \quad (5.11)$$

in which the last equation is follows merely by summing up the three other ones. This system is structurally different from the one obtained in [14], which involved only two independent profiles (ρ_a, ρ_b) corresponding to deterministic densities for the particles τ_a and τ_b , while in the present case there are three (ρ_A, ρ_B, ρ_C) for example).

It is interesting to notice that, in both models, explicit level surfaces exist. Indeed, the above system satisfies $\rho_A \rho_B \rho_C \rho_D = cte$, in addition to constraint $\rho_A + \rho_B + \rho_C + \rho_D = 1$. On the other hand, $\rho_a(1 - \rho_a)\rho_b(1 - \rho_b)$ is the level surface of the former system encountered in [14]. This can be explained by reversing the mapping (5.10), so that

$$\begin{aligned} A_i &= \bar{\tau}_i^a \bar{\tau}_i^b, & B_i &= \tau_i^a \bar{\tau}_i^b, \\ C_i &= \tau_i^a \tau_i^b, & D_i &= \bar{\tau}_i^a \tau_i^b. \end{aligned} \quad (5.12)$$

This indicates that the set of 4-tuples $\{\tau_i^a, \bar{\tau}_i^a, \tau_i^b, \bar{\tau}_i^b\}$ constitutes the elementary blocks of the system, and that letters A_i, B_i, C_i, D_i are composite variables encoding correlations of these building blocks. Therefore, in the continuous limit, we are left with two different descriptions of the same system, related in a non trivial manner. We propose now to explore more carefully this connection. In particular, while the linear mapping (5.10) still holds in the continuous limit, as a relation between expected values

$$\begin{cases} \rho_a = \rho_B + \rho_C, \\ \rho_b = \rho_C + \rho_D, \end{cases} \quad (5.13)$$

the non-linear equations (5.12) are instead expected to bring a different form, since they involve correlations.

Proposition 5.2. *The differential system given by*

$$\begin{cases} \frac{\partial}{\partial x} \left[\log \frac{\rho^a(x)}{1 - \rho^a(x)} \right] = 2\eta(2\rho_b(x) - 1), \\ \frac{\partial}{\partial x} \left[\log \frac{\rho^b(x)}{1 - \rho^b(x)} \right] = -2\eta(2\rho_a(x) - 1), \end{cases} \quad (5.14)$$

is related to (5.11) through the invertible functional mapping given by

$$\begin{cases} \rho_A = \bar{\rho}_a \bar{\rho}_b + K, & \rho_B = \rho_a \bar{\rho}_b - K, \\ \rho_C = \rho_a \rho_b + K, & \rho_D = \bar{\rho}_a \rho_b - K, \end{cases} \quad (5.15)$$

where K is a constant to be determined.

Proof. First, let $\{\rho_B, \rho_C, \rho_D\}$ be the set of independent variables in (5.11), and express them in terms of the new triple $\{\rho_a, \rho_b, \rho_C\}$ given by (5.13). This gives

$$\begin{aligned}\frac{\partial(\rho_a - \rho_C)}{\partial x} &= \eta(\rho_a - \rho_C)(\rho_a + \rho_b - 1), \\ \frac{\partial(\rho_b - \rho_C)}{\partial x} &= \eta(\rho_b - \rho_C)(1 - \rho_a + \rho_b), \\ \frac{\partial\rho_C}{\partial x} &= \eta\rho_C(\rho_b - \rho_a).\end{aligned}\tag{5.16}$$

Combining these equations yields

$$\begin{cases} \frac{\partial\rho_a}{\partial x} = \eta\rho_a(\rho_a + \rho_b - 1) + \eta\rho_C(1 - 2\rho_a), \\ \frac{\partial\rho_b}{\partial x} = \eta\rho_b(1 - \rho_a - \rho_b) + \eta\rho_C(2\rho_b - 1), \end{cases}\tag{5.17}$$

which in turn allows to express ρ_C as

$$\rho_C = \frac{1}{\rho_a - \rho_b} \left(\rho_a \frac{\partial\rho_b}{\partial x} + \rho_b \frac{\partial\rho_a}{\partial x} \right).$$

Instantiating this last value of ρ_C in (5.17) and in (5.16), we obtain (5.14), after immediate recombination, together with the relation

$$\frac{\partial\rho_C}{\partial x} = \frac{\partial(\rho_a\rho_b)}{\partial x}.$$

This last equation has its counterpart for ρ_A, ρ_B and ρ_D : after integration, we are left with four constants, which reduce to the one given in (5.15) only when compatibility with (5.13) is imposed. ■

6 Non-Gibbs steady state regime

We shall speak of *non-Gibbs steady state regime* whenever the invariant measure is not described by means of a potential. This kind of regime occurs when Kolmogorov's reversibility criterion fails for at least one cycle in the state space.

6.1 The tagged particle

One cycle in the state space for the n odd model can be accurately represented by a tagged particle moving around, while keeping the other particles frozen in a well-defined permutation order. Each time this particle exchanges its position with one of its neighbours, the permutation order of the frozen particles remains unchanged. In other words, the tagged particle simply diffuses in a *fixed* random environment defined by the other particles. Choose $X^1 = A$ as the tagged particle, and let $\{X^{k_i}, i = 1, \dots, N; k_i \in \{1, \dots, n\}\}$ the complementary set of frozen particles. To all admissible transitions, which are typically jumps of A between sites $(i, i + 1)$ or $(i, i - 1)$, corresponds a set of conditional rates given by

$$\begin{cases} \lambda_a^+(i + \frac{1}{2}) \stackrel{\text{def}}{=} \sum_{k_i=1}^n \lambda_{ak_i} X_{i+1}^{k_i}, \\ \lambda_a^-(i + \frac{1}{2}) \stackrel{\text{def}}{=} \sum_{k_i=1}^n \lambda_{k_i a} X_{i+1}^{k_i}. \end{cases}$$

Violation of condition (5.4) is mathematically equivalent to the inequality

$$\prod_{i=1}^{N-1} \frac{\lambda_a^+(i + \frac{1}{2})}{\lambda_a^-(i + \frac{1}{2})} \neq 1.$$

In such a case, the diffusion of particle A is biased to the right [resp. left] direction, if the preceding coefficient is greater [resp. lower] than one. Let us write the invariant measure of the set of binary occupation numbers $\{A_i, i = 1, \dots, N\}$ of our tagged particle, conditionally to the set $\{X_i^k, i = 1 \dots N, k = 1 \dots n\}$ of occupation numbers of the frozen subset, which has of course to correspond to a given permutation.

Then, clearly, $\sum_{i=1}^N A_i = 1$ (since we consider only one tagged particle) and

$$\Pi(\{A\}|\{X\}) = \frac{1}{Z} \sum_{l=1}^N \exp \left\{ \sum_{m=1, i=1}^{n, N} \sum_{l+1 < j < i} A_i X_j^m \log \lambda_{am} + \sum_{i < j < l} A_i X_j^m \log \lambda_{ma} \right\}.$$

One can now verify that the expression of the flux due to A between sites i and $i + 1$

$$\begin{aligned} \phi_a(i + \frac{1}{2}) &\stackrel{\text{def}}{=} \lambda_a^+(i + \frac{1}{2})P(A_i = 1) - \lambda_a^-(i + \frac{1}{2})P(A_{i+1} = 1) \\ &= \frac{1}{Z} \left[\exp\left(\sum_{m=1}^n N_m \log \lambda_{am}\right) - \exp\left(\sum_{m=1}^n N_m \log \lambda_{ma}\right) \right] \end{aligned}$$

is in fact independent of i . Implicitly, this measure is actually defined with respect to a *rotating frame*, where by frame we mean the set $\{X_i^k\}$ slightly rotating as A circulates around the system. Indeed, after one complete tour of the tagged particle, the sequence $\{X_i^k\}$ has been shifted by one unit in the opposite direction ($X_i^k \rightarrow X_{i-1}^k$).

Another way of seeing things is to consider the steady-state regime of a particle moving around a circular lattice in a random environment. At each site i there are random transition rates $\lambda^\pm(i)$ corresponding to jumps to the left(-) or to the right(+). Then at steady state there is a uniform flux ϕ , which is independent of the lattice site and leads to the system of equations

$$\begin{aligned} \lambda^+(1)p\left(\frac{1}{2}\right) - \lambda^-(1)p\left(\frac{3}{2}\right) &= \phi, \\ &\dots \\ \lambda^+(i)p\left(i - \frac{1}{2}\right) - \lambda^-(i)p\left(i + \frac{1}{2}\right) &= \phi, \\ &\dots \\ \lambda^+(N)p\left(N - \frac{1}{2}\right) - \lambda^-(N)p\left(\frac{1}{2}\right) &= \phi. \end{aligned}$$

Hence,

$$p\left(i + \frac{1}{2}\right) = \sum_{l=1}^N p\left(i + \frac{1}{2}, l\right),$$

with

$$p\left(i + \frac{1}{2}, l\right) = \frac{\phi}{\det} \prod_{j=1}^{l-1} \lambda_k^-(j) \prod_{j=l+1}^i \lambda_k^+(j),$$

and

$$\det = \prod_{i=1}^N \lambda^+(i) - \prod_{i=1}^N \lambda^-(i).$$

Of course when the determinant vanishes, we recover the reversible case which is exactly Kolmogorov' criterion. To see the meaning of $p(i + \frac{1}{2}, l)$, introduce a fictitious particle moving in the complementary lattice of intermediate sites, so that l be located between $l - \frac{1}{2}$ and $l + \frac{1}{2}$ (see figure 6.1a), but with the important restriction that no overtaking is permitted between the two particles. This is materialized by a cut on the (i, l) torus (see figure 6.1.b). As long as one does not cross the cut drawn

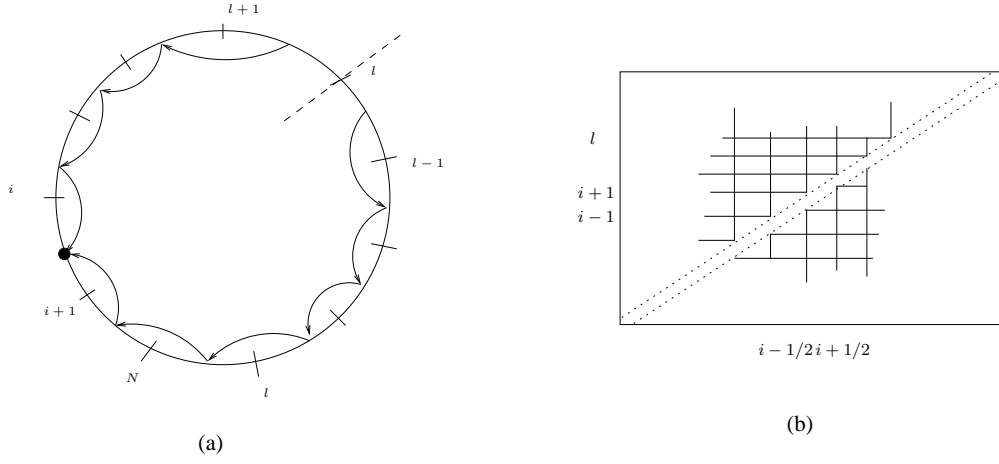

Fig. 6.1: interpretation of $p(i + \frac{1}{2}, l)$ (a). Cut in the transitions (b)

in figure 6.1.b, the following detailed balance holds along a horizontal line

$$\frac{p(i + \frac{3}{2}, l)}{p(i + \frac{1}{2}, l)} = \frac{\lambda^+(i + 1)}{\lambda^-(i + 1)}.$$

Similarly, along a vertical line, we have

$$\frac{p(i + \frac{1}{2}, l + 1)}{p(i + \frac{1}{2}, l)} = \frac{\lambda^-(l)}{\lambda^+(l + 1)}.$$

This shows at once that $p(i + \frac{1}{2}, l)$ is the invariant measure of this 2-particle system. Combining these last two equations, we get

$$\begin{cases} \lambda^+(i + 1)p(i + \frac{1}{2}, i + 1) = \lambda^+(i + 2)p(i + \frac{3}{2}, i + 2), \\ \lambda^-(i + 1)p(i + \frac{3}{2}, i + 1) = \lambda^-(i)p(i + \frac{1}{2}, i). \end{cases}$$

This means the measure we consider is still the stationary one, provided that the following transitions rates are added

$$\begin{aligned} (i + \frac{1}{2}, i + 1) &\xrightarrow{\lambda^+(i+1)} (i + \frac{3}{2}, i + 2) \\ (i + \frac{3}{2}, i + 1) &\xrightarrow{\lambda^-(i+1)} (i + \frac{1}{2}, i), \end{aligned}$$

which is tantamount to adding transition jumps along the cut (without crossing it however). By construction we meet again the correct rates between i and $i + 1$ and the corresponding measures of this model, simply by summing over l . In addition the value of the flux is obtained directly by

$$\phi = \lambda^+(i + 1)p(i + \frac{1}{2}, i + 1) - \lambda^-(i + 1)p(i + \frac{3}{2}, i) = \frac{\phi}{\det} \times \det,$$

as expected. This procedure of adding moving walls (a fictitious particle) could be useful in some cases to construct the invariant measure when reversibility is lost.

6.2 Cycles in the state-graph and matrix-form solutions

6.2.1 Tagged particle cycles

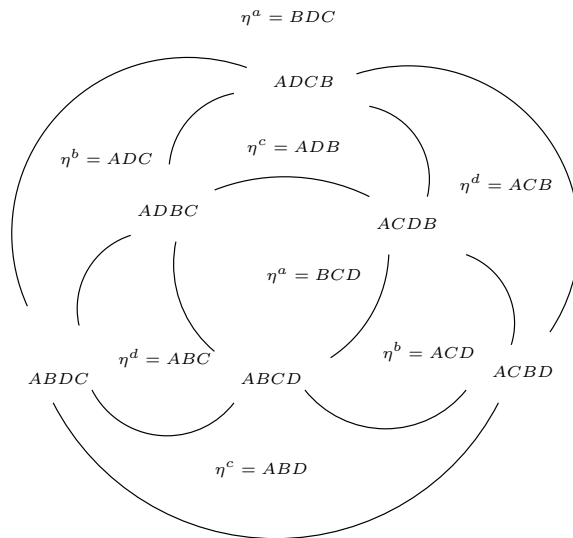

Fig. 6.2: Graph of the state space and the dual graph corresponding to cycles for a local exchange process of type (2.1), with 4 letters and periodic boundary conditions.

By state-graph, we mean the graph in which nodes represent all individual states of the system, and arcs are the allowed transitions between states connecting these nodes. By definition a closed path in the graph means that all visited nodes are

visited only once, but the extremity which is visited twice. Regarding to Kolmogorov's criteria, two types of cycles arise: trivial and non-trivial cycles. Let $\{\eta_1, \eta_2, \dots, \eta_k, \eta_1\}$ be a cycle involving k different states, and $\lambda_{12}, \lambda_{23}, \dots, \lambda_{k1}$ the set of transition rates attached to each arc, and $\lambda_{21}, \lambda_{32}, \dots, \lambda_{1k}$ to the reversed ones (assuming each transition is reversible with a finite rate). Then, to check reversibility, we attach to this cycle a coefficient

$$\frac{\gamma_+}{\gamma_-} \stackrel{\text{def}}{=} \frac{\lambda_{12}\lambda_{23}\dots\lambda_{k1}}{\lambda_{21}\lambda_{32}\dots\lambda_{1k}}, \quad (6.1)$$

and Kolmogorov's criterion holds if and only if this coefficient is equal to 1.

When transitions consist only in particle exchanges between neighbouring sites, which is the case either in the simple exclusion process ($n = 2$) or for the multi-type particle system (n odd in our model definition), it is possible to identify a set of elementary cycles which play an important role in the description of the stationary regime.

Definition 6.1. *For a purely particle exchange model, with an arbitrary number of particle species and periodic boundary conditions, a **tagged particle cycle** (TPC) is the set of states scanned during the process where a particle of a given type is transported around the system after performing successive allowed jumps (including virtual exchanges with particles of the same species). Let η be the sequence corresponding to one of these states. If i is the position in the sequence of the letter which is transported, the cycle is denoted by the reduced word η_i^* , obtained from η after removing the letter of type x at the i^{th} position.*

This definition has to be adapted when the system is open, because in this case transporting a particle around is not anymore meaningful. For the simple exclusion process, we propose the following

Definition 6.2. *For a simple particle exclusion process with open boundary, a **tagged particle cycle** is the set of states scanned during the following process: a particle, travels to the right (assuming it can), reaches the right end of the system, then is converted into a hole, which in turn travels back through the system until reaching the left end, where it is converted into a particle which finally will move to the right to the starting point. This definition is completed by exchanging right with left and particle with hole, as long as all steps of the process are allowed.*

This definition is illustrated in figure 6.3.a. All other cycles are of the type depicted in 6.3.c, so that they are trivial, as far as from Kolmogorov's criteria are concerned.

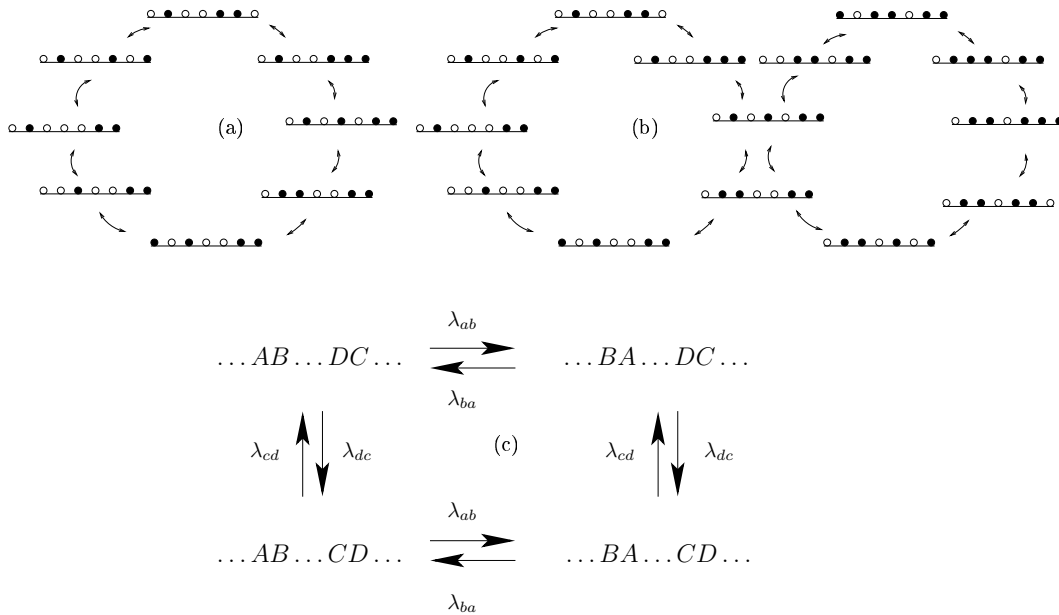

Fig. 6.3: Example of TPC in the state space for asep with 7 particles and open boundary (a). If the process is not totally asymmetric, and if particles can both enter and leave the system at each end, a transition pertains to two contiguous TPC (b). (c) represents a trivial cycle, Kolmogorov's coefficient (6.1) is 1, whatever the type of particles may be.

6.2.2 Cycle combinatorics

The system is not reversible if Kolmogorov's criterion fails at least for one TPC. From a combinatorial point of view, it may seem surprising at first glance that, for the class of systems we consider, the condition that Kolmogorov's criterion holds for each TPC is not only necessary but also sufficient. Indeed, as shown below, the total number of independent cycles in the state space is much larger than the number of TPC.

This can be observed by performing a combinatoric analysis, remember the state-graph defines a graph in which each node is a state, and each arc connecting two nodes stands for an allowed transition. From basic results in graph theory (see [2]), the quantity giving the number of independent cycles in an arbitrary graph \mathcal{G} is called the *cyclomatic number*

$$\nu(\mathcal{G}) = m - n + p, \quad (6.2)$$

where n, m, p are the respective number of nodes, arcs and components. In all our cases, since the system is irreducible, the number of component is $p = 1$. It remains to evaluate the number of nodes and the number of arcs. The general case is involved. Thus we shall only consider two simple cases, where all elementary rates (in the original process) are positive, and each arc of the state-graph will count both for a transition and its reverse.

1st case: ASEP system of size N with open boundary conditions.

The number of states is 2^N and, from the very definition, the number of independent TPC is exactly the number of sequence of size $N - 1$, i.e. 2^{N-1} . To compute the number of arcs, we introduce n_k^N the number of configurations of size N with k sectors of identical particles: this is precisely the number of partitions of N with k elements. This yields the simple recurrence

$$n_k^{N+1} = n_{k-1}^N + n_k^N,$$

the corresponding generating function being given by

$$f(x, y) \stackrel{\text{def}}{=} \sum_{N=1}^{\infty} \sum_{k=1}^N n_k^N x^k y^N = \frac{2xy}{1 - x - xy}.$$

A state with k sector can experience $k + 1$ possible transitions, therefore the number of arcs of the graph is

$$m = \frac{1}{2} \frac{1}{N!} \frac{\partial^N}{\partial y^N} \frac{\partial}{\partial x} [x f(x, y)] \Big|_{x=1, y=0} = 2^{N-1} \left(1 + \frac{N+1}{2} \right).$$

Hence

$$\nu(\mathcal{G}) = 2^{N-2}(N - 1) + 1,$$

and

$$\frac{\nu(\mathcal{G})}{m} = \frac{N - 1}{2} + 2^{1-N}.$$

showing, for large N , an asymptotic factor of $N/2$ between the cyclomatic number $\nu(\mathcal{G})$ and the number of TPC.

2nd case: N particle system of size N with periodic boundary conditions.

Because of invariance under circular permutation of the particles of a given state, the number of states is $(N - 1)!$. The number of arcs is exactly $N/2$ times the number of states, i.e. $\frac{N!}{2}$. Therefore,

$$\nu(\mathcal{G}) = (N - 1)! \left(\frac{N}{2} - 1 \right) + 1.$$

Here the number of TPC is given by $N(N - 2)! = N(N - 1)!/(N - 1)$, where N is the number of possible letters to remove. Indeed, recalling from the definition that a TPC is obtained by removing a letter from a sequence, $(N - 1)!$ is the number of states and $1/(N - 1)$ a symmetry factor due to circular permutation of $N - 1$ letter sequence corresponding to a cycle. Thus we observe again the asymptotic factor of $N/2$, for large N , between the cyclomatic number and the number of TPC.

The conclusion of this qualitative analysis is that, given an independent set of cycles, most of them are not TPC. Without proving this fact for the moment, we can safely claim that any independent cycle can be decomposed on a basis consisting of the set of TPC, and of cycles of *second class* as these depicted in figure 6.3.c. Since this second class cycles are trivial with respect to Kolmogorov's criteria, in what follow we will solely deal with TPC.

6.2.3 Cycle currents and matrix solutions

A question is then whether it is possible to attach to these non trivial cycles, conserved quantities (which vanish when the system is reversible), namely particle currents. A transition taking place between two particles of different type, say $AB \rightarrow BA$, can be viewed either as a particle A travelling to the right, or as a particle B travelling to the left. Therefore, two joint TPC are involved in this exchange (see figure 6.3.b). Assuming this transition occurs between site i and $i + 1$, we consider the dual graph of the state-graph state, see figure (6.2), and we identify the center of each plaquette with an elementary TPC represented by a reduced word. In this way, a set of variables $\{\phi(\eta^*)\}$ is attached to the TPC plaquettes, while currents between states are attached to the links of the graph, which represent transition between states. Exploiting the conservation of probability mass at equilibrium,

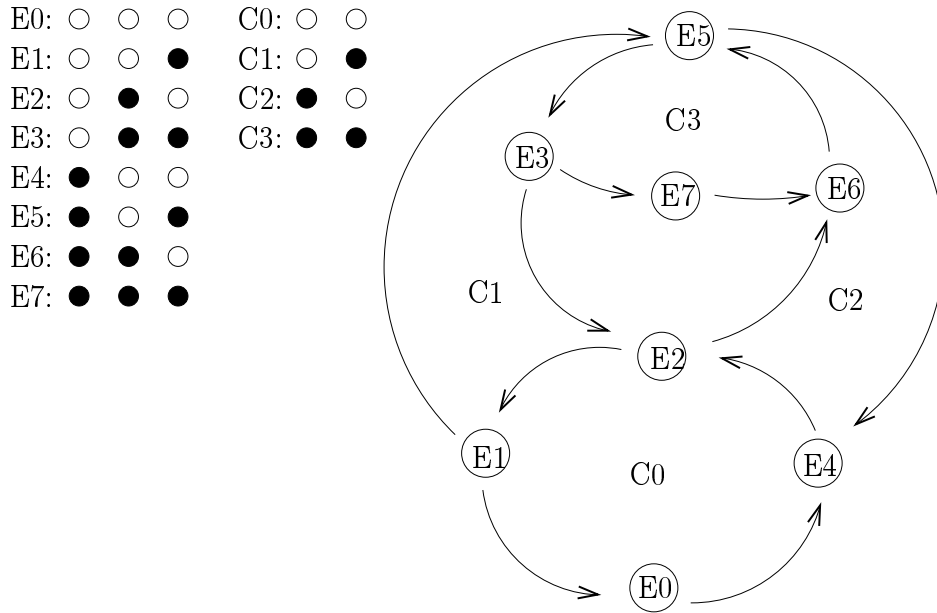

Fig. 6.4: Graph of the state space for a TASEP with three particles and the dual graph corresponding to the possibles cycles.

currents between states η and η' can be written in the form

$$\lambda_{ab}P_{\eta} - \lambda_{ba}P_{\eta'} = \phi_a(\eta_i^*) - \phi_b(\eta_{i+1}^*), \tag{6.3}$$

allowing to change current variables into cycle variables, as loop currents are introduced in an electric circuit. Recall that, by construction, if one follows a particle say a around a cycle, and if one writes (6.3) for each transition, the quantity $\phi(\eta_i^*)$ remains always the same along this cycle. Writing that equation for all states and all possible transitions produces a set of extended detailed balance equations, which, after eliminating all ϕ 's, would lead to the invariant measure equation. Before proving that this system of equations is well defined, let us make the link of these flux equations with the matrix-form solution [9] of the simple exclusion process. Take a system of size N , with two types of particles A and B , open boundary conditions, a rate of entrance α at the left end and a rate of escape β at the right end of the system. The invariant measure can be encoded by means of a matrix product in the following manner. A given sequence $\eta = ABA \dots BB$ is represented by a product of

E1: AABBC C_{a1} : ABBC
 E2: AABCB C_{a2} : ABCB
 E3: AACBB C_{a3} : ACBB
 E4: ABABC C_{c1} : AABB
 E5: ABACB C_{c2} : ABAB
 E6: ACABB

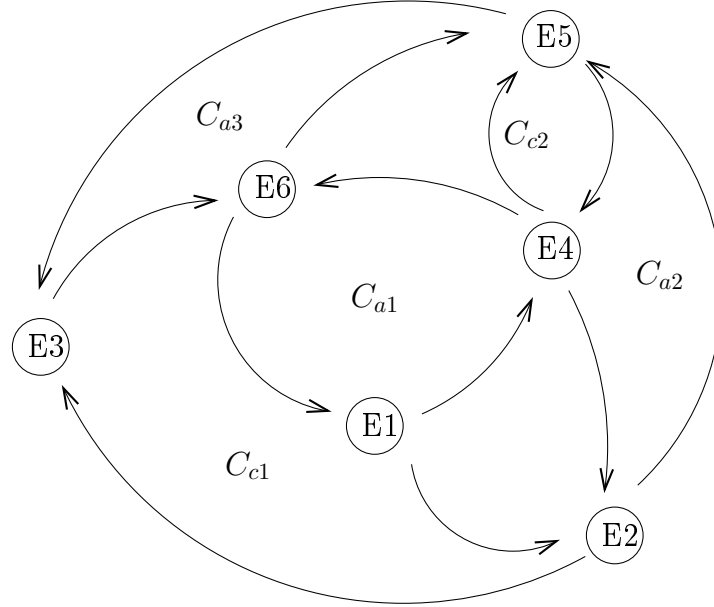

Fig. 6.5: Graph of the state space for a totally asymmetric ABC model with five particles, (A, A, B, B, C) and the dual graph corresponding to the possible cycles.

matrices U and V , and the corresponding weight is obtained by taking the trace

$$P_\eta = \text{Tr}(WUVU \dots VV),$$

where W is an additional matrix which takes into account the boundary property. A sufficient condition for this to be the invariant measure is that U, V, W satisfy

$$\begin{cases} \lambda_{ab}UV - \lambda_{ba}VU = U + V & (*) \\ UW = \frac{1}{\beta}W \\ WV = \frac{1}{\alpha}W. \end{cases}$$

The right side in $(*)$ is reminiscent of the second member of (6.3). In fact we have

$$\begin{aligned} \phi_a(\eta_i^*) &= \text{Tr}(W\eta_i^*) \\ \phi_b(\eta_{i+1}^*) &= -\text{Tr}(W\eta_{i+1}^b) \end{aligned}$$

It is remarkable in this case that variables attached to the dual lattice (the ϕ 's) take the form of a probability amplitude of a reduced exclusion process $[\text{Tr}(W\eta_i^*)]$ correspond to the stationary weight for a system of size $N - 1$. This suggests the existence of a dual process in the space of TPC, which can be formulated as an exclusion process.

6.3 A system of detailed equations for currents

When writing the system (6.3) for detailed currents, we have at hand m equations, m being the number of links of the state-graph, and $n + \nu_{\text{tpc}}$ unknowns, where n is the number of nodes and ν_{tpc} the number of TPC. In matrix form, this reads

$$MP = \Phi, \quad (6.4)$$

where

- M is a $m \times n$ matrix;
- P a column vector of size n , the elements of which are probability weights corresponding to each state;
- Φ is a column vector of size m , where each component is the algebraic contribution of all TPC having the corresponding link l in common, l being a line index, and we already know that the number of these contributions is at most 2, see figure 6.3.c.

To fix the sign conventions, we agree that orientations of cycles are given by the natural orientation of the system, i.e. each particle travels positively from left to right. An exception is made for the simple exclusion system, since in this case holes travel positively to the left and there is only one type of TPC.

$$\lambda_{10}P(\eta) - \lambda_{01}P(\eta') = \phi(\eta_i^*) + \phi(\eta_{i+1}^*) \quad \text{for ASEP,}$$

$$\lambda_{ab}P(\eta) - \lambda_{ba}P(\eta') = \phi_a(\eta_i^*) - \phi_b(\eta_{i+1}^*) \quad \text{for multi-type systems.}$$

As the cyclomatic number of the state graph is the number of independent cycles of the graph, we see from (6.2) that our system, since m is the number of equations and $n + \nu_{\text{tpc}}$ the number of unknown, is over-determined by a quantity

$$m - (n + \nu_{\text{tpc}}) = \nu - \nu_{\text{tpc}} - 1.$$

It is interesting to identify the origin of this over-determination and a set of resulting constraints put on the ϕ 's. To each line of the matrix M corresponds a transition between two states, so that a given cycle in the state-space is associated with some combination of lines of M (namely the successive transitions taking part in the cycle), and the resulting sub-matrix is a square matrix of size the number of states visited by the corresponding cycle.

If $\frac{\gamma_+}{\gamma_-}$ is Kolmogorov's coefficient (6.1) of this cycle, the related determinant is simply given by $\gamma_+ - \gamma_-$ and vanishes for all trivial cycles of the type depicted in figure 6.3.c. This means that the number of independent equations is $m - \nu + \nu_{\text{tpc}}$, which equals the number of unknown minus 1, the remaining degree of freedom being related the normalization condition. However, a certain number of compatibility conditions have to be imposed on the ϕ 's in order to eliminate safely all dependent equations of our system (6.4). These conditions lead directly to the basic recurrence scheme which is at the source of matrix-solutions obtained in the context of ASEP, but also for multi-type particle systems [1], as we shall see in the following lemma

Lemma 6.3. *Let N be the size of the system (number of sites), A a given type of particle, η a sequence of size N , and η^* a reduced sequence obtained from η by removing a letter A . Let also $P^{(N-1)}(\eta^*)$ be the normalized weight of state η^* in the invariant measure of the reduced process of size $N - 1$, and $C_a^{(N)}$ a constant associated with the type a . Then the form*

$$\phi_a^{(N)}(\eta^*) = C_a^{(N)} P^{(N-1)}(\eta^*),$$

fulfills the compatibility condition for all trivial cycles.

Proof. Instead of proving this for an arbitrary trivial cycle, we do it for the one depicted in figure 6.3, leaving to the reader the detail of the general case. To fix some notation, let η^1, η^2, η^3 and η^4 be the 4 states concerned by the cycle, so that

$$\begin{array}{lll} \eta^1 = \dots \mathbf{AB} \dots \mathbf{CD} \dots & \eta_i^{1*} = \dots \mathbf{B} \dots \mathbf{CD} \dots & \eta_{i+1}^{1*} = \dots \mathbf{A} \dots \mathbf{CD} \dots \\ \eta^2 = \dots \mathbf{BA} \dots \mathbf{CD} \dots & \eta_j^{2*} = \dots \mathbf{BA} \dots \mathbf{D} \dots & \eta_{j+1}^{2*} = \dots \mathbf{BA} \dots \mathbf{C} \dots \\ \eta^3 = \dots \mathbf{BA} \dots \mathbf{DC} \dots & \eta_i^{3*} = \dots \mathbf{A} \dots \mathbf{DC} \dots & \eta_{i+1}^{3*} = \dots \mathbf{B} \dots \mathbf{DC} \dots \\ \eta^4 = \dots \mathbf{AB} \dots \mathbf{DC} \dots & \eta_j^{4*} = \dots \mathbf{AB} \dots \mathbf{C} \dots & \eta_{j+1}^{4*} = \dots \mathbf{AB} \dots \mathbf{D} \dots \end{array}$$

Assume also A is in position i and C in position j in η_1 . Then, the system of equations restricted to this cycle takes the simple form

$$\lambda_{ab}P[\eta^1] - \lambda_{ba}P[\eta^2] = \phi_a[\eta_i^{1*}] - \phi_b[\eta_{i+1}^{1*}], \quad (a)$$

$$\lambda_{cd}P[\eta^2] - \lambda_{dc}P[\eta^3] = \phi_c[\eta_j^{2*}] - \phi_d[\eta_{j+1}^{2*}], \quad (b)$$

$$\lambda_{ba}P[\eta^3] - \lambda_{ab}P[\eta^4] = \phi_b[\eta_i^{3*}] - \phi_a[\eta_{i+1}^{3*}], \quad (c)$$

$$\lambda_{dc}P[\eta^4] - \lambda_{cd}P[\eta^1] = \phi_d[\eta_j^{4*}] - \phi_c[\eta_{j+1}^{4*}]. \quad (d)$$

As we already know, these equations are not independent. Hence taking the combination $\lambda_{cd}(a) + \lambda_{ba}(b) + \lambda_{dc}(c) + \lambda_{ab}(d)$ leads to eliminate one equation, but with the following constraint on the ϕ 's.

$$\begin{aligned} & \lambda_{cd}\phi_a[\eta_i^{1*}] - \lambda_{dc}\phi_a[\eta_{i+1}^{3*}] + \lambda_{dc}\phi_b[\eta_i^{3*}] - \lambda_{cd}\phi_b[\eta_{i+1}^{1*}] + \\ & \lambda_{ba}\phi_c[\eta_j^{2*}] - \lambda_{ab}\phi_c[\eta_{j+1}^{4*}] + \lambda_{ab}\phi_d[\eta_j^{4*}] - \lambda_{ba}\phi_d[\eta_{j+1}^{2*}] = 0 \end{aligned}$$

At this point, let us remark that, for example, η_i^{1*} and η_{i+1}^{3*} are in correspondence through the transition $CD \rightarrow DC$ at site $j, j+1$, as well as η_j^{2*} and η_{j+1}^{4*} with respect to the transition $AB \rightarrow BA$ at site $i, i+1 \dots$. From the hypothesis of the lemma, this gives

$$\begin{aligned} & C_a^{(N)} (C_c^{(N-1)} P^{(N-2)}[\eta_{i,j}^{1**}] - C_d^{(N-1)} P^{(N-2)}[\eta_{i,j+1}^{1**}]) + \\ & C_b^{(N)} (C_d^{(N-1)} P^{(N-2)}[\eta_{i,j}^{3**}] - C_c^{(N-1)} P^{(N-2)}[\eta_{i,j+1}^{3**}]) + \\ & C_c^{(N)} (C_b^{(N-1)} P^{(N-2)}[\eta_{i,j}^{2**}] - C_a^{(N-1)} P^{(N-2)}[\eta_{i+1,j}^{2**}]) + \\ & C_d^{(N)} (C_a^{(N-1)} P^{(N-2)}[\eta_{i,j}^{4**}] - C_b^{(N-1)} P^{(N-2)}[\eta_{i+1,j}^{4**}]) = 0, \end{aligned}$$

where $\eta_{i,j}^{1**}$ is the sequence obtained from η^1 by suppressing letters at site i and j . This last equation holds since

$$\begin{cases} \eta_{i,j}^{1**} = \eta_{i+1,j}^{2**}, & \eta_{i,j}^{3**} = \eta_{i+1,j}^{4**}, \\ \eta_{i,j}^{2**} = \eta_{i,j+1}^{3**}, & \eta_{i,j}^{4**} = \eta_{i,j+1}^{1**}. \end{cases}$$

■

6.4 Fluid limits

In this section we examine how the structural constants $C_k^{(N)}$, when they exist at microscopic level, are transposed at macroscopic level.

6.4.1 From the hydrodynamic functional

Proposition 6.4. *Let a local particle exchange system 2.1 of size N , with n types of particles and periodic boundary conditions. Assume the detailed current equations holds, for any pair of particle types k and l ,*

$$\lambda_{kl}^{(N)} P(\eta) - \lambda_{lk}^{(N)} P(\eta') = \phi_k(\eta_i^*) - \phi_l(\eta_{i+1}^*), \quad k, l = 1 \dots n,$$

altogether with the structure equation, valid for any type,

$$\phi_k^{(N)}(\eta^*) = C_k^{(N)} P^{(N-1)}(\eta^*), \quad k = 1 \dots n. \quad (6.5)$$

Then the limit functional $f_\infty[\phi] = \lim_{N \rightarrow \infty} f_\infty^{(N)}[\phi]$, where

$$f_\infty^{(N)}[\phi] = \sum_{\{\eta\}} P(\eta) \exp\left(\frac{1}{N} \sum_{k=1, i=1}^{n, N} X_i^k \phi_k\left(\frac{i}{N}\right)\right),$$

satisfies the equation

$$\frac{\partial}{\partial x} \frac{\partial f_\infty}{\partial \phi_k(x)} + \sum_{l \neq k} \alpha_{kl} \frac{\partial^2 f_\infty}{\partial \phi_k(x) \partial \phi_l(x)} = c_k f_\infty - v \frac{\partial f_\infty}{\partial \phi_k(x)}, \quad (6.6)$$

under the fundamental scaling

$$\lim_{N \rightarrow \infty} \log \frac{\lambda_{kl}^{(N)}}{\lambda_{lk}^{(N)}} = \alpha_{kl} \quad \text{and} \quad \forall l \neq k, \quad \lim_{N \rightarrow \infty} \frac{N^2 C_k^{(N)}}{\lambda_{kl}^{(N)}} = \lim_{N \rightarrow \infty} \frac{C_k^{(N)}}{D} = c_k,$$

with

$$v \stackrel{\text{def}}{=} \sum_{l=1}^n c_k.$$

Proof. We use the notation of section 4. In order to extract additional information at steady state, we refine our preceding variational analysis by defining the functional

$$T^{(N)}(\{\phi, \partial_x \phi\}) = \frac{N^2}{2} \left[\sum_{k \neq l, i=1}^{n, N} \tilde{\lambda}_{kl}^{(N)} \frac{\partial^2}{\partial \phi_l(\frac{i}{N}) \partial \phi_k(\frac{i+1}{N})} + \tilde{\lambda}_{lk}^{(N)} \frac{\partial^2}{\partial \phi_k(\frac{i+1}{N}) \partial \phi_l(\frac{i}{N})} \right] f_\infty^{(N)}, \quad (6.7)$$

which corresponds to the second member of equation (4.1) at steady state, and where it is understood that the sets $\{\phi\} \stackrel{\text{def}}{=} \{\phi(\frac{i}{N}), i = 1 \dots N\}$ and $\{\partial \phi\} \stackrel{\text{def}}{=} \{\frac{\partial \phi}{\partial x}(\frac{i}{N}), i = 1 \dots N\}$ are taken as independant parameters. This functional can be written in two different manners. Recalling the definitions

$$\Delta \psi_{kl}(i) \stackrel{\text{def}}{=} \phi_k(i+1) - \phi_k(i) - \phi_l(i+1) + \phi_l(i) \stackrel{\text{def}}{=} \Delta \psi_k(i) - \Delta \psi_l(i),$$

(6.7) may be rewritten in the form

$$\begin{aligned} T^{(N)}(\{\phi, \partial_x \phi\}) = ND \sum_{k=1, i=1}^{n, N} \partial_x \phi_k(\frac{i}{N}) & \left[\frac{\partial f_\infty^{(N)}}{\partial \phi_k(\frac{i}{N})} - \frac{\partial f_\infty^{(N)}}{\partial \phi_k(\frac{i+1}{N})} \right. \\ & \left. + \sum_{l \neq k} \frac{\alpha_{kl}}{2} \left(\frac{\partial^2 f_\infty^{(N)}}{\partial \phi_k(\frac{i}{N}) \partial \phi_l(\frac{i+1}{N})} + \frac{\partial^2 f_\infty^{(N)}}{\partial \phi_l(\frac{i+1}{N}) \partial \phi_k(\frac{i}{N})} \right) \right] + \mathcal{O}\left(\frac{1}{N}\right), \end{aligned} \quad (6.8)$$

On the other hand, combining the sums in (6.7) yields

$$\begin{aligned} T^{(N)}(\{\phi, \partial_x \phi\}) = N^2 \sum_{k, l=1, i=1}^{n, N} \sum_{\{\eta\}} e^{\frac{1}{N} \vec{\phi} \cdot \vec{\eta} + \frac{1}{2N} \Delta \psi_{kl}(i)} \sinh \frac{\Delta \psi_{kl}(i)}{2N} \\ \times X_i^k X_{i+1}^l \left[\lambda_{kl}^{(N)} P^{(N)}(\eta) - \lambda_{lk}^{(N)} P^{(N)}(\eta'_i) \right], \end{aligned} \quad (6.9)$$

where η is a given configuration, η'_i being the one obtained from η by exchanging i and $i+1$, and

$$\vec{\phi} \cdot \vec{\eta} = \sum_{k=1, i=1}^{n, N} X_i^k \phi\left(\frac{i}{N}\right).$$

>From the assumptions in the statement of the proposition, we can rewrite (6.9) as

$$\begin{aligned}
 T^{(N)}(\{\phi, \partial_x \phi\}) &= N^2 \sum_{k,l=1}^{n,N} \sum_{\{\eta\}} e^{\frac{1}{N} \vec{\phi} \cdot \vec{\eta} + \frac{1}{2N} \Delta \psi_{kl}(i)} \sinh \frac{\Delta \psi_{kl}(i)}{2N} \\
 &\quad \times X_i^k X_{i+1}^l \left[C_k^{(N)} P^{(N-1)}(\eta_i^*) - C_l^{(N)} P^{(N-1)}(\eta_{i+1}^*) \right],
 \end{aligned} \tag{6.10}$$

where η_i^* is the sequence obtained from η by removing the site i . We also have

$$\sum_{\eta} X_i^k P(\eta_i^*) e^{\frac{1}{N} \vec{\phi} \cdot \vec{\eta}} = f_{\infty}^{(N-1)}[\phi_i^*] e^{\frac{1}{N} \phi_k(\frac{i}{N})},$$

where $f_{\infty}^{(N-1)}[\phi_i^*]$ means that $f_{\infty}^{(N-1)}$ is considered as a function of the $n(N-1)$ variables $\{\phi_k(\frac{j}{N}), k=1, \dots, n; j=1, \dots, N, j \neq i\}$. Using all these ingredients, expanding (6.10) in powers of $\frac{1}{N}$ and keeping the dominant terms, we get

$$T^{(N)}(\{\phi, \partial_x \phi\}) = \frac{N^2}{2} \sum_{k,l=1}^{n,N} \Delta \psi_{kl}(i) \left[C_k^{(N)} \frac{\partial f_{\infty}^{(N-1)}}{\partial \phi_l(\frac{i+1}{N})} - C_l^{(N)} \frac{\partial f_{\infty}^{(N-1)}}{\partial \phi_k(\frac{i}{N})} \right] + \mathcal{O}\left(\frac{1}{N}\right). \tag{6.11}$$

Now, rearranging the summation, using the exclusion property

$$\sum_{l=1}^n \frac{\partial}{\partial \phi_l(\frac{i}{N})} = \frac{1}{N},$$

comparing (6.8) and (6.11), we finally obtain

$$\begin{aligned}
 N^2 \sum_{k=1}^{n,N} \partial_x \phi_k\left(\frac{i}{N}\right) &\left[\frac{\partial f_{\infty}^{(N)}}{\partial \phi_k(\frac{i}{N})} - \frac{\partial f_{\infty}^{(N)}}{\partial \phi_k(\frac{i+1}{N})} + \frac{\alpha^{kl}}{2} \left(\frac{\partial^2 f_{\infty}^{(N)}}{\partial \phi_k(\frac{i}{N}) \partial \phi_l(\frac{i+1}{N})} + \frac{\partial^2 f_{\infty}^{(N)}}{\partial \phi_l(\frac{i+1}{N}) \partial \phi_k(\frac{i}{N})} \right) \right] \\
 &= N^2 \sum_{k,i=1}^{n,N} \partial_x \phi_k\left(\frac{i}{N}\right) \left[\frac{C_k^{(N)}}{D} f_{\infty}^{(N-1)} - \sum_{l=1}^n \frac{C_l^{(N)}}{D} \frac{\partial f_{\infty}^{(N-1)}}{\partial \phi_k(\frac{i}{N})} \right] + \mathcal{O}\left(\frac{1}{N}\right).
 \end{aligned}$$

As the last equality holds for any $\partial_x \phi_k$, letting $N \rightarrow \infty$ implies easily (6.6), which was to be proved. \blacksquare

6.4.2 Lotka-Volterra systems and out-of-equilibrium stationary states

Here we will establish the connection between the structural constants (6.5) of the current equations associated with the invariant measure and the fluid limit description of stationary states. From the results obtained in section 4, we are looking for a solution of the form

$$f_\infty(\phi) = \exp\left(\int_0^1 dx \sum_{k=1}^N \rho_k^\infty(x) \phi_k(x)\right),$$

which, instantiated into (6.6), yields gives the following equations for the ρ_k^∞ 's .

$$\frac{\partial \rho_k^\infty}{\partial x} - \rho_k^\infty \sum_{l \neq k} \alpha^{kl} \rho_l^\infty = c_k - v \rho_k^\infty, \quad k = 1 \dots n.$$

The interpretation of this system is now quite clear : it is exactly a particular stationary solution of the system formed by the coupled Burger's equations

$$\frac{\partial \rho_k}{\partial t} = \frac{\partial^2 \rho_k}{\partial x^2} - \frac{\partial}{\partial x} \left(\rho_k \sum_{l \neq k} \alpha^{kl} \rho_l \right), \quad k = 1 \dots n,$$

where the functions ρ_k are sought in the class

$$\rho_k(x, t) \stackrel{\text{def}}{=} \rho_k^\infty(x - vt),$$

the variable $(x - vt)$ being taken [modulo 1]. Hence, there is a frame rotating at velocity v , in which ρ_k^∞ is periodic. Moreover, in this frame, the stationary currents do not vanish and have constant values

$$J_k(x) = \frac{\partial \rho_k^\infty}{\partial x} + \rho_k^\infty \left(v - \sum_{l \neq k} \alpha^{kl} \rho_l^\infty \right) = c_k.$$

Therefore, while the macroscopic constants $\{c_k, k = 1, \dots, n\}$ are in principle determined from the periodic boundary conditions constraints and from the fixed average values of each particle species, they can also be directly derived from the microscopic model, as soon as the structural constants do exist.

6.5 Permanent currents at steady state

6.5.1 A scheme with currents

In our preceding studies, we devised a scheme to obtain a fluid limit at steady state, first for the reversible square-lattice model in [14], and also for the ABC model when it is non-reversible case [15]. Here we generalize this procedure to transient n -type particle systems, resting upon the hydrodynamic hypothesis partially established in section 4, and which will be precisely stated.

For any particle-type k , the rescaled discrete current reads

$$J_k^{(N)}\left(\frac{i}{N}\right) \stackrel{\text{def}}{=} \lambda_k^+(i+1)X_i^k - \lambda_k^-(i)X_{i+1}^k, \quad i = 1, \dots, N, \quad (6.12)$$

with

$$\begin{cases} \lambda_k^+(i) \stackrel{\text{def}}{=} \sum_{l \neq k} \frac{\lambda_{kl}}{N} X_i^l + \Gamma_k X_i^k, \\ \lambda_k^-(i) \stackrel{\text{def}}{=} \sum_{l \neq k} \frac{\lambda_{lk}}{N} X_i^l + \Gamma_k X_i^k, \end{cases}$$

where arbitrary constants Γ_k have been introduced (they not modify the value of J_k) to ensure that the λ_k^\pm 's never vanish. To be consistent with other scalings, Γ_k is assumed to scale like N . Our hypothesis is that J_k has a limiting distribution, $J_k(x)$, such that, for any integrable complex-valued function α ,

$$\lim_{N \rightarrow \infty} \frac{1}{N} \sum_{i=1}^N \alpha\left(\frac{i}{N}\right) J_k^{(N)}\left(\frac{i}{N}\right) = \int_0^1 \alpha(x) J_k(x) dx. \quad (6.13)$$

In addition, the system will be said *equidiffusive*, if there exists a single diffusion constant D , such that, for all pair of species (k, l) ,

$$\lim_{N \rightarrow \infty} \frac{\lambda_{kl}(N)}{N^2} = D \quad [\text{equidiffusion}].$$

To simplify the notation, consider equation for $k = 1$, writing $J_a \stackrel{\text{def}}{=} J_1$ and replacing X_i^1 by A_i . Then solving (6.12) as a linear system yields

$$A_{i+1} = \frac{\lambda_a^+(i+1)A_i - J_a^{(N)}\left(\frac{i}{N}\right)}{\lambda_a^-(i)}.$$

This relationship between A_i and A_{i+1} can be iterated, by means of a 2×2 matrix products. Indeed, introducing the pair of numbers (u_i, v_i) such that $A_i = \frac{u_i}{v_i}$, the recursion becomes

$$\begin{bmatrix} u_{i+1} \\ v_{i+1} \end{bmatrix} = \begin{bmatrix} \sqrt{\frac{\lambda_a^+(i+1)}{\lambda_a^-(i)}} & -\frac{J_a^{(N)}\left(\frac{i}{N}\right)}{\sqrt{\lambda_a^+(i+1)\lambda_a^-(i)}} \\ 0 & \sqrt{\frac{\lambda_a^-(i)}{\lambda_a^+(i+1)}} \end{bmatrix} \begin{bmatrix} u_i \\ v_i \end{bmatrix} \stackrel{\text{def}}{=} M_i \begin{bmatrix} u_i \\ v_i \end{bmatrix},$$

where for convenience we divided everything by the common factor $\sqrt{\lambda_a^-(i)\lambda_a^+(i+1)}$. Let us define the quantities (p being a positive integer)

$$G_{a0}^{(N)}\left(\frac{i+p}{N}, \frac{i}{N}\right) \stackrel{\text{def}}{=} \prod_{j=i}^{i+p} \begin{bmatrix} \sqrt{\frac{\lambda_a^+(j+1)}{\lambda_a^-(j)}} & 0 \\ 0 & \sqrt{\frac{\lambda_a^-(j)}{\lambda_a^+(j+1)}} \end{bmatrix},$$

$$G_a^{(N)}\left(\frac{i+p}{N}, \frac{i}{N}\right) \stackrel{\text{def}}{=} \prod_{j=i}^{i+p} M_j,$$

$$\sigma_a^{(N)}\left(\frac{i}{N}\right) \stackrel{\text{def}}{=} \begin{bmatrix} 0 & -\frac{J_a^{(N)}\left(\frac{i}{N}\right)}{\sqrt{\lambda_a^+(i+1)\lambda_a^-(i)}} \\ 0 & 0 \end{bmatrix}.$$

Because of the upper triangular structure of σ , we may simply express $G^{(N)}$ as

$$G_a^{(N)}\left(\frac{i+p}{N}, \frac{i}{N}\right) = G_{a0}^{(N)}\left(\frac{i+p}{N}, \frac{i}{N}\right) + \sum_{j=0}^p G_{a0}^{(N)}\left(\frac{i+p}{N}, \frac{i+j+1}{N}\right) \sigma_a^{(N)}\left(\frac{i+j}{N}\right) G_{a0}^{(N)}\left(\frac{i+j-1}{N}, \frac{i}{N}\right).$$

To handle this equation in the continuous limit, an additional transformation is needed. Let us define

$$L_i = \begin{bmatrix} \sqrt{\frac{\Gamma_a}{\lambda_a^+(i)}} & 0 \\ 0 & \sqrt{\frac{\lambda_a^+(i)}{\Gamma_a}} \end{bmatrix}, \quad R_i = \begin{bmatrix} \sqrt{\frac{\lambda_a^-(i)}{\Gamma_a}} & 0 \\ 0 & \sqrt{\frac{\lambda_a^-(i)}{\Gamma_a}} \end{bmatrix},$$

and

$$\begin{cases} \tilde{G}_a^{(N)}\left(\frac{i+p}{N}, \frac{i}{N}\right) = L_{i+p+1} G_a^{(N)}\left(\frac{i+p}{N}, \frac{i}{N}\right) R_i \\ \tilde{G}_{a0}^{(N)}\left(\frac{i+p}{N}, \frac{i}{N}\right) = L_{i+p+1} G_{a0}^{(N)}\left(\frac{i+p}{N}, \frac{i}{N}\right) R_i \end{cases} . \quad (6.14)$$

Then $\tilde{G}^{(N)}$, $\tilde{G}_0^{(N)}$ and $\tilde{\sigma}^{(N)}$ verify the new equation

$$\begin{aligned} \tilde{G}_a^{(N)}\left(\frac{i+p}{N}, \frac{i}{N}\right) &= \tilde{G}_{a0}^{(N)}\left(\frac{i+p}{N}, \frac{i}{N}\right) \\ &+ \sum_{j=0}^p \tilde{G}_{a0}^{(N)}\left(\frac{i+p}{N}, \frac{i+j+1}{N}\right) \tilde{\sigma}_a^{(N)}\left(\frac{i+j}{N}\right) \tilde{G}_{a0}^{(N)}\left(\frac{i+j}{N}, \frac{i+1}{N}\right), \end{aligned} \quad (6.15)$$

where

$$\tilde{\sigma}_a^{(N)}\left(\frac{i}{N}\right) = \begin{bmatrix} 0 & -\frac{\Gamma_a J_a^{(N)}\left(\frac{i}{N}\right)}{\lambda_a^+(i+1)\lambda_a^-(i)} \\ 0 & 0 \end{bmatrix}.$$

Noting that $A_{i+p+1}\Gamma_a/\lambda_a^+(i+p+1) = A_{i+p+1}$ and $A_i\Gamma_a/\lambda_a^-(i) = A_i$, the iteration between i and $i+p$ gives

$$A_{i+p+1} = \frac{\tilde{G}_{a11}^{(N)}\left(\frac{i+p}{N}, \frac{i}{N}\right) A_i + \tilde{G}_{a12}^{(N)}\left(\frac{i+p}{N}, \frac{i}{N}\right)}{\tilde{G}_{a22}^{(N)}\left(\frac{i+p}{N}, \frac{i}{N}\right)}.$$

We can now profit by the law of large numbers in equation (6.15). First of all, for N large, and fixing $x = i/N$ and $y = p/N$, we get

$$\begin{aligned} \tilde{G}_{a0}^{(N)}\left(\frac{i+p}{N}, \frac{i}{N}\right) &= \exp\left(\frac{\sigma_3}{2} \sum_{j=i+1, k=2}^{i+p, n} \log \frac{\lambda_{ak}}{\lambda_{ka}} X_j^k\right) \\ &= \exp\left(\frac{\sigma_3}{2} \int_x^{x+y} du \sum_{k=2}^n \alpha^{ak} \rho_k(u) + o(1)\right), \end{aligned}$$

where $\sigma_3 = \begin{bmatrix} 1 & 0 \\ 0 & -1 \end{bmatrix}$, from the hydrodynamic hypothesis. To proceed further, we have to distinguish between two situations.

[The equidiffusion case]

Recalling that Γ_a is a free parameter which scales like N , it is convenient in the *equidiffusion* case to impose the limit

$$\lim_{N \rightarrow \infty} \frac{\Gamma_a(N)}{N} = D.$$

Then, expanding $\tilde{\sigma}(i/N)$ with respect to $1/N$ yields

$$\tilde{\sigma}_a^{(N)}\left(\frac{i}{N}\right) = \begin{bmatrix} 0 & -\frac{J_a^{(N)}\left(\frac{i}{N}\right)}{ND} \\ 0 & 0 \end{bmatrix} + \mathcal{O}(N^{-2}),$$

and the limit

$$\tilde{G}_a(x+y, x) \stackrel{\text{def}}{=} \lim_{N \rightarrow \infty} \tilde{G}_a^{(N)}\left(\frac{i+p}{N}, \frac{i}{N}\right)$$

is provided by equation (6.15). Hence

$$\tilde{G}_a(x+y, x) = \tilde{G}_{a0}(x+y, x) + \int_x^{x+y} du \tilde{G}_{a0}(x+y, x+u) \tilde{\sigma}_a(x+u) \tilde{G}_{a0}(x+u, x), \quad (6.16)$$

with

$$\tilde{G}_{a0}(y, x) = \exp\left(\frac{\sigma_3}{2} \int_x^y du \sum_{k=2}^n \alpha_{ak} \rho_k(u)\right),$$

still by virtue of the hydrodynamic hypothesis (6.13). Now it is possible to close the equations between densities and currents. Letting

$$q_a\left(\frac{i}{N}\right) \stackrel{\text{def}}{=} \mathbb{E}\left(A_i \mid \{X_j^k, j < i, k = 1 \dots n\}\right),$$

we have

$$q_a\left(\frac{i}{N}\right) = \frac{\tilde{G}_{11}^a\left(\frac{i}{N}, 1\right) A_1 + \tilde{G}_{12}^a\left(\frac{i}{N}, 1\right)}{\tilde{G}_{22}^a\left(\frac{i}{N}, 1\right)} + o(1).$$

Hence, at fixed $x = i/N$, we get the limit relation

$$\rho_a(x) \stackrel{\text{def}}{=} \frac{u_a(x)}{v_a(x)} = \lim_{N \rightarrow \infty} q_a\left(\frac{i}{N}\right),$$

where u_a and v_a satisfy the differential system

$$\begin{aligned} \frac{\partial u_a}{\partial x} &= \frac{1}{2} \sum_{k=2}^n \alpha_{ak} \rho_k(x) u_a - \frac{1}{D} J_a(x) v_a, \\ \frac{\partial v_a}{\partial x} &= -\frac{1}{2} \sum_{k=2}^n \alpha_{ak} \rho_k(x) v_a, \end{aligned} \quad (6.17)$$

as a direct consequence of 6.16.

Combining these last two equations to write $\rho'_a = (u'_a v_a - v'_a u_a)/v_a^2$, we obtain the final deterministic expression for the current

$$J_a(x) = D \left(-\frac{\partial \rho_a}{\partial x} + \sum_{k=2}^n \alpha_{ak} \rho_k \rho_a \right), \quad (6.18)$$

which, combined with the continuity equation

$$\frac{\partial \rho_a}{\partial t} + \frac{\partial J_a}{\partial x} = 0,$$

leads again to a Burger's hydrodynamic equation. Using the central limit theorem, it is also possible to establish by the above approach various equations for stochastic hydrodynamics and current fluctuations. This is postponed to section 7.2.3.

[The hetero-diffusion case] Here, the limit (6.15) is a bit more tricky. In fact, the expansion of $\tilde{\sigma}$ involves correlations between currents and densities which already appear in the leading terms, and we expect an effective diffusion constant of the form

$$D_a(\rho) = D \exp \left(\sum_{k=2}^n \beta^{ak} \rho_k \right),$$

with

$$\begin{cases} D \stackrel{\text{def}}{=} \lim_{N \rightarrow \infty} \frac{1}{N^2} \exp \left(\frac{1}{n-1} \sum_{k=2}^n \log \lambda_{ak}(N) \right), \\ \beta^{ak} \stackrel{\text{def}}{=} \lim_{N \rightarrow \infty} \log \left(\frac{\lambda_{ak}}{N^2 D} \right). \end{cases}$$

We pursue no further the study of this case, which presumably could be handled with block-estimates technics (see [30]).

6.5.2 The square-lattice model

The procedure follows the lines of the preceding subsection. The current equations corresponding to both species have the form

$$\begin{aligned} J_a^{(N)} \left(\frac{i}{N} \right) &= \lambda_a^+(i) \tau_i^a \bar{\tau}_{i+1}^a - \lambda_a^-(i) \bar{\tau}_i^a \tau_{i+1}^a, \\ J_b^{(N)} \left(\frac{i}{N} \right) &= \lambda_b^+(i) \tau_i^b \bar{\tau}_{i+1}^b - \lambda_b^-(i) \bar{\tau}_i^b \tau_{i+1}^b, \end{aligned}$$

with the rates given by (2.5), and we restrict the present analysis to the symmetric case (see relations [2.4]). Reversing for example the equation for J_a leads to the homographic relationship

$$\tau_{i+1}^a = \frac{\lambda_a^+(i)\tau_i^a - J_a^{(N)}\left(\frac{i}{N}\right)}{(\lambda_a^+(i) - \lambda_a^-(i))\tau_i^a + \lambda_a^-(i)},$$

which again can be iterated by means of the matrix product \tilde{G}_a and equation (6.15). Define

$$\lambda(N) \stackrel{\text{def}}{=} \frac{\lambda^+(N) + \lambda^-(N)}{2}, \quad \mu(N) \stackrel{\text{def}}{=} \frac{\lambda^+(N) - \lambda^-(N)}{2},$$

and

$$\gamma(N) \stackrel{\text{def}}{=} \frac{\gamma^+(N) + \gamma^-(N)}{2}.$$

Then the proper scalings for large N are given by

$$\lim_{N \rightarrow \infty} \frac{\lambda(N)}{N^2} = D, \quad \lim_{N \rightarrow \infty} \frac{\gamma(N)}{N^2} = \Gamma, \quad \lim_{N \rightarrow \infty} \frac{\mu(N)}{N} = \eta.$$

Contrary to the last section, the transformation (6.14) is unnecessary. We have

$$\sigma_a^{(N)}\left(\frac{i}{N}\right) = \begin{bmatrix} 0 & -\frac{J_a^{(N)}\left(\frac{i}{N}\right)}{\sqrt{\lambda_a^+(i)\lambda_a^-(i)}} \\ \sqrt{\frac{\lambda_a^+(i)}{\lambda_a^-(i)}} - \sqrt{\frac{\lambda_a^-(i)}{\lambda_a^+(i)}} & 0 \end{bmatrix}.$$

Here $G_a^{(N)}$ cannot be given explicitly, but is instead solution of the following combinatorial self-consistent equation

$$\begin{aligned} G_a^{(N)}\left(\frac{i+p}{N}, \frac{i}{N}\right) &= G_{0a}^{(N)}\left(\frac{i+p}{N}, \frac{i}{N}\right) \\ &+ \sum_{j=0}^p G_{0a}^{(N)}\left(\frac{i+p}{N}, \frac{i+j}{N}\right) \sigma_a^{(N)}\left(\frac{i+j}{N}\right) G_a^{(N)}\left(\frac{i+j}{N}, \frac{i+1}{N}\right). \end{aligned} \quad (6.19)$$

Now

$$\tau_{i+p+1} = \frac{G_{11}^{(N)}\left(\frac{i+p}{N}, \frac{i}{N}\right)\tau_i + G_{11}^{(N)}\left(\frac{i+p}{N}, \frac{i}{N}\right)}{G_{21}^{(N)}\left(\frac{i+p}{N}, \frac{i}{N}\right)\tau_i + G_{22}^{(N)}\left(\frac{i+p}{N}, \frac{i}{N}\right)}.$$

For the same reason as before, the limit G_a of $G_a^{(N)}$ does satisfy

$$G_a(x+y, x) = G_a^0(x+y, x) + \int_x^{x+y} du G_a^0(x+y, x+u) \sigma_a(x+u) G_a(x+u, x), \quad (6.20)$$

with

$$G_a^0(y, x) = \exp\left(\eta \sigma_3 \int_x^y (2\rho_b(u) - 1) du\right),$$

by just applying the law of large numbers in the formal expansion of $G_a^{(N)}$ with respect to $\sigma_a^{(N)}$. In the present report, we leave aside the question concerning existence and analytic properties of a solution of (6.20). As for the expression of σ_a , we must again discriminate between two situations.

[Case $\gamma = \lambda$]

$$\sigma_a(x) = \begin{bmatrix} \eta(2\rho_b - 1) & -\frac{J_a(x)}{D} \\ 2\eta(2\rho_b - 1) & \eta(1 - 2\rho_b) \end{bmatrix},$$

which leads to the following differential system, analogous to (6.17),

$$\begin{aligned} \frac{\partial u_a}{\partial x} &= \eta(2\rho_b - 1)u_a - \frac{1}{D}J_a(x)v_a, \\ \frac{\partial v_a}{\partial x} &= 2\eta(2\rho_b - 1)u_a + \eta(1 - 2\rho_b)v_a, \end{aligned}$$

so that

$$J_a(x) = -D\left(\frac{\partial \rho_a}{\partial x} + 2\eta\rho_a(1 - \rho_a)(1 - 2\rho_b)\right).$$

[Case $\gamma \neq \lambda$]

Like in the *hetero-diffusion* case of the last section, the effective diffusion constant $D_a(\rho)$ involves correlations between τ_i^b and τ_{i+1}^b and $J_a(i/N)$ in the leading order term, and we expect a behavior of the form [14]

$$D_a(\rho_b) = D \exp\left[2\rho_b(1 - \rho_b) \log \frac{\gamma}{\lambda}\right],$$

as a result of a multiplicative process. This could be obtained through renormalization technics applied directly to equation (6.19).

To conclude this section, we see that, for $\gamma = \lambda$, the differential system expressing, at steady state, the deterministic limit of the square lattice model with periodic boundary conditions finally reads, setting $\nu_{a,b} = 2\rho_{a,b} - 1$,

$$\begin{cases} \frac{\partial \nu_a}{\partial x} = \eta(1 - \nu_a^2)\nu_b + v\nu_a + \varphi^a, \\ \frac{\partial \nu_b}{\partial x} = -\eta(1 - \nu_b^2)\nu_a + v\nu_b + \varphi^b, \end{cases} \quad (6.21)$$

where v is a possibly finite drift velocity and $\varphi^a = \varphi(\bar{\nu}_a, \bar{\nu}_b)$ and $\varphi^b(\bar{\nu}_a, \bar{\nu}_b)$ are two constant currents in the translating frame. These currents have to be determined in a self-consistent manner, after fixing the average densities $\bar{\nu}_a$ and $\bar{\nu}_b$ and the periodic boundary conditions. For $v = 0$, the system (6.21) is Hamiltonian with

$$H = \frac{\eta}{2}[\nu_a^2\nu_b^2 - \nu_a^2 - \nu_b^2] + \varphi_b\nu_a - \varphi_a\nu_b. \quad (6.22)$$

Indeed, it is easy to observe that (6.21) can be rewritten as

$$\frac{\partial \nu_a}{\partial x} = -\frac{\partial H}{\partial \nu_b}, \quad \frac{\partial \nu_b}{\partial x} = \frac{\partial H}{\partial \nu_a}.$$

The degenerate fixed point $\nu_{a,b}(x) = \bar{\nu}_{a,b}$ is always a trivial solution and corresponds to the relations

$$\varphi_a = \eta(\bar{\nu}_a^2 - 1)\bar{\nu}_b, \quad \varphi_b = \eta(1 - \bar{\nu}_b^2)\bar{\nu}_a.$$

7 Local equilibrium and stochastic corrections

The goal of this section is to go beyond the law of large numbers, and to tackle microscopic and macroscopic currents from several points of view (central limit theorem, large deviations).

7.1 Time-scale for local equilibrium

In keeping with our approach, we discuss the question of local equilibrium [30] by means of the following functional

$$Y_t^{(N)} \stackrel{\text{def}}{=} \exp\left(\frac{1}{N} \sum_{k,l=1, i=1}^{n,N} \phi_{kl}\left(\frac{i}{N}\right) X_i^k X_{i+1}^l\right).$$

Without entering into cumbersome technical details, let us just notice that the explicit computation of $L_t^{(N)} Y_t^{(N)}$ shows that $L_t^{(N)} Y_t^{(N)}$ scales like $\mathcal{O}(N)$ instead of $\mathcal{O}(1)$ as $L_t^{(N)} Z_t^{(N)}$. This fact can be interpreted as follows. The empiric measure

$$\mu_t^{(N)} \stackrel{\text{def}}{=} \frac{1}{N} \sum_{k,l=1,i=1}^{n,N} \phi_{kl} \left(\frac{i}{N} \right) X_i^k X_{i+1}^l$$

is a convolution of the distribution of interfaces between particle domains with a set of arbitrary functions. To a given particle density distribution, drawn from the set of local hydrodynamic densities, corresponds an arrangement of these interfaces which somehow characterizes the local correlations between particles. As shown in section 6.5, these correlations vanish at steady state, at least when the system is *equidiffusive*. Moreover, this scaling tells us that correlations vanish at a time-scale *faster* than the diffusion scale, by a factor of N . Therefore, even in transient regime, correlations are negligible for the family of diffusive processes under study. A more formal proof of this fact is postponed to the completion of the functional approach initiated in [16].

7.2 Microscopic currents

7.2.1 Particle currents

An essential feature of particle systems is that the number of particles is locally conserved. This property is reflected as $N \rightarrow \infty$ by a continuity equation, which relates local variations of particle density to inhomogeneous fluxes or currents. In a discretized framework, conservation of particles is expressed according to the following

Proposition 7.1. *Let $\{J_i^k(t, \epsilon)\}$ $i = 1, \dots, N$ be stochastic variables corresponding to the fluxes of particles of type $k \in \{1, \dots, n\}$ between site i and $i + 1$, such that*

$$J_i^k(t, \epsilon) \stackrel{\text{def}}{=} \frac{1}{\epsilon} \sum_{l \neq k} \left(X_i^k(t) X_{i+1}^l(t) X_i^l(t+\epsilon) X_{i+1}^k(t+\epsilon) - X_i^l(t) X_{i+1}^k(t) X_i^k(t+\epsilon) X_{i+1}^l(t+\epsilon) \right)$$

with $\epsilon > 0$. By definition $J_i^k(t, \epsilon)$ are ternary variables in $\{-\frac{1}{\epsilon}, 0, +\frac{1}{\epsilon}\}$. The following identity, equivalent to particle conservation,

$$\lim_{\epsilon \rightarrow 0} \frac{X_i^k(t+\epsilon) - X_i^k(t)}{\epsilon} + J_{i+1}^k(t, \epsilon) - J_i^k(t, \epsilon) = 0 \quad a.s., \quad (7.1)$$

holds for all $i \in \{1, \dots, N\}$, $\forall t \in \mathbb{R}^+$. In addition, letting $\eta^{(N)}(t)$ denote the sequence $\{X_i^k(t)\}$, $i = 1, \dots, N; k = 1, \dots, n\}$, then the variables $\{J_i^k(t, \epsilon)\}$, $i = 1, \dots, N; k = 1, \dots, n\}$, have a joint conditional Laplace transform given by

$$h_{t,\epsilon}^{(N)}(\phi) \stackrel{\text{def}}{=} \mathbb{E}_t \left(\exp \left(\frac{1}{N} \sum_{k < l, i=1}^{n,N} \phi_k \left(\frac{i}{N} \right) \epsilon J_i^k(t, \epsilon) \right) \middle| \eta(t) \right) = o(\epsilon) + \mathbb{E}_t \left[\exp \left(\epsilon \sum_{k \neq l, i=1}^{n,N} \lambda_{kl} X_i^k X_{i+1}^l \left(e^{\frac{1}{N} \psi_{kl} \left(\frac{i}{N} \right)} - 1 \right) + \lambda_{lk} X_i^l X_{i+1}^k \left(e^{-\frac{1}{N} \psi_{kl} \left(\frac{i}{N} \right)} - 1 \right) \right) \right], \quad (7.2)$$

where ϕ_k , $k = 1, \dots, n$ is a set of \mathbf{C}^∞ bounded functions, and $\psi_{kl} = \phi_k - \phi_l$.

Proof. The points are mere consequences of the definition of the generator and the Markovian property of the process. In particular, (7.1) results from the fact that, almost surely, at most one jump takes place in the time-interval ϵ , when $\epsilon \rightarrow 0$, since all events are due to independent Poisson processes. In addition, on the time interval $[t, t + \epsilon]$, the occurrence of a particle exchange between sites i and $i + 1$, corresponding to $\epsilon J_i^k(t, \epsilon) = 1$ is only conditioned by the presence of a pair (k, l) at $(i, i + 1)$, with a transition rate given by $\lambda_{kl} X_i^k X_{i+1}^l$. Therefore

$$h_{t,\epsilon}^{(N)}(\phi) = \mathbb{E}_t \left(\prod_{k \neq l, i=1}^{n,N} \left[1 + \epsilon \lambda_{kl} X_i^k X_{i+1}^l \left(e^{\frac{1}{N} \psi_{kl} \left(\frac{i}{N} \right)} - 1 \right) \right] \right),$$

which, after a first order expansion with respect to ϵ , leads to (7.2). ■

7.2.2 An iterative numerical scheme

Given a sample path $\eta^{(N)}(t)$ at time t , we may generate a current sequence $\{J_i^k(t, \epsilon)\}$ according to the local product form encountered earlier. In turn, once the set $\{J_i^k(t, \epsilon)\}$ is known, the sequence $\eta(t + \epsilon)$ is almost surely determined, as $\epsilon \rightarrow 0$, by the identity (7.1), expressing conservation law of particles. We therefore have at hand an explicit stochastic numerical scheme to generate the sequence $\eta(t)$ step by step.

Proposition 7.2. *For any $\epsilon > 0$, $N \in \mathbb{N}$, the iterative scheme given by*

$$Q_{n+1}(\eta) = \sum_{\eta'} P_\epsilon(\eta|\eta') Q_n(\eta),$$

where $P_\epsilon(\eta|\eta')$ is defined according to (7.1) and (7.2), converges when $\epsilon \rightarrow 0$ to the original probability measure $P_{t=n\epsilon}(\eta)$ generated by the original semi-group.

Proof. There is only thing to show: $\forall T > 0$, the probability p_ϵ that $\exists t \in [0, T]$, such that two adjacent transitions occur within the same time-interval $[t, t + \epsilon]$, tends to 0 when $\epsilon \rightarrow 0$. This is warranted by the fact that the total number of transitions for $t < T$ is almost certainly finite. Indeed, we have

$$p_\epsilon \leq 1 - \left(1 - (\max_{kl} \lambda_{kl})^2 \epsilon^2\right)^{\frac{NT}{\epsilon}} \xrightarrow{\epsilon \rightarrow 0} 0.$$

For the hydrodynamic limit the rates λ_{kl} scale like N^2 for large N . Thus, it will be convenient to take a single limit $\epsilon \stackrel{\text{def}}{=} \epsilon(N) \rightarrow 0$ as $N \rightarrow \infty$, since the condition for the scheme to be meaningful writes

$$N\epsilon(N)(\max_{kl} \lambda_{kl})^2 = o(1),$$

so that we get a scaling of $\epsilon(N) = o(N^{-5})$ to meet our needs. This will allow us, in the sequel, to make use of the approximation

$$\sum_{i=1}^N \alpha_i^k \left(X_i^k(t + \epsilon) - X_i^k(t) - \sum_l (J_{i-1}^k - J_i^k) \epsilon \right) = o(\epsilon),$$

for any set of bounded complex numbers $\{\alpha_i^k\}$. ■

7.2.3 Central limit theorem for currents

We are in position to exploit the conditional product form (7.2) to perform a mapping, in the spirit of Lemma 4.1 of [14], in order to obtain a dynamical description of the system, in terms of some external free random process. To this end we assume the validity of the hydrodynamic limit, as a basic point, and we rely on the following lemma.

Lemma 7.3. *Suppose the existence of a set of density functions ρ_k , such that*

$$\mathbb{E} \left[\exp \left(\frac{1}{N} \sum_{k,i=1}^{n,N} X_i^k \phi_k \left(\frac{i}{N} \right) \right) \right] = \exp \left(\sum_{k,i=1}^{n,N} \log \left[1 + \rho_k \left(\frac{i}{N} \right) \left(e^{\phi_k \left(\frac{i}{N} \right)} - 1 \right) \right] + o(N^{-2}) \right),$$

for any given bounded complex function ϕ_k , and let $\phi = \sup_{1 \leq k \leq n; x \in [0,1]} (\phi_k(x))$. Then,

$$\mathbb{E} \left[\exp \left(\frac{1}{N} \sum_{k < l, i=1}^N \phi_k \left(\frac{i}{N} \right) \phi_l \left(\frac{i}{N} \right) X_i^k X_i^l \right) \right] = \exp \left(\frac{1}{N} \sum_{k < l, i=1}^N \phi_k \left(\frac{i}{N} \right) \phi_l \left(\frac{i}{N} \right) \rho_k \left(\frac{i}{N} \right) \rho_l \left(\frac{i}{N} \right) + o \left(\frac{\phi}{N} \right) \right).$$

From this we deduce the following identity,

$$h_{t,\epsilon}^{(N)}(\phi) = \exp \left(\epsilon \sum_{k < l, i=1}^{n,N} \lambda_{kl} \rho^k \left(\frac{i}{N} \right) \rho^l \left(\frac{i+1}{N} \right) \left(e^{\frac{1}{N} \psi_{kl} \left(\frac{i}{N} \right)} - 1 \right) + \lambda_{lk} \rho^l \left(\frac{i}{N} \right) \rho^k \left(\frac{i+1}{N} \right) \left(e^{-\frac{1}{N} \psi_{kl} \left(\frac{i}{N} \right)} - 1 \right) + o(\epsilon) \right), \quad (7.3)$$

which leads to recover (in our specific context) a formulation of the general result of [3] concerning fluctuation laws of currents for diffusive systems.

Define the following $n \times n$ symmetric matrix $M\{\rho_k, k = 1, \dots, n\}$

$$\begin{cases} M_{ij} = -\rho_i \rho_j, & i \neq j, \\ M_{ii} = \rho_i (1 - \rho_i). \end{cases}$$

The determinant of the matrix is $\prod_{k=1}^n \rho_k$, so that it is invertible if none of the ρ_k vanishes, the inverse being given by

$$\begin{cases} M_{ij}^{-1} = \frac{1}{\rho_i} + \frac{1}{\rho_j}, & i \neq j, \\ M_{ii}^{-1} = \frac{1}{\rho_i}. \end{cases} \quad (7.4)$$

after having taken into account the exclusion condition $\sum_{k=1}^n \rho_k = 1$. Since every line k or column k sums to $\rho_k \rho_n > 0$, all the eigenvalues are strictly positive, and hence $M(\rho)$ owns a real square-root matrix $M^{\frac{1}{2}}(\rho)$.

Proposition 7.4. *Let $\phi_k, k = 1, \dots, n-1$ denote a set of C^∞ bounded functions of the real variable $x \in [0, 1]$, $\{w_i^k, k = 1, \dots, n-1\}$ a set of independent identically distributed Bernoulli random variables with parameters $1/2$, taking at time t values in $\{-1/2, 1/2\}$. Then there exists a probability space, such that*

$$\begin{aligned} \frac{1}{N} \sum_{k,i=1}^{n,N} \phi_k\left(\frac{i}{N}\right) J_i^k \epsilon &= \frac{1}{N} \sum_{k,i=1}^{n,N} \phi_k\left(\frac{i}{N}\right) \left[\mathcal{J}^k\left(\rho\left(\frac{i}{N}\right)\right) \epsilon + \sqrt{D\epsilon} \sum_{l=1}^n M_{kl}^{\frac{1}{2}}\left(\rho\left(\frac{i}{N}\right)\right) w_i^l \right] \\ &+ \mathcal{O}(N^{-2}), \text{ a.s.}, \end{aligned} \quad (7.5)$$

where \mathcal{J}^k are deterministic currents expressed, in terms of densities, by

$$\mathcal{J}^k(\{\rho_l, l = 1 \dots n\}) \stackrel{\text{def}}{=} -D \left(\frac{\partial \rho_k}{\partial x} + \sum_{l \neq k} \alpha_{kl} \rho_k \rho_l \right).$$

The lines of arguments bare some features in common with the ones proposed in [14] (to study fluctuations at steady state). Recall, by law of large numbers, that correlations are negligible and do not affect the expression of the deterministic currents (6.18). This justifies the mapping (7.5). On the other hand, the calculation of coefficients $M_{ij}^{\frac{1}{2}}$ is done by comparing $h_{t,\epsilon}^{(N)}$ in (7.3) with

$$\begin{aligned} \mathbb{E} \left[\exp \left(\frac{1}{N} \sum_{k,i=1}^{n,N} \phi_k \left(\frac{i}{N} \right) \sqrt{D\epsilon} M_{kl}^{\frac{1}{2}} \left(\frac{i}{N} \right) w_i^l \right) \right] &= \\ \exp \left(\frac{D\epsilon}{2N^2} \sum_{kl} \phi_k \left(\frac{i}{N} \right) M_{kl} \left(\frac{i}{N} \right) \phi_l \left(\frac{i}{N} \right) + o(\epsilon) \right). \end{aligned}$$

As $M^{\frac{1}{2}}$ is symmetric, we see that the satisfactory expression for M is the one given above. Setting, for $k = 1, \dots, n$,

$$Y_k^{(N)}(x, t) \stackrel{\text{def}}{=} \frac{1}{\sqrt{N}} \sum_{i=1}^{[xN]} w_i^k,$$

the corresponding white noise processes

$$W^k(x, t) = \lim_{N \rightarrow \infty} Y_k^{(N)}(x, t),$$

describe current fluctuations in the continuous limit. It is worth remarking that, due to the exclusion constraint

$$\sum_{k=1}^n J_i^k(t, \epsilon) = 0, \quad \forall i \in \{1, \dots, N\},$$

there are only $n - 1$ independant processes $dW^k(x, t)$.

7.3 Macroscopic fluctuations

Two main quantities will be explored in this section: the Lagrangian and the large deviation functional.

7.3.1 The Lagrangian

The preceding section provides us with the coefficients needed in order to achieve an heuristic derivation of the Lagrangian [3] describing the current fluctuations. Given $\rho_k^{(N)}$ the empirical measure

$$\rho_k^{(N)}(x, t) \stackrel{\text{def}}{=} \frac{1}{N} \sum_{i=1}^n X_i^k(t) \delta(x - \frac{i}{N}),$$

assuming the system admits a hydrodynamic description in terms of density fields $\rho_k(x, t)$, the statement in [3] is that there is a large deviation principle for the stationary measure. In other words, the probability that the measure $\rho_k^{(N)}$ deviates from the hydrodynamic density profile ρ_k is exponentially small and given by

$$P\{\rho^{(N)}(t) \simeq \hat{\rho}(t), t \in [t_1, t_2]\} \simeq e^{-NI_{[t_1, t_2]}(\hat{\rho})},$$

with

$$I_{[t_1, t_2]}(\hat{\rho}) = \int_{t_1}^{t_2} \mathcal{L}(\hat{\rho}(t), \partial_t \hat{\rho}(t)) dt.$$

The deviation from hydrodynamic solutions come from current fluctuations. Writing formally $\nabla^{-1} \stackrel{\text{def}}{=} \int_0^x$, the quantity $\nabla^{-1} \frac{\partial \hat{\rho}_k^{(N)}}{\partial t} + \mathcal{J}^k(\hat{\rho})$, represents the fluctuation of

the current J^k . Reversing the relationship between current fluctuation and white noise process leads to

$$dW^l(x, t) \simeq dY_l^{(N)}(x, t) = \sqrt{\frac{\epsilon}{DN}} \sum_{k=1}^n M_{lk}^{-\frac{1}{2}} \left(\nabla^{-1} \frac{\partial \hat{\rho}_k}{\partial t} + \mathcal{J}_k(\hat{\rho}) \right), \quad l = 1, \dots, n-1. \quad (7.6)$$

Then, putting the joint distribution of $\{dW^k(x, t); x \in [0, 1], k = 1, \dots, n-1\}$ in (7.6), we obtain

$$\begin{aligned} \mathcal{L}(\hat{\rho}(t), \partial_t \hat{\rho}(t)) dt &= \frac{1}{2} \int_0^1 dx \sum_{k=1}^{n-1} \left(\frac{dW^k(x, t)}{dx} \right)^2 \\ &= \frac{1}{2D} \int_0^1 dx \sum_{k=1}^{n-1} \sum_{l=1}^n M_{lk}^{-\frac{1}{2}} \left(\nabla^{-1} \frac{\partial \hat{\rho}_k}{\partial t} + \mathcal{J}_k(\hat{\rho}) \right)^2 dt, \end{aligned}$$

where ϵ has been identified with dt and dx with $1/N$. Then, the symmetry of $M^{-\frac{1}{2}}$, the form (7.4) of M^{-1} and the exclusion constraint

$$\sum_{k=0}^n \nabla^{-1} \frac{\partial \hat{\rho}_k}{\partial t} + \mathcal{J}_k(\hat{\rho}) = 0,$$

lead to the final compact form

$$\mathcal{L}(\hat{\rho}, \partial_t \hat{\rho}) = \frac{1}{2D} \int_0^1 dx \sum_{k=1}^n \frac{\left(\nabla^{-1} \frac{\partial \hat{\rho}_k}{\partial t} + \mathcal{J}_k(\hat{\rho}) \right)^2}{\hat{\rho}_k}.$$

7.3.2 Hamilton-Jacobi equation and large deviation functional

Here we proceed as in [3]. Let π_k , the conjugate variable of ρ_k ,

$$\pi_k(x, t) \stackrel{\text{def}}{=} \frac{\partial \mathcal{L}(\hat{\rho}, \partial_t \hat{\rho})}{\partial \partial_t \rho(x, t)}.$$

The Hamiltonian is then given by

$$\mathcal{H}(\{\rho_k, \pi_k\}) \stackrel{\text{def}}{=} \int_0^1 dx \sum_{k=1}^n \pi_k(x, t) \partial_t \rho_k(x, t) - \mathcal{L}.$$

Some algebraic manipulations lead to the expression

$$\mathcal{H}(\{\rho_k, \pi_k\}) = \int_0^1 dx \left[\partial_x \pi_k \mathcal{J}_k(\rho) - \frac{1}{2} D\rho_k \left(\partial_x \pi_k \right)^2 \right].$$

Then the large deviation functional \mathcal{F} , satisfying

$$P(\rho^{(N)} \simeq \rho) \simeq e^{-N\mathcal{F}(\rho)},$$

might be derived, as in [3], from a regular variational principle

$$\mathcal{F}(\rho) = \inf_{\hat{\rho}} I_{[-\infty, 0]}(\hat{\rho}),$$

where the minimum is taken over all trajectories $\hat{\rho}$ connecting the stationary deterministic equilibrium profiles $\bar{\rho}_k$ to ρ . This means that \mathcal{F} and the action functional I must satisfy the related Hamilton-Jacobi equation

$$\mathcal{H}\left(\{\rho_k, \frac{\partial \mathcal{F}}{\partial \rho_k}\}\right) = 0.$$

In addition, one can check the relation

$$\mathcal{F} = \mathcal{S} + \mathcal{U},$$

where

$$\begin{cases} \mathcal{S} = \int_0^1 dx \sum_{k=1}^n \rho_k \log \rho_k, \\ \mathcal{U} = \frac{1}{2} \int_0^1 dx \int_0^x \sum_{k \neq l} \alpha^{kl} \rho_k(x) \rho_l(y) dy, \end{cases}$$

a form already encountered in the reversible case, see equation (5.6). Indeed, when the process is reversible, \mathcal{U} is translation invariant (i.e. independent of the initial integration point, here set to zero), and so

$$\frac{\partial \mathcal{S}}{\partial \rho_k(x)} = \frac{\mathcal{J}_k}{D\rho_k}.$$

We skip the irreversible case, which might be solved along the lines of section 6.

8 Concluding Remarks

In this report we strove to put forward some technics, and to extend methods to tackle the problem of mapping discrete model to continuous equations. In particular we showed a way of obtaining functional equations to handle the hydrodynamic regime. Even in the context of a very specific model, namely stochastic distortions of discrete curves, some open hard questions remain.

- The determination of the invariant measure in the general case, at the discrete level, which would generalize the totally asymmetric case [17, 26].
- The analysis of Hamilton-Jacobi equations to obtain a kind of continuous counterpart of the invariant measures, namely large deviation functionals.

Also the study of the 4-particle case corresponding to figure 6.2 but not reported here, seems to be rich of interesting combinatorial features, which we could not yet interpret.

With regard to hydrodynamic limits, there is a puzzling issue, namely when particle-species diffuse at various speeds, in what we called the *heterodiffusive* case. For many one-dimensional models, it is well known that a single slow particle may considerably modify the macroscopic behavior of the system (see e.g. [25]). Our approach is for the moment restricted to diffusive one-dimensional systems. Nevertheless, other scalings (like Euler), as well as processes in higher dimension, are definitely worth being studied. Following th, it could be interesting to consider more realistic exclusion processes, for instance in the field of traffic modelling. Also the analyses of irreversible invariant states in terms of cycles in the state-graph could be extended for ASEP on closed networks.

References

- [1] P. ARNDT, T. HEINZEL, AND V. RITTENBERG, *Stochastic models on a ring and quadratic algebras. the three-species diffusion problem*, J. Phys. A: Math. Gen., 31 (1998), pp. 833–843.
- [2] C. BERGE, *Théorie des Graphes et ses Applications*, vol. II of Collection Universitaire des Mathématiques, Dunod, 2ème ed., 1967.

-
- [3] L. BERTINI, A. DE SOLE, D. GABRIELLI, G. JONA LASINIO, AND C. LANDIM, *Current fluctuations in stochastic lattice gases*, Phys. Rev. Lett., 94 (2005), p. 030601.
- [4] P. BILLINGSLEY, *Convergence of Probability Measures*, Wiley Series in Probability and Statistics, John Wiley & Sons Inc., second ed., 1999.
- [5] J. BURGERS, *A mathematical model illustrating the theory of turbulences*, Adv. Appl. Mech., 1 (1948), pp. 171–199.
- [6] M. CLINCY, B. DERRIDA, AND M. EVANS, *Phase transition in the ABC model*, Phys. Rev. E, 67 (2003), pp. 6115–6133.
- [7] A. DE MASI AND E. PRESUTTI, *Mathematical Methods for Hydrodynamic Limits*, vol. 1501 of Lecture Notes in Mathematics, Springer-Verlag, 1991.
- [8] B. DERRIDA, C. ENAUD, AND J. LEBOWITZ, *The asymmetric exclusion process and brownian excursions*, J. Stat. Phys., 115 (2004), pp. 365–382.
- [9] B. DERRIDA, M. EVANS, V. HAKIM, AND V. PASQUIER, *Exact solution for 1d asymmetric exclusion model using a matrix formulation*, J. Phys. A: Math. Gen., 26 (1993), pp. 1493–1517.
- [10] B. DERRIDA AND K. MALLICK, *Exact diffusion constant for the one-dimensional partially asymmetric exclusion model*, J. Phys. A: Math. Gen., 30 (1997), pp. 1031–1046.
- [11] S. ETHIER AND T. KURTZ, *Markov Processes, Characterization and Convergence*, John Wiley & Sons, 1986.
- [12] M. EVANS, D. P. FOSTER, C. GODRÈCHE, AND D. MUKAMEL, *Spontaneous symmetry breaking in a one dimensional driven diffusive system*, Phys. Rev. Lett., 74 (1995), pp. 208–211.
- [13] M. EVANS, Y. KAFRI, M. KODUVELY, AND D. MUKAMEL, *Phase Separation and Coarsening in one-Dimensional Driven Diffusive Systems*, Phys. Rev. E., 58 (1998), p. 2764.
- [14] G. FAYOLLE AND C. FURTLERHNER, *Dynamical Windings of Random Walks and Exclusion Models. Part I: Thermodynamic limit in \mathbb{Z}^2* , Journal of Statistical Physics, 114 (2004), pp. 229–260.

-
- [15] ———, *Stochastic deformations of sample paths of random walks and exclusion models*, in Mathematics and computer science. III, Trends Math., Birkhäuser, Basel, 2004, pp. 415–428.
- [16] ———, *Stochastic dynamics of discrete curves and exclusion processes. part 1: Hydrodynamic limit of the ASEP system*, Rapport de Recherche 5793, Inria, 2005.
- [17] P. FERRARI AND J. MARTIN, *Stationary distribution of multi-type totally asymmetric exclusion processes*. math.PR/0501291.
- [18] C. GODRÈCHE AND J. LUCK, *Nonequilibrium dynamics of urns models*, J. Phys. Cond. Matter, 14 (2002), p. 1601.
- [19] O. KALLENBERG, *Foundations of Modern Probability*, Springer, second edition ed., 2001.
- [20] M. KARDAR, G. PARISI, AND Y. ZHANG, *Dynamic scaling of growing interfaces*, Phys. Rev. Lett., 56 (1986), pp. 889–892.
- [21] F. P. KELLY, *Reversibility and stochastic networks*, John Wiley & Sons Ltd., 1979. Wiley Series in Probability and Mathematical Statistics.
- [22] C. KIPNIS AND C. LANDIM, *Scaling limits of Interacting Particles Systems*, Springer-Verlag, 1999.
- [23] R. LAHIRI, M. BARMA, AND S. RAMASWAMY, *Strong phase separation in a model of sedimenting lattices*, Phys. Rev. E, 61 (2000), pp. 1648–1658.
- [24] T. M. LIGGETT, *Stochastic Interacting Systems: Contact, Voter and Exclusion Processes*, vol. 324 of Grundlehren der mathematischen Wissenschaften, Springer, 1999.
- [25] K. MALLICK, *Shocks in the asymmetry exclusion model with an impurity*, J. Phys. A: Math. Gen., 29 (1996), pp. 5375–5386.
- [26] K. MALLICK, S. MALLICK, AND N. RAJEWSKY, *Exact solution of an exclusion process with three classes of particles and vacancies*, J. Phys. A: Math. Gen., 32 (1999), pp. 8399–8410.
- [27] J. MURRAY, *Mathematical Biology*, vol. 19 of Biomathematics, Springer-Verlag, second ed., 1993.

- [28] W. RUDIN, *Functional Analysis*, International Series in Pure and Applied Mathematics, McGraw-Hill, second ed., 1991.
- [29] P. S. private communication.
- [30] H. SPOHN, *Large Scale Dynamics of Interacting Particles*, Springer, 1991.



Unité de recherche INRIA Rocquencourt
Domaine de Voluceau - Rocquencourt - BP 105 - 78153 Le Chesnay Cedex (France)

Unité de recherche INRIA Futurs : Parc Club Orsay Université - ZAC des Vignes
4, rue Jacques Monod - 91893 ORSAY Cedex (France)

Unité de recherche INRIA Lorraine : LORIA, Technopôle de Nancy-Brabois - Campus scientifique
615, rue du Jardin Botanique - BP 101 - 54602 Villers-lès-Nancy Cedex (France)

Unité de recherche INRIA Rennes : IRISA, Campus universitaire de Beaulieu - 35042 Rennes Cedex (France)

Unité de recherche INRIA Rhône-Alpes : 655, avenue de l'Europe - 38334 Montbonnot Saint-Ismier (France)

Unité de recherche INRIA Sophia Antipolis : 2004, route des Lucioles - BP 93 - 06902 Sophia Antipolis Cedex (France)

Éditeur
INRIA - Domaine de Voluceau - Rocquencourt, BP 105 - 78153 Le Chesnay Cedex (France)
<http://www.inria.fr>
ISSN 0249-6399