



HAL
open science

PROTEUS – Creating Distributed Maintenance Systems through an Integration Platform

Thomas Bangemann, Xavier Rebeuf, Denis Reboul, Andreas Schulze, Jacek Szymanski, Jean-Pierre Thomesse, Mario Thron, Nouredine Zerhouni

► **To cite this version:**

Thomas Bangemann, Xavier Rebeuf, Denis Reboul, Andreas Schulze, Jacek Szymanski, et al.. PROTEUS – Creating Distributed Maintenance Systems through an Integration Platform. Computers in Industry, 2006. inria-00000827

HAL Id: inria-00000827

<https://inria.hal.science/inria-00000827>

Submitted on 11 Oct 2006

HAL is a multi-disciplinary open access archive for the deposit and dissemination of scientific research documents, whether they are published or not. The documents may come from teaching and research institutions in France or abroad, or from public or private research centers.

L'archive ouverte pluridisciplinaire **HAL**, est destinée au dépôt et à la diffusion de documents scientifiques de niveau recherche, publiés ou non, émanant des établissements d'enseignement et de recherche français ou étrangers, des laboratoires publics ou privés.

PROTEUS – Creating Distributed Maintenance Systems through an Integration Platform

Thomas Bangemann¹, Xavier Rebeuf², Denis Reboul³, Andreas Schulze⁶, Jacek Szymanski⁴,
Jean-Pierre Thomesse², Mario Thron¹, Noureddine Zerhouni⁵

¹ ifak, Steinfeldstr. 3, D-39179 Barleben, Germany, ([thomas.bangemann, mario.thron@ifak-md.de](mailto:thomas.bangemann,mario.thron@ifak-md.de))

³ CEGELEC, 72 Avenue de la Liberté, F-92739 Nanterre, France, denis.reboul@cegelec.com

⁴ CEGELEC, 72 Avenue de la Liberté, F-92739 Nanterre, France, jacek.szymanski@transport.alstom.com

² LORIA, Nancy Université, 2 av de la forêt de Haye F-54516 Vandoeuvre-lès-Nancy, France, (Xavier.Rebeuf, Jean-Pierre.Thomesse)[@ensem.inpl-nancy.fr](mailto:ensem.inpl-nancy.fr)

⁵ LAB LIFC, LAB 25 rue Alain Savary, F-25000 Besançon France, zerhouni@ens2m.fr

⁶ CEGELEC AT GmbH & Co. KG, Goldsteinst. 238, D-60528 Frankfurt/M., Germany, andreas.schulze@cegelec.com

Abstract

This paper is based on the results from the project PROTEUS sponsored by the French Ministry of Economy, Finance and Industry and the Federal Ministry of Education and Research of Germany under the label of European Commission Initiative ITEA. It presents the architecture and the basic concepts of an integration platform, which constitutes the framework of systems implementing the tasks dedicated to remote maintenance, as well as other applications, for large and medium scale industrial installation. The approach illustrated here is useful for executing any maintenance strategy by implementing the relevant means for controlling workflow between several system components as well as the component's integration itself. The paper first points out the need for designing such a maintenance-oriented platform, continues with a requirements analysis to a global maintenance system followed by the description of the fundamentals of a maintenance application integration system. Finally a sample implementation of a maintenance scenario is given.

Keywords: Application integration, e-maintenance, remote maintenance, concurrent engineering, service integration, Web service, workflow management.

1. Introduction

Any industrial enterprise represents a lot of activities, from marketing, design of the products, and manufacturing, to commercial service, management and financing. These activities have been studied for a long time with one main global objective, their optimization. This, of course, would be followed by an increase in profits. The other advantages resulting from this optimization include: better quality of production, greater output, better training of operators, innovation of a product, better commercial service, financially optimal investments, and so on. This is the main reason why, for a number of decades, each activity and service of an enterprise was the object of modeling and formalization, and, according to the variety of activities, the number of models and of modeling techniques proved to be great. But after having optimized the different services of an enterprise, essentially thanks to information technology and the different theories of automatic control and optimization, it appeared that global optimization needed other approaches, other theories and other tools. The key words then became “integration”, “computer integrated manufacturing”, “openness and open systems”, “interoperability”. Some technologies have seriously contributed to this approach. Firstly, the networking capabilities with the MAP project [1] early in the 1980s, and then with fieldbuses [2], The decreasing cost of electronics and the increasing number of controllers, computers, and PLCs in all the machines, in all the equipment, in all the activities have also made their contribution.

But this is not enough. Technology provides certain capabilities, but to reach the objective of global optimization there needs to be more than technology. Models are needed, and in this field, the complexity of the concerned systems (an enterprise) and the heterogeneity of the existing models make this modeling difficult. The original idea of the PROTEUS project dedicated to industrial maintenance lies in the integration of all the necessary tools whose functions range from the detection of alarms to the management of spare parts, with the purpose of optimizing costs and improving productivity. This optimization can be seen as the extension of the automatic control principles throughout the entire enterprise, in particular the “closed loop” concept applied to the production process.

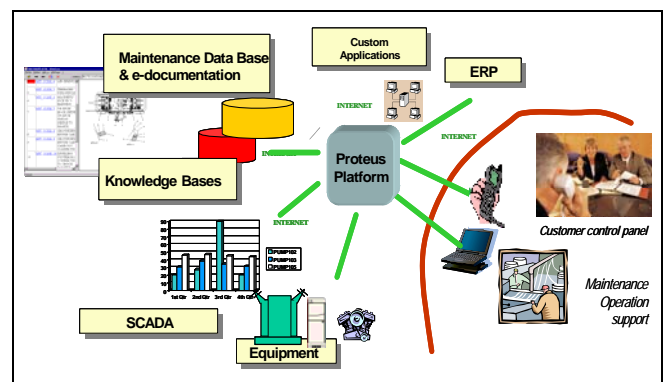

Figure 1. Overall maintenance components

Indeed, maintenance is a very important activity for all industrial enterprises, for improving product quality, production output, and customer satisfaction. Maintenance covers all domains of an enterprise, from the plant and the equipment to be maintained, to the organization according to different strategies (preventive maintenance, predictive maintenance, corrective maintenance), to managing operators and material (handling, hoisting) and spare parts, to the computer aided diagnostic systems, to documentation management and so on.

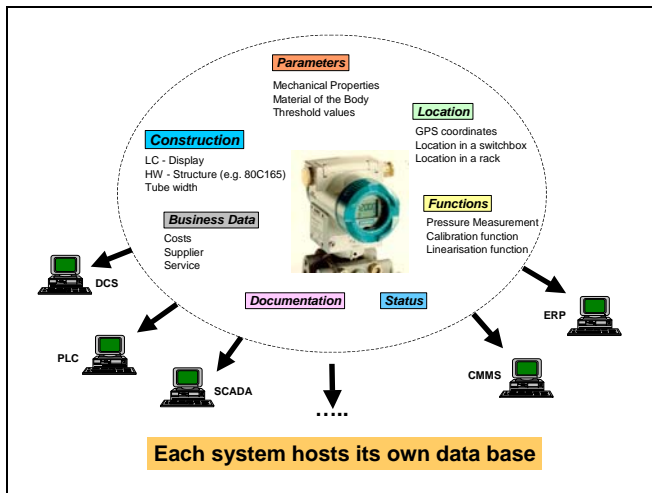

Figure 2. Enterprise hosting maintenance related data[3]

Maintenance is then an activity which needs the integration of several sub-systems associated with the different previous functions involved in maintenance operations. All these software sub-systems are currently based on different models; they are normally complementary, but sometimes redundant, sometimes incoherent and always heterogeneous.

The objective of PROTEUS is then the integration of these various sub-systems thanks to a unique and coherent description of the equipment (through an ontology description), a generic architecture (based on the “Web Services” technology) and coherent models of heterogeneous components. Modeling approaches like UML [4] [5], PERA [6], GRAI [7] must be exploited to manage the diversity of the problems and tasks envisaged.

It is then possible to access all the documentation in a unified way, independently of its origin, equipment manufacturer, integrator, or end-user. Any operator or manager (obviously with the proper access rights) also has the capability to remotely access relevant data from the SCADA or the DCS controlling the plant, to request a diagnosis from a remote intelligent system, and then to prepare any intervention with optimality.

Such a platform may be adapted to any production tool, in any domain (energy produced in a nuclear power plant or by windmill, discrete part manufacturing companies, transport systems and so on.). It allows any maintenance strategy, allows the outsourcing of maintenance to dedicated and specialized companies, and the optimization of the different tasks or operations for the benefits of the different actors.

Before describing the platform, its structure, and the modeling techniques used, this paper introduces in section 2, the end-user expectations for a global integrated

maintenance. The components of the platform are described in section 3. Section 4 presents the platform integration concept. In section 5 some modeling considerations related to the platform (How to define the workflows of the maintenance operations? Which are the business logics?) are discussed. Section 6 is dedicated to the unified external access to the platform components through a Web portal.

2. User expectations from future maintenance platforms

The power of having information when you need it facilitates sound asset management decisions that add value to the top line, trim expenses, and reduce waste. The contribution to the bottom line is significant, making the development of an asset information management network a sound investment. The resulting network that integrates and synchronizes the various maintenance and reliability applications to gather and deliver asset information where it is needed, when it is needed is called e-maintenance, which is a subset of e-manufacturing, and e-business.

Industry has a growing set of smart industrial devices with embedded intelligence. Just like humans, they need online services (i.e., for condition monitoring, remote diagnostics, maintenance, etc.) It is the goal of e-maintenance to answer this need.

On the other hand, maintenance operations have ceased to be a “necessary evil” and are currently considered as a part of a global EAO (Enterprise Asset Optimization) policy [8][9] implemented by a growing number of industrial organizations. Maintenance strategies can be classified in the diagram below, which shows the different levels of the maturity of practice.

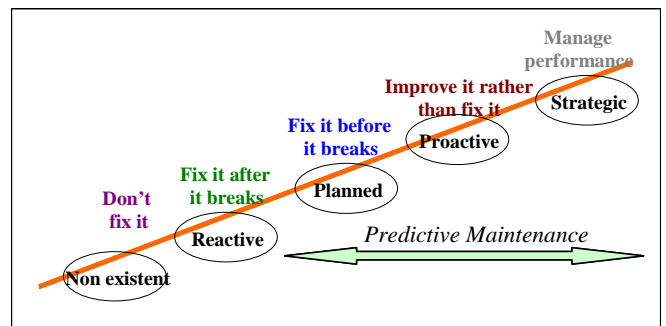

Figure 3. Levels of maintenance maturities

Despite the linear scale of growth presented on the diagram above there is a qualitative gap between the first two low-level strategies and three higher-level. The effort to go towards a more advanced methodology is significant and can only be efficiently implemented if enabling tools and practices are available.[10]

The general objective is to provide a fully integrated platform, which would implement the three following functions:

Continuous assessment of the state of the Equipment:

which consists in continuous remote monitoring of the system by the mean of a set of selected measurement & events, observed through their evolution.

Maintenance and Repair Operation process management:

this process groups logistic actions aimed at improving the efficiency of field operations by means of remote access to technical documentation and knowledge stores for maintenance agents, on-line usage of modeling packages, decision help tools and human experts.

Comprehensive data presentation and synthesis:

which involve direct information delivery to actors of both tactical and strategic operations (including supervisory and decision level, asset management panel and maintenance contract management).

With its collaborative platform based on the web services, PROTEUS allows for the remote access to the dedicated tools answering to all these controls, and, with the central platform components, the PROTEUS platform ensures the link between the equipment assembly or sub-assembly and the relevant maintenance support to maintain the equipment in operational condition.

The design of the PROTEUS platform was driven by different sources of inspiration. On the one hand the strategic progress in the domain of maintenance management (see figure 3) lead to more powerful tool support for efficient maintenance strategies.

A consequence of the never-ending cycle of capabilities bearing requests for new advancements was the upcoming request for sharing existing databases and the exchange of information between several tools.

On the other hand current developments in the business and office area, targeted toward providing more powerful services and convenience, lead to the idea of applying those technologies to industrial applications. This brought up the idea of extensive use of Internet technologies for remote access to maintenance data using standard browser technologies (this in fact is state of the art).

User expectations can be divided into two main groups – those targeted toward the overall maintenance system and those dedicated to individual tools (CMMS, data acquisition, ERP, e-documentation, knowledge management, Web-portal) needed to execute complex maintenance tasks. The following citation gives the requirements for the overall platform:

- The platform shall encapsulate different sources of information to hide the distribution from the user.
- Access to the platform shall be possible using different types of client applications (access through browser computers or mobile terminals as well as from dedicated maintenance application programs).
- Integration of tools already used within the plant shall be possible.
- The monitoring of the maintained equipment shall be adaptable to the individual users needs.
- The platform shall provide a unified representation of data independent of the data source.
- The construction of the platform shall be scalable to support adaptation to systems of different complexities.
- Technologies used to build the platform shall be based on standards or quasi-standards widely used,

open source components shall be used where applicable.

- The platform shall be open to technical improvements regarding tools to be integrated or technologies applied (adaptability, extendibility).
- The platform shall be based on web-technologies.
- Care has to be taken regarding security aspects.

An e-Maintenance platform has to be designed to fulfill today's requirements coming from maintenance techniques as defined for the third generation.

Moreover it has to provide the enabling means for fourth generation maintenance techniques [11].

3. The maintenance platform architecture

The architecture of a system as described above is illustrated in figure 4, whereas PROTEUS is mainly focused on the infrastructure for integration rather than on the development of dedicated tools.

Considering the market situation diverse solutions are available for all the components arranged around the central operational core generating a great range of application. Exemplary ICAS - Integrated Condition Assessment System shall be mentioned.

The Integrated Condition Assessment System (ICAS) [12] is a software developed by the NAVSEA Philadelphia Division [13] which works on Navy Condition Based Maintenance. Specialised on Hull Mechanical and Electrical Systems aboard, the ICAS software has been used on more than 50 United States Navy Surface Combatant ships. Its two main functions are to record real-time operational data so that relevant information becomes available for further processing when needed and to match real-time vital parameters against known patterns so as to inform the user of any possible degradation or unexpected behaviour. An instantiation of the generic PROTEUS platform to ship maintenance should be able to use this tool for both data acquisition and data analysis.

Also certain effort has been taken to realize data exchange between individual tools, which in most cases is limited to the point-to-point connection between individual tools following bilateral agreement for exchange formats. Initiatives like MIMOSA [14] have been established to unify data elements to be exchanged for special equipment like Condition Monitoring Tools or dedicated assets.

MIMOSA has specified a CRIS (Common relational information system) which is a relational database model of maintenance information. They have also designed interfaces for common requests on stored data and they have specified their own specific servers to exchange information. From its beginning, the PROTEUS project has been thought to work with and through web services. In PROTEUS, the following approach was chosen: the maintenance processes have been identified and suitable interfaces have been designed so that it is possible to design particular maintenance processes. The PROTEUS solution allows to model the whole

maintenance cycle from preventive maintenance to prognosis, with resource reservations, real-time data monitoring, e-documentation, etc. It offers a coherent and homogeneous portal to any information or process related to maintenance.

MIMOSA and PROTEUS can be seen as complementary solutions in that MIMOSA focuses more on how to model and store information related to maintenance and PROTEUS focuses more on providing services that, when composed, yield dynamic maintenance processes.

For the exchange of plant management data, powerful integration platforms, so called Enterprise Application Integration tools (like Biz Talk [15], TIB/Active Enterprise, e*Exchange, MQSeries Integrator, ETI EXTRACT, JARDiX Integration Suite, SCORE Integration Suite, eBusiness Integration) have been designed to overcome the evil of diverse bilateral interface adaptation solutions. Those solutions are cost intensive and mainly dedicated to B2B applications.

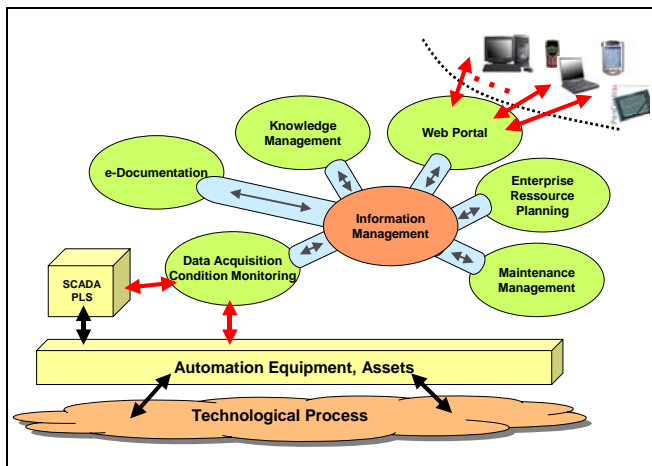

Figure 4. General maintenance platform components

The concept presented here follows the idea of application integration within the context of maintenance - Maintenance Application Integration (MAI). It considers all these components delivering data useful for maintenance tasks:

WEB Portal

The Web Portal can be seen as the universal user interface to access all maintenance management related information. It is responsible for providing data to different types of client applications.

Enterprise Resource Planning (ERP)

ERP tools, like SAP/R3, are not primarily dedicated to be used for maintenance management. Two aspects have to be considered. Firstly, ERP systems are elementary parts of enterprise management and are able to deliver information regarding assets, personal, etc. Secondly, today's ERP systems may already contain modules for maintenance management.

Maintenance Management Systems (CMMS)

CMMS's are classically used to plan and control maintenance tasks.

Knowledge management

Knowledge management methods are used to support diagnosis processes as well as decision-making.

e-Documentation Server

An e-documentation server can be used for managing access to any kind of documentation used to describe assets or to support repair, inspection and servicing.

Data Acquisition Server

The availability of online data (status information) is the precondition for the application of condition-based maintenance strategies. A Data Acquisition Server (DAS) shall be considered as a means to deliver any kind of such data.

Platform core

Several basic functions are needed to manage the cooperative operation of all the tools considered to be elementary part of the e-Maintenance platform. This mainly considers communication mechanisms, access right management, event distribution/notification, registration, scheduling of operations, work flow management.

It also defines means to instantiate Business Logic Objects (BLO's). Business logic objects are used to control workflow as well as to transform data into or from a common exchange format used for communication within the PROTEUS platform. The consequent use of BLO's opens the way to real distributed design and execution of maintenance tasks while improving or even replacing centralized maintenance management through distributed components. The PROTEUS platform can be seen as the distributed runtime environment for maintenance management applications.

The principal objective of the PROTEUS platform is to provide the means for moving from co-existence to the interoperability and co-operation of these applications within the same environment. The interoperability should provide the condition for orchestration of components in order to provide a global integrated service for the platform user(s). The integration is necessarily done by the exchange of data between the components. This fact shows that the platform faces three principal structural constraints:

- Need for interoperability and co-operation of applications having a vast diversity of execution models: real-time for SCADA, transactional data access for documentation and ERP, interactive (dialog based) execution for decision support tools
- Evident need for data exchange between remote sites since the applications are rarely present on the same site
- Diversity of applications implies diversity of data formats and data volumes produced by them.

The concept of integration of services provides the service user with the comfort of having a total abstraction of service implementation. User action is limited to the service invocation via a publicly available interface. The system, which implements the whole framework, takes charge of the identification of necessary components and the appropriate method of communication between them. The communication method would consist in a choice of

elementary services and their interfaces as well as the scheduling of service invocation and data exchange. It becomes evident that the main issues of the integration platform construction are:

- Remote access to any component application, despite its position with respect to the requester; this implies the use of a global networking facility such as Internet
- Efficiency of data transmission linked with the possibility of an exchange of heterogeneous data formats
- Distributed execution of component applications and independence of the type of machine hosting an application
- Possibility of dynamic discovery of services, addresses and interfaces
- Possibility of programming service chaining mechanisms

4. Platform integration concept

The basic idea of the PROTEUS platform consists in using the existing maintenance applications (tools) in order to provide integrated maintenance services. Integration is based on the co-operative and orchestrated execution of distributed processes running on heterogeneous hardware/software platforms and communicating via Web Services.

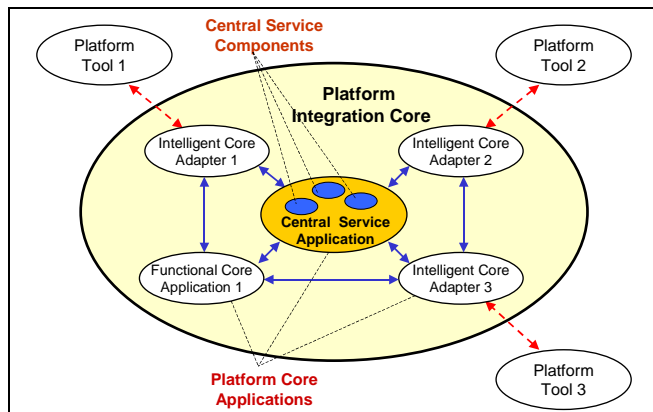

Figure 5. Platform architecture

The figure above presents the top-level view of the architecture of the PROTEUS Platform. This star-like architectural pattern features three classes of elements, which are oriented towards diversified functions:

1. Central Service Application (CSA) provide integration oriented services
2. Intelligent Core Adapters (ICA) provide standardized interface transformers for the peripheral applications (platform tools)
3. Functional Core Applications (FCA) implement supplementary functions needed by the global service requirements and not provided by the platform tools

The structure presented in the figure above implements the idea of integration via standardized interface wrappers and is entirely dictated by the requirement of flexibility in the choice of the platform tools.

The architecture is optimized for fast information exchange. The CSA is used for communication establishment between

communication partners and fast look-up of distributed information. ICAs and FCAs exchange data directly using the client-server pattern.

The Role of Central Service Applications

Integration relies on a pool of central components, which allow applications to register themselves, discover other applications and forward necessary descriptions of their interfaces to them.

The pool of these components, called Central Service Application (CSA) is the heart of the PROTEUS platform. It represents a variety of component types.

The key feature of the PROTEUS platform is the distribution over a local or global network. Following this principle the set of CSA components can be conveniently distributed over many execution supports for the overall robustness and reliability of the system. The roles of the key CSA components are briefly discussed below:

UDDI server

The existence of this component in the PROTEUS platform allows for the dynamic discovery of the services offered by the integrated applications.

Work Flow management tool

This is one of the key components providing the co-operation possibility among the different platform tools via synchronization and orchestration of their operations.

Security Manager

The openness of the communication media exposes the platform to external intrusions. Therefore security mechanisms and management applications become necessary for the platform. The data flow is protected by strong encryption. The CAAS centrally manages authentication certificates and user roles, which are the base for secure authentication and authorization within the Internet-based PROTEUS Platform.

Application Data Repository

The Application Data Repository is structured according to the description of the conceptual structure of the managed system and provides an interface for access to data items stored within the integrated tools. The implementation of Application Data Repository is of the great importance since it is the key to high system performance. The PROTEUS specific addressing of objects enables a link-mechanism in a Web-based system, which is comparable with the indexing mechanism in a relational database system. It has the same effect as a dramatically reduced information access time compared to the systematic search approach.

Central Event Distribution

In order to provide integrated services, a complementary method of co-operation between distinct applications is implemented by a mechanism of notification via events on the “subscriber – producer” principle. The task of event subscription and distribution is global and is implemented by the Central Event Distribution System.

The Role of Intelligent Core Adapter (ICA)

The Central Service Applications described above are in charge of implementation and support of service exchange mechanisms, whose role is to enable the interactions between integrated tools. The interactions should follow a regular pattern of data and control flow, which is to be implemented by a collection of dedicated elements of the architecture called Intelligent Core Adapters (ICA).

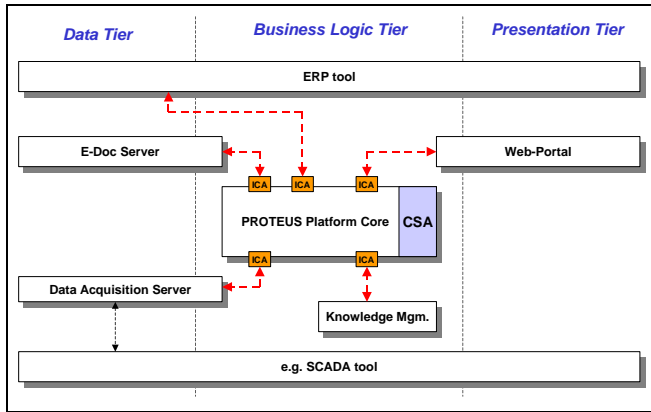

Figure 6. PROTEUS platform interface constellation

The figure above presents the view of the PROTEUS platform in terms of a three-tiered design pattern. Some of the peripheral applications, i.e. the ERP tool or a SCADA application, provide all three tiers by themselves, while other applications might possibly not. The data tier parts of these applications are especially used for integration purposes within the PROTEUS platform. The data tier is the source and the final destination of what can be considered as raw data relative to the primary system function (industrial process data, parameters of field equipment, process management data, spare part stock status, available personnel and others).

The Business Logic Tier is in charge of value added data processing, reduction and transformation. The raw data from the data tier is processed according to the rules of business logic such as algorithms for process monitoring and control, synthetic financial indicators, reporting rules.

The Presentation Tier contributes to the necessary chores of information formatting so that it is easily exploitable by human users.

Figure 6 brings into evidence the fact that some architectural elements are placed within one tier and some span over two or three tiers. This fact complicates the task of system integration, which aims at the harmonious cooperation of the application within the criterion of the creation of maximal synergy. With this in mind, we see that the architecture is actually re-engineered and the star-like pattern previously proposed is introduced. The Intelligent Core Adapters, which employ the initially proposed three-tier pattern on the basis of inter-application communication normalization, play a crucial role in this pattern.

The two principal requirements imposed on ICA operation are:

1. Adaptation of the peripheral tool interface to a PROTEUS conformant interface exposed to other applications,

2. Normalization of the communication protocol used by the tool in order to obtain the same protocols within the whole PROTEUS system.

Both of these requirements aim at normalization and adaptation of the different domains of the data tier.

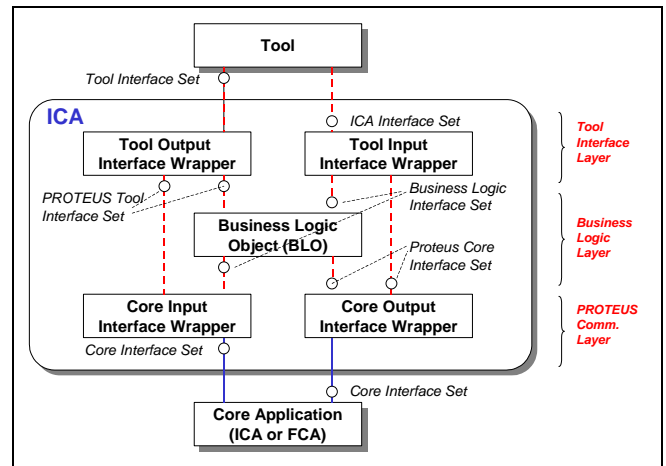

Figure 7. Intelligent Core Adapter (ICA)

The figure above shows the internal architecture of an ICA. The peripheral tools provide a set of interfaces called Tool Interface Set. These interfaces are bound to a specific communication mechanism and a specific semantic of the methods offered by the tool.

The Tool Output Interface Wrapper converts the method semantics and communication details of the Tool Interface Set into a set of methods usable by other core applications and Business Logic Objects (BLOs) residing within the ICA. This resulting interface set is called PROTEUS Tool Interface Set.

The tools use the Tool Input Interface Wrapper to access the adapter internal BLOs and indirectly other platform applications.

Each ICA contains one or several Core Input Interface Wrappers. These wrappers map the PROTEUS Tool Interface Set as well as the BLO Interface Sets to the PROTEUS communication layer (SOAP).

The components that give the active behavior to the ICA are its BLOs.

These applications, called in the previous section Functional Core Applications (FCAs), provide some global operations to the system, like workflow implementation, some generic computations on data, etc. It is also worth noting that these applications operate on the basis of the same design pattern as the ICAs. The difference is that these components have no tool interface wrapper layer.

A sample component integration

Well-defined, uniform parameters with a specific choice of data types enable manufacturers to implement software along the data flow from the field device to the various users quickly and with no deviation. The parameters selected are dependent on the business logic and consumed by multiple applications. With regards to the PROTEUS project this business logic is targeted toward global maintenance.

Field devices as well as the other applications are software, which is programmed in typical application domain language, e.g. PLC with IEC 61131-3 languages, PC-tools

in C++ or Java. Additionally, there are automation specific components, which provide specific interfaces with their own data types, e.g. OPC. There is a vertical data flow up to the MES components, which need parameter conversion in the appropriate data types like the XML ones. The digital communication systems require a transmission of parameters with defined data types between all these components. Unfortunately the sets of data types for all these components are not exactly the same.

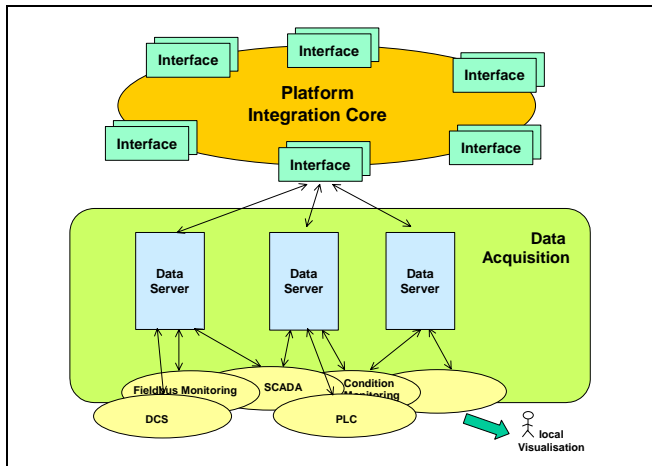

Figure 8. Data Acquisition Server integration

For the handling of data within the overall PROTEUS platform data must be transformed into a common understandable format. Types and semantics as well as the arrangement of data must be described. Consequently, PROTEUS concerns the definition of data, data lists, data groups or objects known and to be used within the global PROTEUS platform (data model).

Then, the platform integration concept is applied adapting data acquisition components like SCADA, DCS or field devices to the PROTEUS platform. This adaptation is done through a Data Acquisition Server (DAS).

A Data Acquisition Server may be seen as an instance of an Intelligent Core Adapter exploiting all the different types of interfaces as well as Business Logic Objects (BLOs). As defined within the data model each object has a certain number of attributes representing real device parameters (like process value, measurement range, limits, configuration parameters, etc.).

Private methods are used to call interface functions to access data from the devices and to map this data to the object attributes. Update strategies are defined to provide data with the right quality at the right time. Private methods may also be used for data manipulation like filtering or pre-processing.

Public methods are called by the web services to access the attributes from other platform tools.

Following this approach it is possible to adapt any type of automation equipment to the PROTEUS platform. The mapping of parameters to a unified data model eases the availability of online data to different maintenance application components independent of their location.

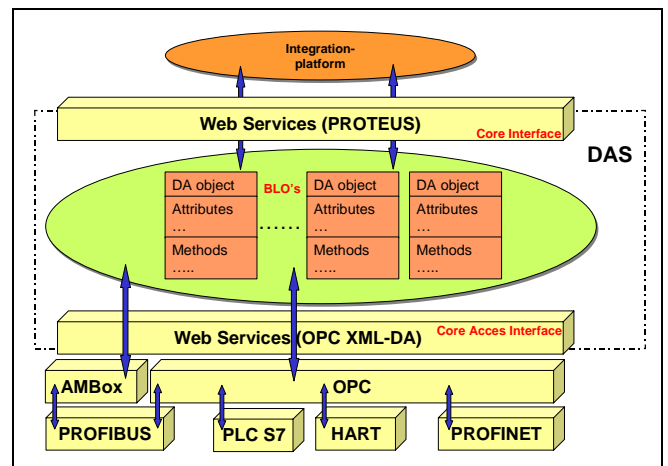

Figure 9. Data acquisition server mapped to ICA architecture (simplified)

5. Design and implementation of maintenance workflow

The implementation of workflows within the PROTEUS platform will be illustrated in the following by using a sample workflow.

Certain equipment of an installation is monitored online to retrieve status information as a basis for condition-based maintenance. In the case where a problem is detected, a message is sent to the CMMS, a trouble ticket is created and notification is sent to the operator. The operator may retrieve additional information from the Data Acquisition Server, as needed, before requesting support from the expert system. The expert system tries to find a correction and to quantify the risk linked with the appearing problem. Therefore, the knowledge database is needed to give it a description of the problem. Finally, it gets sensor values from the data acquisition server. If the evaluated risk is higher than a given bound, then the operator has to stop the process and repair. In this case it requires the e-doc server to have instructions for reparation or documentation regarding equipment characteristics. Otherwise, an intervention will be planned by the CMMS tool.

Several components of the maintenance platform are involved in the sample workflow in order to demonstrate the flow of information.

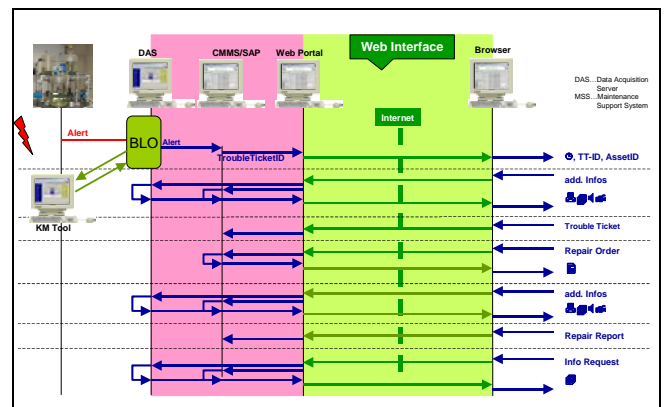

Figure 10. Work flow scenario

The involved components are the Web-portal, the knowledge management tool, the Data Acquisition Server, the e-Documentation server and the CMMS.

The scenario is composed of several actions of the actors involved and the control of information flow. The flow of information associated to business logic rules is managed by Business Logic Objects (BLOs). They are part of the Intelligent Core Adapters (ICAs) and Functional Core Applications (FCAs). Stateful and stateless BLOs are distinguished. A special case of a stateful BLO is a Workflow BLO. The following figure shows a sample constellation of how the Workflow BLO interacts with other platform components.

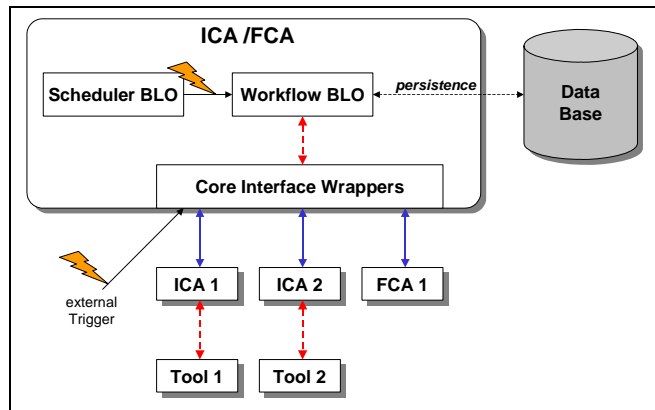

Figure 11. BLO interactions

The Intelligent Core Adapters have a persistence layer. This layer is responsible for storing the internal state of adapters. There are two possibilities for implementing this persistence layer:

- Persistency is provided by the adapter runtime environment (e.g. Microsoft BizTalk server, J2EE server).
- Persistency is managed by the adapter source code by saving the adapter state into a file or a data base. Here is no need for a complex and expensive runtime environment like in the first solution but the amount of manual work for programming and testing increases dramatically.

The workflow is triggered by either an internal trigger like a scheduled event or by an external trigger. The Workflow BLO orchestrates different tools (via their ICAs) and FCAs once the workflow is started.

The workflow will be organized by finite or infinite state machines running in the Workflow BLO. A batch will be considered as special finite state machine without internal loops. The actual state of the state machine will be persistent (stored in a data base).

There are two main workflow types using the BLOs:

- Transactional workflows
- Interruptible workflows

The following figure maps the example given above to a sequence of a transactional between ICA's:

A trigger (detection of the problem) initiates the start of the state machine. This start is marked at the persistence system. Several interactions with the external ICA's (and optionally with FCA's) follow while the state machine steps from state to state. Finally all information related to

this run of the state machine is deleted from the persistence store.

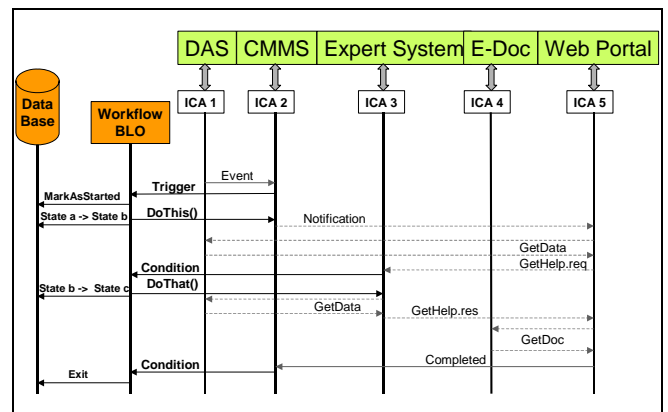

Figure 12. Work flow implementation

In the case of a transactional workflow, the state machine will run from its initial state after system restart if the system crashes at the point where the Workflow BLO is running.

Every state change and the relevant meta-results are persistently stored in case of an interruptible workflow. This makes it possible to restart directly from the state which was active before a system crash.

The main workflow types shown may be complemented by additional rules like time-outs in case the persistence store additionally saves time stamps of each action and state change.

6. Global platform access and communication

Each maintenance actor gains access to the generic maintenance platform through a common web portal. This web portal, which is a web site, is a gateway to any maintenance resource or activity.

The web portal is a key point for the success of deploying the platform. It has to be simple, well designed and well understood by its day-to-day users. More importantly, and more difficult to achieve, it has to assist the human actors without burdening them with tedious scenarios or cryptic forms to fill in.

The main functionality of the web portal is to enable a user to retrieve the data he needs to complete his current tasks. It also has to allow the user to enter new information and to ensure that they are stored and dispatched to the relevant PROTEUS services. It also has to allow the exchange of any kind of data relevant to maintenance. This can be dynamically computed data (like the current schedule of an operator) or static data (like a video showing how to complete a given repair).

The proposed web portal allows maintenance actors to use any kind of internet-able devices from anywhere.

A common interface (start page) provides navigation to loosely integrated features. Existing heterogeneous hardware and software have to be integrated into the PROTEUS platform as homogeneously as possible. The main challenge here is to define an interface for each category of tool: SCADA, CMMS, ERP, etc. Each interface will offer a coherent, simple and uniform view of the maintenance related core features ordered by its category.

Each maintenance actor needs to be able to connect itself to the PROTEUS platform through a Web browser on any kind of client terminal. The client terminal can be a traditional PC, a PDA, a mobile phone or any other type of client, on which it is possible to connect to the Internet. Then, through this Web portal, maintenance actors have to retrieve data in many formats. It can be in the form of text documents, dynamic information compiled by a SCADA system, an ERP or a CMMS system. Furthermore, it can also be real-time data, like video streams coming from a Video-on-Demand (VoD) server.

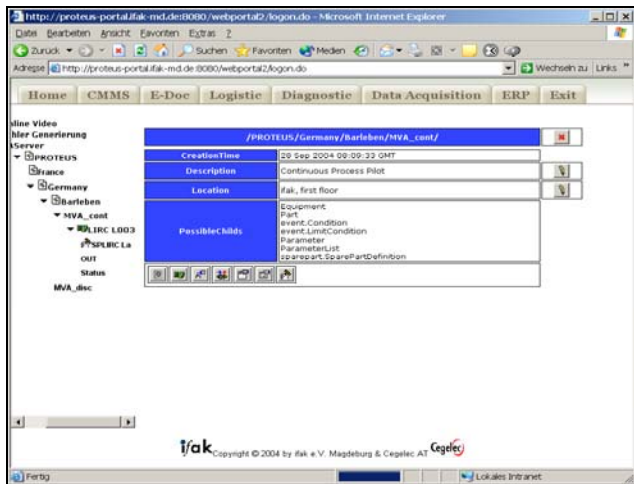

Figure 13. Access through the PROTEUS Web portal

As we also have to deal with light clients, i.e. a user who logs onto the PROTEUS platform using only a standard browser, we will use only the relevant client-side technologies, among which: HTML, DOM, and EcmaScript. The Portal can obviously use any server-side tools because the specificity of these solutions is that the client only receives computed HTML (among which JSP, servlets, etc.).

All Proteus Core platform Web-service clients will be available on the Proteus Web portal. When a user connected to the Proteus Web portal asks for a document or other kind of information, the Proteus Web portal will invoke the corresponding Web-service available on the Proteus Core Platform or WP server. Nevertheless, the first step for each connection will be to find, on the Proteus Core platform, if the service required is available for the user who is invoking it. Data exchanged with the Proteus Core platform may be string or other simple types (Integers, Boolean, strings, and XSD structures). But it can also be documents or pictures. Data will be exchanged via SOAP/HTTP, but it will also be possible to use SOAP/HTTPS, according to the requirements of the company in which this Proteus platform is implemented.

Data exchanged with other platform tools are documents, pictures, real-time data, and other simple XSD types. Indeed, the Proteus Web portal will invoke the tool's Web-services required by the users connected to it via SOAP/HTTP or SOAP/HTTPS. Then the information and documents will have to be transformed by the Proteus Web portal in order to be adapted to the Web browser used by the client terminal (translation in HTML or WML pages, pictures and documents resizing, and so on).

7. Current platform exploitation

At the completion of the PROTEUS project, three different pilots were established to demonstrate the success of the concepts developed:

- a pilot for maintenance of continuous processes (see figure below),
- a second pilot for maintenance of mechanical workshops and
- the third pilot for maintenance in railway applications.

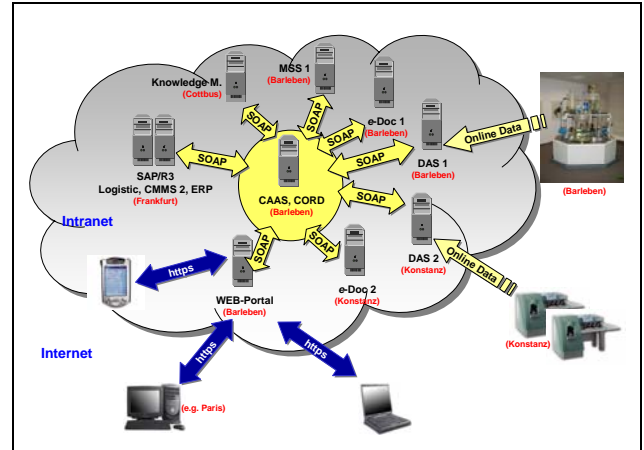

Figure 14. Platform pilot (for continuous process)

The platform was installed and is currently being used in Cegelec-Belfort to help with maintenance actions on its BAPS system for the fully automated production of alternator blades. This platform is also used to manage the legal security aspect of the overhead traveling cranes installed in this area, linked contractually with Cegelec France.

Another platform is under construction to manage the maintenance of escalators for a large manufacturer.

Based on the PROTEUS results, Cegelec Germany developed a support tool for maintenance services which have already been introduced to customers. It is marketed as the Cegelec "Web Service Management" approach.

ifak further developed core components of the PROTEUS platform and now offers support for introducing such components into industrial IT environments to integrate and centrally access different automation and management systems. Special attention is drawn to condition-based and predictive maintenance as well as to workflow management.

Finally, several projects are under study for adapting this platform to water treatment plants and ship maintenance.

8. Conclusion

In today's landscape of maintenance support tools, few truly integrated systems exist. However, the enabling technologies for building a global platform are there, on the market, or within the capabilities of integrators. The major technological trends currently observed promote the use of Internet communication technology and distributed object-oriented processing environments to provide the necessary integration of previously isolated sub-systems. The PROTEUS project takes its inspiration from these trends in order to promote progress and innovation in the domain of integrated maintenance systems.

The basic integration technology as defined for the PROTEUS platform allows for the exploitation of Web services to access different systems, among them we find those from the MES level or condition monitoring equipment. Each adapter used to interface an individual tool provides an object-related view of the relevant data of this tool. So PROTEUS adapter objects can be modeled based on the definitions of IEC 62264 [18] or ISO 13374 [16], [17].

The system presented in this article is an example of vertical integration of applications in the domain of remote maintenance of industrial installations. Our objective while designing it was to conciliate three requirements: heterogeneity, extensibility and coherence. The conciliation of these requirements is possible thanks to the extensive use of Web Service technology and especially a sort of service choreography through workflow programming.

From our initial experience we conclude that the PROTEUS integration platform is now able to provide satisfactory solutions to its users who are maintenance operators, asset owners and industrial system providers.

9. References

- [1] INI (1987). *The MAP Book: An introduction to Industrial Networking*. Industrial Networking Incorporated, 3990 Freedom Circle, Santa Clara, CA 95052 8030.
- [2] Thomesse J.-P., *Fieldbus technology in industrial automation*. Proceedings of IEEE, Vol 93, N°6, June 2005, pp 1073-1101.
Annual reviews in Control 22, 1998, pp 35-45.
- [3] Bangemann, Th.; Thomesse, J.-P.; Lepeuple, B.; Diedrich, Ch.: PROTEUS-providing a concept for integrating online data into global maintenance strategies. INDIN'04, IEEE, 24.-26.06.2004, Berlin. Conference proceedings CD reprint.
- [4] Booch, G., Rumbaugh, J., Jacobson, I., *The Unified Modeling Language User Guide*, Addison-Wesley Longman, 1999.
- [5] Rumbaugh, J., Jacobson, I., Booch, G., *Unified Modeling Language Reference Manual*, 12/1997.
- [6] Williams T. J., *The Purdue Enterprise Reference Architecture – A technical guide for CIOM planning and implementation*, ISA, Research Triangle Park, NC-USA. 1992.
- [7] Doumeingts G. *et Al.*, Computers in Industry, Vol 42, 2000, pp.245-263.
- [8] Hegge,-J.; Sannes,-T. Introduction of an open system philosophy in the control centre environment. Proceedings of CIGRE 35th International Conference on Large High Voltage Electric Systems. vol.2 28 Aug.-3 Sept. 1994 Paris, France.
- [9] Weil M. Raising the bar for maintenance apps. Manufacturing-Systems. 1998; 16 (11) : 5-5
- [10] Khatib,-A.-R.; Zuzhu-Dong; Bin-Qiu; Yilu-Liu. Thoughts on future Internet based power system information network architecture. 2000 Power Engineering Society Summer Meeting. vol. 1 16-20 July 2000 Seattle, WA, USA
- [11] PROTEUS project Deliverable D5.1, Operation Guidance and Logistics, 2004.
- [12] <https://icas.navsses.navy.mil/>
- [13] <http://www.navsea.navy.mil/default.asp>
- [14] <http://www.mimosa.org> .

[15] <http://www.microsoft.com/biztalk/>.

[16] ISO 13374-1:2003, Condition monitoring and diagnostics of machines -- Data processing, communication and presentation -- Part 1: General guidelines, TC 108/SC 5; 2003-03-13.

[17] Naedele, M.; Sager, P.; Frei, C.. Using multi-agent systems for intelligent plant maintenance functionality, Fifth World Congress on Intelligent Control and Automation (IEEE Cat. No.04EX788), Vol.4. Piscataway, NJ, USA: IEEE, 2004. p. 3059-63 Vol.4.

[18] IEC 62264 « Enterprise – control system integration » Part 1 Models and terminology-2003, Part 2 Object models attributes, 2004, Part 3 Activity models of manufacturing operations management, 2004, TC184/SC5.