



HAL
open science

Modeling Cardiac Stimulation by a Pacemaker, with Accurate Tissue-Electrode Interface

Valentin Pannetier, Michael Leguèbe, Yves Coudière, Richard D Walton, Delphine Feuerstein, Diego Amaro, Philippe Dhiver

► **To cite this version:**

Valentin Pannetier, Michael Leguèbe, Yves Coudière, Richard D Walton, Delphine Feuerstein, et al.. Modeling Cardiac Stimulation by a Pacemaker, with Accurate Tissue-Electrode Interface. FIMH 2023 - 12th International Conference on Functional Imaging and Modeling of the Heart, Jun 2023, Villeurbanne (Lyon), France. hal-04384661

HAL Id: hal-04384661

<https://inria.hal.science/hal-04384661v1>

Submitted on 10 Jan 2024

HAL is a multi-disciplinary open access archive for the deposit and dissemination of scientific research documents, whether they are published or not. The documents may come from teaching and research institutions in France or abroad, or from public or private research centers.

L'archive ouverte pluridisciplinaire **HAL**, est destinée au dépôt et à la diffusion de documents scientifiques de niveau recherche, publiés ou non, émanant des établissements d'enseignement et de recherche français ou étrangers, des laboratoires publics ou privés.



Distributed under a Creative Commons Attribution 4.0 International License

MODELING CARDIAC STIMULATION BY A PACEMAKER, WITH ACCURATE TISSUE-ELECTRODE INTERFACE

Valentin PANNETIER¹, Michael LEGUÈBE¹, Yves COUDIÈRE¹, Richard WALTON², Delphine FEUERSTEIN³, Diego AMARO³, and Philippe DHIVER³

1. Univ. Bordeaux, CNRS, Inria, IMB, UMR 5251, IHU Liryc F-33400, Talence, France, 2. Univ. Bordeaux, Inserm, CRCTB, U 1045, IHU Liryc, F-33000 Bordeaux, France 3. Microport CRM, Clamart, France

An implantable **pacemaker** aims to restore a cardiac beat when the intrinsic conduction system fails. It **sends energy** to the heart in the form of a **voltage pulse** and it is programmed to deliver enough energy to trigger a **cardiac depolarization** (which is called **capture**). We present a 0D model of a cardiac pacemaker with a cardiac tissue. We take into account electrochemical phenomena observed during pacing, like **electrode polarization**. To validate it, we compare numerical results with ex-vivo experimental data of stimulation threshold detection.

> 0D model for a pacemaker

● **Pulse.** A tank capacitor C_{pulse} acts as source of current. In the meantime, a second capacitor C_{ocd} is charged. The **duration** (d) and the **amplitude** (V_{stim}) of the pulse is decided by the clinician.

● **Switch.** short transition phase (\sim hundreds of μs) during which switches are open.

● **Output Capacitor Discharge (OCD).** C_{pulse} is isolated and C_{ocd} discharges. This step lasts for 13 ms, and counteracts the electrode polarization that occurred during the pulse.

> Pacemaker coupled to a purely resistive medium

$$\frac{dI}{dt} + \frac{1}{\tau} I = \frac{1}{R_{tot}} \left(\frac{V_1}{\tau_1} + \frac{V_2}{\tau_2} \right)$$

$$\frac{dV_1}{dt} + \frac{V_1}{\tau_1} = \frac{I}{C_1}$$

$$\frac{dV_2}{dt} + \frac{V_2}{\tau_2} = \frac{I}{C_2}$$

► **Current** (top) and **voltage** (bottom) delivered by a pacemaker lead in a **saline solution** (black solid line). Red dashed lines are the **calibration** for 2 V and 1 ms.

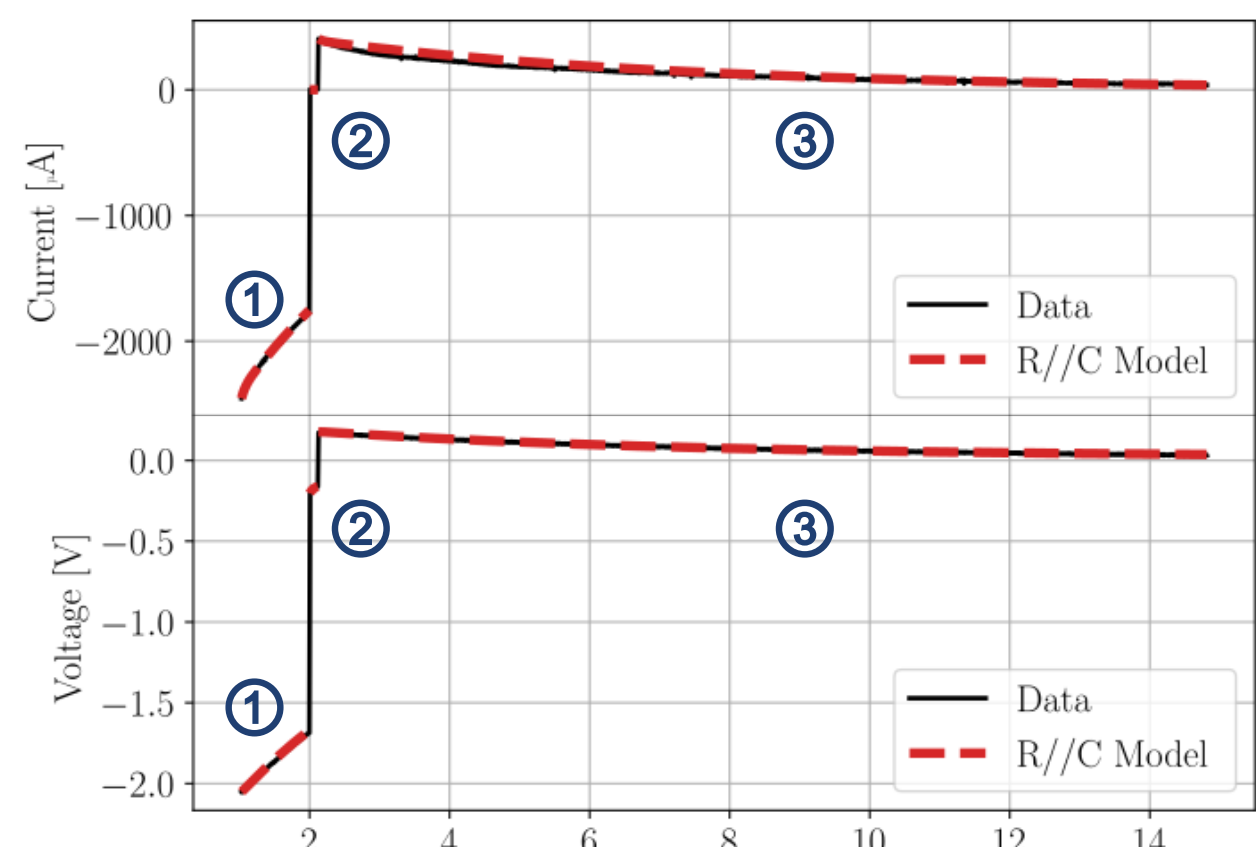

Parameters:

- device: R_{tot} , $\tau = R_{tot} C_{tot}$ depend on the phase (1, 2 or 3).
- contacts: modeled by a parallel RC circuit with parameters (C_1, τ_1) and (C_2, τ_2).

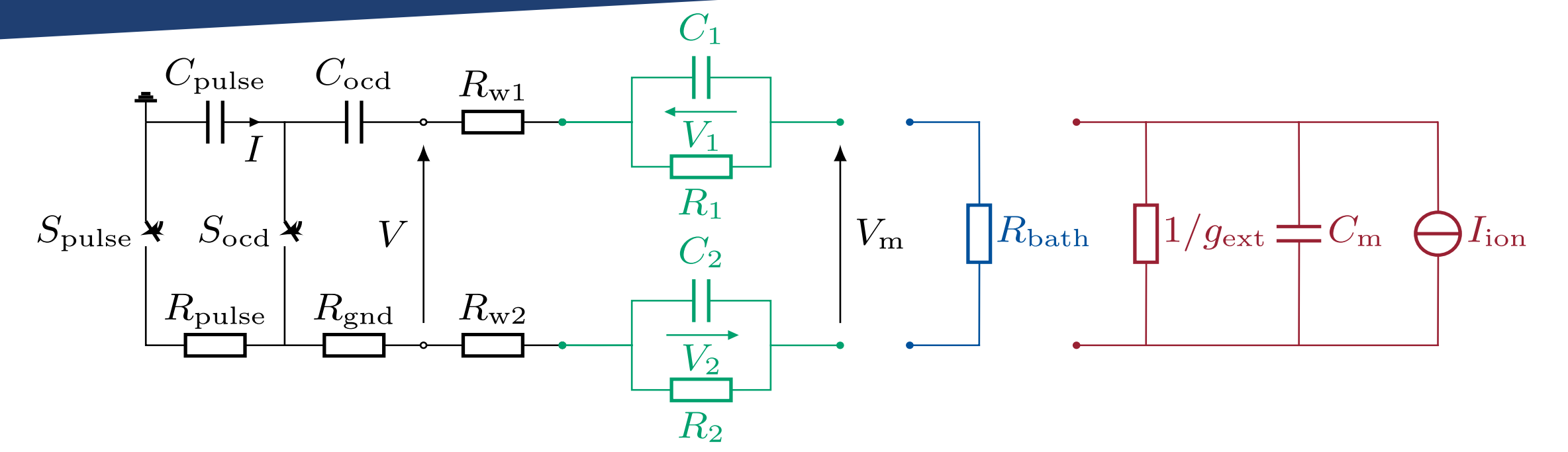

▲ **Equivalent circuit** of a pacemaker (black, left) coupled to either a **resistive medium** (blue, middle), or a **single cell model** (red, right) via connecting dots and contacts (green, middle).

> Pacemaker coupled to a rescaled Beeler-Reuter [3] ionic model (I_{ion}, g) with an extracellular conductance g_{ext}

$$\frac{dI}{dt} + \frac{1}{\tau} I = \frac{1}{R_{tot}} \left(\frac{V_1}{\tau_1} + \frac{V_2}{\tau_2} + \frac{I_{ion}(h, V_m)}{C_m} + \frac{V_m}{\tau_m} \right)$$

$$\frac{dV_1}{dt} + \frac{V_1}{\tau_1} = \frac{I}{C_1}$$

$$\frac{dV_2}{dt} + \frac{V_2}{\tau_2} = \frac{I}{C_2}$$

$$\frac{dV_m}{dt} + \frac{I_{ion}(h, V_m)}{C_m} + \frac{V_m}{\tau_m} = \frac{I}{SC_m}$$

$$\frac{dh}{dt} + g(h, V_m) = 0$$

Parameters:

+ Scaling parameters: $S, \tau_m = SC_m / g_{ext}$.

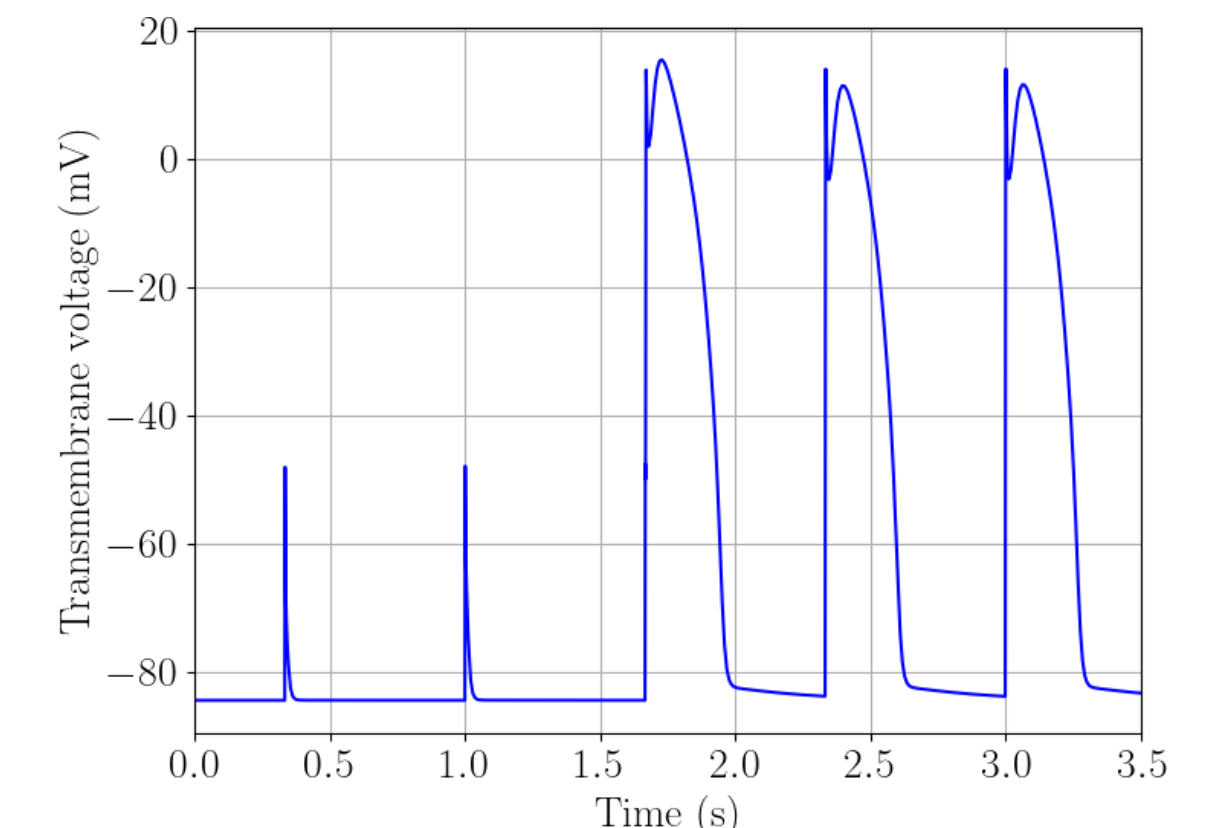

▲ **Transmembrane voltage** computed for a single set of parameters (V_{stim}, d, S, g_{ext}).

> Calibration: ringer tests

To evaluate the **accuracy of the R/C model** for the **electrode polarization**:

• We measure the current I and the voltage V delivered by a pacemaker lead directly in a **saline passive solution** without cardiac tissue.

• We use a MicroPort Vega lead to **obtain datasets of (I_{meas}, V_{meas})** for **different stimulation amplitudes and durations**.

• **Method.** Weighted least square on I_{meas} and V_{meas} .

• **Resolution.** SciPy implementation of the L-BFGS-B algorithm

→ **Identifying** properties of contacts (C_1, τ_1) and (C_2, τ_2).

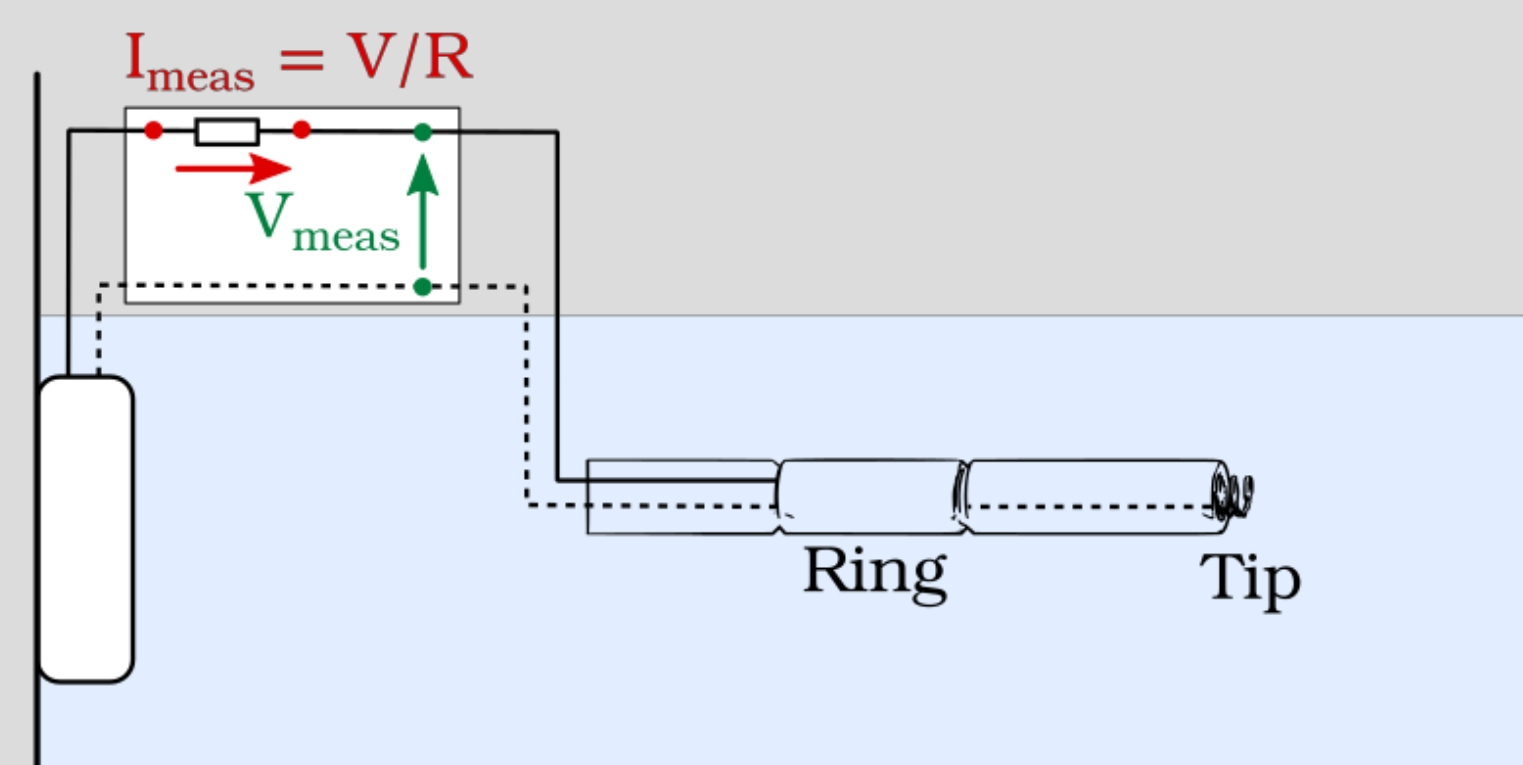

▲ **Sketch** of the bench test used to calibrate the electrode contact model.

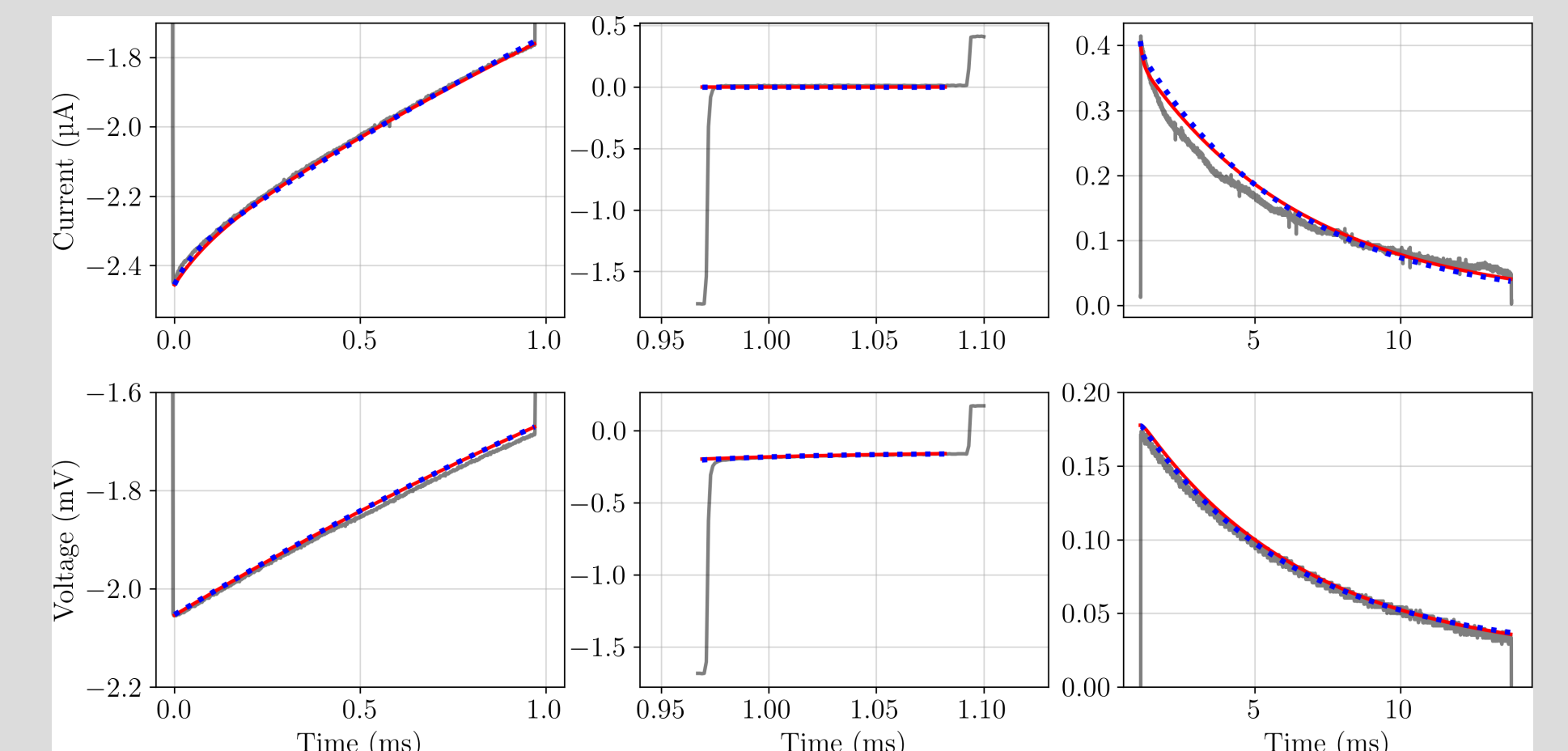

▲ **Fitted currents and voltages** when calibrating parameters $\theta = (R_1, R_2, \tau_1, \tau_2)$: comparison between a single experimental dataset (gray solid line), θ calibrated on this dataset (blue dotted line) and θ calibrated on the 9 datasets together (red solid line).

> Computer model compared to experimental data

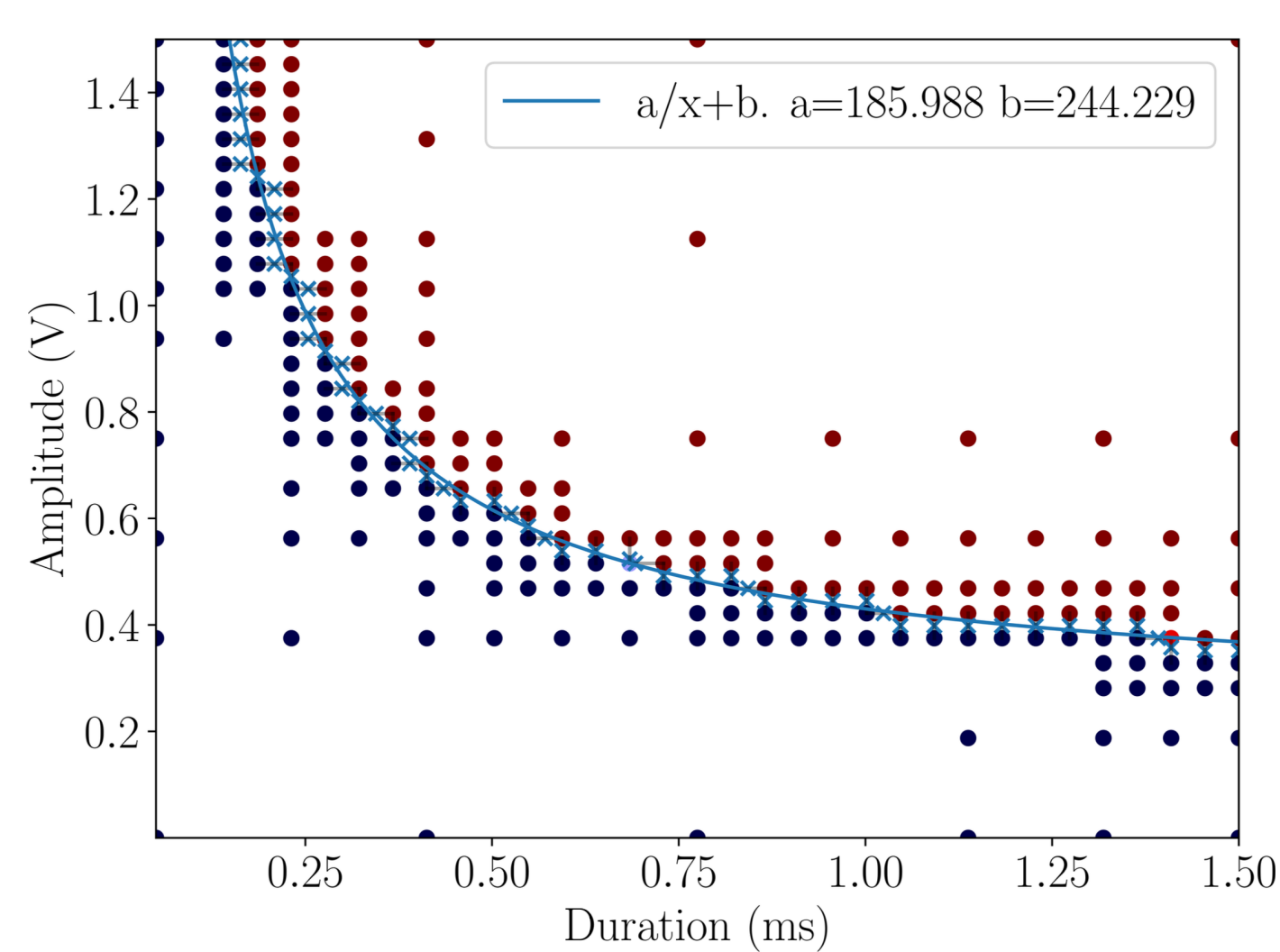

▲ **Lapicque curve** obtained after detection of a 50% capture ratio. Blue points are for 0% capture, and red points for 100% capture.

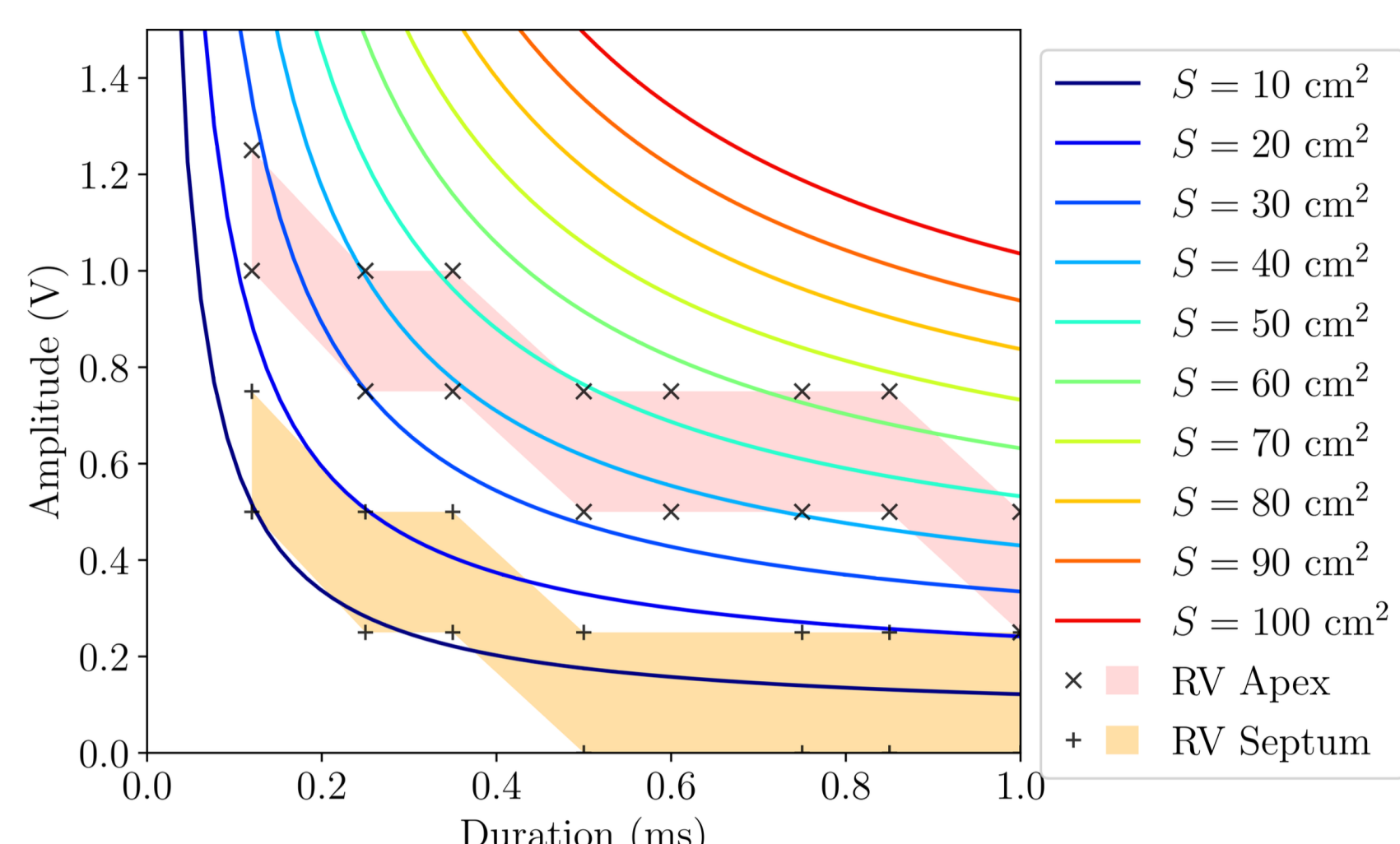

▲ Comparison of **Lapicque curves** (solid lines) computed with different values of S (top) and R_1 (bottom). The **shaded regions** indicate where the **experimental capture threshold** is located, for different stimulation sites on the tissue wedge. ▼

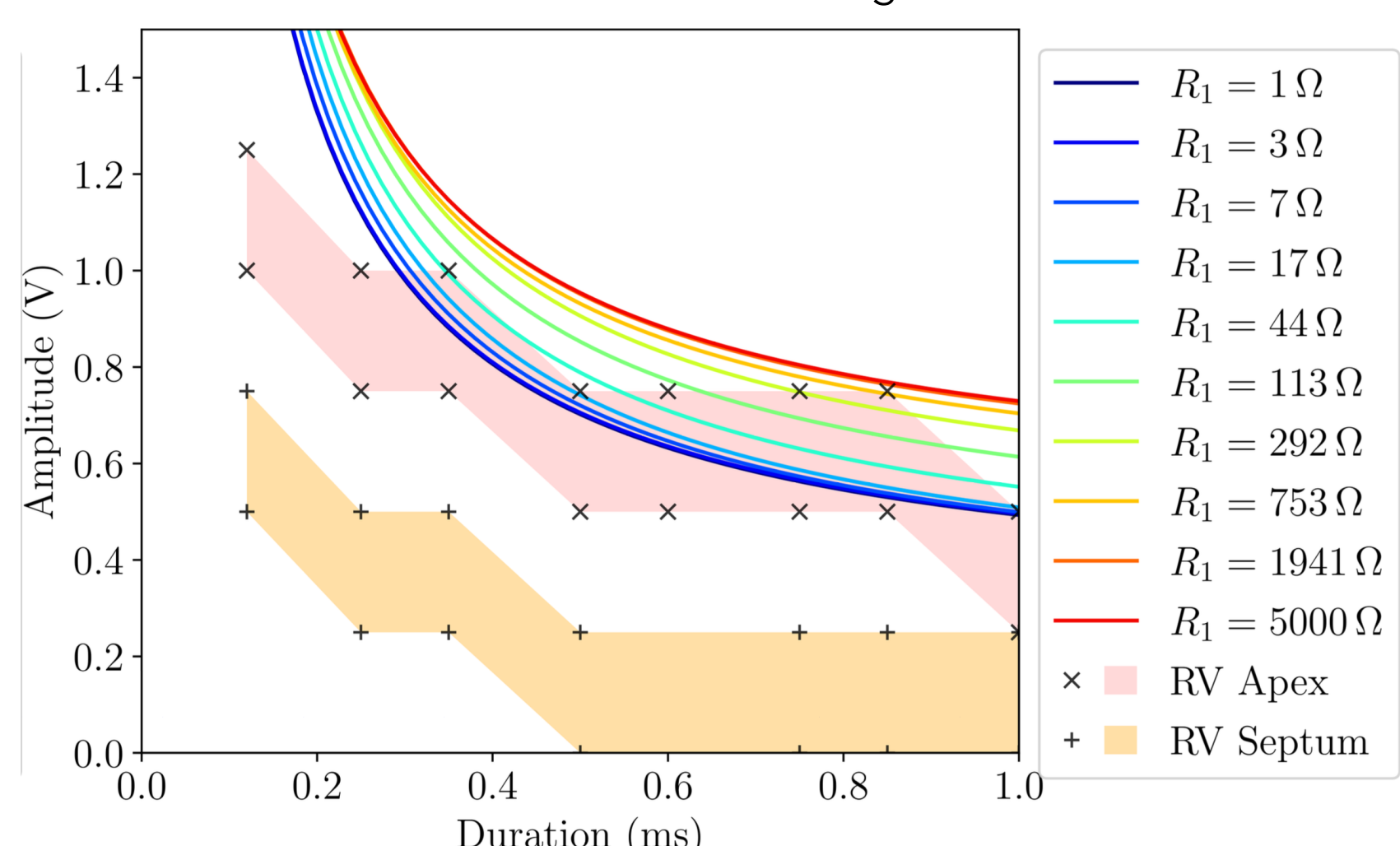

> Lapicque curve

In order to save battery, the energy delivered by the pacemaker must be just above the cut-off threshold between capture and non-capture.

- **Lapicque curve:** threshold of stimulation in the voltage-duration plane [2].
- Computed from **ratio of successful captures** in the 0D model with a **2D dichotomy**.

$$A(d) = A_{rh} \left(1 + \frac{t_{ch}}{d} \right)$$

> Animal and computer experiments

- **Two** wedge preparation of **sheep hearts** in a saline solution [5].
- Testing a **range of pulse durations and stimulus amplitudes** to localize the stimulation threshold.

• Scaling parameter **S** has a **great influence** (determines the amount of current seen per cm^2 of membrane).

• **Little influence** of the parameter **g_{ext}**

• Study the **influence of bio-electrodes parameters** (contact with tissue, not only a bath).

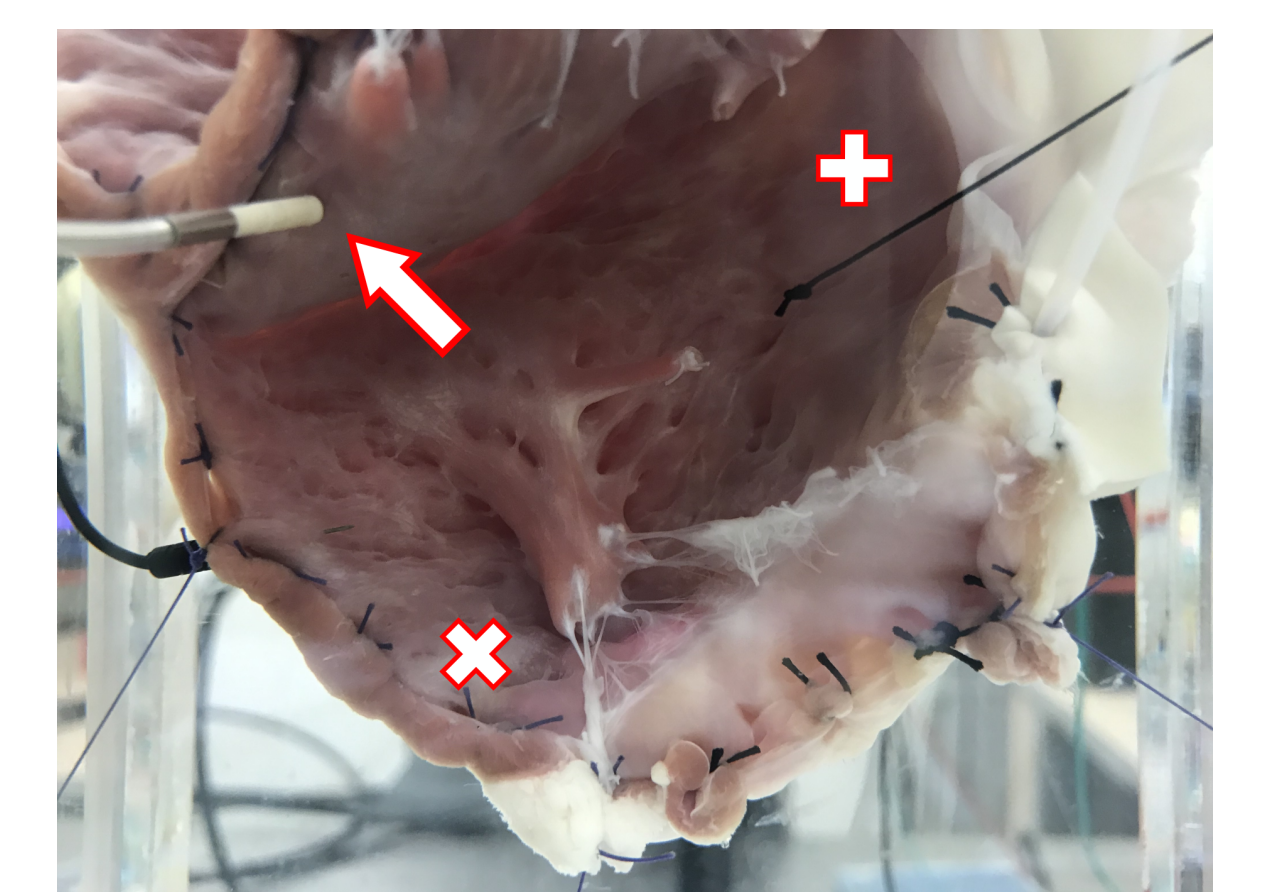

▲ **Right ventricle endocardial** view of the tissue wedge preparation with the pacemaker electrode implanted in the septum (arrow). Other implantation sites were located in the apex (+) and at the base of the ventricle (+).

> Next

> 3D model of tissue slab surrounded by blood

- Take the geometry into account (electrode distances, front wave propagation, ...).
- Compare experimental data with our 3D solution.

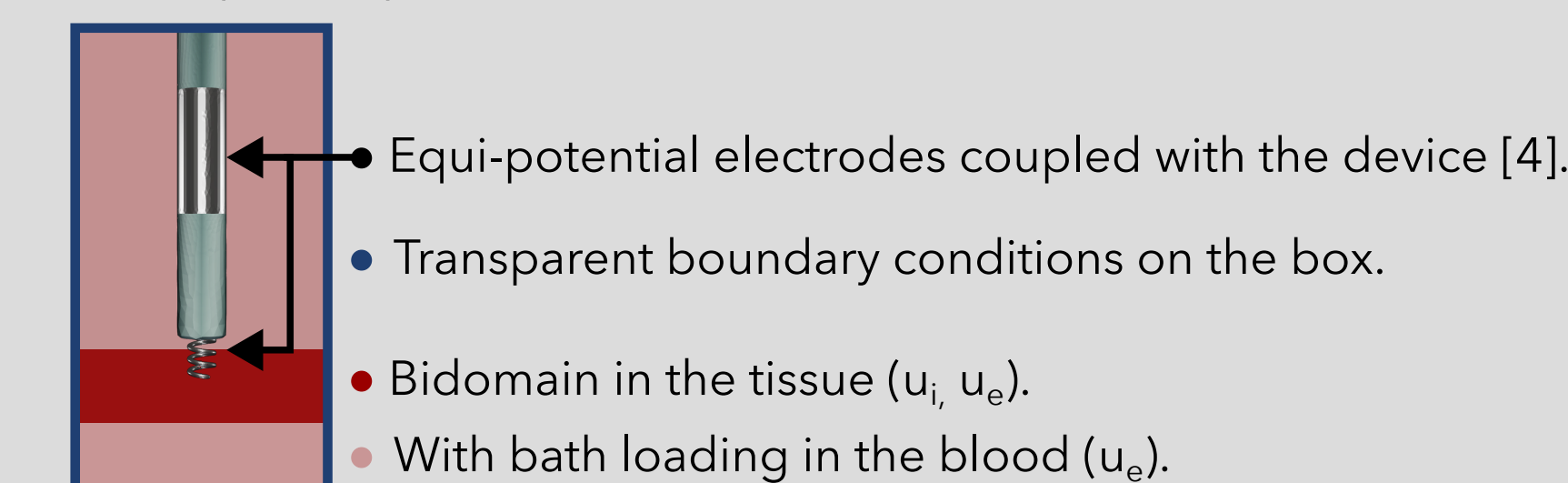

> Additional ex-vivo data to adjust the model

- Activation by optical mapping → conductivity distribution.
- Voltage measured by the lead.
- Geometries, fibers orientation and collagen distribution from 9.4T MRI.

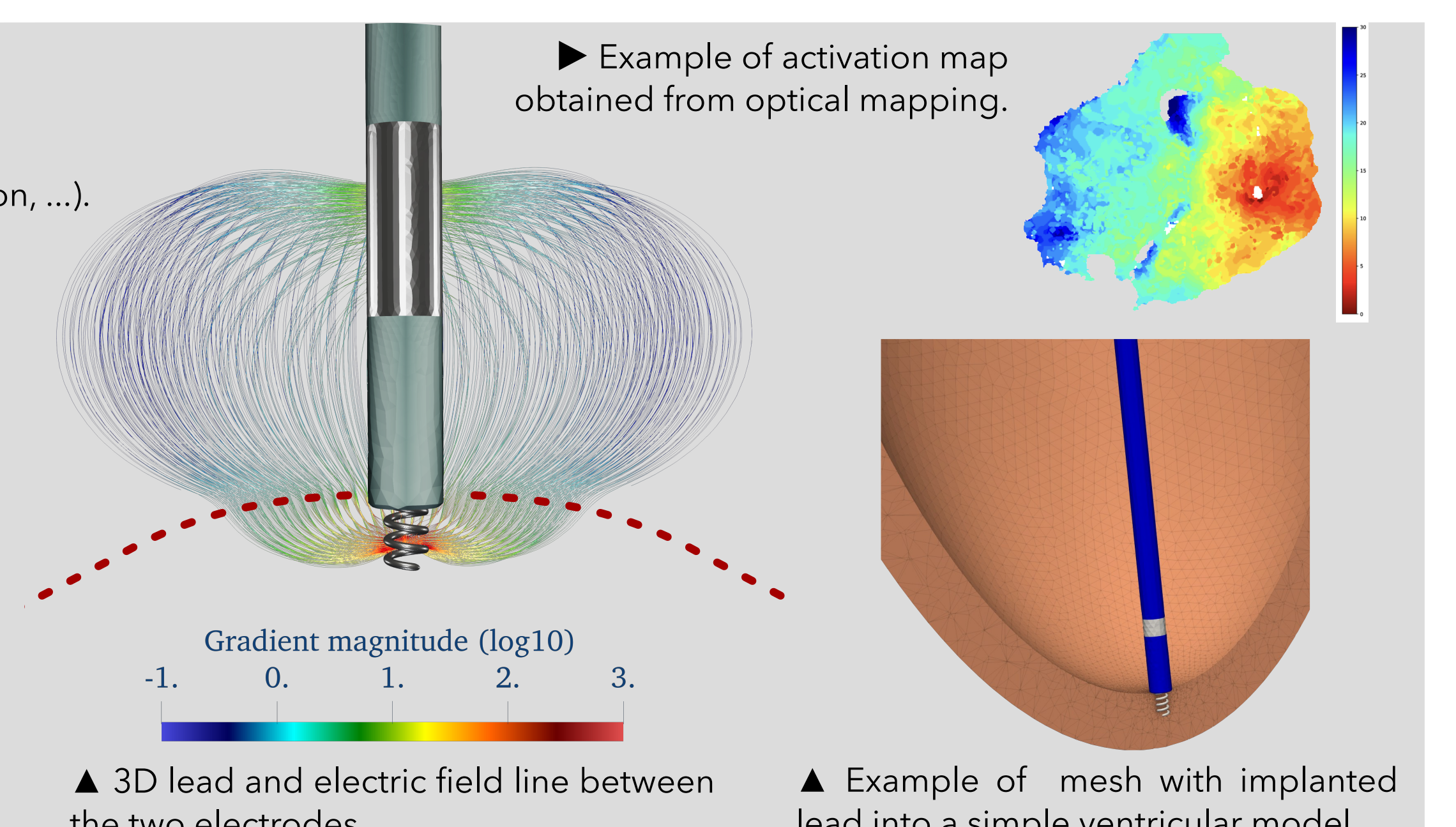

▲ 3D lead and electric field line between the two electrodes.

▲ Example of mesh with implanted lead into a simple ventricular model.

References

1. Beeler, G.W., Reuter, H.: Reconstruction of the action potential of ventricular myocardial fibres. J Physiol (1977).
2. Blair, H.: On the intensity-time relations for stimulation by electric currents. JGP (1932).
3. Grimnes, S., Ørjan G Martinsen: Bioimpedance and Bioelectricity Basics (Third Edition). Academic Press, Oxford (2015)
4. Somersalo, E et al: Existence and Uniqueness for Electrode Models for Electric Current Computed Tomography. SIAP (1992).
5. Walton, R.D., et al: Compartmentalized Structure of the Moderator Band Provides a Unique Substrate for Macroreentrant Ventricular Tachycardia. CIRCEP (2018)