



HAL
open science

Systematic for Process Improvement Using Cyber-Physical Systems and Toyota Kata

Raphael Odebrecht de Souza, Helio Aisenberg Ferenhof, Fernando Antônio
Forcellini

► **To cite this version:**

Raphael Odebrecht de Souza, Helio Aisenberg Ferenhof, Fernando Antônio Forcellini. Systematic for Process Improvement Using Cyber-Physical Systems and Toyota Kata. 18th IFIP International Conference on Product Lifecycle Management (PLM), Jul 2021, Curitiba, Brazil. pp.447-460, 10.1007/978-3-030-94335-6_32 . hal-04186156

HAL Id: hal-04186156

<https://inria.hal.science/hal-04186156v1>

Submitted on 23 Aug 2023

HAL is a multi-disciplinary open access archive for the deposit and dissemination of scientific research documents, whether they are published or not. The documents may come from teaching and research institutions in France or abroad, or from public or private research centers.

L'archive ouverte pluridisciplinaire **HAL**, est destinée au dépôt et à la diffusion de documents scientifiques de niveau recherche, publiés ou non, émanant des établissements d'enseignement et de recherche français ou étrangers, des laboratoires publics ou privés.



Distributed under a Creative Commons Attribution 4.0 International License



This document is the original author manuscript of a paper submitted to an IFIP conference proceedings or other IFIP publication by Springer Nature. As such, there may be some differences in the official published version of the paper. Such differences, if any, are usually due to reformatting during preparation for publication or minor corrections made by the author(s) during final proofreading of the publication manuscript.

Systematic for Process Improvement Using Cyber-Physical Systems and Toyota Kata

Raphael Odebrecht de Souza^{1,2,a[0000-0002-2186-6183]}, Helio Aisenberg Ferenhof^{1,3[0000-0001-5167-0838]} and Fernando Antônio Forcellini^{1,2[0000-0003-2851-6028]}

¹ GEPPS – Service, Process and Product Engineering Group

²Department of Mechanical Engineering – Federal University of Santa Catarina.

³ Post-Graduate Program in Knowledge Engineering and Management - Federal University of Santa Catarina.

^araphael.odebrecht@posgrad.ufsc.br

Abstract. There are several benefits reported in the literature regarding the Lean approach and Industry 4.0 integration. In general, the most significant justification for integrating these two concepts is that incorporating new technologies in a production system should only occur once the system is operating without waste and in an optimized way. Thus, implementing the Lean approach represents an excellent opportunity for organizations that want to use the technologies of Industry 4.0 (I4.0). Although Industry 4.0 brings new opportunities for digitalizing production systems, machines and equipment cannot suggest improvements independently. In this way, employees will continue to be an integral part of production systems. However, when analyzing the specialized literature, it was possible to observe that the discussion about workers' participation to effectively implement the new technologies of I4.0 in the productive systems is incipient. Thus, this work presents a new framework developed called Systematic for Process Improvement Using Cyber-Physical Systems and Toyota Kata that use the Improvement Kata and Coaching Kata routines and the cadence of activities from the training of employees to the development of the Cyber-Physical System of the organization to implement the new technologies of Industry 4.0. The systematic was tested in a theoretical case study, and the results showed that it was possible to develop a Cyber-Physical System using SIMIO® software. Improvements could be developed and simulated in the digital environment with data from the actual process.

Keywords: Lean, Toyota Kata, Cyber-Physical Systems, Industry 4.0.

1 Introduction

The benefits reported in the literature regarding the integration of the Lean approach and Industry 4.0 (I4.0) are real-time communication of the worker at the workstation and the Cyber-Physical System (CPS), real-time recognition of errors, and the consequent elimination of process waste and mutual transfer of knowledge between senior

managers and shop floor workers, among others [1], [2], [3], [4]. However, there is an absence of frameworks that describe the role of shop floor workers to actively implement the new technologies of I4.0 on the process level and develop the organization CPS. Besides that, the sustainability of changes arising from the Lean approach is often inefficient, and the improvements get lost over time because they are not part of the routine of workers [5].

When investigating how Toyota maintains its improvement standards over time, [6] described the Toyota Kata (TK) approach. This method consists of two complementary routines that, when repeated constantly, can make the continuous improvement part of the culture of organizations. TK approach can establish routines that can conduct workers towards the same direction, stimulate organizational learning, and make the continuous improvements process daily for the organization. Based on this scenario, this paper aims to demonstrate how the TK approach can be used with the technologies of I4.0 to develop the CPS of an organization and present the initial results of its application on a theoretical case study.

2 Methodology

Initially, an extended Structured Bibliographic Research (SBR) following the Systematic Search Flow (SSF) [7] method was conducted to gather information about the integration of Lean and TK approach with I4.0. We search leading journals and conference proceedings using the keywords that the online databases Scopus, Web of Knowledge, EBSCO, Engineering Village, ProQuest, and Google Scholar offer. The query string used was (("Lean" OR "Value Stream Management" OR "Toyota Kata") AND ("Industr* 4.0" OR "Smart Factory" OR "Cyber-Physical Systems")). The research was also complemented with exploratory research.

Based on the SBR, the literature gaps were identified. The constructs and best characteristics were selected to develop a framework for applying the Toyota Kata approach to integrate I4.0 technologies and develop the CPS on the production systems of organizations.

In order to demonstrate the result of the framework developed, a theoretical case study was performed. As recommended by [8] and [9], we opted to use a case study as a research strategy. We intended through the case investigate the research object crucial characteristics, being our analyses unity. The manufacturing field is an area in which process simulation tools are essential to validate methods and architectures before applying them to the shop floor [10]. For [11], simulations bring benefits such as low cost, ease of use, and the wealth of details concerning a natural system.

The article is organized as follows: initially, state-of-the-art on integrating the Lean approach, TK, and Industry 4.0 is presented. Then, the Toyota Kata approach is briefly described. Then, the new framework is presented, and its phases are described. Finally, the theoretical case study, discussion, and conclusions are presented.

3 Integration of Industry 4.0 and Lean

By analyzing the studies referring to I4.0 and the Lean approach in the literature, it was possible to verify how these concepts worked in theory and practice. I4.0 is a contributor to the activities of an organization, as it focuses on optimizing and improving the efficiency of processes. The use of the technologies of I4.0 aims to acquire and present new data and information about the production environment to assist the decision-making of employees. To convert resources into intelligent objects, I4.0 uses a set of technologies based on the concepts and interactions between the Cyber-Physical Systems (CPS) [12] and the Internet of Things (IoT) [13].

The motivations for integrating I4.0 and Lean concepts are diverse, but they can be summed up with the statement by [14], which says that "the automation of inefficient processes will continue to make the process inefficient." Thus, [15], [16], and [17] suggest a progressive order, in which first the Lean approach is implemented, which is responsible for optimizing and organizing the manufacturing environment, and then the technologies of I 4.0 can be used to connect and digitize processes.

According to [4], the use of sensors on the shop floor generates performance data and metrics transmitted in real-time to the organization's Cyber-Physical System. Thus, through the Value Stream Mapping (VSM) tool, these data can optimize production systems. [18]. Furthermore, [19] presented the use of the VSM tool in conjunction with the I4.0 technologies in detail. According to the authors, its use allows a comprehensive visualization of socio-technical systems, including technologies, organizations, and people.

According to [2], [4], [14], [20], excessive automation may not be beneficial since, currently, machines and equipment are unable to suggest improvements on their own. Therefore, the human factor should be better described in the existing models for integrating the two approaches since employees will continue to participate actively in adding value.

Some authors like [21], [22], [23], [24], [25], present the Toyota Kata approach as a contributor to Industry 4.0. According to the works, the TK approach can characterize the current condition and design the future states of production systems. Besides that, the TK approach is presented to implement the continuous improvement process with PDCA cycles.

Although the works mentioned above cited the TK approach as a contributor to industry 4.0, some opportunities for improvement were observed. None of the authors discuss using the Value Stream Mapping tool in conjunction with the Toyota Kata approach and the Cyber-Physical Systems of the organization to characterize how the production system behaves and the possibility of simulating optimized future states. Furthermore, no work has shown the step-by-step that an organization must take to effectively implement Industry 4.0 on its production process and develop the Cyber-Physical System of the organization.

4 Toyota Kata approach

When investigating how Toyota maintains its continuous improvement standards, [6] presented an investigated approach within the company called Toyota Kata.

Kata means routine or "way of doing" and is described as a repeated pattern and develops skills and a new mindset for improvement. This pattern directly interferes with the reasoning and behavior of employees, as it is a routine of continuous improvement that provides the training of people through the application of the scientific method for sustainably solving problems [6]. The practice of Kata is based on two concepts, as shown in Figure 1: Improvement Kata and Coaching Kata [6] and [26].

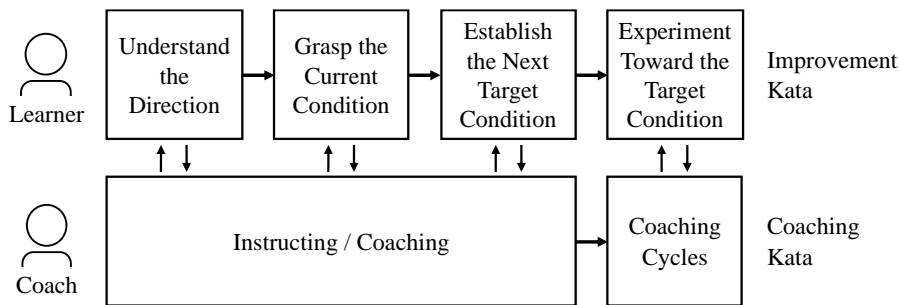

Fig. 1. Improvement Kata and Coaching Kata [6], [26].

4.1 Improvement Kata

The Improvement Kata routine is performed by an apprentice and can be used at all organizational levels, but the process level is where much of the continuous improvement occurs [6]. The Improvement Kata routine is divided into four steps, as shown in Figure 3 and described below.

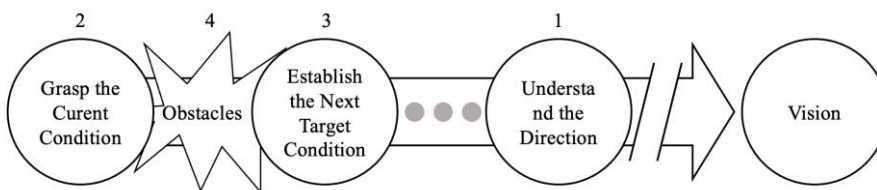

Fig. 1. Four steps of Improvement Kata [6].

1. Understand the Direction: This is what the organization seeks in the long run. The challenge pursued by the teams is usually selected by the leadership and is in line with the company's vision.
2. Grasp the Current Condition: The purpose of this step is not to discover potential problems or improvements but to analyze and understand the Current Condition of

the process and obtain the facts and data necessary to establish an appropriate Target Condition for the following process.

3. Establish the Next Target Condition: After understanding the Current-Condition, a Target Condition is established, that is, a better future state that can be reached in a short time.
4. Interact towards the Target Condition: It is at this stage that the Apprentice and his team carry out small experiments, using the scientific method for solving problems through the PDCA (Plan, Do, Check and Act, in English), to exit from the Current-Condition and go towards the Target-Condition. The obstacles that prevent the team from reaching the Target Condition are lifted, and one obstacle at a time is chosen to be addressed. After each stage, a reflection is made, and the next stage is planned.

4.2 Coaching Kata

Coaching Kata is how the Improvement Kata routine is taught. The coach is responsible for guiding the learner through the learning cycle. The Coach performs cycles with the Apprentice next to a Storyboard board, where notes and information from the PDCA cycles are taken, guided by five questions. Often these cycles are performed aided by a card, with the script for the Coaching Kata cycle, as shown in Figure 4.

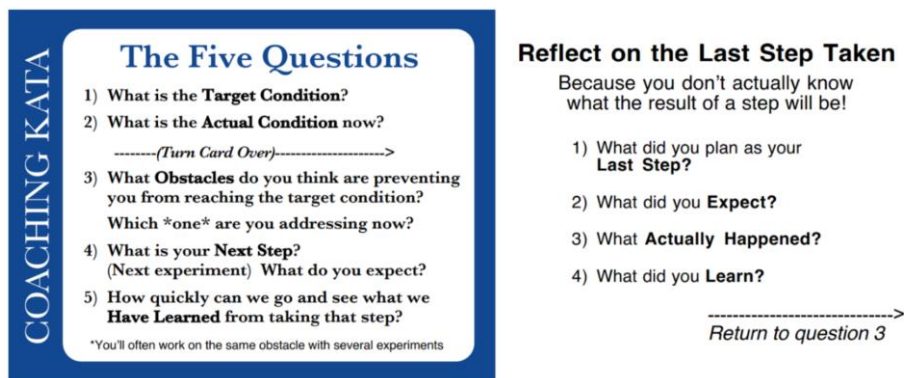

Fig. 2. Card with the five questions for the Coaching Kata Cycle [6].

As mentioned before, [21], [22], [23], [24] and [25] presented the TK approach as a contributor to I4.0. Nevertheless, there are several applications of the TK approach in different environments. [27] used the TK approach to implement the Value Stream Mapping in an organization. [28] combined the TK approach with the TRIZ approach to developing a method for sustained innovation. Moreover, [29] and [30] used the TK approach to implement Lean Construction. [31], [32] and [33] used the TK approach to improve different processes in hospitals. In sequence, the new framework developed in this work is presented.

5 Systematic for process improvement using Cyber-Physical Systems and Toyota Kata

For this work, systematics is understood as improving methods based on the interpretation and critical reflection of the lessons learned, characterized by the organization of data, practices, and concepts that lead to a reflection and re-elaboration of thought [34]. Therefore, this topic aims to present the system developed for process improvement using Cyber-Physical Systems and Toyota Kaya. The systematic aims to guide the subjects involved in the process by maintaining the sustainability of improvements and the innovation of solutions. The improvement is based on the Improvement Kata and Coaching Kata routine, resulting in sequencing target conditions.

The systematic is composed of five phases (team training, unfolding the company's vision, value stream mapping, implementing the technologies of industry 4.0, and elaborating the Cyber-Physical System.) presented in Figure 5.

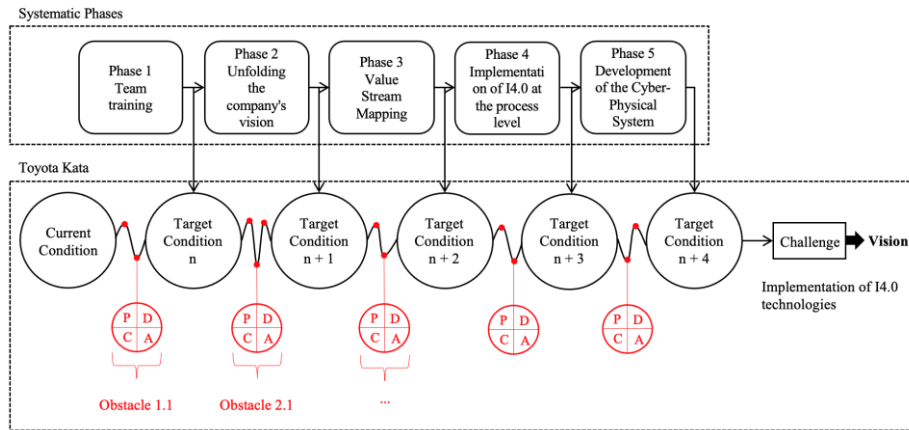

Fig. 5. General overview of the Systematic.

- Phase 1 – Team training: The improvement process is necessary to evaluate the organization's current condition concerning TK, I4.0, and CPS knowledge. Thus, according to the company's maturity level, participants in the improvement process should be trained with the fundamentals of the necessary concepts if there is a knowledge gap.
- Phase 2 – Unfolding the company's vision: To use the Toyota Kata routine, the True North or the company's direction must be clear, and its unfolding to the lower levels must be carried out. Thus, based on a larger objective of the organization, the challenge for each team is defined. This way, the challenges of the different levels will be linked to the organization's objectives, and the new Target Condition of one level will be the challenge of the lower level.

- Phase 3 – Value Stream Mapping: It is from the Value Stream Map that the opportunities to implement the technologies of Industry 4.0 are identified. The tool also ensures that the improvement does not arise from an isolated initiative. Instead is guided in what the company is prioritizing. It is recommended that the elaboration of the VSM is carried out with the participation of everyone directly involved with the processes that belong to specific flows, such as supervisors and employees at the operational level, to identify the real problems of the value flow and make the correct definition of the direction of improvements.
- Phase 4 – Implementation of I4.0 at the process level: From the Value Stream Map and the breakdown of activities at the different hierarchical levels of the organization, the team can select a specific process and start the implementation of Industry 4.0 technologies at the process level. The new technologies to be implemented in the value stream must assist employees and not replace them; currently, they will continue to participate in the improvement process.
- Phase 5 – Development of the Cyber-Physical System: The organization's Cyber-Physical System is the center of Industry 4.0, as it integrates the physical and digital components of the process. Sensors are responsible for capturing the production process parameters in real-time, and these data are sent to the company's Cyber-Physical System. In this way, a Digital Twin can be created, and the modifications can be simulated in the digital environment before being implemented in the actual process. Not only that, but the Cyber-Physical System can communicate with operators and inform the parameters of the production process in real-time.

During all phases, the Coaching Kata routine is used to understand the challenge, characterize de Current Condition, set the Target Condition, and list the obstacles blocking the team from going from the Current Condition to the Target Condition using the five-question card. This way, the team can iterate in short PDCA cycles towards the Next Target Condition. When the team achieves that Target Condition, another Target Condition towards the Challenge is set. By repeating this process, the organization can reach the final challenge that is the implementation of I4.0 technologies.

With the Toyota Kata approach carried out in the form of short cycle experiments, improvement is encouraged as a routine among the participants in the process, as it requires the presence and involvement of all employees to think about solutions and test them, thus aiming the sustainability of improvements in the organization. Using the system proposed in this work, organizations can start Industry 4.0 and make their processes more efficient and connected. Industry 4.0 technologies enable faster and more efficient decision-making and creating a Digital Twin factory that allows improvements to be tested in the digital environment before being implemented.

6 Theoretical case study

The Systematic for Process Improvement Using Cyber-Physical Systems and Toyota Kata developed in this work was implemented in a hypothetical and simulated case study conducted by post-graduate students at the GEPPS (Engineering Group of Products, Processes, and Services) of the Federal University of Santa Catarina.

According to [35], simulation models can provide most of the information needed to design, analyze, and operate complex systems. The manufacturing field is an area in which process simulation tools are essential to validate methods and architectures before applying them to the shop floor [36]. For [37], simulations bring benefits such as low cost, ease of use, and richness of details concerning a natural system. In sequence, the elements used in this theoretical case study are presented. Furthermore, Table 2 presented at the end of this topic summarizes the Systematic for Process Improvement Using Cyber-Physical Systems and Toyota Kata developed in this work with the case study outputs.

The simulation environment used for this study is based on a model developed by [26] that represents a bicycle manufacturing process of a fictitious company called Pedal+. The model reproduces a company's manufacturing system in terms of logical and quantitative aspects, which can be manipulated and altered to observe how the system behaves. Different types of workstations (such as material receiving, assembling components, welding, painting, and final assembly) can be changed to check their influence on system behavior. Thus, several scenarios can be tested and their implications directly observed.

The model's objective is to assist teaching, research, and training of Lean practices, carrying out experiments in an environment similar to the industrial one.

In the initial stage of the simulation, Pedal+ has three production lines with four working cells and a painting process that works in batches. Raw material deliveries take place daily, and shipment takes place weekly. Inter-process inventories have no control.

Following the phases of the Systematic for Process Improvement Using Cyber-Physical Systems and Toyota Kata, the information on the Current State of the production system was given to participants. As the students were already familiar with the TK approach, I4.0 and CPS, no training or capacitation was needed (phase 1). Next, the unfolding of the company's vision (phase 2) was developed as being "become a reference in quality and service, consolidating the brand in the regional market, maintaining above all the well-being and satisfaction in the organizational environment."

With the information of the productive system in hand, the team started using the TK approach to draw the Current State VSM (phase 3) with the help of the software SIMIO® (Figure 6). After the characterization of the current state, the team begins to think about which I4.0 technologies should be implemented in the production system to understand better how it is working (phase 4) and what improvements could be implemented.

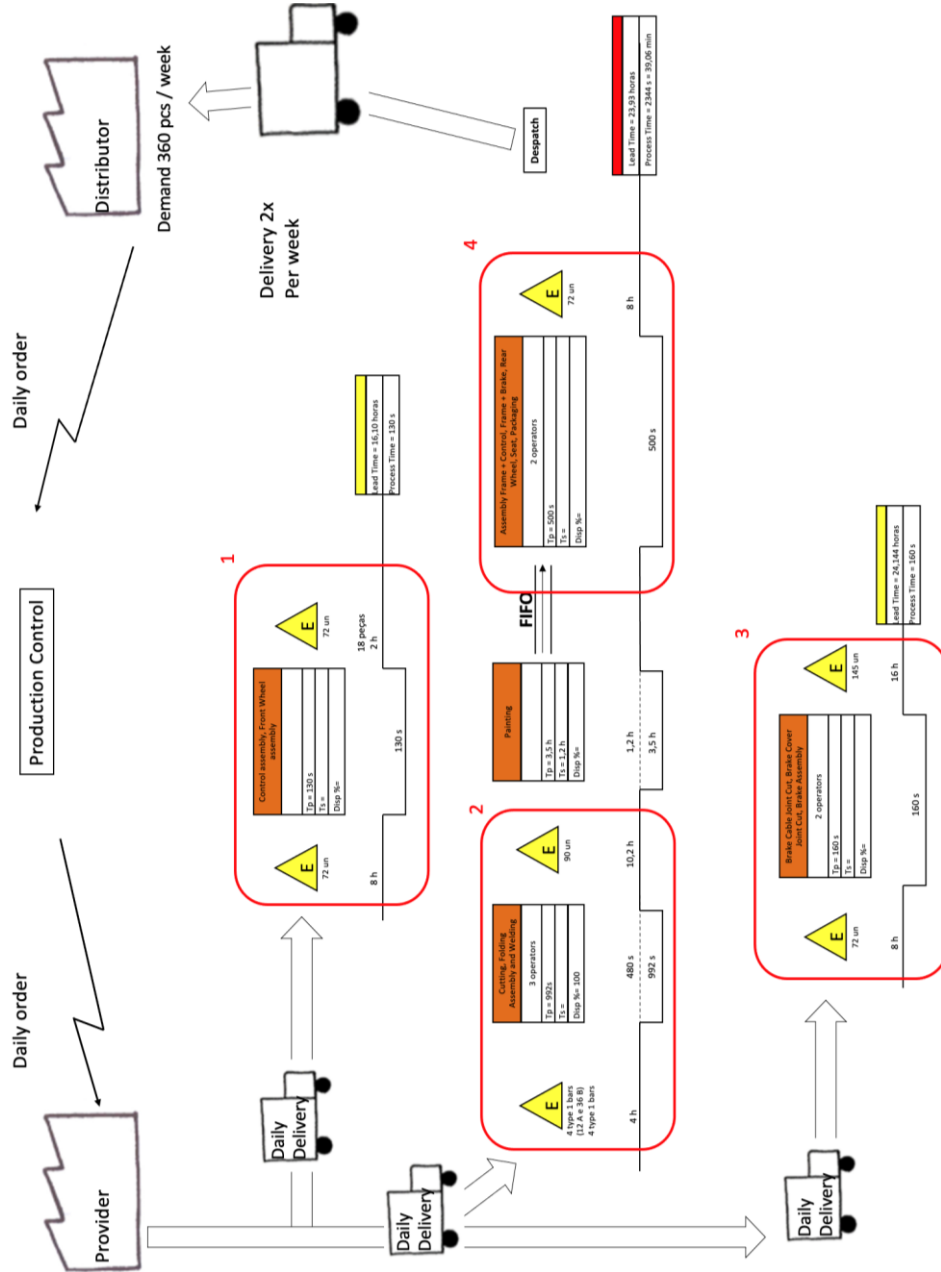

Fig. 6. Current State VSM.

As the main objective of the implementation of I4.0 is to acquire information about how the system is behaving, the team opted to implement RFID sensors to develop the

Cyber-Physical System of the Pedal+ (phase 5). The team decided to implement supermarkets between the cells and pulled systems, controlled by electronic Kanban (e-Kanban) to control the inventory. The team could calculate and simulate the ideal parameters for all the e-Kanban systems from the RFID sensors and the CPS data. The comparative results before and after the e-Kanban systems are presented in Table 1.

Table 1. Inventory before and after e-Kanban

Process	Before	Time	After	Time
	e-Kanban [uni]	[hours]	e-Kanban [uni]	[hours]
1 and 2	72	8	18	2
Two and painting	90	10,2	30	3,4
3 and 4	145	16	18	2
Total	307	34,2	66	7,4

With this modification, the number of units stocked between Pedal+ production processes decreased from 307 units to 66 units, representing a reduction of 26,8 hours of the total Lead Time. With the modification implemented, it was possible to observe that the sensors of Industry 4.0 had the role of providing information from the production system for the team's decision-making. The Lean approach was responsible for the optimization of stocks with the implementation of supermarkets.

Another problem identified by the team was the defects produced by cell 4, which had a 23% rework. In this simulation scenario, errors occur during the bike's assembly stage since the parts arriving from the auxiliary lines are placed in boxes, and the assembly happens at random; that is, the operator decides the assembly sequence of the parts. To correct the errors identified by the assembly process. The team implemented a process so that the bicycle assembly occurs in a standardized manner and the sequence determined, as shown in Figure 7.

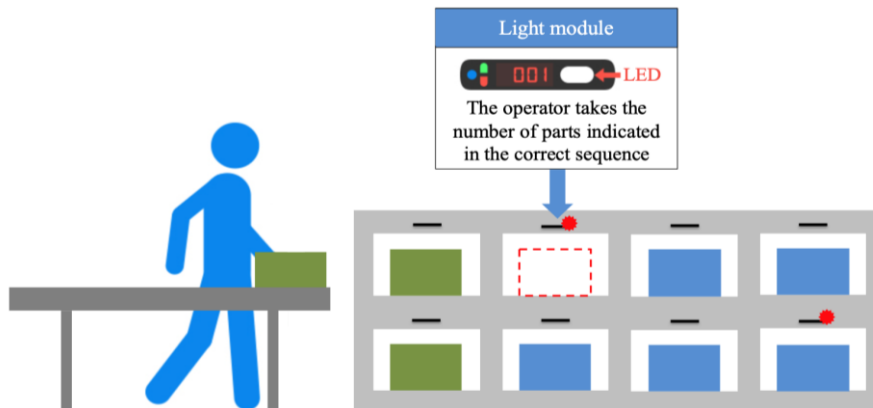

Fig. 7. Pick to light and put to the light system.

With the implementation of the system, the team verified that errors in the assembly process were eliminated.

The improvements proposed in the VSM of the future state were implemented in the SIMIO® software to simulate the new Current Condition of the organization (Figure 8).

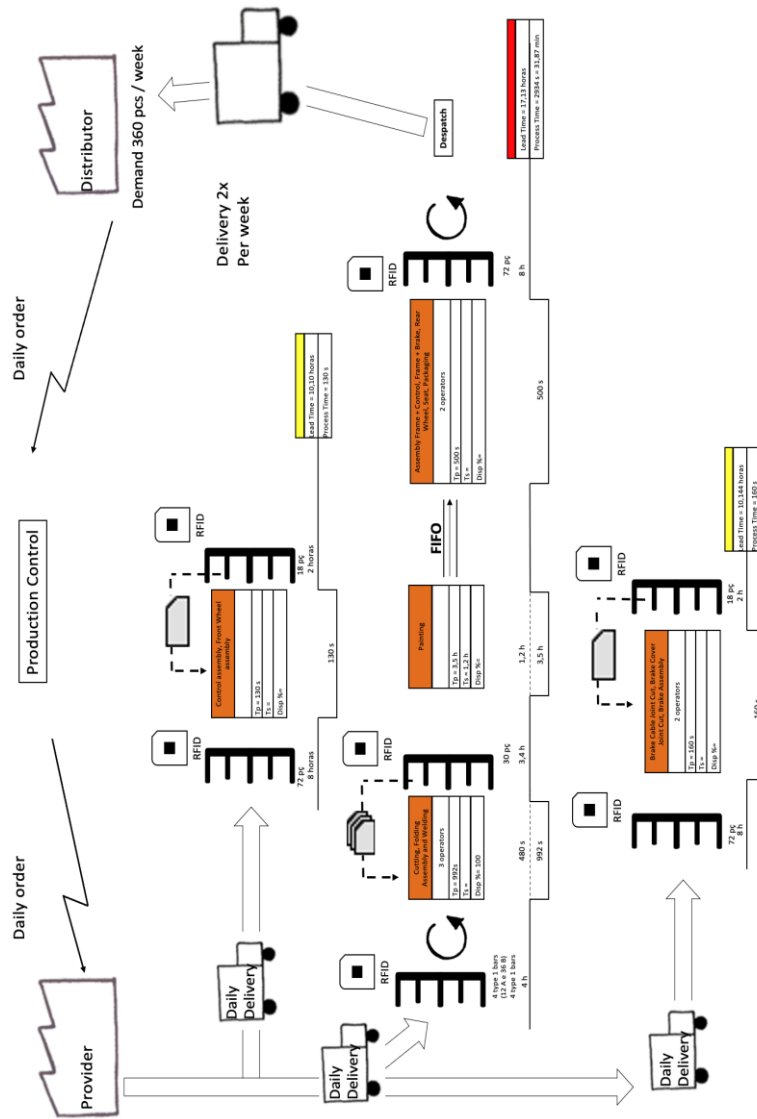

Fig. 8. Future State VSM.

Table 2 summarizes the use of the Systematic for Process Improvement Using Cyber-Physical Systems and Toyota Kata, its phases, and its outcomes for this case study.

Table 2. Phases of the Systematic for Process Improvement Using Cyber-Physical Systems and Toyota Kata and its outcomes.

Phase	Description	Outcome
1	Team Training	As the participants were already familiar with the TK approach, I4.0 and CPS, no training or capacitation was needed.
2	Unfolding the company's vision	The company's vision was developed as being "become a reference in quality and service, consolidating the brand in the regional market, maintaining above all the well-being and satisfaction in the organizational environment."
3	Value Stream Mapping	The team used the TK approach and the software SIMIO® to draw the Current State VSM, as shown in Figure 6.
4	Implementation of I4.0 at the process level	Implementation of RFID sensors, implementation of supermarkets between the cells and pulled systems, controlled by electronic Kanban (e-Kanban). Implementation of a pick to light and put to the light system to correct and avoid errors.
5	Development of the Cyber-Physical System	The Cyber-Physical System was developed on SIMIO® with the information acquired by the I4.0 sensors.

7 Conclusion

From the case study carried out in this work, it became evident that Industry 4.0 does not alter an organization's production processes' physical capacity but facilitates and controls the exchange of information more efficiently.

Concerning the understanding of the systematics proposed in this paper, simulation fulfilled its role of exemplifying the Systematic for Process Improvement Using Cyber-Physical Systems and Toyota Kata in a simulated company. In this specific case, there may be a double interpretation when using the SIMIO® software. If the information about the value flow were acquired from a natural process and fed into the software, creating a Cyber-Physical System can help organizations visualize their process flow and simulate a future state with improvements. Thus, the effect of the changes can be evaluated before they are implemented on the shop floor.

Finally, we conclude that the Toyota Kata approach provides a managing structure that can be used to develop the Cyber-Physical System of an organization and improve its processes with simulation and a connected production system. For future works, we recommend applying the systematic developed in a natural environment to understand better how it behaves and what improvements and refinements should be made.

References

1. Kolberg, D., Knobloch, J., Zuhlke, D.: Towards a Lean automation interface for workstations. *International Journal of Production Research*, vol. 55, pp. 2845-2856 (2017).
2. Kolberg, D., Zuhlke, D.: Lean Automation enabled by Industry 4.0 Technologies. *15th IFAC Symposium on Information Control Problems in Manufacturing*, vol. 28, pp. 1870-1875 (2015)
3. Wagner, T., Herrmann, C., Thiede, S.: Identifying target-oriented Industrie 4.0 potentials in Lean automotive electronics value streams. *51st CIRP Conference on Manufacturing Systems*, vol 71, pp. 1003-1008 (2018).
4. Davies, R., Coole, T., Smith, A.: Review of socio-technical considerations to ensure successful implementation of Industry 4.0. *27th International Conference on Flexible Automation and Intelligent Manufacturing*, vol. 11, pp.1288-1296 (2017).
5. D'aquino, S. F., Santos, T. M., Silva, L. J. S., Forcellini, F. A.: Uma proposta de dinâmica Lean utilizando a abordagem Kata de Melhoria e Kata de Coaching. *V Congresso de Sistemas Lean*. Florianópolis, SC, pp. 1025-1050, (2015).
6. Rother, M.: *Toyota Kata: Managing people for improvement, adaptiveness, and superior results*. New York, NY: McGraw Hill, (2010).
7. Ferenhof, H. A., Fernandes, R. F.: Desmistificando a revisão de literatura como base para redação científica: Método SSF. *ACB*, vol. 21, n. 3 (2016).
8. Goode W. J., Hatt P. K., *Métodos em pesquisa social*. 5a ed. São Paulo: Companhia Editora Nacional, (1979).
9. Yin, R.: *Estudo de caso: planejamento e métodos*. 2a ed. Porto Alegre. Bookman, (2001).
10. Ruiz, N.: An intelligent simulation environment for manufacturing systems. *Computers & Industrial Engineering*, vol. 76. Supplement C, pp. 148–168 (2014).
11. Centeno, M.A., Carrillo, M.: Challenges of Introducing Simulation as a Decision-Making Tool. *Proceedings of the 2001 Winter Simulation Conference*, (2001).
12. Khan, A.; Turowski, K.: A perspective on Industry 4.0. From challenges to opportunities in production systems. *TBD 2016 – International Conference on Internet of Things and Big Data*, (2016).
13. Atzori, L., Iera, A., Morabito, G.: The internet of things: a survey. *Computer Networks*, vol. 54, pp. 2787-2805, (2010).
14. Bauer, H., Brandl, F., Lock, C.; Reinhart, G.: Integration of Industrie 4.0 in Lean Manufacturing Learning Factories. *8th International CIRP Conference on Learning Factories*, vol. 23, pp. 147-152 (2018).
15. Dombrowski, U., Richter, T., Krenkel, P.: Interdependencies of Industrie 4.0 & Lean Production Systems: A Use Cases Analysis. *Procedia Manufacturing*. *Procedia Manufacturing*, vol. 11, pp. 1061–1068 (2017).
16. Prinz, C., Kreggenfeld, N., Kuhlenkötter, B.: Lean meets Industrie 4.0 - A practical approach to interlink the method world and cyber-physical world. *8th International CIRP Conference on Learning Factories*, vol. 23, pp. 21-23, (2018).
17. Wagner, T., Herrmann, C., Thiede, S.: Identifying target-oriented Industrie 4.0 potentials in Lean automotive electronics value streams. *51st CIRP Conference on Manufacturing Systems*, vol. 72, pp. 1003-1008, (2018).
18. Hartmann, L., Meudt, T., Seifermann, S., Metternich, J.: Value stream method 4.0: Holistic method to analyse and design value streams in the digital age. *6th CIRP Global Web Conference*, vol. 78, pp. 249-254, (2018).

19. Lugert, A., Völker, K., Winkler, H.: Dynamization of Value Stream Management by technical and managerial approach. 51st CIRP Conference on Manufacturing Systems, vol. 72, pp. 701-706, (2018).
20. Leyh, C., Martin, S., Schaffer, T.: Industry 4.0 and Lean Production-A matching relationship? An analysis of selected Industry 4.0 models. Proceedings of the 2017 Federated Conference on Computer Science and Information Systems, pp. 989-993, (2017).
21. Tamás, P., Iilés, B.: Process improvement trends for manufacturing systems in industry 4.0. Academic Journal of Manufacturing Engineering, vol. 14, pp119 – 125, (2016).
22. Stehling, M., Schmiedinger, T., Kohlegger, M.: Why Robots do not matter! Using Digital Twin and Augmented Learning for Continuous Improvement in the context of Manufacturing. I-Know Conference, (2017).
23. Veres, C., Marian, L., Monica, S., Al-Akel, K., Hosu, D.: Industry 4.0 Implementation Model: Taking Steps Towards Digitization. Performance Management or Management Performance. pp 503 – 510, (2018).
24. Uriarte, A., Ng, A., Moris, M. U.: Supporting the lean journey with simulation and optimization in the context of Industry 4.0. Procedia Manufacturing, vol. 25, pp 586 – 593, (2018).
25. Villalba-Diez, J., Zheng, X., Schmidt, D., Molina, M.: Characterization of industry 4.0 lean management problem-solving behavioral patterns using EEG sensors and deep learning. Sensors, vol. 19, (2019).
26. Werner, S. M., Ferenhof, H. A., Forcellini, F. A.: Utilização da abordagem Toyota Kata para o ensino de Lean, com base em um ambiente simulado. VIII Congresso Brasileiro de Engenharia de Produção. Ponta Grossa, PR, (2018).
27. Bonamigo A., Paimell F. A., Arbugeri L. A.: Implementação do VSM por meio do conceito Toyota Kata. In: VII Congresso Brasileiro de Engenharia de Produção, Ponta Grossa, (2017)
28. Tovoinen T., Continuous innovation: Combining Toyota Kata and TRIZ for sustained innovation, Procedia Engineering, vol. 131, pp. 963-974, 2015.
29. Casten M.H., Plattenberger J., Barley J.M., Grier C.: Construction Kata: Adapting Toyota Kata to a lean construction project production system. In: 21st Annual Conference of the International Group for Lean Construction, Fortaleza, pp. 964-973, (2013).
30. Tillmann P., Ballard G., Tommelein I., A mentoring approach to implement lean construction. In: 22nd Annual Conference of the International Group for Lean Construction, Oslo, pp. 1283-1293 (2014).
31. Tartas D.: Uma proposta lean para o setup rápido de leitos hospitalares com base na abordagem Toyota Kata. Masters Dissertation (Production Engineering), Santa Catarina Federal University, (2017).
32. D'aquino S., F.: Proposta de modelo de referência para o processo de gestão de leitos hospitalares Masters Dissertation (Production Engineering), Santa Catarina Federal University, (2017).
33. Werner S., M.: Modelo para a gestão do processo de altas hospitalares. Masters Dissertation (Production Engineering), Santa Catarina Federal University, (2017).
34. Shahabuddin, N., Probert, D., Phaal, R., Plants, K.: Representing and approaching complex management issues: Part 1 – Role and Definition. Centre for Technology Management (CTM) Working Paper (1999).
35. Heim, J.A. Integrating distributed simulation objects. In: Proc. of the 1997. Winter Simulation Conference. pp. 532–538 (1997).
36. Ruiz, N. An intelligent simulation environment for manufacturing systems. Computers & Industrial Engineering, v. 76, n. Supplement C, p. 148–168, 2014.
37. Centeno, M.A., Carrillo, M. Challenges of Introducing Simulation as a Decision Making Tool. Proceedings of the 2001 Winter Simulation Conference, 2001.