



HAL
open science

Completeness of Graphical Languages for Mixed State Quantum Mechanics

Titouan Carette, Emmanuel Jeandel, Simon Perdrix, Renaud Vilmart

► **To cite this version:**

Titouan Carette, Emmanuel Jeandel, Simon Perdrix, Renaud Vilmart. Completeness of Graphical Languages for Mixed State Quantum Mechanics. *ACM Transactions on Quantum Computing*, 2021, *ACM Transactions on Quantum Computing*, 2 (4), pp.1-28. 10.1145/3464693 . hal-04082921

HAL Id: hal-04082921

<https://inria.hal.science/hal-04082921v1>

Submitted on 26 Apr 2023

HAL is a multi-disciplinary open access archive for the deposit and dissemination of scientific research documents, whether they are published or not. The documents may come from teaching and research institutions in France or abroad, or from public or private research centers.

L'archive ouverte pluridisciplinaire **HAL**, est destinée au dépôt et à la diffusion de documents scientifiques de niveau recherche, publiés ou non, émanant des établissements d'enseignement et de recherche français ou étrangers, des laboratoires publics ou privés.

Completeness of Graphical Languages for Mixed State Quantum Mechanics

Titouan Carette¹, Emmanuel Jeandel¹, Simon Perdrix¹, and
Renaud Vilmart²

¹Université de Lorraine, CNRS, Inria, LORIA, F 54000 Nancy

²Université Paris-Saclay, CNRS, LRI, 91405, Orsay

Abstract

There exist several graphical languages for quantum information processing, like quantum circuits, ZX-calculus, ZW-calculus, etc. Each of these languages forms a \dagger -symmetric monoidal category (\dagger -SMC) and comes with an interpretation functor to the \dagger -SMC of finite dimensional Hilbert spaces. In recent years, one of the main achievements of the categorical approach to quantum mechanics has been to provide several equational theories for most of these graphical languages, making them complete for various fragments of pure quantum mechanics.

We address the question of how to extend these languages beyond pure quantum mechanics, in order to reason about mixed states and general quantum operations, i.e., completely positive maps. Intuitively, such an extension relies on the axiomatisation of a *discard* map which allows one to get rid of a quantum system, an operation which is not allowed in pure quantum mechanics.

We introduce a new construction, the *discard construction*, which transforms any \dagger -symmetric monoidal category into a symmetric monoidal category equipped with a discard map. Roughly speaking this construction consists in making any isometry causal.

Using this construction, we provide an extension for several graphical languages that we prove to be complete for general quantum operations. However, this construction fails for some fringe cases like Clifford+T quantum mechanics, as the category does not have enough isometries.

Acknowledgements

This work is funded by ANR-17-CE25-0009 SoftQPro, ANR-17-CE24-0035 Van-QuTe, PIA-GDN/Quantex, and LUE/UOQ. This research is also supported by the project NEASQC funded from the European Union's Horizon 2020 research and innovation programme (grant agreement No 951821).

1 Introduction

Graphical languages used for quantum information can be formalised through the notion of string diagrams for symmetric monoidal categories [Sel10]. Qubits are represented by wires, and morphisms by components where some wires go in, and some others go out, just as in quantum circuits (which are actually a particular case of symmetric monoidal category), and where these graphical elements can be composed either in sequence (usual composition) or in parallel (tensor product). They usually come with an additional structure, a contravariant functor called dagger.

Quantum circuits and the ZX-calculus [CD11] are examples of graphical languages for quantum mechanics and quantum computing. Some variants of the ZX-calculus have been introduced more recently, like the ZW-calculus [Had15] and the ZH-calculus [BK19]. All these languages are defined using generators (elementary gates) and come with an interpretation functor which associates to any diagram a pure quantum evolution, i.e., a morphism in the category of Hilbert spaces. Given a graphical language, there are generally several ways to represent a quantum evolution. Thus a graphical language is also equipped with an equational theory which allows to transform a diagram into another equivalent diagram. A fundamental property, which is generally hard to prove, is the completeness of the language: given two diagrams representing the same quantum evolution, one can be turned into the other using only the transformation rules in the theory.

The languages considered have usually been built so as to be able to represent pure quantum evolutions, i.e., isolated quantum systems which do not interact with the environment. The language is called *universal* for pure quantum mechanics if it can represent all such systems. The hardness of the completeness problem, as well as constraints given by the complexity to physically achieve some gates with error-correction, focused the research on some restrictions of the languages. Finite presentations for quantum circuits were shown to be complete for some restrictions – namely Clifford [Sel15], one-qubit Clifford+T [MA08], two-qubit Clifford+T [SB15], CNot-dihedral [ACR18] –, however none of these restrictions are universal, nor approximately universal. Regarding the ZX-calculus, completeness results exist for non-universal restrictions of the ZX-calculus [Bac14a, Bac14b, CW18, DP14], but also for the many-qubit Clifford+T ZX-calculus [JPV18a], which was the first completeness result for an approximately universal fragment of the language. Then complete theories have been introduced for the universal ZX-calculus [HNW18, JPV18b, JPV19, Vil19] and ZW-calculus [Had17, HNW18]. The completeness of the graphical languages for pure quantum mechanics is one of the main achievements of the categorical approach to quantum mechanics, and is the cornerstone for the application of this formalism in many areas of quantum information processing. The ZX-calculus already proved to be useful for quantum information processing [CK17] (e.g. measurement-based quantum computing [Dun13, DP10, Hor11], quantum codes [dBH17, CKR⁺16, DG18, DL14], circuit optimisation [DKPvdW19], foundations [BD14, DD16], etc.). Moreover the ZX-calculus has been used in

practice, notably in the software packages: Quantomatic [KZ15] and PyZX [KvdW18].

The existence of complete graphical languages beyond pure quantum mechanics for more general, not necessarily pure, quantum evolutions is an open question that we address in the present paper.

While pure quantum evolutions correspond to linear maps over Hilbert spaces, probability distributions over quantum states as well as some quantum evolutions like discarding a quantum system can be represented, following the von Neumann approach, by means of density matrices and completely positive maps. The category of completely positive maps has been already studied [Sel04], and in particular the connections between the pure and the von Neumann approaches is a central question in categorical quantum mechanics. Selinger introduced a construction called CPM to turn a category for pure quantum mechanics into a category for density matrices and completely positive maps [Sel07]. Another approach to relate pure quantum mechanics to the general one is the notion of environment structure [Coe08, CH16, CP12]. The notion of *purification* is central in the definition of environment structure. The CPM-construction and the environment structure approaches have been proved to be equivalent [CH16]. In [CK17] completely positive maps are represented by doubling the wires, this can be seen roughly as another way to present the CPM-construction.

In terms of graphical languages, the environment structure approach cannot be used in a straightforward way to extend a graphical language beyond pure quantum mechanics. Roughly speaking the environment structure approach provides second order axioms which associate with any equation on arbitrary (non necessarily pure) evolutions an equivalent equation on pure evolutions. Such a second order axiom cannot be easily handled by an equational theory on diagrams. Regarding the CPM-construction, the main property which has been exploited in [CK17] is that $\text{CPM}(\mathbf{C})$ is essentially a subcategory of \mathbf{C} . Thus one can use a graphical language which has been designed for \mathbf{C} in order to represent morphisms in $\text{CPM}(\mathbf{C})$: Given a complete graphical language for \mathbf{C} , we can use a subset of the pure diagrams to represent the evolutions in $\text{CPM}(\mathbf{C})$. The main caveat of this approach is that this subset is not necessarily closed under the equational theory on pure diagrams, and as a consequence does not provide a complete graphical language for $\text{CPM}(\mathbf{C})$.

Our contributions. In [HS19], it was shown that the category \mathbf{CPTPM} of completely positive trace-preserving maps is the universal monoidal category with a terminal unit and a functor from the category of isometries. We build upon this result by introducing a new construction, the *discard construction*, which transforms any \dagger -symmetric monoidal category into a symmetric monoidal category equipped with a discard map. Roughly speaking this construction consists of making any isometry causal. Indeed, in quantum mechanics, the isometries (linear maps U such $U^\dagger \circ U = I$) are known to be causal, i.e., applying U and then discarding the subsystem on which it has been applied is equivalent to discarding the subsystem straightaway. Specifically, the discard construction

proceeds as follows: first the discard is added to the subcategory of isometries, making the unit of the tensor a terminal object in this subcategory, as pointed out in [HS19]. Then the discard construction is obtained as the pushout of the resulting category and the original one.

We show that the discard construction does not always produce an environment structure for the original category, and thus is not equivalent to the CPM construction. We show that a necessary and sufficient condition for the two constructions to be equivalent is that the initial category has enough isometries. We show that most of the categories usually used in the context of categorical quantum mechanics, like **FHilb**, **Stab** or **Rel**, do have enough isometries. However **Clifford+T** does not.

Finally, we show that the discard construction provides a simple recipe to extend graphical languages beyond pure quantum mechanics. We provide an extension for several graphical languages that we prove to be complete for general quantum operations.

Structure of the paper. In Section 2, we review some categorical notions used in categorical quantum mechanics. Section 3 is dedicated to the definition of the discard construction and the relation with the CPM construction. Finally, in Section 4 we use the discard construction to extend the ZX-calculus to make it complete for general (not necessarily pure) quantum evolutions. The construction is also applied to other graphical languages.

2 Background

2.1 Dagger symmetric monoidal categories

To avoid any size issue, all our categories are small. The homset of a category \mathbf{C} will be denoted $\mathbf{C}[A, B]$. For simplicity, all monoidal categories considered in the following will be *strict*. Recall that a *strict symmetric monoidal category* (SMC) \mathbf{C} is a category together with a tensor product bifunctor $\otimes : \mathbf{C} \times \mathbf{C} \rightarrow \mathbf{C}$, a unit object I such that $A \otimes I = I \otimes A = A$ and $A \otimes (B \otimes C) = (A \otimes B) \otimes C$, and a symmetry natural isomorphism: $\sigma_{A,B} : A \otimes B \rightarrow B \otimes A$ satisfying $\sigma_{A,I} = 1_A$, $\sigma_{A,B \otimes C} = (1_B \otimes \sigma_{A,C}) \circ (\sigma_{A,B} \otimes 1_C)$, and $\sigma_{A,B} \circ \sigma_{B,A} = 1_{B \otimes A}$. A *prop* is an SMC whose set of objects is freely generated by one object under the tensor product. The homomorphisms of strict symmetric monoidal categories are called strict symmetric monoidal functors. These are functors $F : \mathbf{C} \rightarrow \mathbf{D}$ which preserves unit, tensors and symmetries.

We will use *string diagram* notations for SMCs where morphisms are described as boxes and

$$g \circ f := \begin{array}{|c|} \hline f \\ \hline g \\ \hline \end{array} \quad f \otimes g := \begin{array}{|c|} \hline f \\ \hline g \\ \hline \end{array} \quad 1_A := |^A \quad 1_I := \boxed{} \quad \sigma_{A,B} := \begin{array}{c} \diagdown \quad \diagup \\ \diagup \quad \diagdown \end{array}$$

A \dagger -SMC \mathbf{C} is an SMC with an i.o.o. (identity on objects) involutive and contravariant SMC-functor $(\cdot)^\dagger : \mathbf{C} \rightarrow \mathbf{C}$. That is, every morphism $f : A \rightarrow B$ has a dagger $f^\dagger : B \rightarrow A$ such that $f^{\dagger\dagger} = f$. Moreover the dagger respects the

symmetries $\sigma_{A,B}^\dagger = \sigma_{B,A}$. The dagger is a central notion in categorical quantum computing and can be used to define specific properties of morphisms:

Definition 1. $f : A \rightarrow B$ is an isometry if $f^\dagger \circ f = 1_A$, i.e., $\begin{array}{c} \boxed{f} \\ \boxed{f^\dagger} \end{array} = \left| \right.$.

In this paper, most of the categories considered are furthermore compact closed: A dagger compact category (\dagger -CC) is a \dagger -SMC where every object A has a dual object A^* such that for all objects A , there are two morphisms

$A \cup A^* : A \otimes A^* \rightarrow I$ and $A^* \cap A : I \rightarrow A^* \otimes A$ satisfying $A \left| \begin{array}{c} \cup \\ A^* \end{array} \right. \cap = \left| \right. A$,

$A^* \cap \left| \begin{array}{c} \cup \\ A \end{array} \right. A^* = \left| \right. A^*$ and $(A \cup A^*)^\dagger = A^* \cap A$. In this paper all examples are self dual, i.e., $A^* = A$.

2.2 Examples

We will consider two kinds of SMCs in this paper: the categories of quantum evolutions and graphical languages.

Quantum evolutions. Pure quantum evolutions correspond the category of Hilbert spaces. We will consider several of its subcategories: **FHilb** is the category of finite dimensional Hilbert spaces whose objects are \mathbb{C}^n and morphisms are linear maps. Its tensor is the usual tensor product of vector spaces and its dagger is the adjoint with respect to the usual scalar product. It is the mathematical model for pure quantum mechanics. In quantum information processing, quantum data is usually carried by qubits, hence **Qubit** is the full subcategory of **FHilb** with objects of the form \mathbb{C}^{2^n} . **Stab** is the subcategory of **Qubit** which is finitely generated by the Clifford operators: H, S, CNot, the state $|0\rangle$, the projector $\langle 0|$, and the scalar 2 where:

$$H = \frac{1}{\sqrt{2}} \begin{pmatrix} 1 & 1 \\ 1 & -1 \end{pmatrix} \quad S = \begin{pmatrix} 1 & 0 \\ 0 & i \end{pmatrix} \quad \text{CNot} = \begin{pmatrix} 1 & 0 & 0 & 0 \\ 0 & 1 & 0 & 0 \\ 0 & 0 & 0 & 1 \\ 0 & 0 & 1 & 0 \end{pmatrix} \quad |0\rangle = \begin{pmatrix} 1 \\ 0 \end{pmatrix} \quad \langle 0| = (1 \ 0)$$

Those are amongst the most commonly used gates in quantum computation (see [NC10] for details). **Clifford+T** is the same as **Stab** but with the additional generator $T = \begin{pmatrix} 1 & 0 \\ 0 & e^{i\frac{\pi}{4}} \end{pmatrix}$. The morphisms of **Clifford+T** are exactly the matrices with entries in the ring $\mathbb{Z}[i, \frac{1}{\sqrt{2}}]$ [JPV18a]. Contrary to **Stab**, **Clifford+T** is *approximately universal* in the sense that $\forall n, m \in \mathbb{N}, \forall f \in \mathbf{Qubit}[\mathbb{C}^{2^n}, \mathbb{C}^{2^m}]$ and $\forall \epsilon > 0$, there exists $g \in \mathbf{Clifford+T}[\mathbb{C}^{2^n}, \mathbb{C}^{2^m}]$ such that $\|f - g\| < \epsilon$. Note that this definition is weaker than the usual meaning of approximate universality for quantum circuits where it is required that unitaries can be approximated by unitaries. **FHilb**, **Qubit**, **Clifford+T**, and **Stab** are all \dagger -CC. Note that **Qubit**, **Clifford+T**, and **Stab** are props, but **FHilb** is not. Technically, they are only equivalent to props, but we will assume that we work with the corresponding skeletal categories. Note that the skeletal category of **FHilb** is the self-dual compact closed prop of complex matrices.

Probability distributions over pure quantum states as well as some quantum evolutions like discarding a quantum system are not *pure* but can be represented, following the von Neumann approach, by means of density matrices and completely positive maps. Let **CPM** be the category of completely positive maps of finite dimension whose objects are \mathbb{C}^n and $\mathbf{CPM}[\mathbb{C}^n, \mathbb{C}^m] = \{U : \mathbb{C}^{n \times n} \rightarrow \mathbb{C}^{m \times m} \mid U \text{ is a completely positive linear map}\}$. Similarly to the pure case, one can define various subcategories of **CPM**. Note that it can be achieved by the CPM construction described in the next section.

Graphical languages. The second kind of categories we are considering in this paper are graphical languages. They are props which come with an interpretation defining their semantics. They can be presented by generators and relations, see [Zan15] and [BCR17] for a detailed discussion.

Definition 2. A graphical language \mathcal{G} is a prop presented by a set of generators Σ and a set of equations E together with a monoidal category S and a function $\llbracket \cdot \rrbracket : \Sigma \rightarrow \text{hom}(S)$ called the interpretation of \mathcal{G} in S . \mathcal{G} is said to be sound if $\llbracket \cdot \rrbracket$ defines a strict symmetric monoidal functor $\llbracket \cdot \rrbracket : \mathcal{G} \rightarrow S$, and universal (resp. complete) when this functor is full (resp. faithful).

The ZX-, ZW- and ZH-calculi or the quantum circuits are examples of such categories with semantics in **Qubit**.

2.3 Environment structures and CPM-construction

Connecting the Hilbert approach – for pure quantum mechanics – and the von Neumann approach – for open systems – is a central question in categorical quantum mechanics. Selinger pointed out that any \dagger -CC for pure quantum mechanics can be turned into a category for density matrices and completely positive maps via the CPM construction [Sel07]:

Definition 3. Given a \dagger -CC \mathbf{C} , let $\mathbf{CPM}(\mathbf{C})$ be the \dagger -CC with the same objects

as \mathbf{C} such that $\mathbf{CPM}(\mathbf{C})[A, B] = \left\{ \begin{array}{c} A \\ \boxed{f} \\ B \end{array} \Big| \begin{array}{c} C \\ \boxed{f^*} \\ C^* \end{array} \Big| \begin{array}{c} A^* \\ B^* \end{array} \right\}, f \in \mathbf{C}[A, B \otimes C]$, where

$$\begin{array}{c} \boxed{g^*} \\ \Big| \\ B^* \end{array} \Big| \begin{array}{c} B \\ \boxed{g^\dagger} \\ A \end{array} \Big| \begin{array}{c} A^* \end{array} := \begin{array}{c} \begin{array}{c} \boxed{g^\dagger} \\ \Big| \\ A \end{array} \\ \Big| \\ B^* \end{array} \Big| \begin{array}{c} B \\ \boxed{g^*} \\ C^* \end{array} \Big| \begin{array}{c} A^* \end{array}.$$

Applying it to **FHilb** one obtains the category **CPM** of completely positives maps. The CPM construction can also be applied to **Qubit**, **Clifford+T**, and **Stab**. Note that the CPM-construction has been then extended to not necessarily compact categories [CH16].

Another approach to relate pure quantum mechanics to the general one is the notion of environment structure [Coe08, CH16, CP12]. The notion of *purification* is central in the definition of environment structure. Intuitively, it means that (1) there is a discard morphism for every object; (2) any morphism

can be purified, i.e., decomposed into a pure morphism followed by a discarding map, and (3) this purification is unique up to a certain equivalence relation. More formally:

Definition 4. An environment structure for a \dagger -CC \mathbf{C} is a CC $\overline{\mathbf{C}}$ with the same objects as \mathbf{C} , an i.o.o SMC-functor $\iota : \mathbf{C} \rightarrow \overline{\mathbf{C}}$ and for each object A a morphism $\underline{\underline{1}}_A : A \rightarrow I$ such that:

$$(1) \quad \underline{\underline{1}}_I = 1_I, \text{ and for all } A, B : \mathbf{C}, \underline{\underline{1}}_A \otimes \underline{\underline{1}}_B = \underline{\underline{1}}_{A \otimes B}.$$

(2) For all $f : A \rightarrow B$ in $\overline{\mathbf{C}}$, there is an $f' : A \rightarrow B \otimes X$ in \mathbf{C} such that:

$$\begin{array}{c} \boxed{f} \\ \hline \end{array} = \begin{array}{c} \boxed{\iota(f')} \\ \hline \underline{\underline{1}} \end{array}$$

(3) For any $f : A \rightarrow B \otimes X$ and $g : A \rightarrow B \otimes Y$ in \mathbf{C} : $f \sim_{\text{cp}} g \Leftrightarrow \begin{array}{c} \boxed{\iota(f)} \\ \hline \underline{\underline{1}} \end{array} =$

$$\begin{array}{c} \boxed{\iota(g)} \\ \hline \underline{\underline{1}} \end{array}$$

where the relation \sim_{cp} is defined as: $f \sim_{\text{cp}} g \Leftrightarrow \begin{array}{c} \boxed{f} \\ \hline \boxed{f^\dagger} \end{array} = \begin{array}{c} \boxed{g} \\ \hline \boxed{g^\dagger} \end{array}$

Note that \sim_{cp} is technically not a relation on morphisms but on tuples (A, B, X, f) with $f \in \mathbf{C}[A, B \otimes X]$: $(A, B, X, f) \sim_{\text{cp}} (C, D, Y, g)$ if $A = C, B = D$ and f, g satisfy the graphical condition represented above. By abuse of notation, we write $f \sim_{\text{cp}} g$, as the other components of the tuple will be usually obvious from context. We will do the same for our relation \sim_{iso} below.

CPM is actually an environment structure for the category **FHilb**, and more generally for any \dagger -CC \mathbf{C} , $\text{CPM}(\mathbf{C})$ is an environment structure for \mathbf{C} and conversely any environment structure for \mathbf{C} is equivalent to $\text{CPM}(\mathbf{C})$ [CH16]. Actually one can notice that $\text{CPM}(\mathbf{C})[A, B]$ is nothing but the set of equivalence classes of \sim_{cp} .

The notion of environment structures has also been generalised to the non compact case [CH16]. Even if our construction does not require a compact structure, we chose here to focus on the compact case for two reasons. First, for now the relation of our construction with environment structures is only clear with this hypothesis. Second the \mathbf{CP}^∞ construction of [CH16] leads to a codiscrete category when applied on the subcategory of isometries in **FHilb**. This suggests that there might not be general connections between our construction and \mathbf{CP}^∞ .

3 The Discard Construction

We introduce a new construction, the *discard construction*, which consists in adding a discard map for every object of a \dagger -SMC, and thus intuitively trans-

forming a category for pure quantum mechanics into a category for general quantum evolutions.

Causality is a central notion in quantum mechanics which has been axiomatised using a discard map as follows [KU17]: $f : A \rightarrow B$ is *causal* if and only

if $\begin{array}{c} \downarrow \\ \boxed{f} \\ \downarrow \\ \perp \end{array} = \perp$. Amongst the pure quantum evolutions, the isometries are causal

evolutions. The discard construction essentially consists in making any isometry causal. Thus, whereas the CPM construction relies on completely positive maps and the environment structures on the concept of purification, the discard construction relies on causality.

3.1 Definition

We introduce the new construction in three steps. First, given a \dagger -SMC, one can consider its subcategory of isometries:

Definition 5. *Given a \dagger -SMC \mathbf{C} , \mathbf{C}_{iso} is the subcategory with the same objects as \mathbf{C} and isometries as morphisms, i.e., for all $A, B : \mathbf{C}$, $\mathbf{C}_{\text{iso}}[A, B] = \{f : \mathbf{C}[A, B], f^\dagger \circ f = 1_A\}$.*

Note that \mathbf{C}_{iso} is an SMC but usually not a \dagger -SMC. Any \dagger -SMC-functor $F : \mathbf{C} \rightarrow \mathbf{D}$ between two \dagger -SMC can be restricted to their subcategories of isometries leading to an SMC-functor $F_{\text{iso}} : \mathbf{C}_{\text{iso}} \rightarrow \mathbf{D}_{\text{iso}}$. Thus there is a restriction functor $\text{iso} : \dagger\text{-SMC} \rightarrow \text{SMC}$. Note that this functor preserves fullness and faithfulness. One always has an inclusion i.o.o. faithful SMC-functor: $i_{\text{iso}} : \mathbf{C}_{\text{iso}} \rightarrow \mathbf{C}$.

In quantum mechanics, isometries are causal evolutions, i.e., applying an isometry and then discarding all outputs is equivalent to discarding the inputs straight away. As pointed out in [HS19], adding discard maps to the category of isometries would make I a terminal object. Such a category is said to be *affine symmetric monoidal category* (ASMC). We define the affine completion of an SMC:

Definition 6. *Given an SMC \mathbf{C} , we define $\mathbf{C}^!$ as \mathbf{C} with an additional morphism $!_A : A \rightarrow I$ for each object $A : \mathbf{C}$. We denote the functor $i^! : \mathbf{C} \rightarrow \mathbf{C}^!$ which is strict monoidal and i.o.o. We further impose that $1_I = !_I$, and that for all $f : \mathbf{C}[A, B]$, $!_B \circ i^!(f) = !_A$. This makes I a terminal object in $\mathbf{C}^!$, and thus $\mathbf{C}^!$ is an ASMC.*

Note by the way that $!_A \otimes !_B = 1_I \circ (!_A \otimes !_B) = !_I \circ (!_A \otimes !_B) = !_A \otimes !_B$. Again given a functor $F : \mathbf{C} \rightarrow \mathbf{D}$, one can define a functor $F^! : \mathbf{C}^! \rightarrow \mathbf{D}^!$ by $F^!(!_A) = !_i(F(A))$ and $F^!(f) = i^!(F(f))$ for the other morphisms. In [HS19], Huot and Staton show that **CPTPM**, the category of completely positive trace preserving maps, is equivalent to $\mathbf{FHilb}_{\text{iso}}^!$, thus giving a characterization of it via a universal property. We extend this idea to non-trace preserving maps by proceeding to a locally affine completion of the subcategory of isometries.

We define the category \mathbf{C}^\neq as the pushout of \mathbf{C} and $\mathbf{C}_{\text{iso}}^!$:

Definition 7. Given a \dagger -SMC \mathbf{C} , \mathbf{C}^\neq is defined as the pushout in the category of a symmetric monoidal categories:

$$\begin{array}{ccc} \mathbf{C}_{\text{iso}} & \xleftarrow{i_{\text{iso}}} & \mathbf{C} \\ \downarrow i^! & & \downarrow \iota_{\mathbf{C}} \\ \mathbf{C}_{\text{iso}}^! & \xrightarrow{\iota_{\mathbf{C}_{\text{iso}}^!}} & \mathbf{C}^\neq \end{array}$$

The existence of this pushout follows from the fact that the forgetful functor from strict symmetric monoidal categories to categories $\mathbf{StrictSymMonCat} \rightarrow \mathbf{Cat}$ preserves coequalizers, and from [BW85, Theorem 9.3.9]. As all our functors are i.o.o., we can also describe it simply combinatorially. The objects of \mathbf{C}^\neq are the same as \mathbf{C} . Its morphisms are equivalence classes generated by formal composition and tensoring of morphisms in $\mathbf{C}_{\text{iso}}^!$ and \mathbf{C} . The equivalence relation is generated by the equations of both categories augmented with equations $i^!(f) = i_{\text{iso}}(f)$ for all f in \mathbf{C}_{iso} . The functors $\iota_{\mathbf{C}}$ and $\iota_{\mathbf{C}_{\text{iso}}^!}$ are the natural ways to embed \mathbf{C} and $\mathbf{C}_{\text{iso}}^!$. We will see those formal compositions as string diagrams whose components are morphisms of \mathbf{C} and $\mathbf{C}_{\text{iso}}^!$ wired to each other. Two diagrams represent the same morphism if we can rewrite one into the other applying the equations of both categories and $i^!(f) = i_{\text{iso}}(f)$ for all f in \mathbf{C}_{iso} . This forms a well defined SMC.

Since the only morphisms in \mathbf{C}_{iso} which are not identified with the morphisms of \mathbf{C} are those that contain $!_A$, we can see \mathbf{C}^\neq as \mathbf{C} augmented with discard maps which delete isometries. A more detailed description of pushouts of props can be found in [Zan15].

Definition 8. The discard map on an object A is defined in \mathbf{C}^\neq by $\frac{A}{\perp} := \iota_{\mathbf{C}_{\text{iso}}^!}(!_A)$.

Note, that for any isometry $f : A \rightarrow B$ in \mathbf{C}^\neq , $\boxed{f} = \frac{\perp}{\perp}$, thus any isometry is causal.

3.2 Relation to environment structures and CPM

In order to compare the \mathbf{C}^\neq construction with environment structures and the CPM construction we need to study in detail the purification process in \mathbf{C}^\neq . First notice that any morphism of \mathbf{C}^\neq admits a purification:

Lemma 8.1. Let \mathbf{C} be a \dagger -SMC. For all $f : \mathbf{C}^\neq[A, B]$, there is an $X : \mathbf{C}$ and an $f' : \mathbf{C}[A, B \otimes X]$ such that $\boxed{f} = \frac{\perp}{\perp} \circ \iota_{\mathbf{C}}(f')$.

The proof is in the appendix on page 24.

The purification needs not be unique, however it satisfies an essential uniqueness condition. To state it we define the relation \sim_{iso} :

Definition 9. Let \mathbf{C} be a \dagger -SMC, and two morphisms $f : A \rightarrow B \otimes X$, $g : A \rightarrow B \otimes Y$. $f \sim_{\text{iso}} g$ if there are two isometries $u : X \rightarrow Z$ and $v : Y \rightarrow Z$, such

$$\text{that } \begin{array}{c} \boxed{f} \\ \hline \boxed{u} \end{array} = \begin{array}{c} \boxed{g} \\ \hline \boxed{v} \end{array}.$$

Note that the relation \sim_{iso} is not transitive, thus we consider \sim_{iso}^+ its transitive closure to make it an equivalence relation. It is easy to show that if $f \sim_{\text{iso}}^+ g$ then f and g purify the same morphism of \mathbf{C}^\neq . The converse is also true:

Lemma 9.1. For all $f : A \rightarrow B \otimes X$ and $g : A \rightarrow B \otimes Y$: $f \sim_{\text{iso}}^+ g \Leftrightarrow \begin{array}{c} \boxed{\iota_{\mathbf{C}}(f)} \\ \hline \underline{\quad} \end{array} = \begin{array}{c} \boxed{\iota_{\mathbf{C}}(g)} \\ \hline \underline{\quad} \end{array}$

The proof is in the appendix on page 24.

So the purification is unique up to \sim_{iso}^+ . Lemma 9.1 also gives an alternative definition of \mathbf{C}^\neq which relates more easily to the CPM construction. It is the same construction as CPM with \sim_{cp} replaced by \sim_{iso}^+ . In other words $\mathbf{C}^\neq[A, B]$ is the set of equivalent classes of \sim_{iso}^+ .

As we have introduced a new discard construction, a natural question is whether \mathbf{C}^\neq is an environment structure for \mathbf{C} . To be an environment structure, three conditions are required. The first two are satisfied: \mathbf{C}^\neq has a discard morphism for every object, and every morphism can be purified. The third one is the uniqueness of the purification: according to the definition of the environment structures, f and g purify the same morphism if and only if $f \sim_{\text{cp}} g$ whereas according to Lemma 9.1, f and g purify the same morphism if and only if $f \sim_{\text{iso}}^+ g$. As a consequence \mathbf{C}^\neq is an environment structure for \mathbf{C} if and only if $\sim_{\text{cp}} = \sim_{\text{iso}}^+$. It turns out that one of the inclusions is always true:

Lemma 9.2. For any \dagger -SMC category \mathbf{C} , we have $\sim_{\text{iso}}^+ \subseteq \sim_{\text{cp}}$.

The proof is in the appendix on page 26.

As a consequence, if $\sim_{\text{cp}} \neq \sim_{\text{iso}}^+$, it means that there are some morphisms f, g that are equal in \sim_{cp} but cannot be proved equal in \sim_{iso}^+ . Intuitively it means the category has not enough isometries to prove those terms equal, which leads to the following definition:

Definition 10. A \dagger -SMC category \mathbf{C} has enough isometries if the equivalence relations \sim_{cp} and \sim_{iso}^+ of \mathbf{C} are equal.

Lemma 10.1. Given a \dagger -SMC \mathbf{C} , the following properties are equivalent:

1. \mathbf{C} has enough isometries;
2. \mathbf{C}^\neq is an environment structure for \mathbf{C} ;

3. $\mathbf{C}^\sharp \simeq \text{CPM}(\mathbf{C})$.

The proof is in the appendix on page 26.

Note that if \mathbf{C} has enough isometries, the discard construction provides a definition of $\text{CPM}(\mathbf{C})$ via a universal property. This gives a more direct way to build the environment, avoiding to deal with the equivalence classes of the CPM construction.

Remark: Let's focus for a moment on the category $\text{CausalCPM}(\mathbf{C})$ of causal maps, that is the subcategory of maps cancelled by the discards in $\text{CPM}(\mathbf{C})$. We have that: $\sim_{\text{cp}} \subseteq \sim_{\text{iso}}^+ \Rightarrow \mathbf{C}_{\text{iso}}^! \simeq \text{CausalCPM}(\mathbf{C})$. In fact by Lemma 10.1, $\text{CPM}(\mathbf{C}) \simeq \mathbf{C}^\sharp$, and then the subcategory $\text{CausalCPM}(\mathbf{C})$ is equivalent to the subcategory of maps cancelled by the discards in \mathbf{C}^\sharp which is equivalent to $\mathbf{C}_{\text{iso}}^!$. $\text{CausalCPM}(\mathbf{FHilb})$ being exactly \mathbf{CPTPM} , we have recovered the result of [HS19].

3.3 Examples

We consider the usual subcategories of \mathbf{FHilb} used for pure quantum mechanics and show in each case whether the discard construction produces an environment structure or not. First of all, thanks to the Stinespring dilation theorem, \mathbf{FHilb}^\sharp is not only an environment structure for \mathbf{FHilb} , but the relation \sim_{iso} is also transitive in this case:

Proposition 10.1. \mathbf{FHilb}^\sharp is an environment structure for \mathbf{FHilb} . Furthermore $\sim_{\text{iso}}^+ = \sim_{\text{iso}}$.

The proof is in the appendix on page 27.

This property is also true of the category \mathbf{Rel} of sets and relations, giving an alternative description of the category $\text{CPM}(\mathbf{Rel})$ studied in [Mar15] and [Gog15].

Proposition 10.2. \mathbf{Rel}^\sharp is an environment structure for \mathbf{Rel} . Furthermore $\sim_{\text{iso}}^+ = \sim_{\text{iso}}$.

The proof is in the appendix on page 27.

When dealing with graphical languages we will be more interested in the full subcategory \mathbf{Qubit} of \mathbf{FHilb} :

Proposition 10.3. \mathbf{Qubit}^\sharp is an environment structure for \mathbf{Qubit} .

The proof is in the appendix on page ??.

Note that in general, the property of having enough isometries does not transfer to full subcategories: If \mathbf{D} is a full subcategory of \mathbf{C} , we might have $f \sim_{\text{iso}}^+ g$ in \mathbf{C} but $f \not\sim_{\text{iso}}^+ g$ in \mathbf{D} . This could happen for two reasons: First the chain of intermediate morphisms that prove that $f \sim_{\text{iso}}^+ g$ might live outside of \mathbf{D} . Second, the isometries that “prove” that $f \sim_{\text{iso}}^+ g$ in \mathbf{C} might have codomain outside of \mathbf{D} .

If our category is not a full subcategory, then everything falls apart, and finding conditions that guarantee that \mathbf{C}^\neq is an environment structure for \mathbf{C} is not easy.

For subcategories of **Qubit**, necessary conditions can be given. This category has the peculiarity that \cdot^* is the identity on objects and that $f^{**} = f$ for all morphisms (\cdot^* maps a matrix to its conjugate matrix). In particular, for any state $\phi : I \rightarrow I \otimes X$, we have $\phi^* \sim_{\text{cp}} \phi$. Indeed $\begin{array}{c} \boxed{\phi} \quad \boxed{\phi^*} \\ \text{---} \end{array} = \begin{array}{c} \boxed{\phi^*} \quad \boxed{\phi} \\ \text{---} \end{array}$.

So a necessary condition for a subcategory of **Qubit** to behave nicely is that for all states ϕ , we have $\phi^* \sim_{\text{iso}}^+ \phi$. This is the case in **Stab**: Given a stabilizer state ϕ , there always exists a stabilizable unitary U s.t. $U\phi = \phi^*$. In fact:

Proposition 10.4. \mathbf{Stab}^\neq is an environment structure for **Stab**.

The main idea of the proof, found on page 28, is to use the map/state duality, and structural results about bipartite stabilizer states [AP05].

No such unitary exists in general in **Clifford+T**: For almost all states ϕ , there is no unitary U (and actually no morphism at all) s.t. $U\phi = \phi^*$. **Clifford+T** therefore has not got enough isometries:

Proposition 10.5. $(\mathbf{Clifford+T})^\neq$ is not an environment structure for **Clifford+T**. More precisely, there exists a state ϕ s.t. $\phi \sim_{\text{cp}} \phi^*$ but $\phi \not\sim_{\text{iso}}^+ \phi^*$. One can take for example $\phi = 1 + 2i$ (in this case ϕ is a state with no input and outputs, hence a scalar).

The proof is in the appendix on page 29.

Note that for all categories above, we have $\sim_{\text{iso}}^+ = \sim_{\text{iso}}$. That it holds in **Qubit** and **FHilb** is a consequence of the Witt extension theorem: Every isometry $f : A \rightarrow B$ is equal to a unitary $g : B \rightarrow B$ precomposed with a canonical embedding from A to B . It is well known in **Stab** and it is true in **Clifford+T** by [GS13, Lemma 5].

4 Application to the ZX-calculus and other graphical languages

We now focus on the behavior of interpretation functors with respect to the discard construction. The discard construction defines a functor $(\cdot)^\neq : \dagger\text{-SMC} \rightarrow \text{SMC}$. Indeed, given a \dagger -SMC functor F , F_{iso} and F_{iso}^\dagger uniquely define a functor F^\neq by pushout.

$$\begin{array}{ccccc}
 & & \mathbf{D}_{\text{iso}} & \xrightarrow{\quad} & \mathbf{D} \\
 & \nearrow F_{\text{iso}} & \downarrow & \nearrow F & \downarrow \\
 \mathbf{C}_{\text{iso}} & \xrightarrow{\quad} & \mathbf{C} & & \\
 \downarrow & & \downarrow & & \downarrow \\
 & \nearrow F_{\text{iso}}^\dagger & \mathbf{D}_{\text{iso}}^\dagger & \xrightarrow{\quad} & \mathbf{D}^\neq \\
 \mathbf{C}_{\text{iso}}^\dagger & \xrightarrow{\quad} & \mathbf{C}^\neq & \xrightarrow{F^\neq} &
 \end{array}$$

The following lemma and theorem are the main tools to apply the discard construction to graphical languages:

Lemma 10.2. *If F is faithful and if $F_{\text{iso}} : \mathbf{C}_{\text{iso}} \rightarrow \mathbf{D}_{\text{iso}}$ is full and surjective on objects, then $F(f) \sim_{\text{iso}}^+ F(g) \Rightarrow f \sim_{\text{iso}}^+ g$.*

Theorem 10.1. *Let \mathbf{C} and \mathbf{D} be two \dagger -SMCs and $F : \mathbf{C} \rightarrow \mathbf{D}$ a \dagger -SMC-functor. If F is faithful and if $F_{\text{iso}} : \mathbf{C}_{\text{iso}} \rightarrow \mathbf{D}_{\text{iso}}$ is full and surjective on objects, then $F^\neq : \mathbf{C}^\neq \rightarrow \mathbf{D}^\neq$ is faithful. If furthermore F is full then F^\neq is full and faithful.*

The proofs are in the appendix on pages 30 and 30.

Note that the hypothesis on F_{iso} is very strong, we want it to be surjective on objects as we do not want to lose even one isometry. If F is only required to be essentially surjective then our theorem holds only if the isomorphisms between objects are also unitary. In fact, the proper framework to express this condition would be to consider \dagger -categories and not categories as being fundamental in the spirit of [Kar19].

Reformulating for graphical languages this gives:

Corollary 10.1 (of Theorem 10.1). *Given a \dagger -CC \mathbf{C} with enough isometries, if \mathcal{G} is a \dagger -CC universal complete graphical language for \mathbf{C} then \mathcal{G}^\neq is a universal complete language for $\text{CPM}(\mathbf{C})$.*

This provides a general recipe. We start with a universal complete graphical language \mathcal{G} . We build \mathcal{G}^\neq , by Theorem 10.1, $\llbracket \cdot \rrbracket^\neq : \mathcal{G}^\neq \rightarrow \mathbf{C}^\neq$ is full and faithful. Furthermore $\mathbf{C}^\neq \simeq \text{CPM}(\mathbf{C})$. \mathcal{G}^\neq as a prop can be presented by adding one new generator $\underline{\underline{=}}$ to the signature Σ and one equation for each isometry of \mathcal{G} . Note that we add one equation for each isometry in \mathcal{G} and that is all, there is no recursive process involved. In general, if one is provided with a spanning set of the isometries, the number of equations can be drastically reduced. We just need one equation for each element of this set. We then obtain a universal complete graphical language. For example if one finds an axiomatisation of quantum circuits complete for $\mathbf{Qubits}_{\text{iso}}$ then the discard construction will apply since $\mathbf{Qubits}_{\text{iso}}$ obviously has enough isometries.

We will now briefly review the ZX-calculus and some of its twin languages. They are all universal and complete for subcategories of \mathbf{Qubit} . Each time we will apply the recipe with a well chosen spanning set and provide the additional axioms involving $\underline{\underline{=}}$.

4.1 The ZX-calculus

The ZX-calculus was introduced in [CD11] by Coecke and Duncan for pure quantum evolutions. It is a \dagger -compact prop generated by:

$$R_Z^{(n,m)}(\alpha) : n \rightarrow m :: \begin{pmatrix} \cdot \\ \cdot \\ \dots \\ \cdot \\ \cdot \\ m \end{pmatrix} \quad R_X^{(n,m)}(\alpha) : n \rightarrow m :: \begin{pmatrix} \cdot \\ \cdot \\ \dots \\ \cdot \\ \cdot \\ m \end{pmatrix} \quad H : 1 \rightarrow 1 :: \begin{matrix} | \\ \square \\ | \end{matrix}$$

and the two compositions: spacial $(. \otimes .)$ and sequential $(. \circ .)$. The symmetric and compact structure are provided by $\sigma : 2 \rightarrow 2 :: \begin{array}{c} \diagdown \\ \diagup \end{array}$, $\epsilon : 2 \rightarrow 0 :: \begin{array}{c} \diagup \\ \diagdown \end{array}$ and $\eta : 0 \rightarrow 2 :: \begin{array}{c} \diagup \\ \diagdown \end{array}$.

To simplify, the red and green nodes are represented empty when holding a 0 angle:

$$\begin{array}{c} (\dots) \\ \bullet \\ (\dots) \end{array} := \begin{array}{c} (\dots) \\ \circ \\ (\dots) \end{array} \quad \text{and} \quad \begin{array}{c} (\dots) \\ \bullet \\ (\dots) \end{array} := \begin{array}{c} (\dots) \\ \circ \\ (\dots) \end{array}$$

The language is universal [CD11]. It has numerous complete axiomatisations [HNW18, JPV18b]. We use here the compact one of [Vil18]:

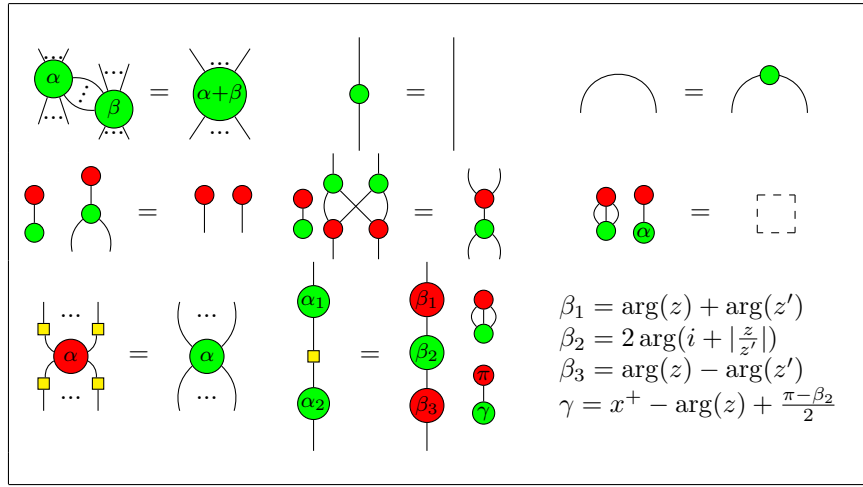

Figure 1: Set of rules for the general ZX-calculus with scalars. Where $x^+ := \frac{\alpha_1 + \alpha_2}{2}$, $x^- := x^+ - \alpha_2$, $z := -\sin(x^+) + i \cos(x^-)$, $z' := \cos(x^+) - i \sin(x^-)$ and $z' = 0 \Rightarrow \beta_2 = 0$. All of these rules also hold when flipped upside-down, or with the colours red and green swapped. The ellipses (...) denote zero or more wires, while $(. \cdot)$ denotes one or more wires.

ZX-diagrams represent quantum evolutions, so there exists a functor $[[\cdot]] : ZX \rightarrow \mathbf{Qubit}$, called the *standard interpretation*, which associates to any diagram $D : n \rightarrow m$ a linear map $[[D]] : \mathbb{C}^{2^n} \rightarrow \mathbb{C}^{2^m}$ inductively defined as follows:

$$\begin{array}{l} \text{---} [[\cdot]] \text{---} \\ [[D_1 \otimes D_2]] := [[D_1]] \otimes [[D_2]] \quad [[D_2 \circ D_1]] := [[D_2]] \circ [[D_1]] \\ [[\text{---}]] := (1) \quad [[\text{---}]] := \begin{pmatrix} 1 & 0 \\ 0 & 1 \end{pmatrix} \quad [[\text{---}]] := \frac{1}{\sqrt{2}} \begin{pmatrix} 1 & 1 \\ 1 & -1 \end{pmatrix} \\ [[\text{---}]] := (1 \ 0 \ 0 \ 1) \quad [[\text{---}]] := \begin{pmatrix} 1 & 0 & 0 & 0 \\ 0 & 0 & 1 & 0 \\ 0 & 1 & 0 & 0 \\ 0 & 0 & 0 & 1 \end{pmatrix} \quad [[\text{---}]] := \begin{pmatrix} 1 \\ 0 \\ 0 \\ 1 \end{pmatrix} \end{array}$$

$$\llbracket \bullet \bullet \rrbracket := (1 + e^{i\alpha}) \quad \llbracket \begin{matrix} \dots \\ \bullet \\ \dots \\ m \end{matrix} \rrbracket := 2^m \overbrace{\begin{pmatrix} 1 & 0 & \dots & 0 & 0 \\ 0 & 0 & \dots & 0 & 0 \\ \vdots & \vdots & \ddots & \vdots & \vdots \\ 0 & 0 & \dots & 0 & 0 \\ 0 & 0 & \dots & 0 & e^{i\alpha} \end{pmatrix}}^{2^n} \quad (n + m > 0)$$

For any $n, m \geq 0$ and $\alpha \in \mathbb{R}$: $\llbracket \begin{matrix} \dots \\ \bullet \\ \dots \\ m \end{matrix} \rrbracket = \llbracket \bullet \rrbracket^{\otimes m} \circ \llbracket \begin{matrix} \dots \\ \bullet \\ \dots \\ n \end{matrix} \rrbracket \circ \llbracket \bullet \rrbracket^{\otimes n}$
 (where $M^{\otimes 0} = (1)$ and $M^{\otimes k} = M \otimes M^{\otimes k-1}$ for $k \in \mathbb{N}^*$).

Theorem 10.1 provides a recipe for transforming a language for pure states into a language for mixed states and CPMs. The resulting language ZX^{\neq} can be seen as a prop with the generators of the ZX-calculus, augmented with $\underline{\llbracket \bullet \rrbracket}$, along with the equations $\{\underline{\llbracket \bullet \rrbracket} \circ D = \underline{\llbracket \bullet \rrbracket} \mid D^\dagger \circ D = I\}$. We actually do not need an infinite axiomatisation. Indeed, the set of isometries of the ZX-calculus can be finitely generated.

Using $(e^{i\alpha}, |0\rangle, H, R_Z(\alpha), \text{CNot})$ as spanning set of the isometries [NC10], we obtain only five axioms:

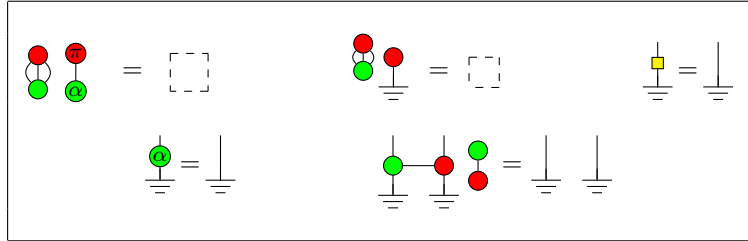

In fact the first axioms follows from the others :

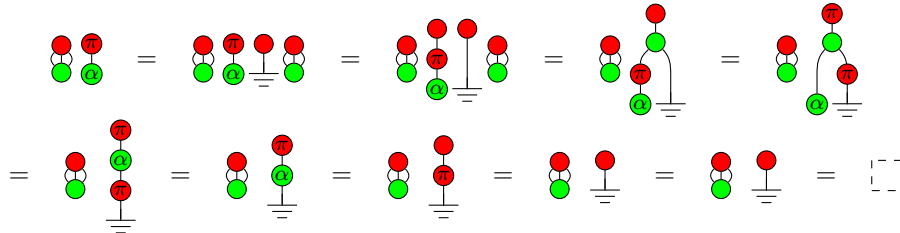

The final axiomatisation is then:

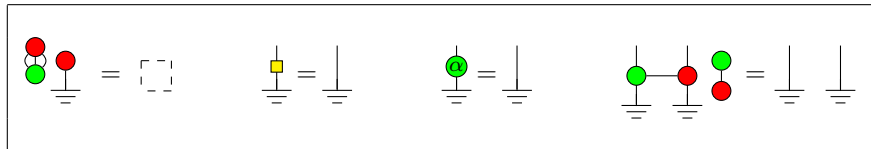

Note that the last axiom, which means that CNot is causal, is equivalent to the following equation, first introduced in [CP12]:

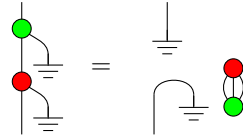

In this equation, the bottom part of the right hand side is nothing but a maximally mixed state (i.e., the states $\binom{1}{0}$ and $\binom{0}{1}$ uniformly at random). Moreover,

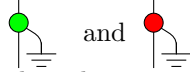

and can be interpreted as measurements in complementary basis, thus the equation means that measuring a system according to two complementary basis is equivalent to discarding the system and replacing it with a maximally mixed state.

4.2 The $\frac{\pi}{2}$ fragment of ZX-calculus

The $ZX_{\frac{\pi}{2}}$ is obtained from ZX by restricting phases α to $\{0, \frac{\pi}{2}, \pi, \frac{3\pi}{2}\}$. It is universal and complete for **Stab** [Bac14a] with the adequate axiomatisation. Moreover according to Lemma 10.4 **Stab** $^{\frac{\pi}{2}}$ is an environment structure for **Stab**.

The set $(e^{i\frac{\pi}{4}}, |0\rangle, H, R_Z(\alpha), \text{CNot})$, with α restricted to multiples of $\frac{\pi}{2}$, is a spanning set of isometries in **Stab** (notice that $e^{i\frac{\pi}{4}} = 2 \langle 0| HSH |0\rangle\langle 0| H |0\rangle$ is in **Stab**), so adding the same set of equations than in $ZX^{\frac{\pi}{2}}$ with additional rule

$$\binom{\frac{\pi}{2}}{\circ} = \begin{bmatrix} \text{---} \\ \text{---} \end{bmatrix} \quad \text{will provide a complete axiomatisation for } ZX_{\frac{\pi}{2}}.$$

4.3 The Clifford+T fragment of ZX-calculus

Restricting ZX to angles multiples of $\pi/4$, we obtain a language which is known to be universal and complete for **Clifford+T** [JPV18a]. However, as shown by Lemma 10.5, the semantic category **Clifford+T** does not have enough isometries. The discard construction is strictly coarser than CPM for this fragment. So we leave open the complete axiomatisation of quantum operations for this fragment.

4.4 The ZW-calculus

The ZW-calculus was introduced in [Had15], deriving from the GHZ/W-calculus [CK10], where the main two generators are two non-equivalent ways to entangle three qubits, the so-called GHZ and W states. The language was made complete for pure quantum mechanics in [HNW18]. Since CNot is hard to express in this calculus, we choose another set of universal diagrams, more suited to ZW, namely $(e^{i\alpha}, |1\rangle, R_Z(\alpha), H, \text{CZ} \circ \text{SWAP})$. The resulting rules for $ZW^{\frac{\pi}{2}}$ are:

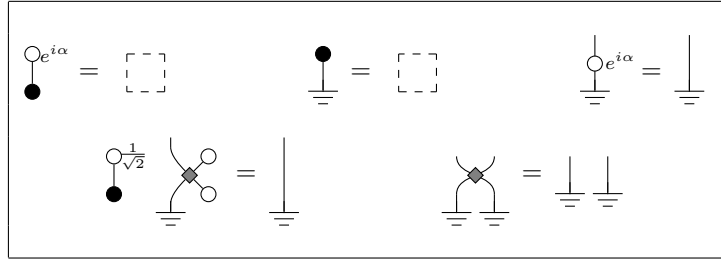

Here also the first rule is unnecessary and follows from the others:

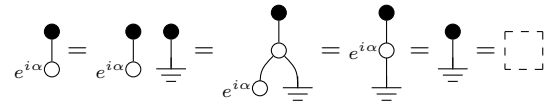

The final axiomatisation is:

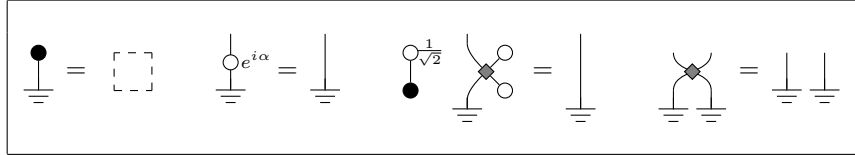

4.5 The ZH-calculus

The ZH-calculus was introduced and proved to be complete in [BK19]. The point of this language is to easily represent hypergraph-states, a generalisation of graph-states, a useful resource for quantum computing. This language has been specifically designed to easily represent the multi-controlled Z (which constitute the hyperedges in the hypergraph-states). So in particular, CZ and $R_Z(\alpha)$ are easily representable. Up to a scalar, H is also easily doable, and $\llbracket X^{(0,1)} \rrbracket = |0\rangle$. Hence, choosing $(e^{i\alpha}, |0\rangle, H, R_Z(\alpha), CZ)$ as spanning set, we only need the axioms:

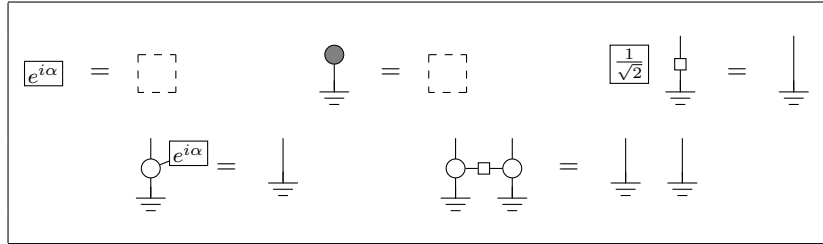

Again the first rule is unnecessary and follows from the others:

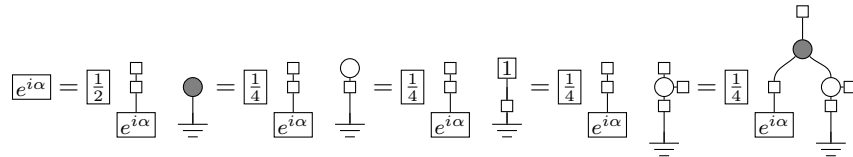

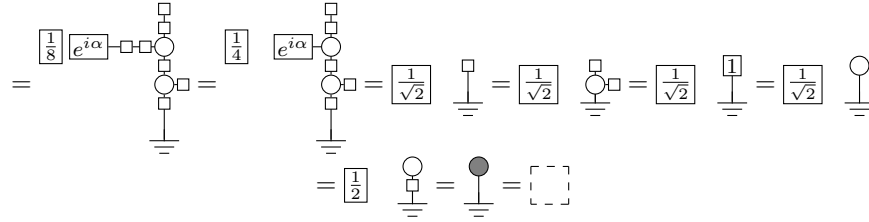

The last two rules of the previous axiomatisation can also be merged into one generalised rule. The final axiomatisation is:

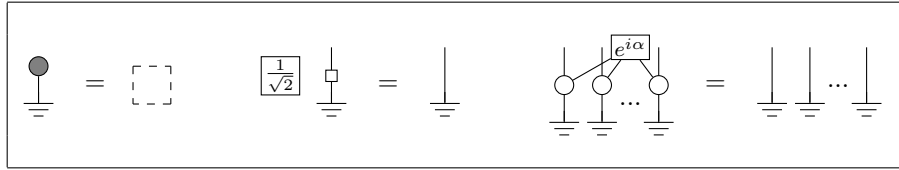

4.6 ZX-calculus with bastard spiders

In this section, contrary to the previous ones, we do not apply the discard construction to a graphical language, instead we consider the extension of the ZX-calculus introduced in [CK17] for representing mixed states and classical channels. The main idea is to add two additional spiders, a new kind of green and a new kind of red spiders, the so-called *bastard spiders* depicted as follows:

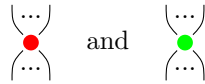

They respectively represent decoherence in the Z and X basis. The behaviour of a bastard spider would be represented in the ZX^\neq -calculus as a standard spider with a ground attached to it:

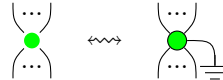

which respectively represent decoherence in the Z and X basis:

We give here an axiomatisation of those bastard spiders and show that it is equivalent to the discard construction, and then complete for quantum operations.

The new generators behave the same way as vanilla red and green spiders with respect to fusion and Hadamard gate:

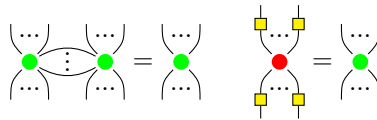

They also satisfy the following axioms:

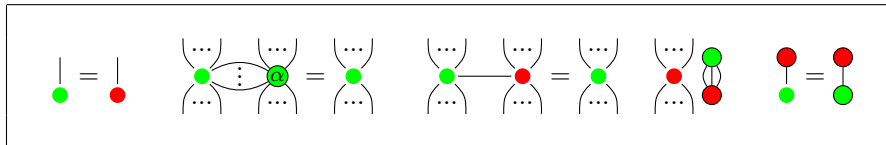

We call the ZX -calculus augmented by those generators and equations ZX^b .

Lemma 10.3. $ZX^b \simeq ZX^\ddagger$

The proof is in the appendix on pages 31.

Remark: [CK17] also includes a new type of classical wire. However, we choose to drop it, first because it is not necessary to fully describe quantum operation, but mainly because even if a new type of wire could have been properly handled by the use of colored props, the composition of bastard spiders of distinct colors through classical wire is ill-defined, which is inconsistent with a presentation with generators and equations.

5 Conclusion

Given any \dagger -SMC \mathbf{C} , the discard construction has been defined as the pushout of \mathbf{C} with the affine completion of its subcategory of isometries. This can be seen as a locally affine completion. This pushout construction can be decomposed into two steps, adding a discard generator, and then quotienting by equations ensuring the causality of isometries. There are as many equations as isometries in \mathbf{C} . However, since causality is closed under tensor and composition, stating the causality of a spanning set of isometries is enough. This is how we managed to give finite axiomatizations for the ZX , ZW and ZH calculi.

The discard construction corresponds to a congruence \sim_{iso}^+ . In the compact-closed case the CPM construction also corresponds to a congruence \sim_{cp} . We always have $\sim_{\text{iso}}^+ \subseteq \sim_{\text{cp}}$. Thus the two constructions only coincide when there are enough isometries, i.e., $\sim_{\text{cp}} \subseteq \sim_{\text{iso}}^+$. It happens that **Rel**, **FHilb** as well as its subcategories **Qubit** and **Stab**, have enough isometries. However **Clifford+T** doesn't, finding a good axiomatization of CPM **Clifford+T** is then still an open problem.

In the non compact-closed case, a \mathbf{CP}^∞ construction has been introduced in [CH16]. It relies on a congruence \sim_∞ generalizing \sim_{cp} . We still have $\sim_{\text{iso}}^+ \subseteq \sim_\infty$. We don't know if the converse holds for **Hilb**. However, we already have a counterexample: on **FHilb**_{iso}, \sim_∞ is trivial while \sim_{iso}^+ is not. This raises the question of the right generalization of **CPM** in the non compact-closed case.

Further research could include the investigation of the links of the discard construction and the works of [Com20], which also defines a similar construction based on congruences, and [CH17], which asks how a category factorizes into pure maps and discards.

References

- [ACR18] Matthew Amy, Jianxin Chen, and Neil J. Ross. A finite presentation of CNOT-dihedral operators. In Bob Coecke and Aleks Kissinger, editors, *Proceedings 14th International Conference on*

Quantum Physics and Logic, Nijmegen, The Netherlands, 3-7 July 2017, volume 266 of *Electronic Proceedings in Theoretical Computer Science*, pages 84–97, 2018.

- [AP05] Koenraad M. R. Audenaert and Martin B. Plenio. Entanglement on mixed stabilizer states: Normal forms and reduction procedures. *New Journal of Physics*, 7:170–170, Aug 2005.
- [Bac14a] Miriam Backens. The ZX-calculus is complete for stabilizer quantum mechanics. In *New Journal of Physics*, volume 16, page 093021. IOP Publishing, Sep 2014.
- [Bac14b] Miriam Backens. The ZX-calculus is complete for the single-qubit clifford+t group. In Bob Coecke, Ichiro Hasuo, and Prakash Panangaden, editors, *Proceedings of the 11th workshop on Quantum Physics and Logic, Kyoto, Japan, 4-6th June 2014*, volume 172 of *Electronic Proceedings in Theoretical Computer Science*, pages 293–303, 2014.
- [BCR17] John C. Baez, Brandon Coya, and Franciscus Rebro. Props in network theory. In *Theory and Applications of Categories*, volume 33, pages 727–783, Jul 2017.
- [BD14] Miriam Backens and Ali Nabi Duman. A complete graphical calculus for Spekkens’ toy bit theory. *Foundations of Physics*, pages 1–34, 2014.
- [BK19] Miriam Backens and Aleks Kissinger. ZH: A complete graphical calculus for quantum computations involving classical non-linearity. In Peter Selinger and Giulio Chiribella, editors, *Proceedings of the 15th International Conference on Quantum Physics and Logic, Halifax, Canada, 3-7th June 2018*, volume 287 of *Electronic Proceedings in Theoretical Computer Science*, pages 23–42, 2019.
- [BW85] Michael Barr and Charles Wells. *Toposes, Triples and Theories*. Springer-Verlag, New York, 1985.
- [CD11] Bob Coecke and Ross Duncan. Interacting quantum observables: Categorical algebra and diagrammatics. *New Journal of Physics*, 13(4):043016, Apr 2011.
- [CH16] Bob Coecke and Chris Heunen. Pictures of complete positivity in arbitrary dimension. *Information and Computation*, 250:50–58, 2016.
- [CH17] Oscar Cunningham and Chris Heunen. Purity through factorisation. *arXiv preprint arXiv:1705.07652*, 2017.

- [CK10] Bob Coecke and Aleks Kissinger. The compositional structure of multipartite quantum entanglement. In *Automata, Languages and Programming*, pages 297–308. Springer Berlin Heidelberg, 2010.
- [CK17] Bob Coecke and Aleks Kissinger. *Picturing Quantum Processes: A First Course in Quantum Theory and Diagrammatic Reasoning*. Cambridge University Press, 2017.
- [CKR⁺16] Nicholas Chancellor, Aleks Kissinger, Joschka Roffe, Stefan Zohren, and Dominic Horsman. Graphical structures for design and verification of quantum error correction. arXiv:1611.08012, 2016.
- [Coe08] Bob Coecke. Axiomatic description of mixed states from Selinger’s CPM-construction. *Electronic Notes in Theoretical Computer Science*, 210:3 – 13, 2008. Proceedings of the 4th International Workshop on Quantum Programming Languages (QPL 2006).
- [Com20] Cole Comfort. The zx& calculus: A complete graphical calculus for classical circuits using spiders. *arXiv preprint arXiv:2004.05287*, 2020.
- [CP12] Bob Coecke and Simon Perdrix. Environment and Classical Channels in Categorical Quantum Mechanics. *Logical Methods in Computer Science*, Volume 8, Issue 4, Nov 2012.
- [CW18] Bob Coecke and Quanlong Wang. ZX-rules for 2-qubit Clifford+T quantum circuits, 2018. arXiv:1804.05356.
- [dBH17] Niel de Beaudrap and Dominic Horsman. The ZX-calculus is a language for surface code lattice surgery. *CoRR*, abs/1704.08670, 2017.
- [DD16] Ross Duncan and Kevin Dunne. Interacting Frobenius algebras are Hopf. In *Proceedings of the 31st Annual ACM/IEEE Symposium on Logic in Computer Science*, LICS 2016, pages 535–544, New York, NY, USA, 2016. ACM.
- [DG18] Ross Duncan and Liam Garvie. Verifying the smallest interesting colour code with quantomatic. In Bob Coecke and Aleks Kissinger, editors, *Proceedings 14th International Conference on Quantum Physics and Logic, Nijmegen, The Netherlands, 3-7 July 2017*, volume 266 of *Electronic Proceedings in Theoretical Computer Science*, pages 147–163, 2018.
- [DKPvdW19] Ross Duncan, Aleks Kissinger, Simon Perdrix, and John van de Wetering. Graph-theoretic simplification of quantum circuits with the ZX-calculus, 2019.

- [DL14] Ross Duncan and Maxime Lucas. Verifying the Steane code with Quantomatic. In Bob Coecke and Matty Hoban, editors, *Proceedings of the 10th International Workshop on Quantum Physics and Logic, Castelldefels (Barcelona), Spain, 17th to 19th July 2013*, volume 171 of *Electronic Proceedings in Theoretical Computer Science*, pages 33–49. Open Publishing Association, 2014.
- [DP10] Ross Duncan and Simon Perdrix. Rewriting measurement-based quantum computations with generalised flow. *Lecture Notes in Computer Science*, 6199:285–296, 2010.
- [DP14] Ross Duncan and Simon Perdrix. Pivoting makes the ZX-calculus complete for real stabilizers. In Bob Coecke and Matty Hoban, editors, *Proceedings of the 10th International Workshop on Quantum Physics and Logic, Castelldefels (Barcelona), Spain, 17th to 19th July 2013*, volume 171 of *Electronic Proceedings in Theoretical Computer Science*, pages 50–62, 2014.
- [Dun13] Ross Duncan. A graphical approach to measurement-based quantum computing. In *Quantum Physics and Linguistics*, pages 50–89. Oxford University Press, Feb 2013.
- [Gog15] Stefano Gogioso. A bestiary of sets and relations. *arXiv preprint arXiv:1506.05025*, 2015.
- [GS13] Brett Giles and Peter Selinger. Exact synthesis of multiqubit Clifford+T circuits. *Phys. Rev. A*, 87:032332, Mar 2013.
- [Had15] Amar Hadzihasanovic. A diagrammatic axiomatisation for qubit entanglement. In *2015 30th Annual ACM/IEEE Symposium on Logic in Computer Science*, pages 573–584, Jul 2015.
- [Had17] Amar Hadzihasanovic. *The Algebra of Entanglement and the Geometry of Composition*. PhD thesis, University of Oxford, 2017.
- [HNW18] Amar Hadzihasanovic, Kang Feng Ng, and Quanlong Wang. Two complete axiomatisations of pure-state qubit quantum computing. In *Proceedings of the 33rd Annual ACM/IEEE Symposium on Logic in Computer Science, LICS '18*, pages 502–511, New York, NY, USA, 2018. ACM.
- [Hor11] Clare Horsman. Quantum picturalism for topological cluster-state computing. *New Journal of Physics*, 13(9):095011, Sep 2011.
- [HS19] Mathieu Huot and Sam Staton. Universal properties in quantum theory. In Peter Selinger and Giulio Chiribella, editors, *Proceedings of the 15th International Conference on Quantum Physics*

- and Logic, Halifax, Canada, 3-7th June 2018*, volume 287 of *Electronic Proceedings in Theoretical Computer Science*, pages 213–223, 2019.
- [JPV18a] Emmanuel Jeandel, Simon Perdrix, and Renaud Vilmart. A complete axiomatisation of the ZX-calculus for Clifford+T quantum mechanics. In *Proceedings of the 33rd Annual ACM/IEEE Symposium on Logic in Computer Science*, LICS '18, pages 559–568, New York, NY, USA, 2018. ACM.
- [JPV18b] Emmanuel Jeandel, Simon Perdrix, and Renaud Vilmart. Diagrammatic reasoning beyond Clifford+T quantum mechanics. In *Proceedings of the 33rd Annual ACM/IEEE Symposium on Logic in Computer Science*, LICS '18, pages 569–578, New York, NY, USA, 2018. ACM.
- [JPV19] Emmanuel Jeandel, Simon Perdrix, and Renaud Vilmart. A generic normal form for zx-diagrams and application to the rational angle completeness. In *2019 34th Annual ACM/IEEE Symposium on Logic in Computer Science (LICS)*, pages 1–10, June 2019.
- [Kar19] Martti Karvonen. The way of the dagger. *arXiv e-prints*, pages arXiv–1904, 2019.
- [KU17] Aleks Kissinger and Sander Uijlen. A categorical semantics for causal structure. In *2017 32nd Annual ACM/IEEE Symposium on Logic in Computer Science (LICS)*, pages 1–12. IEEE, 2017.
- [KvdW18] Aleks Kissinger and John van de Wetering. *Pyzx*, 2018.
- [KZ15] Aleks Kissinger and Vladimir Zamdzhiev. Quantomatic: A proof assistant for diagrammatic reasoning. In Amy P. Felty and Aart Middeldorp, editors, *Automated Deduction - CADE-25*, pages 326–336, Cham, 2015. Springer International Publishing.
- [MA08] Ken Matsumoto and Kazuyuki Amano. Representation of Quantum Circuits with Clifford and $\pi/8$ Gates, Jun 2008.
- [Mar15] Daniel Marsden. A graph theoretic perspective on cpm (rel). *arXiv preprint arXiv:1504.07003*, 2015.
- [NC10] Michael A. Nielsen and Isaac L. Chuang. *Quantum Computation and Quantum Information: 10th Anniversary Edition*. Cambridge University Press, 2010.
- [SB15] Peter Selinger and Xiaoning Bian. Relations for Clifford+T operators on two qubits, 2015.

- [Sel04] Peter Selinger. Towards a quantum programming language. *Mathematical. Structures in Comp. Sci.*, 14(4):527–586, Aug 2004.
- [Sel07] Peter Selinger. Dagger compact closed categories and completely positive maps. *Electronic Notes in Theoretical Computer Science*, 170:139–163, Mar 2007.
- [Sel10] Peter Selinger. A survey of graphical languages for monoidal categories. In *New Structures for Physics*, pages 289–355. Springer, 2010.
- [Sel15] Peter Selinger. Generators and Relations for n-qubit Clifford Operators. *Logical Methods in Computer Science*, Volume 11, Issue 2, Jun 2015.
- [Vil18] Renaud Vilmart. A near-optimal axiomatisation of zx-calculus for pure qubit quantum mechanics. *arXiv preprint arXiv:1812.09114*, 2018.
- [Vil19] Renaud Vilmart. A near-minimal axiomatisation of zx-calculus for pure qubit quantum mechanics. In *2019 34th Annual ACM/IEEE Symposium on Logic in Computer Science (LICS)*, pages 1–10, June 2019.
- [Zan15] Fabio Zanasi. *Interacting Hopf Algebras – the theory of linear systems*. PhD thesis, Université de Lyon, 2015.

A Proofs

Proof of Lemma 8.1. Given any morphism $f : \mathbf{C}^\sharp[A, B]$, we take a diagram representing it. Using the naturality of the symmetry we obtain an equivalent diagram in \mathbf{C}^\sharp where all the discards have been pushed to the bottom right:

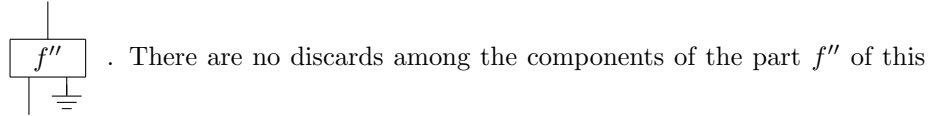

There are no discards among the components of the part f'' of this diagram. So it represents a morphism in the range of $\iota_{\mathbf{C}}$ and then there is an $f' : \mathbf{C}[A, B \otimes X]$ such that:

$$\begin{array}{c} | \\ \boxed{f} \\ | \end{array} = \begin{array}{c} | \\ \boxed{\iota_{\mathbf{C}}(f')} \\ | \\ \hline \end{array}$$

In other words, f' is a purification of f . □

Proof of Lemma 9.1.

(\Rightarrow) It is enough to show $f \sim_{\text{iso}} g \Rightarrow \begin{array}{c} | \\ \boxed{\iota_{\mathbf{C}}(f)} \\ | \\ \equiv \\ | \\ \equiv \end{array} = \begin{array}{c} | \\ \boxed{\iota_{\mathbf{C}}(g)} \\ | \\ \equiv \\ | \\ \equiv \end{array}$ since equality is transitive.

$f \sim_{\text{iso}} g \Leftrightarrow$ there are two isometries $u : X \rightarrow Z$ and $v : Y \rightarrow Z$ such that

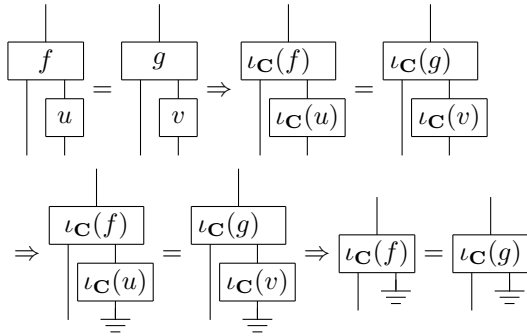
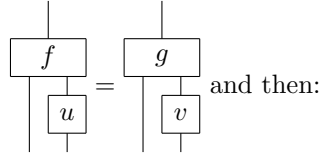

(\Leftarrow) We have $\begin{array}{c} | \\ \boxed{\iota_{\mathbf{C}}(f)} \\ | \\ \equiv \\ | \\ \equiv \end{array} = \begin{array}{c} | \\ \boxed{\iota_{\mathbf{C}}(g)} \\ | \\ \equiv \\ | \\ \equiv \end{array}$ in \mathbf{C}^\neq . To do the proof, we will have to go

back to the definition of the category \mathbf{C}^\neq as a pushout. Recall that two terms are equal if one can rewrite one into the other using the equations defining \mathbf{C}^\neq .

We can assume that, among those steps, the only one involving discards are isometry deletion/creation. Diagrammatically this amounts to saying that the discards are never moved, in fact one can always move the other morphisms to make them interact with the discards.

Doing this, we ensure that all intermediary diagrams in the chain of equations

are of the form $\begin{array}{c} | \\ \boxed{\iota_{\mathbf{C}}(k)} \\ | \\ \equiv \\ | \\ \equiv \end{array}$ for some k . Therefore, to prove the result

for a chain of equations of arbitrary size, it is enough to do it just for one step of rewriting.

Consider then this step of rewriting. There are two cases.

Either we have used an equation which, by identification, can be seen as an equation of \mathbf{C} , that is which involves no discards. Then by functoriality

of ι_C we recover that $f = g$ and therefore $f \sim_{\text{iso}} g$.

Or the equation involves a discard which has deleted an isometry u . Then

one part of the diagram, let's say $\iota_C(f)$, can be written $\iota_C(f) = \iota_C(g)$.

But u being an isometry, there exists u' in \mathbf{C} such that $\iota_C(u') = u$. Hence,

we have $\begin{array}{c} \boxed{f} \\ \text{---} \\ \text{---} \end{array} = \begin{array}{c} \boxed{g} \\ \text{---} \\ \boxed{u'} \\ \text{---} \end{array}$ in \mathbf{C} . It follows that $f \sim_{\text{iso}} g$.

□

Proof of Lemma 9.2. Since \sim_{cp} is transitive it is enough to show that $\sim_{\text{iso}} \subseteq \sim_{\text{cp}}$. Let $f : A \rightarrow B \otimes X$ and $g : A \rightarrow B \otimes Y$ s.t. $f \sim_{\text{iso}} g$. Then there are two

isometries $u : X \rightarrow Z$ and $v : Y \rightarrow Z$ such that $\begin{array}{c} \boxed{f} \\ \text{---} \\ \boxed{u} \\ \text{---} \end{array} = \begin{array}{c} \boxed{g} \\ \text{---} \\ \boxed{v} \\ \text{---} \end{array}$ and then:

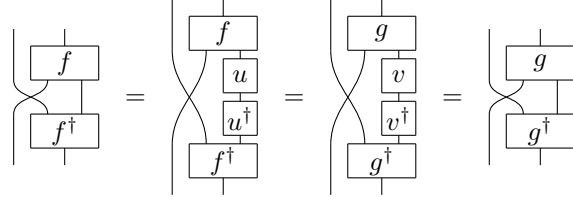

So $f \sim_{\text{cp}} g$.

□

Proof of Lemma 10.1. [(1) \Leftrightarrow (2)] First \mathbf{C}^\sharp has the same object as \mathbf{C} and $\iota_C : \mathbf{C} \rightarrow \mathbf{C}^\sharp$ is a SM-functor. We need to check the three conditions hold:

- Since $\iota_{\mathbf{C}_{\text{iso}}^\sharp}$ is strict monoidal one has:

$$\begin{aligned} \frac{I}{\underline{\quad}} &= \iota_{\mathbf{C}_{\text{iso}}^\sharp}(!_I) = \iota_{\mathbf{C}_{\text{iso}}^\sharp}(id_I) = id_I \\ \frac{A}{\underline{\quad}} \otimes \frac{B}{\underline{\quad}} &= \iota_{\mathbf{C}_{\text{iso}}^\sharp}(!_A) \otimes \iota_{\mathbf{C}_{\text{iso}}^\sharp}(!_B) = \iota_{\mathbf{C}_{\text{iso}}^\sharp}(!_A \otimes !_B) \\ &= \iota_{\mathbf{C}_{\text{iso}}^\sharp}(!_A \otimes B) = \frac{A \otimes B}{\underline{\quad}} \end{aligned}$$

So the first condition is satisfied.

- The second condition is Lemma 8.1.
- According to Lemma 9.2, $\sim_{\text{iso}}^+ \subseteq \sim_{\text{cp}}$, thus the third condition is satisfied if and only if $\sim_{\text{cp}} \subseteq \sim_{\text{iso}}^+$.

[(1) \Leftrightarrow (2)] Direct consequence of the fact that \mathbf{D} is an environment structure for \mathbf{C} iff \mathbf{D} is equivalent to $\text{CPM}(\mathbf{C})$ [CH16]. \square

Proof of Proposition 10.1. Let $f : A \rightarrow B \otimes X$ and $g : A \rightarrow B \otimes Y$ be two linear

maps such that $f \sim_{\text{cp}} g$. By definition: $\begin{array}{c} \boxed{f} \\ \downarrow \\ \boxed{f^\dagger} \end{array} = \begin{array}{c} \boxed{g} \\ \downarrow \\ \boxed{g^\dagger} \end{array}$. It follows that the two

superoperators $\rho \mapsto \text{tr}_X(f^\dagger \rho f)$ and $\rho \mapsto \text{tr}_Y(g^\dagger \rho g)$ are equal and then by the Stinespring dilation theorem (see for example [HS19]), there are isometries u

and v such that $\begin{array}{c} \boxed{f} \\ \downarrow \\ \boxed{u} \end{array} = \begin{array}{c} \boxed{g} \\ \downarrow \\ \boxed{v} \end{array}$. In other words $f \sim_{\text{iso}} g$. This shows that

$\sim_{\text{cp}} \subseteq \sim_{\text{iso}}$ which is even stronger than having enough isometries. From Lemma 9.2 it follows that $\sim_{\text{iso}}^+ \subseteq \sim_{\text{iso}}$. \square

Proof of Proposition 10.2. We just have to show that $\sim_{\text{iso}}^+ \subseteq \sim_{\text{iso}}$ in \mathbf{Rel} . $\mathcal{R} : A \rightarrow B$ is an isometry in \mathbf{Rel} iff $\forall (x, y) \in A \times A$:

$$\exists z \in B, (x|z) \in \mathcal{R} \wedge (y|z) \in \mathcal{R} \Leftrightarrow x = y$$

In other words, \mathcal{R} must be total and injective in the relational sense. Given two relations $\mathcal{F} : A \rightarrow B \times C$ and $\mathcal{G} : A \rightarrow B \times D$ we have $\mathcal{F} \sim_{\text{iso}}^+ \mathcal{G}$ iff $\forall (a, b, a', b') \in A \times B \times A \times B$:

$$\exists c \in C, (a|b, c) \in \mathcal{F} \wedge (a'|b', c) \in \mathcal{F} \Leftrightarrow \exists d \in D, (a|b, d) \in \mathcal{G} \wedge (a'|b', d) \in \mathcal{G}$$

We denote $\mathcal{F}|_c = \{(a, b) \in A \times B, (a|b, c) \in \mathcal{F}\}$ and $\mathcal{G}|_d = \{(a, b) \in A \times B, (a|b, d) \in \mathcal{G}\}$. Given two relations $\mathcal{F} : A \rightarrow B \times C$ and $\mathcal{G} : A \rightarrow B \times D$ we have $\mathcal{F} \sim_{\text{iso}} \mathcal{G}$ iff there exists two isometries $\mathcal{U} : C \rightarrow H$ and $\mathcal{V} : D \rightarrow H$ such that: $\forall (a, b, h) \in A \times B \times H$:

$$\exists c \in C, (a|b, c) \in \mathcal{F} \wedge (c|h) \in \mathcal{U} \Leftrightarrow \exists d \in D, (a|b, d) \in \mathcal{G} \wedge (d|h) \in \mathcal{V}$$

Let $\mathcal{F} : A \rightarrow B \times C$ and $\mathcal{G} : A \rightarrow B \times D$ be two relations such that $\mathcal{F} \sim_{\text{iso}}^+ \mathcal{G}$. We define two relations $\mathcal{U} : C \rightarrow \{0, 1\} \times C \times D \times A \times B$ and $\mathcal{V} : D \rightarrow \{0, 1\} \times C \times D \times A \times B$ as: forall $(c, c', d, d', a, b) \in C \times C \times D \times D \times A \times B$,

$$\begin{aligned} (c|0, c', d', a, b) \in \mathcal{U} &\Leftrightarrow c = c' \wedge \mathcal{F}|_c = \emptyset \\ (c|1, c', d', a, b) \in \mathcal{U} &\Leftrightarrow c = c' \wedge (a|b, c') \in \mathcal{F} \end{aligned}$$

and:

$$\begin{aligned} (d|0, c', d', a, b) \in \mathcal{V} &\Leftrightarrow d = d' \wedge \mathcal{G}|_d = \emptyset \\ (d|1, c', d', a, b) \in \mathcal{V} &\Leftrightarrow d = d' \wedge (a|b, d') \in \mathcal{G} \end{aligned}$$

U and V are isometries. We only show it for \mathcal{U} , the case of \mathcal{V} being perfectly symmetric. Given $(c, i, c', d, a, b) \in C \times \{0, 1\} \times C \times D \times A \times B$, $(c|i, c', d, a, b) \in \mathcal{U}$ implies by construction that $c = c'$. So \mathcal{U} is injective. Given any $c \in C$, if $\mathcal{F}|_c = \emptyset$ then: $(c|0, c, d, a, b) \in \mathcal{U}$ for all $(d, a, b) \in D \times A \times B$. Else, if $\mathcal{F}|_c \neq \emptyset$ then there is $(a, b) \in A \times B$ such that $(c|1, c, d, a, b) \in \mathcal{U}$ for all $d \in D$. So \mathcal{U} is total. So \mathcal{U} is an isometry.

Given $(a, b, i, c', d', a', b') \in A \times B \times \{0, 1\} \times C \times D \times A \times B$, we need to prove:

$$\exists c \in C, (a|b, c) \in \mathcal{F} \wedge (c|i, c', d', a', b') \in \mathcal{U} \Leftrightarrow \exists d \in D, (a|b, d) \in \mathcal{G} \wedge (d|i, c', d', a', b') \in \mathcal{V}$$

We distinguish to cases:

- If $i = 0$:

$$\exists c \in C, (a|b, c) \in \mathcal{F} \wedge (c|0, c', d', a', b') \in \mathcal{U} \Leftrightarrow \exists d \in D, (a|b, d) \in \mathcal{G} \wedge (d|0, c', d', a', b') \in \mathcal{V}$$

Unfolding the definition of \mathcal{U} and \mathcal{V} gives:

$$\exists c \in C, (a|b, c) \in \mathcal{F} \wedge \mathcal{F}|_c = \emptyset \Leftrightarrow \exists d \in D, (a|b, d) \in \mathcal{G} \wedge \mathcal{G}|_d = \emptyset$$

Both assertions are false so the equivalence holds.

- If $i = 1$:

$$\exists c \in C, (a|b, c) \in \mathcal{F} \wedge (c|1, c', d', a', b') \in \mathcal{U} \Leftrightarrow \exists d \in D, (a|b, d) \in \mathcal{G} \wedge (d|1, c', d', a', b') \in \mathcal{V}$$

Unfolding the definition of \mathcal{U} and \mathcal{V} gives:

$$\exists c \in C, (a|b, c) \in \mathcal{F} \wedge (a'|b', c) \in \mathcal{F} \Leftrightarrow \exists d \in D, (a|b, d) \in \mathcal{G} \wedge (a'|b', d) \in \mathcal{G}$$

But this is exactly $\mathcal{F} \sim_{\text{iso}}^+ \mathcal{G}$.

□

Proof of Proposition 10.4. First of all, since **Stab** is compact closed, using the map/state duality, proving the result for states is sufficient. Since all the non-zero scalars are invertible in **Stab** we can furthermore without loss of generality focus on normalized states. Consider two states $d_1 : A \otimes X$ and $d_2 : A \otimes Y$ in **Stab** such that $d_1 \sim_{\text{cp}} d_2$. The point of focusing on normalized states is that

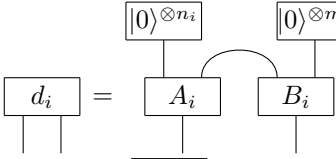
we can decompose using [AP05] so that $d_i =$  where

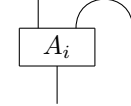
A_i and B_i are unitaries in **Stab**. Defining $A'_i =:$  we have that

$d_i \sim_{\text{iso}} A'_i$ since we just have deleted isometries. So, by transitivity, to prove $d_1 \sim_{\text{iso}}^+ d_2$ we just have to show $A'_1 \sim_{\text{iso}} A'_2$. But since $d_1 \sim_{\text{cp}} d_2$ in **Stab** we also have $d_1 \sim_{\text{cp}} d_2$ in **FHilb** and so by Lemma 10.1, $d_1 \sim_{\text{iso}}^+ d_2$ in **FHilb**. By transitivity $A'_1 \sim_{\text{iso}}^+ A'_2$ in **FHilb** and so by Lemma 10.1 $A'_1 \sim_{\text{iso}} A'_2$ in **FHilb**.

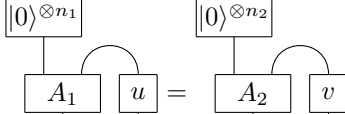
So there are two unitaries u and v such that . In

FHilb any isometry can be written as an unitary with ancillas. In other words

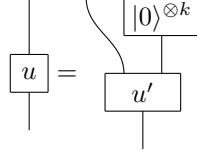
there is an unitary u' such that: $u =$ , composing by u'^{\dagger} on both side

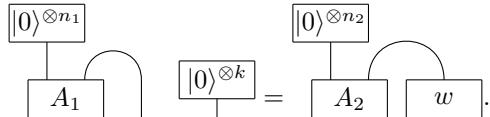
and denoting $w = u'^{\dagger} \circ v$ one has: . It

only remains to show that the isometry w is in **Stab** since the isometry on left

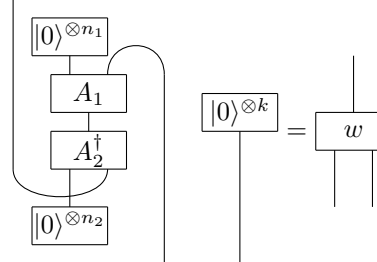
hand side is clearly in it. This is given by:  so

$A'_1 \sim_{\text{iso}} A'_2$ in **Stab** and then $d_1 \sim_{\text{cp}} d_2$. □

Proof of Proposition 10.5. First note that, in any \dagger -SMC category, if $f \sim_{\text{iso}}^+ g$

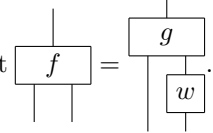
then there is a morphism (usually not an isometry) w such that .

This is true if $f \sim_{\text{iso}} g$: From $\begin{array}{c} | \\ \boxed{f} \\ | \\ \boxed{u} \\ | \end{array} = \begin{array}{c} | \\ \boxed{g} \\ | \\ \boxed{v} \\ | \end{array}$ we immediately get $\begin{array}{c} | \\ \boxed{f} \\ | \end{array} = \begin{array}{c} | \\ \boxed{g} \\ | \\ \boxed{v} \\ | \\ \boxed{u^\dagger} \\ | \end{array}$.

The result then follows by a straightforward induction.

Now take $\phi = 1 + 2i$ and $\phi^* = 1 - 2i$. The scalars are in **Clifford+T** since their entries are in $\mathbb{Z}[i, \frac{1}{\sqrt{2}}]$, and are clearly \sim_{cp} equivalent. Now let's suppose $1 + 2i \sim_{\text{iso}}^+ 1 - 2i$. Then by the previous remark, there exists a morphism u such that $(1 - 2i)u = 1 + 2i$. But the only possibility for u is $\frac{4i-3}{5}$, which is not in $\mathbb{Z}[i, \frac{1}{\sqrt{2}}]$, a contradiction. \square

Proof of Lemma 10.2. First, remark that if $F(\ell) \sim_{\text{iso}} k$, then there exists h s.t. $F(h) = k$. Indeed, under the hypothesis, there are two isometries u and v such

that: $\begin{array}{c} | \\ \boxed{F(\ell)} \\ | \\ \boxed{u} \\ | \end{array} = \begin{array}{c} | \\ \boxed{k} \\ | \\ \boxed{v} \\ | \end{array}$. Since F_{iso} is full and surjective on objects, there are two isometries a and b such that $F(a) = u$ and $F(b) = v$.

$$\begin{array}{c} | \\ \boxed{F(\ell)} \\ | \\ \boxed{F(a)} \\ | \end{array} = \begin{array}{c} | \\ \boxed{k} \\ | \\ \boxed{F(b)} \\ | \end{array} \Rightarrow \begin{array}{c} | \\ \boxed{F(\ell)} \\ | \\ \boxed{F(a)} \\ | \\ \boxed{F(b)}^\dagger \\ | \end{array} = \begin{array}{c} | \\ \boxed{k} \\ | \end{array} \Rightarrow F \left(\begin{array}{c} | \\ \boxed{\ell} \\ | \\ \boxed{a} \\ | \\ \boxed{b^\dagger} \\ | \end{array} \right) = \begin{array}{c} | \\ \boxed{k} \\ | \end{array}$$

The first implication uses the fact that $F(b)$ is an isometry. So k is in the image of F .

By the first remark, it is therefore sufficient to prove the result if $F(f) \sim_{\text{iso}} F(g)$. Since F_{iso} is full and surjective on objects, there are two isometries a and b such that $F(a) = u$ and $F(b) = v$. Therefore

$$\begin{array}{c} | \\ \boxed{F(f)} \\ | \\ \boxed{F(a)} \\ | \end{array} = \begin{array}{c} | \\ \boxed{F(g)} \\ | \\ \boxed{F(b)} \\ | \end{array} \Rightarrow F \left(\begin{array}{c} | \\ \boxed{f} \\ | \\ \boxed{a} \\ | \end{array} \right) = F \left(\begin{array}{c} | \\ \boxed{g} \\ | \\ \boxed{b} \\ | \end{array} \right) \Rightarrow \begin{array}{c} | \\ \boxed{f} \\ | \\ \boxed{a} \\ | \end{array} = \begin{array}{c} | \\ \boxed{g} \\ | \\ \boxed{b} \\ | \end{array}$$

The second one holds because F is faithful. The last equation is the definition of $f \sim_{\text{iso}} g$. \square

Proof of Theorem 10.1. Let f and g be two morphisms such that $F^\pm(f) = F^\pm(g)$. By Lemma 8.1, f and g can be purified:

$$F^{\neq} \left(\begin{array}{c} | \\ \boxed{\iota_C(f')} \\ | \\ \underline{\underline{=}} \end{array} \right) = F^{\neq} \left(\begin{array}{c} | \\ \boxed{\iota_C(g')} \\ | \\ \underline{\underline{=}} \end{array} \right) \Rightarrow \begin{array}{c} | \\ \boxed{\iota_D F(f')} \\ | \\ \underline{\underline{=}} \end{array} = \begin{array}{c} | \\ \boxed{\iota_D F(g')} \\ | \\ \underline{\underline{=}} \end{array}$$

The implication follows from the upper face of the commutative cube. By Lemma 9.1 we have $F(f') \sim_{\text{iso}}^+ F(g')$. By Lemma 10.2, $f' \sim_{\text{iso}}^+ g'$. Then Lemma

9.1 gives $\begin{array}{c} | \\ \boxed{\iota_C(f')} \\ | \\ \underline{\underline{=}} \end{array} = \begin{array}{c} | \\ \boxed{\iota_C(g')} \\ | \\ \underline{\underline{=}} \end{array}$ that is $f = g$, F is faithful. \square

Proof of Lemma 10.3. Since both categories have the same objects we exhibit a full and faithful functor $F : ZX^b \rightarrow ZX^{\neq}$ defined as the identity on the ZX part and which acts on the bastards spiders as: $F \left(\begin{array}{c} \dots \\ \bullet \\ \dots \end{array} \right) = \begin{array}{c} \dots \\ \bullet \\ \dots \\ \underline{\underline{=}} \end{array}$ and the colorswap for the red bastard spiders.

First we need to show that F is well defined. In other words that the images of the additional equations of ZX^b are still equal in ZX^{\neq} :

$$\begin{aligned} F \left(\begin{array}{c} | \\ \bullet \\ \underline{\underline{=}} \end{array} \right) &= \begin{array}{c} \bullet \\ \underline{\underline{=}} \end{array} = \begin{array}{c} \underline{\underline{=}} \end{array} = \begin{array}{c} \bullet \\ \underline{\underline{=}} \end{array} = F \left(\begin{array}{c} | \\ \bullet \\ \underline{\underline{=}} \end{array} \right) \\ F \left(\begin{array}{c} \dots \\ \bullet \\ \dots \\ \dots \\ \bullet \\ \dots \end{array} \right) &= \begin{array}{c} \dots \\ \bullet \\ \dots \\ \dots \\ \bullet \\ \dots \\ \underline{\underline{=}} \end{array} = \begin{array}{c} \dots \\ \bullet \\ \dots \\ \dots \\ \bullet \\ \dots \\ \underline{\underline{=}} \end{array} = \begin{array}{c} \dots \\ \bullet \\ \dots \\ \dots \\ \bullet \\ \dots \\ \underline{\underline{=}} \end{array} = F \left(\begin{array}{c} \dots \\ \bullet \\ \dots \\ \dots \\ \bullet \\ \dots \end{array} \right) \\ F \left(\begin{array}{c} \dots \\ \bullet \\ \dots \\ \dots \\ \bullet \\ \dots \end{array} \right) &= \begin{array}{c} \dots \\ \bullet \\ \dots \\ \dots \\ \bullet \\ \dots \\ \underline{\underline{=}} \end{array} = \begin{array}{c} \dots \\ \bullet \\ \dots \\ \dots \\ \bullet \\ \dots \\ \underline{\underline{=}} \end{array} = \begin{array}{c} \dots \\ \bullet \\ \dots \\ \dots \\ \bullet \\ \dots \\ \underline{\underline{=}} \end{array} = F \left(\begin{array}{c} \dots \\ \bullet \\ \dots \\ \dots \\ \bullet \\ \dots \end{array} \right) \\ F \left(\begin{array}{c} \dots \\ \bullet \\ \dots \\ \dots \\ \bullet \\ \dots \end{array} \right) &= \begin{array}{c} \dots \\ \bullet \\ \dots \\ \dots \\ \bullet \\ \dots \\ \underline{\underline{=}} \end{array} = \begin{array}{c} \dots \\ \bullet \\ \dots \\ \dots \\ \bullet \\ \dots \\ \underline{\underline{=}} \end{array} = \begin{array}{c} \dots \\ \bullet \\ \dots \\ \dots \\ \bullet \\ \dots \\ \underline{\underline{=}} \end{array} = F \left(\begin{array}{c} \dots \\ \bullet \\ \dots \\ \dots \\ \bullet \\ \dots \end{array} \right) \\ F \left(\begin{array}{c} \bullet \\ \bullet \\ \underline{\underline{=}} \end{array} \right) &= \begin{array}{c} \bullet \\ \bullet \\ \underline{\underline{=}} \end{array} = \begin{array}{c} \bullet \\ \bullet \\ \underline{\underline{=}} \end{array} = F \left(\begin{array}{c} \bullet \\ \bullet \\ \underline{\underline{=}} \end{array} \right) \\ F \left(\begin{array}{c} \dots \\ \bullet \\ \dots \\ \dots \\ \bullet \\ \dots \end{array} \right) &= \begin{array}{c} \dots \\ \bullet \\ \dots \\ \dots \\ \bullet \\ \dots \\ \underline{\underline{=}} \end{array} = \begin{array}{c} \dots \\ \bullet \\ \dots \\ \dots \\ \bullet \\ \dots \\ \underline{\underline{=}} \end{array} = \begin{array}{c} \dots \\ \bullet \\ \dots \\ \dots \\ \bullet \\ \dots \\ \underline{\underline{=}} \end{array} = F \left(\begin{array}{c} \dots \\ \bullet \\ \dots \\ \dots \\ \bullet \\ \dots \end{array} \right) \end{aligned}$$

F is full, an antecedent of $\underline{\underline{=}}$ being given by $\begin{array}{c} | \\ \bullet \\ \underline{\underline{=}} \end{array} : F \left(\begin{array}{c} | \\ \bullet \\ \underline{\underline{=}} \end{array} \right) = \begin{array}{c} \bullet \\ \underline{\underline{=}} \end{array} = \begin{array}{c} \underline{\underline{=}} \end{array}$.

For the faithfulness we show that the additional equations of ZX^{\neq} hold in

ZX^b via the translation $\underline{\equiv} \rightarrow \mid :$

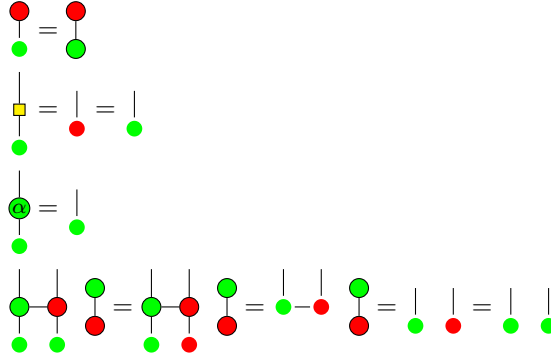

So F is an equivalence of category. □

B ZW and ZH Calculi

B.1 ZW-calculus

ZW-diagrams are generated by:

$Z^{(n,m)}(r) : n \rightarrow m$		$\mathbb{I} : 1 \rightarrow 1$	
$W^{(n,m)} : n \rightarrow m$		$e : 0 \rightarrow 0$	
$\sigma : 2 \rightarrow 2$		$\sigma' : 2 \rightarrow 2$	
$\epsilon : 2 \rightarrow 0$		$\eta : 0 \rightarrow 2$	

where $n, m \in \mathbb{N}$, $r \in \mathbb{C}$, and the generator e is the empty diagram.

and the two compositions: spacial $(. \otimes .)$ and sequential $(. \circ .)$.

The standard interpretation is defined as:

$$\begin{aligned}
 \llbracket D_1 \otimes D_2 \rrbracket &:= \llbracket D_1 \rrbracket \otimes \llbracket D_2 \rrbracket & \llbracket D_2 \circ D_1 \rrbracket &:= \llbracket D_2 \rrbracket \circ \llbracket D_1 \rrbracket \\
 \llbracket \square \rrbracket &:= | \rangle & \llbracket \mid \rrbracket &:= \begin{pmatrix} 1 & 0 \\ 0 & 1 \end{pmatrix}
 \end{aligned}$$

$$\begin{aligned}
\llbracket \text{X} \rrbracket &:= \begin{pmatrix} 1 & 0 & 0 & 0 \\ 0 & 0 & 1 & 0 \\ 0 & 1 & 0 & 0 \\ 0 & 0 & 0 & 1 \end{pmatrix} & \llbracket \text{X}^\bullet \rrbracket &:= \begin{pmatrix} 1 & 0 & 0 & 0 \\ 0 & 0 & 1 & 0 \\ 0 & 1 & 0 & 0 \\ 0 & 0 & 0 & -1 \end{pmatrix} \\
\llbracket \text{C} \rrbracket &:= \begin{pmatrix} 1 \\ 0 \\ 0 \\ 1 \end{pmatrix} & \llbracket \text{C}^\bullet \rrbracket &:= (1 \ 0 \ 0 \ 1) \\
\llbracket \text{X}^{n,m,r} \rrbracket &= \begin{pmatrix} 1 & 0 & \cdots & 0 & 0 \\ 0 & 0 & \cdots & 0 & 0 \\ \vdots & \vdots & \ddots & \vdots & \vdots \\ 0 & 0 & \cdots & 0 & 0 \\ 0 & 0 & \cdots & 0 & r \end{pmatrix} \\
\llbracket \bullet \rrbracket &:= \begin{pmatrix} 0 & 1 \\ 1 & 0 \end{pmatrix} & \llbracket \text{W}^\bullet \rrbracket &:= \begin{pmatrix} 0 & 1 \\ 1 & 0 \\ 1 & 0 \\ 0 & 0 \end{pmatrix}
\end{aligned}$$

B.2 ZH-calculus

The ZH-diagrams are generated by:

$Z^{(n,m)} : n \rightarrow m$		$X^{(n,m)} : n \rightarrow m$		$H^{(n,m)}(a) : n \rightarrow m$	
$\neg : 1 \rightarrow 1$		$e : 0 \rightarrow 0$			$\mathbb{I} : 1 \rightarrow 1$
$\sigma : 2 \rightarrow 2$		$\epsilon : 2 \rightarrow 0$		$\eta : 0 \rightarrow 2$	

where $n, m \in \mathbb{N}$, $a \in \mathbb{C}$, and the generator e is the empty diagram.

and the two compositions: spacial ($\cdot \otimes \cdot$) and sequential ($\cdot \circ \cdot$).

The language was introduced to allow a simple representation of hypergraph states and multi-controlled-Z gates. To do so it features a node called H -spider, which can be seen as a generalisation of the Hadamard gate. By convention, when no parameter is specified in H , the implicit parameter taken is

$$-1: \begin{array}{c} | \\ \square \\ | \end{array} := \begin{array}{c} | \\ \boxed{-1} \\ | \end{array} .$$

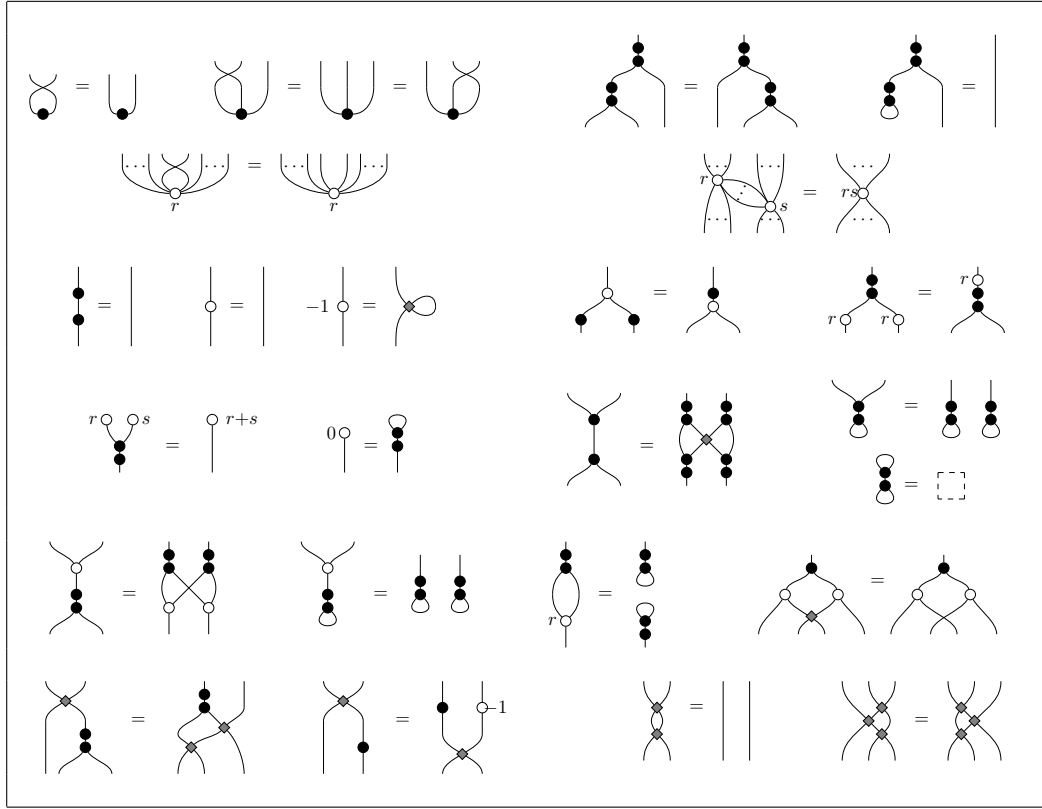

Figure 2: Set of rules for the ZW-calculus. $r, s \in \mathbb{C}$.

The language comes with a standard interpretation defined as:

$$\begin{aligned}
 & \llbracket \cdot \rrbracket \\
 & \llbracket D_1 \otimes D_2 \rrbracket := \llbracket D_1 \rrbracket \otimes \llbracket D_2 \rrbracket \qquad \llbracket D_2 \circ D_1 \rrbracket := \llbracket D_2 \rrbracket \circ \llbracket D_1 \rrbracket \\
 & \llbracket \boxed{} \rrbracket := (1) \qquad \llbracket \parallel \rrbracket := \begin{pmatrix} 1 & 0 \\ 0 & 1 \end{pmatrix} \qquad \llbracket \bullet \rrbracket := \begin{pmatrix} 0 & 1 \\ 1 & 0 \end{pmatrix} \\
 & \llbracket \bowtie \rrbracket := \begin{pmatrix} 1 & 0 & 0 & 0 \\ 0 & 0 & 1 & 0 \\ 0 & 1 & 0 & 0 \\ 0 & 0 & 0 & 1 \end{pmatrix} \qquad \llbracket \frown \rrbracket := \begin{pmatrix} 1 \\ 0 \\ 0 \\ 1 \end{pmatrix} \\
 & \llbracket \smile \rrbracket := (1 \ 0 \ 0 \ 1) \qquad \llbracket \begin{matrix} n \\ \boxed{a} \\ m \end{matrix} \rrbracket := \begin{pmatrix} 1 & \cdots & 1 & 1 \\ \vdots & \ddots & \vdots & \vdots \\ 1 & \cdots & 1 & 1 \\ 1 & \cdots & 1 & a \end{pmatrix}
 \end{aligned}$$

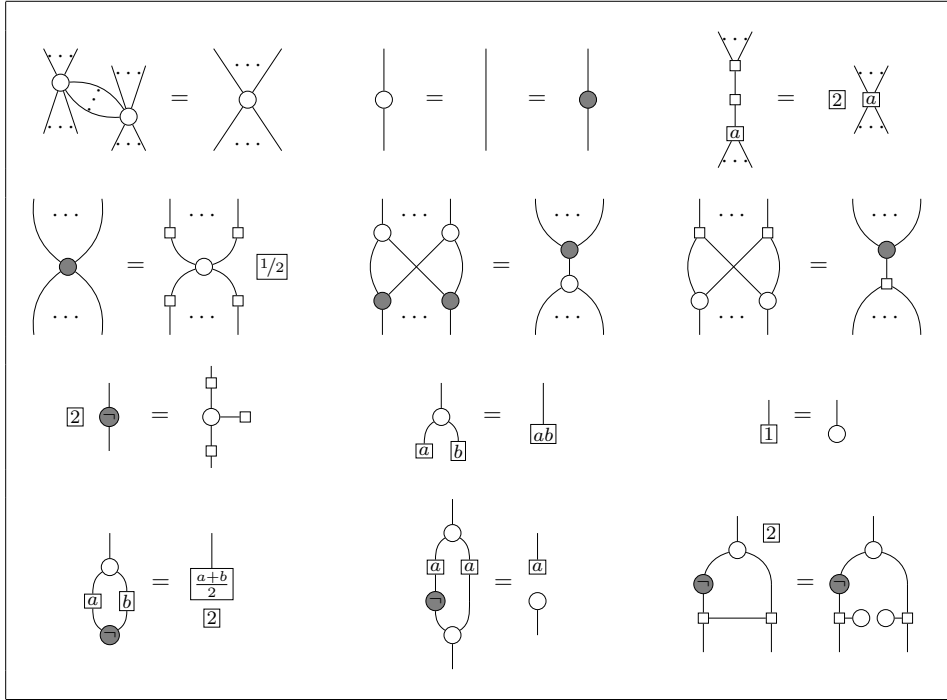

Figure 3: Set of rules ZH. (...) denote zero or more wires, while (·) denote one or more wires.

$$\left[\begin{array}{c} n \\ \vdots \\ \text{crossing} \\ \vdots \\ m \end{array} \right] := \begin{pmatrix} 1 & 0 & \cdots & 0 & 0 \\ 0 & 0 & \cdots & 0 & 0 \\ \vdots & \vdots & \ddots & \vdots & \vdots \\ 0 & 0 & \cdots & 0 & 0 \\ 0 & 0 & \cdots & 0 & 1 \end{pmatrix}$$

$$\left[\begin{array}{c} n \\ \vdots \\ \text{crossing with dot} \\ \vdots \\ m \end{array} \right] := \frac{1}{2} \left[\begin{array}{c} \vdots \\ \text{crossing} \\ \vdots \end{array} \right]^{\otimes m} \circ \left[\begin{array}{c} n \\ \vdots \\ \text{crossing} \\ \vdots \\ m \end{array} \right] \circ \left[\begin{array}{c} \vdots \\ \text{crossing} \\ \vdots \end{array} \right]^{\otimes n}$$

A set of rules was proposed together with the language (Figure 3). It makes the ZH-calculus complete for **Qubit**.

C ZX Axiomatisations

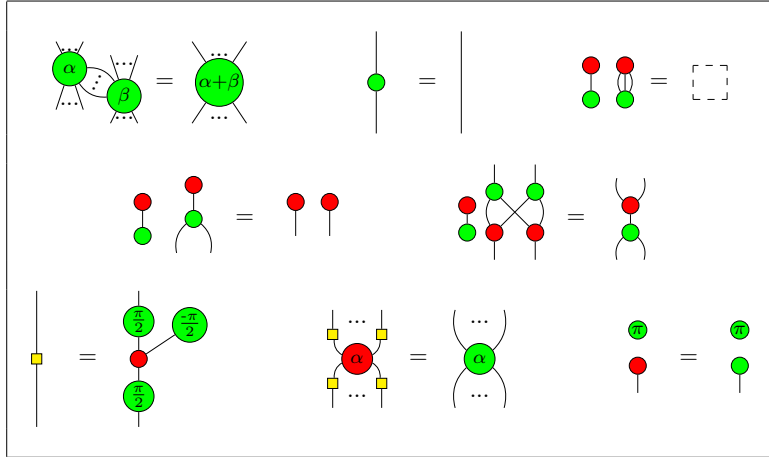

Figure 4: Set of rules $ZX_{\frac{\pi}{2}}$ for the $\frac{\pi}{2}$ -fragment of the ZX-calculus with scalars. All of these rules also hold when flipped upside-down, or with the colours red and green swapped. The right-hand side of (IV) is an empty diagram. (...) denote zero or more wires, while (..) denote one or more wires.