



HAL
open science

A logic programming exploration of metabolic networks to explain microbial community models

Chabname Ghassemi Nedjad, Loïc Paulevé, Clémence Frioux

► To cite this version:

Chabname Ghassemi Nedjad, Loïc Paulevé, Clémence Frioux. A logic programming exploration of metabolic networks to explain microbial community models. GT Bioss 2022 - Journée annuelle du Groupe de Travail sur la Biologie Systémique Symbolique, Nov 2022, Nantes, France. hal-03910483

HAL Id: hal-03910483

<https://inria.hal.science/hal-03910483>

Submitted on 22 Dec 2022

HAL is a multi-disciplinary open access archive for the deposit and dissemination of scientific research documents, whether they are published or not. The documents may come from teaching and research institutions in France or abroad, or from public or private research centers.

L'archive ouverte pluridisciplinaire **HAL**, est destinée au dépôt et à la diffusion de documents scientifiques de niveau recherche, publiés ou non, émanant des établissements d'enseignement et de recherche français ou étrangers, des laboratoires publics ou privés.

Inria

GT Bioss - Nantes

PhD student : Chabname GHASSEMI (LaBRI / Inria)

Co-directors : Loïc PAULEVE (LaBRI)

Clémence FRIOUX (Inria)

A logic programming exploration
of metabolic networks to explain
microbial community models

LaBRI

Introduction

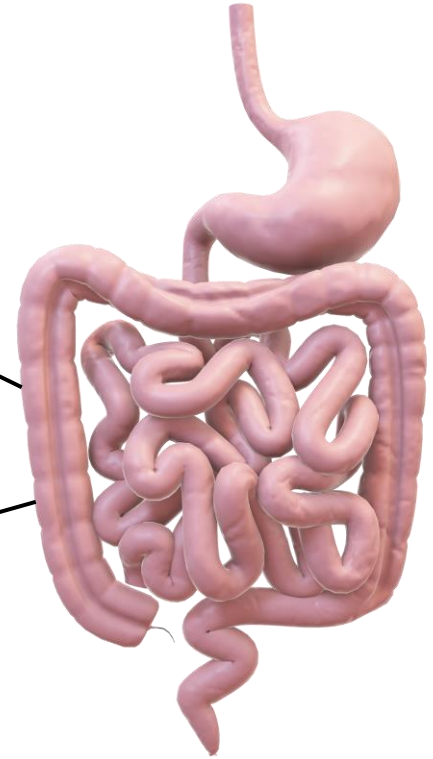
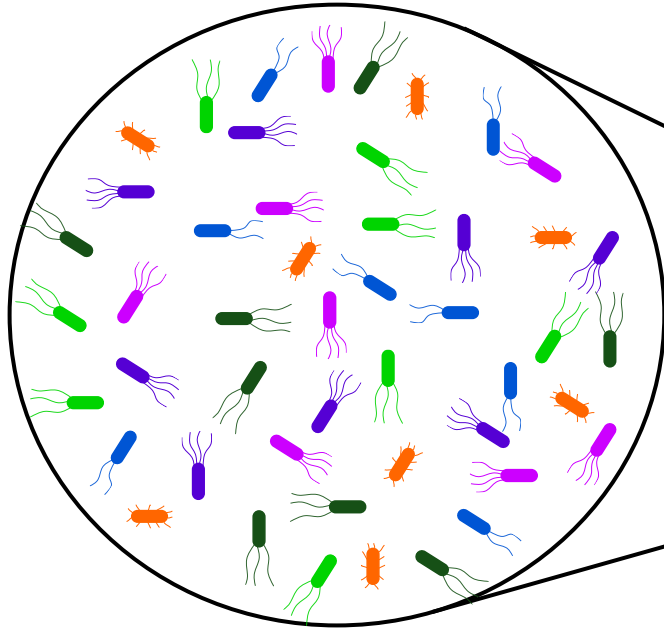

Introduction

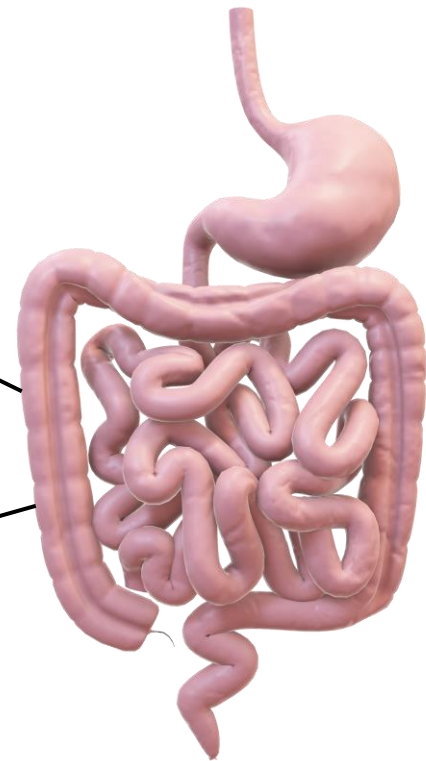
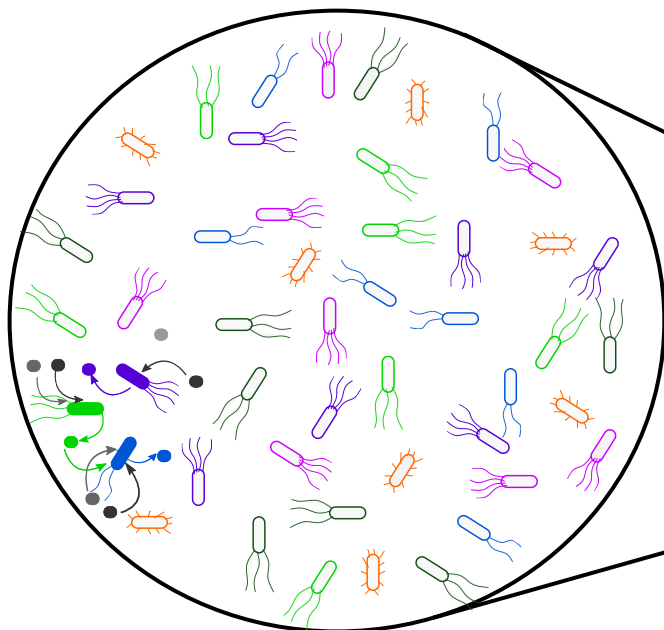

Interactions between bacteria through metabolite production and consumption

Introduction

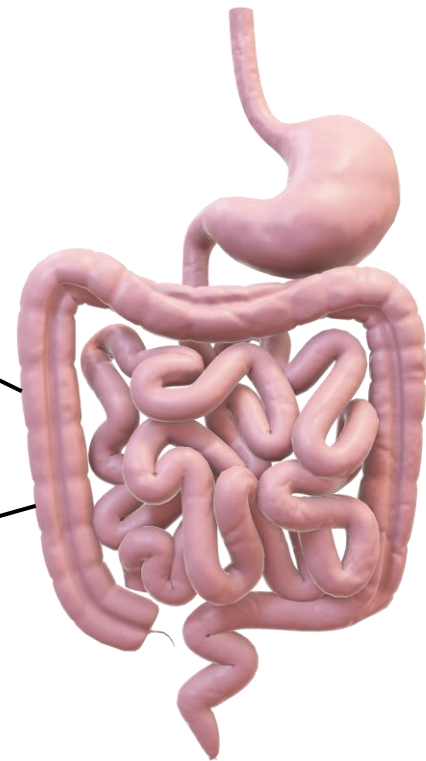
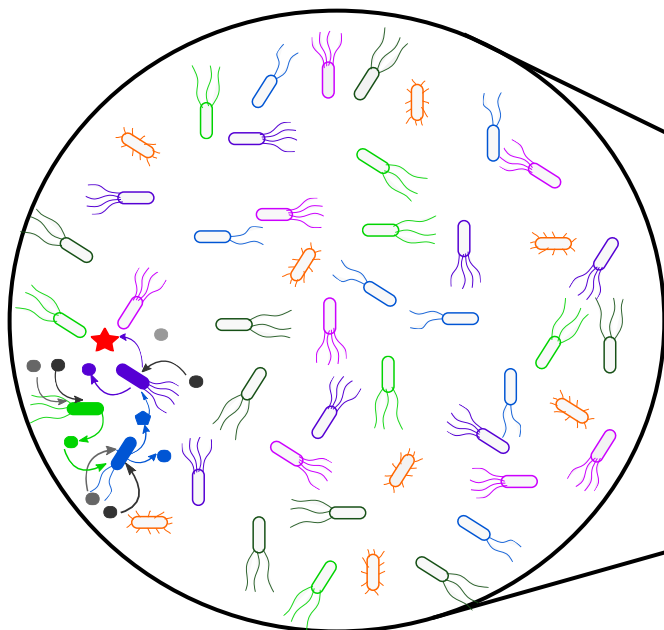

Smaller communities are responsible for functions of interest via mutualistic interactions

Genome Scale Metabolic Networks (GSMNs)

How to represent metabolism ?

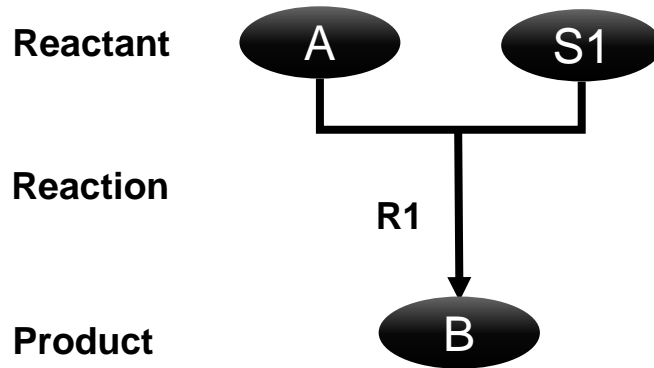

GSMNs : set of hundreds of reactions associated to a genome

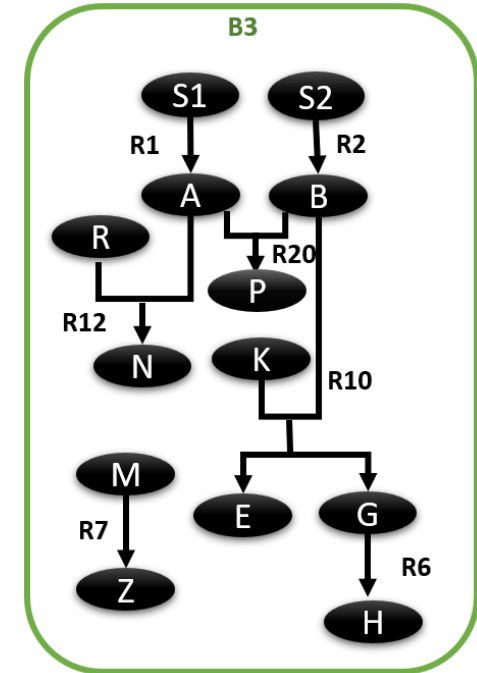

Individual Scope

Boolean abstraction of metabolic producibility
in an environment

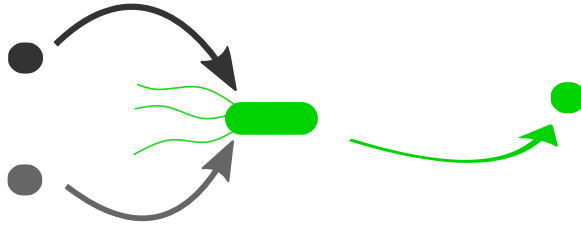

Metabolites produced by individual species

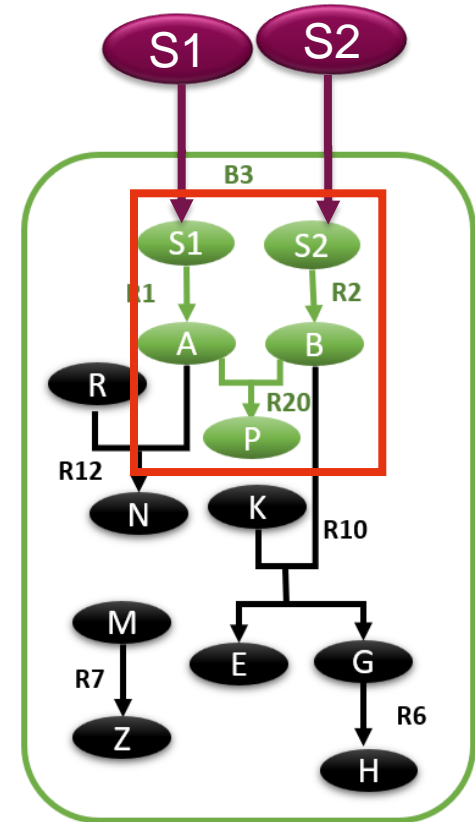

Logic programming to model metabolism

Use of Answer Set Programming (ASP)

Reasoning on knowledge and solving combinatorial problems

ATOMS

```
bacteria("B3").
species("M_A_c", "A", "c", "B3").
reaction("R12", " B3").
reactant ("M_A_c", "R12", "B3").
reactant ("M_R_c", "R12", "B3").
product("M_N_c", "R12", "B3").

seed("S1").
seed("S2").
```

RULES

```
iscope(M,S,B) :- seed(M), species(M,S,_,B),
                 bacteria(B).
iscope(M,S,B) :- bacteria (B), product(M,R,B),
                 reaction(R,B), species(M,S,_,B),
                 iscope(M2,S2,B) : reactant(M2,R,B).
```

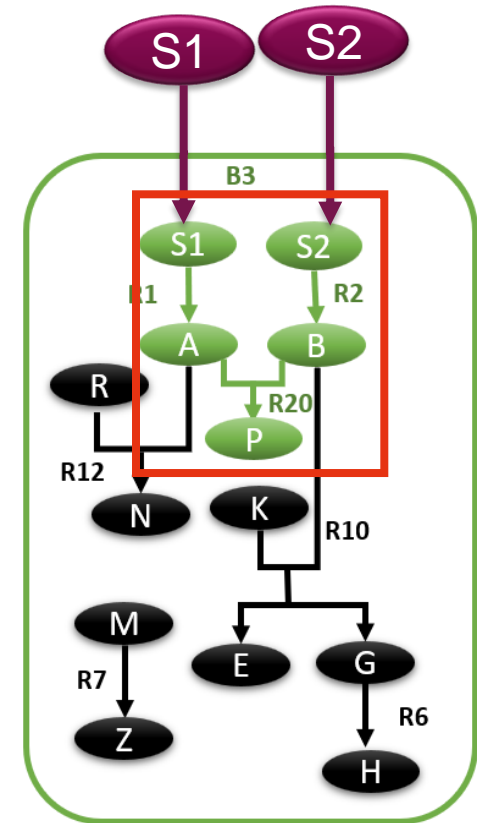

Community of bacteria

Hundreds of bacteria live in an environment

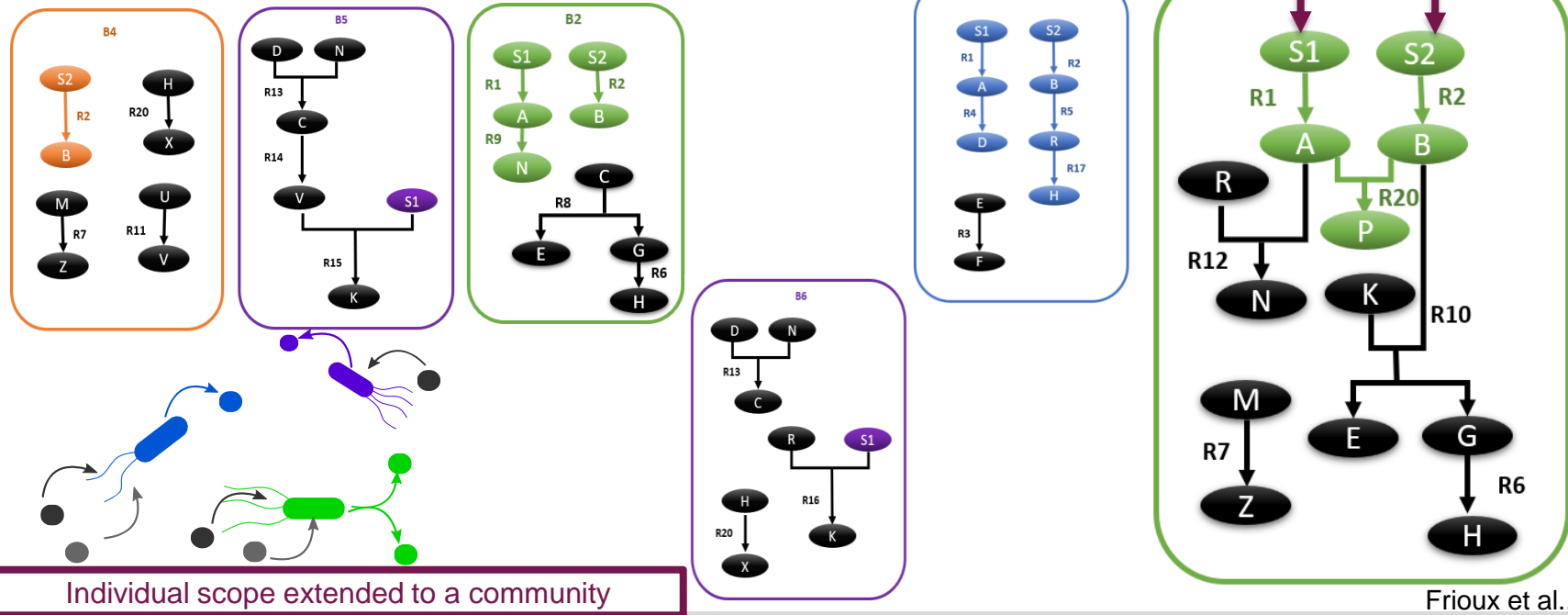

Individual scope extended to a community

Frioux et al., 2018

Community of bacteria

Cooperation between bacteria

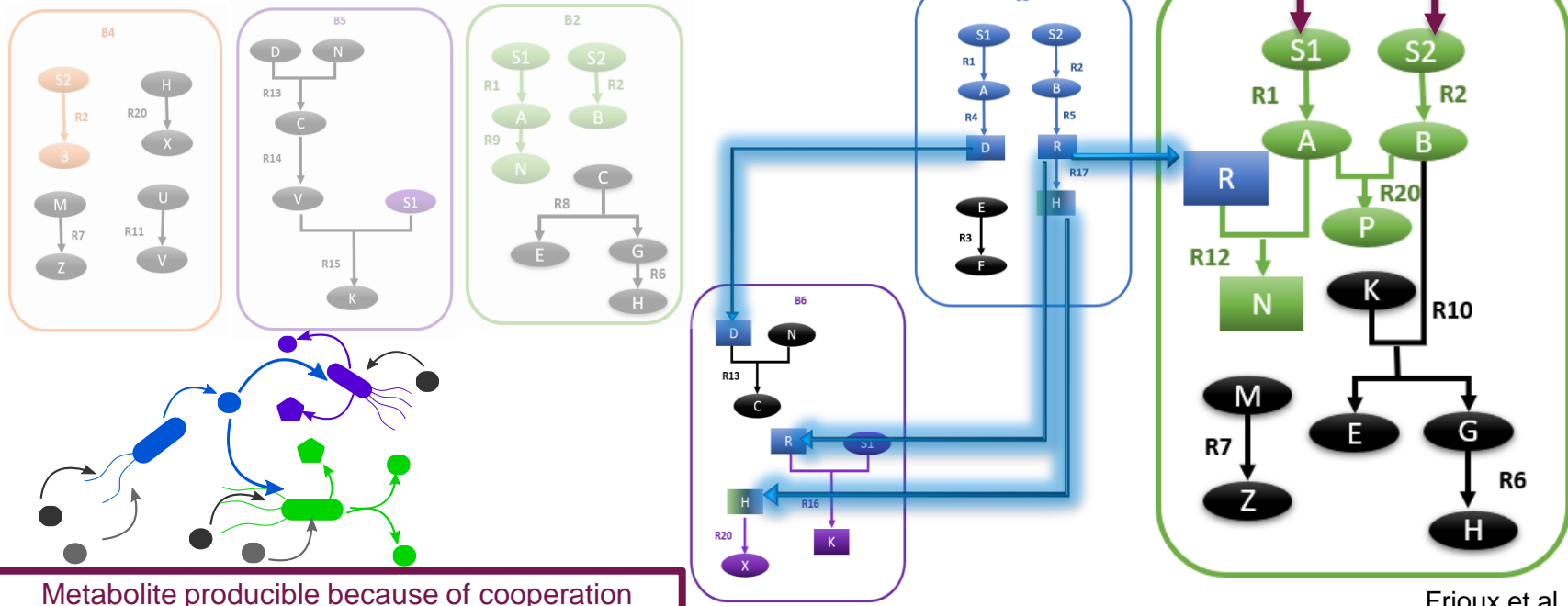

Frioux et al., 2018

Community of bacteria

Metabolic potential

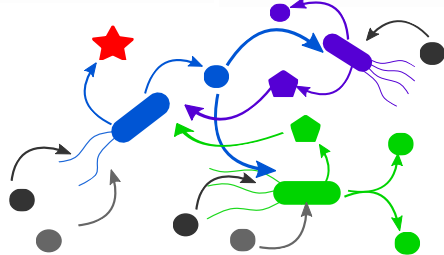
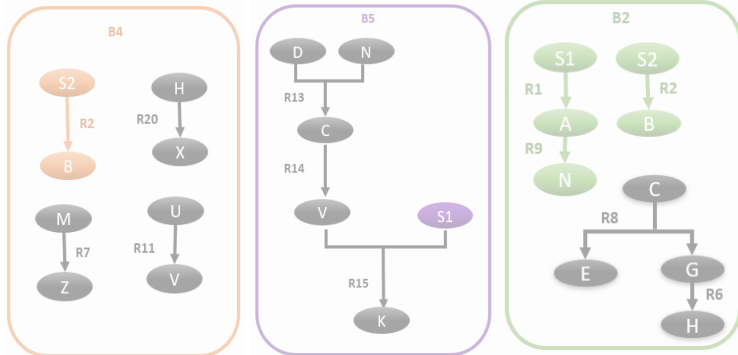

Target metabolites become producible through metabolites exchanges

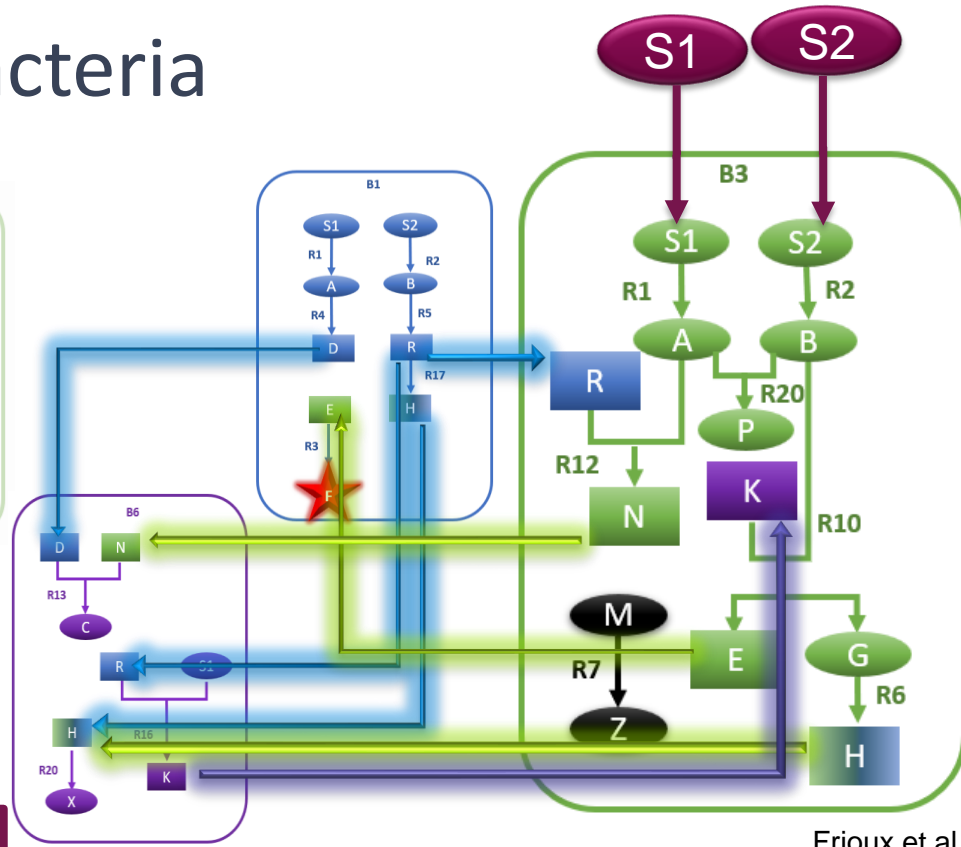

Frioux et al., 2018

Effect of Metabolic redundancy on community selection

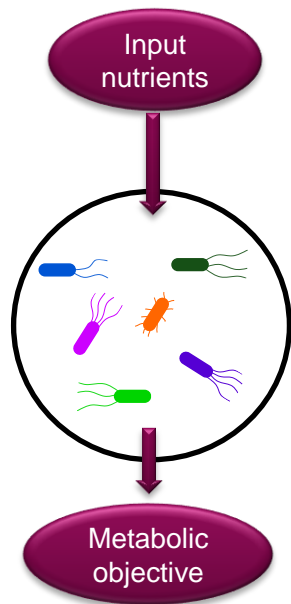

Community identified with metabolic potential to produce a target
Redundancy of metabolism in different species

Frioux et al., 2018
Belcour, Frioux et al. 2020

Effect of Metabolic redundancy on community selection

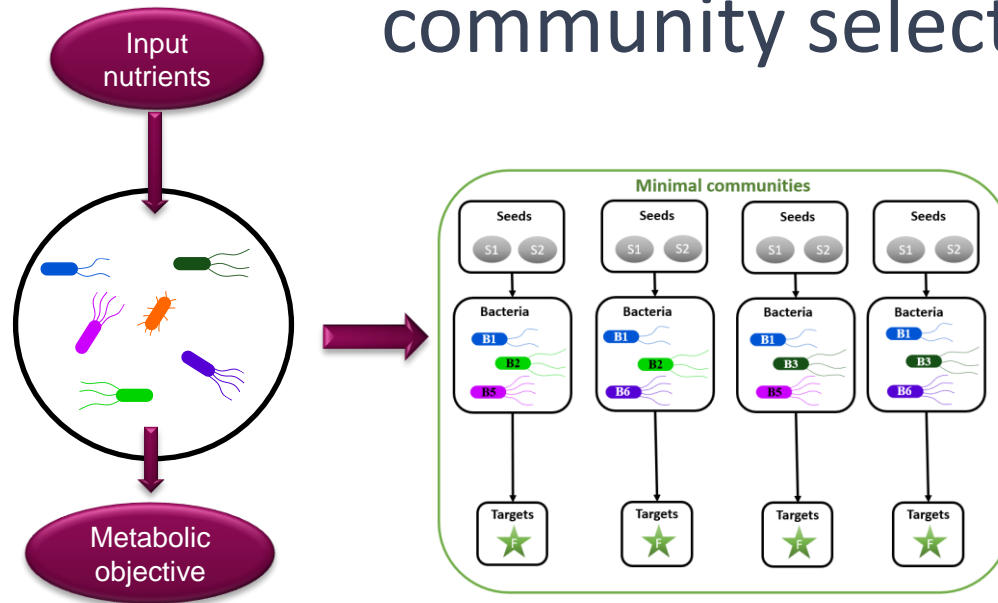

Community identified with metabolic potential to produce a target
Redundancy of metabolism in different species

Frioux et al., 2018
Belcour, Frioux et al. 2020

Effect of Metabolic redundancy on community selection

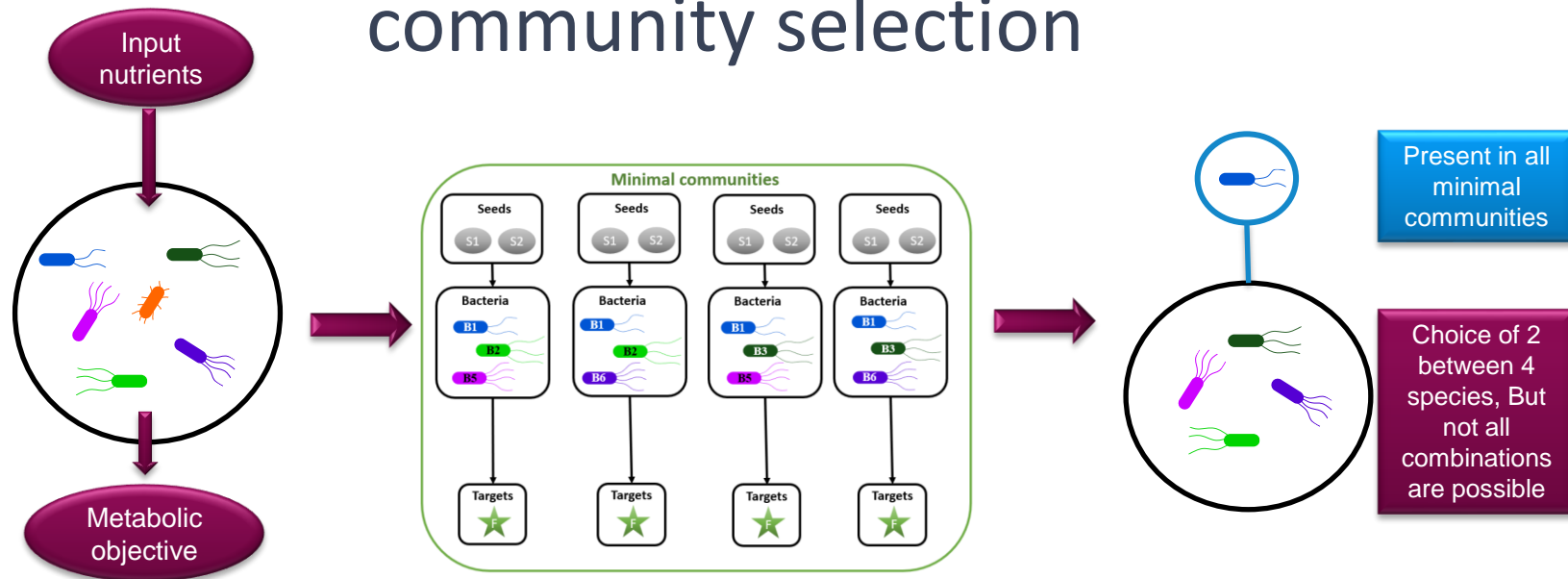

Community identified with metabolic potential to produce a target
Redundancy of metabolism in different species

Frioux et al., 2018
Belcour, Frioux et al. 2020

Effect of Metabolic redundancy on community selection

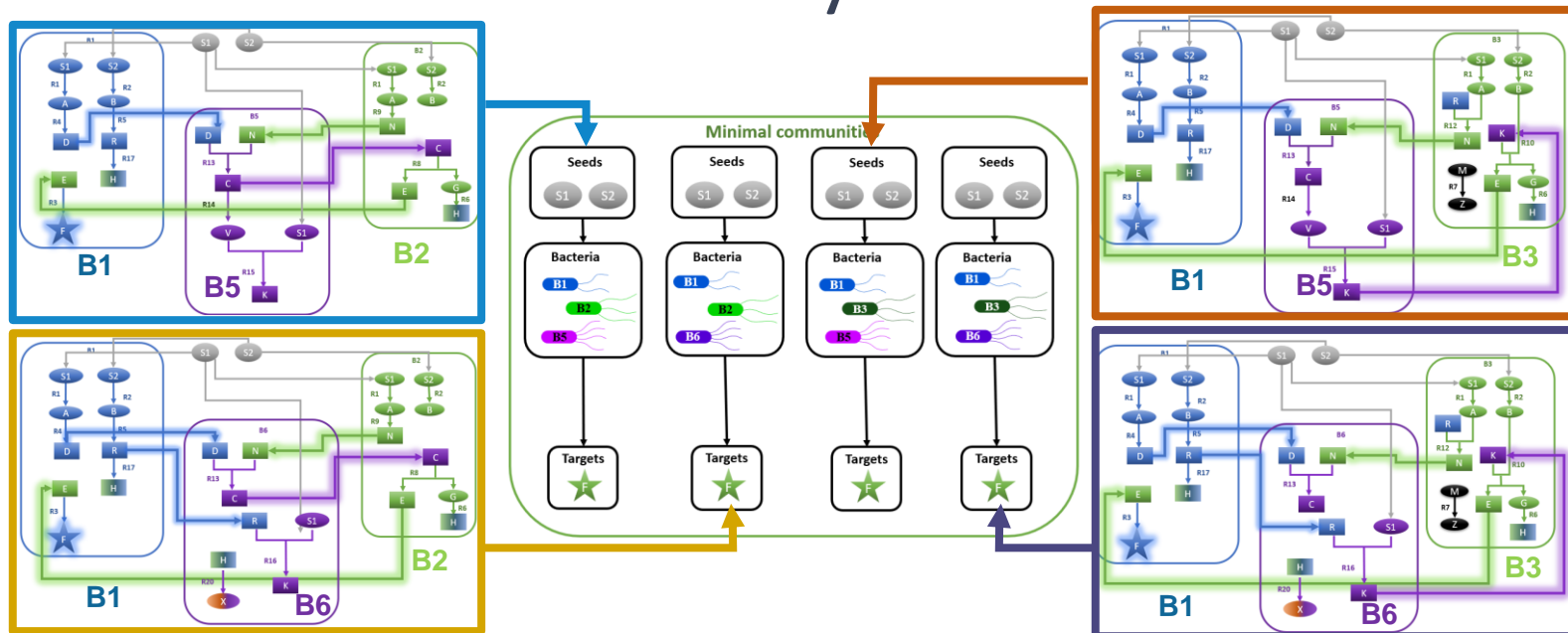

Mechanistic model to predict smaller communities

Frioux et al., 2018
Belcour, Frioux et al. 2020

How visualize all communities

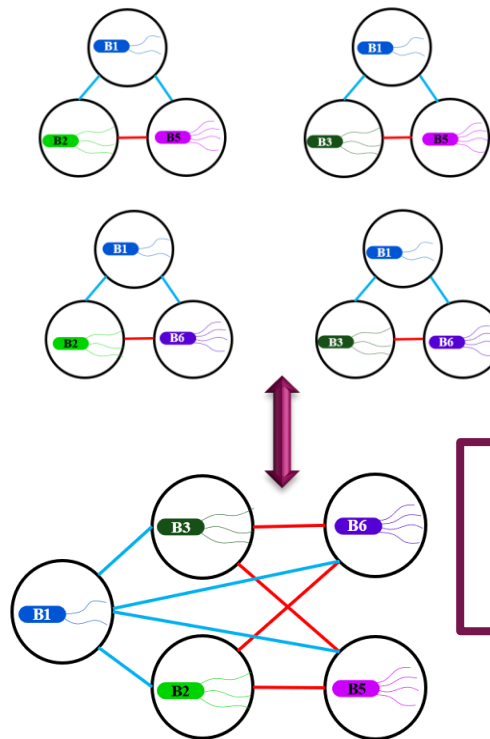
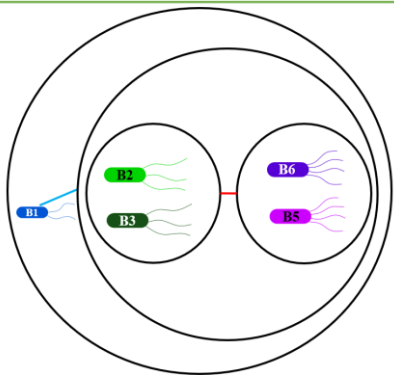
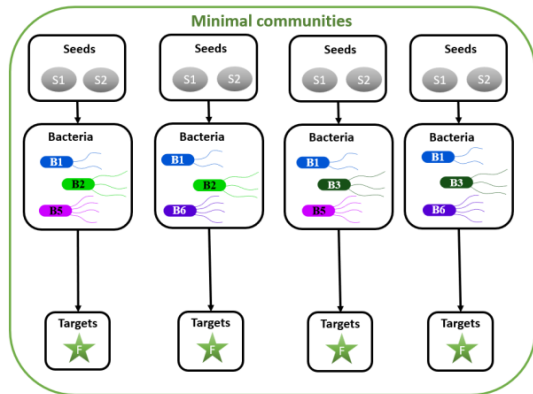

Power Graph: Association graph compression reveals groups of equivalence and essential symbionts

Royer et al., 2008
Belcour, Frioux et al., 2020

Metage2Metabo: Application on real data

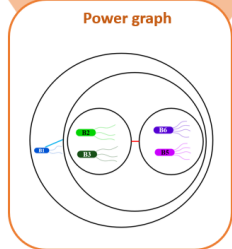
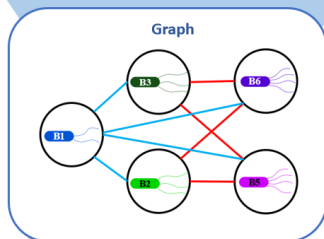
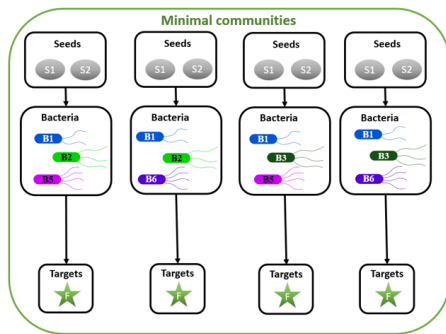

Lipids

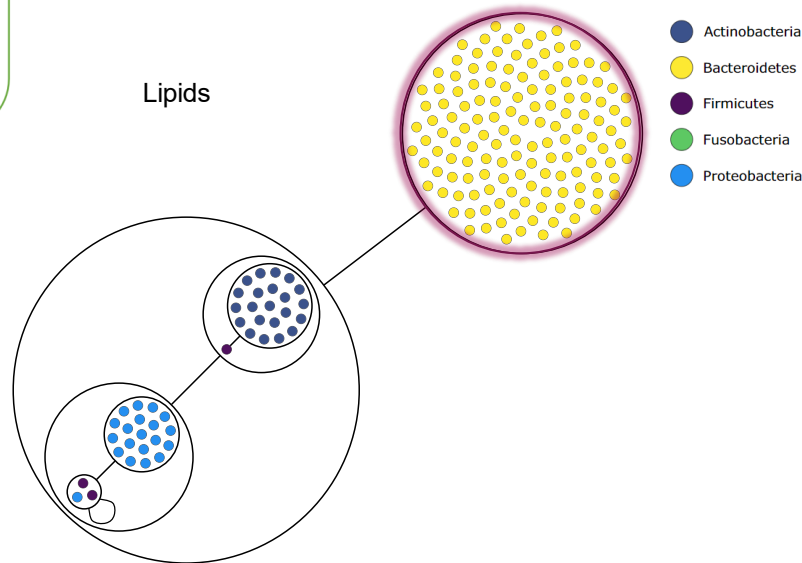

How visualize all communities?

Scaling up to 1,500 bacteria, with a set of 27 lipids as targets

- Community structure
 - > 185 bacteria involved
 - > 7 bacteria per community
 - > 58,520 communities

Belcour, Frioux et al., 2020

Functions not identified on equivalence group.
Why the species are equivalent ?

Internship work

Explainable models of minimal community assembly

What functions are carried by a group of equivalence?

Which metabolites are redundant between species?

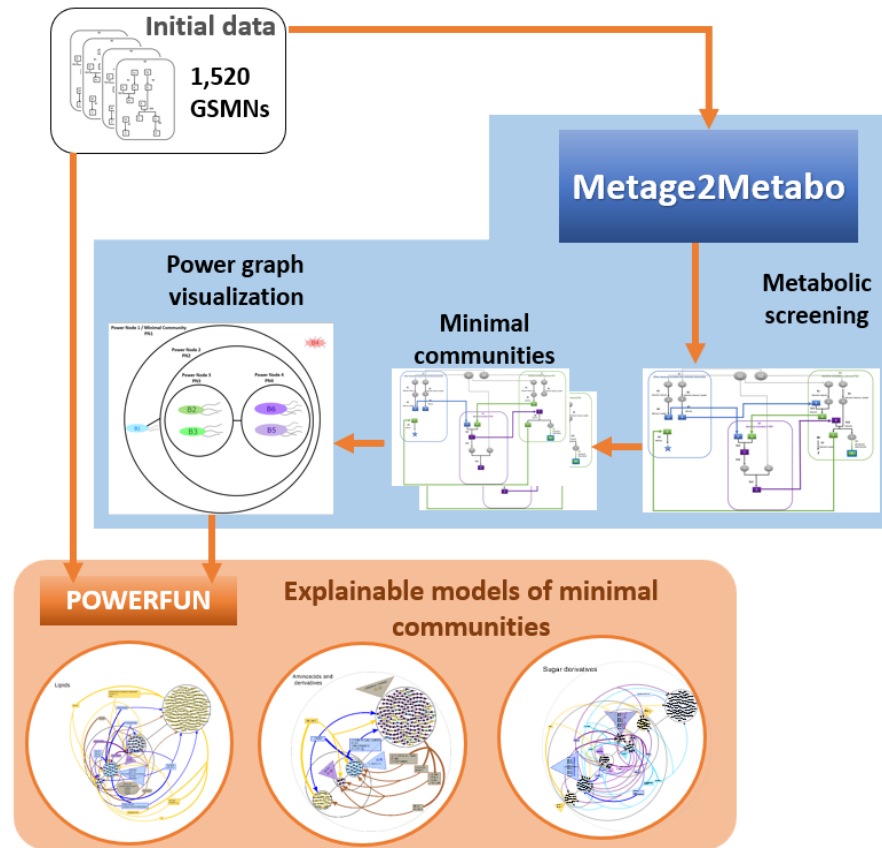

Equivalence group: metabolite produced by a reaction both existing only on a node

Which functions are carried by equivalence group ?

Rules to reveal shared functions of a group of bacteria

- Metareact: unique reaction producing unique metabolite

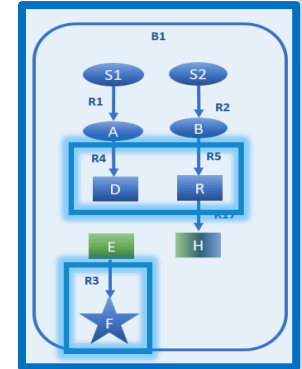
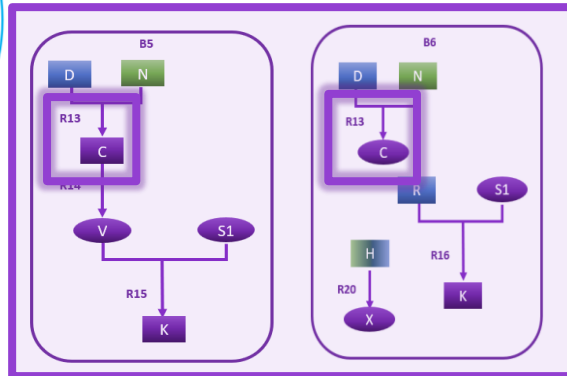
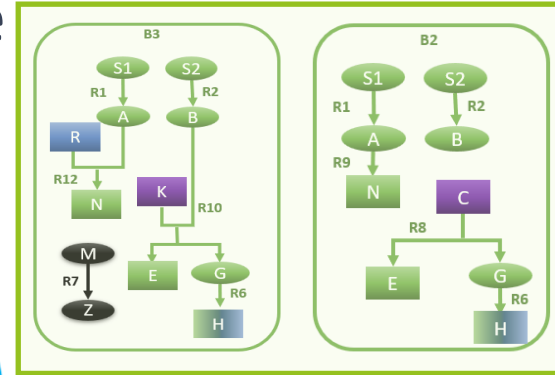
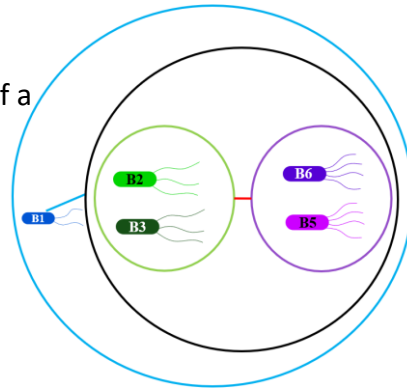

Equivalence group: node specific producible metabolites

Which functions are carried by equivalence group ?

Rules to reveal shared functions of a group of bacteria

- Metareact: unique reaction producing unique metabolite
- Node specific metabolite

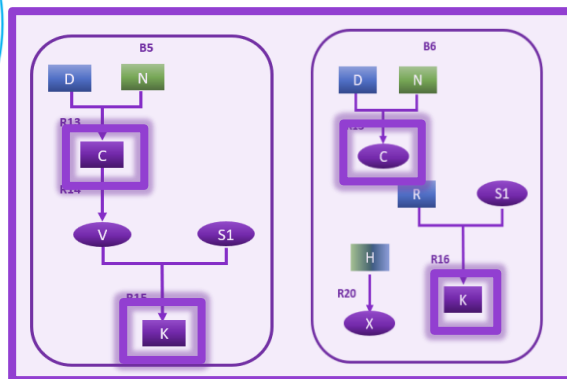
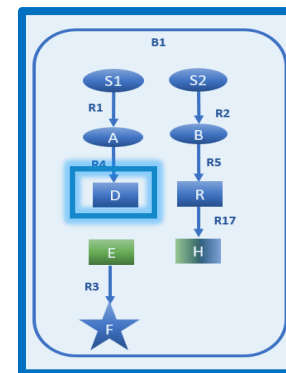
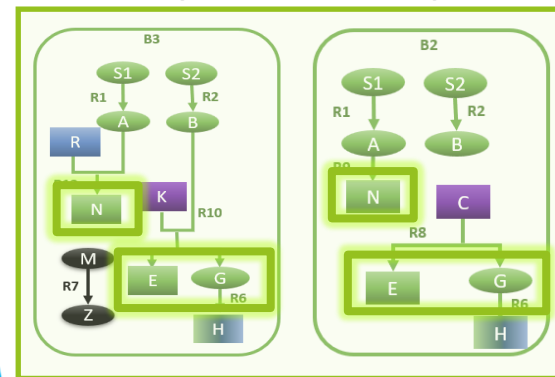
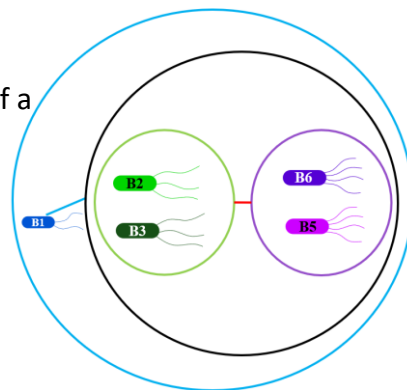

Equivalence group: node specific activated reactions

Which functions are carried by equivalence group ?

Rules to reveal shared functions of a group of bacteria

- Metareact: unique reaction producing unique metabolite
- Node specific metabolite
- Node specific reaction

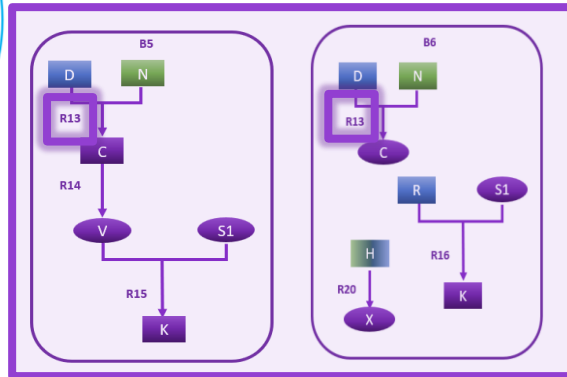
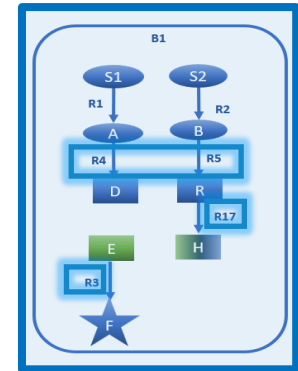
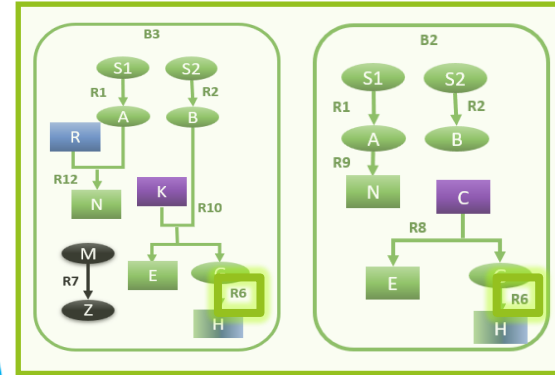
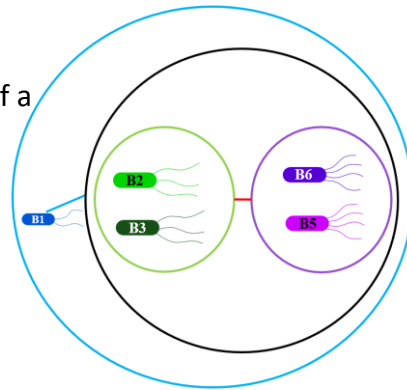

PowerFun: Powernodes Functions

ASP based tool to explain assembly and redundancy of microbial communities with logic programming

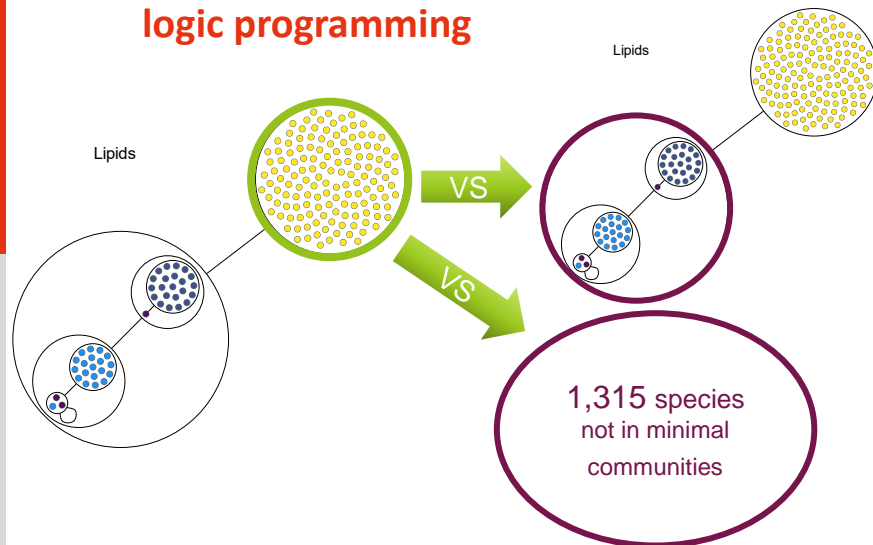

From genome to shared functions of bacteria on minimal communities

ATOMS

```
powernode(P,T).
included(B,P).
```

RULES

```
1{selected_pwrn(P) : powernode(P), included(B,P), bacteria(B)}1.
selected_bact(B,P) :- bacteria(B), included(B,P),
                    selected_pwrn(P).

producible_by_select(M,B) :- select_activ_reaction(R,B),
                             product(M,R,B).
producible_by_other(M,B) :- other_activ_reaction(R,B),
                             product(M,R,B).
producible_only_select(M,B) :- producible_by_select(M,B),
                              not producible_by_other(M,_).

prod_only_all_select(M) :-
    producible_only_select(M,B1) : selected_bact(B1,_);
    producible_only_select(M,B2) : selected_bact(B2,_);
    producible_only_select(M,B1), producible_only_select(M,B2),
    B1 != B2.
prod_only_all_select(M) :- nb_selected_bact(N), N=1;
    producible_only_select(M,B).
```

<https://gitlab.inria.fr/pleiade/powerfun>

Application on real data

PowerFun computed for the lipids powergraph

Data and performance

- 30 min to compute (1CPU, 50GB)
- 85 node specific reactions, 24 activated
- 209 node specific metabolites, 139 carried by one powernode

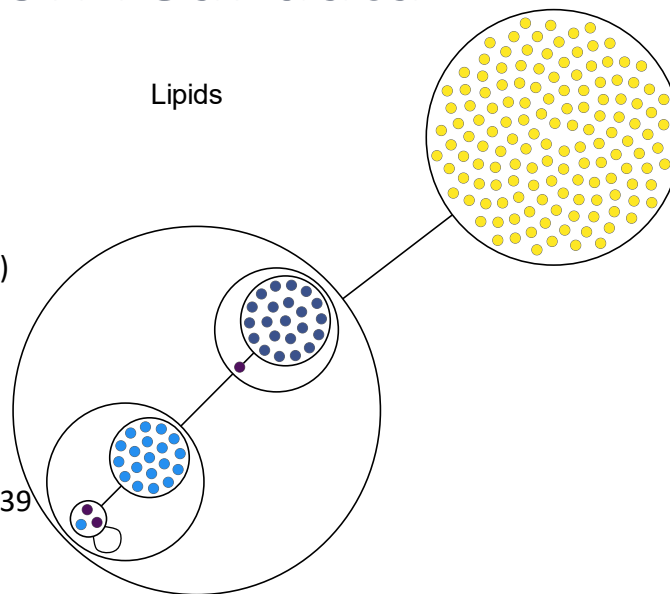

- Actinobacteria
- Bacteroidetes
- Firmicutes
- Fusobacteria
- Proteobacteria

1,500 bacteria, with a set of 27 lipids as targets

- Community structure
 - > 185 bacteria involved
 - > 7 bacteria per community
 - > 58,520 communities

Scaling up and analyses of node specific metabolite and reactions

Node specific metabolites

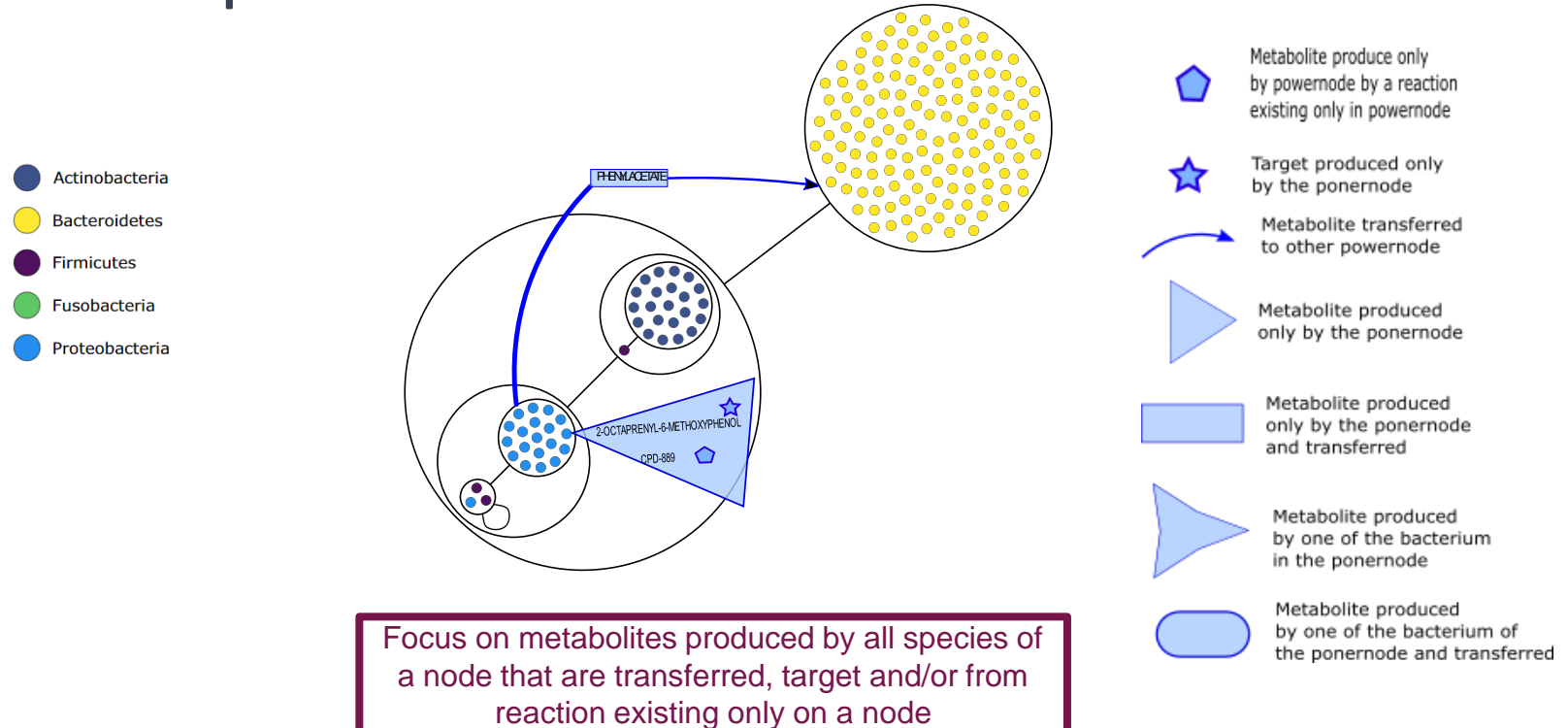

Application on real data: Power nodes flow

- Actinobacteria
- Bacteroidetes
- Firmicutes
- Fusobacteria
- Proteobacteria

Equivalence group produces alone a set of targets or transfers node specific metabolites

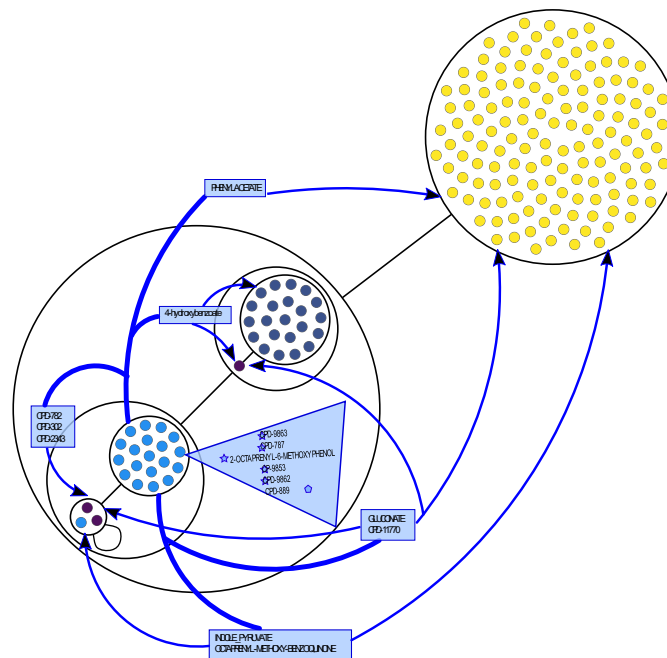

- ⬠ Metabolite produce only by powermode by a reaction existing only in powermode
- ★ Target produced only by the ponernode
- Metabolite transferred to other powernode
- ▶ Metabolite produced only by the ponernode
- ▭ Metabolite produced only by the ponernode and transferred
- ◃ Metabolite produced by one of the bacterium in the ponernode
- ◌ Metabolite produced by one of the bacterium of the ponernode and transferred

Application on real data: Power nodes flow

- Actinobacteria
- Bacteroidetes
- Firmicutes
- Fusobacteria
- Proteobacteria

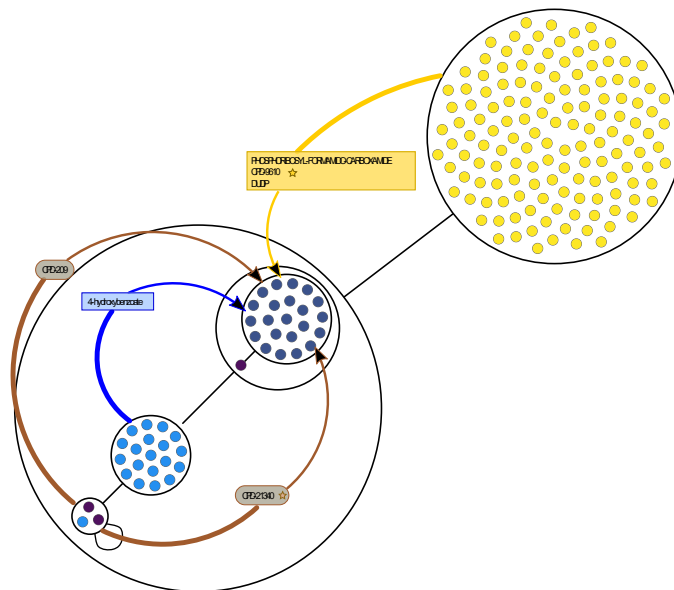

- ⬠ Metabolite produce only by powermode by a reaction existing only in powermode
- ★ Target produced only by the ponernode
- Metabolite transferred to other powernode
- ▶ Metabolite produced only by the ponernode
- ▭ Metabolite produced only by the ponernode and transferred
- ◀ Metabolite produced by one of the bacterium in the ponernode
- ◻ Metabolite produced by one of the bacterium of the ponernode and transferred

Power node not explained by defined rules: no specific metabolites produced by the node

Application on real data: Complete flow

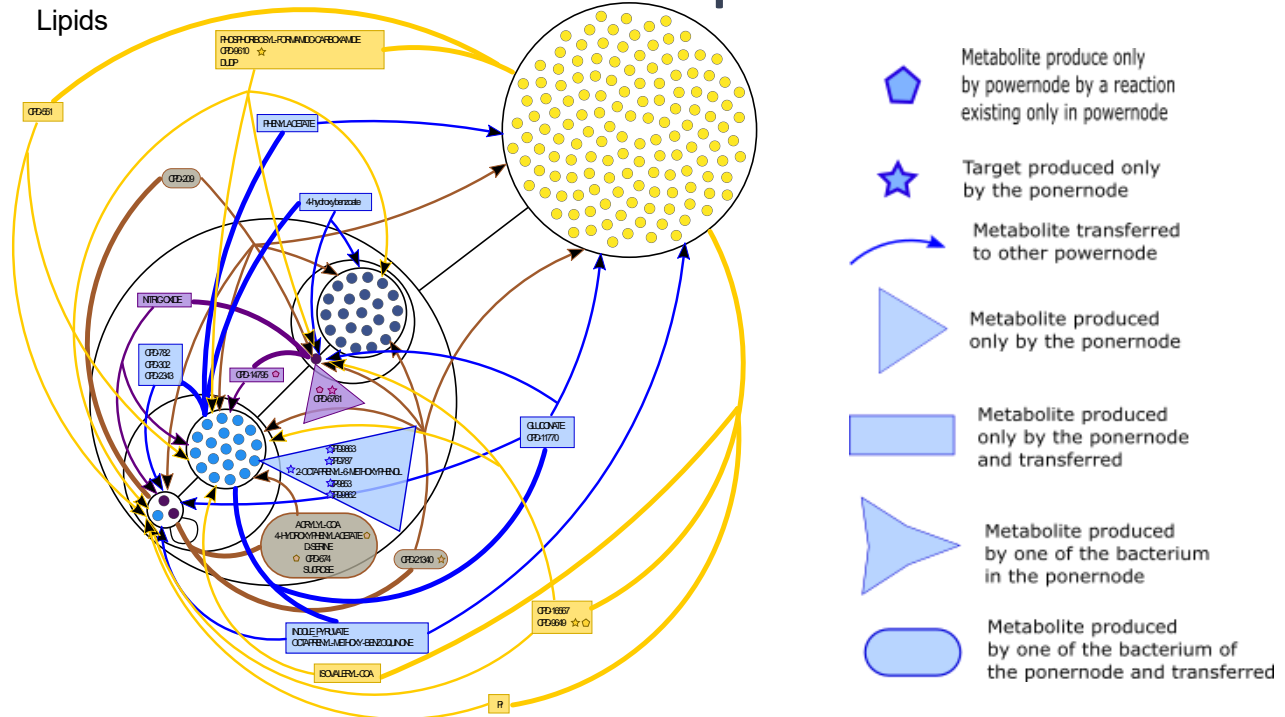

Complex model of node specific metabolite production and transfers for a small community

Discussion

- PowerFun is able to explain equivalence group of species
- Some groups are not explained
- Explainable models remain complex

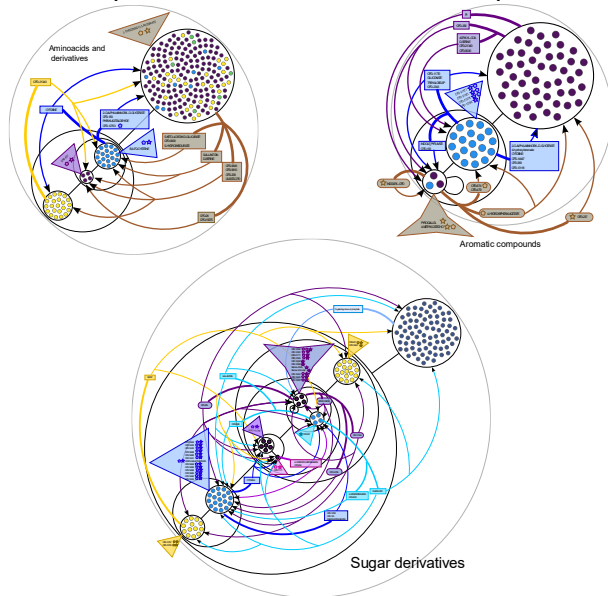

Discussion

- PowerFun is able to explain equivalence group of species
- Some groups are not explained
- Explainable models remain complex

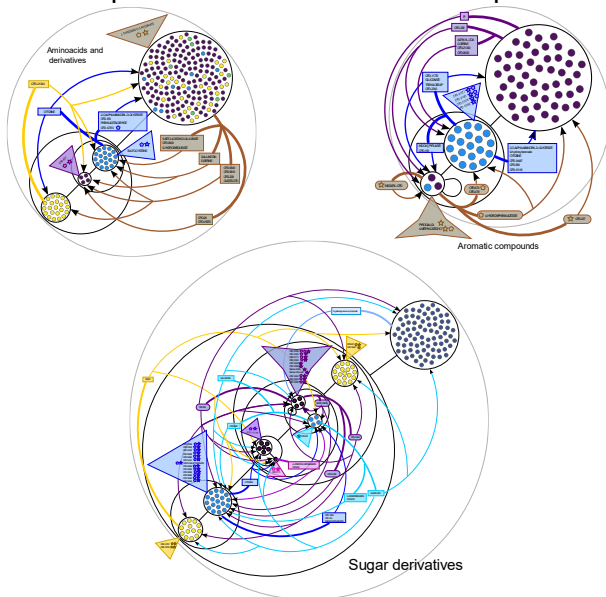

Perspectives

- Define new rules and models: A non-explained group can have two different metabolite activating different path

completion

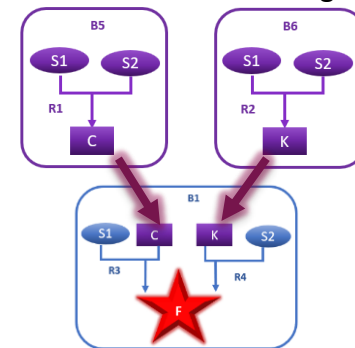
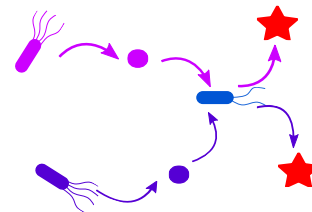

Discussion

- PowerFun is able to explain equivalence group of species
- Some groups are not explained
- Explainable models remain complex

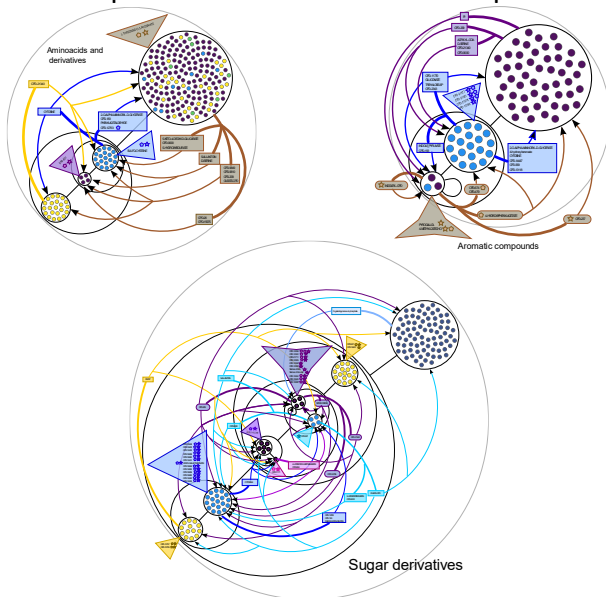

Perspectives

- Define new rules and models: A non-explained group can have two different metabolite activating different path

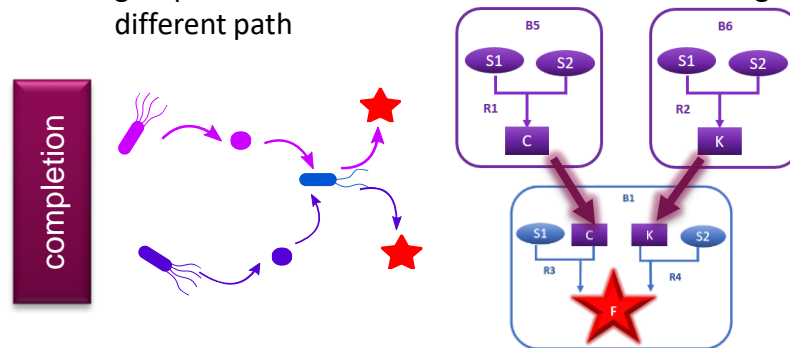

- Constrain definition of exchange metabolites

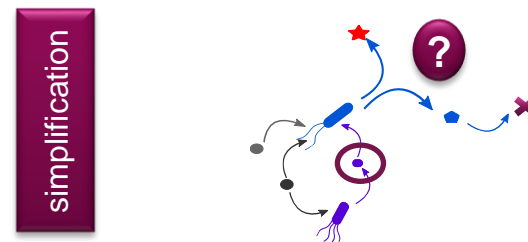

Thank You!

Team Pleiade