



**HAL**  
open science

## Efficient Association of Low and High RF Power Rectifiers for Powering Ultra-Low Power Devices

Jesus Argote-Aguilar, Florin-Doru Hutu, Guillaume Villemaud, Matthieu Gautier, Olivier Berder

► **To cite this version:**

Jesus Argote-Aguilar, Florin-Doru Hutu, Guillaume Villemaud, Matthieu Gautier, Olivier Berder. Efficient Association of Low and High RF Power Rectifiers for Powering Ultra-Low Power Devices. ICECS 2022 - IEEE International Conference on Electronics Circuits and Systems, Oct 2022, Glasgow, United Kingdom. pp.1-4. hal-03845342

**HAL Id: hal-03845342**

<https://inria.hal.science/hal-03845342v1>

Submitted on 9 Nov 2022

**HAL** is a multi-disciplinary open access archive for the deposit and dissemination of scientific research documents, whether they are published or not. The documents may come from teaching and research institutions in France or abroad, or from public or private research centers.

L'archive ouverte pluridisciplinaire **HAL**, est destinée au dépôt et à la diffusion de documents scientifiques de niveau recherche, publiés ou non, émanant des établissements d'enseignement et de recherche français ou étrangers, des laboratoires publics ou privés.



Distributed under a Creative Commons Attribution 4.0 International License

# Efficient Association of Low and High RF Power Rectifiers for Powering Ultra-Low Power Devices

Jesus Argote-Aguilar<sup>\*†</sup>, Florin-Doru Hutu<sup>\*</sup>, Guillaume Villemaud<sup>\*</sup>, Matthieu Gautier<sup>†</sup> and Olivier Berder<sup>†</sup>

<sup>\*</sup> Univ Lyon, INSA Lyon, Inria, CITI, EA3720, 69621 Villeurbanne, France, *name.surname@insa-lyon.fr*

<sup>†</sup> Univ Rennes, CNRS, IRISA, *name.surname@irisa.fr*

**Abstract**—Nowadays, the efficiency of Radio Frequency (RF) energy harvesting circuits is continuously increasing and, at the same time, the energy consumption of connected devices is drastically decreasing. Despite that, collecting, storing and delivering such kind of harvested energy to the device in an appropriate manner is still a challenge. This paper presents the design of a harvester able to efficiently collect energy from both low and high power levels of the RF field. The objective is to correctly power supply an ultra-low power consumption device requiring a regulated voltage. A RF harvester circuit, specially designed for our application and consisting in the association of a low and a high level power rectifier, is presented. By the means of a circulator and depending on the RF power level received at the input port of the RF harvester circuit, the RF power is absorbed by the low power rectifier or reflected to the high power rectifier. The rectifiers have their outputs associated in series. At a frequency of 868 MHz, the efficiencies of the association of rectifiers are 43% and 76% and were obtained for input powers of -20 dBm and 0 dBm respectively.

**Index Terms**—rectifier, wireless power transfer, power management integrated circuit, circulator, series rectifier association.

## I. INTRODUCTION

In a context of an increasing deployment of the Internet of Things (IoT), replacing the battery of billions of connected devices is an expensive and exhausting task. Powering low power connected devices with alternative power sources like solar, vibration or Radio Frequency (RF) energy avoids the use of batteries or increases their lifetime. For example, [1] allows a Wireless Sensor Node (WSN) to efficiently use the energy harvested from ambient sources (e.g. solar, wind, vibration). Indeed, the power consumption of the connected devices is decreasing and powering them with the power extracted from the RF field became feasible. However, a continuous regulated voltage is often required which may considerably increase the required power. With the goal to power ultra-low power devices with RF energy, Power Management Integrated Circuits (PMIC) appear as an efficient solution to both regulate and store the collected energy from the RF field. Efforts have been made to improve the efficiency and reduce the quiescent power of PMIC for low power applications. In [2], the authors measured an overall PMIC efficiency of 20% for a DC available power of  $4.5\mu\text{W}$ . Commercial PMIC appear as an adequate solution for low power applications. For instance, the PMIC BQ25570 from Texas Instruments has been used in [3], the authors measured a quiescent current of 500 nA which, depending on the storage element, corresponds to a quiescent

power between 850 nW and  $2\mu\text{W}$  (without considering the losses in the buck converter of this PMIC). In the present paper, the impact of the output impedance of the rectifier in the quiescent power of the PMIC BQ25570 while it powers loads consuming hundreds of nW and requiring a continuous regulated voltage is studied.

With regard to the harvesting circuit, the use of two rectifiers, each one optimized and matched for a specific power level, has already been studied in [4]. With the goal to harvest RF energy from an extended power range, the authors use a circulator to connect the rectifiers with a single antenna and harvest RF powers from -20 dBm to 10 dBm. However, each rectifier has its own load and it is not possible to collect energy for a single device. In [5], Fully Depleted Silicon On Insulator (FD-SOI) 28 nW rectifiers optimized for a specific band of frequency are associated in series to a single load. The drawback is that the quantity of required antennas (one per rectifier) does not allow a compact solution.

The present paper combines both techniques where the power received by a single antenna at a central frequency of 868 MHz is distributed by the means of a circulator to the rectifiers which at their outputs are associated in series to be efficiently connected to the PMIC BQ25570. The solution is designed with off the shelf components and is able to harvest RF energy from -20 dBm to 0 dBm which may be associated to a Wireless Power Transfer (WPT) and a Self-Energy Recycling (S-ER) [6] scenarios respectively.

The paper is organized as follows: Section II introduces the proposed architecture, Section III presents the features and measurement results of the commercial PMIC BQ25570 from Texas Instruments, Section IV describes the design considerations of the association of rectifiers and Section V concludes this paper.

## II. PROPOSED RF HARVESTING ARCHITECTURE

Aiming to harvest RF power from -20 dBm to 0 dBm, the design of a rectifier for each power level is considered. The system is intended to receive the RF power from a single antenna which is then distributed by a circulator to the appropriate rectifier. The schematic of the proposed architecture is depicted in Fig. 1. The two rectifiers are associated in series with their load that in our case is the PMIC BQ25570. The received power levels may considerably vary (depending on the propagation channel conditions). Since the output voltage of a rectifier depends on its input power, the use of a

voltage regulator is mandatory and the use of a PMIC appears as an appropriate solution. The PMIC provides an output regulated voltage independently of its input power and the power consumed by its load. Furthermore, the PMIC allows to appropriately load a rectifier as explained in Section III.

### III. POWER MANAGEMENT INTEGRATED CIRCUIT MEASUREMENTS

In the context of the envisaged application, three functionalities offered by a PMIC are identified: the Maximum Power Point Tracking (MPPT) which enables a PMIC to efficiently load a rectifier for maximizing its RF/DC conversion efficiency, the management of the collected energy (among its load and a storage element) and the functionality that ensures the supply of a regulated output voltage to the load. These functions are enabled when the PMIC is in its Normal Mode (NM) state after exiting its Cold Start (CS) state which harvests energy in a less efficient way, although necessary to collect the minimal energy required by the former state. In this paper, the measured features of the BQ25570 in NM are presented. Concerning the output impedance  $Z_{rect-out}$ , the authors of [7] claim that a rectifier may be modeled by a voltage source in series with its internal resistor  $R_{int}$  and conclude that a maximum transfer of power occurs when the rectifier load has the same value as  $R_{int}$ . Aiming to study the influence of  $R_{int}$  in the minimal voltage  $V_{pmic-in}$  and power  $P_{pmic-in}$  required by a PMIC in NM while loaded by a resistor emulating a power consumption of 324 nW, the BQ25570 is connected to a voltage source in series with different values of resistors. These elements are modeling the RF rectifier, precisely,  $R_{int}$  is modeling  $Z_{rect-out}$ . To load the rectifier model with the same value of  $R_{int}$ , MPPT is set to 50% implying the output voltage of the rectifier model is fixed at half its open circuit voltage. Furthermore, a ceramic capacitor  $C_{store}$  of 100  $\mu\text{F}$  is used as storage element and its voltage  $V_{store}$  is set to 2.5 V (to limit leakage currents). The output voltage of the PMIC is set to a regulated voltage of 1.8 V. Results are showed in Fig. 2. It is observed that higher  $R_{int}$  require higher voltages, however decrease the power absorbed by the PMIC. Actually, a minimal  $P_{pmic-in}$  of 4.4  $\mu\text{W}$  and 2.9  $\mu\text{W}$  and a minimal  $V_{pmic-in}$  of 111 mV and 210 mV are obtained for a  $R_{int}$  of 2.2 k $\Omega$  and 20 k $\Omega$  respectively. Higher values of  $R_{int}$  do not reduce considerably the minimal power required by the PMIC, for example for a  $R_{int}$  of 47 k $\Omega$ , the BQ25570 absorbs 2.7  $\mu\text{W}$ . These results suggest that the rectifier must be designed with a  $Z_{rect-out}$  around 20 k $\Omega$ . Low  $Z_{rect-out}$  lead to higher quiescent PMIC powers and too high  $Z_{rect-out}$  may limit the efficiency of the rectifier.

### IV. LOW AND HIGH RF POWER RECTIFIERS CONNECTED IN SERIES

With the goal to harvest RF power from -20 dBm to 0 dBm, two rectifiers are designed for each level. As depicted in Fig. 3, using a circulator, low powers are absorbed by the top rectifier called here low power rectifier and high powers are reflected to the bottom rectifier called here high power rectifier. At their

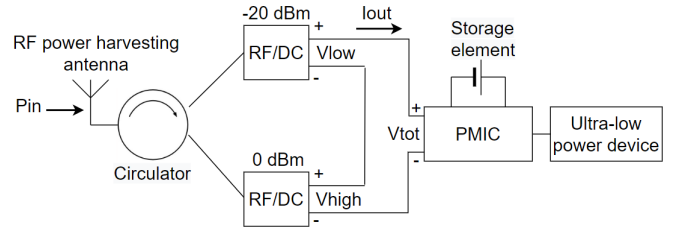

Fig. 1. Proposed architecture for energy harvesting from two different levels of the RF field and able to supply a regulated voltage.

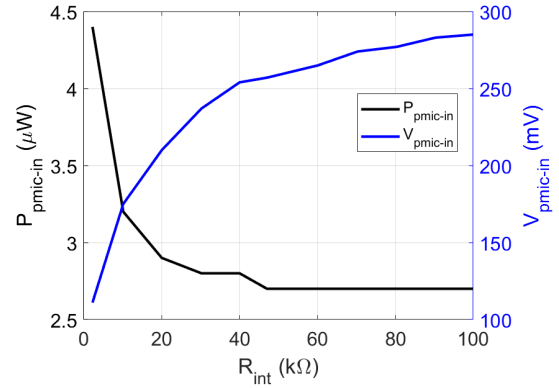

Fig. 2. Impact of the rectifier output impedance on the minimal input power and voltage required by the BQ25570 when loaded with a resistor emulating a consumption power of 324 nW.

outputs, both rectifiers are connected in series to a single load. This configuration is optimized by using the circuit simulator ADS Keysight software.

In this kind of circuit, the power at the input of the rectifiers is unbalanced meaning that the input power of one of the rectifiers is lower or higher than the other and the Voltage Reversal Effect (VRE) which is a negative voltage at the output of the rectifier receiving less power may appear. The rectifier for which the VRE appears acts as an undesired load dissipating power and decreases therefore the rectifier association efficiency.

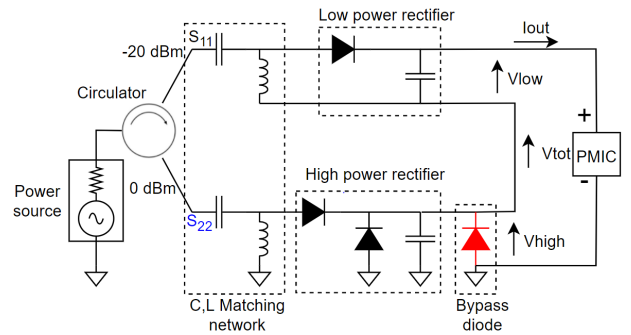

Fig. 3. Series rectifier association with a bypass diode at the output of the high power rectifier.

### A. Strategy to increase the rectifier association efficiency

First, the circuit in Fig. 3 is studied in simulation without any bypass diode. Fig. 4 shows the efficiencies of the low, high power rectifier and the overall efficiencies which are denoted  $Eff_{low-rect}$ ,  $Eff_{high-rect}$  and  $Eff_{tot}$  respectively. Efficiencies are calculated using

$$Eff_x = \frac{V_x * I_{out}}{P_{in}}, \quad (1)$$

where  $V_x$  is  $V_{low}$ ,  $V_{high}$  or  $V_{tot}$ ,  $I_{out}$  is the output current shared by both rectifiers and  $P_{in}$  is the received power at the input of the circulator (Fig. 3).

At -20 dBm, the high power rectifier receives less power and the VRE appears, implying this rectifier is consuming power and explaining its negative efficiency.

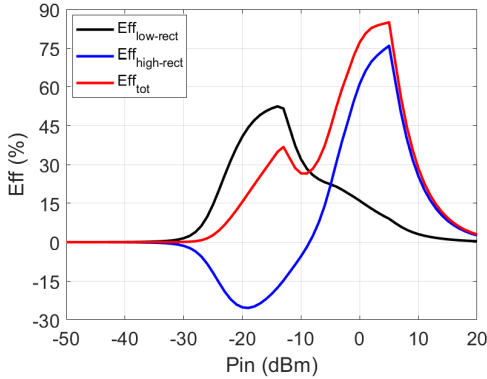

Fig. 4. Efficiencies of the low power rectifier, the high power rectifier and the series association as a function of the input power, without bypass.

At powers around 0 dBm, the VRE is not observed. These results are explained because at low powers, the high power rectifier does not receive enough power to produce considerable voltage at its output and the output current  $I_{out}$  circulating by its equivalent internal resistor  $R_{int-high}$  produces a negative voltage [5]. At high powers the low power rectifier receives enough power to maintain its output voltage positive face to the negative voltage produced by  $I_{out}$  on its equivalent internal resistor  $R_{int-low}$ . Consequently, to limit the VRE, a bypass diode is used, but only for the high power rectifier as depicted in Fig. 3.

When the voltage is positive at the output of the high power rectifier, the bypass diode remains open. However if this voltage is negative, this diode sets the high power rectifier in short-circuit. This configuration considerably decreases the VRE as showed in Fig. 5. Effectively, the negative efficiency of the high power rectifier at -20 dBm is increased from -25.2% to -7.1% which means the power dissipated in the high power rectifier is reduced.

### B. Design considerations of the rectifier association

Aiming to limit the quiescent power of the BQ25570, the series association of rectifiers is designed to present an optimal load around 20 k $\Omega$  which implies a  $Z_{rect-out}$  of the whole configuration around this value.

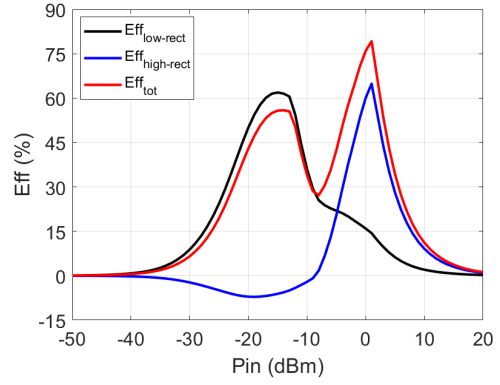

Fig. 5. Efficiencies of the low power rectifier, the high power rectifier and the series association as a function of the input power when a bypass diode is used.

In [8], without taking into account the matching network, the authors analytically demonstrate that series and voltage doubler rectifiers have an optimal load for different input voltages. Although this method allows to save time and find an optimal load in terms of efficiency, there are applications with rectifier output voltage or output impedance requirements. For instance, increasing the load of the rectifier increases the output voltage, while too high loads will reduce the efficiency. Moreover, for a specific frequency and input power, the input impedance of the rectifier depends on its load and it is possible to design a matching network which enables the rectifier to have a maximum power transfer for a specific load. In the present paper, the matching network was designed making a trade off between efficiency and a specific  $Z_{rect-out}$ . First, at a frequency of 868 MHz and for an input power of -20 dBm and 0 dBm respectively, the matching network of the low and high power rectifiers were separately designed to present a reflection coefficient  $S_{11}$  and  $S_{22}$  around -25 dB and a maximum power transfer at 20 k $\Omega$ . As a second step, both rectifiers are associated by the means of a circulator at their inputs and in series at their outputs. At 868 MHz, the marching network of the low and high power rectifiers are optimized in the association to present an optimal association load around 20 k $\Omega$  for -20 dBm and 0 dBm respectively. Furthermore, it was observed that the low power rectifier has a  $S_{11}$  over -3 dB for input powers over 0 dBm, assuring high power levels are reflected to the high power rectifier. A L matching network topology conformed by lumped components is used in all cases.

Fig. 6 shows the efficiency of the low power rectifier, high power rectifier and overall efficiency as a function of the rectifier load  $R_{rect-load}$ . These results show the optimal load of the series association are 24 k $\Omega$  and 21 k $\Omega$  for input powers of -20 dBm and 0 dBm respectively.

The authors in [9] show that Schottky SMS7630, HSMS2860 and HSMS2850 diodes are well suited for applications in the power range of -20 dBm to 10 dBm. As a consequence, this technology is chosen for the design of the proposed circuit. As showed in Fig. 3, the low power rectifier

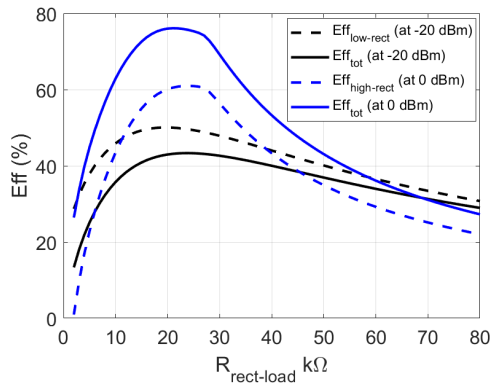

Fig. 6. Efficiencies of the low, high and the series association of the two rectifiers as a function of the output load at -20 dBm and 0 dBm.

is a series topology and employs a Schottky SMS-7630 diode that has a low forward voltage threshold  $V_{th}$  of 0.34 V and is suitable for low power applications. The high power rectifier is a voltage doubler topology and uses two Schottky HSMS-2860 diodes which have a breakdown voltage  $V_b$  of 7 V, being able to operate at powers around 0 dBm. Concerning the bypass diode, the HSMS2850 is employed. Low values of  $V_{th}$  allow to reduce the VRE, the diode HSMS2850 has a low  $V_{th}$  of 0.35 V and at the same time, the  $V_b$  of this diode is 3.8 V which enables it to reach reasonable voltages at high powers.

Fig. 7 compares the efficiencies of the proposed circuit when loaded with 20 kΩ with the performance of the low and high power rectifiers when they are alone and loaded with 13 kΩ and 16 kΩ, which are loads fostering the efficiency at powers of -20 dBm and 0 dBm respectively. As it can be seen in Fig. 7, in the range of -50 dBm to 0 dBm, the overall efficiency of the series association is reduced compared to the efficiencies of each rectifier when they are alone. However, this difference is tolerable considering the series association is able to power a single load from two different power levels and from a single antenna. The association has an efficiency of 43 % and 76 % compared to 55.6 % and 82.2 % when the rectifiers are alone for input powers of -20 dBm and 0 dBm respectively.

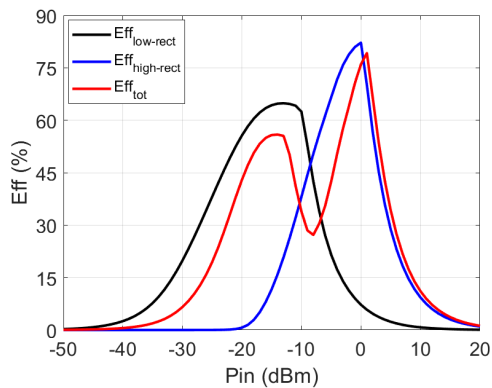

Fig. 7. Comparison of the efficiency of the rectifiers when they are alone versus the series association as a function of the input power.

Furthermore, the association presents efficiency peaks of

55 % at -14 dBm and 79.2 % at 1 dBm. The output voltage of the series association is slightly higher than the output voltages of the rectifiers when they are alone. Values of 293.1 mV and 3.9 V were obtained for the series association compared to 248.3 mV and 3.6 V when the rectifiers are alone for input powers of -20 dBm and 0 dBm respectively. The higher output voltages of the rectifier association are explained by the higher value of its load.

## V. CONCLUSIONS

After characterizing the impact of the internal resistor model of a rectifier in the power absorbed by the PMIC BQ25570, it was determined that the proposed RF harvester circuit must have an output impedance around 20 kΩ to limit the power absorbed by the PMIC. According to this constraint, a RF energy harvester able to collect power from two different power levels was designed and studied in simulation. The solution, which is intended to be fabricated with off the shelf components, presents an output impedance of 21 kΩ and 24 kΩ and an efficiency of 43 % and 76 % for input powers of -20 dBm and 0 dBm respectively. Although at this power levels, the efficiencies are reduced compared to the single rectifiers when they are alone and with loads fostering efficiency, this difference is tolerable considering that the series association is able to power a single load from two different power levels and from a single antenna.

## REFERENCES

- [1] F. Ait Aoudia, M. Gautier, M. Magno, O. Berder, and L. Benini, "Leveraging Energy Harvesting and Wake-Up Receivers for Long-Term Wireless Sensor Networks," *Sensors*, vol. 18, no. 5, 2018. [Online]. Available: <https://www.mdpi.com/1424-8220/18/5/1578>
- [2] M. Caselli, M. Ronchi, and A. Boni, "Power Management Circuits for Low-Power RF Energy Harvesters," *Journal of Low Power Electronics and Applications*, vol. 10, no. 3, 2020. [Online]. Available: <https://www.mdpi.com/2079-9268/10/3/29>
- [3] J. Nicot, L. Fadel, and T. Taris, "An Autonomous Wireless Sensor Node Based on Hybrid RF Solar Energy Harvesting," *Wireless Power Transfer*, vol. 2021, 2021.
- [4] H. Zhang, Y.-x. Guo, Z. Zhong, and W. Wu, "Cooperative Integration of RF Energy Harvesting and Dedicated WPT for Wireless Sensor Networks," *IEEE Microwave and Wireless Components Letters*, vol. 29, no. 4, pp. 291–293, 2019.
- [5] A. Hamani, B. Allard, T.-P. Vuong, M. C. Yagoub, and R. Touhami, "Design of rectenna series-association circuits for radio frequency energy harvesting in CMOS FD-SOI 28 nm," *IET circuits, Devices & Systems*, vol. 12, no. 1, pp. 40–49, 2018.
- [6] Ö. T. Demir and T. E. Tuncer, "Optimum QoS-aware Beamformer Design for Full-Duplex Relay With Self-Energy Recycling," *IEEE Wireless Communications Letters*, vol. 7, no. 1, pp. 122–125, 2017.
- [7] S.-E. Adami, V. Marian, N. Degrenne, C. Vollaïre, B. Allard, and F. Costa, "Self-powered ultra-low power DC-DC converter for RF energy harvesting," in *IEEE Faible Tension Faible Consommation*, 2012, pp. 1–4.
- [8] L. Yao, G. Dolmans, and J. Romme, "On the Analytical Optimal Load Resistance of RF Energy Rectifier," in *IEEE Wireless Power Transfer Conference (WPTC)*, 2021, pp. 1–4.
- [9] A. Fumtchum, P. Tsafack, F. D. Hutu, G. Villemaud, and E. Tanyi, "A Survey of RF Energy Harvesting Circuits," *International Journal of Innovative Technology and Exploring Engineering*, vol. 10, no. 7, pp. 99–106, 2021.