



HAL
open science

Waves4AI

Bruno Cessac

► **To cite this version:**

| Bruno Cessac. Waves4AI. AI4Waves, Oct 2022, Sophia-Antipolis, France. hal-03807338

HAL Id: hal-03807338

<https://inria.hal.science/hal-03807338>

Submitted on 9 Oct 2022

HAL is a multi-disciplinary open access archive for the deposit and dissemination of scientific research documents, whether they are published or not. The documents may come from teaching and research institutions in France or abroad, or from public or private research centers.

L'archive ouverte pluridisciplinaire **HAL**, est destinée au dépôt et à la diffusion de documents scientifiques de niveau recherche, publiés ou non, émanant des établissements d'enseignement et de recherche français ou étrangers, des laboratoires publics ou privés.

Waves4AI

B. Cessac, Université Côte d'Azur, INRIA,
Biovision team and Neuromod Institute
Sophia Antipolis, France

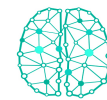

NeuroMod

Context

The visual system

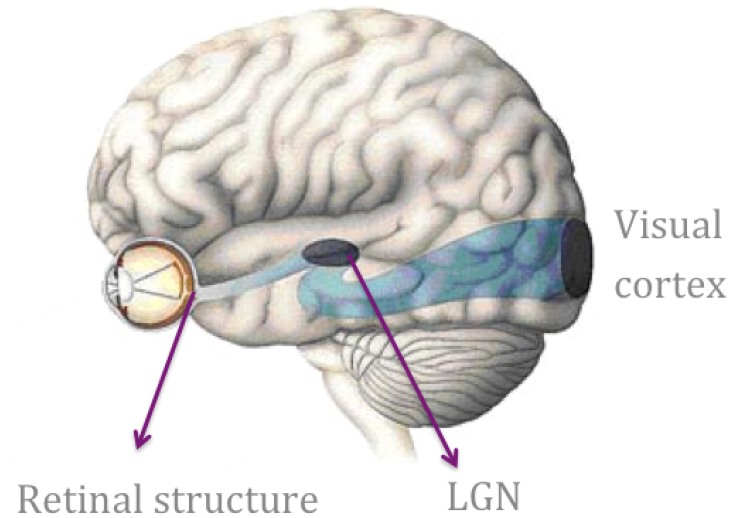

The visual system

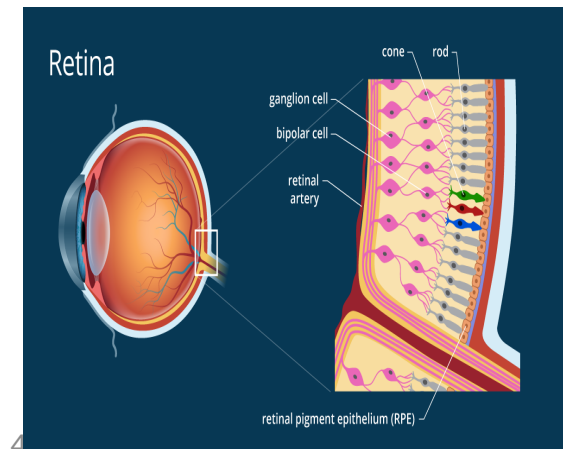
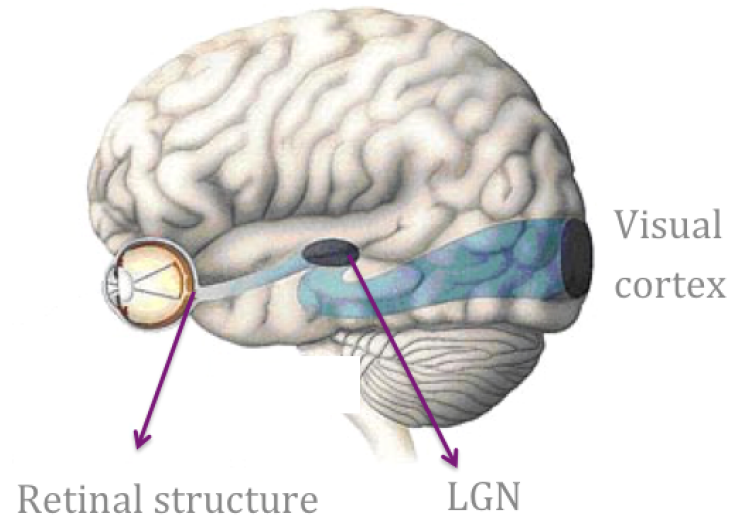

The visual system

Retinal processing: What the visual cortex receives as information from the external world.

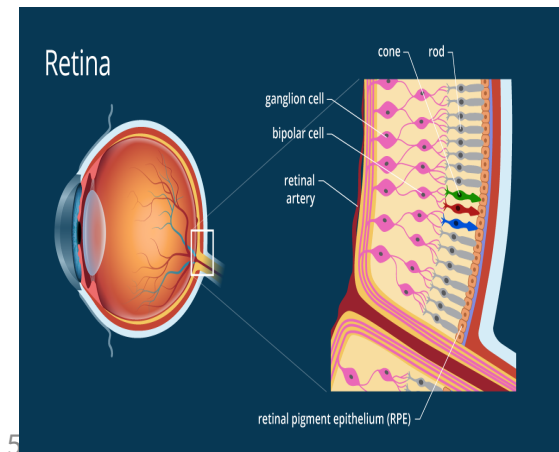
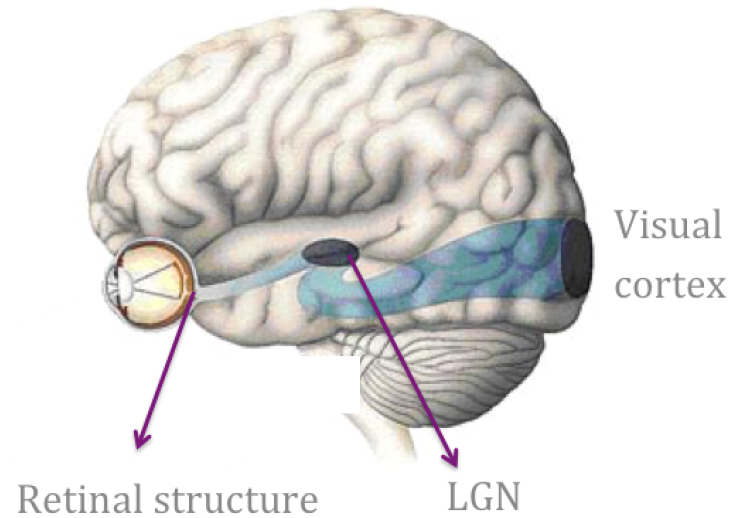

The visual system

Retinal processing: What the visual cortex receives as information from the external world.

The external world is made of **motion** generating an ever changing (**non stationary**) flow of information.

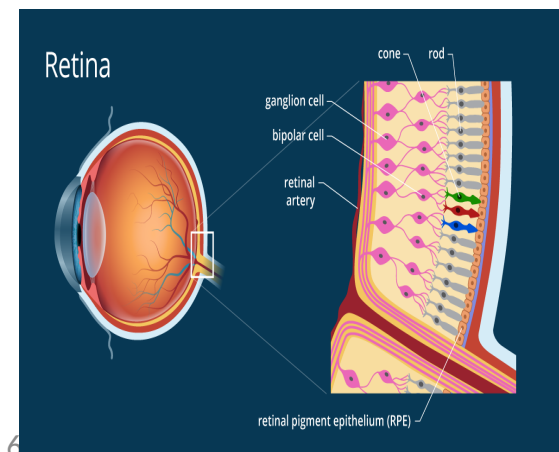
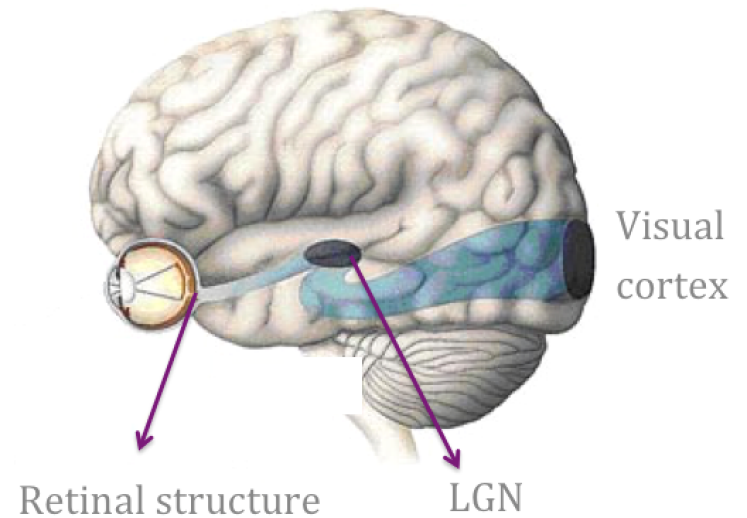

The visual system

Retinal processing: What the visual cortex receives as information from the external world.

The external world is made of **motion** generating an ever changing (**non stationary**) flow of information.

***Waves** in the retina (and in the cortex) contribute, to a large extent, to the overwhelming capacity of the visual system to handle this information, with an **energy consumption** compatible with the narrow **temperature** range of organisms.*

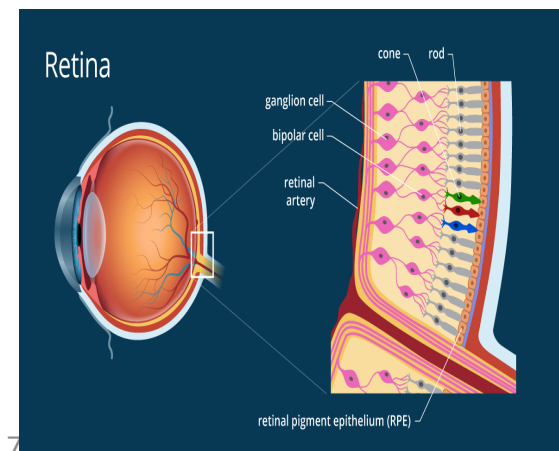
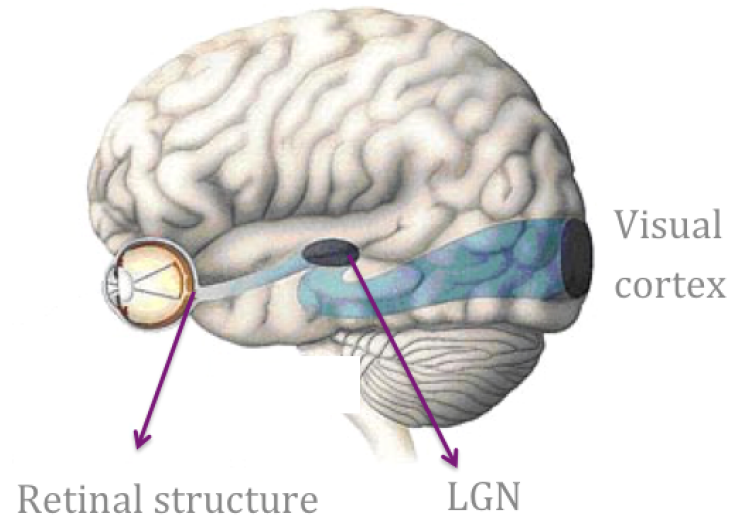

The visual system

Retinal processing: What the visual cortex receives as information from the external world.

The external world is made of **motion** generating an ever changing (**non stationary**) flow of information.

***Waves** in the retina (and in the cortex) contribute, to a large extent, to the overwhelming capacity of the visual system to handle this information, with an **energy consumption** compatible with the narrow **temperature** range of organisms.*

Examples: Differential motion, interrupted motion, anticipation, surprise.

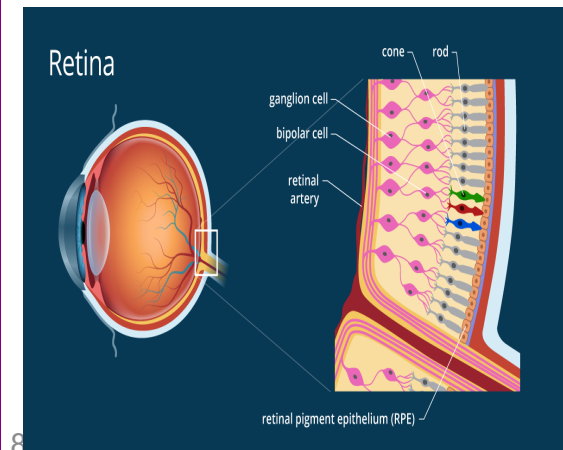
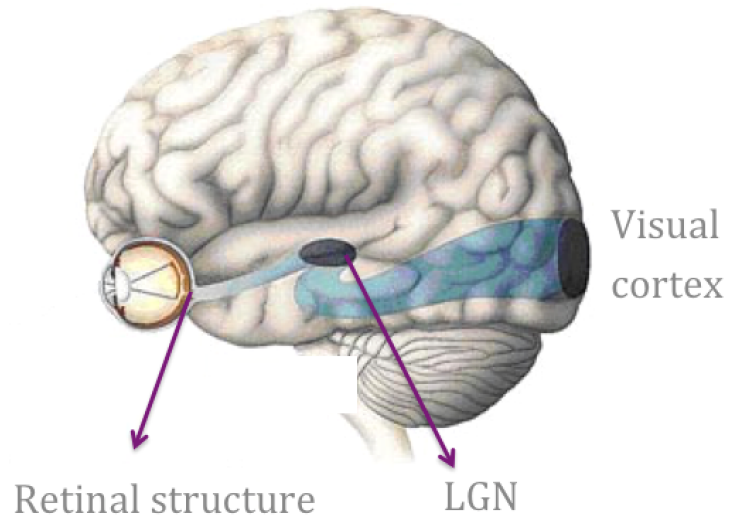

The visual system

Retinal processing: What the visual cortex receives as information from the external world.

The external world is made of **motion** generating an ever changing (**non stationary**) flow of information.

*Waves in the retina (and in the cortex) contribute, to a large extent, to the overwhelming capacity of the visual system to handle this information, with an **energy consumption** compatible with the narrow **temperature** range of organisms.*

Examples: Differential motion, interrupted motion, anticipation, surprise.

(To my knowledge) AI systems are not capable to process these tasks with a so low energy consumption (~ nW).

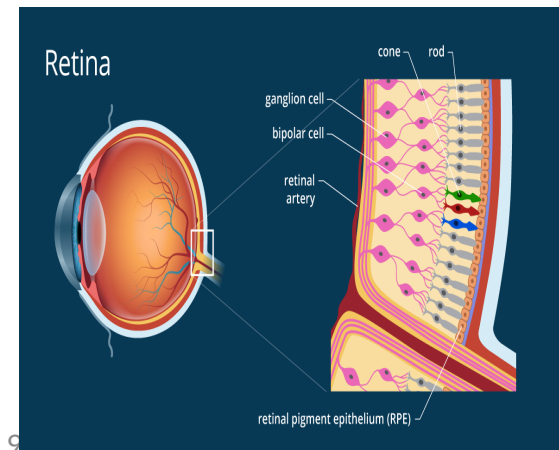
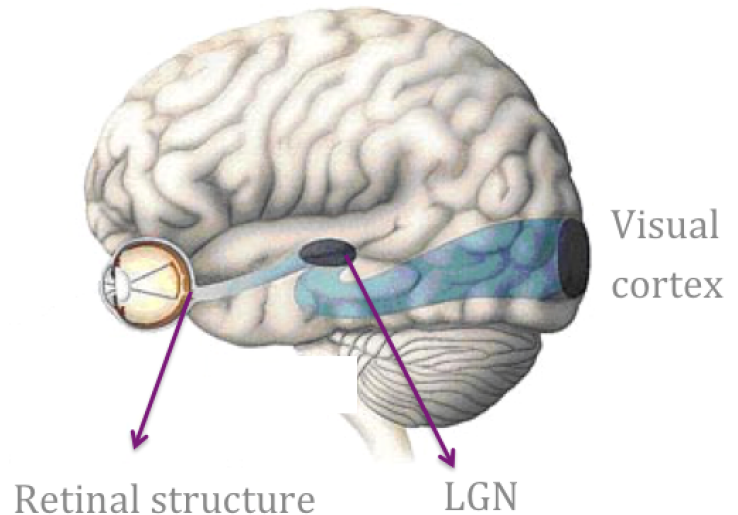

The visual system

Retinal processing: What the visual cortex receives as information from the external world.

The external world is made of **motion** generating an ever changing (**non stationary**) flow of information.

*Waves in the retina (and in the cortex) contribute, to a large extent, to the overwhelming capacity of the visual system to handle this information, with an **energy consumption** compatible with the narrow **temperature** range of organisms.*

Examples: Differential motion, interrupted motion, anticipation, surprise.

(To my knowledge) AI systems are not capable to process these tasks with a so low energy consumption (~ nW).

What can we learn from retinal waves activity that could be helpful to improve AI systems ?

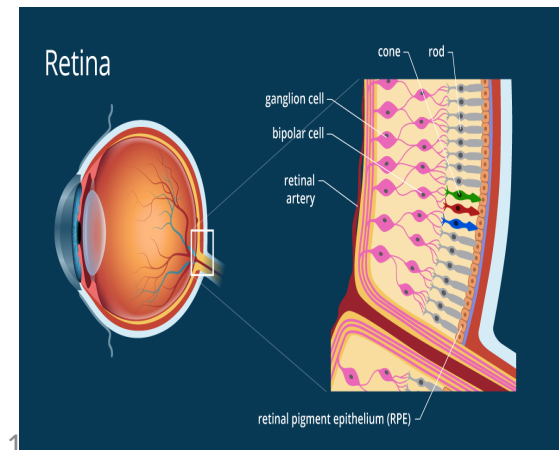
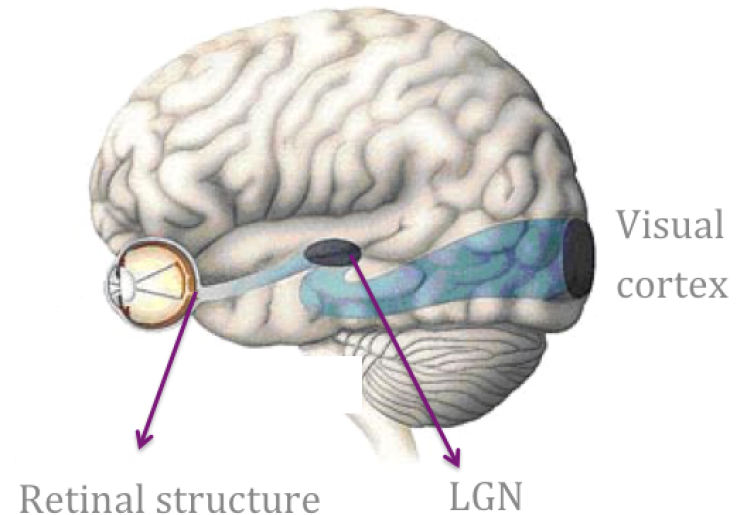

The retina and its dynamics

The visual system

Retina's layered structure

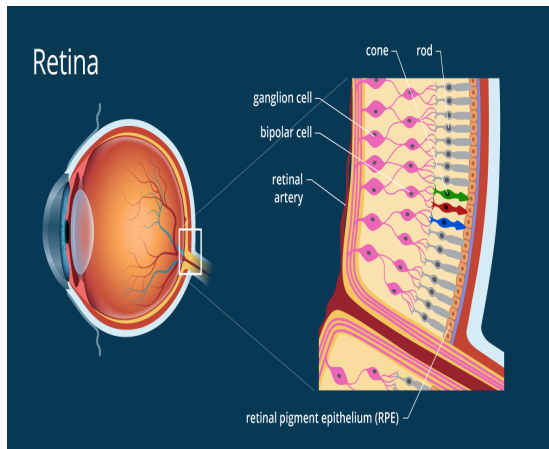
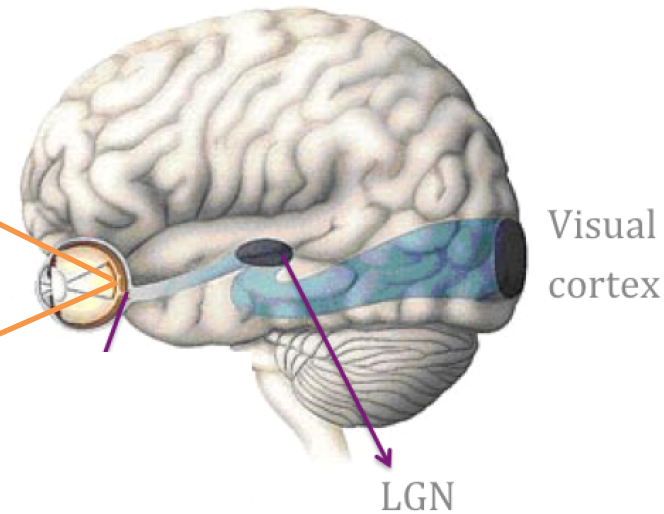
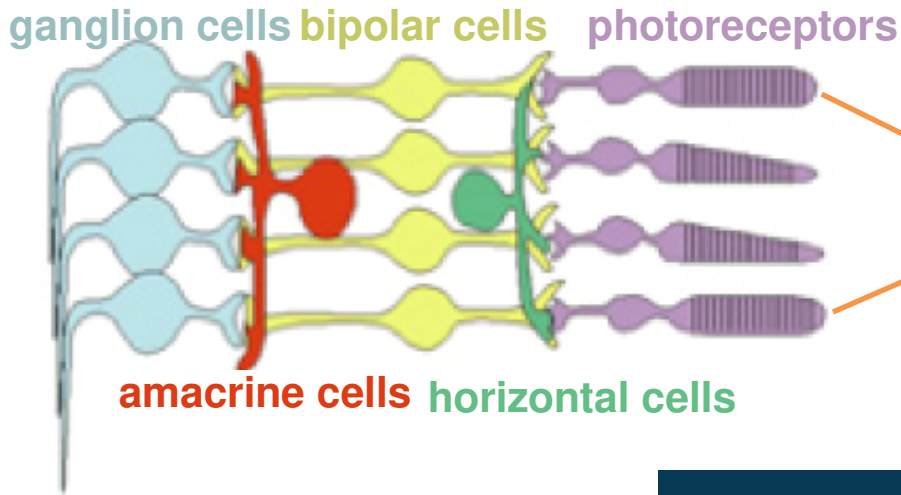

The visual system

Retina's layered structure

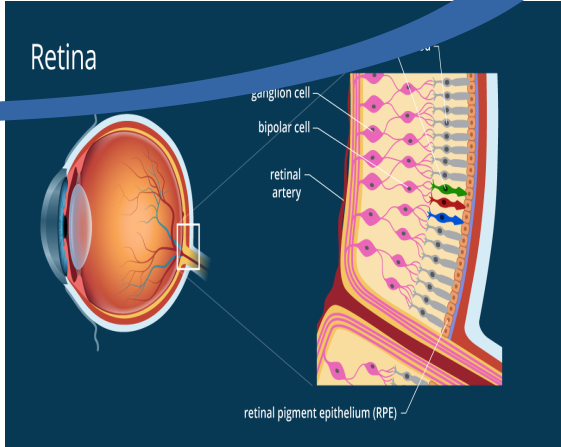
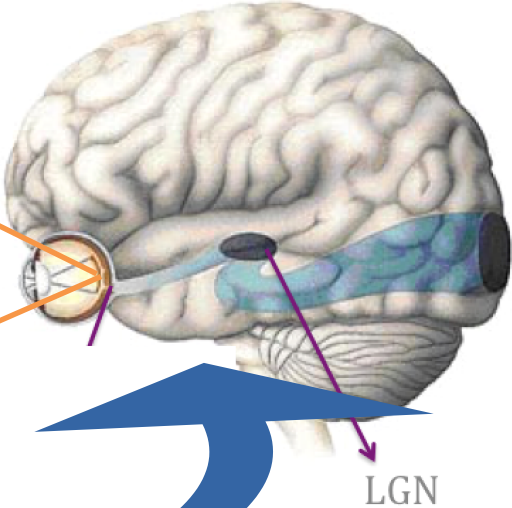
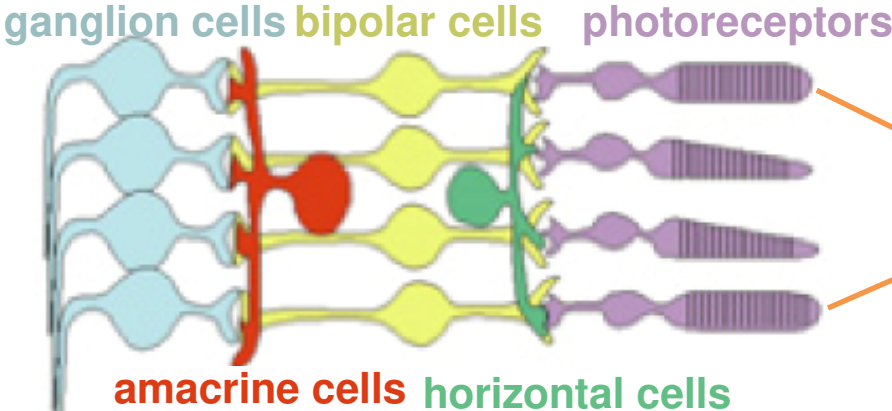

The visual system

Retina's layered structure

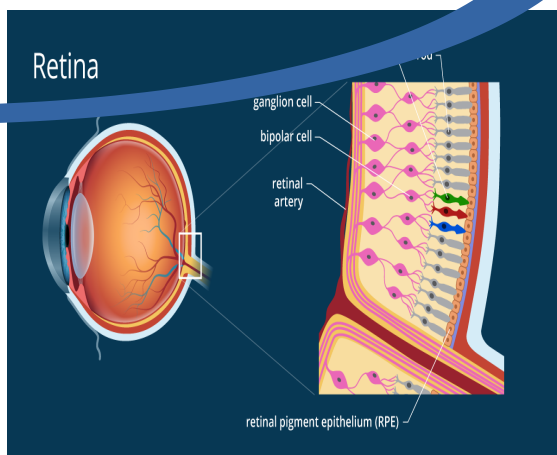
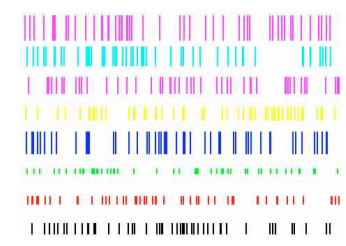
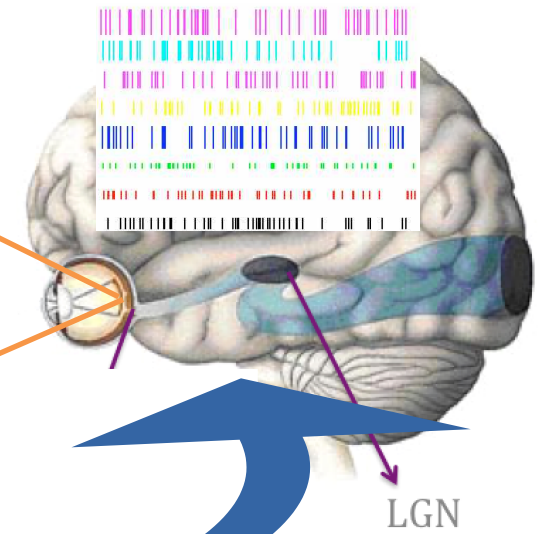
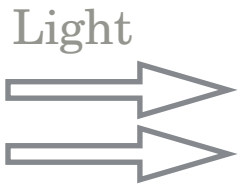
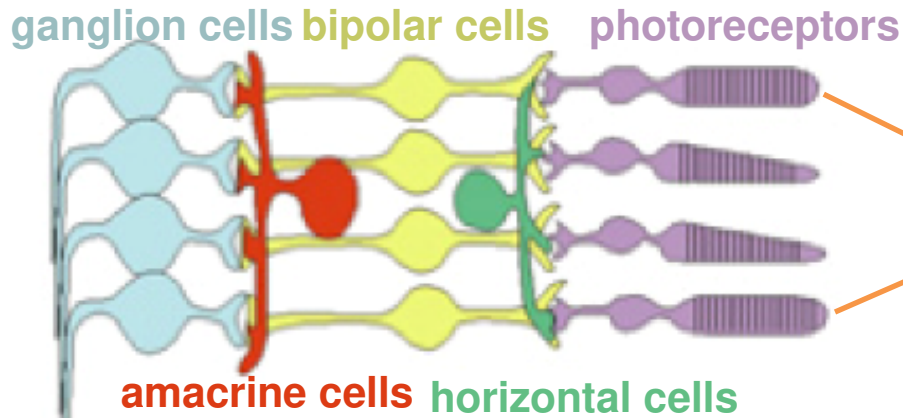

The visual system

Retina's layered structure

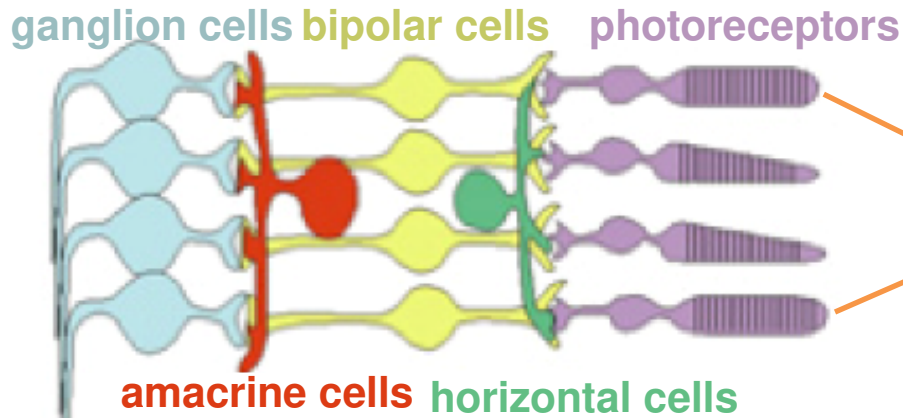

Light

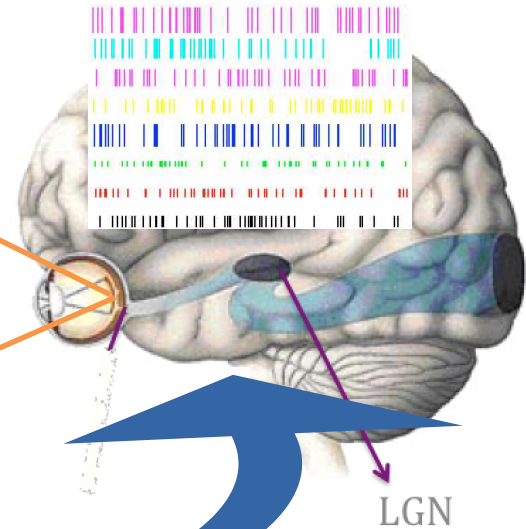

Visual cortex

LGN

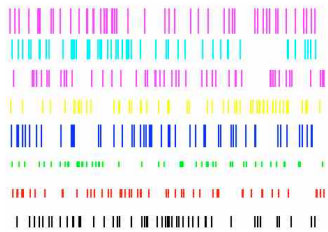

« Information » flux

The visual system

Retina's layered structure

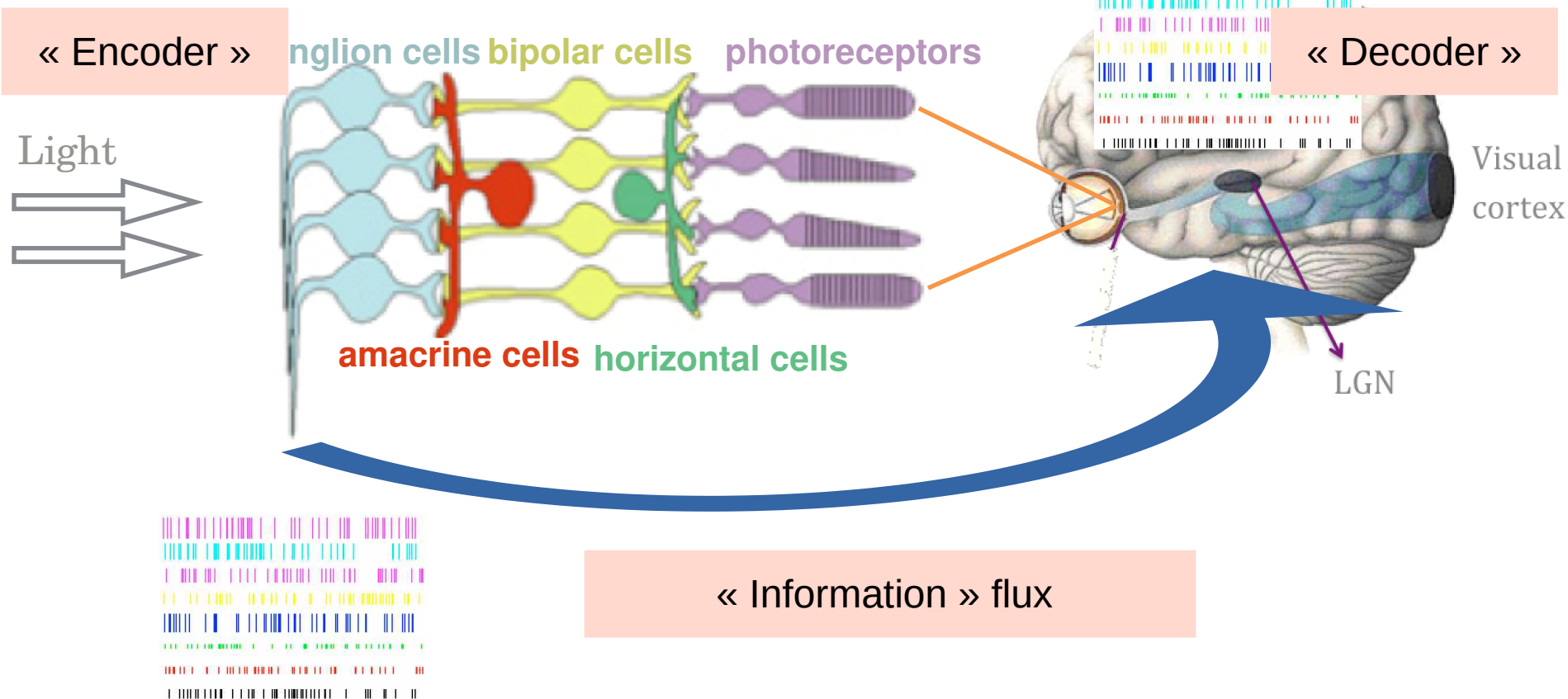

The visual system

Retina's layered structure

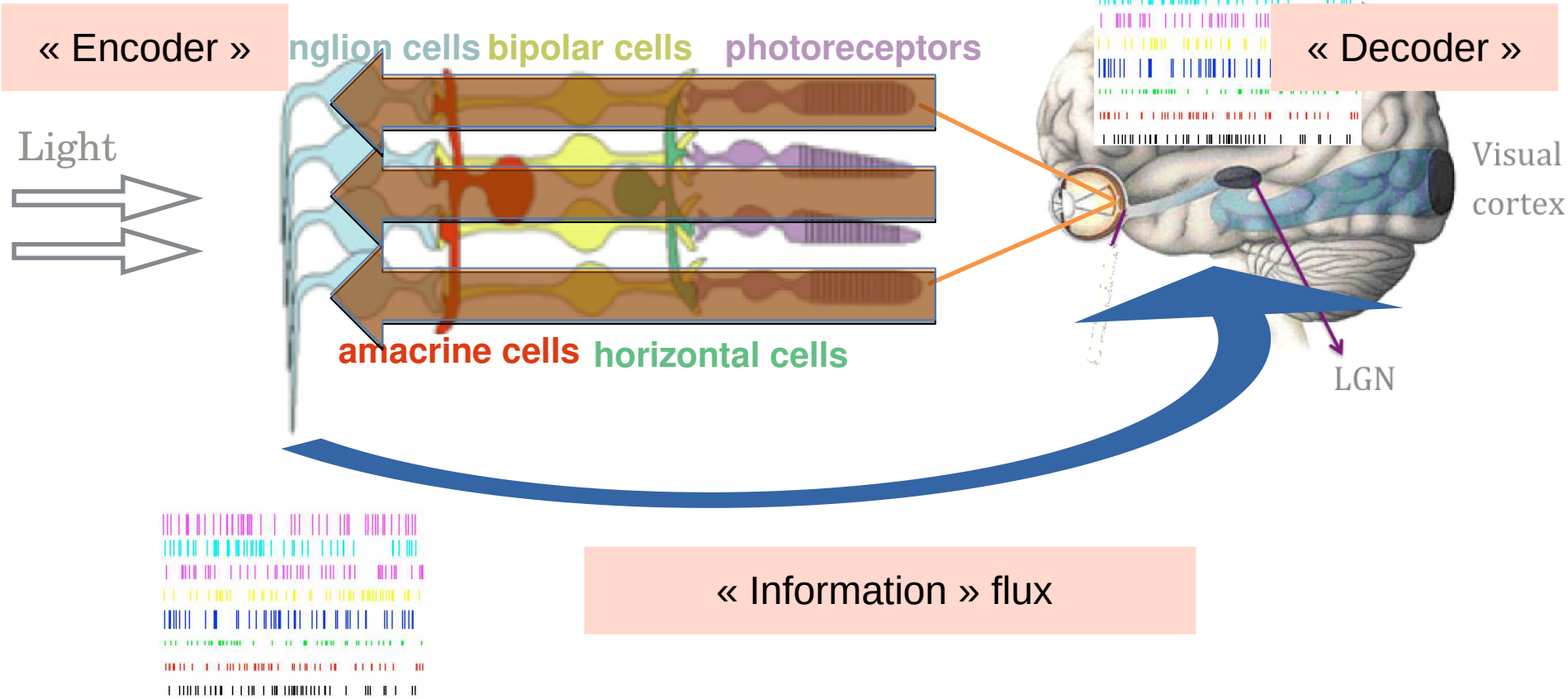

The visual system

Retina's layered structure

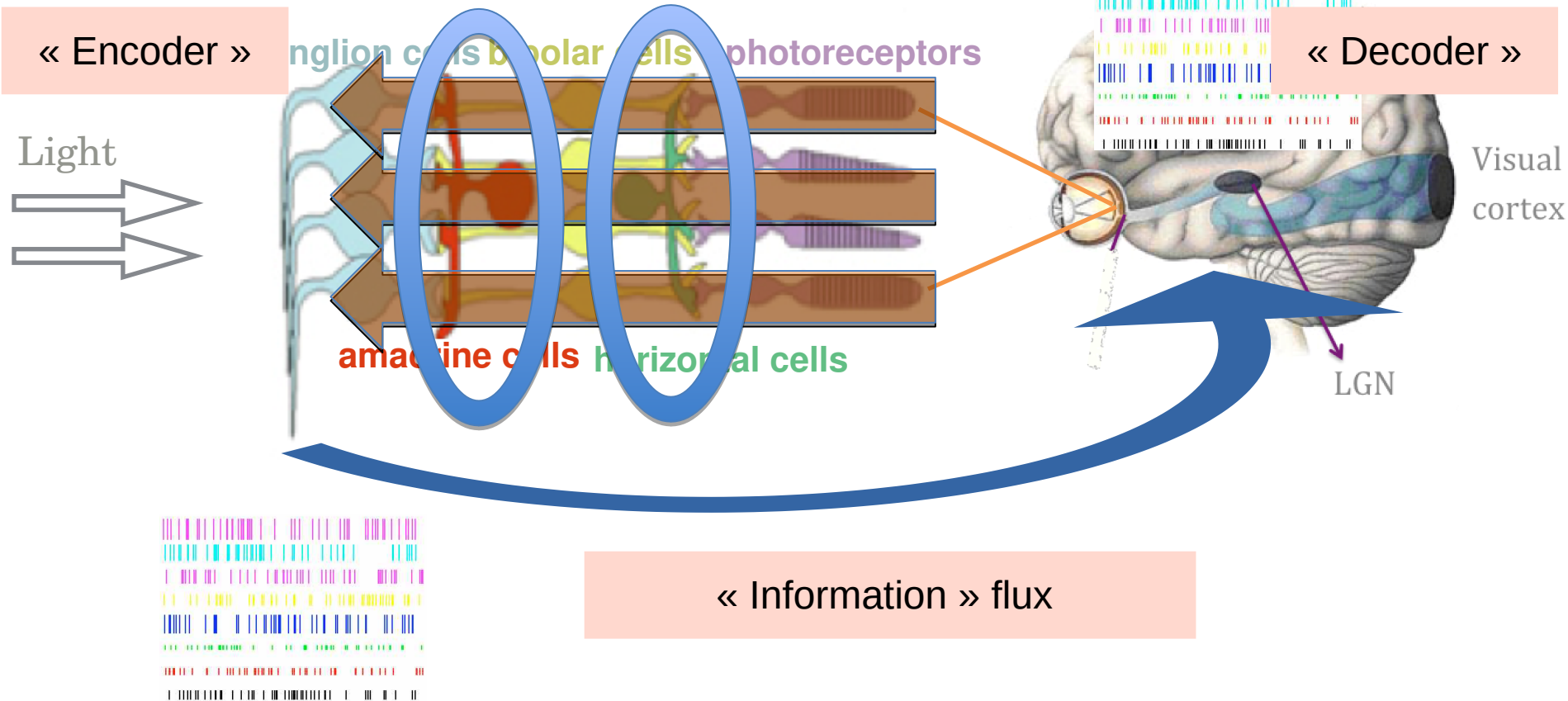

The visual system

Retina's layered structure

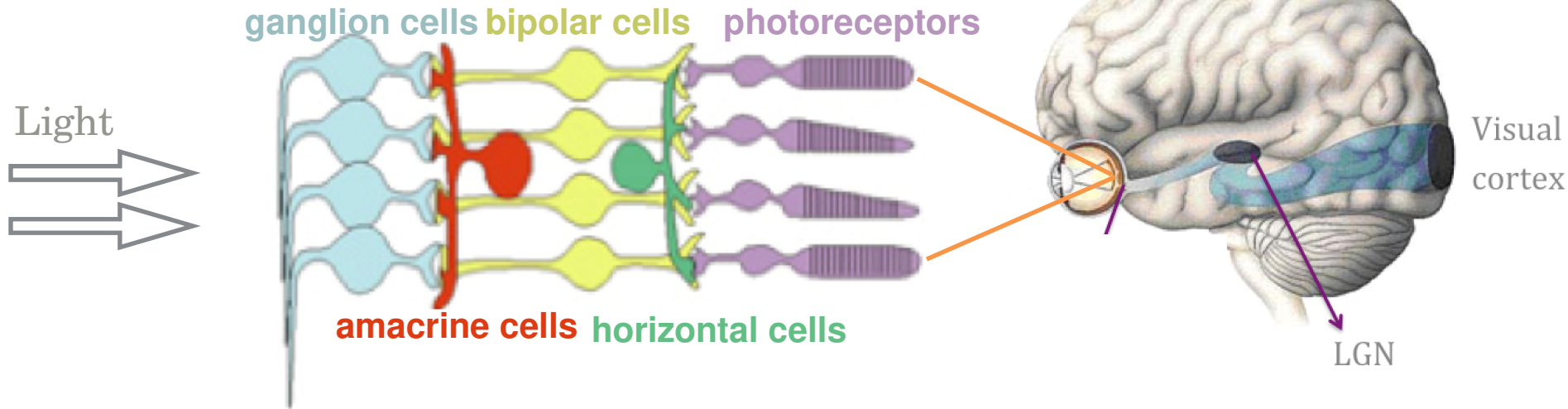

« Information » is processed by spikes.

Individual neurons and individual synapses do not matter.

Population dynamics, cortical columns, neural fields.

The visual system

Retina's layered structure

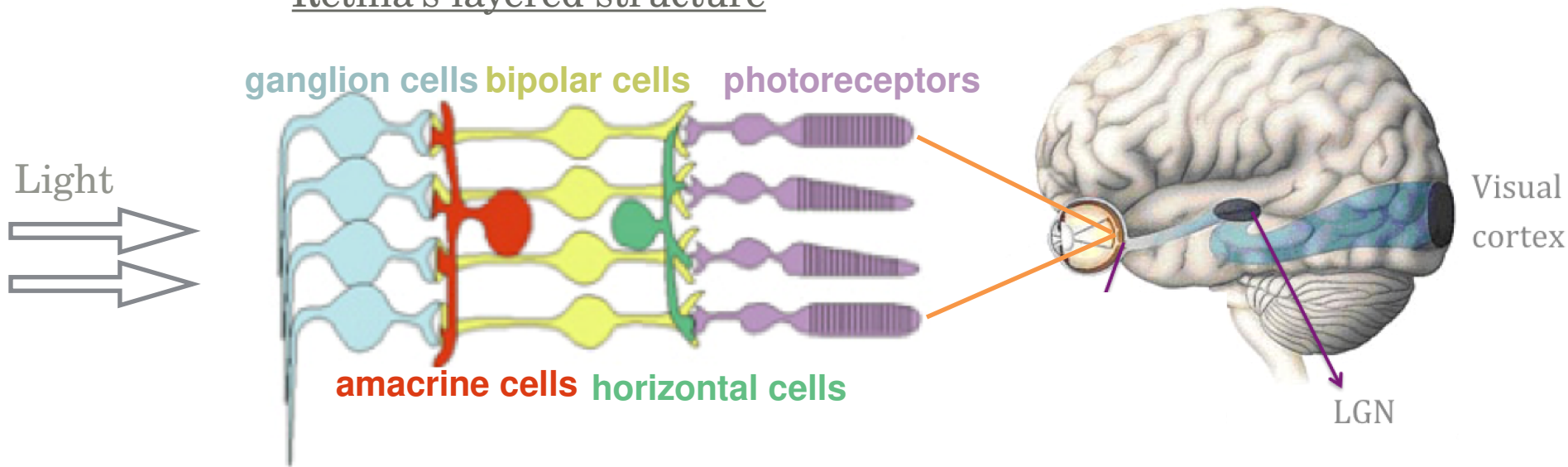

Analogic computing.

No spikes except at GCells

**Individual neurons and synapses
DO matter.**

**Dedicated circuits made of a few
neurons and synapses process the
local visual information.**

**« Information » is processed by
spikes.**

**Individual neurons and individual
synapses do not matter.**

**Population dynamics, cortical
columns, neural fields.**

A modeller point of view

1. The retina is a ***high dimensional, non autonomous and noisy*** dynamical system, layered and structured, with ***non stationary and spatially inhomogeneous entries*** (visual scenes).

A modeller point of view

1. The retina is a ***high dimensional, non autonomous and noisy*** dynamical system, layered and structured, with ***non stationary and spatially inhomogeneous entries*** (visual scenes).
2. ***Local circuits*** of non linear cells, connected with non linear synapses efficiently process the ***local visual information***. These local circuits are connected together, spanning the whole retina in a ***regular tiling***.

A modeller point of view

1. The retina is a ***high dimensional, non autonomous and noisy*** dynamical system, layered and structured, with ***non stationary and spatially inhomogeneous entries*** (visual scenes).
2. ***Local circuits*** of non linear cells, connected with non linear synapses efficiently process the ***local visual information***. These local circuits are connected together, spanning the whole retina in a ***regular tiling***.
3. The conjunction of non linearities and regular structure can produce a highly complex ***spatio-temporal*** dynamics.

A modeller point of view

1. The retina is a **high dimensional, non autonomous and noisy** dynamical system, layered and structured, with **non stationary and spatially inhomogeneous entries** (visual scenes).
2. **Local circuits** of non linear cells, connected with non linear synapses efficiently process the **local visual information**. These local circuits are connected together, spanning the whole retina in a **regular tiling**.
3. The conjunction of non linearities and regular structure can produce a highly complex **spatio-temporal** dynamics.
4. The retinal network naturally produces **waves** : spontaneous (developmental) or stimulus induced.

Why can we play tennis ?

Motion anticipation

Retina's layered structure

ganglion cells bipolar cells photoreceptors

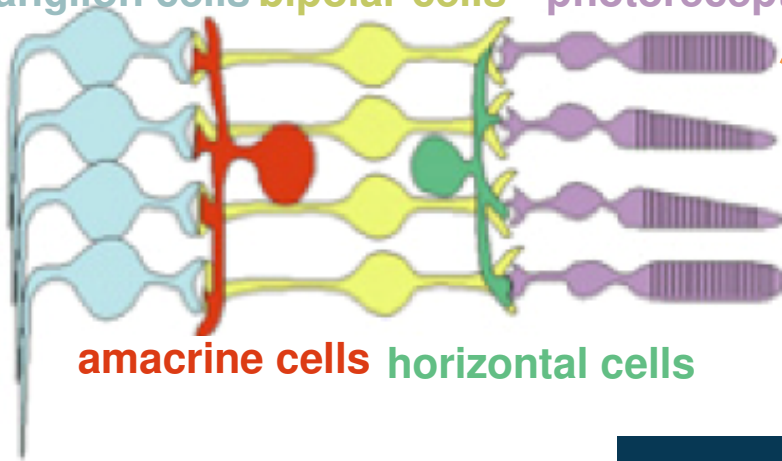
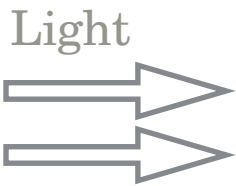

amacrine cells horizontal cells

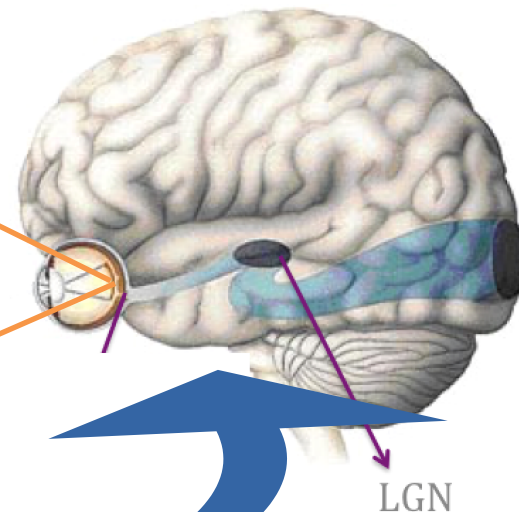

Visual cortex

LGN

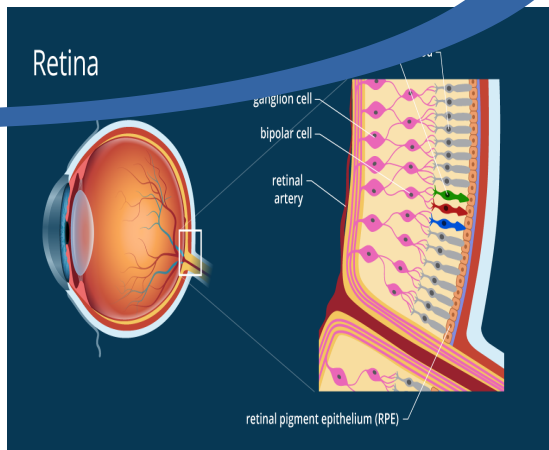

Motion anticipation

Retina's layered structure

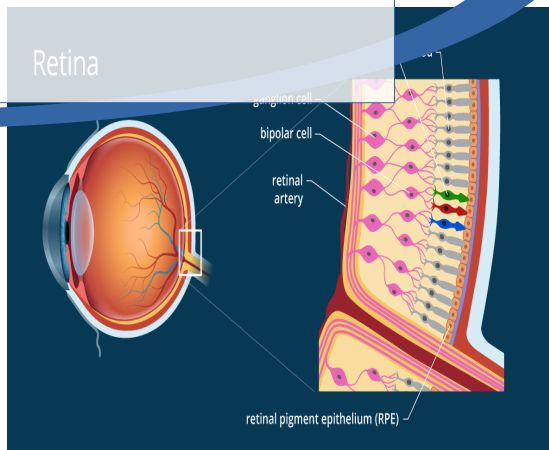
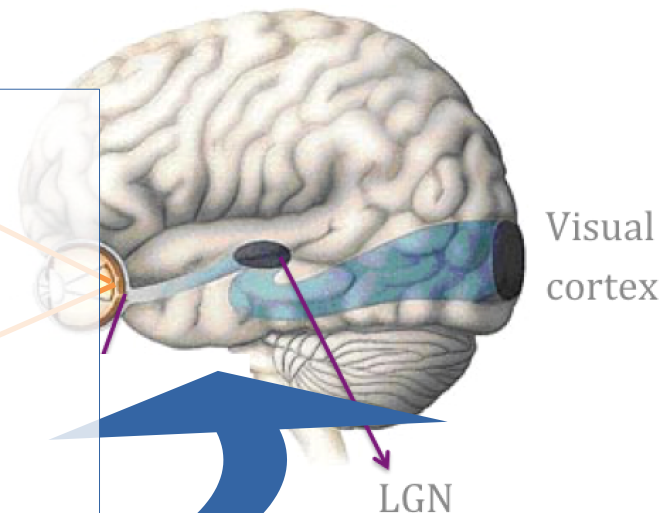

Motion anticipation

Transmission delay eye-visual cortex~ **100 ms**.

Average speed of a tennis ball (stroke) : 170 km/h ~ 47 m/s => **4.7 m** in 100 ms



Motion anticipation

Anticipation is carried out by the primary visual cortex (V1) through an activation wave

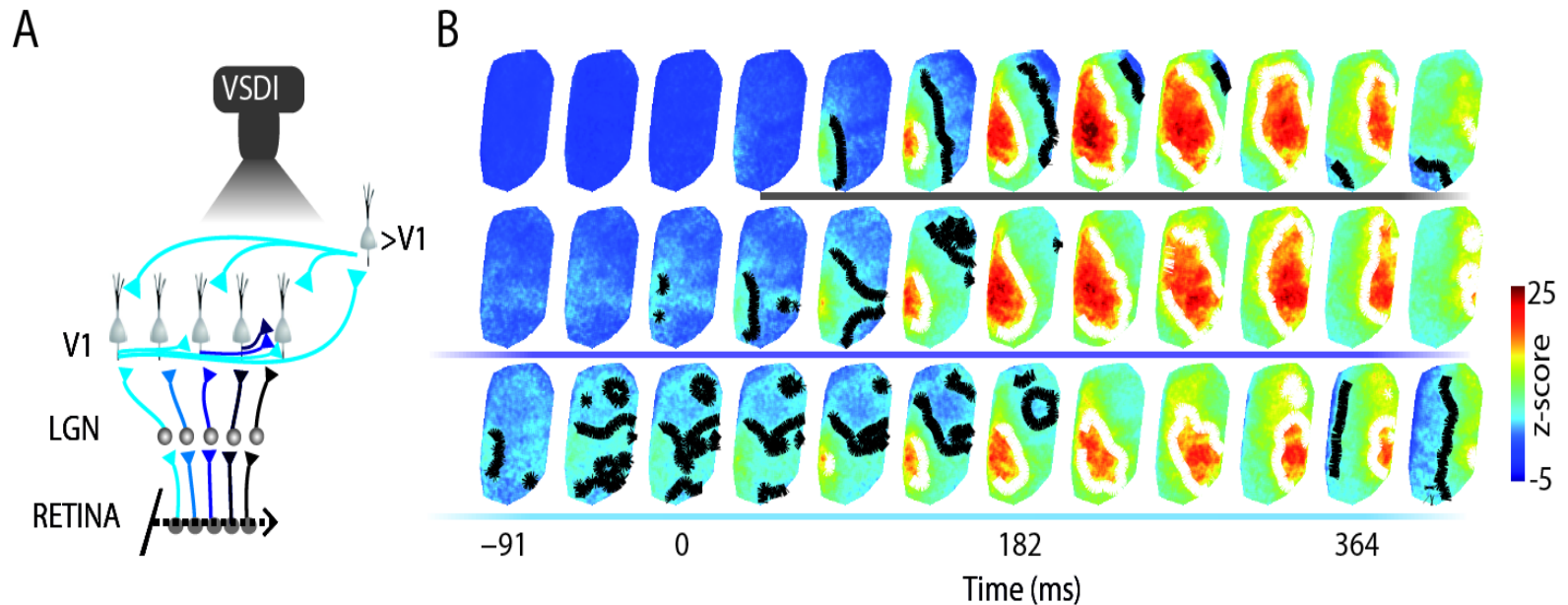

G. Benvenuti, S. Chemla, A. Boonman, L. Perrinet, G. S. Masson, and F. Chavane. Anticipatory responses along motion trajectories in awake monkey area v1. bioRxiv, 2020.

Motion Anticipation

Anticipation also takes place in the retina

M.J. Berry, I.H. Brivanlou, T.A. Jordan, and M. Meister. Anticipation of moving stimuli by the retina. *Nature*, 398(6725):334—338, 1999.

Jamie Johnston Leon Lagnado (2015) General features of the retinal connectome determine the computation of motion anticipation, *eLife* 4:e06250.

S. Souihel and B. Cessac. On the potential role of lateral connectivity in retinal anticipation. *J. Math. Neurosc.*, 11(3), 2021.

Michael D. Menz, Dongsoo Lee, and Stephen A. Baccus. Representations of the amacrine cell population underlying retinal motion anticipation. *bioRxiv*, 2020.

Motion Anticipation

Anticipation also takes place in the retina

S. Souihel and B. Cessac. On the potential role of lateral connectivity in retinal anticipation. *J. Math. Neurosc.*, 11(3), 2021.

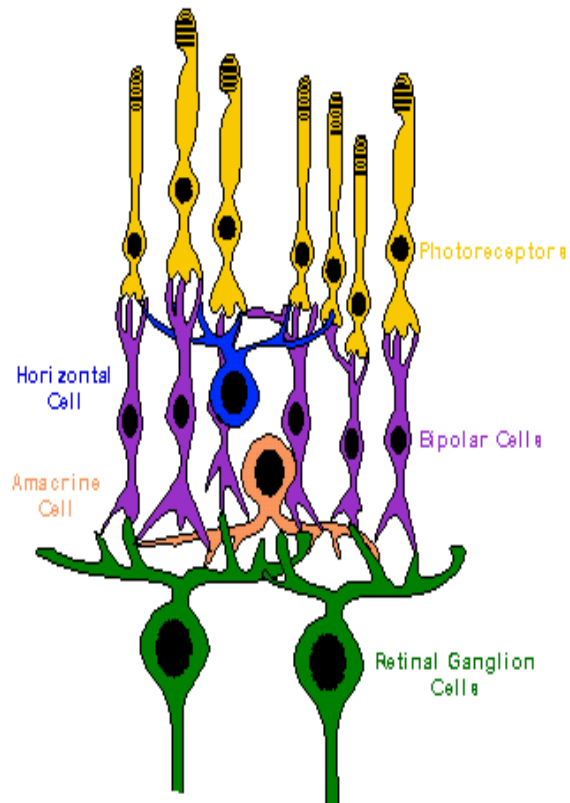

Motion Anticipation

Anticipation also takes place in the retina

S. Souihel and B. Cessac. On the potential role of lateral connectivity in retinal anticipation. *J. Math. Neurosc.*, 11(3), 2021.

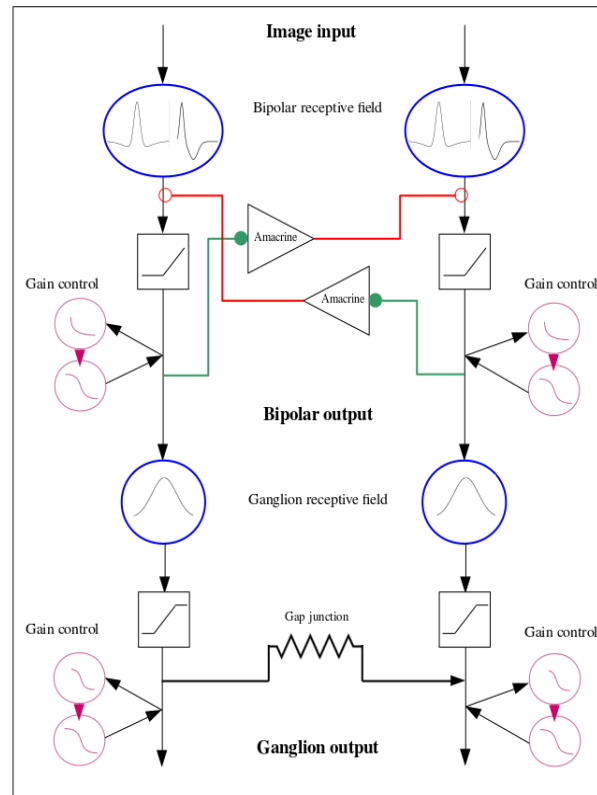
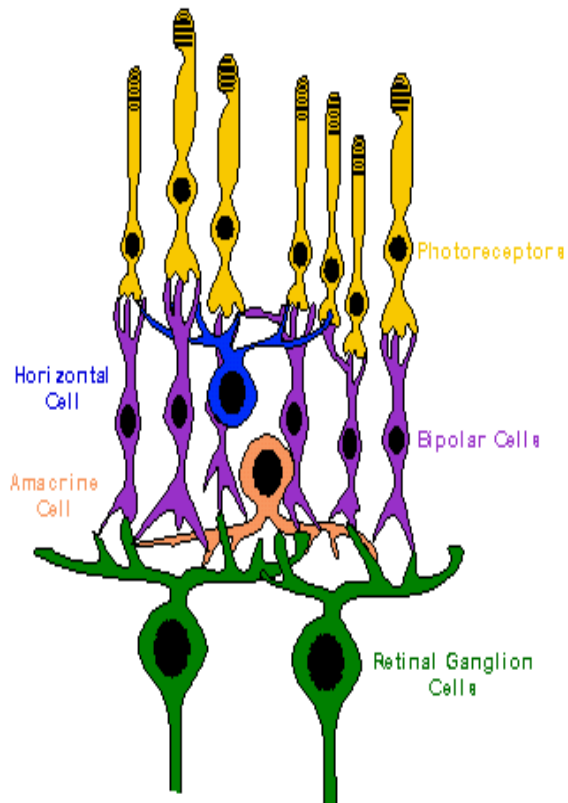

Motion Anticipation

Anticipation also takes place in the retina

S. Souihel and B. Cessac. On the potential role of lateral connectivity in retinal anticipation. *J. Math. Neurosc.*, 11(3), 2021.

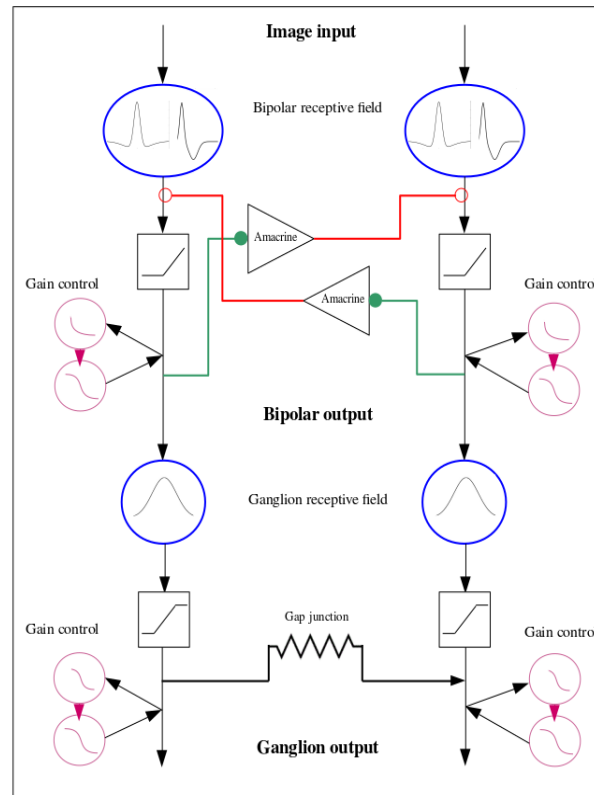
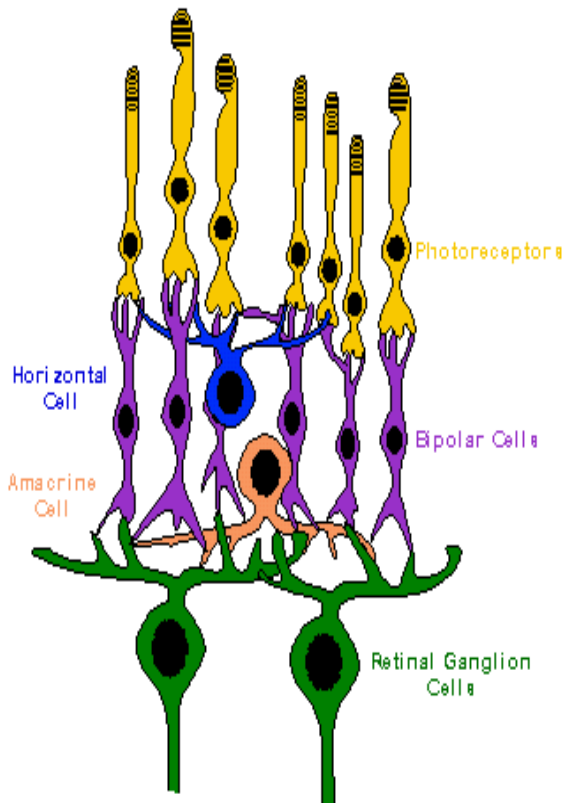

$$\begin{cases} \frac{dV_{B_i}}{dt} = -\frac{1}{\tau_B} V_{B_i} + \sum_{j=1}^{N_A} W_{B_i}^{A_j} V_{A_j} + F_{B_i}(t), \\ \frac{dV_{A_j}}{dt} = -\frac{1}{\tau_A} V_{A_j} + \sum_{i=1}^{N_B} W_{A_j}^{B_i} R_{B_i}, \\ \frac{dA_{B_i}}{dt} = -\frac{A_{B_i}}{\tau_a} + h_B \mathcal{N}(V_{B_i}). \end{cases}$$

Motion Anticipation

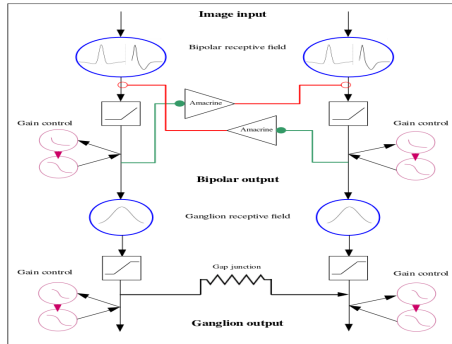

Local circuit

Motion Anticipation

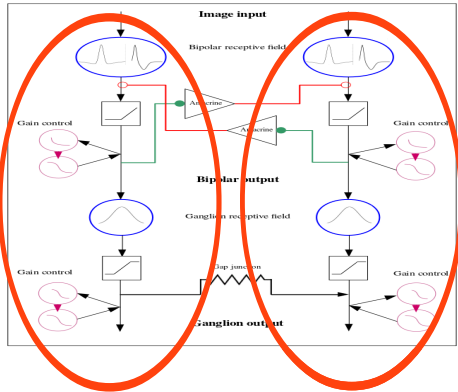

Local circuit

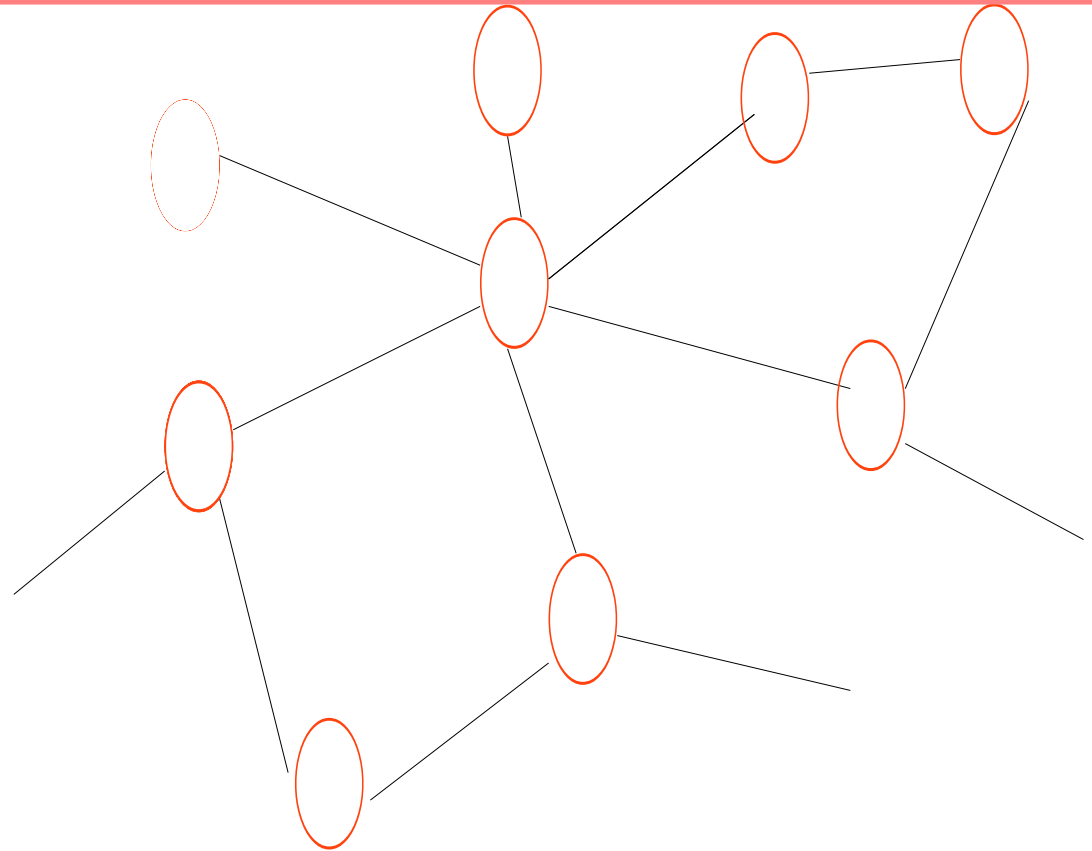

Network

Motion Anticipation

S. Souihel and B. Cessac. On the potential role of lateral connectivity in retinal anticipation. J. Math. Neurosc., 11(3), 2021.

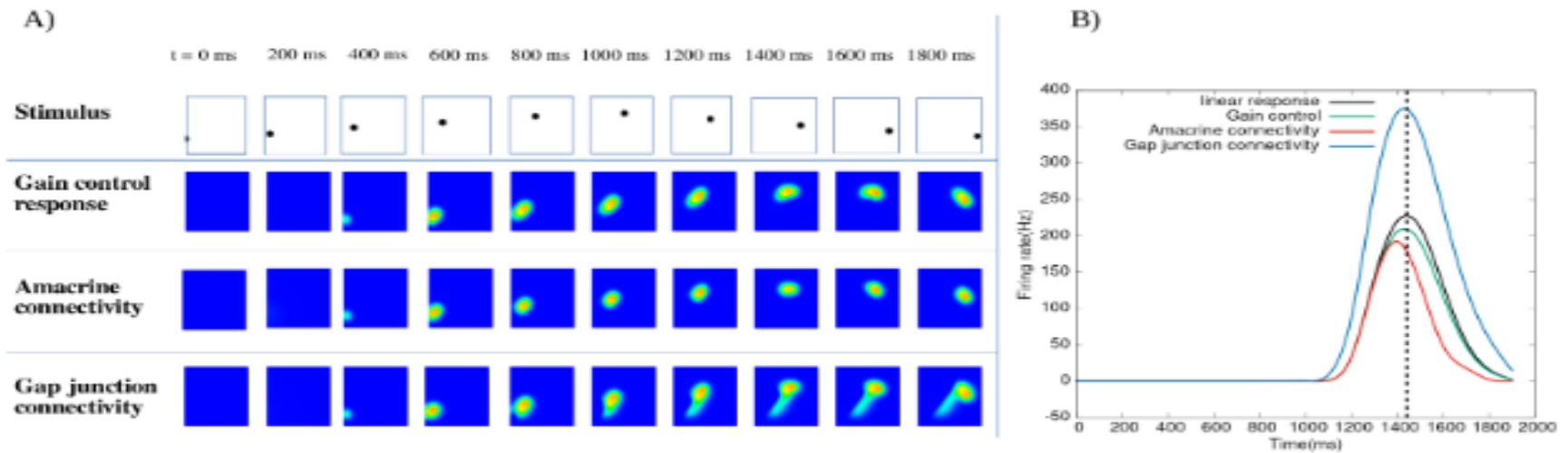

Figure 15: **Effect of anticipatory mechanisms on a parabolic trajectory.** A) Response to a dot moving along a parabolic trajectory. The first line shows the stimulus, the second line shows the GCells response with gain control, the third line presents the effect of lateral ACells connectivity with $w = 0.3 \text{ ms}^{-1}$, and the last line shows the effect of asymmetric gap junctions with $v_{gap} = 9 \text{ mm/s}$. B) Time course response of a cell responding to the dot near the trajectory turning point. Linear response corresponds to the response to the stimulus without gain control.

Motion Anticipation

S. Souihel and B. Cessac. On the potential role of lateral connectivity in retinal anticipation. *J. Math. Neurosc.*, **11(3)**, 2021.

- A **moving object** induces a **retinal wave ahead** of the stimulus thanks to gain control and the amacrine cells network.
 - 1) Compensation of the **photo-transduction delay**.
 - 2) Simple implementation, **weak consumption**.
 - 3) Most of the « computation » is **analogic**.
- Extend to differential motion, interrupted motion, surprise.

Motion Anticipation

S. Souihel and B. Cessac. On the potential role of lateral connectivity in retinal anticipation. J. Math. Neurosc., 11(3), 2021.

- A **moving object** induces a **retinal wave ahead** of the stimulus thanks to gain control and the amacrine cells network.
 - 1) Compensation of the **photo-transduction delay**.
 - 2) Simple implementation, **weak consumption**.
 - 3) Most of the « computation » is **analogic**.
- Extend to differential motion, interrupted motion, surprise.

Motion is not a succession of images.

***There is a spatio-temporal coherence-correlation,
captured by waves.***

How do our eyes learn to see ?

The structure of the retina during development

Retina's layered structure
is shaped during development

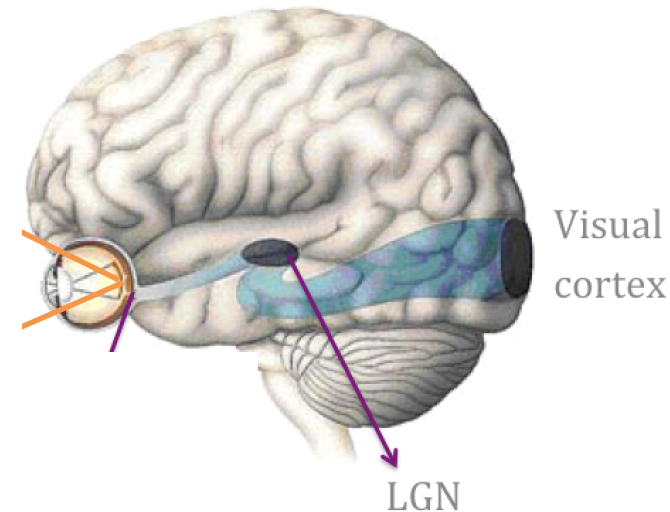
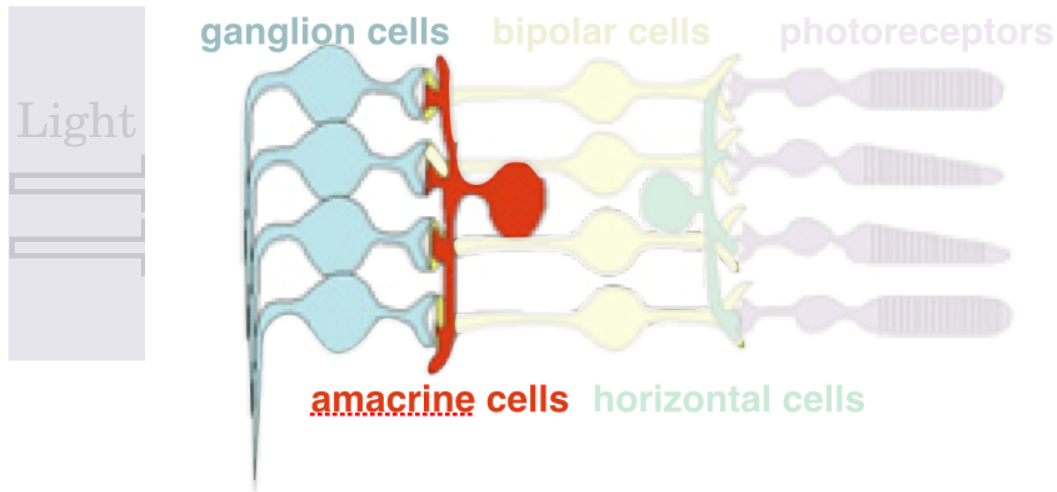

But How?



Retinal waves!

Retinal waves

Spontaneous spatio-temporal waves during development
Disappear short after birth when vision is functional

Recordings from the retina

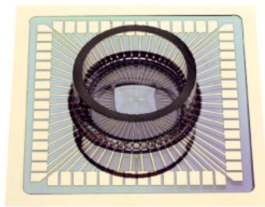
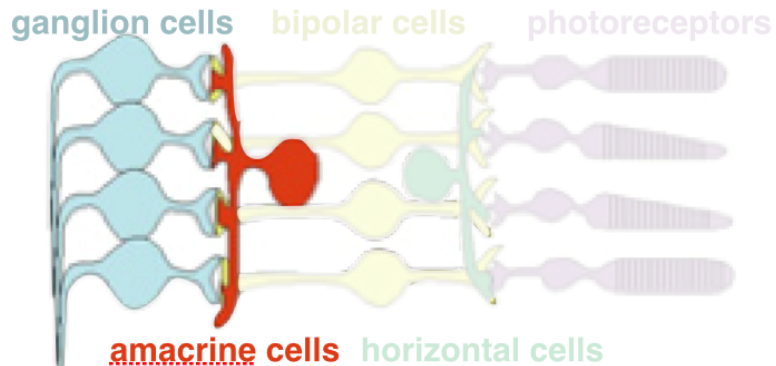

Multi-electrode array (MEA)

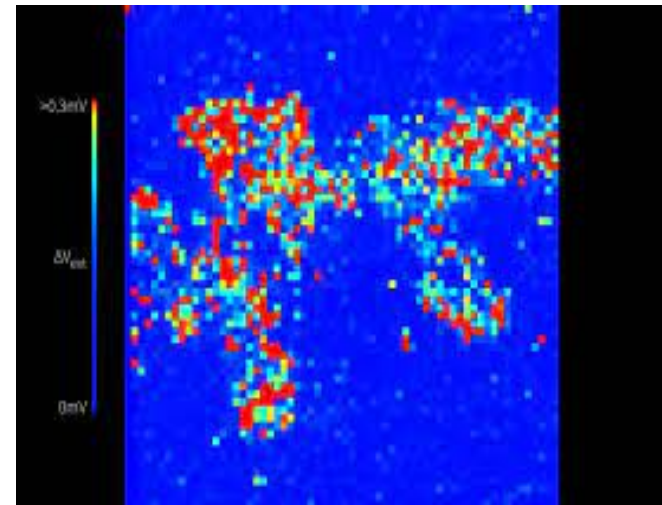

MEA recording of the voltage from a mouse retina
https://www.youtube.com/watch?v=0kt5_mhTy4w.

Stages of Retinal Waves During Development

Stage II

- Retinotopic mapping
- Nicotinic Acetylcholine Receptors (nAChR)

Stage III

- Disappear when vision is functional
- Glutamate – AMPA receptors

Stage I

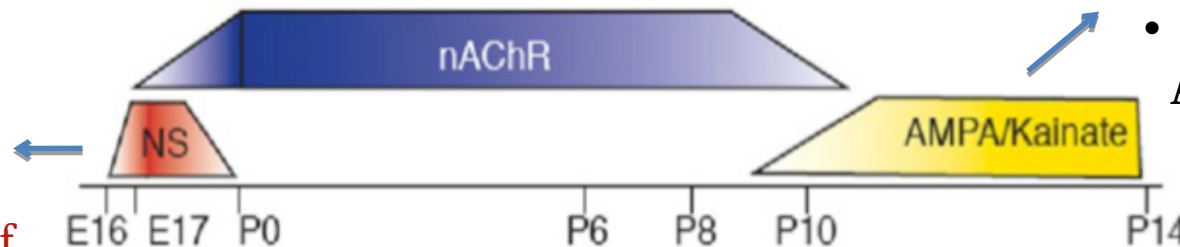

- Formation of retina circuitry
- Chemical synapses not formed yet
- Gap junction-mediated

Retinotopy

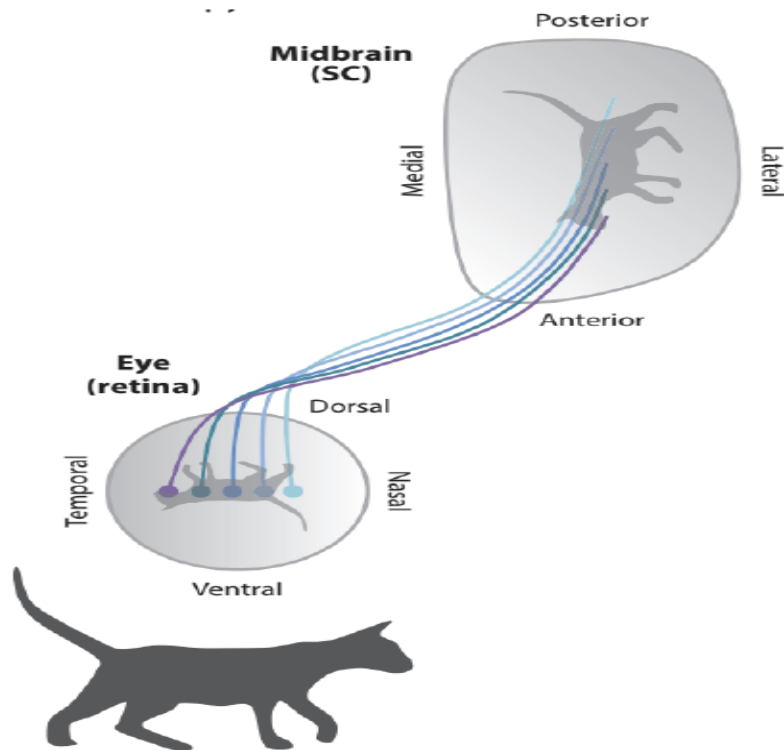

Figure 2.3: Cartoon showing the retinotopic projection and relationship with the visual field. Here a cat is presented as an image to a mouse's retina. This image is inverted by the lens of the eye and projected topographically into the SC where the neighbour relationships can be traced using the colour gradient. Figure adapted from Seabrook et. al. (2017) [190].

Retinotopy

Retinotopy results from :

- 1) Competition** at the synaptic level (*fight for resources*)
- 2) Chemotaxis** (retinal afferents affinity to colliculus location depends on the *concentration of ligands and receptors* at the location)
- 3) Activity** (effects of *neuronal activity* on the organisation of topography)
- 4) Plasticity**

From Nicholas Gale thesis , «Theoretical Investigations into Principles of Topographic Map Formation and Applications », Cambridge 2022.

Retinotopy

Retinotopy results from :

- 1) **Competition** at the synaptic level (*fight for resources*)
- 2) **Chemotaxis** (retinal afferents affinity to colliculus location depends on the *concentration of ligands and receptors* at the location)
- 3) **Activity** (effects of *neuronal activity* on the organisation of topography)
- 4) **Plasticity**



Variational formulation

From Nicholas Gale thesis , «Theoretical Investigations into Principles of Topographic Map Formation and Applications », Cambridge 2022.

Retinotopy

Retinotopy results from :

- 1) **Competition** at the synaptic level (*fight for resources*)
- 2) **Chemotaxis** (retinal afferents affinity to colliculus location depends on the *concentration of ligands and receptors* at the location)
- 3) **Activity** (effects of *neuronal activity* on the organisation of topography)
- 4) **Plasticity**

Variational formulation

+

Retinal waves input

From Nicholas Gale thesis , «Theoretical Investigations into Principles of Topographic Map Formation and Applications », Cambridge 2022.

The Starburst Amacrine Cells Network

Model synaptic interactions

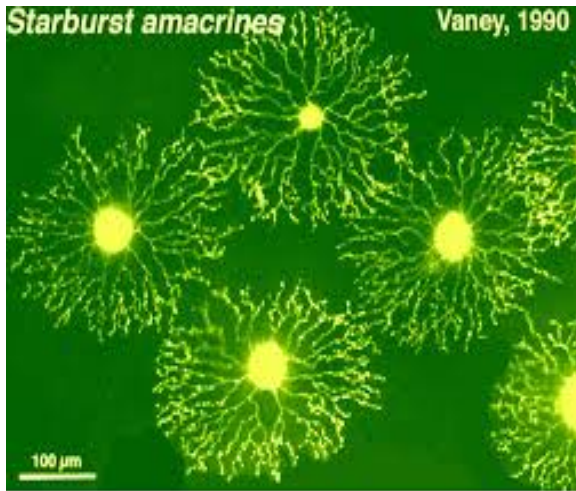
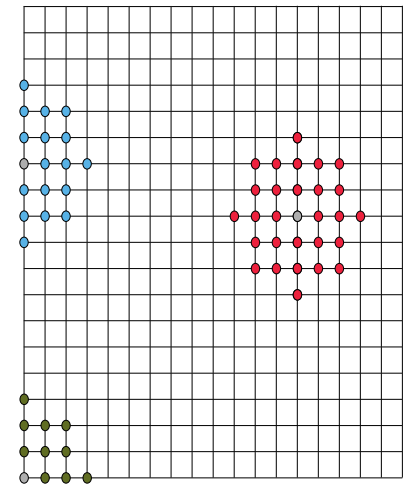
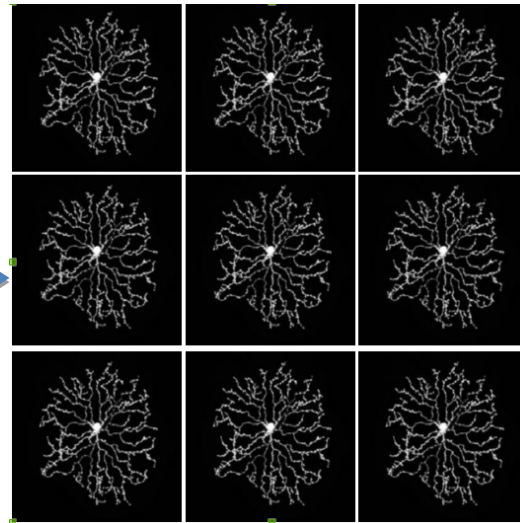

Fig 7. Starburst amacrine cells are stained with Lucifer yellow in whole-mount rabbit retina.



SACs realistic connections

SACs on a lattice

SACs become points on a lattice

A network model for stage II retinal waves

D. Matzakou-Karvouniari, L. Gil, E. Orendorff, O. Marre, S. Picaud, B. Cessac, « A biophysical model explains the spontaneous bursting behavior in the developing retina », *Scientific Reports, Nature Publishing Group*, 2019, 9 (1), pp.1-23. (10.1038/s41598-018-38299-4)

$$\left\{ \begin{array}{l} C_m \frac{dV_i}{dt} = -g_L(V_i - V_L) - g_C M_\infty(V_i)(V_i - V_C) - g_K N_i(V_i - V_K) \\ \quad - G_{sAHP}(R_i)(V_i - V_K) - G_A(\{A_k\}_{k \in \mathcal{B}_i})(V_i - V_A) \\ \\ \tau_N \frac{dN_i}{dt} = \Lambda(V_i)(N_\infty(V_i) - N_i) \\ \\ \tau_C \frac{dC_i}{dt} = -\frac{\alpha_C}{H_X} C_i + C_0 - \delta_C g_C M_\infty(V_i)(V_i - V_C) \\ \\ \tau_S \frac{dS_i}{dt} = \alpha_S(1 - S_i)C_i^4 - S_i \\ \\ \tau_R \frac{dR_i}{dt} = \alpha_R S_i(1 - R_i) - R_i \\ \\ \frac{dA_i}{dt} = -\mu A_i + \beta_A T_A(V_i), \end{array} \right.$$

The nonlinear dynamics of retinal waves

D. Matzakou-Karvouniari, L. Gil, E. Orendorff, O. Marre, S. Picaud, B. Cessac, « A biophysical model explains the spontaneous bursting behavior in the developing retina », *Scientific Reports*, Nature Publishing Group, 2019, 9 (1), pp.1-23. {10.1038/s41598-018-38299-4}

B. Cessac, D. Matzakou-Karvouniari, *The non linear dynamics of retinal waves Physica D: Volume 439*, November 2022, 133436 <https://hal.inria.fr/hal-03485137/file/main.pdf>

The nonlinear dynamics of retinal waves

D. Matzakou-Karvouniari, L. Gil, E. Orendorff, O. Marre, S. Picaud, B. Cessac, « A biophysical model explains the spontaneous bursting behavior in the developing retina », *Scientific Reports*, Nature Publishing Group, 2019, 9 (1), pp.1-23. {10.1038/s41598-018-38299-4}

B. Cessac, D. Matzakou-Karvouniari, *The non linear dynamics of retinal waves Physica D: Volume 439*, November 2022, 133436 <https://hal.inria.fr/hal-03485137/file/main.pdf>

- Stage II retinal waves are due to the conjunction of :

1) Spontaneous bursting (initiation) ;

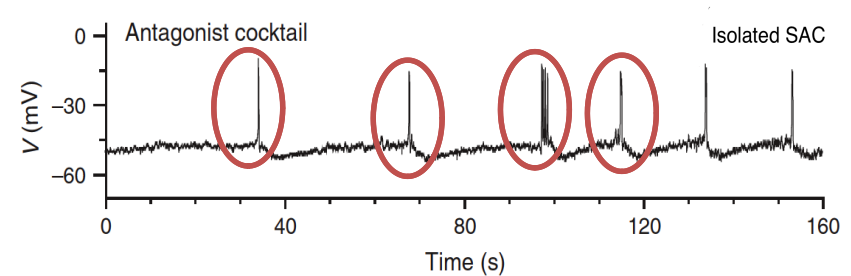

The nonlinear dynamics of retinal waves

D. Matzakou-Karvouniari, L. Gil, E. Orendorff, O. Marre, S. Picaud, B. Cessac, « A biophysical model explains the spontaneous bursting behavior in the developing retina », *Scientific Reports*, Nature Publishing Group, 2019, 9 (1), pp.1-23. {10.1038/s41598-018-38299-4}

B. Cessac, D. Matzakou-Karvouniari, *The non linear dynamics of retinal waves Physica D: Volume 439*, November 2022, 133436 <https://hal.inria.fr/hal-03485137/file/main.pdf>

• Stage II retinal waves are due to the conjunction of :

- 1) Spontaneous bursting (initiation) ;
- 2) Acetylcholine network (propagation) ;

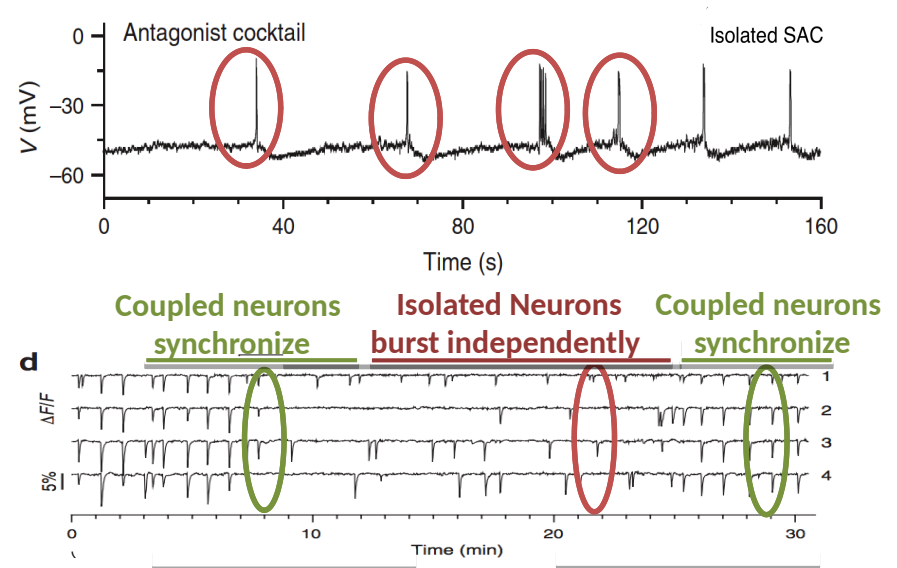

The nonlinear dynamics of retinal waves

D. Matzakou-Karvouniari, L. Gil, E. Orendorff, O. Marre, S. Picaud, B. Cessac, « A biophysical model explains the spontaneous bursting behavior in the developing retina », *Scientific Reports*, Nature Publishing Group, 2019, 9 (1), pp.1-23. {10.1038/s41598-018-38299-4}

B. Cessac, D. Matzakou-Karvouniari, *The non linear dynamics of retinal waves Physica D: Volume 439*, November 2022, 133436 <https://hal.inria.fr/hal-03485137/file/main.pdf>

• Stage II retinal waves are due to the conjunction of :

- 1) Spontaneous bursting (initiation) ;
- 2) Acetylcholine network (propagation) ;
- 3) Long refractoriness (stop);

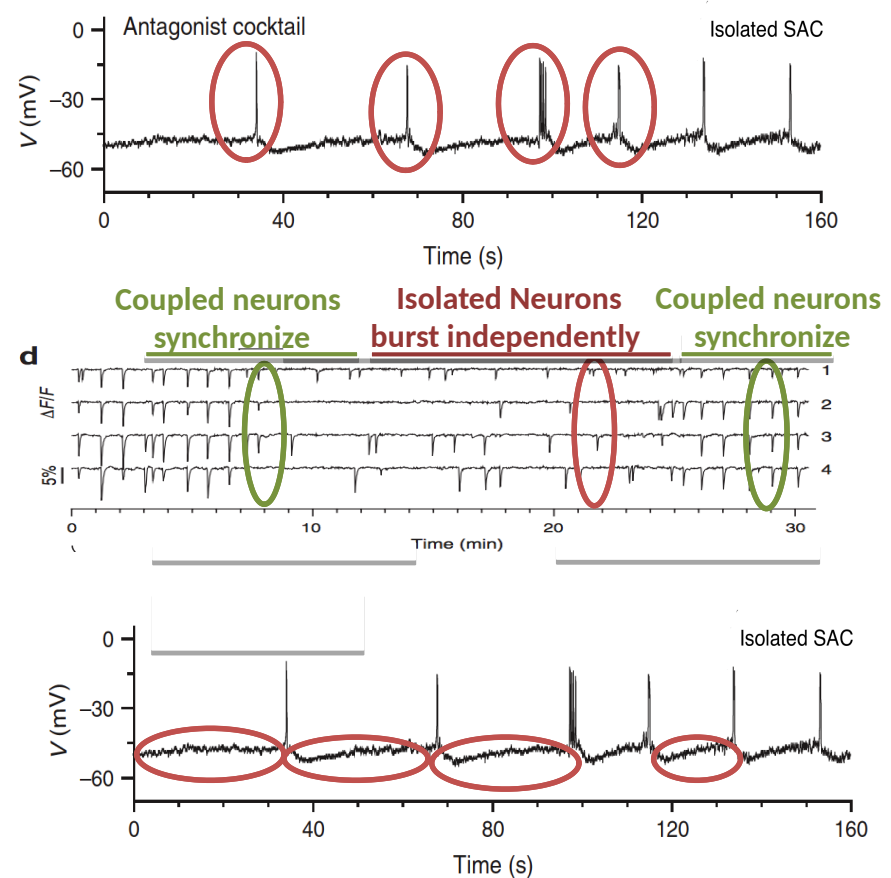

The nonlinear dynamics of retinal waves

D. Matzakou-Karvouniari, L. Gil, E. Orendorff, O. Marre, S. Picaud, B. Cessac, « A biophysical model explains the spontaneous bursting behavior in the developing retina », *Scientific Reports*, Nature Publishing Group, 2019, 9 (1), pp.1-23. {10.1038/s41598-018-38299-4}

B. Cessac, D. Matzakou-Karvouniari, *The non linear dynamics of retinal waves Physica D: Volume 439*, November 2022, 133436 <https://hal.inria.fr/hal-03485137/file/main.pdf>

• Stage II retinal waves are due to the conjunction of :

- 1) Spontaneous bursting (initiation) ;
- 2) Acetylcholine network (propagation) ;
- 3) Long refractoriness (stop);

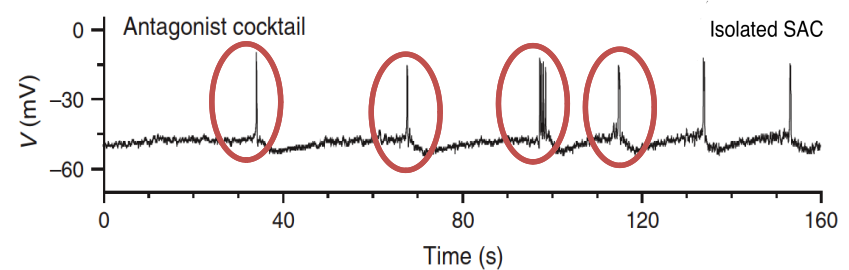

Coupled neurons Isolated Neurons Coupled neurons

Experiment for coupled and isolated neurons, Zheng et al., 2006, Nature

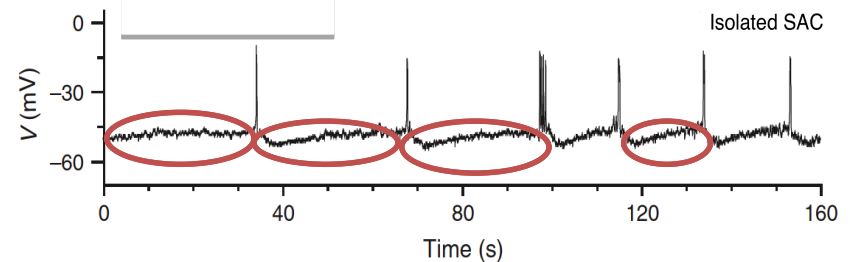
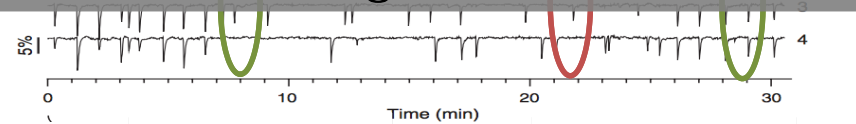

The nonlinear dynamics of retinal waves

D. Matzakou-Karvouniari, L. Gil, E. Orendorff, O. Marre, S. Picaud, B. Cessac, « A biophysical model explains the spontaneous bursting behavior in the developing retina », *Scientific Reports*, Nature Publishing Group, 2019, 9 (1), pp.1-23. ([10.1038/s41598-018-38299-4](https://doi.org/10.1038/s41598-018-38299-4))

B. Cessac, D. Matzakou-Karvouniari, *The non linear dynamics of retinal waves Physica D: Volume 439*, November 2022, 133436 <https://hal.inria.fr/hal-03485137/file/main.pdf>

- Stage II retinal waves are due to the conjunction of :
 - 1) **Spontaneous bursting** (initiation) ;
 - 2) **Acetylcholine network** (propagation) ;
 - 3) **Long refractoriness** (stop);
- Waves propagate in a **random landscape** with **refractory zones** left by the previous waves (similar to forest fires although more complex).

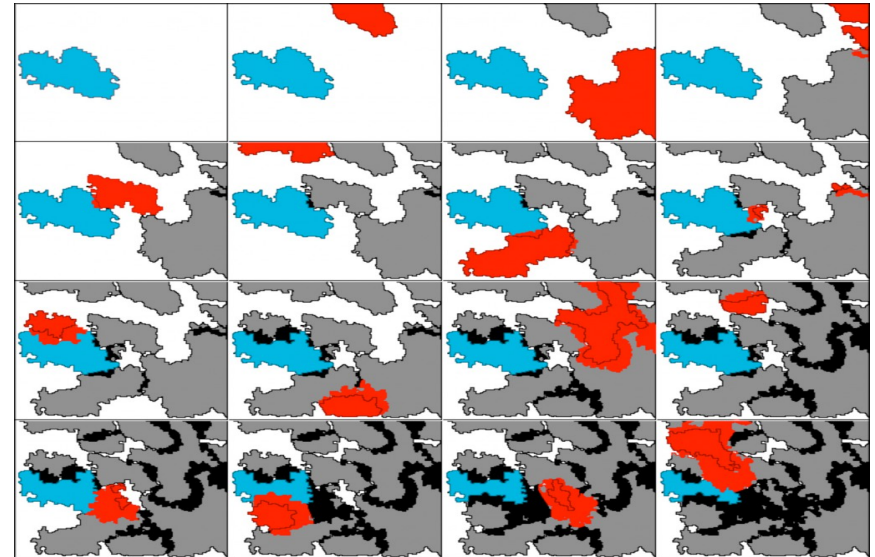

<https://webvision.med.utah.edu/book/part-vi-development-of-cell-types-and-synaptic-connections-in-the-retina/formation-of-early-retinal-circuits-in-the-inner-plexiform-layer/>

The nonlinear dynamics of retinal waves

D. Matzakou-Karvouniari, L. Gil, E. Orendorff, O. Marre, S. Picaud, B. Cessac, « A biophysical model explains the spontaneous bursting behavior in the developing retina », *Scientific Reports*, Nature Publishing Group, 2019, 9 (1), pp.1-23. {10.1038/s41598-018-38299-4}

B. Cessac, D. Matzakou-Karvouniari, *The non linear dynamics of retinal waves Physica D: Volume 439*, November 2022, 133436 <https://hal.inria.fr/hal-03485137/file/main.pdf>

- Stage II retinal waves are due to the conjunction of :
 - 1) **Spontaneous bursting** (initiation) ;
 - 2) **Acetylcholine network** (propagation) ;
 - 3) **Long refractoriness** (stop);
- Waves propagate in a **random landscape** with **refractory zones** left by the previous waves (similar to forest fires although more complex).
- The distribution of waves (long tail) looks like a **critical** phenomena. However, this regime is robust to physiological parameters variation => **Griffiths phase** ? (phase transition of infinite order)

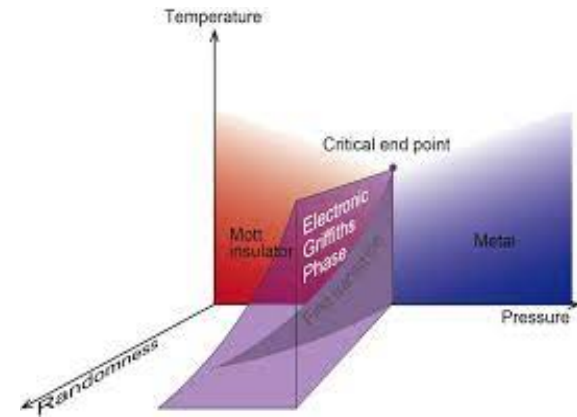

<https://phys.org/news/2020-02-electronic-griffiths-phase-solid-state-physical.html>

The nonlinear dynamics of retinal waves

D. Matzakou-Karvouniari, L. Gil, E. Orendorff, O. Marre, S. Picaud, B. Cessac, « A biophysical model explains the spontaneous bursting behavior in the developing retina », *Scientific Reports*, Nature Publishing Group, 2019, 9 (1), pp.1-23. {10.1038/s41598-018-38299-4}

B. Cessac, D. Matzakou-Karvouniari, *The non linear dynamics of retinal waves Physica D: Volume 439*, November 2022, 133436 <https://hal.inria.fr/hal-03485137/file/main.pdf>

- Stage II retinal waves are due to the conjunction of :
 - 1) Spontaneous bursting (initiation) ;
 - 2) Acetylcholine network (propagation) ;
 - 3) Long refractoriness (stop);
- Waves propagate in a **random landscape** with **refractory zones** left by the previous waves (similar to forest fires although more complex).
- The distribution of waves (long tail) looks like a **critical** phenomena. However, this regime is robust to physiological parameters variation => **Griffiths phase** ? (phase transition of infinite order)
- Cf visual cortex. *Girardi-Schappo, M., Bortolotto, G., Gonsalves, J. et al. Griffiths phase and long-range correlations in a biologically motivated visual cortex model. Sci Rep 6, 29561 (2016).*

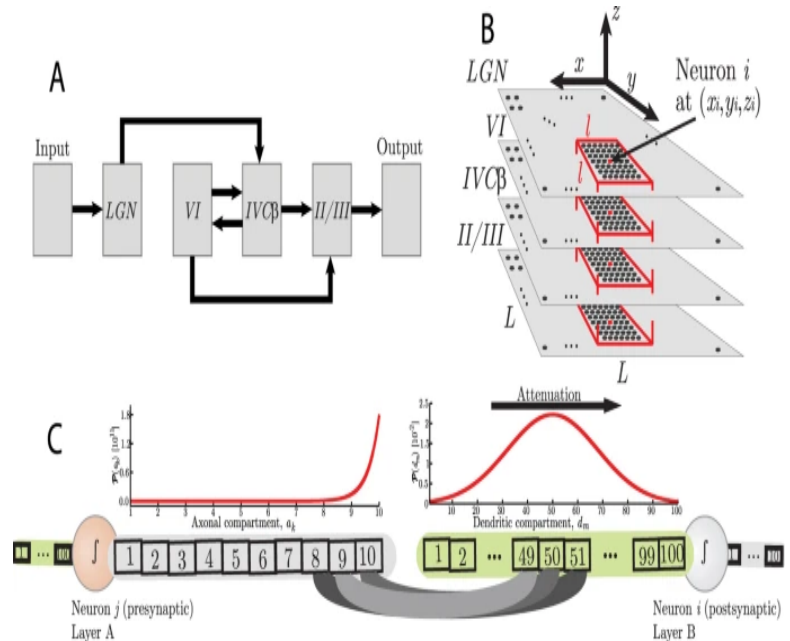

The nonlinear dynamics of retinal waves

D. Matzakou-Karvouniari, L. Gil, E. Orendorff, O. Marre, S. Picaud, B. Cessac, « A biophysical model explains the spontaneous bursting behavior in the developing retina », *Scientific Reports*, Nature Publishing Group, 2019, 9 (1), pp.1-23. {10.1038/s41598-018-38299-4}

B. Cessac, D. Matzakou-Karvouniari, *The non linear dynamics of retinal waves Physica D: Volume 439, November 2022, 133436* <https://hal.inria.fr/hal-03485137/file/main.pdf>

- Stage II retinal waves are due to the conjunction of :
 - 1) Spontaneous bursting (initiation) ;
 - 2) Acetylcholine network (propagation) ;
 - 3) Long refractoriness (stop);
- Waves propagate in a **random landscape** with **refractory zones** left by the previous waves (similar to forest fires although more complex).
- The distribution of waves (long tail) looks like a **critical** phenomena. However, this regime is robust to physiological parameters variation => **Griffiths phase ?** (phase transition of infinite order)
- Cf visual cortex. *Girardi-Schappo, M., Bortolotto, G., Gonsalves, J. et al. Griffiths phase and long-range correlations in a biologically motivated visual cortex model. Sci Rep 6, 29561 (2016).*
- This complex dynamics can be studied thanks to **bifurcation analysis** and **transport equations** (similar to KPZ).

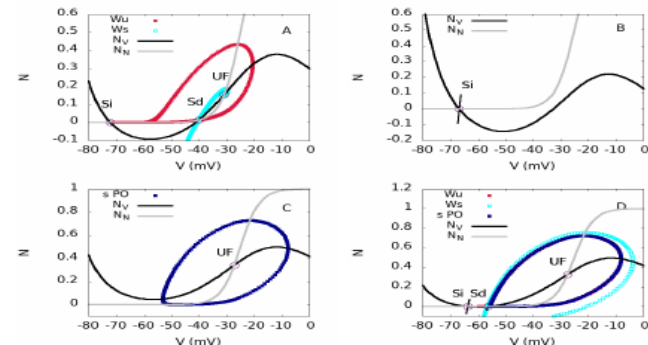
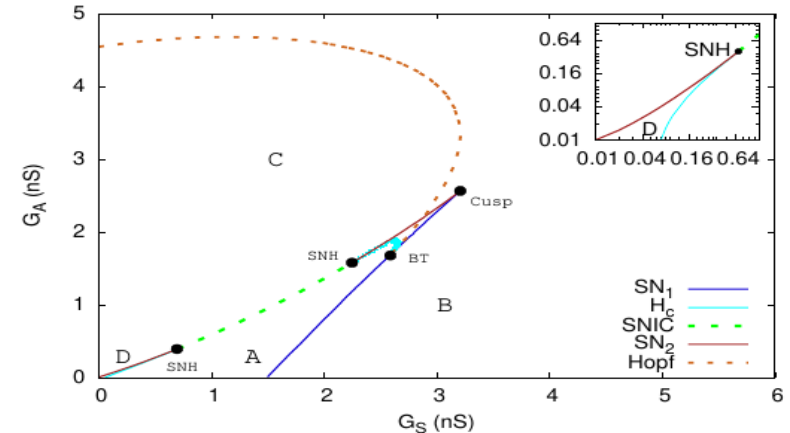

How do our eyes learn to see ?

- Our eyes start to learn and see ***before birth***.
- This process (retinal waves) is ***spontaneous*** and does not require a huge data basis of « natural » images.
- This process is partly controlled by genetics but ***nonlinear dynamics*** plays a major role.
- (Partly) due to this mechanism the visual system is able to handle **motion**.

How do our eyes learn to see ?

- Our eyes start to learn and see ***before birth***.
- This process (retinal waves) is ***spontaneous*** and does not require a huge data basis of « natural » images.
- This process is partly controlled by genetics but ***nonlinear dynamics*** plays a major role.
- (Partly) due to this mechanism the visual system is able to handle **motion**.

Using retinal waves to train ***AI networks*** ?

How do our eyes learn to see ?

- Our eyes start to learn and see **before birth**.
- This process (retinal waves) is **spontaneous** and does not require a huge data basis of « natural » images.
- This process is partly controlled by genetics but **nonlinear dynamics** plays a major role.
- (Partly) due to this mechanism the visual system is able to handle **motion**.

Using retinal waves to train **AI networks** ?

Waves **distribution** plays a major role
+
dynamical shaping of the retina and visual cortex.

Conclusions

- Visual entries are **neither stationary**, nor **spatially regular**.

Conclusions

- Visual entries are **neither stationary**, nor **spatially regular**.
- The « **longitudinal** » retinal pathways PhotoReceptors => Bipolar cells => Ganglion cells efficiently encode the visual information into **parallel flows**.

Conclusions

- Visual entries are **neither stationary**, nor **spatially regular**.
- The « **longitudinal** » retinal pathways PhotoReceptors => Bipolar cells => Ganglion cells efficiently encode the visual information into **parallel flows**.
- On the basis of biophysical modelling + mathematical analysis we found that Amacrine cells may generate, from a **moving stimulus**, **spatio-temporal correlations (waves)** contributing to better encoding a visual scene (e.g. **anticipation**).

Conclusions

- Visual entries are **neither stationary**, nor **spatially regular**.
- The « **longitudinal** » retinal pathways PhotoReceptors => Bipolar cells => Ganglion cells efficiently encode the visual information into **parallel flows**.
- On the basis of biophysical modelling + mathematical analysis we found that Amacrine cells may generate, from a **moving stimulus**, **spatio-temporal correlations (waves)** contributing to better encoding a visual scene (e.g. **anticipation**).

*Waves induce a **spatio-temporal ordering** which could be helpful to train **AI systems** featuring the visual processing.*

Thanks ◀◀