



HAL
open science

Retinal processing: Insights from mathematical modelling

Bruno Cessac

► **To cite this version:**

Bruno Cessac. Retinal processing: Insights from mathematical modelling. EURANDOM workshop on Stochastic Models in Life Sciences, Sep 2022, Eindhoven, Netherlands. hal-03774467

HAL Id: hal-03774467

<https://inria.hal.science/hal-03774467>

Submitted on 12 Sep 2022

HAL is a multi-disciplinary open access archive for the deposit and dissemination of scientific research documents, whether they are published or not. The documents may come from teaching and research institutions in France or abroad, or from public or private research centers.

L'archive ouverte pluridisciplinaire **HAL**, est destinée au dépôt et à la diffusion de documents scientifiques de niveau recherche, publiés ou non, émanant des établissements d'enseignement et de recherche français ou étrangers, des laboratoires publics ou privés.

Retinal processing: Insights from mathematical modelling

B. Cessac, Université Côte d'Azur, INRIA,
Biovision team and Neuromod Institute
Sophia Antipolis, France



The retina and its dynamics

The visual system

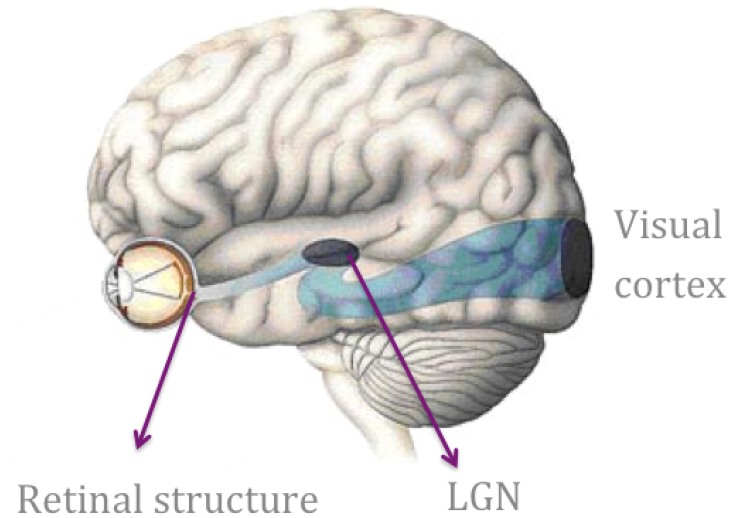

The visual system

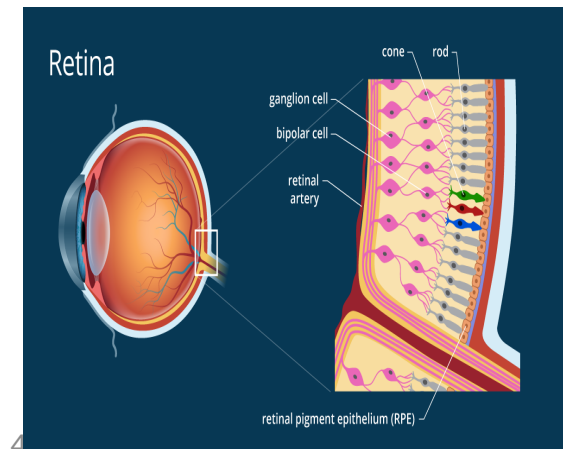
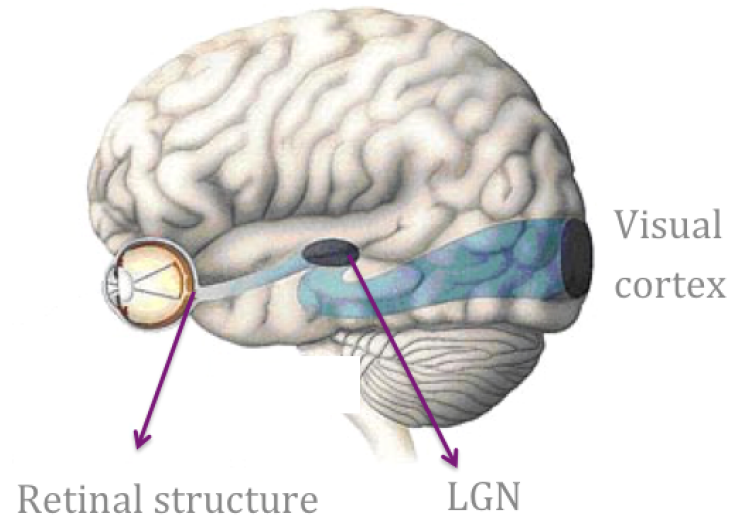

The visual system

Retina's layered structure

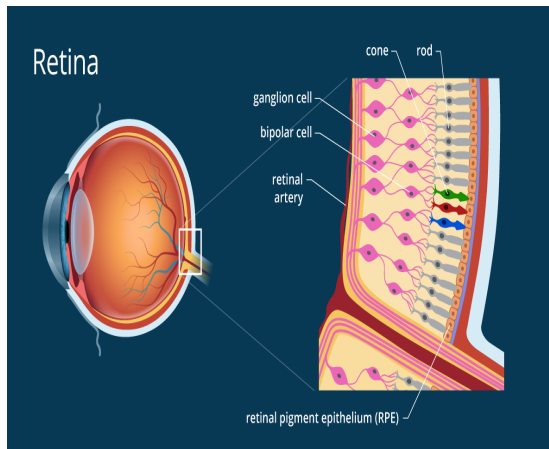
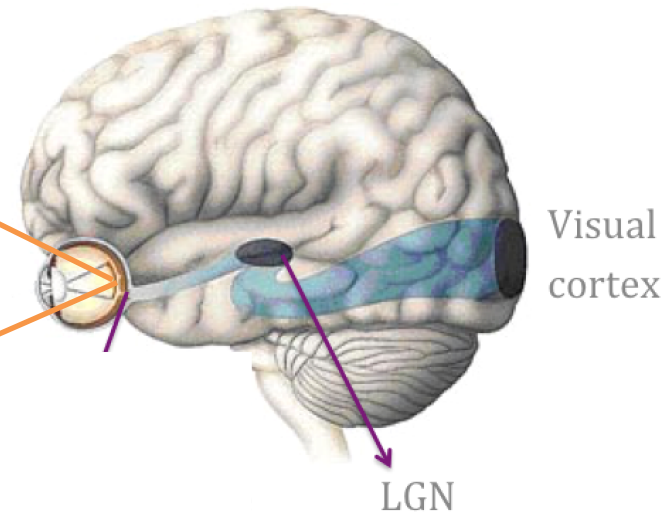
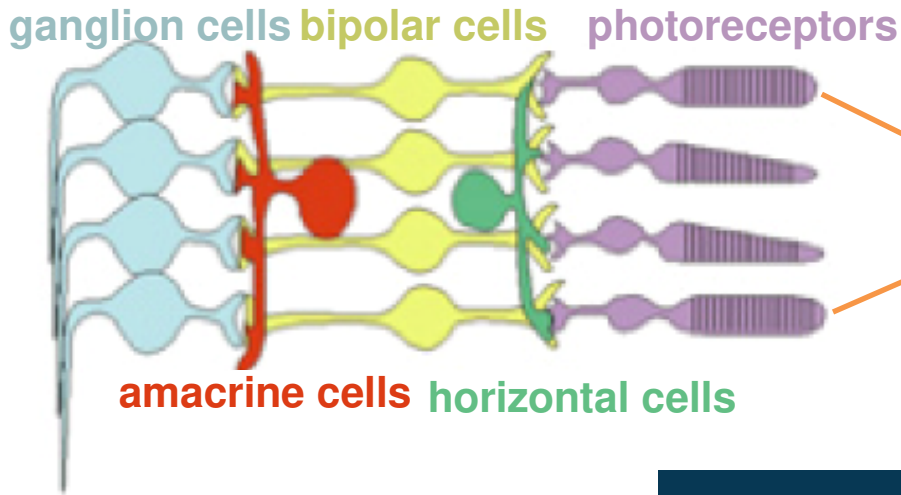

The visual system

Retina's layered structure

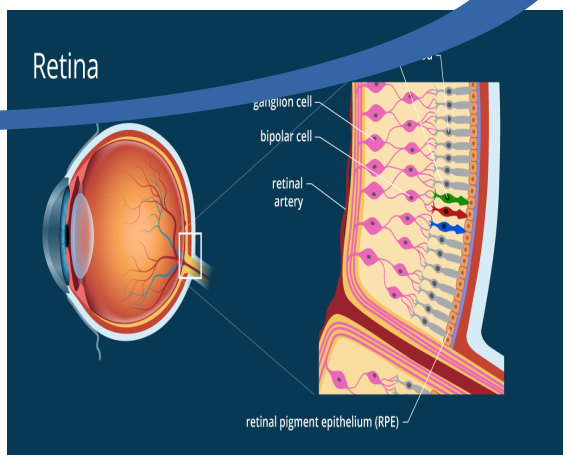
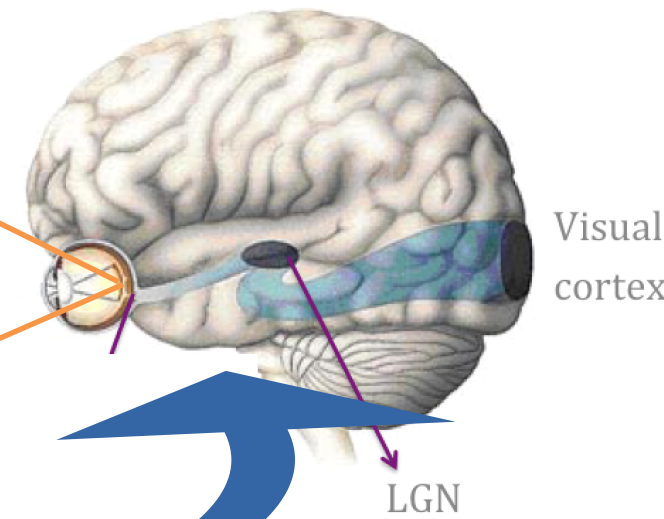
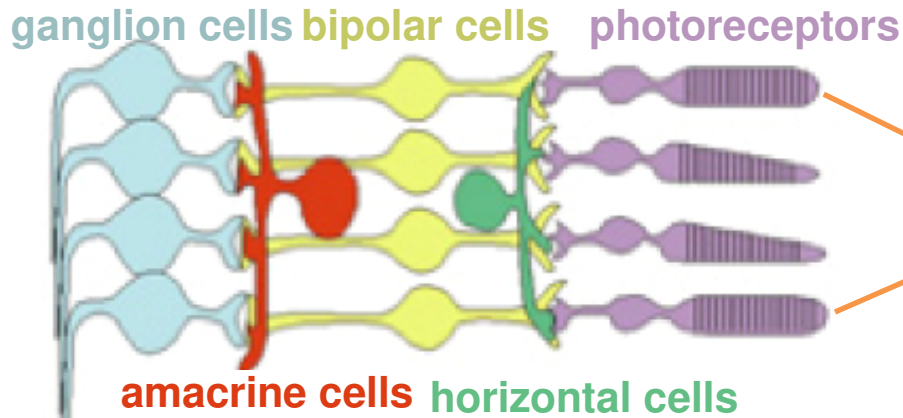

The visual system

Retina's layered structure

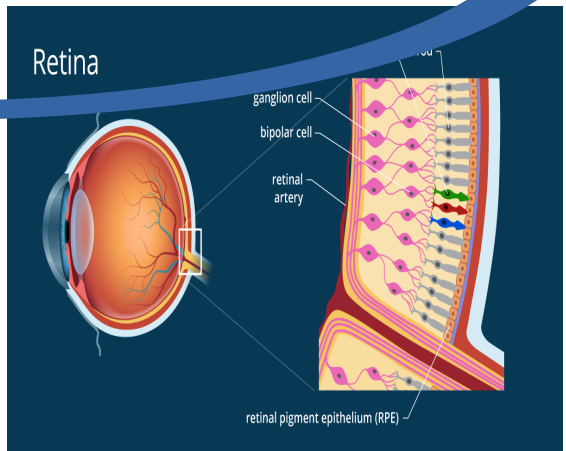
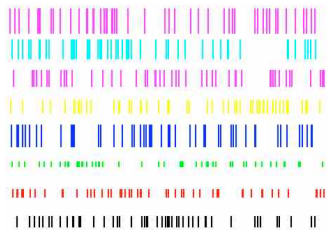
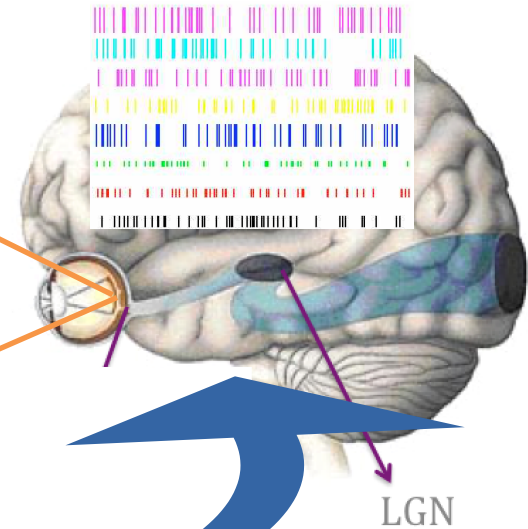
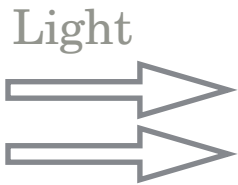
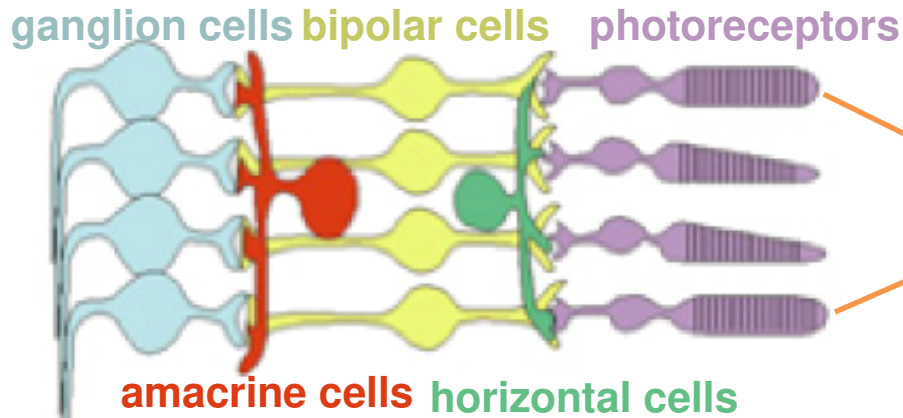

The visual system

Retina's layered structure

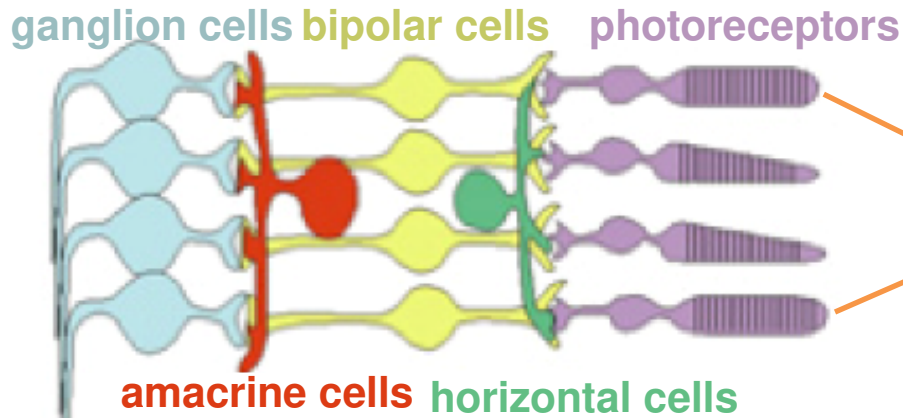

Light

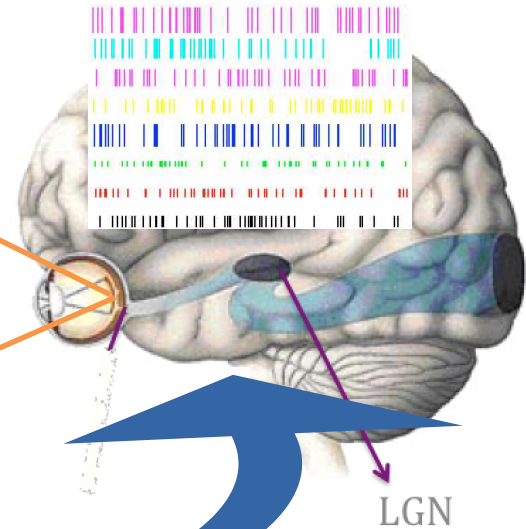

Visual cortex

LGN

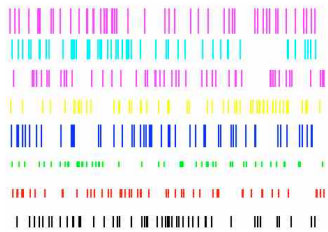

« Information » flux

The visual system

Retina's layered structure

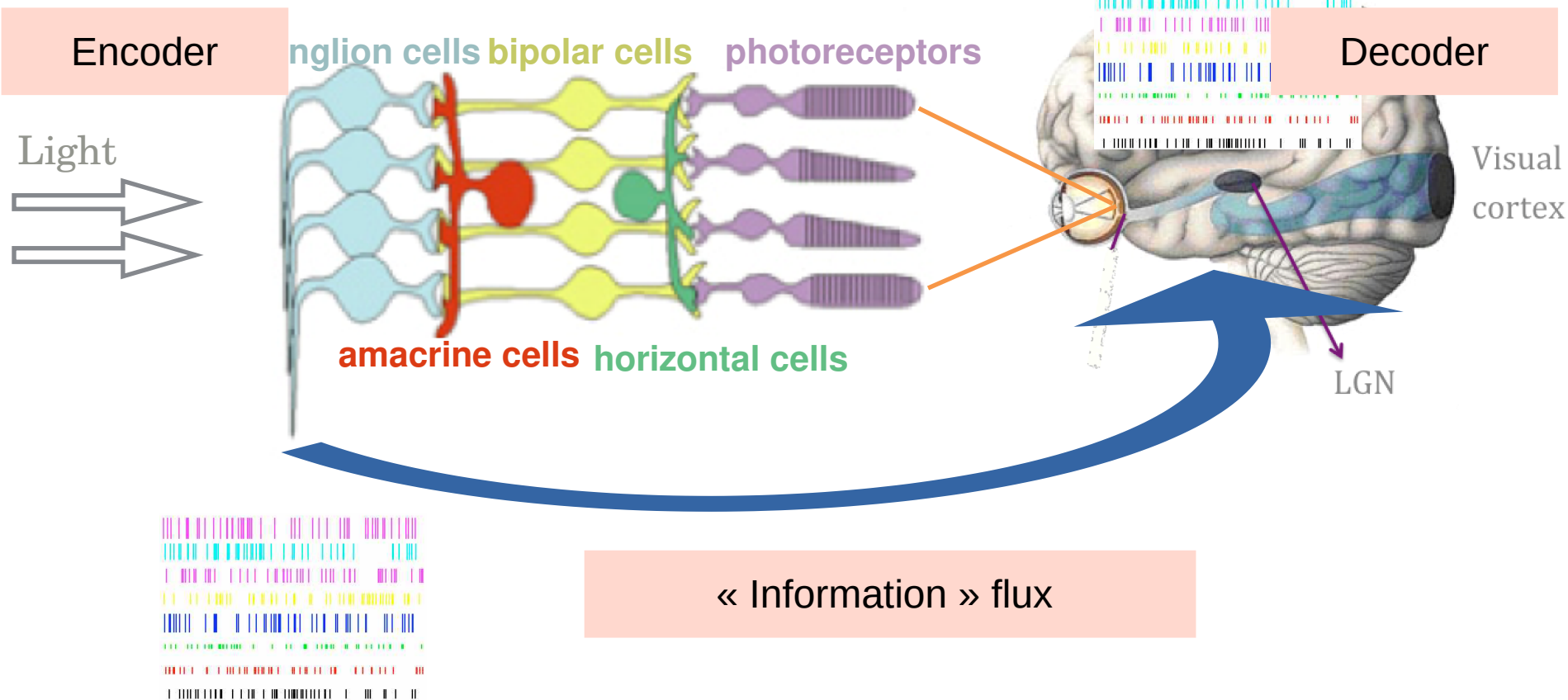

The visual system

Retina's layered structure

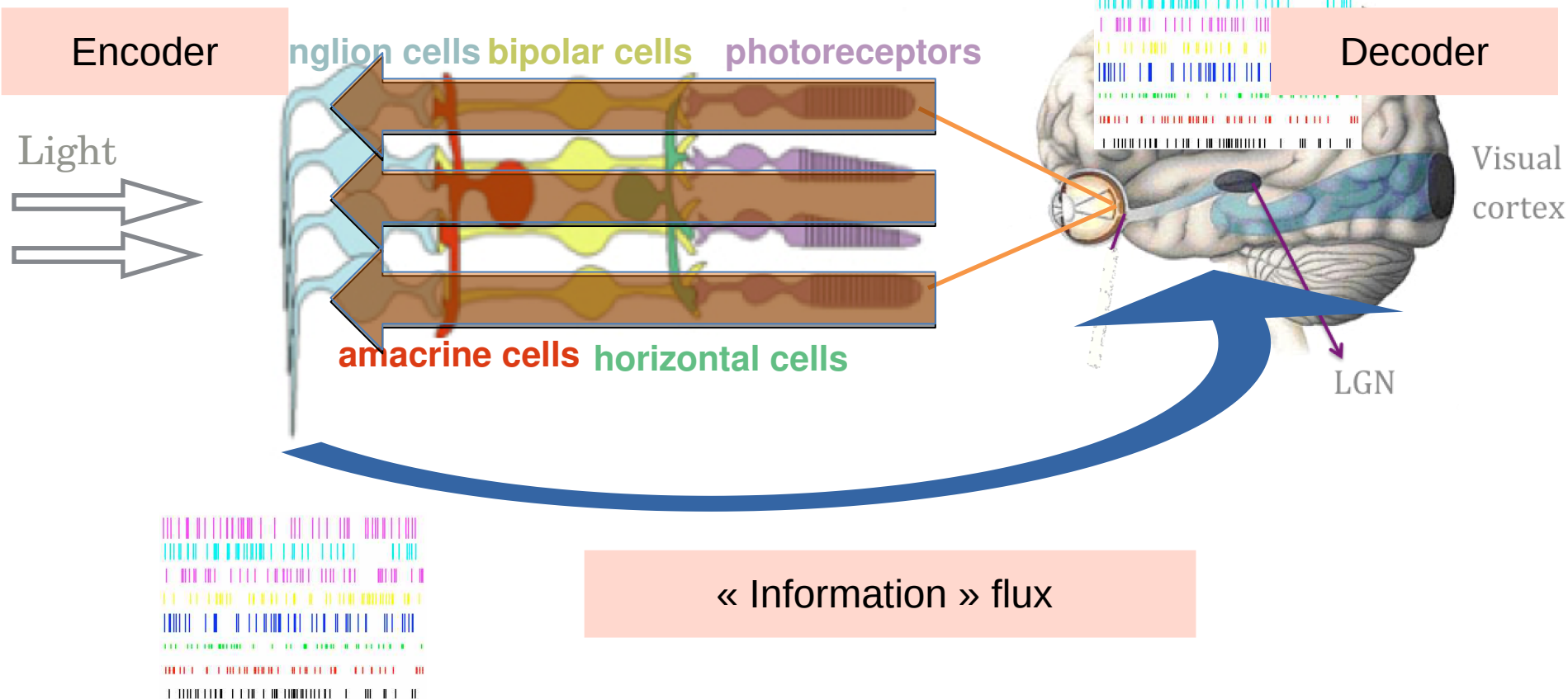

The visual system

Retina's layered structure

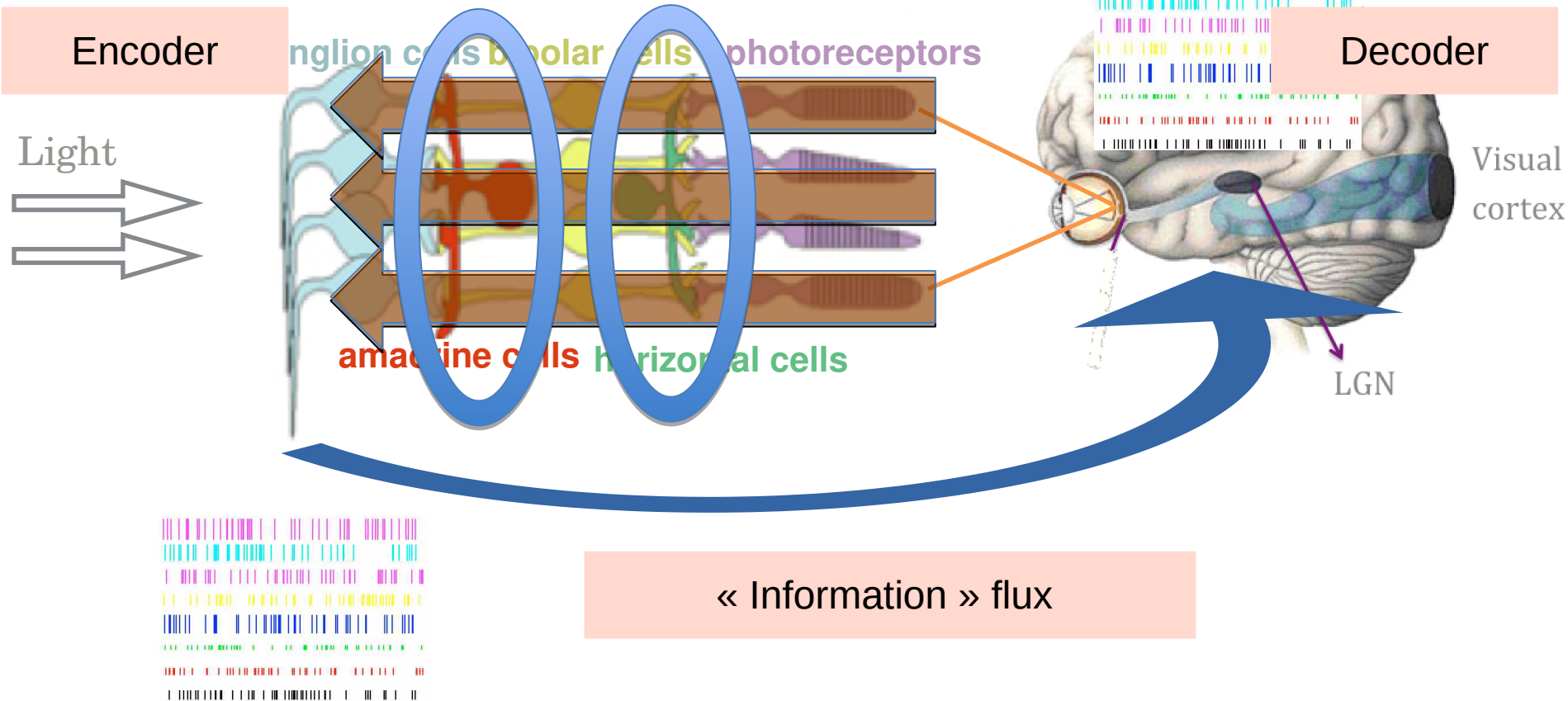

The visual system

Retina's layered structure

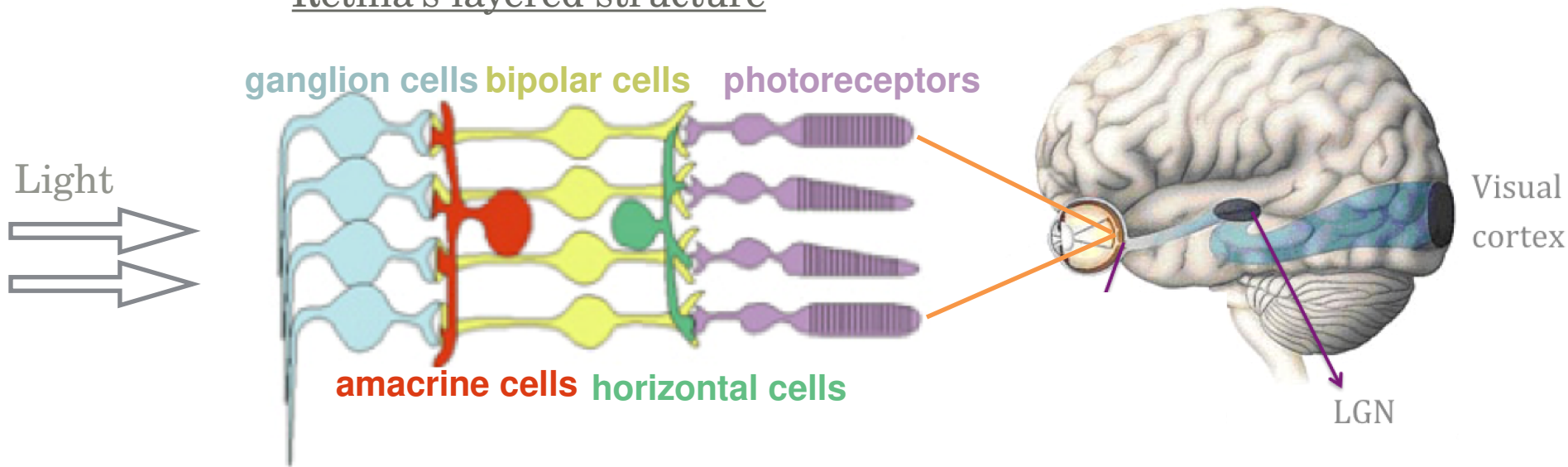

Analogic computing.

No spikes except at GCells

**Individual neurons and synapses
DO matter.**

**Dedicated circuits made of a few
neurons and synapses process the
local visual information.**

**« Information » is processed by
spikes.**

**Individual neurons and synapses do
not matter.**

**Population dynamics, PDEs,
statistical physics, large
deviations ...**

A modeller point of view

1. The retina is a ***high dimensional, non autonomous and noisy*** dynamical system, layered and structured, with ***non stationary and spatially inhomogeneous entries*** (visual scenes).

A modeller point of view

1. The retina is a ***high dimensional, non autonomous and noisy*** dynamical system, layered and structured, with ***non stationary and spatially inhomogeneous entries*** (visual scenes).
2. ***Local circuits*** of non linear cells, connected with non linear synapses efficiently process the ***local visual information***. These local circuits are connected together, spanning the whole retina in a ***regular tiling***.

A modeller point of view

1. The retina is a ***high dimensional, non autonomous and noisy*** dynamical system, layered and structured, with ***non stationary and spatially inhomogeneous entries*** (visual scenes).
2. ***Local circuits*** of non linear cells, connected with non linear synapses efficiently process the ***local visual information***. These local circuits are connected together, spanning the whole retina in a ***regular tiling***.
3. The conjunction of non linearities and regular structure can produce a highly ***disordered spatio-temporal*** dynamics.

A modeller point of view

1. The retina is a **high dimensional, non autonomous and noisy** dynamical system, layered and structured, with **non stationary and spatially inhomogeneous entries** (visual scenes).
2. **Local circuits** of non linear cells, connected with non linear synapses efficiently process the **local visual information**. These local circuits are connected together, spanning the whole retina in a **regular tiling**.
3. The conjunction of non linearities and regular structure can produce a highly **disordered spatio-temporal** dynamics.
4. The retina is sensitive to **changes in its physiology** (development, pharmacology, pathologies). These changes can be addressed from the point of view of **bifurcations theory**.

Questions

I. Spatio-temporal spike correlations.

1. What could be the **spatio-temporal distribution of spikes** emitted from the retina to the LGN-cortex, considering that inputs are *non stationary* (moving objects) ?
2. What could be the *non stationary structure of spatio-temporal correlations* ?
3. In particular is it possible to disentangle the effects of:
 - i. **Stimulus** induced correlations;
 - ii. **Network** induced correlations ;
 - iii. **Non linearities**.

Questions

I. Spatio-temporal spike correlations.

1. What could be the **spatio-temporal distribution of spikes** emitted from the retina to the LGN-cortex, considering that inputs are *non stationary* (moving objects) ?
2. What could be the *non stationary structure of spatio-temporal correlations* ?
3. In particular is it possible to disentangle the effects of:
 - i. **Stimulus** induced correlations;
 - ii. **Network** induced correlations ;
 - iii. **Non linearities**.

II. Cortical model

1. Which **mechanism/principle** is used to decipher "at best" the trajectory of a moving object from the retinal spike trains ?
 - i. Firing rates ?
 - ii. Individual spikes ?
 - iii. Both ?
2. What could be the implications of questions/answers in item I with respect to the theory of **efficient coding** ?

A retina model

Building a 2D retina model

Souihel S., Cessac B., “On the potential role of lateral connectivity in retinal anticipation”, *Journal of Mathematical Neuroscience*, BioMed Central, 2021, 11, {10.1186/s13408-020-00101-z}

Building a 2D retina model

Souihel S., Cessac B., “On the potential role of lateral connectivity in retinal anticipation”, Journal of Mathematical Neuroscience, BioMed Central, 2021, 11, {10.1186/s13408-020-00101-z}

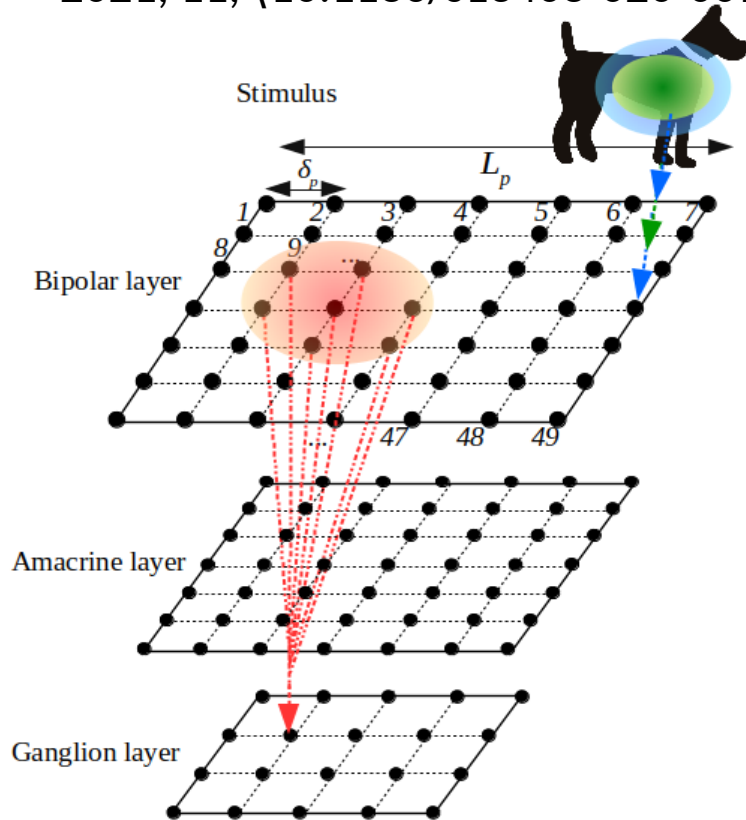

Building a 2D retina model

Souihel S., Cessac B., "On the potential role of lateral connectivity in retinal anticipation", Journal of Mathematical Neuroscience, BioMed Central, 2021, 11, {10.1186/s13408-020-00101-z}

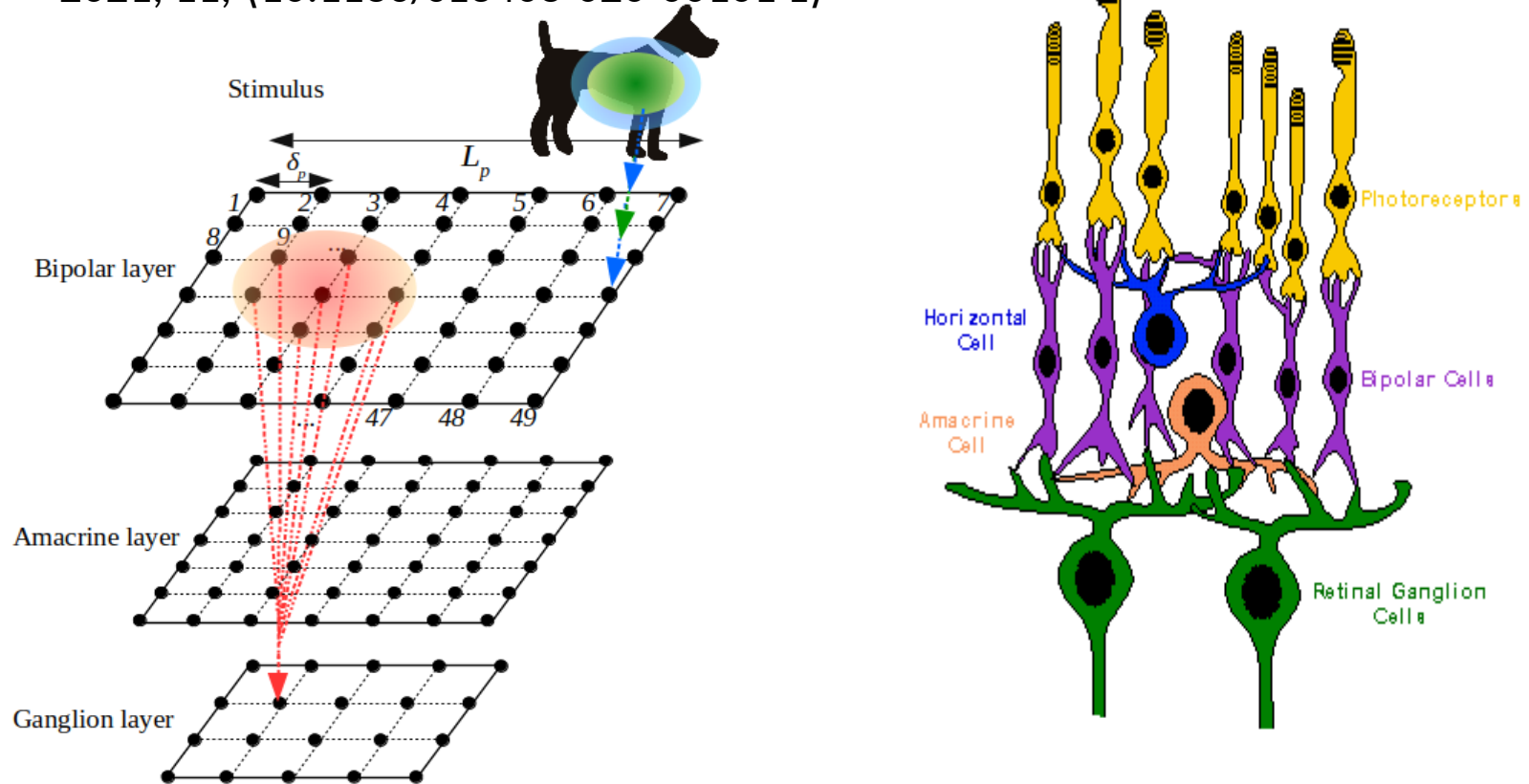

Building a 2D retina model

Souihel S., Cessac B., "On the potential role of lateral connectivity in retinal anticipation", Journal of Mathematical Neuroscience, BioMed Central, 2021, 11, {10.1186/s13408-020-00101-z}

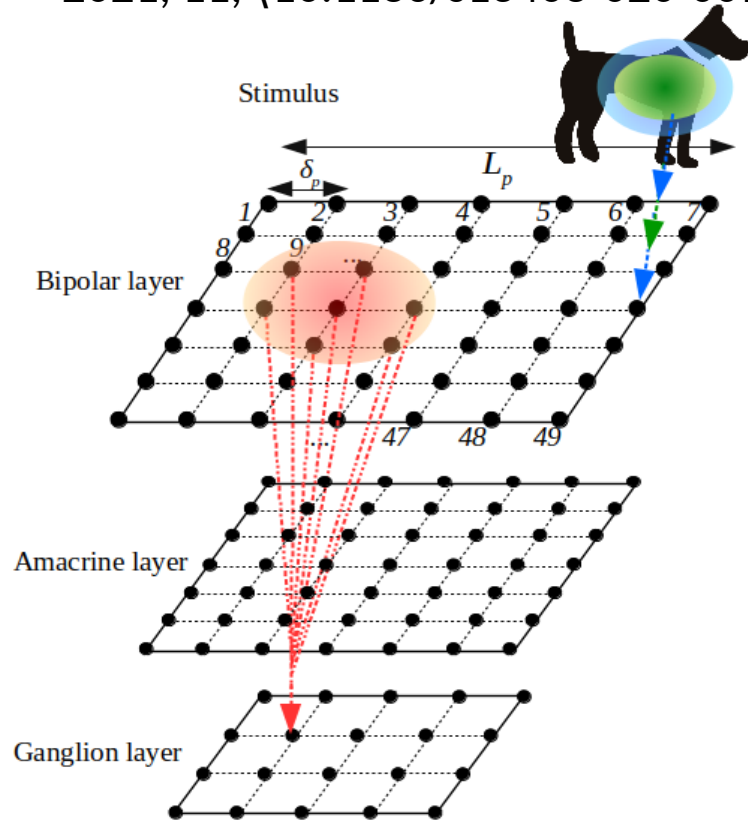

Modelled by a convolution kernel

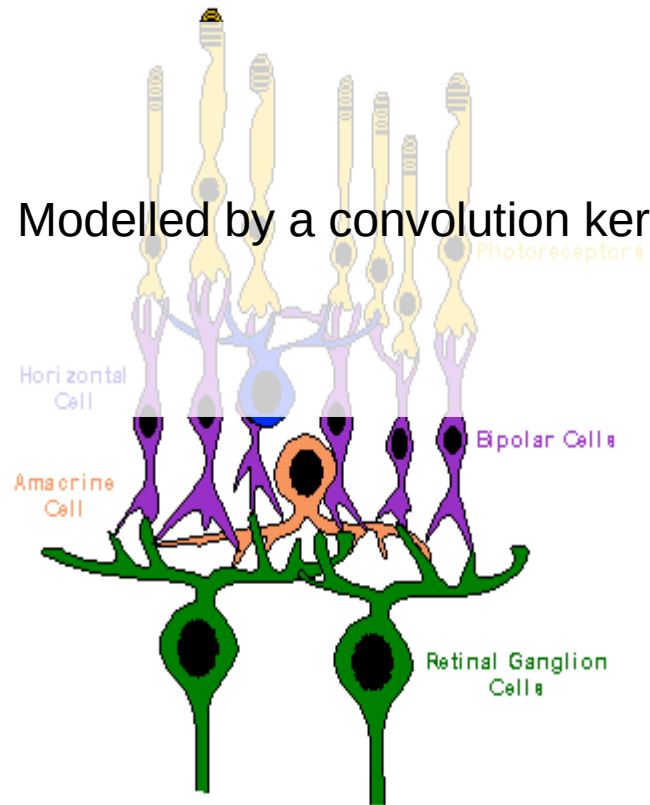

Building a 2D retina model

$$V_{i\text{drive}}(t) = \left[\mathcal{K}_{B_i} \begin{matrix} x,y,t \\ * \end{matrix} \mathcal{S} \right] (t)$$

$$= \int_{x=-\infty}^{+\infty} \int_{y=-\infty}^{+\infty} \int_{s=-\infty}^t \mathcal{K}_{B_i}(x-x_i, y-y_i, t-s) \mathcal{S}(x, y, s) dx dy ds.$$

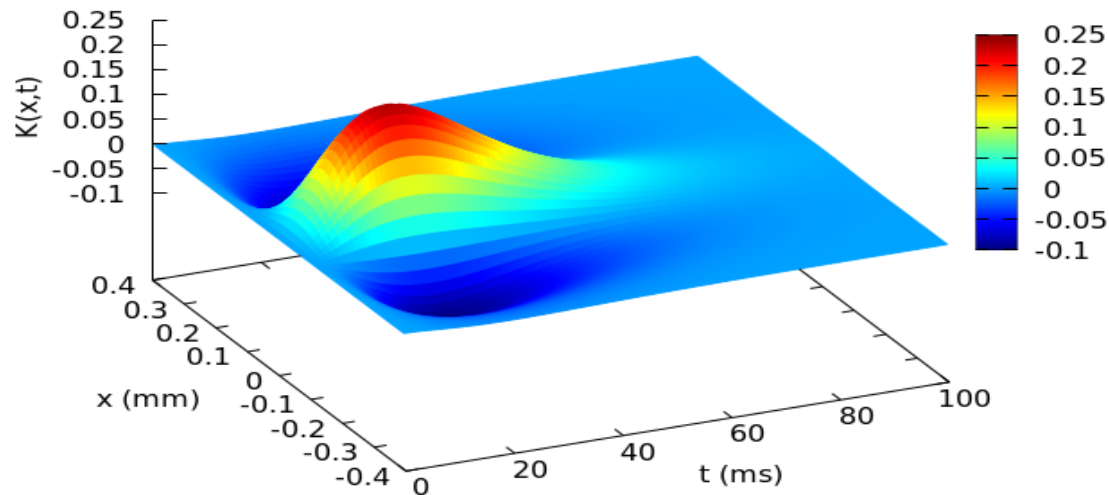

Building a 2D retina model

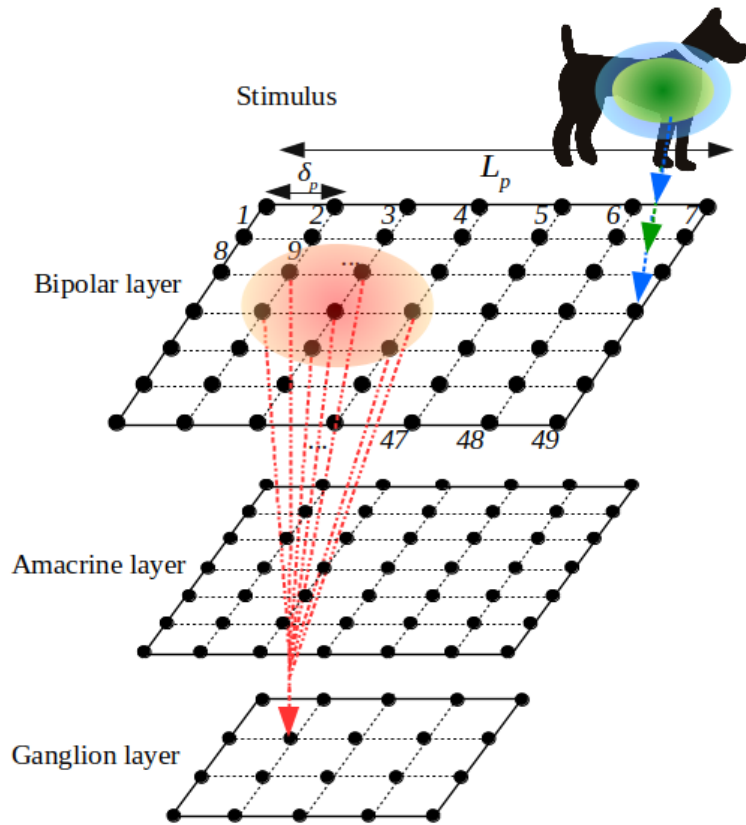

$$V_{i_{drive}}(t) = \left[\mathcal{K}_{B_i}^{x,y,t} * \mathcal{S} \right](t)$$

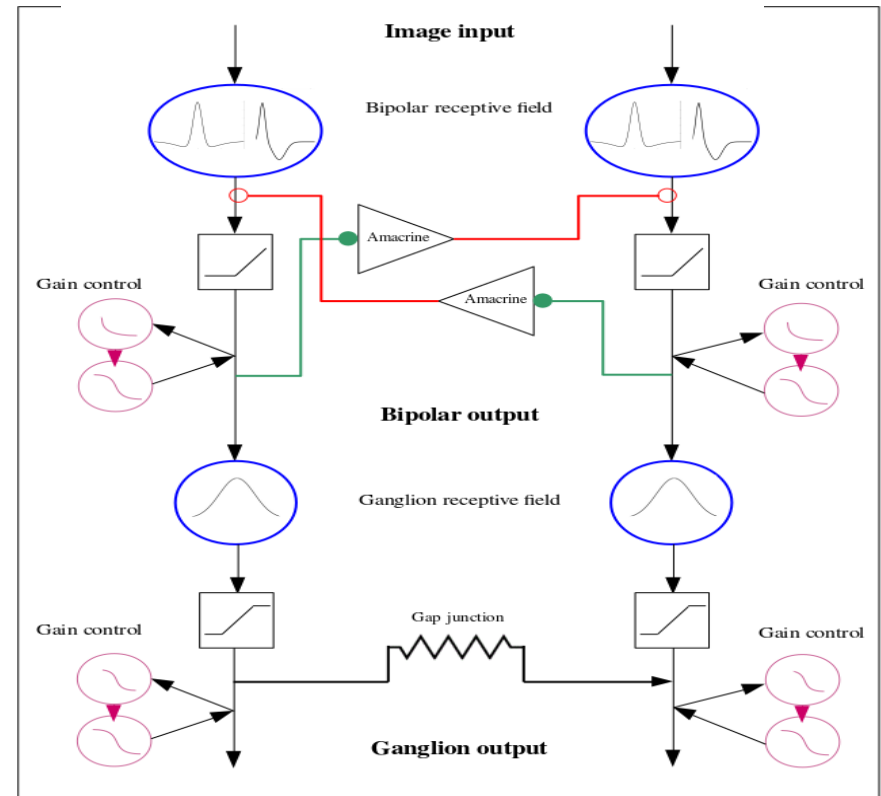

Building a 2D retina model

$$\begin{cases} \frac{dV_{B_i}}{dt} = -\frac{1}{\tau_B} V_{B_i} + \sum_{j=1}^{N_A} W_{B_i}^{A_j} \mathcal{N}_A(V_{A_j}) + F_{B_i}(t), \\ \frac{dV_{A_j}}{dt} = -\frac{1}{\tau_A} V_{A_j} + \sum_{i=1}^{N_B} W_{A_j}^{B_i} \mathcal{N}_B(V_{B_i}), \\ \frac{dV_{G_k}}{dt} = -\frac{1}{\tau_G} V_{G_k} + \sum_{i=1}^{N_B} W_{G_k}^{B_i} \mathcal{N}_B(V_{B_i}) + \sum_{j=1}^{N_A} W_{G_k}^{A_j} \mathcal{N}_A(V_{A_j}) \end{cases}$$

Voltage dynamics

$$V_{i_{drive}}(t) = \left[\mathcal{K}_{B_i}^{x,y,t} * \mathcal{S} \right](t)$$

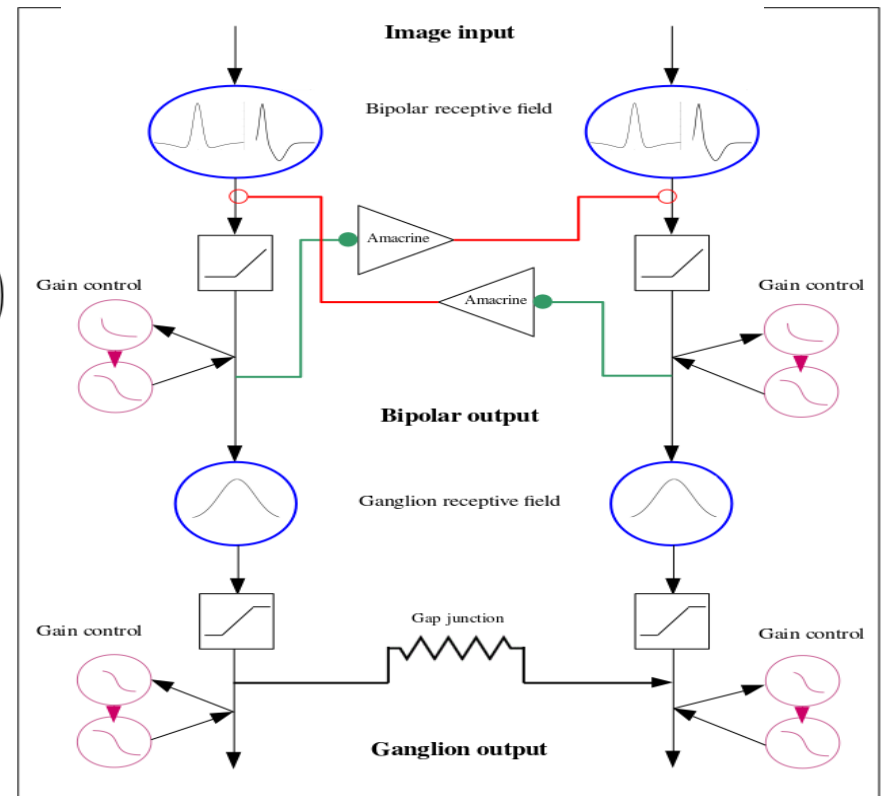

Building a 2D retina model

Stimulus dependent drive

$$F_{B_i}(t) = \frac{V_{i_{drive}}}{\tau_B} + \frac{dV_{i_{drive}}}{dt}$$

$$\left\{ \begin{aligned} \frac{dV_{B_i}}{dt} &= -\frac{1}{\tau_B} V_{B_i} + \sum_{j=1}^{N_A} W_{B_i}^{A_j} \mathcal{N}_A(V_{A_j}) - F_{B_i}(t), \\ \frac{dV_{A_j}}{dt} &= -\frac{1}{\tau_A} V_{A_j} + \sum_{i=1}^{N_B} W_{A_j}^{B_i} \mathcal{N}_B(V_{B_i}), \\ \frac{dV_{G_k}}{dt} &= -\frac{1}{\tau_G} V_{G_k} + \sum_{i=1}^{N_B} W_{G_k}^{B_i} \mathcal{N}_B(V_{B_i}) + \sum_{j=1}^{N_A} W_{G_k}^{A_j} \mathcal{N}_A(V_{A_j}) \end{aligned} \right.$$

Voltage dynamics

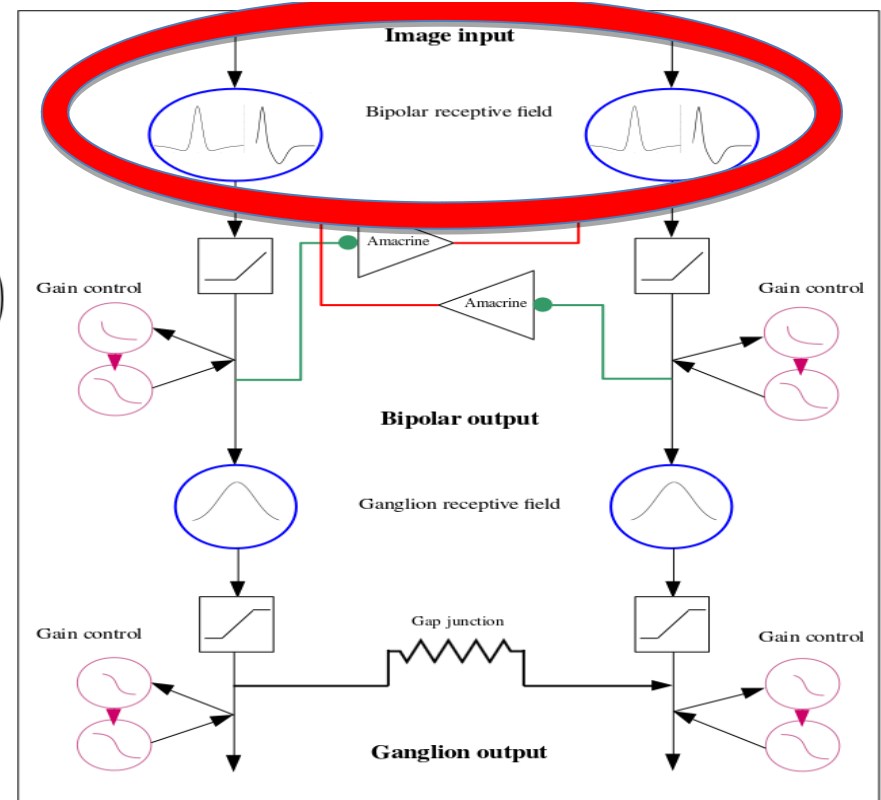

Building a 2D retina model

$$\begin{cases} \frac{dV_{B_i}}{dt} = -\frac{1}{\tau_B} V_{B_i} + \sum_{j=1}^{N_A} W_{B_i}^{A_j} \mathcal{N}_A(V_{A_j}) - F_{B_i}(t), \\ \frac{dV_{A_j}}{dt} = -\frac{1}{\tau_A} V_{A_j} + \sum_{i=1}^{N_B} W_{A_j}^{B_i} \mathcal{N}_B(V_{B_i}), \\ \frac{dV_{G_k}}{dt} = -\frac{1}{\tau_G} V_{G_k} + \sum_{i=1}^{N_B} W_{G_k}^{B_i} \mathcal{N}_B(V_{B_i}) - \sum_{j=1}^{N_A} W_{G_k}^{A_j} \mathcal{N}_A(V_{A_j}) \end{cases}$$

Voltage dynamics

$$\mathcal{N}_A(V) = \begin{cases} V - \theta_A, & \text{if } V_A > \theta_A; \\ 0, & \text{otherwise} \end{cases}$$

$$V_{i_{drive}}(t) = \left[\mathcal{K}_{B_i}^{x,y,t} * \mathcal{S} \right](t)$$

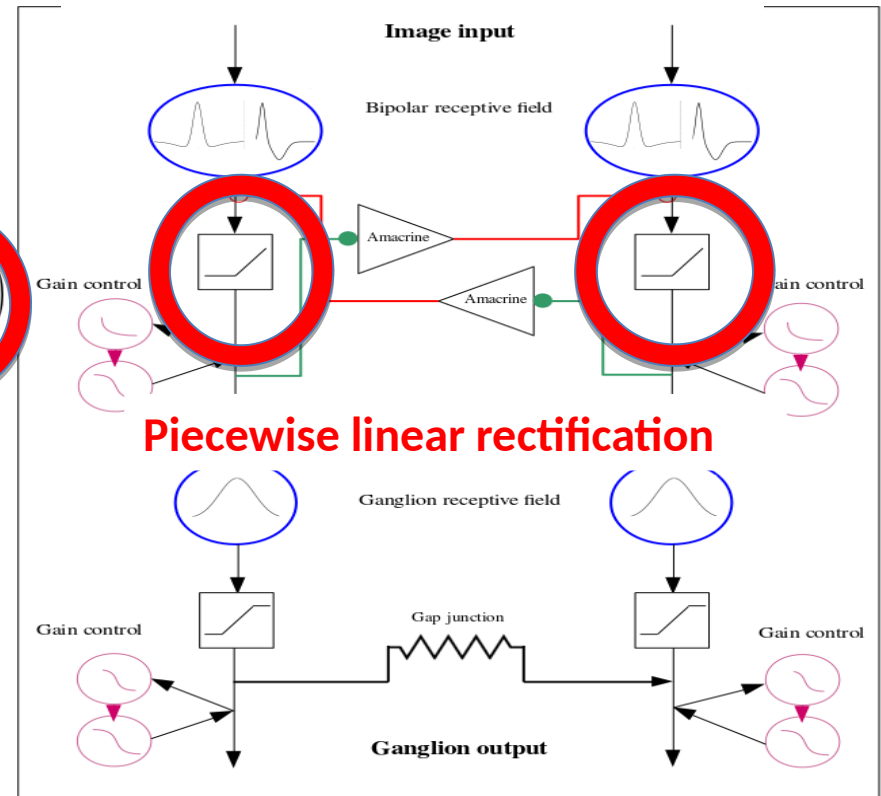

Building a 2D retina model

Inhibition

$$\begin{cases} \frac{dV_{B_i}}{dt} = -\frac{1}{\tau_B} V_{B_i} + \sum_{j=1}^{N_A} W_{B_i}^{A_j} \mathcal{N}_A(V_{A_j}) + F_{B_i}(t), \\ \frac{dV_{A_j}}{dt} = -\frac{1}{\tau_A} V_{A_j} + \sum_{i=1}^{N_B} W_{A_j}^{B_i} \mathcal{N}_B(V_{B_i}), \\ \frac{dV_{G_k}}{dt} = -\frac{1}{\tau_G} V_{G_k} + \sum_{i=1}^{N_B} W_{G_k}^{B_i} \mathcal{N}_B(V_{B_i}) + \sum_{j=1}^{N_A} W_{G_k}^{A_j} \mathcal{N}_A(V_{A_j}) \end{cases}$$

Voltage dynamics

$$V_{i_{drive}}(t) = \left[\mathcal{K}_{B_i}^{x,y,t} * \mathcal{S} \right](t)$$

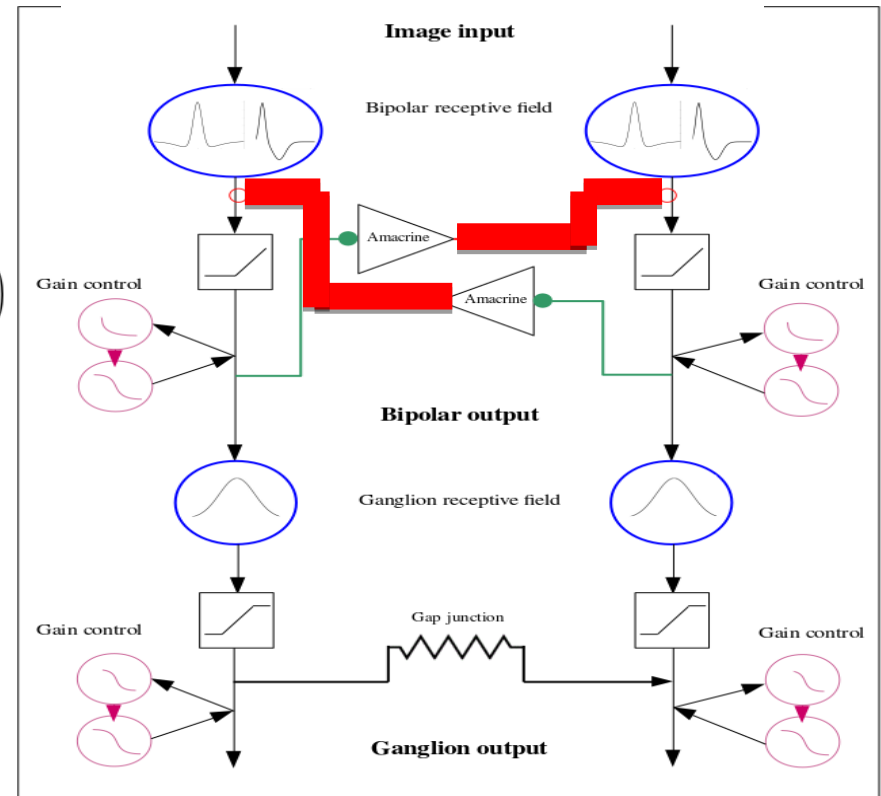

Building a 2D retina model

Excitation

$$V_{i\text{drive}}(t) = \left[\mathcal{K}_{B_i}^{x,y,t} * \mathcal{S} \right](t)$$

$$\begin{cases} \frac{dV_{B_i}}{dt} = -\frac{1}{\tau_B} V_{B_i} + \sum_{j=1}^{N_A} W_{B_i}^{A_j} \mathcal{N}_A(V_{A_j}) + F_{B_i}(t), \\ \frac{dV_{A_j}}{dt} = -\frac{1}{\tau_A} V_{A_j} + \sum_{i=1}^{N_B} \mathbf{W}_{A_j}^{B_i} \mathcal{N}_B(V_{B_i}), \\ \frac{dV_{G_k}}{dt} = -\frac{1}{\tau_G} V_{G_k} + \sum_{i=1}^{N_B} \mathbf{W}_{G_k}^{B_i} \mathcal{N}_B(V_{B_i}) + \sum_{j=1}^{N_A} W_{G_k}^{A_j} \mathcal{N}_A(V_{A_j}) \end{cases}$$

Voltage dynamics

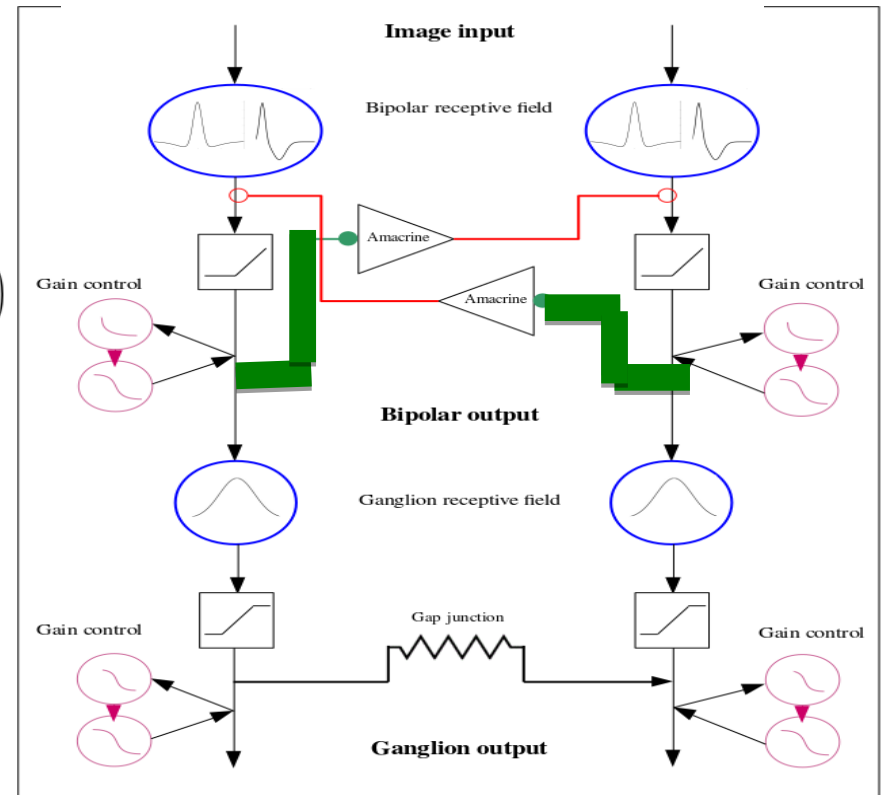

Building a 2D retina model

$$\begin{cases} \frac{dV_{B_i}}{dt} = -\frac{1}{\tau_B} V_{B_i} + \sum_{j=1}^{N_A} W_{B_i}^{A_j} \mathcal{N}_A(V_{A_j}) + F_{B_i}(t), \\ \frac{dV_{A_j}}{dt} = -\frac{1}{\tau_A} V_{A_j} + \sum_{i=1}^{N_B} W_{A_j}^{B_i} \mathcal{N}_B(V_{B_i}), \\ \frac{dV_{G_k}}{dt} = -\frac{1}{\tau_G} V_{G_k} + \sum_{i=1}^{N_B} W_{G_k}^{B_i} \mathcal{N}_B(V_{B_i}) + \sum_{j=1}^{N_A} W_{G_k}^{A_j} \mathcal{N}_A(V_{A_j}) \end{cases}$$

Voltage dynamics

$$\mathcal{N}_G(V_G) = \frac{1}{\sqrt{2\pi}} \int_{-\infty}^{\frac{V_G - \theta_G}{\sigma_G}} e^{-\frac{x^2}{2}} dx.$$

Spike rate

$$V_{i,drive}(t) = \left[\mathcal{K}_{B_i}^{x,y,t} * \mathcal{S} \right](t)$$

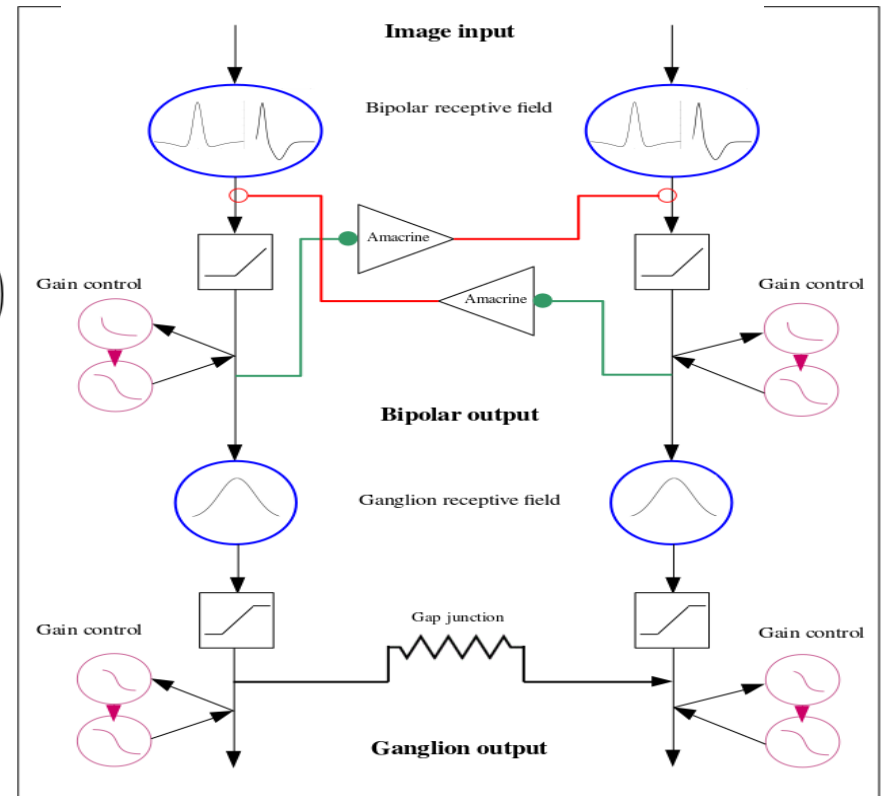

Building a 2D retina model

Dynamical system representation

$$\begin{cases} \frac{dV_{B_i}}{dt} = -\frac{1}{\tau_B} V_{B_i} + \sum_{j=1}^{N_A} W_{B_i}^{A_j} \mathcal{N}_A(V_{A_j}) + F_{B_i}(t), \\ \frac{dV_{A_j}}{dt} = -\frac{1}{\tau_A} V_{A_j} + \sum_{i=1}^{N_B} W_{A_j}^{B_i} \mathcal{N}_B(V_{B_i}), \\ \frac{dV_{G_k}}{dt} = -\frac{1}{\tau_G} V_{G_k} + \sum_{i=1}^{N_B} W_{G_k}^{B_i} \mathcal{N}_B(V_{B_i}) + \sum_{j=1}^{N_A} W_{G_k}^{A_j} \mathcal{N}_A(V_{A_j}) \end{cases}$$

$$\mathcal{F}_\alpha(t) = \begin{cases} F_{B_i}(t), & \alpha = i, \quad i = 1 \dots N_B; \\ 0, & \alpha > N_B; \end{cases}$$

$$\mathcal{X}_\alpha = \begin{cases} V_{B_i}, & \alpha = i, \quad i = 1 \dots N_B; \\ V_{A_j}, & \alpha = N_B + j, \quad j = 1 \dots N_A; \\ V_{G_k}, & \alpha = N_B + N_A + k, \quad k = 1 \dots N_G. \end{cases}$$

$$\mathcal{R}_\alpha(\vec{\mathcal{X}}) = \begin{cases} \mathcal{N}_B(V_{B_i}), & \alpha = i, \quad i = 1 \dots N_B; \\ \mathcal{N}_A(V_{A_j}), & \alpha = N_B + j, \quad j = 1 \dots N_A; \\ 0, & \alpha = N_B + N_A + k, \quad k = 1 \dots N_G. \end{cases}$$

$$\mathcal{W} = \begin{pmatrix} 0_{N_B N_B} & W_B^A & 0_{N_B N_G} \\ W_A^B & 0_{N_A N_A} & 0_{N_A N_G} \\ W_G^B & W_G^A & 0_{N_G N_G} \end{pmatrix}$$

Dynamics of the 2D retina model

Dynamical system representation

$$\frac{d\vec{\mathcal{X}}}{dt} = \mathcal{T}^{-1} \cdot \vec{\mathcal{X}} + \mathcal{W} \cdot \vec{\mathcal{R}}(\vec{\mathcal{X}}) + \vec{\mathcal{F}}(t).$$

$$\mathcal{T} = \begin{pmatrix} -\text{diag}[\tau_{B_i}]_{i=1\dots N_B} & 0_{N_B N_A} & 0_{N_B N_G} \\ 0_{N_A N_B} & -\text{diag}[\tau_{A_j}]_{j=1\dots N_A} & 0_{N_A N_G} \\ 0_{N_G N_B} & 0_{N_G N_A} & -\text{diag}[\tau_{G_k}]_{k=1\dots N_G} \end{pmatrix}.$$

$$\mathcal{F}_\alpha(t) = \begin{cases} F_{B_i}(t), & \alpha = i, \quad i = 1 \dots N_B; \\ 0, & \alpha > N_B; \end{cases}$$

$$\mathcal{X}_\alpha = \begin{cases} V_{B_i}, & \alpha = i, \quad i = 1 \dots N_B; \\ V_{A_j}, & \alpha = N_B + j, \quad j = 1 \dots N_A; \\ V_{G_k}, & \alpha = N_B + N_A + k, \quad k = 1 \dots N_G. \end{cases}$$

$$\mathcal{R}_\alpha(\vec{\mathcal{X}}) = \begin{cases} \mathcal{N}_B(V_{B_i}), & \alpha = i, \quad i = 1 \dots N_B; \\ \mathcal{N}_A(V_{A_j}), & \alpha = N_B + j, \quad j = 1 \dots N_A; \\ 0, & \alpha = N_B + N_A + k, \quad k = 1 \dots N_G. \end{cases}$$

$$\mathcal{W} = \begin{pmatrix} 0_{N_B N_B} & W_B^A & 0_{N_B N_G} \\ W_A^B & 0_{N_A N_A} & 0_{N_A N_G} \\ W_G^B & W_G^A & 0_{N_G N_G} \end{pmatrix}$$

Dynamics of the 2D retina model

$$\frac{d\vec{\mathcal{X}}}{dt} = \mathcal{T}^{-1} \cdot \vec{\mathcal{X}} + \mathcal{W} \cdot \vec{\mathcal{R}}(\vec{\mathcal{X}}) + \vec{\mathcal{F}}(t).$$

Piecewise linear dynamical system

$$\mathcal{R}_\alpha(\vec{\mathcal{X}}) = \begin{cases} \mathcal{N}_B(V_{B_i}), & \alpha = i, & i = 1 \dots N_B; \\ \mathcal{N}_A(V_{A_j}), & \alpha = N_B + j, & j = 1 \dots N_A; \\ 0, & \alpha = N_B + N_A + k, & k = 1 \dots N_G. \end{cases}$$

$$\mathcal{N}_A(V) = \begin{cases} V - \theta_A, & \text{if } V_A > \theta_A; \\ 0, & \text{otherwise} \end{cases},$$

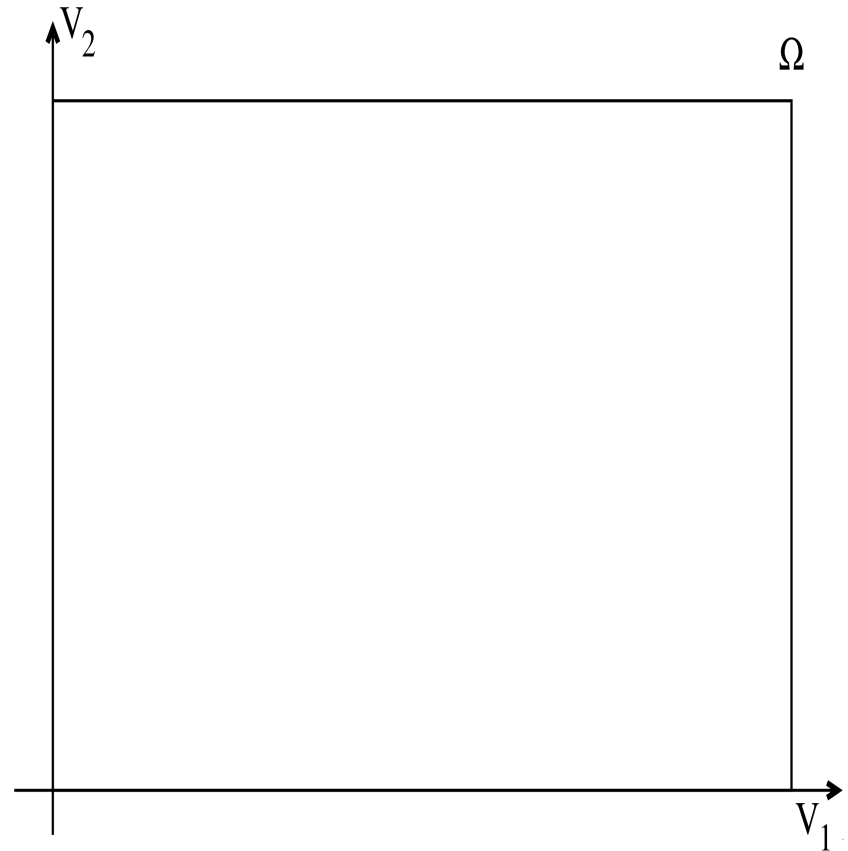

Dynamics of the 2D retina model

$$\frac{d\vec{\mathcal{X}}}{dt} = \mathcal{T}^{-1} \cdot \vec{\mathcal{X}} + \mathcal{W} \cdot \vec{\mathcal{R}}(\vec{\mathcal{X}}) + \vec{\mathcal{F}}(t).$$

Piecewise linear dynamical system

$$\mathcal{R}_\alpha(\vec{\mathcal{X}}) = \begin{cases} \mathcal{N}_B(V_{B_i}), & \alpha = i, & i = 1 \dots N_B; \\ \mathcal{N}_A(V_{A_j}), & \alpha = N_B + j, & j = 1 \dots N_A; \\ 0, & \alpha = N_B + N_A + k, & k = 1 \dots N_G. \end{cases}$$

$$\mathcal{N}_A(V) = \begin{cases} V - \theta_A, & \text{if } V_A > \theta_A; \\ 0, & \text{otherwise} \end{cases},$$

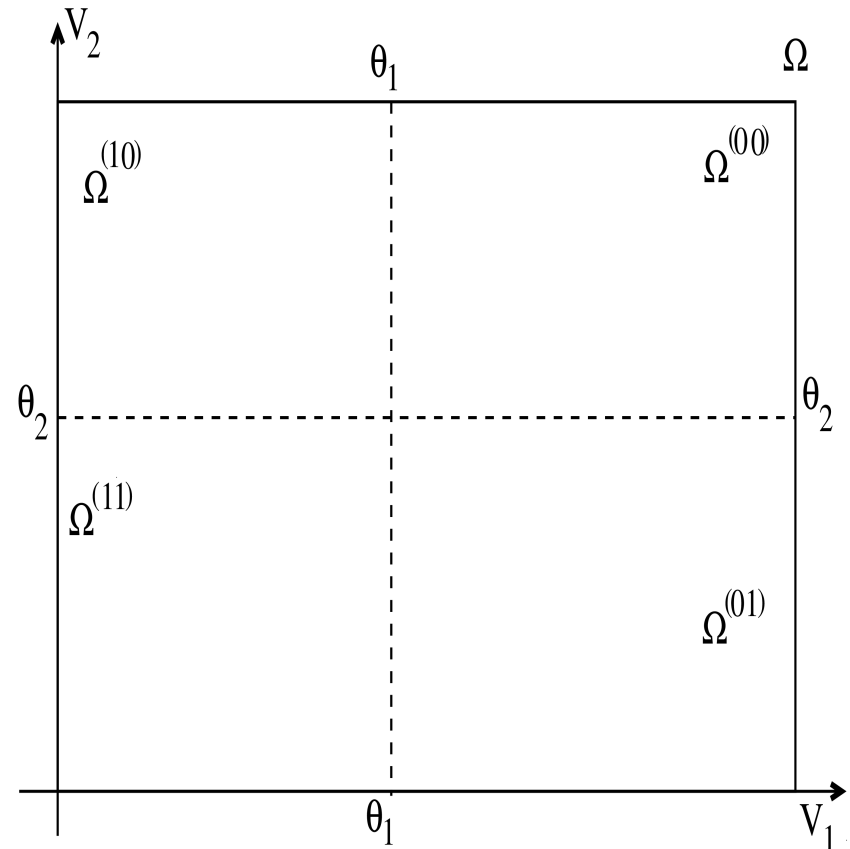

Dynamics of the 2D retina model

$$\frac{d\vec{\mathcal{X}}}{dt} = \mathcal{T}^{-1} \cdot \vec{\mathcal{X}} + \mathcal{W} \cdot \vec{\mathcal{R}}(\vec{\mathcal{X}}) + \vec{\mathcal{F}}(t).$$

Piecewise linear dynamical system

$$\mathcal{R}_\alpha(\vec{\mathcal{X}}) = \begin{cases} \mathcal{N}_B(V_{B_i}), & \alpha = i, & i = 1 \dots N_B; \\ \mathcal{N}_A(V_{A_j}), & \alpha = N_B + j, & j = 1 \dots N_A; \\ 0, & \alpha = N_B + N_A + k, & k = 1 \dots N_G. \end{cases}$$

$$\mathcal{N}_A(V) = \begin{cases} V - \theta_A, & \text{if } V_A > \theta_A; \\ 0, & \text{otherwise} \end{cases},$$

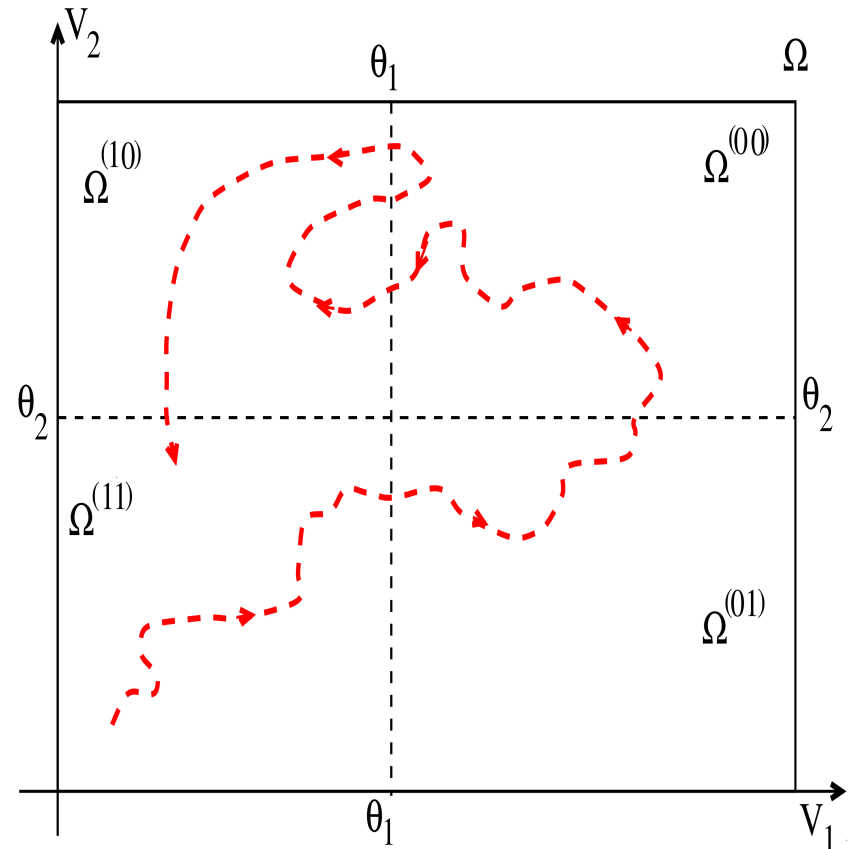

Dynamics of the 2D retina model

$$\frac{d\vec{\mathcal{X}}}{dt} = \mathcal{T}^{-1} \cdot \vec{\mathcal{X}} + \mathcal{W} \cdot \vec{\mathcal{R}}(\vec{\mathcal{X}}) + \vec{\mathcal{F}}(t).$$

Piecewise linear dynamical system

$$\mathcal{R}_\alpha(\vec{\mathcal{X}}) = \begin{cases} \mathcal{N}_B(V_{B_i}), & \alpha = i, & i = 1 \dots N_B; \\ \mathcal{N}_A(V_{A_j}), & \alpha = N_B + j, & j = 1 \dots N_A; \\ 0, & \alpha = N_B + N_A + k, & k = 1 \dots N_G. \end{cases}$$

$$\mathcal{N}_A(V) = \begin{cases} V - \theta_A, & \text{if } V_A > \theta_A; \\ 0, & \text{otherwise} \end{cases},$$

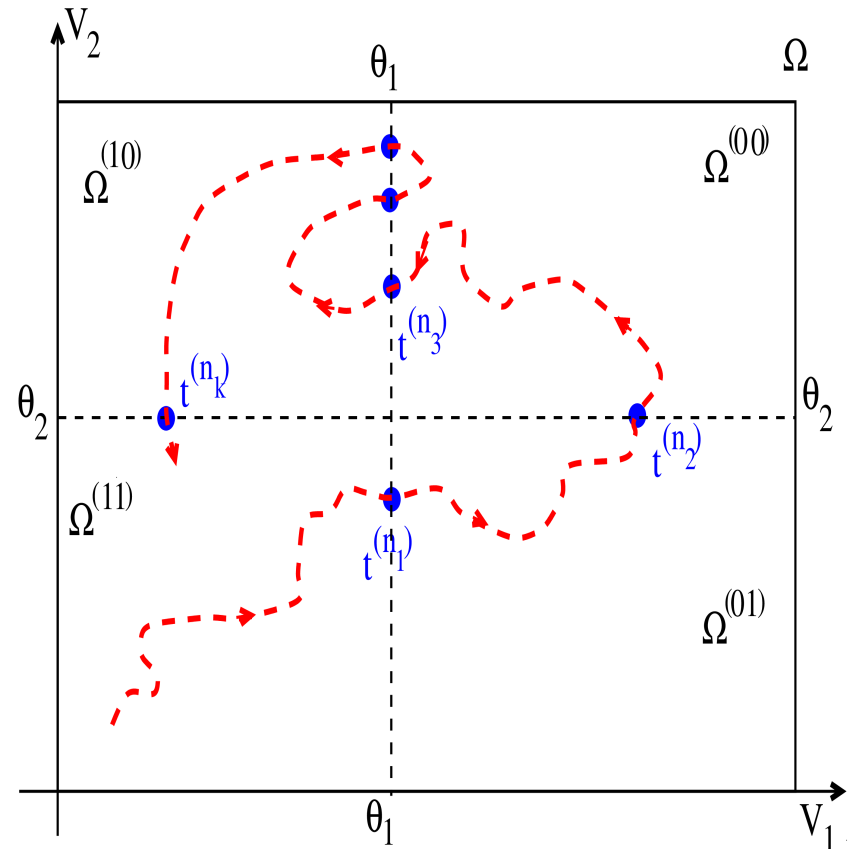

Dynamics of the 2D retina model

$$\frac{d\vec{\mathcal{X}}}{dt} = \mathcal{L}^{(n)} \cdot \vec{\mathcal{X}} + \vec{\mathcal{F}}^{(n)}(t), \quad \vec{\mathcal{X}} \in \Omega^{(n)}$$

Piecewise linear dynamical system

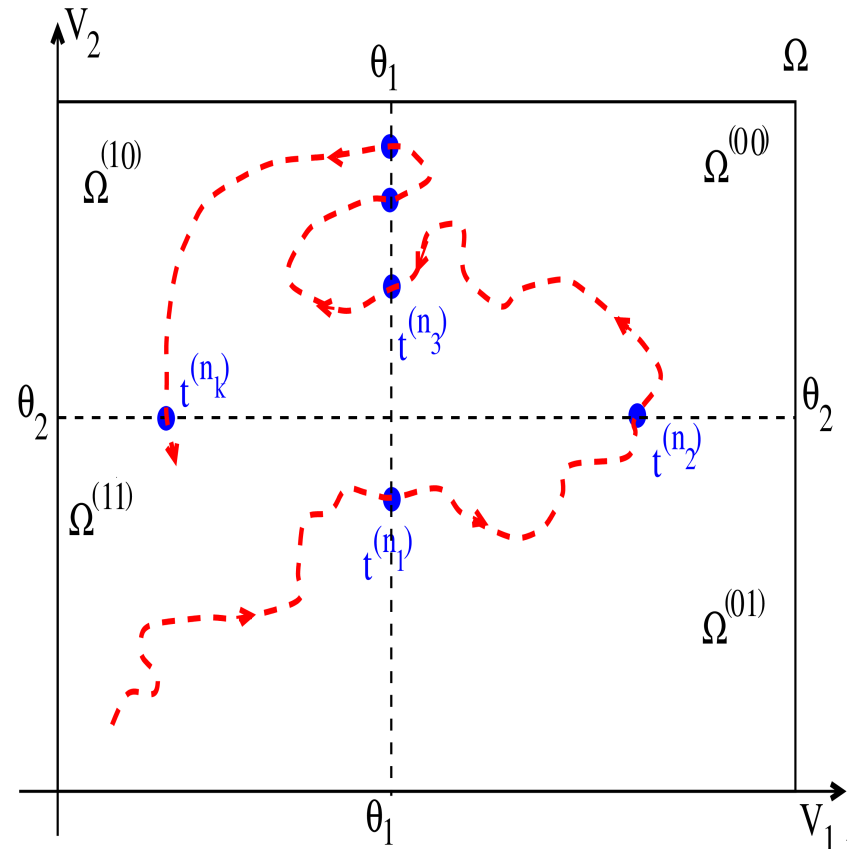

Dynamics of the 2D retina model

$$\frac{d\vec{\mathcal{X}}}{dt} = \mathcal{L}^{(n)} \cdot \vec{\mathcal{X}} + \vec{\mathcal{F}}^{(n)}(t), \quad \vec{\mathcal{X}} \in \Omega^{(n)}$$

Piecewise linear dynamical system

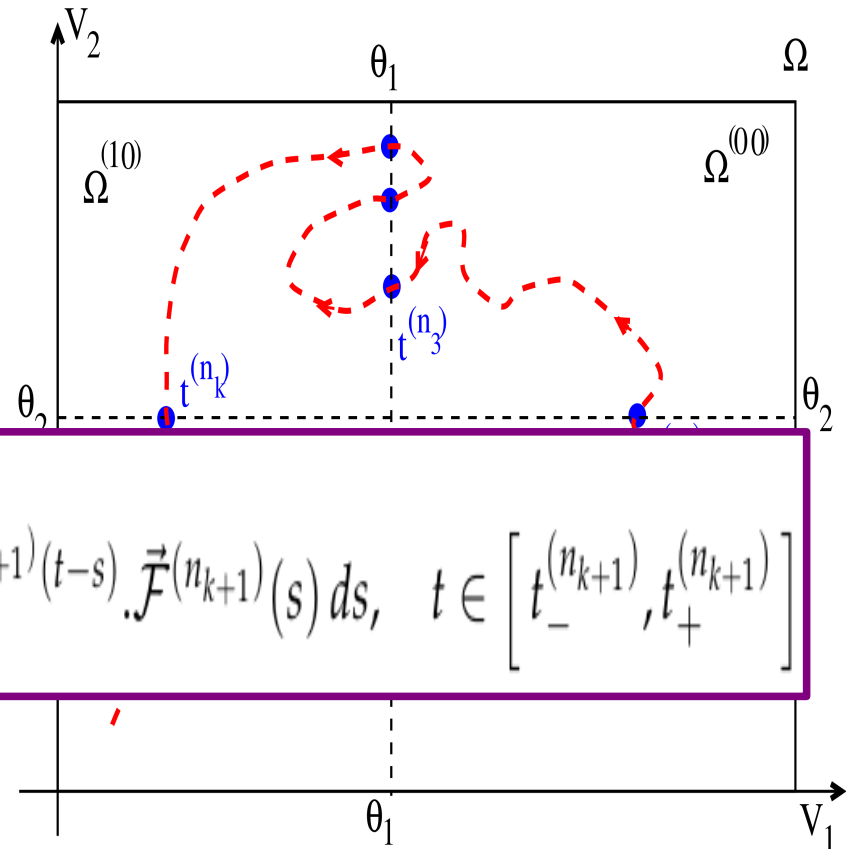

$$\vec{\mathcal{X}}(t) = e^{\mathcal{L}^{(n_{k+1})}(t-t_-^{(n_{k+1})})} \cdot \vec{\mathcal{X}}(t_-^{(n_{k+1})}) + \int_{t_-^{(n_{k+1})}}^t e^{\mathcal{L}^{(n_{k+1})}(t-s)} \cdot \vec{\mathcal{F}}^{(n_{k+1})}(s) ds, \quad t \in [t_-^{(n_{k+1})}, t_+^{(n_{k+1})}]$$

Dynamics of the 2D retina model

$$\frac{d\vec{\chi}}{dt} = \mathcal{L}^{(0)} \cdot \vec{\chi} + \vec{\mathcal{F}}^{(0)}(t), \quad \vec{\chi} \in \Omega^{(0)}$$

Non rectified dynamical system

We assume :

- 1) All eigenvalues are stable;
- 2) The rest state is in $\Omega^{(0)}$. We set it to 0.

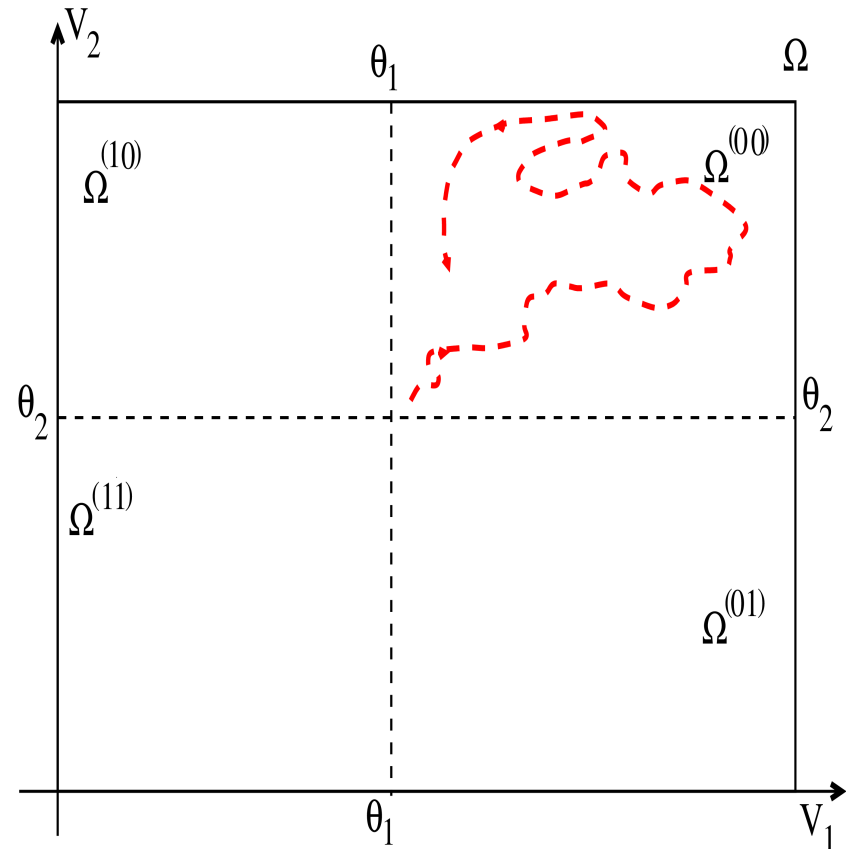

Dynamics of the 2D retina model

$$\frac{d\vec{\chi}}{dt} = \mathcal{L}^{(0)} \cdot \vec{\chi} + \vec{F}^{(0)}(t), \quad \vec{\chi} \in \Omega^{(0)}$$

Non rectified dynamical system

We assume :

- 1) All eigenvalues are stable;
- 2) The rest state is in $\Omega^{(0)}$. We set it to 0.

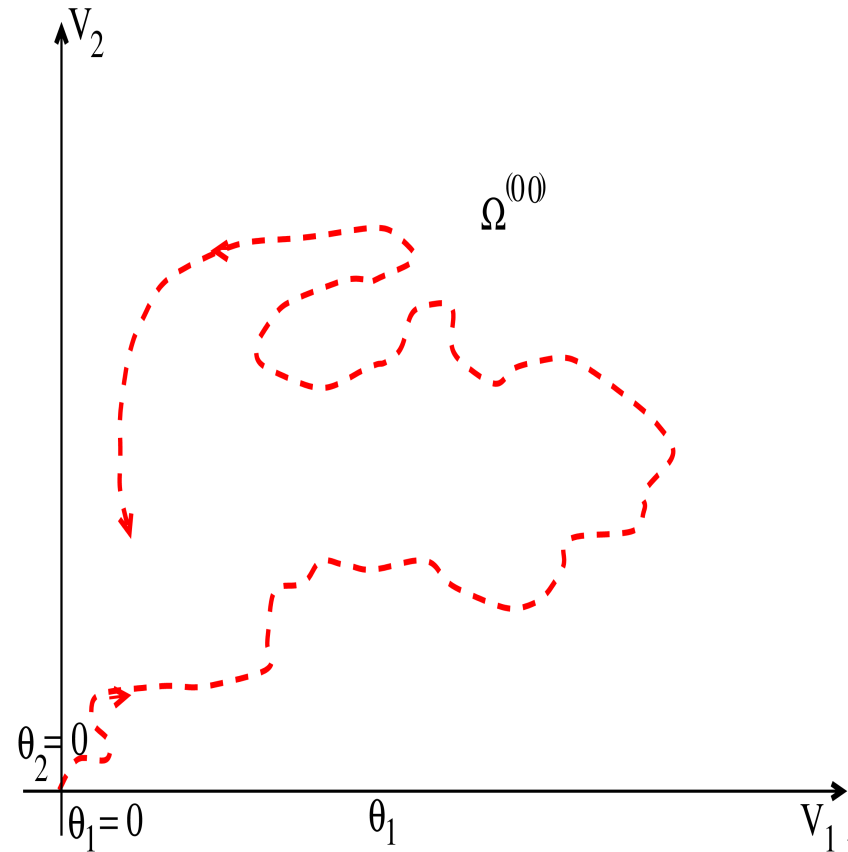

Dynamics of the 2D retina model

$$\frac{d\vec{\chi}}{dt} = \mathcal{L}^{(0)} \cdot \vec{\chi} + \vec{F}^{(0)}(t), \quad \vec{\chi} \in \Omega^{(0)}$$

Non rectified dynamical system

We assume :

- 1) All eigenvalues are stable;
- 2) The rest state is in $\Omega^{(0)}$. We set it to 0.

$$\vec{\chi}(t) = \left[e^{\mathcal{L}^{(0)} t} * \vec{F}_0 \right] (t)$$

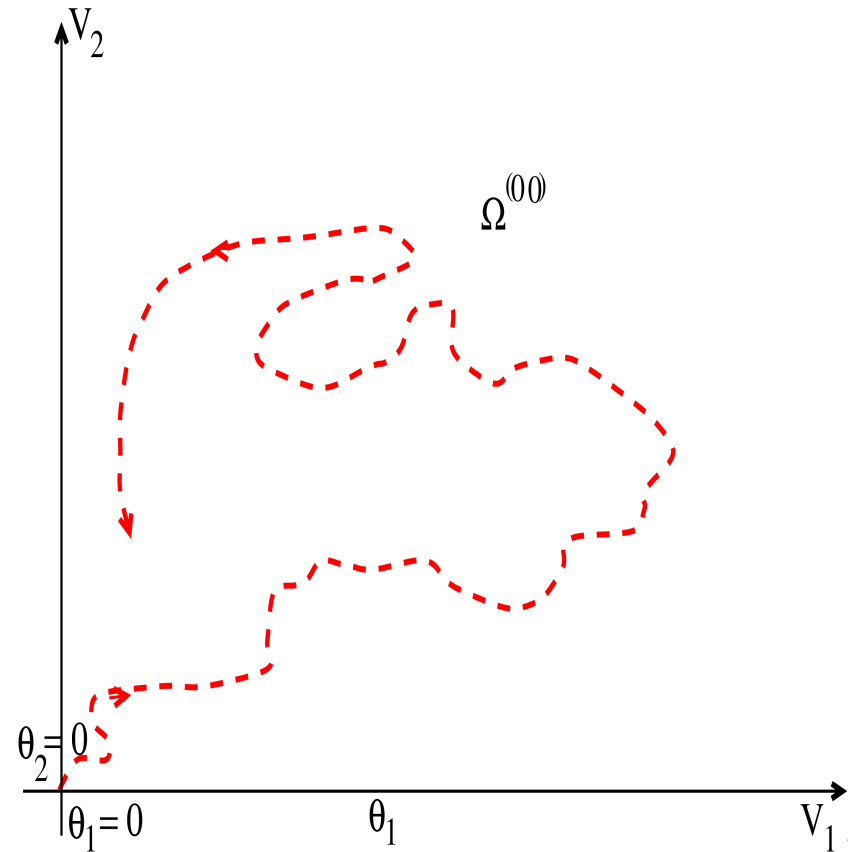

Dynamics of the 2D retina model

$$\frac{d\vec{\chi}}{dt} = \mathcal{L}^{(0)} \cdot \vec{\chi} + \vec{F}^{(0)}(t), \quad \vec{\chi} \in \Omega^{(0)}$$

The eigenvalues and eigenvectors of can be computed in some specific cases as well as conditions for stability.

S. Souihel, B. Cessac, Journal of Mathematical Neuroscience, BioMed Central, 2021, 11, (10.1186/s13408-020-00101-z)

B. Cessac, Journal of Imaging, 2022, Special Issue Mathematical Modeling of Human Vision and Its Application to Image Processing, 8 (1), pp.14. ([10.3390/jimaging8010014](https://doi.org/10.3390/jimaging8010014))

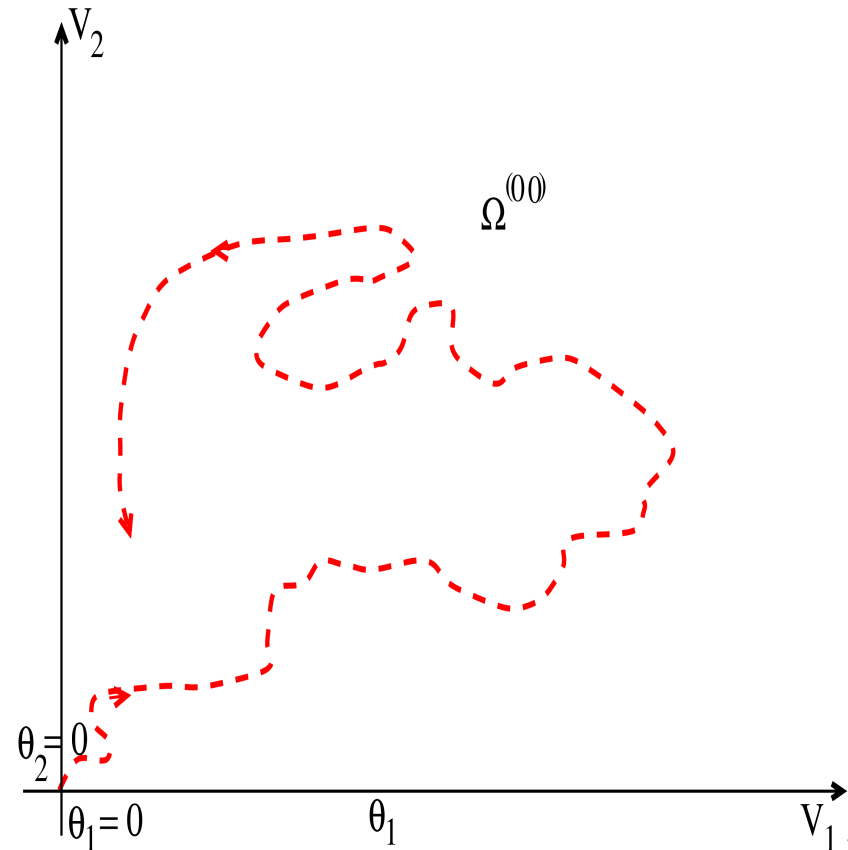

Stimulus correlations

$$\mathcal{S}(x, y, t) = \mathcal{S}_d(x, y, t) + \sigma_S \tilde{\zeta}(x, y, t)$$

$$V_{i_{drive}}(t) = \left[\mathcal{K}_{B_i} \begin{matrix} x, y, t \\ * \end{matrix} \mathcal{S} \right](t)$$

Stimulus correlations

$$\mathcal{S}(x, y, t) = \mathcal{S}_d(x, y, t) + \sigma_S \tilde{\zeta}(x, y, t)$$

$$V_{i_{drive}}(t) = \left[\mathcal{K}_{B_i} \begin{matrix} x, y, t \\ * \end{matrix} \mathcal{S} \right](t)$$

$$\mathbb{E}[V_{i_{drive}}(t)] = \left[\mathcal{K}_{B_i} \begin{matrix} x, y, t \\ * \end{matrix} \mathcal{S}_d \right](t)$$

Stimulus correlations

$$\mathcal{S}(x, y, t) = \mathcal{S}_d(x, y, t) + \sigma_S \tilde{\zeta}(x, y, t)$$

$$V_{i_{drive}}(t) = \left[\mathcal{K}_{B_i} \overset{x, y, t}{*} \mathcal{S} \right] (t)$$

$$\mathbb{E}[V_{i_{drive}}(t)] = \left[\mathcal{K}_{B_i} \overset{x, y, t}{*} \mathcal{S}_d \right] (t)$$

$$\begin{aligned} & \mathbb{E} \left[\left(V_{i_{drive}}(t) - \mathbb{E}[V_{i_{drive}}(t)] \right) \left(V_{j_{drive}}(t') - \mathbb{E}[V_{j_{drive}}(t')] \right) \right] \\ &= \sigma_S^2 \int_{x=-\infty}^{+\infty} \int_{y=-\infty}^{+\infty} \int_{s=-\infty}^t \mathcal{K}_{B_i}(x - x_i, y - y_i, t - s) \mathcal{K}_{B_j}(x - x_j, y - y_j, t' - s) dx dy ds \end{aligned}$$

Stimulus correlations

$$\mathcal{S}(x, y, t) = \mathcal{S}_d(x, y, t) + \sigma_S \tilde{\zeta}(x, y, t)$$

$$V_{i_{drive}}(t) = \left[\mathcal{K}_{B_i} \overset{x, y, t}{*} \mathcal{S} \right] (t)$$

$$\mathbb{E}[V_{i_{drive}}(t)] = \left[\mathcal{K}_{B_i} \overset{x, y, t}{*} \mathcal{S}_d \right] (t)$$

Drive correlations do not depend on the **stimulus**, only on the **receptive fields**, via the overlap of the spatial and temporal part.

$$\begin{aligned} & \mathbb{E} \left[\left(V_{i_{drive}}(t) - \mathbb{E}[V_{i_{drive}}(t)] \right) \left(V_{j_{drive}}(t') - \mathbb{E}[V_{j_{drive}}(t')] \right) \right] \\ &= \sigma_S^2 \int_{x=-\infty}^{+\infty} \int_{y=-\infty}^{+\infty} \int_{s=-\infty}^t \mathcal{K}_{B_i}(x - x_i, y - y_i, t - s) \mathcal{K}_{B_j}(x - x_j, y - y_j, t' - s) dx dy ds \end{aligned}$$

Stimulus correlations

$$\mathcal{S}(x, y, t) = \mathcal{S}_d(x, y, t) + \sigma_S \tilde{\zeta}(x, y, t)$$

$$V_{i_{drive}}(t) = \left[\mathcal{K}_{B_i} \begin{matrix} x, y, t \\ * \end{matrix} \mathcal{S} \right] (t)$$

$$\mathbb{E}[V_{i_{drive}}(t)] = \left[\mathcal{K}_{B_i} \begin{matrix} x, y, t \\ * \end{matrix} \mathcal{S}_d \right] (t)$$

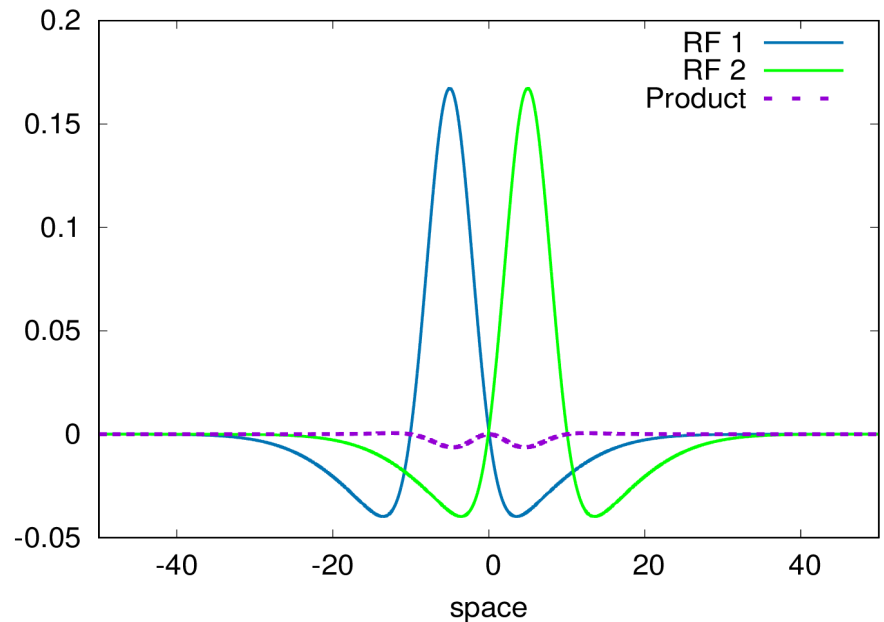

$$\mathbb{E} \left[\left(V_{i_{drive}}(t) - \mathbb{E}[V_{i_{drive}}(t)] \right) \left(V_{j_{drive}}(t') - \mathbb{E}[V_{j_{drive}}(t')] \right) \right]$$

$$= \sigma_S^2 \int_{x=-\infty}^{+\infty} \int_{y=-\infty}^{+\infty} \int_{s=-\infty}^t \mathcal{K}_{B_i}(x - x_i, y - y_i, t - s) \mathcal{K}_{B_j}(x - x_j, y - y_j, t' - s) dx dy ds$$

Stimulus correlations

$$\mathcal{S}(x, y, t) = \mathcal{S}_d(x, y, t) + \sigma_S \tilde{\zeta}(x, y, t)$$

$$V_{i_{drive}}(t) = \left[\mathcal{K}_{B_i} \overset{x, y, t}{*} \mathcal{S} \right] (t)$$

$$\mathbb{E}[V_{i_{drive}}(t)] = \left[\mathcal{K}_{B_i} \overset{x, y, t}{*} \mathcal{S}_d \right] (t)$$

Drive correlations do not depend on the **stimulus**, only on the **receptive fields**, via the overlap of the spatial and temporal part.

Lateral inhibition weakens these correlations.

$$\begin{aligned} & \mathbb{E} \left[\left(V_{i_{drive}}(t) - \mathbb{E}[V_{i_{drive}}(t)] \right) \left(V_{j_{drive}}(t') - \mathbb{E}[V_{j_{drive}}(t')] \right) \right] \\ &= \sigma_S^2 \int_{x=-\infty}^{+\infty} \int_{y=-\infty}^{+\infty} \int_{s=-\infty}^t \mathcal{K}_{B_i}(x - x_i, y - y_i, t - s) \mathcal{K}_{B_j}(x - x_j, y - y_j, t' - s) dx dy ds \end{aligned}$$

Voltage correlations

$$\frac{d\vec{\mathcal{X}}}{dt} = \mathcal{L}^{(0)} \cdot \vec{\mathcal{X}} + \vec{\mathcal{F}}^{(0)}(t), \quad \vec{\mathcal{X}} \in \Omega^{(0)}$$

$$\vec{\mathcal{X}}(t) = \left[e^{\mathcal{L}^{(0)} \cdot t} * \vec{\mathcal{F}}_0 \right](t)$$

$$\mathbb{E} \left[\vec{\mathcal{X}}(t) \right] = \left[e^{\mathcal{L}^{(0)} \cdot t} * \mathbb{E} \left[\vec{\mathcal{F}}^{(0)} \right] \right]$$

Voltage correlations

$$\frac{d\vec{\mathcal{X}}}{dt} = \mathcal{L}^{(0)} \cdot \vec{\mathcal{X}} + \vec{\mathcal{F}}^{(0)}(t), \quad \vec{\mathcal{X}} \in \Omega^{(0)}$$

$$\vec{\mathcal{X}}(t) = \left[e^{\mathcal{L}^{(0)} \cdot t} * \vec{\mathcal{F}}_0 \right](t)$$

$$\mathbb{E} \left[\vec{\mathcal{X}}(t) \right] = \left[e^{\mathcal{L}^{(0)} \cdot t} * \mathbb{E} \left[\vec{\mathcal{F}}^{(0)} \right] \right]$$

$$C_{\vec{\mathcal{X}}}(t, t') = \int_{s=-\infty}^t \int_{s'=-\infty}^{t'} e^{\mathcal{L}^{(0)}(t-s)} \cdot C_{\mathcal{F}}(s, s') \cdot e^{\tilde{\mathcal{L}}^{(0)}(t'-s')} ds ds'$$

Voltage correlations

$$\frac{d\vec{\mathcal{X}}}{dt} = \mathcal{L}^{(0)} \cdot \vec{\mathcal{X}} + \vec{\mathcal{F}}^{(0)}(t), \quad \vec{\mathcal{X}} \in \Omega^{(0)}$$

$$\vec{\mathcal{X}}(t) = \left[e^{\mathcal{L}^{(0)} \cdot t} * \vec{\mathcal{F}}_0 \right](t)$$

$$\mathbb{E} \left[\vec{\mathcal{X}}(t) \right] = \left[e^{\mathcal{L}^{(0)} \cdot t} * \mathbb{E} \left[\vec{\mathcal{F}}^{(0)} \right] \right]$$

1) $\mathcal{L}^{(0)}$ and $\tilde{\mathcal{L}}^{(0)}$ do not commute in general but they have the same spectrum ;

$$C_{\vec{\mathcal{X}}}(t, t') = \int_{s=-\infty}^t \int_{s'=-\infty}^{t'} e^{\mathcal{L}^{(0)}(t-s)} \cdot C_{\mathcal{F}}(s, s') \cdot e^{\tilde{\mathcal{L}}^{(0)}(t'-s')} ds ds'$$

Voltage correlations

$$\frac{d\vec{\mathcal{X}}}{dt} = \mathcal{L}^{(0)} \cdot \vec{\mathcal{X}} + \vec{\mathcal{F}}^{(0)}(t), \quad \vec{\mathcal{X}} \in \Omega^{(0)}$$

$$\vec{\mathcal{X}}(t) = \left[e^{\mathcal{L}^{(0)} t} * \vec{\mathcal{F}}_0 \right](t)$$

$$\mathbb{E}[\vec{\mathcal{X}}(t)] = \left[e^{\mathcal{L}^{(0)} t} * \mathbb{E}[\vec{\mathcal{F}}^{(0)}] \right]$$

- 1) $\mathcal{L}^{(0)}$ and $\tilde{\mathcal{L}}^{(0)}$ do not commute in general but they have the same spectrum ;
- 2) Voltages correlations are due to :

I. Stimuli correlations ;

$$C_{\vec{\mathcal{X}}}(t, t') = \int_{s=-\infty}^t \int_{s'=-\infty}^{t'} e^{\mathcal{L}^{(0)}(t-s)} C_{\mathcal{F}}(s, s') e^{\tilde{\mathcal{L}}^{(0)}(t'-s')} ds ds'$$

Voltage correlations

$$\frac{d\vec{\mathcal{X}}}{dt} = \mathcal{L}^{(0)} \cdot \vec{\mathcal{X}} + \vec{\mathcal{F}}^{(0)}(t), \quad \vec{\mathcal{X}} \in \Omega^{(0)}$$

$$\vec{\mathcal{X}}(t) = \left[e^{\mathcal{L}^{(0)} t} * \vec{\mathcal{F}}_0 \right](t)$$

$$\mathbb{E}[\vec{\mathcal{X}}(t)] = \left[e^{\mathcal{L}^{(0)} t} * \mathbb{E}[\vec{\mathcal{F}}^{(0)}] \right]$$

1) $\mathcal{L}^{(0)}$ and $\tilde{\mathcal{L}}^{(0)}$ do not commute in general but they have the same spectrum ;

2) Voltages correlations are due to :

I. Stimuli correlations ;

II. **Network effects** (mixture of exponentials decaying in time) ;

$$C_{\vec{\mathcal{X}}}(t, t') = \int_{s=-\infty}^t \int_{s'=-\infty}^{t'} e^{\mathcal{L}^{(0)}(t-s)} \cdot C_{\mathcal{F}}(s, s') \cdot e^{\tilde{\mathcal{L}}^{(0)}(t'-s')} ds ds'$$

Voltage correlations

$$\frac{d\vec{\mathcal{X}}}{dt} = \mathcal{L}^{(0)} \cdot \vec{\mathcal{X}} + \vec{\mathcal{F}}^{(0)}(t), \quad \vec{\mathcal{X}} \in \Omega^{(0)}$$

$$\vec{\mathcal{X}}(t) = \left[e^{\mathcal{L}^{(0)} \cdot t} * \vec{\mathcal{F}}_0 \right](t)$$

$$\mathbb{E} \left[\vec{\mathcal{X}}(t) \right] = \left[e^{\mathcal{L}^{(0)} \cdot t} * \mathbb{E} \left[\vec{\mathcal{F}}^{(0)} \right] \right]$$

1) $\mathcal{L}^{(0)}$ and $\tilde{\mathcal{L}}^{(0)}$ do not commute in general but they have the same spectrum ;

2) Voltages correlations are due to :

I. Stimuli correlations ;

II. Network effects (mixture of exponentials decaying in time) ;

III. For a **moving object** correlations propagate with the stimulus in a **wave like-form** with a network contribution.

$$C_{\vec{\mathcal{X}}}(t, t') = \int_{s=-\infty}^t \int_{s'=-\infty}^{t'} e^{\mathcal{L}^{(0)}(t-s)} \cdot C_{\mathcal{F}}(s, s') \cdot e^{\tilde{\mathcal{L}}^{(0)}(t'-s')} ds ds'$$

Motion anticipation

Souihel S., Cessac B., “On the potential role of lateral connectivity in retinal anticipation”, Journal of Mathematical Neuroscience, BioMed Central, 2021, 11, {10.1186/s13408-020-00101-z}

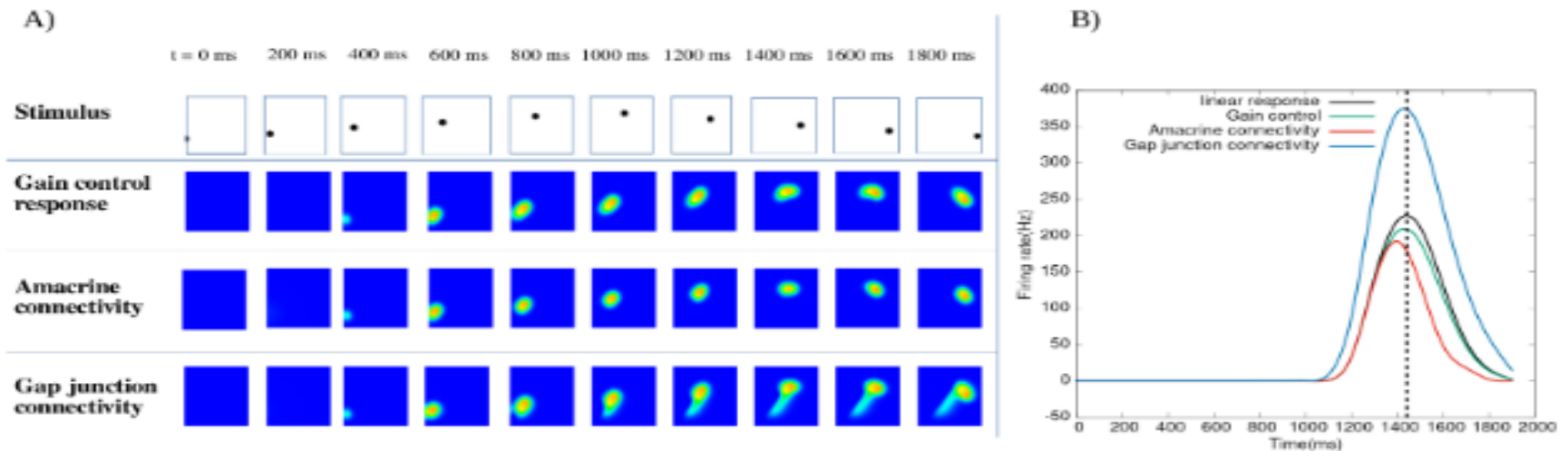

Figure 15: **Effect of anticipatory mechanisms on a parabolic trajectory.** A) Response to a dot moving along a parabolic trajectory. The first line shows the stimulus, the second line shows the GCells response with gain control, the third line presents the effect of lateral ACells connectivity with $w = 0.3 \text{ ms}^{-1}$, and the last line shows the effect of asymmetric gap junctions with $v_{gap} = 9 \text{ mm/s}$. B) Time course response of a cell responding to the dot near the trajectory turning point. Linear response corresponds to the response to the stimulus without gain control.

Spike correlations

$$\frac{d\vec{\chi}}{dt} = \mathcal{L}^{(0)} \cdot \vec{\chi} + \vec{\mathcal{F}}^{(0)}(t), \quad \vec{\chi} \in \Omega^{(0)}$$

$$\mathcal{N}_G(V_{G_k}) = f\left(\frac{V_{G_k}(t) - \theta_G}{\sigma_G}\right) = \frac{1}{\sqrt{2\pi}} \int_{-\infty}^{\frac{V_{G_k} - \theta_G}{\sigma_G}} e^{-\frac{x^2}{2}} dx$$

Spike correlations

$$\frac{d\vec{\mathcal{X}}}{dt} = \mathcal{L}^{(0)} \cdot \vec{\mathcal{X}} + \vec{\mathcal{F}}^{(0)}(t), \quad \vec{\mathcal{X}} \in \Omega^{(0)}$$

$$\mathcal{N}_G(V_{G_k}) = f\left(\frac{V_{G_k}(t) - \theta_G}{\sigma_G}\right) = \frac{1}{\sqrt{2\pi}} \int_{-\infty}^{\frac{V_{G_k} - \theta_G}{\sigma_G}} e^{-\frac{x^2}{2}} dx$$

$$\nu_{\alpha_1}(t_1) \equiv \mathbb{E}\left[f\left(\frac{V_{G_{\alpha_1}}(t_1) - \theta_G}{\sigma_G}\right)\right] = f\left(\frac{m_{\alpha_1}(t_1) - \theta_G}{\sqrt{\sigma_G^2 + \sigma_{\alpha_1}^2}}\right)$$

Spike correlations

$$\frac{d\vec{\mathcal{X}}}{dt} = \mathcal{L}^{(0)} \cdot \vec{\mathcal{X}} + \vec{\mathcal{F}}^{(0)}(t), \quad \vec{\mathcal{X}} \in \Omega^{(0)}$$

$$\mathcal{N}_G(V_{G_k}) = f\left(\frac{V_{G_k}(t) - \theta_G}{\sigma_G}\right) = \frac{1}{\sqrt{2\pi}} \int_{-\infty}^{\frac{V_{G_k} - \theta_G}{\sigma_G}} e^{-\frac{x^2}{2}} dx$$

$$\nu_{\alpha_1}(t_1) \equiv \mathbb{E}\left[f\left(\frac{V_{G_{\alpha_1}}(t_1) - \theta_G}{\sigma_G}\right)\right] = f\left(\frac{m_{\alpha_1}(t_1) - \theta_G}{\sqrt{\sigma_G^2 + \sigma_{\alpha_1}^2}}\right)$$

$$\nu_{\alpha_1\alpha_2}(t_1, t_2) \equiv \mathbb{E}\left[f\left(\frac{V_{G_{\alpha_1}}(t_1) - \theta_G}{\sigma_G}\right) f\left(\frac{V_{G_{\alpha_2}}(t_2) - \theta_G}{\sigma_G}\right)\right]$$

Spike correlations

$$\frac{d\vec{\mathcal{X}}}{dt} = \mathcal{L}^{(0)} \cdot \vec{\mathcal{X}} + \vec{\mathcal{F}}^{(0)}(t), \quad \vec{\mathcal{X}} \in \Omega^{(0)}$$

$$\mathcal{N}_G(V_{G_k}) = f\left(\frac{V_{G_k}(t) - \theta_G}{\sigma_G}\right) = \frac{1}{\sqrt{2\pi}} \int_{-\infty}^{\frac{V_{G_k} - \theta_G}{\sigma_G}} e^{-\frac{x^2}{2}} dx$$

$$\nu_{\alpha_1}(t_1) \equiv \mathbb{E}\left[f\left(\frac{V_{G_{\alpha_1}}(t_1) - \theta_G}{\sigma_G}\right)\right] = f\left(\frac{m_{\alpha_1}(t_1) - \theta_G}{\sqrt{\sigma_G^2 + \sigma_{\alpha_1}^2}}\right)$$

$$\nu_{\alpha_1\alpha_2}(t_1, t_2) \equiv \mathbb{E}\left[f\left(\frac{V_{G_{\alpha_1}}(t_1) - \theta_G}{\sigma_G}\right) f\left(\frac{V_{G_{\alpha_2}}(t_2) - \theta_G}{\sigma_G}\right)\right]$$

$$\nu_{\alpha_1\alpha_2\dots\alpha_k}(t_1, t_2, \dots, t_k) \equiv \mathbb{E}\left[f\left(\frac{V_{G_{\alpha_1}}(t_1) - \theta_G}{\sigma_G}\right) f\left(\frac{V_{G_{\alpha_2}}(t_2) - \theta_G}{\sigma_G}\right) \dots f\left(\frac{V_{G_{\alpha_k}}(t_k) - \theta_G}{\sigma_G}\right)\right]$$

Spike correlations

$$\frac{d\vec{\mathcal{X}}}{dt} = \mathcal{L}^{(0)} \cdot \vec{\mathcal{X}} + \vec{\mathcal{F}}^{(0)}(t), \quad \vec{\mathcal{X}} \in \Omega^{(0)}$$

$$\mathcal{N}_G(V_{G_k}) = f\left(\frac{V_{G_k}(t) - \theta_G}{\sigma_G}\right) = \frac{1}{\sqrt{2\pi}} \int_{-\infty}^{\frac{V_{G_k} - \theta_G}{\sigma_G}} e^{-\frac{x^2}{2}} dx$$

$$\nu_{\alpha_1}(t_1) \equiv \mathbb{E}\left[f\left(\frac{V_{G_{\alpha_1}}(t_1) - \theta_G}{\sigma_G}\right)\right] = f\left(\frac{m_{\alpha_1}(t_1) - \theta_G}{\sqrt{\sigma_G^2 + \sigma_{\alpha_1}^2}}\right)$$

$$\nu_{\alpha_1\alpha_2}(t_1, t_2) \equiv \mathbb{E}\left[f\left(\frac{V_{G_{\alpha_1}}(t_1) - \theta_G}{\sigma_G}\right) f\left(\frac{V_{G_{\alpha_2}}(t_2) - \theta_G}{\sigma_G}\right)\right]$$

$$\nu_{\alpha_1\alpha_2\dots\alpha_k}(t_1, t_2, \dots, t_k) \equiv \mathbb{E}\left[f\left(\frac{V_{G_{\alpha_1}}(t_1) - \theta_G}{\sigma_G}\right) f\left(\frac{V_{G_{\alpha_2}}(t_2) - \theta_G}{\sigma_G}\right) \dots f\left(\frac{V_{G_{\alpha_k}}(t_k) - \theta_G}{\sigma_G}\right)\right]$$

I. High order correlations can be computed (X is **Gaussian**).

Spike correlations

$$\frac{d\vec{\mathcal{X}}}{dt} = \mathcal{L}^{(0)} \cdot \vec{\mathcal{X}} + \vec{\mathcal{F}}^{(0)}(t), \quad \vec{\mathcal{X}} \in \Omega^{(0)}$$

$$\mathcal{N}_G(V_{G_k}) = f\left(\frac{V_{G_k}(t) - \theta_G}{\sigma_G}\right) = \frac{1}{\sqrt{2\pi}} \int_{-\infty}^{\frac{V_{G_k} - \theta_G}{\sigma_G}} e^{-\frac{x^2}{2}} dx$$

$$\nu_{\alpha_1}(t_1) \equiv \mathbb{E}\left[f\left(\frac{V_{G_{\alpha_1}}(t_1) - \theta_G}{\sigma_G}\right)\right] = f\left(\frac{m_{\alpha_1}(t_1) - \theta_G}{\sqrt{\sigma_G^2 + \sigma_{\alpha_1}^2}}\right)$$

$$\nu_{\alpha_1\alpha_2}(t_1, t_2) \equiv \mathbb{E}\left[f\left(\frac{V_{G_{\alpha_1}}(t_1) - \theta_G}{\sigma_G}\right) f\left(\frac{V_{G_{\alpha_2}}(t_2) - \theta_G}{\sigma_G}\right)\right]$$

$$\nu_{\alpha_1\alpha_2\dots\alpha_k}(t_1, t_2, \dots, t_k) \equiv \mathbb{E}\left[f\left(\frac{V_{G_{\alpha_1}}(t_1) - \theta_G}{\sigma_G}\right) f\left(\frac{V_{G_{\alpha_2}}(t_2) - \theta_G}{\sigma_G}\right) \dots f\left(\frac{V_{G_{\alpha_k}}(t_k) - \theta_G}{\sigma_G}\right)\right]$$

I. High order correlations can be computed (X is **Gaussian**).

II. They depend on **stimulus correlations** and **network induced correlations** in an explicit way.

Spike correlations

$$\frac{d\vec{\mathcal{X}}}{dt} = \mathcal{L}^{(0)} \cdot \vec{\mathcal{X}} + \vec{\mathcal{F}}^{(0)}(t), \quad \vec{\mathcal{X}} \in \Omega^{(0)}$$

$$\mathcal{N}_G(V_{G_k}) = f\left(\frac{V_{G_k}(t) - \theta_G}{\sigma_G}\right) = \frac{1}{\sqrt{2\pi}} \int_{-\infty}^{\frac{V_{G_k} - \theta_G}{\sigma_G}} e^{-\frac{x^2}{2}} dx$$

$$\nu_{\alpha_1}(t_1) \equiv \mathbb{E}\left[f\left(\frac{V_{G_{\alpha_1}}(t_1) - \theta_G}{\sigma_G}\right)\right] = f\left(\frac{m_{\alpha_1}(t_1) - \theta_G}{\sqrt{\sigma_G^2 + \sigma_{\alpha_1}^2}}\right)$$

$$\nu_{\alpha_1\alpha_2}(t_1, t_2) \equiv \mathbb{E}\left[f\left(\frac{V_{G_{\alpha_1}}(t_1) - \theta_G}{\sigma_G}\right) f\left(\frac{V_{G_{\alpha_2}}(t_2) - \theta_G}{\sigma_G}\right)\right]$$

$$\nu_{\alpha_1\alpha_2\dots\alpha_k}(t_1, t_2, \dots, t_k) \equiv \mathbb{E}\left[f\left(\frac{V_{G_{\alpha_1}}(t_1) - \theta_G}{\sigma_G}\right) f\left(\frac{V_{G_{\alpha_2}}(t_2) - \theta_G}{\sigma_G}\right) \dots f\left(\frac{V_{G_{\alpha_k}}(t_k) - \theta_G}{\sigma_G}\right)\right]$$

- I. High order correlations can be computed (X is **Gaussian**).
- II. They depend on **stimulus correlations** and **network induced correlations** in an explicit way.
- III. A **moving object** induces non stationary **spatio-temporal** spike correlations.

The role of rectification

$$\frac{d\vec{\mathcal{X}}}{dt} = \mathcal{L}^{(n)} \cdot \vec{\mathcal{X}} + \vec{\mathcal{F}}^{(n)}(t), \quad \vec{\mathcal{X}} \in \Omega^{(n)}$$

Piecewise linear dynamical system

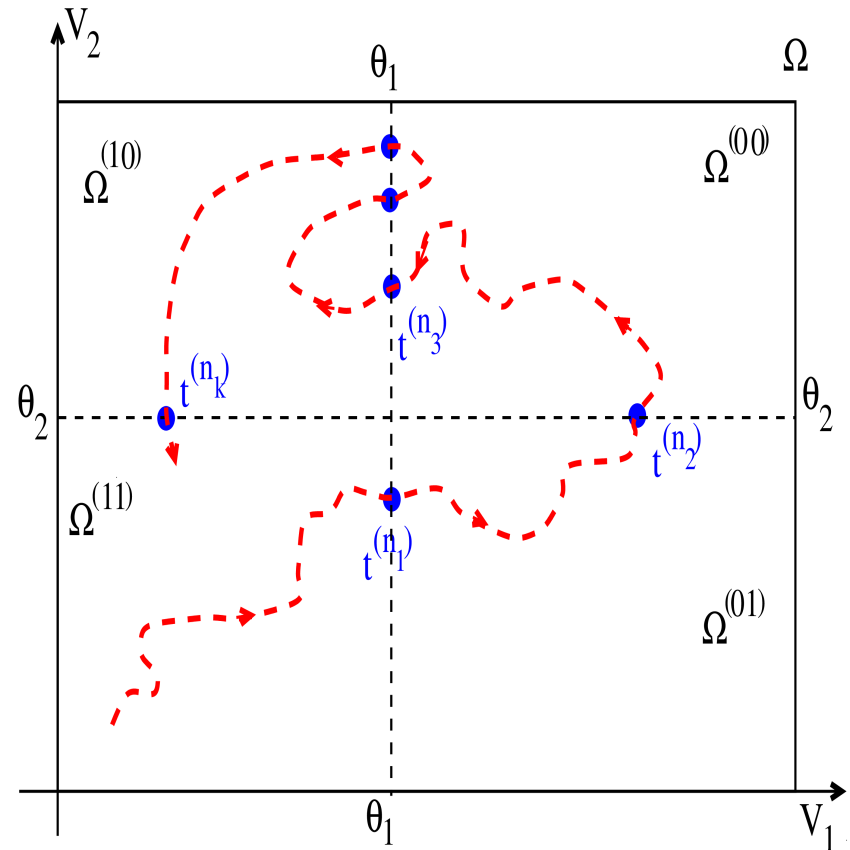

The role of rectification

$$\frac{d\vec{\chi}}{dt} = \mathcal{L}^{(n)} \cdot \vec{\chi} + \vec{F}^{(n)}(t), \quad \vec{\chi} \in \Omega^{(n)}$$

Piecewise linear dynamical system

- I. Rectification generates **null eigenvalues** that actually prevent **exponential instability** ;
- II. In the deterministic case **times of exit** from continuity domains can be explicitly computed. They **depend on the stimulus** ;

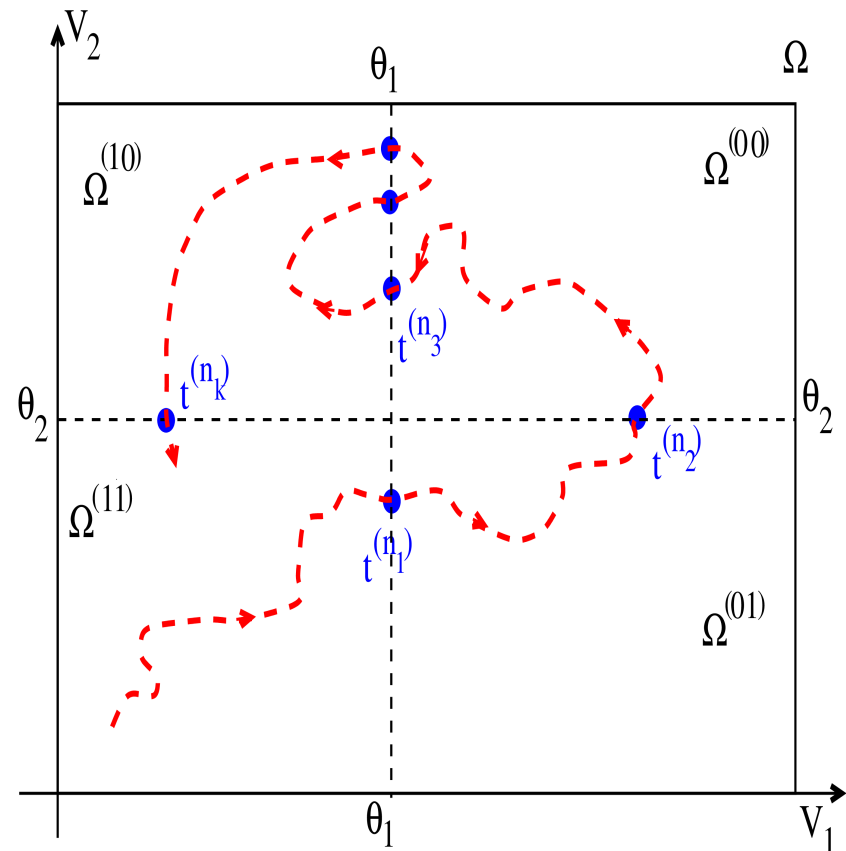

The role of rectification

$$\frac{d\vec{\mathcal{X}}}{dt} = \mathcal{L}^{(n)} \cdot \vec{\mathcal{X}} + \vec{\mathcal{F}}^{(n)}(t), \quad \vec{\mathcal{X}} \in \Omega^{(n)}$$

Piecewise linear **stochastic** system

- I. Rectification generates **null eigenvalues** that actually prevent **exponential instability** ;
- II. In the deterministic case **times of exit** from continuity domains can be explicitly computed. They **depend on the stimulus** ;
- III. In the stochastic case these times become **random**.

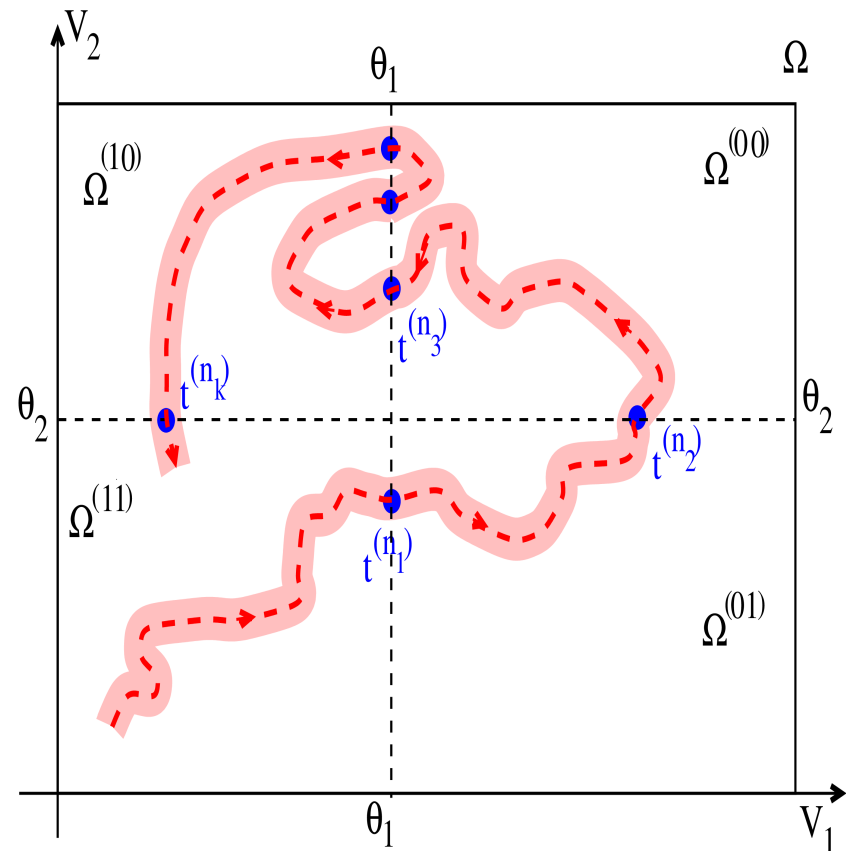

The role of rectification

Questions to mathematicians

Can we compute, in this setting :

The law of the exit times (say for a bar moving with a constant speed) ?

The voltages correlations (are they still Gaussian ?)

The spike correlations ?

$$\frac{d\vec{\chi}}{dt} =$$

Piece

$$\vec{\chi}(t) = e^{\mathcal{L}t}$$

II. In the de
cont
compute

III. In the stochastic case these times become **random**.

Ω
ns to mathe
 $\Omega^{(0)}$

$$t_{+}^{(n_{k+1})}, t_{+}^{(n_{k+1})}]$$

$\Omega^{(0)}$

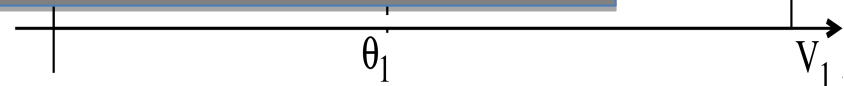

Partial conclusion

I. Spatio-temporal spike correlations.

1. What could be the **spatio-temporal distribution of spikes** emitted from the retina to the LGN-cortex, considering that inputs are *non stationary* (moving objects) ?
2. What could be the *non stationary structure of spatio-temporal correlations* ?
3. In particular is it possible to disentangle the effects of:
 - i. **Stimulus** induced correlations;
 - ii. **Network** induced correlations ;
 - iii. **Non linearities**.

Partial conclusion

I. *Spatio-temporal spike correlations.*

1. What could be the **spatio-temporal distribution of spikes** emitted from the retina to the LGN-cortex, considering that inputs are *non stationary* (moving objects) ?
2. What could be the *non stationary structure of spatio-temporal correlations* ?
3. In particular is it possible to disentangle the effects of:
 - i. **Stimulus** induced correlations;
 - ii. **Network** induced correlations ;
 - iii. **Non linearities**.

In this model,

1. **Lateral inhibition decorrelates** the stimulus input;
2. **Voltage correlations** are integrating stimulus **correlations/ network/rectification** effects in a way that can be mathematically analysed;
3. A **moving object** generates a **wave of activity** which also impacts **spatio-temporal spike correlations**;
4. **Rectification/Gain control** have a strong impact on these correlations (*some cell become suddenly silent*).

Questions

In this model,

1. **Lateral inhibition decorrelates** the stimulus input;
2. **Voltage correlations** are integrating stimulus **correlations/ network/rectification** effects in a way that can be mathematically analysed;
3. A **moving object** generates a **wave of activity** which also impacts **spatio-temporal spike correlations**;
4. **Rectification/Gain control** have a strong impact on these correlations (*some cell become suddenly silent*).

II. Cortical model

1. Which **mechanism/principle** is used to decipher "at best" the trajectory of a moving object from the retinal spike trains ?
 - i. Firing rates ?
 - ii. Individual spikes ?
 - iii. Both ?
2. What could be the implications of questions/answers in item I with respect to the theory of **efficient coding** ?

Spike response to correlated inputs

The visual system

Retina's layered structure

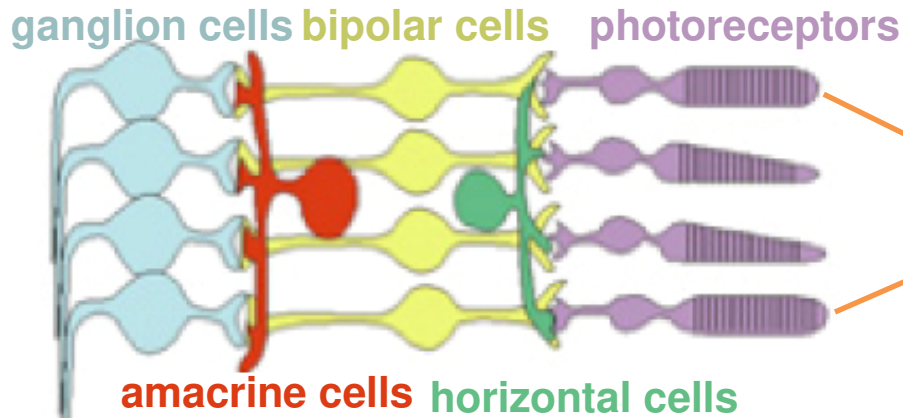

Light

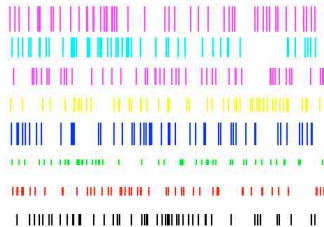
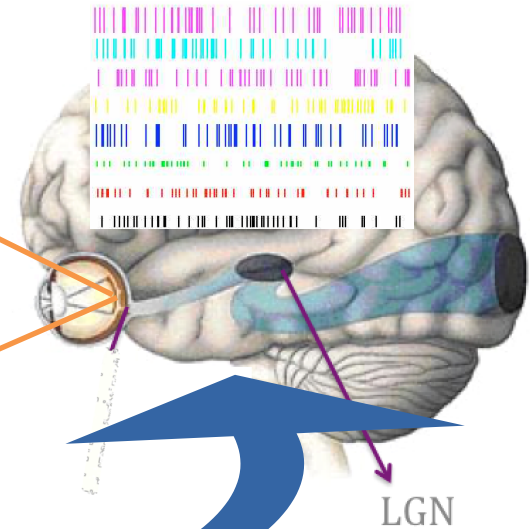

The cortex has no clue of what is happening in the retina. It only receives spikes and has to extract all the visual information from them.

The visual system

Retina's layered structure

ganglion cells bipolar cells photoreceptors

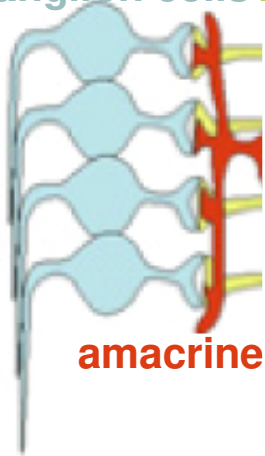

Which cortical model ?

Firing rates ?

Individual spikes ?

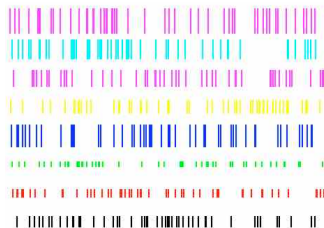
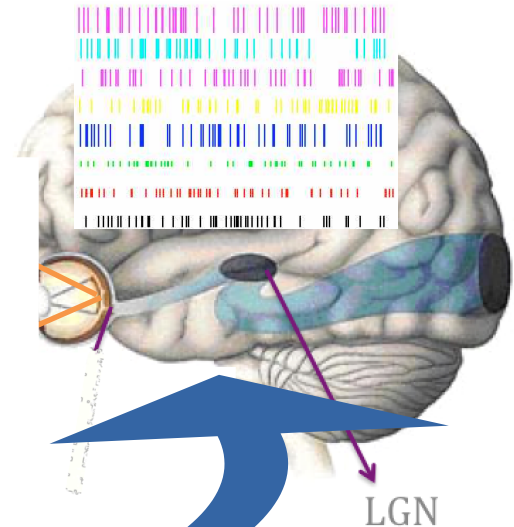

A mean field model to reproduce VSDI recordings

Zerlaut et al 2016
Chemla et al 2018
Souihel, 2019 (PhD)

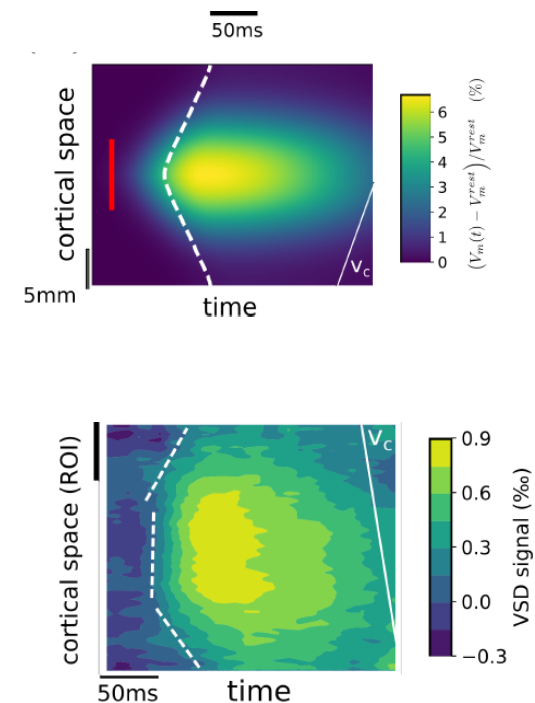
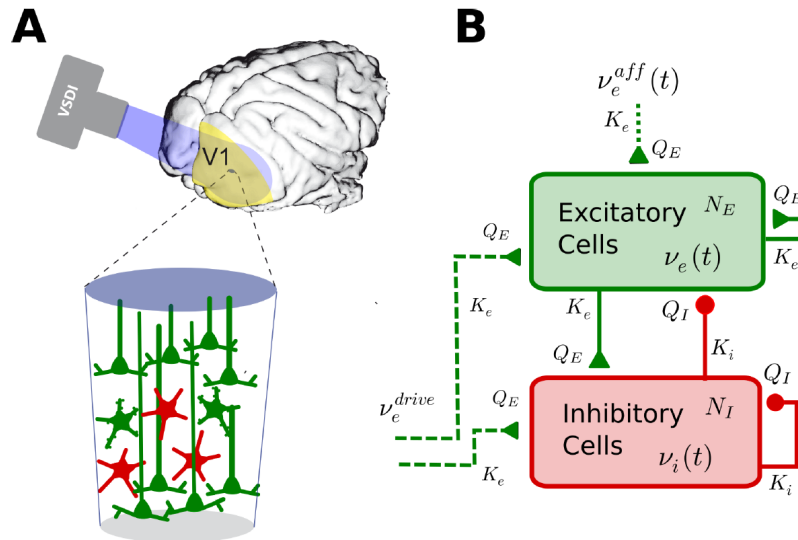

A spiking model

B. Cessac, Viéville T., “On Dynamics of Integrate-and-Fire Neural Networks with Adaptive Conductances.”, *Front. Comput. Neurosci.* (2008) 2:2.

R. Cofré and B. Cessac « Dynamics and spike trains statistics in conductance-based Integrate-and-Fire neural networks with chemical and electric synapses », *Chaos, Solitons & Fractals*, Volume 50, May 2013, Pages 13-31.

B. Cessac and R. Cofré, « Spike train statistics and Gibbs distributions », *J. Physiol. Paris*, Volume 107, Issue 5, Pages 360-368 (November 2013). Special issue: Neural Coding and Natural Image Statistics.

B. Cessac, I. Ampuero, R. Cofre, « Linear response for spiking neuronal networks with unbounded memory ». *Entropy*, MDPI, 2021, 23 (2), pp.155. (10.3390/e23020155)

A conductance-based Integrate and Fire model

Sub-threshold dynamics:

$$C_k \frac{dV_k}{dt} + g_k(t, \omega) V_k = i_k(t, \omega).$$

- Linear in V .
- Spike history-dependent.

Dynamics integration

$$\Gamma_k(t_1, t, \omega) = e^{-\frac{1}{C_k} \int_{t_1}^t V_{\tau_k}(t, \omega) g_k(u, \omega) du}$$

$$V_k(t, \omega) = \underbrace{V_k^{(sp)}(t, \omega) + V_k^{(S)}(t, \omega)}_{V_k^{(det)}(t, \omega)} + V_k^{(noise)}(t, \omega)$$

$$V_k^{(sp)}(t, \omega) = V_k^{(syn)}(t, \omega) + V_k^{(L)}(t, \omega),$$

$$V_k^{(syn)}(t, \omega) = \frac{1}{C_k} \sum_{j=1}^N W_{kj} \int_{\tau_k(t, \omega)}^t \Gamma_k(t_1, t, \omega) \alpha_{kj}(t_1, \omega) dt_1$$

Spontaneous spiking activity

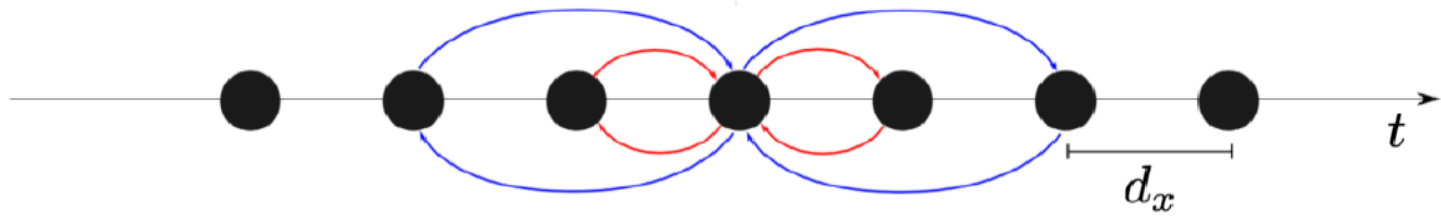

Spontaneous spiking activity

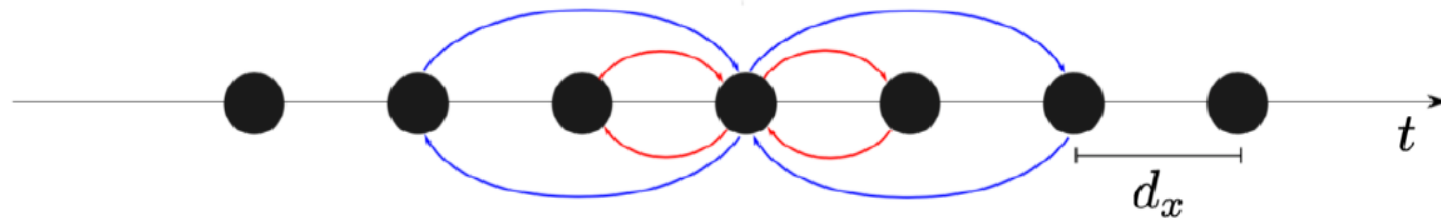

Spontaneous spiking activity

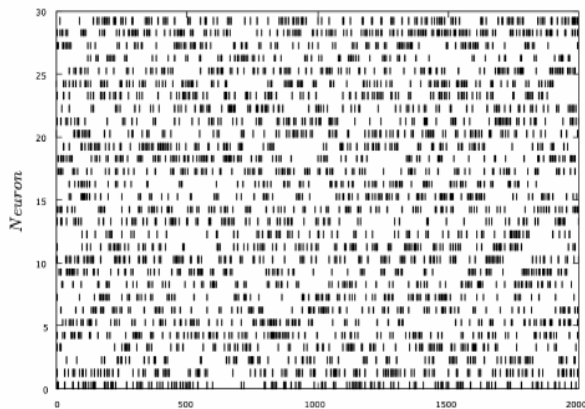
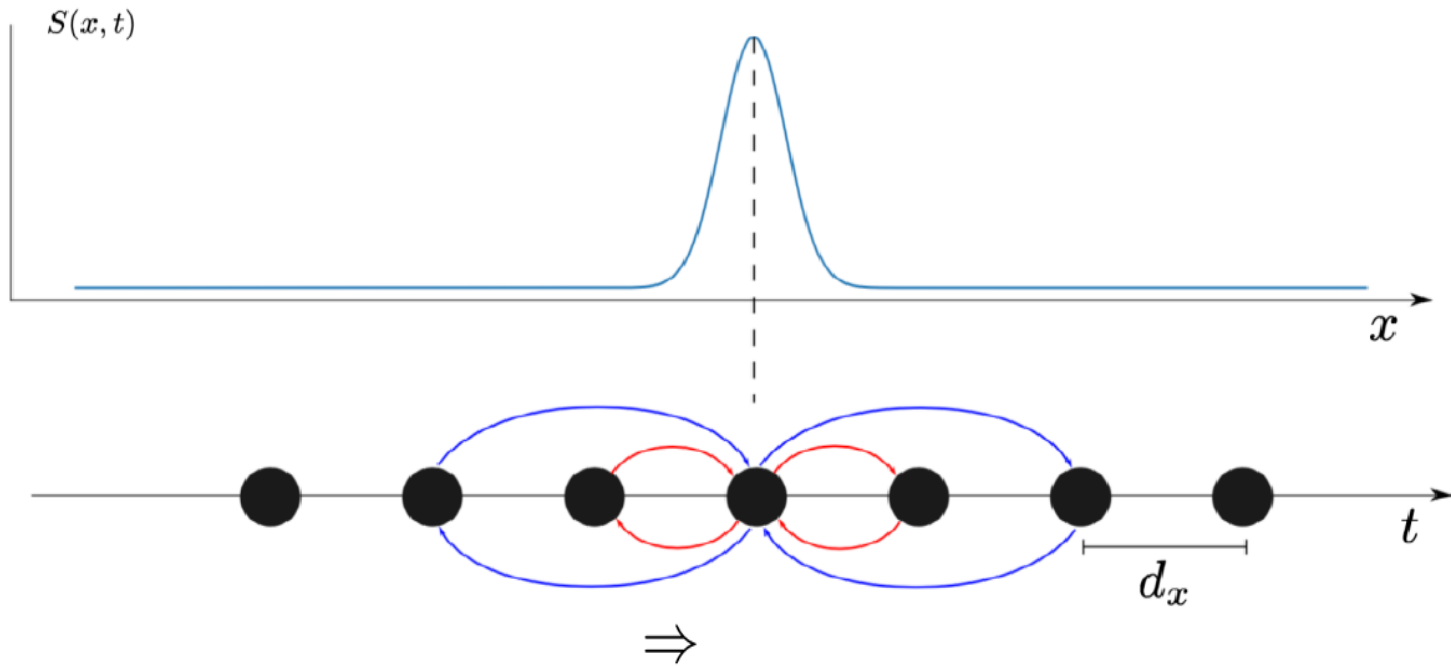

Spontaneous spiking activity

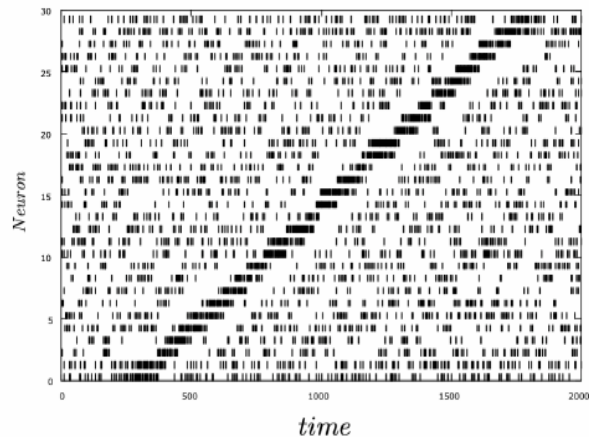
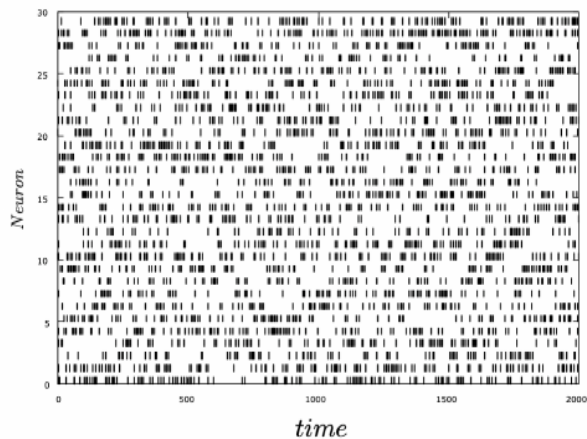
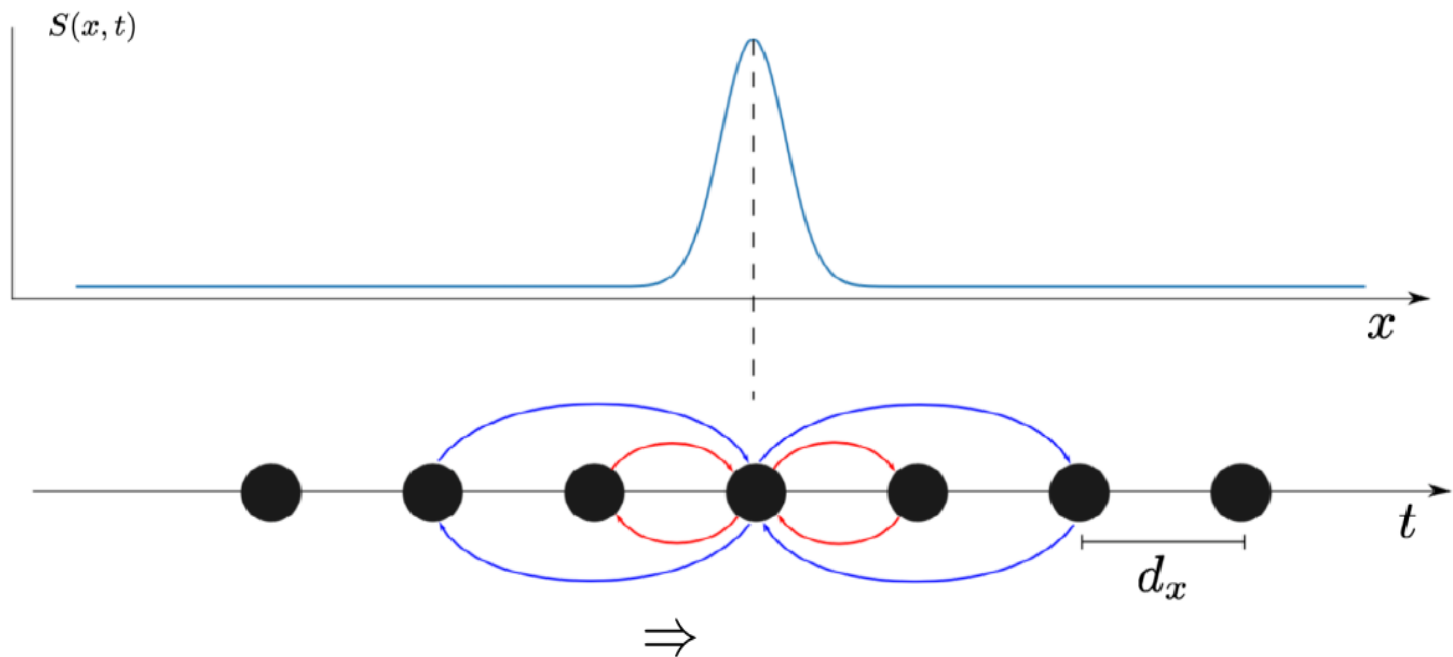

Spontaneous spiking activity

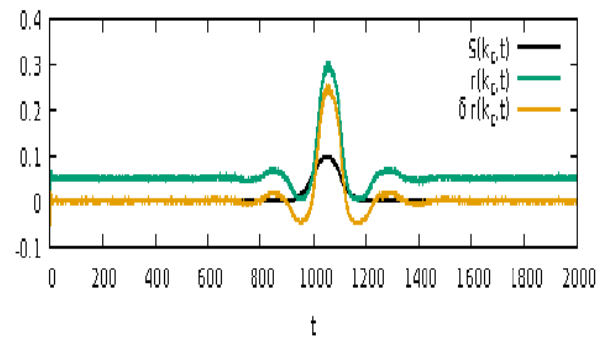
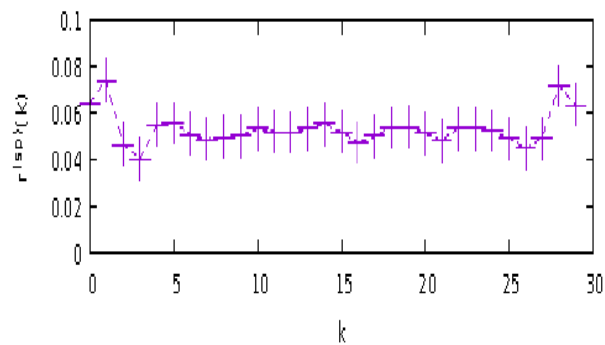
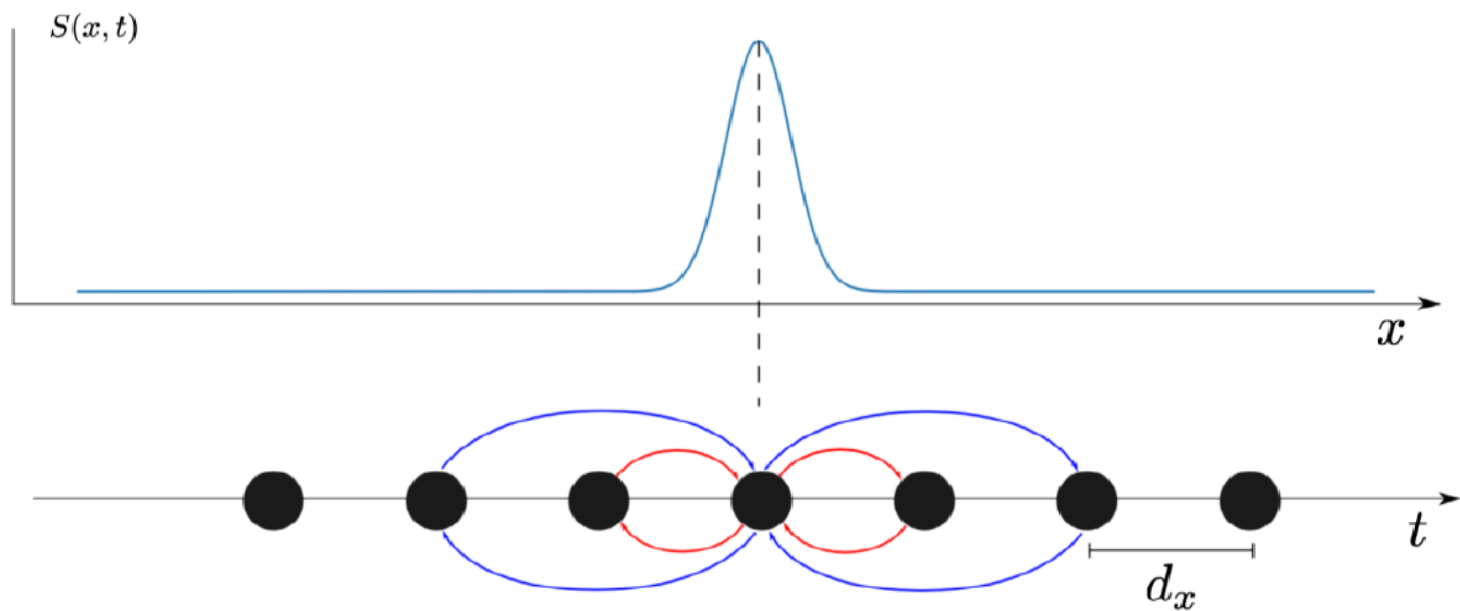

Sample averaging (non stationary)

Spontaneous spiking activity

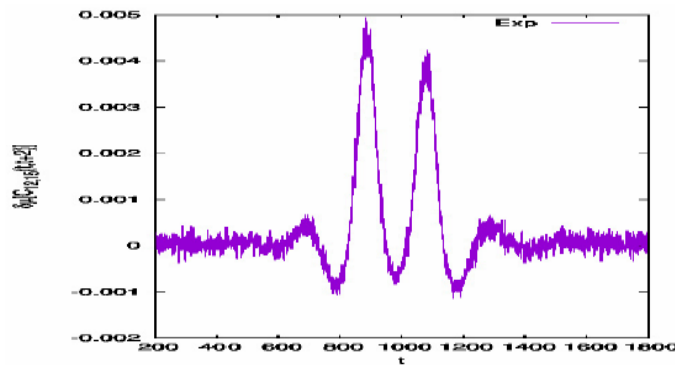
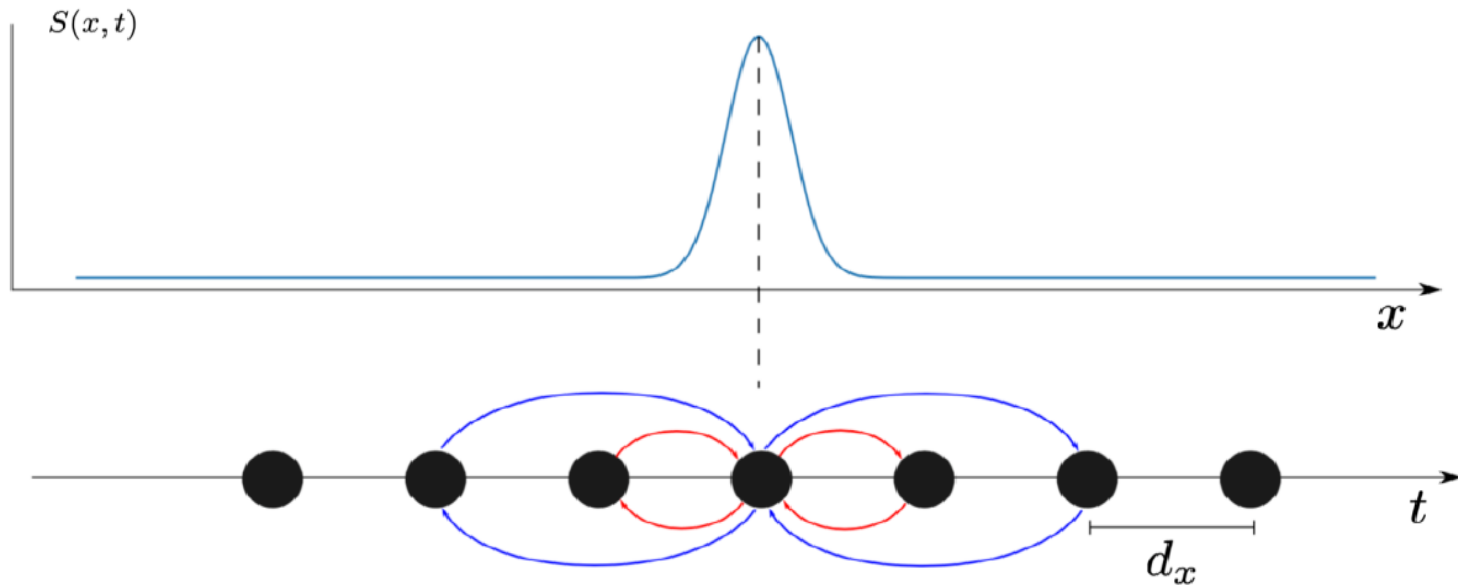

Variation in the correlation $C_{12,15}(t, t + 2)$

Correlation variations are triggered by the stimulus, but they are constrained by the network dynamics.

How to compute the spatio-temporal response of a neuronal network to a time dependent stimulus ?

Can we compute the time variation of spike-observables as a function of the stimulus and spontaneous dynamics ?

B. Cessac, I. Ampuero, R. Cofre, Linear response for spiking neuronal networks with unbounded memory. *Entropy*, MDPI, 2021, 23 (2), pp.155.

A conductance-based Integrate and Fire model

Variable length Markov chain with unbounded memory

$$P_n [\omega(n) \mid \omega_{-\infty}^{n-1}] \equiv \Pi \left(\omega(n), \frac{\theta - V_k^{(det)}(n-1, \omega)}{\sigma_k(n-1, \omega)} \right)$$

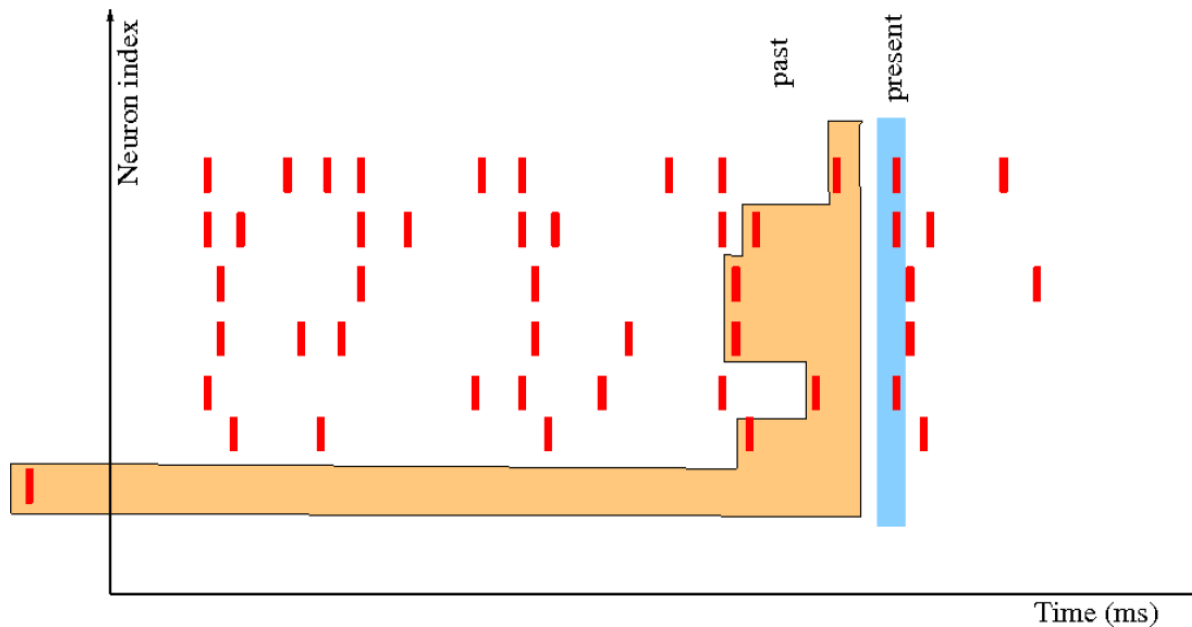

Response to stimuli

B. Cessac, I. Ampuero, R. Cofre, Linear response for spiking neuronal networks with unbounded memory. Entropy, MDPI, 2021, 23 (2), pp.155.

GIF model without stimulus \Rightarrow *stationary Gibbs distribution*.

time-dependent stimulus $S(t) \Rightarrow$ *non stationary Gibbs distribution*.

How is the average of an observable $f(\omega, t)$ affected by the stimulus ?

If S is weak enough: $\delta\mu[f(t)] = [\kappa_f * S](t)$, (linear response).

$$\kappa_{k,f}(t - t_1) = \frac{1}{C_k} \sum_{r=-\infty}^{n=[t]} C^{(sp)} \left[f(t, \cdot), \frac{\mathcal{H}_k^{(1)}(r, \cdot)}{\sigma_k(r-1, \cdot)} \int_{\tau_k(r-1, \cdot)}^{r-1} S_k(t_1) \Gamma_k(t_1, r-1, \cdot) dt_1 \right]$$

Firing rates

Computations have been done using the INRIA Pranas software, B. Cessac et al, *Frontiers in Neuroinformatics*, Vol 11, page 49, (2017).

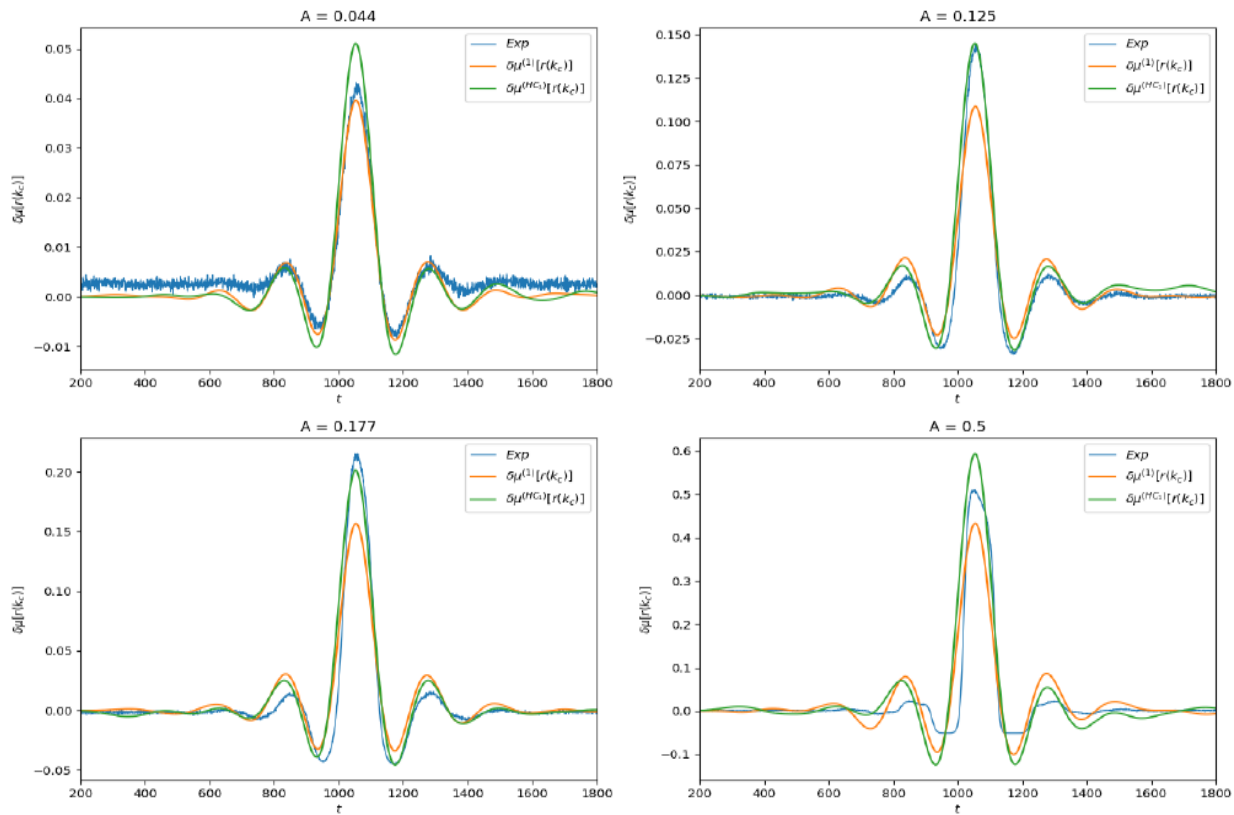

Figure: Linear response of $f(\omega, n) = \omega_{k_c}(n)$ for different values of stimulus amplitude A .

Higher order observable

Computations have been done using the INRIA Pranas software, B. Cessac et al, *Frontiers in Neuroinformatics*, Vol 11, page 49, (2017).

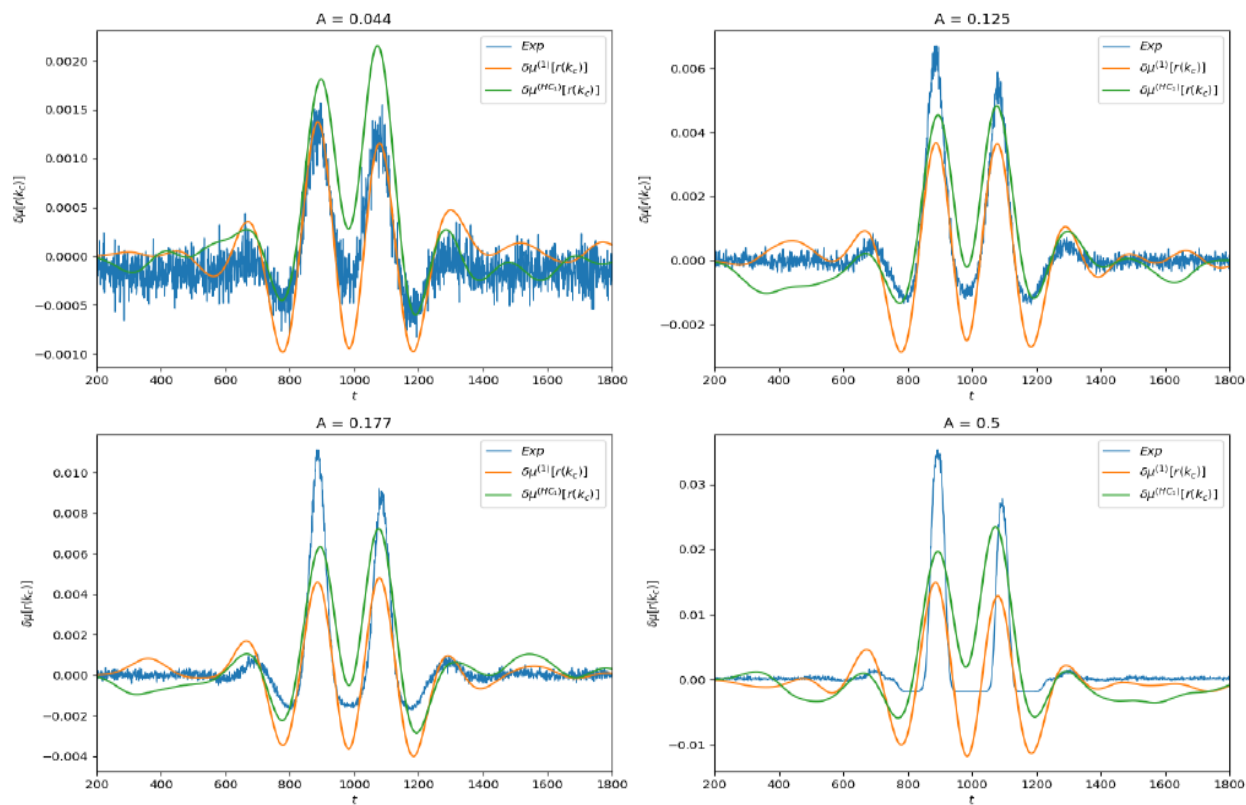

Figure: Linear response of the observable $f(n, \omega) = \omega_{k_c-2}(n-3)\omega_{k_c}(n)$.

Higher order observable

Computations have been done using the INRIA Pranas software, B. Cessac et al, *Frontiers in Neuroinformatics*, Vol 11, page 49, (2017).

Question to mathematicians :

Would it be possible to extend this linear response in a more general context (Hawkes processes, Galves-Löcherbach model) ?

200 400 600 800 1000 1200 1400 1600 1800 200 400 600 800 1000 1200 1400 1600 1800
t t

Figure: Linear response of the observable $f(n, \omega) = \omega_{k_C - 2}(n - 3)\omega_{k_C}(n)$.

Conclusions

- Visual entries are **neither stationary**, nor **spatially regular**.

Conclusions

- Visual entries are **neither stationary**, nor **spatially regular**.
- The « **longitudinal** » pathways PhotoReceptors => Bipolar cells => Ganglion cells efficiently encode the visual information into **parallel flows**.

Conclusions

- Visual entries are **neither stationary**, nor **spatially regular**.
- The « **longitudinal** » pathways PhotoReceptors => Bipolar cells => Ganglion cells efficiently encode the visual information into **parallel flows**.
- On the basis of biophysical modelling + mathematical analysis we found that Amacrine cells may generate, from a **moving stimulus**, **spatio-temporal correlations (waves)** contributing to better encoding a visual scene (e.g. **anticipation**).

Conclusions

- Visual entries are **neither stationary**, nor **spatially regular**.
- The « **longitudinal** » pathways PhotoReceptors => Bipolar cells => Ganglion cells efficiently encode the visual information into **parallel flows**.
- On the basis of biophysical modelling + mathematical analysis we found that Amacrine cells may generate, from a **moving stimulus**, **spatio-temporal correlations (waves)** contributing to better encoding a visual scene (e.g. **anticipation**).
- We also showed theoretically that an object moving in the receptive field of laterally connected Ganglion Cells may dramatically imprint **spike statistics**, not only firing rates, but also **higher order correlations**, living, in the **raster plots**, a trace that could be deciphered.

Conclusions

- Visual entries are **neither stationary**, nor **spatially regular**.
- The « **longitudinal** » pathways PhotoReceptors => Bipolar cells => Ganglion cells efficiently encode the visual information into **parallel flows**.
- On the basis of biophysical modelling + mathematical analysis we found that Amacrine cells may generate, from a **moving stimulus**, **spatio-temporal correlations (waves)** contributing to better encoding a visual scene (e.g. **anticipation**).
- We also showed theoretically that an object moving in the receptive field of laterally connected Ganglion Cells may dramatically imprint **spike statistics**, not only firing rates, but also **higher order correlations**, living, in the **raster plots**, a trace that could be deciphered.
- This leads to a paradigm very different from the « **efficient coding** » paradigm where longitudinal pathways are assumed to be independent. We switch from a paradigm of « rate » decoding to « **correlations** » **decoding**.

Thanks ◀◀