



**HAL**  
open science

# Modeling Memory Contention between Communications and Computations in Distributed HPC Systems (Extended Version)

Alexandre Denis, Emmanuel Jeannot, Philippe Swartvagher

► **To cite this version:**

Alexandre Denis, Emmanuel Jeannot, Philippe Swartvagher. Modeling Memory Contention between Communications and Computations in Distributed HPC Systems (Extended Version). [Research Report] RR-9451, INRIA Bordeaux, équipe TADAAM. 2022, pp.34. hal-03564751v1

**HAL Id: hal-03564751**

**<https://inria.hal.science/hal-03564751v1>**

Submitted on 10 Feb 2022 (v1), last revised 31 May 2022 (v2)

**HAL** is a multi-disciplinary open access archive for the deposit and dissemination of scientific research documents, whether they are published or not. The documents may come from teaching and research institutions in France or abroad, or from public or private research centers.

L'archive ouverte pluridisciplinaire **HAL**, est destinée au dépôt et à la diffusion de documents scientifiques de niveau recherche, publiés ou non, émanant des établissements d'enseignement et de recherche français ou étrangers, des laboratoires publics ou privés.

*Inria*

# Modeling Memory Contention between Communications and Computations in Distributed HPC Systems (Extended Version)

Alexandre DENIS, Emmanuel JEANNOT, Philippe SWARTVAGHER

**RESEARCH  
REPORT**

**N° 9451**

February 2022

Project-Team TADaAM

ISRN INRIA/RR--9451--FR+ENG

ISSN 0249-6399





# Modeling Memory Contention between Communications and Computations in Distributed HPC Systems (Extended Version)

Alexandre DENIS, Emmanuel JEANNOT, Philippe  
SWARTVAGHER

Project-Team TADaaM

Research Report n° 9451 — February 2022 — 34 pages

## Abstract:

To amortize the cost of MPI communications, distributed parallel HPC applications can overlap network communications with computations in the hope that it improves global application performance. When using this technique, both computations and communications are running at the same time. But computation usually also performs some data movements. Since data for computations and for communications use the same memory system, memory contention may occur when computations are memory-bound and large messages are transmitted through the network at the same time.

In this paper we propose a model to predict memory bandwidth for computations and for communications when they are executed side by side, according to data locality and taking contention into account. Elaboration of the model allowed to better understand locations of bottleneck in the memory system and what are the strategies of the memory system in case of contention. The model was evaluated on many platforms with different characteristics, and showed a prediction error in average lower than 4 %.

**Key-words:** HPC, MPI, Memory Contention, NUMA, Bandwidth, Predictive Models, Multicore Processing

**RESEARCH CENTRE  
BORDEAUX – SUD-OUEST**

200 avenue de la Vieille Tour  
33405 Talence Cedex

# Modélisation de la contention mémoire entre les communications et les calculs sur les systèmes HPC distribués (version étendue)

**Résumé :** Pour amortir le coût des communications MPI, les applications HPC distribuées et parallèles peuvent recouvrir les communications réseau par des calculs, dans l'espoir d'améliorer les performances globales de l'application. L'utilisation de cette technique implique d'exécuter en même temps des calculs et des communications. Généralement, les calculs causent des déplacements de données. Puisque les données pour les calculs et celles pour les communications circulent au sein du même système gérant la mémoire, de la contention peut se produire dans ce système lorsque les calculs sont limités par les données et les communications échangent des messages de taille importante.

Nous proposons dans ce papier un modèle pour prédire le débit mémoire accordé aux calculs et aux communications lorsqu'ils sont exécutés en parallèle. Ce modèle prend en compte le placement des données et la contention mémoire. L'élaboration de ce modèle nous a permis de mieux comprendre quels sont les composants du système mémoire les plus sujets à la contention, et quelles sont les stratégies mises en œuvre par le système pour gérer cette dernière. Le modèle a été évalué sur plusieurs machines avec différentes caractéristiques et ses prédictions ont une erreur en moyenne inférieure à 4 %.

**Mots-clés :** HPC, MPI, Contention Mémoire, NUMA, Débit mémoire, Modèle Prédicatif, Calcul Multicœur

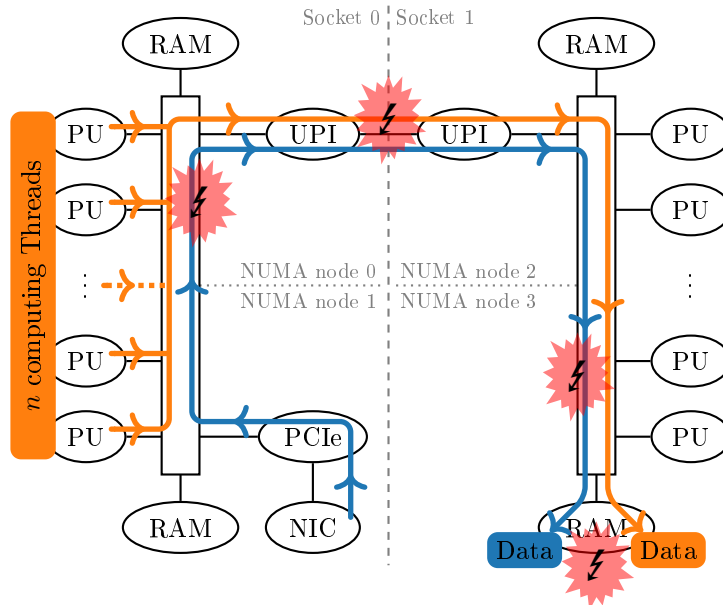

Figure 1: Contention between computations and communications can occur at different locations. The *inter-socket bus* is called *Infinity Fabric* (IF) on AMD processors, and *Ultra Path Interconnect* (UPI) on INTEL processors.

This research report extends an article submitted to the 24<sup>th</sup> *Workshop on Advances in Parallel and Distributed Computational Models*, still under peer-review.

## 1 Introduction

The key to reach a good scalability in distributed high-performance computing (HPC) is to reduce the cost of communications. One way of amortizing this cost as done by modern HPC applications consists in running computation alongside communications. This technique is known as communication and computation overlap, which consists in running the communications in background, while the computation is performed, in the hope that their cost becomes basically free.

However, computation moves data between memory and cores. When overlapping communications and computation, data movement for the computation and for the network may share parts of the path in the machine memory system. Contention can occur on this path, between these two kinds of streams. Figure 1 illustrates an example of such a situation: computing cores use data stored on a specific NUMA node and, in this case, communications store data received from the network on the same NUMA node. Both data streams travel through same paths of the memory system: contention can occur in the memory controller of a processor, the inter-socket connection link or the controller of a NUMA node. These bottlenecks can reduce performances of both computations and communications, while computations/communications overlap is usually set up to save execution time.

We observed [1] that contention between computations and communications actually happens in practice, and we have shown that several factors can impact it: data placement, message size and arithmetic intensity of computing kernels. Performances are the most reduced when

computing kernels are memory-intensive (putting important pressure on memory buses), big messages are exchanged (thus moving big messages through memory buses) and data to send to the network is located on a NUMA node different than the one where the network interface is plugged to.

In this paper, we propose a model of this contention between computations and communications. Given a number of computing cores, the model can predict memory bandwidth available for computations and communications, when they are executed simultaneously, while taking into account the locality of data they manipulate. More than just predicting performances, the model allows us to test our hypotheses about the internal working of processors' memory system, how they deal with contention between different kinds of streams.

The rest of the paper is organized as follows: section 2 introduces context and initial hypotheses to build the model. Then, section 3 explains the model. Model predictions are evaluated and discussed in section 4. Finally section 5 presents related works and section 6 summarizes our findings.

## 2 Context and hypotheses

Since different kinds of data streams can share the same memory bus, it is possible to sum the measured bandwidths of each data stream, to get the overall occupancy of the bus capacity, from a bandwidth point of view. Indeed, this assumption is the cornerstone of our model; once the bandwidth capacity of the bus is known, one has to distribute the available bandwidth between computations and communications.

However, it is important to note that behaviours of processors and memory controllers regarding contention are not publicly documented by processor manufacturers. Moreover, the values they use to characterize hardware features (the memory controller bandwidth or the SMP interconnect rate, for instance) can hardly be linked to experimental observations, nor directly used as parameters of the model.

Thus we propose a model whose parameters are determined through experiments rather than theoretical capacity of hardware. We make our own set of hypotheses explaining memory bandwidth in case of contention, as well as our own set of benchmarks to get model parameters.

### 2.1 Contention behaviour

Memory buses have a finite bandwidth. When this capacity (or threshold) is reached, the bus capacity is shared between all components accessing it, reducing memory bandwidth available for each accessor. Memory requests issued by CPU cores may have a different (often higher) priority than requests coming from PCIe devices, *e.g.* from a network interface. However, a minimal memory bandwidth will always be available for communications, to prevent starvations. We can also assume in some cases computing cores can generate contention with each other, even without communications in parallel.

If we put together these hypotheses: when communications and computations executed in parallel reach together the memory bus bandwidth threshold, communication bandwidth starts to decrease to avoid impacting computing cores. When the assured minimum bandwidth for communications is reached, the performance of computations decreases uniformly between computing cores to fit the memory bus capacity; but the contention between the computing cores can already create contention penalizing computation performances too.

## 2.2 NUMA systems

Nowadays, machines commonly feature *Non-Uniform Memory Access* (NUMA): as depicted in Figure 1, multiple memory banks are available; each memory bank is connected to a single CPU. Although the whole available memory is still accessible through a single address space, the performance of a memory access varies whether a core is accessing its own memory or the memory from another memory bank. Hence, we will use the terms *local* and *remote* to qualify whether computing cores use memory respectively close or far to them.

The main consequence of such NUMA systems is that memory bandwidth will vary whether cores or network interface are accessing local or remote memory. Moreover, depending on where is located memory used for computations or communications, the path taken by the data between the NUMA node and the computing core or the network interface will be different, changing the locations of contention. Thus our model has to take into account on which NUMA node data manipulated by computations or communications are located.

To focus on the interferences between computations and communications, we will not mix local and remote accesses from computing cores. This means we will model performances of computations and communications when cores of only one socket are computing. Considering computing cores of all sockets accessing the same NUMA node (thus some of them are doing local accesses and other ones remote accesses) is another problematic that is left for future work.

## 2.3 Last level caches

The last-level cache (L3 cache on most machines), between cores and NUMA nodes, tends to alleviate the number of memory transfers done by computation. Thus, we would overestimate the number of memory movements if we assumed that every memory access instruction would lead to an actual transfer through the whole memory system. It would lead to wrong results about contention since our model only takes as input actual memory transfers.

If the data of the streams we are predicting the bandwidth go through the last-level cache, our model has to describe two phenomena: the contention on memory bus and the behaviour of the cache. However, the behaviour of the cache is complex to model [2,3], implements undocumented strategies different for each processor manufacturer, and changes for each kind of application. All in all, modeling the cache is another topic, different from the one we are currently dealing with.

For all these reasons, we chose to ignore the last-level cache and make the data stream bypass it.

## 2.4 Modeling methods

A widespread model for contention is queuing theory [4,5]: cores or network interfaces are customers; when they make a memory request, they enter in the queue: they leave the queue when the request is processed. Closed-form expressions exist for properties of such queues, especially the mean time spent in a queue. Unfortunately this kind of model is not relevant for our usecase. Since NUMA machines have a hierarchical organization of their memory, bottlenecks can appear on several places in the memory system (see Figure 1). Each place where contention can occur has to be represented by a dedicated queue, and the different queues of all memory components have to be combined to model the behaviour of the whole memory system. Correctly assembling the queues requires to have a sharp understanding of how the memory system works (knowledge usually not available publicly and specific to each processor generation and manufacturer). Even if we succeed in proposing an assembly of queues, getting all parameters of all queues would



require lot of execution samples to be precise enough. Moreover, obtained parameters characterizing the queue can lack physical meaning, making the parameter interpretation harder. Most queuing models are built with the assumption that all customers have the same request rate; it is not necessarily true in our case: one network interface can issue memory requests at a higher rate than one computing core (a single computing core can reach a memory bandwidth of 5 GB/s, while network bandwidth can be around 10 GB/s). In such situation, we lose the closed-form expressions, which were the main advantage of queuing theory.

We chose a simpler model, easier to manipulate, but accurate enough for our needs: a basic threshold. While the bandwidth required by all issuers of memory requests stays under the memory bus capacity, there is no contention, no impact on performances. When it does not fit the memory bus anymore, only the bus capacity is available, and is split among computing cores and network interface. This model, described in details below, has the advantages of requiring few application runs to calibrate the parameters and has understandable parameters with a physical meaning, well-known units, and coherent values regarding performed benchmarks and hardware features.

### 3 A model for memory bandwidth sharing

The model gives the memory bandwidths available for computations and communications, and thus predicts the impact of the contention on their performances, using as parameters the number of computing cores, the memory location of data used by computations and communications and the topology of the machine.

Since memory bandwidth depends on which NUMA node is accessed, we need to instantiate our model once for *local* accesses noted  $\mathcal{M}_{local}$  (*e.g.* memory for computations and communications located on the first NUMA node of the first socket) and once for *remote* accesses noted  $\mathcal{M}_{remote}$  (*e.g.* memory for computations and communications located on the first NUMA node of the second socket). Parameters of each model are defined with metrics collected on executions where data used for computations and communications are on the same NUMA node (case with the largest contention). Once parameters are collected, performances can be predicted according to these parameters. Performances with memory placement configurations other than the ones used to instantiate the model are predicted by combining the local and remote models. This section explains how model parameters are defined, then how the model predicts performances and finally how models for local and remote accesses are combined to predict performances of all possible data placements.

#### 3.1 Model parameters

The model requires several parameters describing the behaviour of the machine when communications and computations are executed independently, to know nominal performances and predict them correctly when there is no contention, and in parallel, to know what can be the impact of contention.

A convenient way to understand how bandwidths which will be predicted by the model evolve is to sum memory bandwidths for computations and communications and visualize them by stacking them. Since both streams share parts of the same memory system, it allows to easily represent the share of the bus capacity among the two different streams. Figure 2 is an example of such representation: according to the number of computing cores, the orange area depicts memory bandwidth for all computing cores and blue area depicts memory bandwidth for communications, when they are both executed in parallel. We also show the graph of the memory bandwidth for computation executed alone, in green.

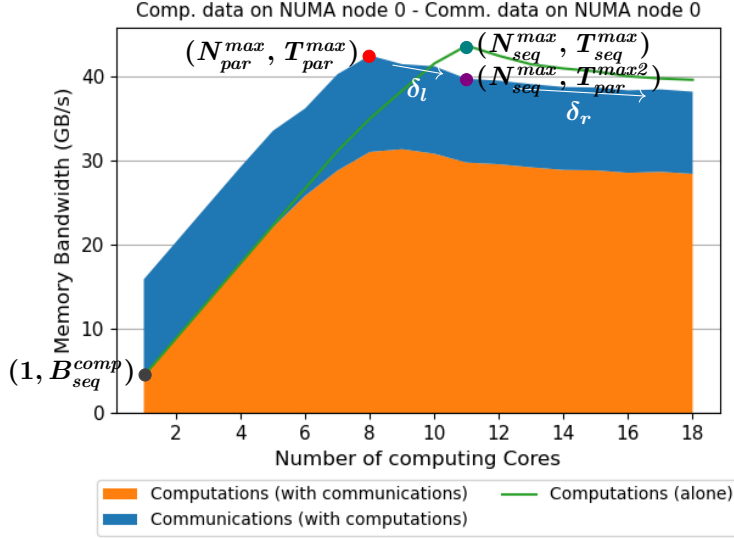

Figure 2: Stacked memory bandwidth for computations and communications, with coordinates of the interesting points to instantiate the model: memory bandwidth for one computing core, the maximum memory bandwidths reached with lonely computations, with computations and communications in parallel, and the lost of total memory bandwidth when additional cores are computing.

One can notice memory bandwidth for computations alone scales perfectly from  $B_{seq}^{comp}$  (● on the plot, with one computing core) until  $T_{seq}^{max}$  with  $N_{seq}^{max}$  computing cores (● on the plot). With more computing cores, the memory bandwidth slightly decreases linearly.

When computations and communications are executed in parallel, the maximum bandwidth is different ( $T_{par}^{max}$ , ● on the plot) than when computations are executed alone, as well as the number of computing cores ( $N_{par}^{max}$ ) necessary to reach this maximum. With more computing cores, the total bandwidth decreases linearly too, but with a slope discontinuity when there are  $N_{seq}^{max}$  computing cores. Between  $N_{par}^{max}$  and  $N_{seq}^{max}$  computing cores, each additional computing core reduces the total bandwidth  $T_{par}^{max}$  with  $\delta_l$ . With more than  $N_{seq}^{max}$  computing cores, each additional computing core reduce the total bandwidth for computations and communications with  $N_{seq}^{max}$  computing cores ( $T_{par}^{max2}$ , ● on the plot) with  $\delta_r$ .

Other important parameters of the model are related to network performances. Network communications require a bandwidth  $B_{seq}^{comm}$  when they are executed alone (their nominal performances, not appearing in Figure 2). Although it is difficult to perceive on this figure, the memory bandwidth available for communications is reduced in the worst case by a factor  $\alpha$ , computed as follow:  $\alpha = \min(\frac{B_{par}^{comm}(i)}{B_{seq}^{comm}})$ , where  $i$  represents the number of computing cores.

Introduced notations characterize behaviour of the memory system and compose the model parameters. To sum up, the model requires the following parameters to predict memory bandwidth for computations and communications:

- $N_{par}^{max}, T_{par}^{max}$ : the maximum total memory bandwidth  $T_{par}^{max}$  reached when computations and communications are executed simultaneously, and with how many computing cores  $N_{par}^{max}$  it is reached;

- $N_{seq}^{max}, T_{seq}^{max}$ : the maximum memory bandwidth  $T_{seq}^{max}$  reached when computations are executed alone, and with how many computing cores  $N_{seq}^{max}$  it is reached;
- $T_{par}^{max2}$ : the total memory bandwidth when communications are performed and  $N_{seq}^{max}$  cores are computing in parallel;
- $\delta_l, \delta_r$ : the memory bandwidths lost per additional computing core when there are respectively between  $N_{par}^{max}$  and  $N_{seq}^{max}$  computing cores and when there are more than  $N_{seq}^{max}$  computing cores;
- $B_{seq}^{comp}$ : the memory bandwidth used by one single computing core;
- $B_{seq}^{comm}$ : the communication bandwidth when communications are executed alone;
- $\alpha$ : the ratio of the available bandwidth for communications in the worst case.

### 3.2 Modeling memory bandwidth

Our model predicts the performances of computations *and* communications when they are executed in parallel, for every possible number  $n$  of computing cores on one socket. It also predicts performances when computations and communications are executed independently, to be able to predict performance of memory binding configurations without contention.

The performances are predicted in two steps: first, the total bandwidth  $\mathcal{T}$  the memory system can support according to the number of computing cores is estimated, then this total bandwidth is split between communications and computations.

The total bandwidth  $\mathcal{T}(n)$  for computations and communication when  $n$  cores are computing is given by the following equation:

$$\mathcal{T}(n) = \begin{cases} T_{par}^{max} & \text{if } n \leq N_{par}^{max} \\ T_{par}^{max} - \delta_l \times (n - N_{par}^{max}) & \text{else if } N_{par}^{max} < n \leq N_{seq}^{max} \\ T_{par}^{max2} - \delta_r \times (n - N_{seq}^{max}) & \text{otherwise} \end{cases} \quad (1)$$

The different cases linearly approximate the total bandwidth: while there are less than  $N_{par}^{max}$  computing cores, the bandwidth is at its higher level  $T_{par}^{max}$ ; when there are more computing cores, contention starts to impact total bandwidth and for each additional core,  $\delta_l$  or  $\delta_r$  is subtracted, whether there are less or more than  $N_{seq}^{max}$  computing cores (corresponding to the left or the right of the inflexion point).

Bandwidth allocated to computations and communications follows different equations which depend if satisfying computing core requirements ( $n \times B_{seq}^{comp}$ ) and assuring minimum bandwidth to communications ( $\alpha \times B_{seq}^{comm}$ ) is lower than the bus capacity or exceeds it. The bandwidth required to fit into the bus, noted  $R(n)$ , is given by the following formula:

$$R(n) = n \times B_{seq}^{comp} + \alpha \times B_{seq}^{comm} \quad (2)$$

The share of the total bandwidth allocated to computing cores is described by the following equation:

$$\mathcal{B}_{par}^{comp}(n) = \begin{cases} n \times B_{seq}^{comp} & \text{if } R(n) < \mathcal{T}(n) \\ \mathcal{T}(n) - \mathcal{B}_{par}^{comm}(n) & \text{otherwise} \end{cases} \quad (3)$$

While all memory bandwidth requested by computing cores and minimal bandwidth assured for communications fit in the total available bandwidth, computations on  $n$  computing cores will get the memory bandwidth  $\mathcal{B}_{par}^{comp}(n)$ , corresponding to their request (perfect scaling). When

the threshold is reached, computations get the remaining bandwidth after communications got their share of the bandwidth.

The bandwidth for communications is allocated as stated by the following equation:

$$\mathcal{B}_{par}^{comm}(n) = \begin{cases} \min(\mathcal{T}(n) - \mathcal{B}_{par}^{comp}(n), B_{seq}^{comm}) & \text{if } R(n) < \mathcal{T}(n) \\ \alpha(n) \times B_{seq}^{comm} & \text{otherwise} \end{cases} \quad (4)$$

While  $R(n)$  is lower than the bus capacity, communications get the share of the total bandwidth unused by computing cores, but they cannot use more than the nominal performance of the network  $B_{seq}^{comm}$ . When  $R(n)$  exceeds the bus capacity, the bandwidth for communications is impacted by a factor  $\alpha(n)$ :

$$\alpha(n) = \begin{cases} \frac{B_{par}^{comm}(i)}{B_{seq}^{comm}} - \frac{\frac{B_{par}^{comm}(i)}{B_{seq}^{comm}} - \alpha}{N_{seq}^{max} - i} \times (n - i) & \text{if } N_{seq}^{max} - N_{par}^{max} > 1 \text{ and } n < N_{seq}^{max}, \\ & \text{where } i = \max_j(\{j | R(j) < \mathcal{T}(j)\}) \\ \alpha & \text{otherwise} \end{cases} \quad (5)$$

With  $N_{seq}^{max}$  or more computing cores, communications get their minimal assured bandwidth, thus  $\alpha(n) = \alpha$ . When there are less computing cores, more than one core between  $N_{par}^{max}$  and  $N_{seq}^{max}$ , and  $R(n) \geq \mathcal{T}(n)$  (*i.e.* the case when  $\alpha(n)$  has to be computed), bandwidth for communication does not abruptly drop to  $\alpha \times B_{seq}^{comm}$ . Therefore, we linearly interpolate the factor, with reference points the factor of impact on communications with the maximum number of computing cores where  $R(n) < \mathcal{T}(n)$  is still valid (noted  $i$  in the equation), and  $\alpha$  with  $N_{seq}^{max}$  computing cores.

To predict performances on all memory placement configurations, the model needs in some configuration to predict performances of computations and communications executed alone, when there is no contention. The bandwidth for communications executed alone is simply the model parameter  $B_{seq}^{comm}$ . The bandwidth for computations executed alone is given by the following formula:

$$\mathcal{B}_{seq}^{comp}(n) = \min(n \times B_{seq}^{comp}, \mathcal{T}(n), T_{seq}^{max}) \quad (6)$$

The formula considers a perfect scaling of memory bandwidth allocated to computing cores, limited by the memory bus capacity  $\mathcal{T}(n)$  and cannot neither exceed the maximum bandwidth  $T_{seq}^{max}$  when computations are executed alone.

### 3.3 Model NUMA effect

NUMA systems present different memory bandwidths depending if accesses are made to a local or a remote NUMA node. Therefore, we need two model instantiations, each with its own set of parameter values. The set of parameters describing local accesses, when both computations and communications make memory accesses to the same local NUMA node (regarding to computing cores), is noted  $\mathcal{M}_{local}$ , and conversely, the set of parameters describing remote accesses, when they make memory accesses to the same NUMA node of a another socket, is noted  $\mathcal{M}_{remote}$ .

Using equations 1 to 5, we can model performances for the two memory binding configurations we used to calibrate the two models, by directly using the corresponding model. However, we need to combine these two models to predict performances on all other memory binding configurations. Predicting bandwidths of computations and communications require now two additional parameters, to take into account data location: the index of the NUMA node where are located data used by computations ( $m_{comp}$ ) and by communications ( $m_{comm}$ ). These parameters, in addition to the number of NUMA nodes per socket noted  $\#m$ , allow to select the corresponding bandwidth according to placement.

In the rest of the section, the notation  $\mathcal{B}(\mathcal{M})$  means the bandwidth  $\mathcal{B}$  is given by using the model instantiation  $\mathcal{M}$ .

Regarding communications, the model to apply is selected with the following equation:

$$\mathcal{B}_{par}^{comm}(n, m_{comp}, m_{comm}) = \begin{cases} \mathcal{B}_{par}^{comm}(\mathcal{M}_{remote}, n) & \text{if } m_{comp} \geq \#m \text{ and } m_{comp} = m_{comm} \\ \mathcal{B}_{par}^{comm}(\mathcal{M}_{local} \setminus B_{seq}^{comm}(\mathcal{M}_{remote}), n) & \text{else if } m_{comm} \geq \#m \\ \mathcal{B}_{par}^{comm}(\mathcal{M}_{local}, n) & \text{otherwise} \end{cases} \quad (7)$$

If both computations and communications access to the same remote NUMA node, communication bandwidth is given by the remote model  $\mathcal{M}_{remote}$ . In all other cases, communications are less subject to contention and follow the local model  $\mathcal{M}_{local}$ . However, on some machines, the network performances are very sensible to the locality of exchanged data. Since  $\mathcal{M}_{local}$  is instantiated with communication bandwidth with data located on the local NUMA node, it may not fit the network performances when data for communications are located on the remote NUMA node. Therefore in this case, we use the local model, but with the nominal network performances when data are located on remote memory, *i.e.* the  $B_{seq}^{comm}$  of  $\mathcal{M}_{remote}$ .

The model for computation bandwidth is selected with the following equation:

$$\mathcal{B}_{par}^{comp}(n, m_{comp}, m_{comm}) = \begin{cases} \mathcal{B}_{par}^{comp}(\mathcal{M}_{local}, n) & \text{if } m_{comp} < \#m \text{ and } m_{comp} = m_{comm} \\ \mathcal{B}_{seq}^{comp}(\mathcal{M}_{local}, n) & \text{if } m_{comp} < \#m \text{ and } m_{comp} \neq m_{comm} \\ \mathcal{B}_{par}^{comp}(\mathcal{M}_{remote}, n) & \text{if } m_{comp} \geq \#m \text{ and } m_{comp} = m_{comm} \\ \mathcal{B}_{seq}^{comp}(\mathcal{M}_{remote}, n) & \text{if } m_{comp} \geq \#m \text{ and } m_{comp} \neq m_{comm} \end{cases} \quad (8)$$

Computations are impacted by contention only when data used for communications are on the same NUMA node as data for computations. In such case, bandwidth for computations is the one with communications in parallel  $\mathcal{B}_{par}^{comp}$ , from the model corresponding to computation data location, local or remote. In the same fashion, when computations and communications do not use the same NUMA node for their data, computations get their nominal memory bandwidth  $\mathcal{B}_{seq}^{comp}$ .

Appendix A presents algorithms to predict memory bandwidth for computations and communications, implemented using equations described above.

## 4 Evaluation of the model

We want to measure the impact of memory contention on computations and communications, when they are executed in parallel, and to compare it with the predictions of our model. To know the impact, we need the performances of computations and communications executed alone and in parallel.

### 4.1 Experimental setup

#### 4.1.1 Benchmarking program

We designed our own benchmarking suite<sup>1</sup>, which executes the following steps for all possible number of computing cores:

1. Computations alone

<sup>1</sup>Available on <https://gitlab.inria.fr/pswarta/memory-contention>

2. Communications alone
3. Computations and communications in parallel

Computations are spread among cores dedicated to computations with OPENMP pragmas and communications are done by a single thread bound to a dedicated core, between two machines using MPI. We used MADMPI, the MPI interface of NEWMADELEINE [6], for the presented results, but similar results are observed with other MPI libraries, such as OPENMPI. Computations and communications use different data, making them completely independent.

Having several computing cores and one core dedicated to communication management mimics the working of runtime systems such as STARPU [7] or PARSEC [8]. It has been demonstrated that using threaded communication [9, 10] allows communications and computation overlap and thus better application performance.

Performances are measured on a single node, but we still need two machines for network exchanges. We study the performance penalty caused by memory contention, therefore, to control and understand memory movements, all computing cores perform *non-temporal* `memset` instructions to move data from cores to memory, and communication performances are measured with the bandwidth observed to receive messages of 64 MB from the other machine. We use *non-temporal* instructions to bypass the last level cache, as explained in section 2.3: they tell the processor to store data directly in memory, bypassing the cache. Data used for communications and computations are explicitly bound on selected NUMA nodes, to know the data location and consider it in the model. Memory bandwidth for computations is computed from the duration of the `memset` instructions, each computing core always work on the same amount of data (weak scaling). Memory bandwidth for communications is considered to be the same as the network bandwidth, *i.e.* the message size over the necessary time to receive data from the other machine, since this stream has also to go through the memory bus after arriving on the network interface. Only samples collected during steady state are considered: all cores execute computation iterations for a defined amount of time, then we skip performances of first and last iterations of each core, to get rid of the performance when not exactly all cores are computing.

To bind memory on a specific NUMA node, bind threads to cores and gather topology information, we use HWLOC [11].

#### 4.1.2 Modeling all placements

With NUMA machines, we need two model instantiations: one for local memory accesses and another one for remote accesses. On a machine with two sockets (processors) and two NUMA nodes per socket, we would execute our benchmarking program to get model parameters with memory for computations and communications both located on the first NUMA node of the first socket for the local model and with memory located on the first NUMA node of the second socket for the remote model. Thus we need to measure memory bandwidths of two placement configurations, to latter be able to predict performances of all other configurations (16 in this example, since there are 4 possibilities where to put data for computations and the same 4 possibilities for communication data), as explained in section 3.3.

The program to measure memory bandwidth of one placement configuration needs to be executed for all possible numbers of computing cores, in the range of the number of cores on the first socket, as explained in section 3. Once the performance metrics (memory bandwidth for computations alone and in parallel of communications, network bandwidth for communications alone and in parallel of computations) are extracted from benchmark outputs, the evolution of the bandwidths over the number of computing cores is analyzed (it mostly looks for minima and maxima) and the parameters of the model, listed in section 3.1, are computed.

| Platform Type | Name                       | Processor                                   | Memory                        | Network                             |
|---------------|----------------------------|---|-------------------------------|-------------------------------------|
| Experimental  | <code>billy</code>         | 2 × AMD EPYC 7502 with 32 cores             | 128 GB of RAM<br>2 NUMA nodes | INFINIBAND<br>ConnectX-6 HDR        |
|               | <code>henri</code>         | 2 × INTEL Xeon Gold 6140 with 18 cores      | 96 GB of RAM<br>2 NUMA nodes  | INFINIBAND<br>ConnectX-4 EDR        |
|               | <code>henri-subnuma</code> |   | 96 GB of RAM<br>4 NUMA nodes  |                                     |
| Medium-scale  | <code>bora</code>          | 2 × INTEL Xeon Gold 6240 with 18 cores      | 192 GB of RAM<br>2 NUMA nodes | OMNI-PATH<br>HFI Silicon 100 series |
|               | <code>dahu</code>          | 2 × INTEL Xeon Gold 6130 with 16 cores      | 192 GB of RAM<br>2 NUMA nodes | OMNI-PATH<br>HFI Silicon 100 Series |
|               | <code>diablo</code>        | 2 × AMD EPYC 7452 with 32 cores             | 256 GB of RAM<br>2 NUMA nodes | INFINIBAND<br>ConnectX-6 HDR        |
|               | <code>grvingt</code>       | 2 × INTEL Xeon Gold 6130 with 16 cores      | 192 GB of RAM<br>2 NUMA nodes | OMNI-PATH<br>HFI Silicon 100 Series |
|               | <code>pyxis</code>         | 2 × CAVIUM-ARM ThunderX2 99xx with 32 cores | 256 GB of RAM<br>2 NUMA nodes | INFINIBAND<br>ConnectX-6 EDR        |
| Production    | <code>occigen</code>       | 2 × INTEL Xeon E5 2690v4 with 14 cores      | 64 GB of RAM<br>2 NUMA nodes  | INFINIBAND<br>Connect-IB FDR        |

Table 1: Characteristics of testbed platforms.

Note that this process can be optimized: once the maxima of bandwidth  $T_{par}^{max}$  and  $T_{seq}^{max}$  are found, one can skip executions with number of computing cores greater than  $N_{seq}^{max}$ , except the execution with all cores of the first socket, required to compute  $\delta_r$ . Here we still need to execute the program with all possible numbers of computing cores, to evaluate the accuracy of our model.

#### 4.1.3 Testbed platforms

We evaluated our model for the bandwidth metrics obtained on several platforms with different characteristics: from small experimental platforms to large production ones. Since we target HPC systems, we considered only fast networks, where contention occurs more; with technologies such as INFINIBAND and OMNI-PATH. Table 1 describes characteristics of platforms used to measure model accuracy. `henri` and `henri-subnuma` are the same platform, allowing to access to the BIOS to change number of NUMA nodes. Hyperthreading is only enabled on platforms `dahu`, `grvingt`, `pyxis` and `occigen`, however, on all platforms, threads are bound to physical cores (*i.e.* hyperthreads are not used).

Values of model parameters for each platform are presented in Appendix B.

## 4.2 Results

Figures 3 to 8 depict performances of computations and communications as well as the model predictions. Each figure is composed of several subplots, one per possible placement combination of data for computations and data for communications on available NUMA nodes. For instance, Figure 3 represents results on the `henri` platform, with 2 NUMA nodes. Data for communications can be located on 2 NUMA nodes, as well as data for computations, which leads to 4 placement combinations. Each line of plots represents one placement for communication data, while columns represent placements for computation data. Titles above each plot precise the placement of data. The two placement combinations used to instantiate the local and remote models are highlighted with a bold title and a thicker frame. Each subplot presents, according to the number of computing cores, network bandwidth (in blue, to be read on the left Y-axis) and memory bandwidth for computations (in orange, to be read on the right Y-axis), when they are executed alone ( $\bullet$  markers) and in parallel ( $\blacktriangledown$  markers). The blue and orange curves indicate our model predictions of the bandwidth for respectively communications and computations. Error bars are not shown to ease reading, but the run-to-run variability is very low.

**henri** Figure 3 shows there is contention between computations and communications, impacting them both, more or less severely according to data placement. Our model is accurate when computations and communications perform both remote memory accesses. When computations and communications perform both local accesses, our model reflects the correct impact on communications too late (the model predicts a decrease starting with 14 computing cores, while it is 10 in reality), because communications start to be impacted before the total bandwidth threshold  $\mathcal{T}$  is reached. Other memory placement configurations, not used to instantiate the model, show the same flaws.

**henri-subnuma** The `henri` platform configured with 4 NUMA nodes allows 16 data placement combinations, described by Figure 4. The grey and white areas are used to distinguish the two NUMA nodes of the first socket. With such numerous configurations, symmetries in performances appear, mimicking symmetries of the machine topology: for instance, when data for computations and communications are on different NUMA nodes of the second socket (right half of set of plots), performances are always the same, regardless of which NUMA nodes are used. These symmetries allow the model to be valid, with only two configurations used to predict all 16 combinations. All these configurations also show that the placement configurations the most disturbed by memory contention are the ones where data for computations and communications are on the same NUMA node (*i.e.* subplots on the diagonal of the figure), while computations are almost not impacted in other cases. Therefore we can guess memory contention occurs the most on memory controllers (responsible of accesses to one dedicated NUMA node), rather than on the inter-socket connection bus.

Figure 2 used previously to explain the model is the stacked version of the top left subplot of the Figure 4.

**diablo** Figure 5 shows results on the `diablo` platform, and illustrates especially the case when network performances are highly sensible to data locality: when data for communications is on the first NUMA node, network bandwidth reaches only 12.1 GB/s whereas when data is on the second NUMA node (which the NIC is actually plugged to), network bandwidth can raise up to 22.4 GB/s. Our model succeeds in predicting performances, even if there is almost no contention on this platform.



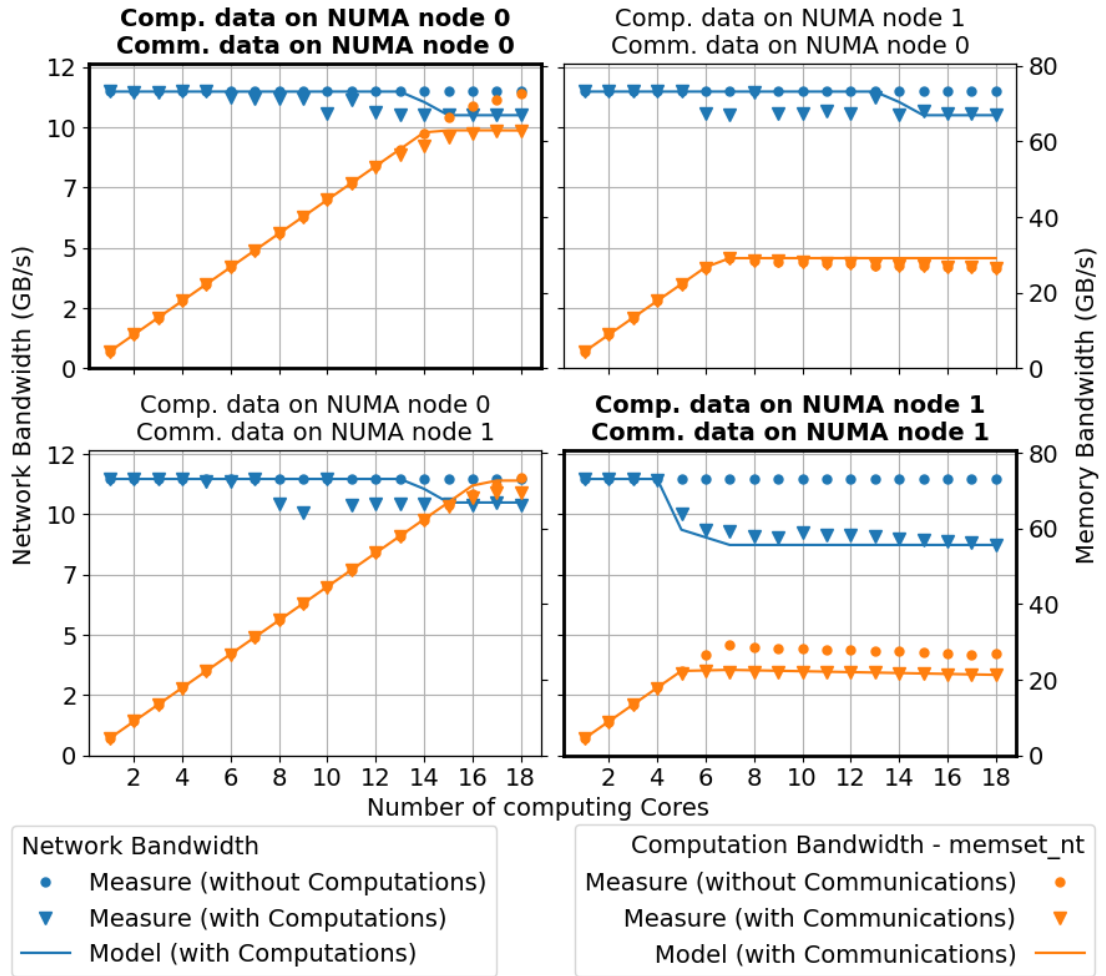

Figure 3: Performances of computations and communications along with our model prediction on henri (INTEL, INFINIBAND).

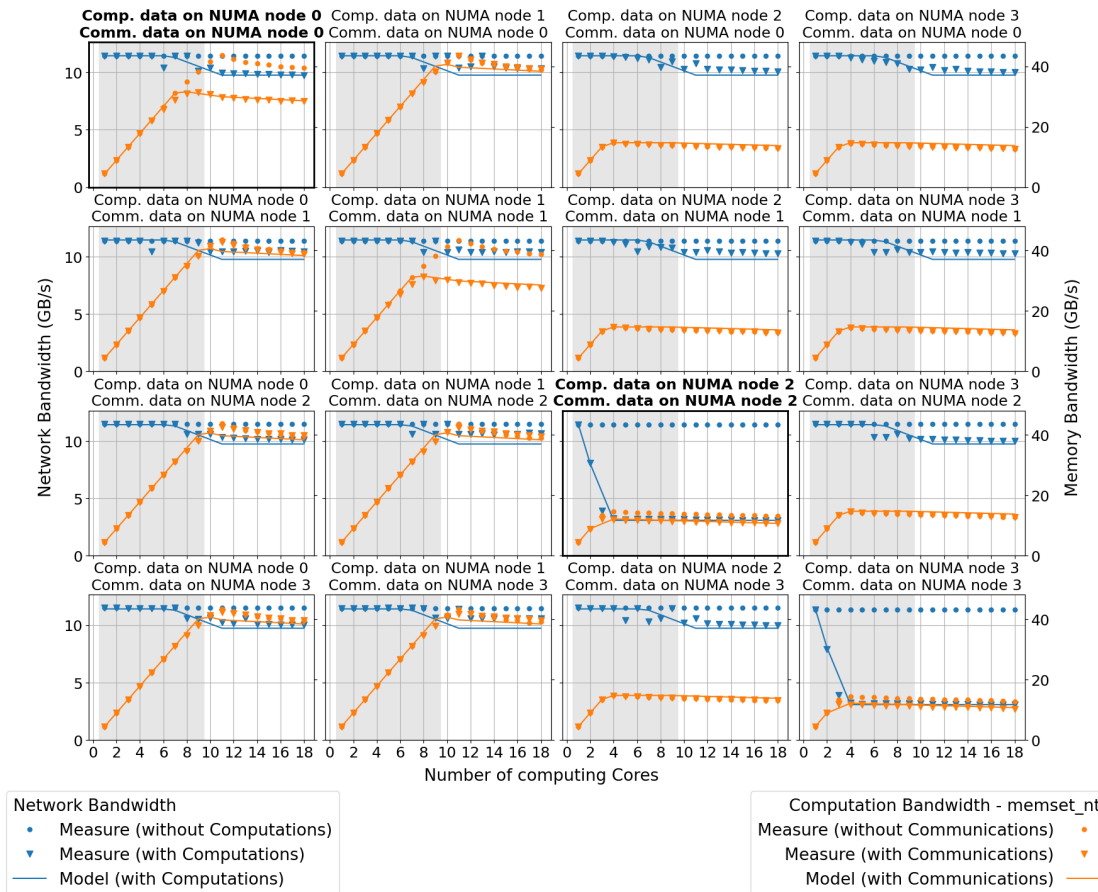

Figure 4: Performances of computations and communications along with our model prediction on henri-subnuma (INTEL, INFINIBAND).

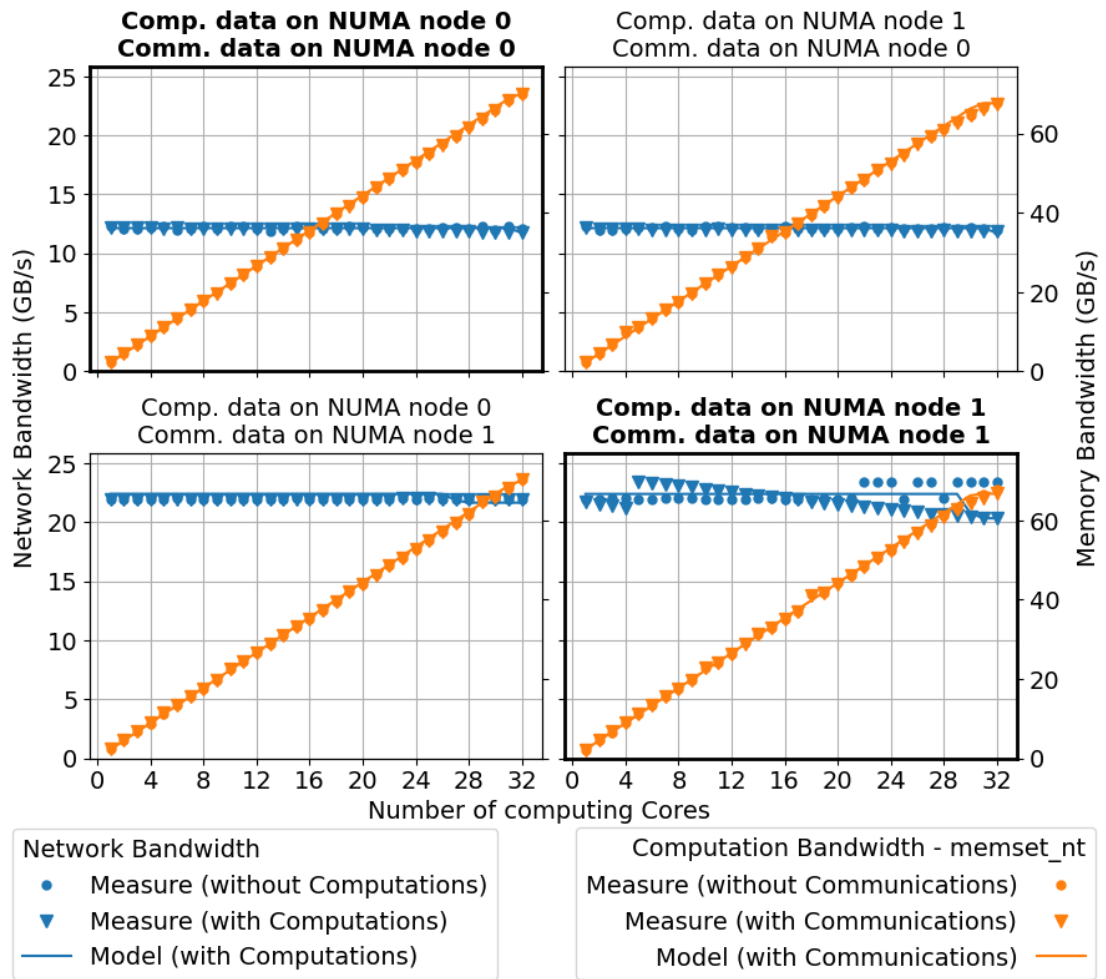

Figure 5: Performances of computations and communications along with our model prediction on diablo (AMD, INFINIBAND).

**billy** Figure 6 depicts results on the **billy** platform, similar to **diablo**. The network performance is still sensible to placement, but is more chaotic; the model fails to capture the variability, but follows the general trend of observations.

**occigen** Figure 7 shows results on the only production platform of our testbed. On this ancient platform (2014-2022), only computations are impacted when computations and communications do both remote memory accesses. This platform is where our model is the most accurate, with the lowest prediction error (see further).

**pyxis** Figure 8 shows results on a platform with ARM processors. Our model predicts correctly performance of computations, although it does not catch that memory bandwidth for computations does not scale well when it gets closer to the threshold. Network performances are not correctly predicted for placement configurations which were not used to instantiate the model. On this architecture, the network performances seem to be more complicated to predict by just relying on the locality of the data.

**bora, dahu, grvingt** Model predictions for platforms equipped with similar hardware (INTEL processor and OMNI-PATH network) give as expected similar results, as can be seen on figures 9, 10 and 11.

Table 2 reports the prediction error on all platforms. The error is estimated with the mean absolute percentage error ( $\frac{100\%}{n} \sum_{k=1}^n \left| \frac{a_k - p_k}{a_k} \right|$ ), for predictions of computations and communications separately, by distinguishing also predictions made by the model on a placement configuration used to instantiate the model (*samples*) or not (*non-samples*). Regarding communications, the highest prediction error on all configurations is on **billy** (8.22 % on sample configurations, 10.84 % on others), explainable by the high variability of network performances, even when communications are executed alone, not taken into account by our model. The prediction error is also high on **pyxis**, especially on non-sample configurations (13.32 %), caused by the wrong appreciation of locality impact on this architecture, as discussed above. On other platforms, the average of prediction error of network bandwidth on all placement configurations is below 6%. Performances of computations are better predicted, with an overall error lower than 4%. Worst cases are on **billy** (3.69 %) and **grvingt** (3.46 %), where the model tends to over-estimate the bandwidth for computations because it assumes a perfect scaling when the number of computing cores increases, but in reality computing cores start to contention before reaching the bandwidth threshold.

## 4.3 Discussion

Results presented above show our model is valid to predict memory bandwidth allocated to communications and to computations: from sample executions on two different placement configurations to instantiate the whole model, we are able to predict bandwidths with all possible placement configurations, with an overall prediction error lower than 4%. Higher prediction errors come most often from unstable input data, nonetheless the model formulation allows us to better understand in which circumstances memory contention happens and how the hardware deals with it.

### 4.3.1 Model limits

Even though our model makes overall good predictions, there are some corner cases where it show its limits. It has difficulties to accurately predict network bandwidth if network perfor-

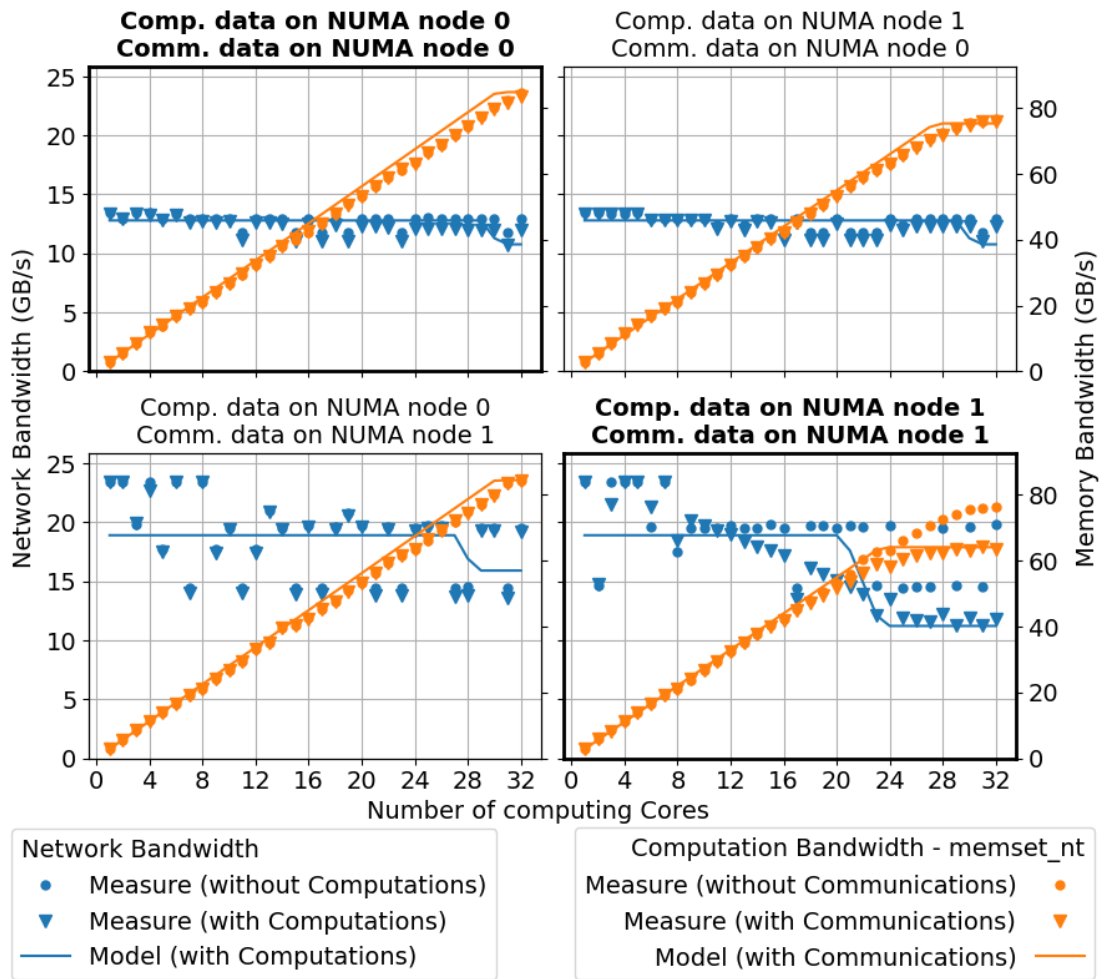

Figure 6: Performances of computations and communications along with our model prediction on billy (AMD, INFINIBAND).

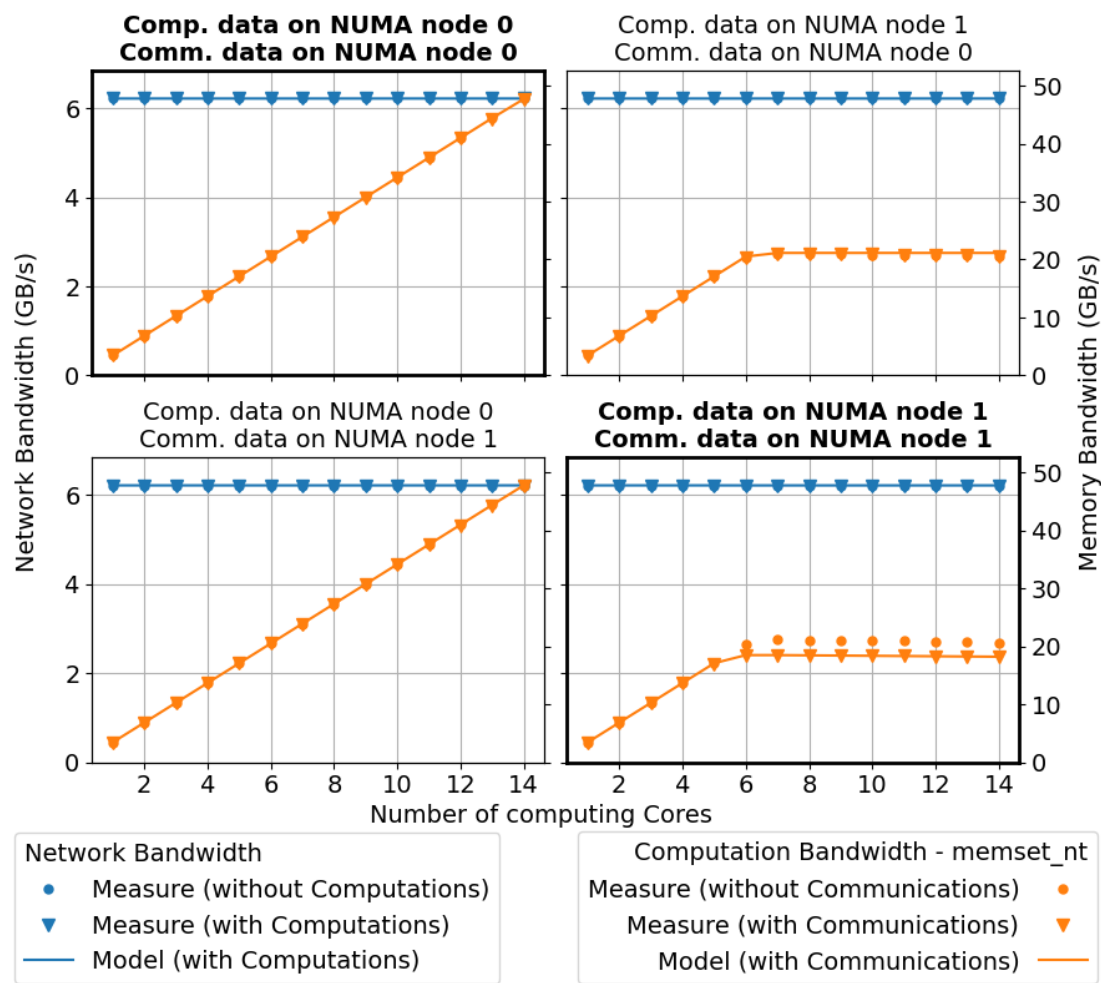

Figure 7: Performances of computations and communications along with our model prediction on occigen (INTEL, INFINIBAND).

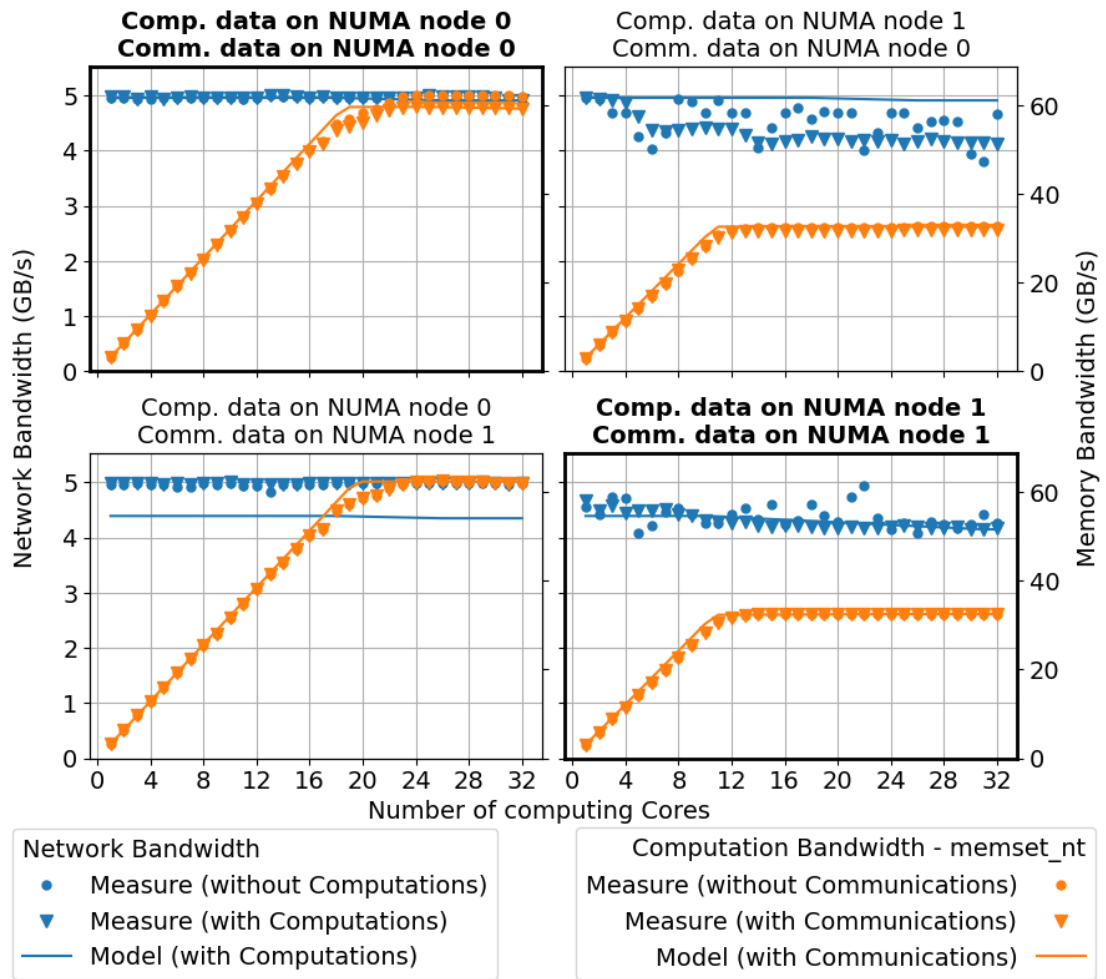

Figure 8: Performances of computations and communications along with our model prediction on pyxis (ARM, INFINIBAND).

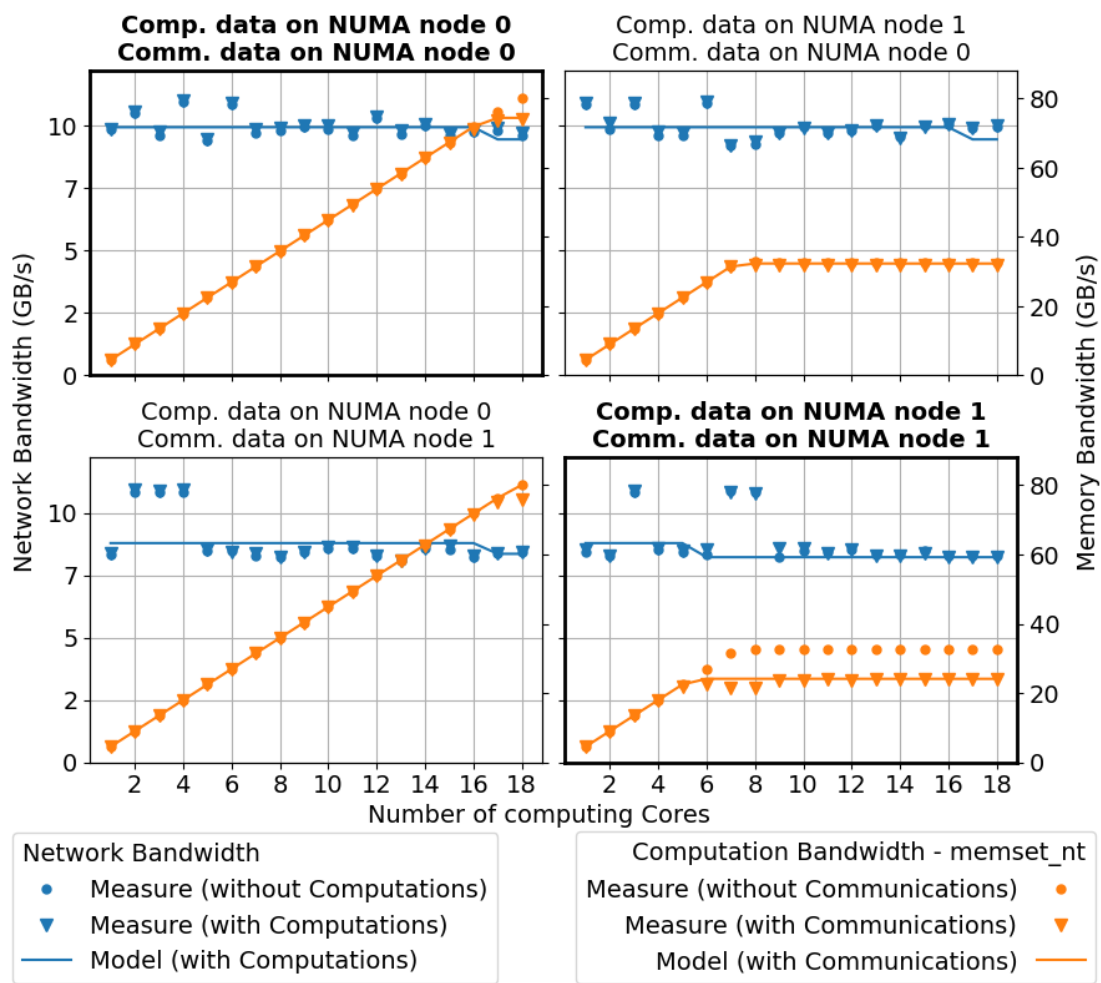

Figure 9: Performances of computations and communications along with our model prediction on bora (INTEL, OMNI-PATH).



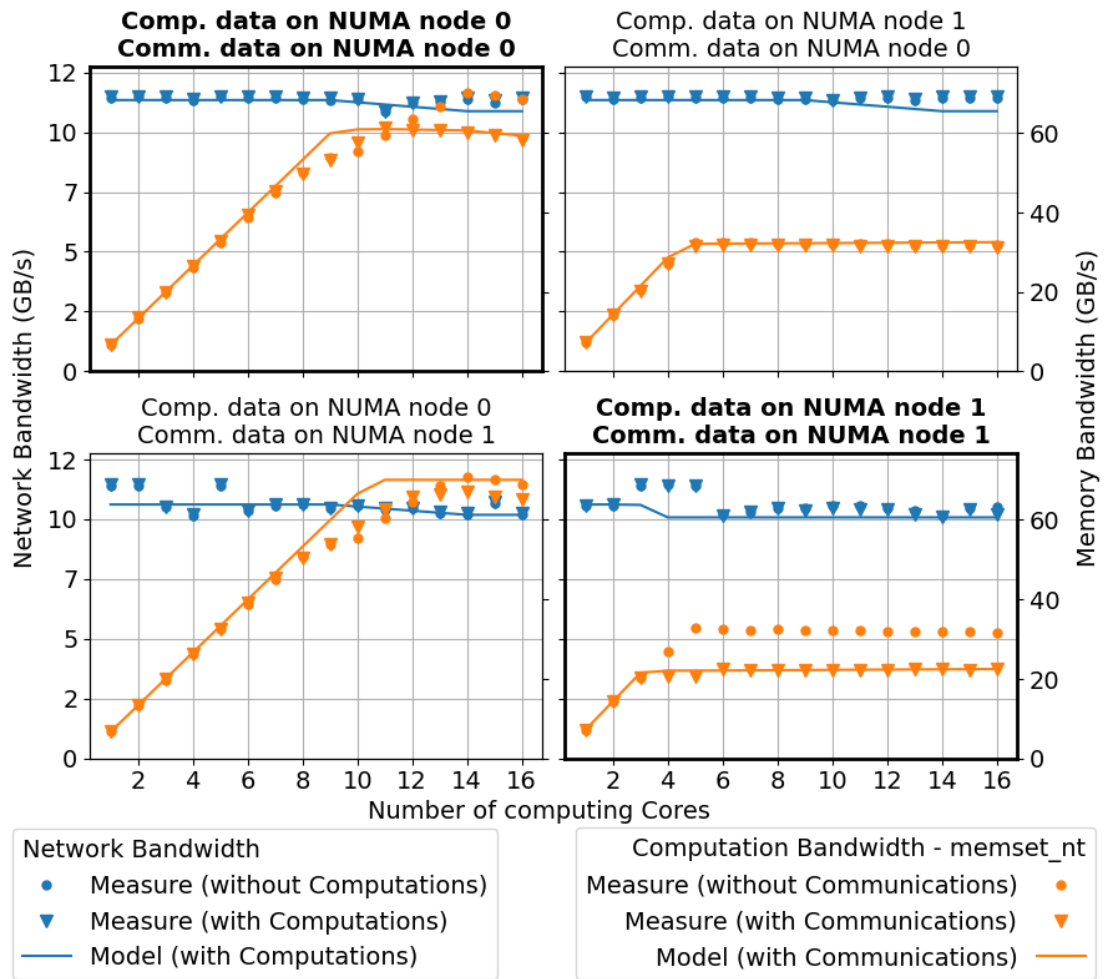

Figure 10: Performances of computations and communications along with our model prediction on dahu (INTEL, OMNI-PATH).

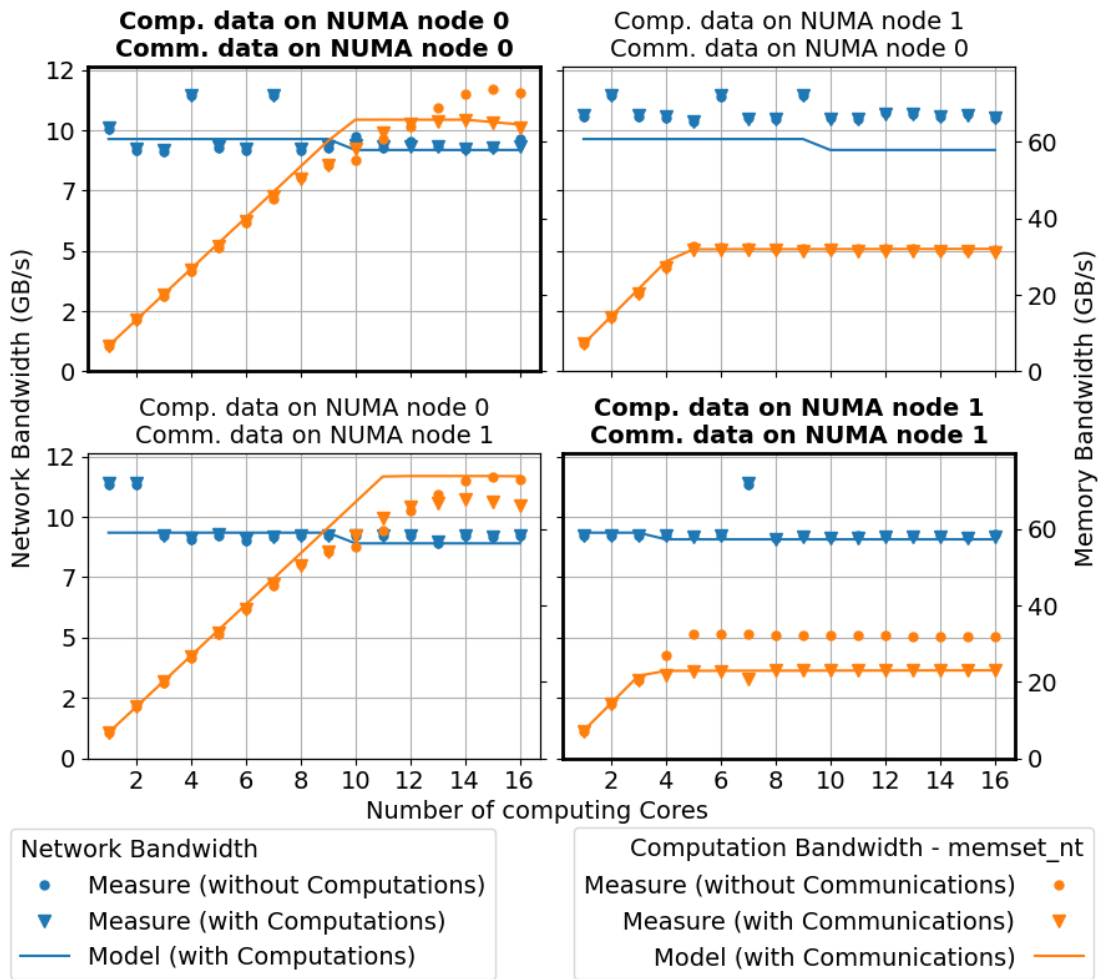

Figure 11: Performances of computations and communications along with our model prediction on grvngt (INTEL, OMNI-PATH).

| Platform       | Communications    |                       |               | Computations      |                       |               | Average       |
|----------------|-------------------|-----------------------|---------------|-------------------|-----------------------|---------------|---------------|
|                | <i>on Samples</i> | <i>on non-Samples</i> | <i>all</i>    | <i>on Samples</i> | <i>on non-Samples</i> | <i>all</i>    |               |
| henri          | 2.62 %            | 3.53 %                | 3.08 %        | 0.80 %            | 2.34 %                | 1.57 %        | 2.32 %        |
| henri-subnuma  | 2.90 %            | 3.80 %                | 3.69 %        | 1.89 %            | 3.66 %                | 3.44 %        | 3.56 %        |
| bora           | 4.39 %            | 5.14 %                | 4.77 %        | 1.34 %            | 0.78 %                | 1.06 %        | 2.91 %        |
| dahu           | 2.76 %            | 2.38 %                | 2.57 %        | 2.00 %            | 3.85 %                | 2.92 %        | 2.74 %        |
| diablo         | 2.32 %            | 1.54 %                | 1.93 %        | 0.92 %            | 0.99 %                | 0.95 %        | 1.44 %        |
| grvingt        | 3.41 %            | 8.06 %                | 5.74 %        | 2.44 %            | 4.48 %                | 3.46 %        | 4.60 %        |
| pyxis          | 1.15 %            | 13.32 %               | 7.24 %        | 1.95 %            | 2.79 %                | 2.37 %        | 4.80 %        |
| occigen        | 0.01 %            | 0.01 %                | 0.01 %        | 0.22 %            | 0.58 %                | 0.40 %        | 0.20 %        |
| <b>Average</b> | <b>3.09 %</b>     | <b>5.40 %</b>         | <b>4.28 %</b> | <b>1.73 %</b>     | <b>2.54 %</b>         | <b>2.21 %</b> | <b>3.24 %</b> |

Table 2: Model errors on testbed platforms.

mances are not stable even without contention (see for instance results on `billy`, `pyxis`, `bora` or `grvingt`). On systems where data locality can highly influence network performances (such as `diablo`, `billy`, `pyxis` or `bora`), the model can be wrong more often, especially on placement configurations not used to instantiate the model. These weaknesses are not related to modeling of contention, since the odd network performances are also hard to predict with communications executed alone. Being able to model network performances in all placement configurations, when communications are executed alone, would help to improve our model, to predict network bandwidth in case of contention.

On machines with many NUMA nodes (more than 4; for instance, `billy` can be configured with 8 NUMA nodes – 4 per processor), network performances under memory contention depend on data locality and the heuristic given by formula 7 is not sufficiently accurate anymore. Moreover, when communications and computations use the same NUMA node for their data (*i.e.* when contention has the most impact), the distribution of memory bandwidth between computations and communications before the threshold is reached (first cases of equations 3 and 4) is, in our model, more in favour of computations as in reality. Thus, these more complex system topologies would require more precise hypotheses to model them accurately. Moreover, evaluating the model on all placement configurations (64 with 8 NUMA nodes!) is more difficult due to necessary time to execute benchmarks on all configurations (about one hour per configuration).

The model predictions are only valid for the parameters of the benchmarks used to instantiate the model: the computation kernels executed by computing cores and the message size used by communications. For different computation kernels and message sizes, memory contention can be different and thus model parameters as well. However, since the computation kernels and message size were chosen here to maximize the contention, other kernels or message size should produce less contention, but the insights provided by our model in the worst case should still be valid.

### 4.3.2 Lessons learned

Distinguishing location of data used for computations and for communications allows to change paths of the two different data streams in the memory system and thus better locate bottlenecks, where memory contention occurs. First hypotheses assume contention happens in memory controller (controlling a NUMA node) or in inter-processor link. Results on machines with 2 NUMA

nodes show contention occurs when data for communications and computations are located on the same NUMA node, especially on the same *remote* NUMA node (*i.e.* data streams have to go through inter-processor link and memory controller). When communications and computations use each their own NUMA node for their data, memory contention is very low (when not null). Results on machines with 4 NUMA nodes (2 *local* and 2 *remote* nodes, for instance on `henri-subnuma`), refine the location of the bottleneck: when computations and communications do both remote accesses (data streams have to go through the inter-socket link), performances are the most impacted due to contention when they use the same remote NUMA node. Thus, **the place where the most contention occurs is memory controller, and not the inter-socket link.**

The hypotheses made to design the model, and validated with experiments, teach us **memory bandwidth for network communications is the first reduced** in case of memory contention, to preserve memory bandwidth dedicated to computations. However, a **minimum bandwidth is always assured for network**, to prevent starvations. When this minimum bandwidth is reached, bandwidth for computations starts to decrease to fit memory system capacity.

## 5 Related works

Our previous work [1] focused on the different factors impacting the memory contention between computations and communications: data and thread placement, message size and arithmetic intensity of computing kernels. At that time, we only reported the results of our observations, without any attempt to model the phenomenon.

Since literature about contention between computations and communications is pretty rare, works about its model is even more sparse.

A theoretical model of the memory bandwidth sharing between computing and communicating threads was made by LANGGUTH *et al.* [12]. Although they considered communications and computations are executed simultaneously, in their model, when communications end before computation, computation gets again all the available bandwidth and *vice-versa* when computation ends before communications. We rather focus on the steady state when there are always computations and communications in parallel, by considering bandwidths instead of durations. Moreover our model is more low-level, by considering the data placement on the machine topology and the number of computing cores.

Works presented in the rest of this section did not consider communications, but were helpful to better understand the memory system, and the possibilities to model its behaviour, especially under contention.

Queuing theory is often used [4, 5] to model memory contention. Each queue can represent one contention point, and assembling them can describe the general behaviour of the whole memory system. Model parameters are derived from hardware counters, read while executing applications. This kind of model fits well with homogeneous queue consumers (computing cores, caches, memory controllers), but is more difficult to use in our context, as explained in section 2.4.

WANG *et al.* presented [13] the possible bottlenecks in the memory system to model them with Integer Programming, to find the optimal number of cores to execute memory-bound applications, especially on NUMA systems.

MAJO and GROSS studied [14] the behaviour of memory controllers in charge of serving local and remote memory accesses. They distinguished the local memory bandwidth (of the local memory controller) and the remote memory bandwidth (of the QPI bus) and modeled the maximum available bandwidth as a pondered sum of the two bandwidths, by introducing a

*sharing-factor*. The evolution of this factor depending on the number of computing cores helps to understand how the memory controller manages its queuing fairness between different types of memory requests.

GOODMAN *et al.* presented [15] PANDIA, a framework to predict performances of other configurations (number of threads and their placement) of parallel applications. From a machine description and 6 well-chosen application runs, they have all required information to make accurate predictions, by knowing the bandwidth capacity of the different memory buses. They take into account parallel fraction, memory accesses, load balancing and computing resource demands of applications, and rely on hardware counters to get these information.

All in all, our work sets oneself apart by modeling memory bandwidths available for computations and communications, when they are executed simultaneously. We expand our model to predict memory bandwidths according to location of memory used for computations or communications. We instantiate our model without consulting hardware counters, by executing only two benchmarks.

## 6 Conclusion

Computations and communications in parallel distributed HPC applications can be executed in parallel to save execution time. With memory-bound computations and network exchanges with large messages, contention can occur in the memory system, reducing performances of both computations and communications.

In this paper, we proposed a model to predict memory bandwidth allocated for computations and communications when they are executed in parallel. Predictions are made from parameters describing behaviour of the memory system with two data placement configurations. From these parameters, the topology description of the machine and information about data locality, our model is able to predict memory bandwidth for computations and for communications, regardless on which NUMA node data are located, with an average prediction error lower than 4 %.

Building this model allows to better understand that memory contention is the most severe when computations and communications use data located on the same NUMA, bottleneck causing this contention is mainly located in the NUMA node controller, rather than in the inter-socket connection bus. In case of contention, the system first degrades memory bandwidth allocated to communications, but ensures a minimum, and then reduces computation bandwidth if necessary.

As future works, we would like to improve our model to better deal with the impact of data locality and study the consequences on the model if we relax its constraints: for instance if application performs communications with bidirectional data movements (*i.e.* *ping-pongs* instead of only *pongs*), as well as similar computing kernels (*e.g.* copying an array into another instead of just initializing an array with a single value). We also would like to take into account the last level cache into our model. Future works also include exploiting indications provided by the model: runtime systems could better know on which NUMA node store data and how many computing cores should be used to avoid memory contention.

**Software Availability** We endeavor to make our experiments reproducible. A public companion<sup>2</sup> contains the instructions to reproduce our study.

<sup>2</sup><https://gitlab.inria.fr/pswartzva/paper-model-memory-contention-r13y>, archived on <https://www.softwareheritage.org/> with the ID `swh:1:snp:306f7c10cf69a5860587e5aad62b76070b798ecd`

## Author contributions

**Alexandre DENIS:** Conceptualization, Methodology, Resources, Writing - Original Draft.

**Emmanuel JEANNOT:** Conceptualization, Supervision, Writing - Original Draft

**Philippe SWARTVAGHER:** Software, Data Curation, Investigation, Methodology, Visualization, Writing - Original Draft.

## Acknowledgment

This work is supported by the Agence Nationale de la Recherche, under grant ANR-19-CE46-0009.

This work is supported by the Région Nouvelle-Aquitaine, under grant 2018-1R50119 *HPC scalable ecosystem*.

Experiments presented in this paper were carried out using the PlaFRIM experimental testbed, supported by Inria, CNRS (LABRI and IMB), Université de Bordeaux, Bordeaux INP and Conseil Régional d'Aquitaine (see <https://www.plafrim.fr/>).

This work was granted access to the HPC resources of CINES under the allocation 2021-A0100601567 attributed by GENCI (Grand Equipement National de Calcul Intensif).

Experiments presented in this paper were carried out using the Grid'5000 testbed, supported by a scientific interest group hosted by Inria and including CNRS, RENATER and several Universities as well as other organizations (see <https://www.grid5000.fr>).

The authors furthermore thank Brice GOGLIN and Guillaume PALLEZ for their help and advice regarding this work.

## References

- [1] A. Denis, E. Jeannot, and P. Swartvagher, "Interferences between Communications and Computations in Distributed HPC Systems," in *ICPP 2021 - 50th International Conference on Parallel Processing*, Chicago / Virtual, United States, Aug. 2021, p. 11.
- [2] D. Chandra, F. Guo, S. Kim, and Y. Solihin, "Predicting inter-thread cache contention on a chip multi-processor architecture," in *11th International Symposium on High-Performance Computer Architecture*, 2005.
- [3] D. Andrade, B. B. Fraguera, and R. Doallo, "Accurate prediction of the behavior of multithreaded applications in shared caches," *Parallel Comput.*, vol. 39, no. 1, p. 36–57, jan 2013.
- [4] Y. Cho, S. Oh, and B. Egger, "Performance modeling of parallel loops on multi-socket platforms using queueing systems," *IEEE Transactions on Parallel and Distributed Systems*, vol. 31, no. 2, pp. 318–331, 2020.
- [5] B. M. Tudor, Y. M. Teo, and S. See, "Understanding off-chip memory contention of parallel programs in multicore systems," in *2011 International Conference on Parallel Processing*, 2011, pp. 602–611.
- [6] O. Aumage, E. Brunet, N. Furmento, and R. Namyst, "NewMadeleine: a Fast Communication Scheduling Engine for High Performance Networks," in *Workshop on Communication Architecture for Clusters (CAC 2007)*, Long Beach, California, United States, Mar. 2007.

- [7] E. Agullo, O. Aumage, M. Faverge, N. Furmento, F. Pruvost, M. Sergent, and S. Thibault, “Achieving High Performance on Supercomputers with a Sequential Task-based Programming Model,” *IEEE Transactions on Parallel and Distributed Systems*, 2017.
- [8] G. Bosilca, A. Bouteiller, A. Danalis, T. Herault, P. Lemarinier, and J. Dongarra, “Dague: A generic distributed dag engine for high performance computing,” in *2011 IEEE International Symposium on Parallel and Distributed Processing Workshops and Phd Forum*, 2011.
- [9] T. Hoefer and A. Lumsdaine, “Message progression in parallel computing - to thread or not to thread?” in *2008 IEEE International Conference on Cluster Computing*, Sep. 2008, pp. 213–222.
- [10] G. Hager, G. Schubert, T. Schoenemeyer, and G. Wellein, “Prospects for truly asynchronous communication with pure MPI and hybrid MPI/OpenMP on current supercomputing platforms,” 01 2011.
- [11] F. Broquedis, J. Clet-Ortega, S. Moreaud, N. Furmento, B. Goglin, G. Mercier, S. Thibault, and R. Namyst, “hwloc: a Generic Framework for Managing Hardware Affinities in HPC Applications,” in *PDP 2010 - The 18th Euromicro International Conference on Parallel, Distributed and Network-Based Computing*, IEEE, Ed., Pisa, Italy, Feb. 2010.
- [12] J. Langguth, X. Cai, and M. Sourouri, “Memory Bandwidth Contention: Communication vs Computation Tradeoffs in Supercomputers with Multicore Architectures,” in *2018 IEEE 24th International Conference on Parallel and Distributed Systems (ICPADS)*, 2018, pp. 497–506.
- [13] W. Wang, J. W. Davidson, and M. L. Soffa, “Predicting the memory bandwidth and optimal core allocations for multi-threaded applications on large-scale numa machines,” in *2016 IEEE International Symposium on High Performance Computer Architecture (HPCA)*, 2016.
- [14] Z. Majo and T. R. Gross, “Memory system performance in a numa multicore multiprocessor,” in *Proceedings of the 4th Annual International Conference on Systems and Storage*, ser. SYSTOR '11. New York, NY, USA: Association for Computing Machinery, 2011.
- [15] D. Goodman, G. Varisteas, and T. Harris, “Pandia: Comprehensive contention-sensitive thread placement,” in *Proceedings of the Twelfth European Conference on Computer Systems*, ser. EuroSys '17. New York, NY, USA: Association for Computing Machinery, 2017, p. 254–269.

## A Algorithms

---

**Algorithm 1** Predict total memory bandwidth (implementation of equation 1)

---

**Inputs:**  $N_{par}^{max}$ ,  $T_{par}^{max}$ ,  $N_{seq}^{max}$ ,  $N_{par}^{max}$ ,  $T_{par}^{max2}$ ,  $\delta_l$ ,  $\delta_r$

**Output:**  $\mathcal{T}$

```

1: function PREDICTTOTAL
2:    $\mathcal{T} \leftarrow []$ 
3:   for  $i = 1$  to  $number\_cores$  do
4:     if  $i \leq N_{par}^{max}$  then
5:        $\mathcal{T}[i] \leftarrow T_{par}^{max}$ 
6:     else if  $i \leq N_{seq}^{max}$  then
7:        $\mathcal{T}[i] \leftarrow T_{par}^{max} - \delta_l \times (i - N_{par}^{max})$ 
8:     else
9:        $\mathcal{T}[i] \leftarrow T_{par}^{max2} - \delta_r \times (i - N_{seq}^{max})$ 
10:    end if
11:  end for
12: end function

```

---



---

**Algorithm 2** Compute memory bandwidths available for computations and communications (implementation of equations 2, 3, 4, 5 and 6)

---

**Inputs:**  $\mathcal{T}$ ,  $B_{seq}^{comp}$ ,  $T_{seq}^{max}$ ,  $N_{seq}^{max}$ ,  $N_{par}^{max}$ ,  $B_{seq}^{comm}$ ,  $\alpha$   
**Outputs:**  $\mathcal{B}_{par}^{comp}$ ,  $\mathcal{B}_{par}^{comm}$ ,  $\mathcal{B}_{seq}^{comp}$

- 1: **function** PREDICTBANDWIDTHS
- 2:      $\mathcal{B}_{par}^{comm} \leftarrow []$
- 3:      $\mathcal{B}_{par}^{comp} \leftarrow []$
- 4:      $\mathcal{B}_{seq}^{comp} \leftarrow []$
- 5:      $\beta_v \leftarrow None$
- 6:      $\beta_i \leftarrow None$
- 7:     **for**  $i = 1$  **to**  $number\_cores$  **do**
- 8:          $\mathcal{B}_{seq}^{comp}[i] \leftarrow \min(B_{seq}^{comp} \times i, \mathcal{T}[i], T_{seq}^{max})$  ▷ Equation 6
- 9:         **if**  $i \times B_{seq}^{comp} + \alpha \times B_{seq}^{comm} < \mathcal{T}[i]$  **then** ▷ Equation 2
- 10:              $\mathcal{B}_{par}^{comp}[i] \leftarrow i \times B_{seq}^{comp}$  ▷ Equation 3
- 11:              $\mathcal{B}_{par}^{comm}[i] \leftarrow \min(\mathcal{T}[i] - \mathcal{B}_{par}^{comp}[i], B_{seq}^{comm})$  ▷ Equation 4
- 12:              $\beta_v \leftarrow \mathcal{B}_{par}^{comm}[i] / B_{seq}^{comm}$
- 13:              $\beta_i \leftarrow i$
- 14:         **else**
- 15:              $\alpha_i \leftarrow \alpha$  ▷ Equation 5
- 16:             **if**  $(N_{seq}^{max} - N_{par}^{max}) > 1$  **and**  $i < N_{seq}^{max}$  **then**
- 17:                  $\delta_c \leftarrow (\beta_v - \alpha) / (N_{seq}^{max} - \beta_i)$
- 18:                  $\alpha_i \leftarrow \beta_v - \delta_c \times (i - \beta_i)$
- 19:             **end if**
- 20:              $\mathcal{B}_{par}^{comm}[i] \leftarrow \alpha_i \times B_{seq}^{comm}$  ▷ Equation 4
- 21:              $\mathcal{B}_{par}^{comp}[i] \leftarrow \mathcal{T}[i] - \mathcal{B}_{par}^{comm}[i]$  ▷ Equation 3
- 22:         **end if**
- 23:     **end for**
- 24: **end function**

---

---

**Algorithm 3** Predict communication performances according to memory placements (implementation of equation 7)

---

**Inputs:**  $m_{comp}$ ,  $m_{comm}$ ,  $\mathcal{M}_{local}$ ,  $\mathcal{M}_{remote}$   
**Outputs:**  $\mathcal{B}_{par}^{comm}$

```

1: function GETCOMMBANDWIDTHS
2:   if  $m_{comp} == m_{comm}$  and  $m_{comp} \geq \#m$  then
3:      $\mathcal{B}_{par}^{comp}, \mathcal{B}_{par}^{comm}, \mathcal{B}_{seq}^{comp} \leftarrow \text{PREDICTBANDWIDTHS}(\mathcal{M}_{remote})$ 
4:     return  $\mathcal{B}_{par}^{comm}$ 
5:   else
6:     if  $m_{comm} \geq \#m$  then
7:        $\mathcal{B}_{par}^{comp}, \mathcal{B}_{par}^{comm}, \mathcal{B}_{seq}^{comp} \leftarrow \text{PREDICTBANDWIDTHS}(\mathcal{M}_{local},$ 
            $\mathcal{B}_{seq}^{comm} \leftarrow \mathcal{B}_{seq}^{comm}(\mathcal{M}_{remote})$   $\triangleright$  Use  $\mathcal{B}_{seq}^{comm}$  from  $\mathcal{M}_{remote}$  in the function
            $)$ 
8:       return  $\mathcal{B}_{par}^{comm}$ 
9:     else
10:       $\mathcal{B}_{par}^{comp}, \mathcal{B}_{par}^{comm}, \mathcal{B}_{seq}^{comp} \leftarrow \text{PREDICTBANDWIDTHS}(\mathcal{M}_{local})$ 
11:      return  $\mathcal{B}_{par}^{comm}$ 
12:    end if
13:  end if
14: end function

```

---



---

**Algorithm 4** Predict computation performances according to memory placements (implementation of equation 8)

---

**Inputs:**  $m_{comp}$ ,  $m_{comm}$ ,  $\mathcal{M}_{local}$ ,  $\mathcal{M}_{remote}$   
**Outputs:**  $\mathcal{B}_{par}^{comp}$

```

1: function GETCOMPBANDWIDTHS
2:   if  $m_{comp} < \#m$  then
3:      $\mathcal{B}_{par}^{comp}, \mathcal{B}_{par}^{comm}, \mathcal{B}_{seq}^{comp} \leftarrow \text{PREDICTBANDWIDTHS}(\mathcal{M}_{local})$ 
4:     if  $m_{comp} == m_{comm}$  then
5:       return  $\mathcal{B}_{par}^{comp}$ 
6:     else
7:       return  $\mathcal{B}_{seq}^{comp}$ 
8:     end if
9:   else
10:     $\mathcal{B}_{par}^{comp}, \mathcal{B}_{par}^{comm}, \mathcal{B}_{seq}^{comp} \leftarrow \text{PREDICTBANDWIDTHS}(\mathcal{M}_{remote})$ 
11:    if  $m_{comp} == m_{comm}$  then
12:      return  $\mathcal{B}_{par}^{comp}$ 
13:    else
14:      return  $\mathcal{B}_{seq}^{comp}$ 
15:    end if
16:  end if
17: end function

```

---

## B Model parameter values

| Parameter        |                             | $\mathcal{M}_{local}$ | $\mathcal{M}_{remote}$ |
|------------------|-----------------------------|-----------------------|------------------------|
| $N_{par}^{max}$  | (number of computing cores) | 32                    | 32                     |
| $T_{par}^{max}$  | (MB/s)                      | 95555.5               | 75276.9                |
| $N_{seq}^{max}$  | (number of computing cores) | 32                    | 32                     |
| $T_{seq}^{max}$  | (MB/s)                      | 84420.4               | 76466.4                |
| $T_{par}^{max2}$ | (MB/s)                      | 95555.5               | 75276.9                |
| $\alpha$         |                             | 0.842                 | 0.593                  |
| $\delta_l$       | (MB/s/core)                 | 0.0                   | 0.0                    |
| $\delta_r$       | (MB/s/core)                 | 0.0                   | 0.0                    |
| $B_{seq}^{comp}$ | (MB/s)                      | 2808.8                | 2746.5                 |
| $B_{seq}^{comm}$ | (MB/s)                      | 12793.0               | 18898.9                |

Table 3: Parameter values for executions on billy

| Parameter        |                             | $\mathcal{M}_{local}$ | $\mathcal{M}_{remote}$ |
|------------------|-----------------------------|-----------------------|------------------------|
| $N_{par}^{max}$  | (number of computing cores) | 18                    | 8                      |
| $T_{par}^{max}$  | (MB/s)                      | 83849.6               | 32315.3                |
| $N_{seq}^{max}$  | (number of computing cores) | 18                    | 8                      |
| $T_{seq}^{max}$  | (MB/s)                      | 80107.7               | 32733.3                |
| $T_{par}^{max2}$ | (MB/s)                      | 83849.6               | 32315.3                |
| $\alpha$         |                             | 0.951                 | 0.936                  |
| $\delta_l$       | (MB/s/core)                 | 0.0                   | 0.0                    |
| $\delta_r$       | (MB/s/core)                 | 0.0                   | 1.6                    |
| $B_{seq}^{comp}$ | (MB/s)                      | 4489.2                | 4487.6                 |
| $B_{seq}^{comm}$ | (MB/s)                      | 9948.4                | 8784.7                 |

Table 4: Parameter values for executions on bora

| Parameter        |                             | $\mathcal{M}_{local}$ | $\mathcal{M}_{remote}$ |
|------------------|-----------------------------|-----------------------|------------------------|
| $N_{par}^{max}$  | (number of computing cores) | 11                    | 5                      |
| $T_{par}^{max}$  | (MB/s)                      | 72147.6               | 32102.5                |
| $N_{seq}^{max}$  | (number of computing cores) | 14                    | 5                      |
| $T_{seq}^{max}$  | (MB/s)                      | 70072.9               | 32677.4                |
| $T_{par}^{max2}$ | (MB/s)                      | 71509.2               | 32102.5                |
| $\alpha$         |                             | 0.959                 | 0.949                  |
| $\delta_l$       | (MB/s/core)                 | 212.8                 | 0.0                    |
| $\delta_r$       | (MB/s/core)                 | 656.8                 | -38.4                  |
| $B_{seq}^{comp}$ | (MB/s)                      | 6656.5                | 7171.3                 |
| $B_{seq}^{comm}$ | (MB/s)                      | 11341.2               | 10607.0                |

Table 5: Parameter values for executions on dahu

| Parameter                                   | $\mathcal{M}_{local}$ | $\mathcal{M}_{remote}$ |
|---|-----------------------|------------------------|
| $N_{par}^{max}$ (number of computing cores) | 32                    | 32                     |
| $T_{par}^{max}$ (MB/s)                      | 81846.8               | 87081.5                |
| $N_{seq}^{max}$ (number of computing cores) | 32                    | 32                     |
| $T_{seq}^{max}$ (MB/s)                      | 70092.1               | 67694.6                |
| $T_{par}^{max2}$ (MB/s)                     | 81846.8               | 87081.5                |
| $\alpha$                                    | 0.967                 | 0.908                  |
| $\delta_l$ (MB/s/core)                      | 0.0                   | 0.0                    |
| $\delta_r$ (MB/s/core)                      | 0.0                   | 0.0                    |
| $B_{seq}^{comp}$ (MB/s)                     | 2221.1                | 2210.2                 |
| $B_{seq}^{comm}$ (MB/s)                     | 12139.7               | 22394.3                |

Table 6: Parameter values for executions on diablo

| Parameter                                   | $\mathcal{M}_{local}$ | $\mathcal{M}_{remote}$ |
|---|-----------------------|------------------------|
| $N_{par}^{max}$ (number of computing cores) | 14                    | 5                      |
| $T_{par}^{max}$ (MB/s)                      | 75015.2               | 31928.2                |
| $N_{seq}^{max}$ (number of computing cores) | 15                    | 5                      |
| $T_{seq}^{max}$ (MB/s)                      | 73818.4               | 32576.8                |
| $T_{par}^{max2}$ (MB/s)                     | 74398.4               | 31928.2                |
| $\alpha$                                    | 0.953                 | 0.971                  |
| $\delta_l$ (MB/s/core)                      | 616.8                 | 0.0                    |
| $\delta_r$ (MB/s/core)                      | 649.2                 | -10.6                  |
| $B_{seq}^{comp}$ (MB/s)                     | 6698.7                | 7178.5                 |
| $B_{seq}^{comm}$ (MB/s)                     | 9628.8                | 9345.7                 |

Table 7: Parameter values for executions on grvingt

| Parameter                                   | $\mathcal{M}_{local}$ | $\mathcal{M}_{remote}$ |
|---|-----------------------|------------------------|
| $N_{par}^{max}$ (number of computing cores) | 17                    | 5                      |
| $T_{par}^{max}$ (MB/s)                      | 73423.0               | 31629.7                |
| $N_{seq}^{max}$ (number of computing cores) | 18                    | 7                      |
| $T_{seq}^{max}$ (MB/s)                      | 72589.9               | 29130.7                |
| $T_{par}^{max2}$ (MB/s)                     | 73387.7               | 31278.1                |
| $\alpha$                                    | 0.915                 | 0.761                  |
| $\delta_l$ (MB/s/core)                      | 35.3                  | 175.8                  |
| $\delta_r$ (MB/s/core)                      | 0.0                   | 119.8                  |
| $B_{seq}^{comp}$ (MB/s)                     | 4455.4                | 4455.2                 |
| $B_{seq}^{comm}$ (MB/s)                     | 11481.1               | 11459.6                |

Table 8: Parameter values for executions on henri

| Parameter                                   | $\mathcal{M}_{local}$ | $\mathcal{M}_{remote}$ |
|---|-----------------------|------------------------|
| $N_{par}^{max}$ (number of computing cores) | 8                     | 11                     |
| $T_{par}^{max}$ (MB/s)                      | 42487.7               | 16936.1                |
| $N_{seq}^{max}$ (number of computing cores) | 11                    | 4                      |
| $T_{seq}^{max}$ (MB/s)                      | 43655.6               | 14726.2                |
| $T_{par}^{max2}$ (MB/s)                     | 39718.9               | 15217.8                |
| $\alpha$                                    | 0.853                 | 0.270                  |
| $\delta_l$ (MB/s/core)                      | 922.9                 | 859.1                  |
| $\delta_r$ (MB/s/core)                      | 191.7                 | 103.3                  |
| $B_{seq}^{comp}$ (MB/s)                     | 4456.4                | 4455.4                 |
| $B_{seq}^{comm}$ (MB/s)                     | 11450.4               | 11410.0                |

Table 9: Parameter values for executions on `henri-subnuma`

| Parameter                                   | $\mathcal{M}_{local}$ | $\mathcal{M}_{remote}$ |
|---|-----------------------|------------------------|
| $N_{par}^{max}$ (number of computing cores) | 14                    | 7                      |
| $T_{par}^{max}$ (MB/s)                      | 53948.2               | 24706.4                |
| $N_{seq}^{max}$ (number of computing cores) | 14                    | 7                      |
| $T_{seq}^{max}$ (MB/s)                      | 47817.2               | 21137.3                |
| $T_{par}^{max2}$ (MB/s)                     | 53948.2               | 24706.4                |
| $\alpha$                                    | 1.000                 | 1.000                  |
| $\delta_l$ (MB/s/core)                      | 0.0                   | 0.0                    |
| $\delta_r$ (MB/s/core)                      | 0.0                   | 39.9                   |
| $B_{seq}^{comp}$ (MB/s)                     | 3417.6                | 3417.8                 |
| $B_{seq}^{comm}$ (MB/s)                     | 6220.0                | 6219.5                 |

Table 10: Parameter values for executions on `occigen`

| Parameter                                   | $\mathcal{M}_{local}$ | $\mathcal{M}_{remote}$ |
|---|-----------------------|------------------------|
| $N_{par}^{max}$ (number of computing cores) | 24                    | 25                     |
| $T_{par}^{max}$ (MB/s)                      | 64626.9               | 36737.2                |
| $N_{seq}^{max}$ (number of computing cores) | 26                    | 31                     |
| $T_{seq}^{max}$ (MB/s)                      | 62462.7               | 32649.8                |
| $T_{par}^{max2}$ (MB/s)                     | 64566.2               | 36696.7                |
| $\alpha$                                    | 0.990                 | 0.945                  |
| $\delta_l$ (MB/s/core)                      | 30.3                  | 6.8                    |
| $\delta_r$ (MB/s/core)                      | 56.9                  | -8.4                   |
| $B_{seq}^{comp}$ (MB/s)                     | 3211.5                | 3030.8                 |
| $B_{seq}^{comm}$ (MB/s)                     | 4958.6                | 4390.1                 |

Table 11: Parameter values for executions on `pyxix`

*Inria*

**RESEARCH CENTRE  
BORDEAUX – SUD-OUEST**

200 avenue de la Vieille Tour  
33405 Talence Cedex

Publisher  
Inria  
Domaine de Voluceau - Rocquencourt  
BP 105 - 78153 Le Chesnay Cedex  
[inria.fr](http://inria.fr)

ISSN 0249-6399