



**HAL**  
open science

# Describing and designing socio-technical organizations through the biophysical description of territorialized supply chains

Emmanuel Krieger

► **To cite this version:**

Emmanuel Krieger. Describing and designing socio-technical organizations through the biophysical description of territorialized supply chains. *Environment and Society*. 2022. hal-03562690

**HAL Id: hal-03562690**

**<https://inria.hal.science/hal-03562690>**

Submitted on 9 Feb 2022

**HAL** is a multi-disciplinary open access archive for the deposit and dissemination of scientific research documents, whether they are published or not. The documents may come from teaching and research institutions in France or abroad, or from public or private research centers.

L'archive ouverte pluridisciplinaire **HAL**, est destinée au dépôt et à la diffusion de documents scientifiques de niveau recherche, publiés ou non, émanant des établissements d'enseignement et de recherche français ou étrangers, des laboratoires publics ou privés.



## **Describing and designing socio-technical organizations through the biophysical description of territorialized supply chains**

*Krieger Emmanuel*

Professional mission from 30 / 05 / 2021 to 30 / 11 / 2021

directed by : M Jean-Yves Courtonne, Researcher at Univ. Grenoble Alpes, CNRS, Inria, Steep  
and M Mathieu Mangeot, Researcher at Univ. Savoie Mont Blanc, CNRS, Inria, Steep  
and Ms Cathy Descamps-Large, Head of the MSc EnvIM Environmental International Management,  
Mines de Paris  
and M Daniel Florentin, Assistant Professor at ISIGE - Institut Supérieur d'Ingénierie et de Gestion de  
l'Environnement, Mines de Paris

**Academic year 2021 / 2022**

**Professional Thesis**

**Post-Master International Environmental Management EnvIM**



Institut Supérieur d'Ingénierie et Gestion de l'Environnement - Mines ParisTech  
35, rue Saint Honoré 77300 Fontainebleau  
Tel : 01 64 69 48 78  
<http://www.isige.ensmp.fr>

## Acknowledgements

I would first like to thank the whole STEEP team because at this stage of my life, I could not have hoped for a better place to land. Indeed, while my ideas and values evolved very quickly in a societal framework that only offered outlets and work settings that did not suit me anymore, I was able to find in this research team a free place of expression providing many transdisciplinary perspectives, with a real questioning of the context in which we evolve as well as a perfect atmosphere to search for meaning in this ocean of questioning. It is notably a team where humility is at the centre of thinking, which seems to be increasingly rare in this world full of certainties.

In this sense, I would like to thank all the PhD fellows, with whom we spend great moments remaking the world, laughing and advancing on our personal lines of thought. On top of that, I would like to thank all the permanent researchers of this team, for the caring environment they created, being always open-minded, available to discuss ideas, always putting our reflections into perspective, as well as guiding the work we achieve with great care, and all this even if their agenda is full.

I would like to give two personal thanks to Mathieu and Jean-Yves, as they notably were the people who supervised my work during the whole training period. My thanks go far beyond the words I can write here, and I really think I'm missing some of what I would like to express to both of them hereafter. Still, I'll try to thank them, and in particular, I would like to thank Mathieu for his benevolence and for the reflections we have jointly led. On more concrete thanks, I would like to thank him for standing in for me during a presentation as well as for the proofreading of everything I have written and his dedication to the search for a thesis funding. Concerning Jean-Yves, I would like to thank him for the scientific references he always provided to deepen my work, for his open-mindedness, his availability to discuss, as well as for the critical rereading of what I wrote and the help he provided me to extend my working period in STEEP until a financing is found for the thesis.

The other part of my thanks goes to all the people which are involved in the MSc EnvIM, whether they are supervisors, or students. I found some real friends in the promotion, and these few months of courses in their presence have, I hope for, forged some lasting friendships.

Of course, this could not have been possible without Cathy and Daniel who have done everything to make the courses more enjoyable during these rehearsal confinements. So, thank you for that. In addition, I would like to specifically thank Cathy and Daniel for the attention and time they give to listening and guiding students, as well as for their critical advice on our work and, on a more specific note, for agreeing to supervise my work. In this context, I notably would like to thank Daniel for always pushing my critical thinking further.

## Abstract

Humans are having more and more impacts on environment due to unsustainable consumption and production patterns, thus threatening the capacity of natural systems to support their long-term existence. To help reaching a desirable and sustainable societal organisation, it is notably helpful to estimate the desirability of possible alternatives to the current socio-technical organisation. To move forward in this direction, a systemic modelling tool which could enable actors to design their own projection of a socio-technical alternative, and to evaluate it with multi-criteria indicators, is considered here. Following the idea of laying the foundations for the realisation of this model, this thesis proposes to explore the biophysical description of territorialized supply chains. In this sense, Supply Chain – Material Flow Analysis are chosen among other tools to be used to describe biophysical economy through the establishment of six material based French national supply-chains which are non-metallic minerals, fossil fuels, metals, waste, water and energy supply chains. Furthermore, based on the establishment of the material flows of urban mobility, a draft of a first prototype, greatly simplifying the approach, is proposed to design urban transport alternatives as well as to proceed to an environmental assessment of these alternatives. The work outlined in this thesis thus further advances the project of creating a multi-supply chain and multi-scale systemic model by continuing to lay the foundations for describing the biophysical economy and by examining what a simplified prototypes could do in terms of modelling, design and evaluation.

Keywords: Biophysical economy, Supply-chain material flow analysis, Sankey diagrams, Systemic modelling, Designing of socio-technical alternatives, Urban mobility modelling, Environmental assessment

## Acronyms

AGE: Applied General Equilibrium

DDP: Deep Decarbonation Pathways

EW-MFA: Economy-Wide Material Flow Account

GDP: Growth Domestic Product

GHG: Greenhouse Gas

LCA: Life-Cycle Assessment

MFA: Material Flow Analysis

MSA: Material System Analysis

OECD: Organisation for Economic Co-operation and Development

PM10: Particulate Matter with a diameter of less than 10  $\mu\text{m}$

SC-MFA: Supply-Chain Material Flow Analysis

SFA: Substance Flow Analysis

SI: Specific material Intensities

SU: Specific service Units

SUT: Supply-and-Use Table

WEE: Waste from Electrical and Electronic Equipment

## Table of contents

Introduction.....	1
1.1 We have our back to the wall: a necessary reorganisation.....	1
1.2 Constructing alternatives with actors of a territory through systemic modelling to change production and consumption patterns.....	2
1.2.1 A systemic modelling tool to create alternatives .....	2
1.2.2 A participatory process to enable stakeholders to establish alternatives for their territory .....	4
1.3 Multi-scale and multi-supply chain biophysical description as a necessary first modelling step.....	6
1.3.1 Biophysical and multi-supply chain description.....	6
1.3.2 Multi-scale description.....	7
1.4 Modification of territories biophysical economy description to create alternatives ...	8
1.5 Multi-criteria analysis as a tool to encourage stakeholder discussions about the vision of their future territory .....	9
1.6 Research questions .....	11
2 The theoretical framework and tools that allow a biophysical description of the human activity.....	13
2.1 The emergence of scientific communities thinking about human activity in a new perspective: parallel with natural ecosystems and biophysical accounting .....	13
2.1.1 The biophysical description of economy: why? .....	13
2.1.2 Where does the idea of describing a system biophysically come from and which scientific communities has it engendered? .....	14
2.1.3 Industrial and territorial ecology scientific fields .....	15
2.2 The different types of material flow studies.....	17
2.3 Coupling MFAs with other assessing methodologies .....	21
2.3.1 Establishing environmental pressures and impacts due to the production of goods .....	21
2.3.2 Coupling SC-MFA with economic and social sciences analysing methods.....	22
3 SC-MFA construction methodology and results obtained on the French economy .....	25
3.1 SC-MFA construction methodology .....	25
3.1.1 Establishing the structuration of supply chains .....	25
3.1.2 Collecting data .....	26
3.1.3 Data reconciliation .....	27
3.1.4 Analysis of the diagrams.....	29

---

3.1.5	Downscaling national MFAs to the scale of territories .....	29
3.2	SC-MFA construction perimeter.....	30
3.2.1	Supply chains that need to be explored.....	30
3.2.2	Weigh of raw materials in France .....	31
3.3	Results for the supply chains embedded in the French economy .....	32
3.3.1	Non-metallic minerals.....	33
3.3.2	Fossil fuels .....	34
3.3.3	Metals.....	35
3.3.4	Wastes .....	37
3.3.5	Energy sector and water sector .....	37
4	Construction of a prototype for creating a socio-technical alternative .....	39
4.1	Choice of the area to be studied .....	39
4.2	Comparison with other approaches to study the field of transportation in France ...	40
4.3	Methodological approach of Gassner’s study on the projection of material uses in the urban transport sector to 2050 and its adaptation to build the prototype.....	42
4.3.1	Presentation of the methodology and the results obtained on Vienna’s study ..	42
4.3.2	Reused methodological bases of Gassner’s article and additions to build the prototype .....	43
4.4	Three narratives of organisations with very different impacts.....	47
4.5	Perspectives and limitations .....	49
4.5.1	Perspectives for the prototype.....	49
4.5.2	Limitations of the approach taken.....	50
5	Conclusion .....	52
6	Annexes.....	54
7	Bibliography .....	74

---

## List of figures

Figure 1 - Project description with the interactions between the systemic tool and the participatory processes. Source: the author. ....	6
Figure 2 - A classical transformation and consumption supply chain for a raw material (Courtonne, 2016; Kovanda, 2021; Xu et al., 2021).....	7
Figure 3 - Figure representing the layout of the report.....	12
Figure 4 - Weak and strong sustainability and their respective representation of the relationship between the economy, society and the environment (Morandin Ahuerma et al., 2019) .....	14
Figure 5 - Main supply chains of the Belgian economic system (Billen et al., 1983).....	16
Figure 6 - A visualization of an EW-MSA system, its boundaries and major types of material flows (Kovanda, 2021).....	19
Figure 7 - Sankey diagram of the forestry supply chain in the region Grand Est (Terriflux - Filière Forêt Bois Grand Est, 2021).....	20
Figure 8 - Raw materials used in supply chains. Source: the author. ....	31
Figure 9 - Apparent French domestic consumption of materials weighted in mass in 2018. Source: data of 2018 processed from the website Eurostat. ....	32
Figure 10 - Sankey diagram of non-metallic minerals for France in 2018 (in thousands of tonnes - kt).....	33
Figure 11 - Sankey diagram of copper for France in 2017 (in kt).....	36
Figure 12 - Direct and indirect impacts based on 4 environmental criteria of three urban mobility alternatives for the city of Lyon. ....	49



## List of tables

<i>Table 1 - Supply table and matrices notations. The numbers in brackets indicate the dimensions of the matrices (Courtonne, 2016).</i> .....	26
<i>Table 2 - Use table and matrices notations (Courtonne, 2016)</i> .....	26

---

# Introduction

## 1.1 We have our back to the wall: a necessary reorganisation

The global socio-economic metabolism, which can be defined as the “set of all anthropogenic flows, stocks, and transformations of physical resources and their respective dynamics assembled in a systems context” (Pauliuk & Hertwich, 2015) has undergone a fundamental evolution from the XX<sup>th</sup> century onwards. The main drivers were notably the industrialization of many countries, an unprecedented population growth and a drastic increase in the magnitude of the global economy (Maddison, 2001), which have altogether resulted in a dramatic increase in energy and material resource uses (Krausmann et al., 2009). In fact, domestic extraction has been multiplied by a factor 12 between 1900 and 2015 and has respectively grown globally from 7.3 Gt/yr to 88.9 Gt/yr (Haas et al., 2020; Krausmann et al., 2018).

These growths of material extraction and consumptions have led to an increase of the various pressures and impacts on environment (Steffen, Broadgate, et al., 2015; United Nations Environment Program (UNEP), 2010; T. O. Wiedmann et al., 2015). Indeed, even though technical improvements have been achieved, “improvements of eco-efficiency<sup>1</sup> have so far not reduced global resource use, as they were overcompensated by economic growth and rebound effects” (Haberl et al., 2017). In other words, the growth of resource use and pollutant emissions was far more rapid than their reduction through better technology since these technology improvements were accompanied by economic and social changes (T. Wiedmann et al., 2020).

Interestingly, the tremendous and increasing impacts of human activity on its environment (Steffen, Richardson, et al., 2015) have led scientists to create a term for a new geological era where humans have become the greatest force modifying the environment: the Anthropocene (Lorius & Carpentier, 2011). In facts, this force is so considerable that it is compromising the long-term life-support systems for human existence (Sachs, 2015) due to an overshoot of carrying capacity and due to the erosion of the environmental capacity which could ultimately lead the society to its collapse (Meadows et al., 1972).

Therefore, in view of the forces at work, it is of primary importance to anchor the evolution of the socioeconomic subsystem in its environmental system (European Communities, 2001; European Environment Agency (EEA), 2017, 2019). In other words, it is therefore necessary to radically and rapidly change our production and consumption patterns to create a liveable future.

---

<sup>1</sup> The concept of eco-efficiency refers to the reduction of the number of resources used or to the number of pollutants emitted per unit of Growth Domestic Product (GDP).

## 1.2 Constructing alternatives with actors of a territory through systemic modelling to change production and consumption patterns

Based on the observation that we need to change production and consumptions patterns, the question that directly follows is how to change them? A possible process is **to enable groups of actors, whoever they are, to create their own projection of a socio-technical alternative through the use of a systemic modelling tool.**<sup>2</sup>

### 1.2.1 A systemic modelling tool to create alternatives

Regarding why projections for territories are key, it relies on the fact that to achieve the most informed public decisions, knowledge is needed to structure an engineering capacity in a first time, and then to take action based on them. This knowledge can be notably achieved through the projection of futures, which is what is suggested here, and in this sense Milkoreit, (2017) says that “the ability of individuals and groups to envision possible, likely, and desirable futures that can guide [...] collectively determined directions is an essential capacity for securing social well-being and prosperity in times of rapid and often unpredictable global change”. Moreover, the emergence of socio-technical alternatives through the co-construction by actors of shared long-term visions may constitute a pressure on the current socio-technical organisation and, with the convergence of other phenomena, be able to change this organisation towards a more sustainable one (Lumbroso, 2019; Smith et al., 2005). Indeed, different imaginaries influence directly narratives and practices inside a given territory (Pachoud et al., 2020). As Gaston Gerber says it simply: “looking at the future means changing it”.

In addition to these prospective issues, and since it is necessary to have a medium to create projections, it is achieved here thanks to systemic modelling. What is meant by model is “a simplified, stylised and formalised representation of (a part of) reality” (Holtz et al., 2015). Modelling involves the selection of the aspects of the system under study which are considered most important in relation to a particular research objective (Holtz et al., 2015). Thus, considering that the primary objective of the present research is the transformation of consumption and production patterns, the model aims at focusing on supply chains and taking into account interdependencies between these supply chains and their spatialization through different scales of territories. The focus is put on interdependences between supply chains and different scales of territory due to the fact that sub-national territories, together with supply chains, are considered to be two key actors of the future organisation of a sustainable society (Calame, 2011). This couple territory-supply chains thus replaces the usual state-firm pairing, which seems unsuited to the challenges of sustainability (Calame, 2011; Courtonne, 2016).

Concerning the systemic aspect of this model, it should be ensured by the interactions and interdependencies between the subparts of the system, e.g., territories or supply chains, which should give properties to the whole socio-technical system. Thus, the model will try to

---

<sup>2</sup> A socio-technical alternative refers here to a given structure of production and consumption patterns, embedded in a defined social organisation which is different from the current socio-technical organisation. More generally, a socio-technical organisation consists of a network of elements linking actors with economic, material, cultural and social aspects (Geels, 2005) and this notion can be linked to the one of “socio-technical regimes” introduced by Geels & Schot, (2007).

comply with the definition of the complex system as given below. However, as any representation of a complex system reflects only a single possibility among the subsets of representations of it (Munda, 2004), it is acknowledged that even if the model is intended to be systemic, it cannot take into account all of its characteristics and it will necessarily have to simplify some of them.

Systemic studies are based on four fundamental concept (Durand, 2010):

- Interaction, which states that relations are generally not as simple as causal actions;
- Globality, saying that a system is not reducible to its parties;
- Organisation, defined as an arrangement of relationships between components or individuals that produces a new unit with characteristics that its components do not have;
- Complexity, which is the principle of recognising that it is not possible to grasp all the concepts of the system, such as certain inherent dynamics of the system, certain uncertainties from the system environment or even ambiguous relationships about contingencies.

Another way of putting it could be that a system is more than the simple sum of its sub-parts and that these sub-parts are interconnected in a complex structure (Meadows et al., 1972; Seiffert & Loch, 2005).

Finally, the model will also be designed to evaluate from a multi-criteria perspective the different descriptions of the economy. Since complex systems have ontologically a multidimensional nature, it is important to be as exhaustive as possible in the overview of all the possible criteria of evaluation (Etxano & Villalba-Eguiluz, 2021). However, a particular attention has to be paid on the biases of evaluating socio-technical organisations for themselves, as the results of an evaluation give a specific representation of a complex system, which is by definition “technically incommensurable” (Munda, 2004).

The objective is thereby to build a tool that would describe the economy and which could allow to modify the current socio-technical organisation in a prospective approach. In concrete terms, this tool would:

- **Take into account issues of production as well as consumption**, i.e., the whole supply chains, together with all the interactions between these same supply chains;
- **Adopt a multi-scale approach**, i.e., describe the territory and its interactions and interdependencies with different other territory scales in the rest of the system;
- **Create socio-technical alternatives** through the modification of consumption and production patterns inscribed in supply chains of different territories;
- **Conduct a multi-criteria evaluation** of the socio-technical alternatives.

It must also be noted here what this tool is not. It is not a tool for steering public action: it cannot provide a methodology for governance. On the contrary, this tool serves to visualise

---

alternatives while not being prescriptive as regards to the alternatives, nor exhaustive with regards to the description of alternatives, since biophysical description necessarily has its own limitations of representation by only being able to represent relations between stakeholders based on their material aspects.

### **1.2.2 A participatory process to enable stakeholders to establish alternatives for their territory**

This tool would also be embedded in a participatory process which would allow to do projections for a territory, regarding notably its consumption and production organisation. This participatory process would have several goals, but wouldn't have the same application, depending on the power of decision-making for the territory planning of the stakeholders participating to the process.

A first option would be that the process could only be informative for the stakeholders of the territory. In such a process, the model could describe the current socio-technical organisation and allow the co-construction of different other socio-technical alternatives. It would here allow stakeholders to evaluate the viability of different alternatives they have created and to choose which ones seem preferable and for which reasons. This is made to allow stakeholders "to explore situations or developments that are regarded as possible to happen [...] from a variety of perspectives" (Börjeson et al., 2006), which is also called making explorative scenarios. However, without any decision-making power, i.e., the participative process only enables informing or consulting as Arnstein (1969) defined it, these creations of alternatives would only make it possible to "reach a common understanding and consensus regarding any conflicting interests, values, or norms" (Basco-Carrera et al., 2017). In such a case, it would not allow stakeholders to make decisions to implement different actions, but would only give a view of different possible pathways. Nonetheless, it would still promote a greater appreciation of plurality and human intentionality among the multiple and sometimes contending viable sociotechnical alternative pathways for the different stakeholders participating (Leach et al., 2007). In other words, it would allow stakeholders to discuss about their territory and to form a common vision on which to build for the next projects of the territory since there are many subjective views of "what the world is", "what the world will likely be" and "what the world should be" (Geels, 2010; Savaget et al., 2019).

A second option would be that the use of the model could be embedded in a participatory process where the planning and the decision-making towards territory sustainability is shared between the citizens and the powerholders, i.e., in a partnership or delegated participatory process (Arnstein, 1969). In this specific case, and on top of what has been said before, it would also allow stakeholders to agree on a pathway and to implement a back casting which is a planning method "in which the future desired conditions are envisioned and then looking backwards from that future to the present in order to strategize and to plan how it could be achieved" (Holmberg & Robert, 2000; Quist, 2007; Quist & Vergragt, 2006). By implementing back casting, the projection study could be the base to create scenarios which are called normative transforming scenarios (Börjeson et al., 2006), and which put the focus "on certain future situations or objectives and how these could be realised". In this sense, the

model would still have the same objective: to be an explorative modelling tool, but it could be followed in the participatory process by a step of making normative transforming scenarios thanks to other methods. A challenge in this process would therefore be for stakeholders to agree on desirable alternative socio-technical pathways and then to set up the necessary coordination to bring the projections into action.

In any case, more than just projections making, participatory processes allow for an outside reflexive look at the tool as issues of sustainability “do not enter the scientific realm as neutral objects of inquiry” but rather are from the very “phase of problem definition value-laden and guided by transformational perspective” (Popa et al., 2015). This is particularly necessary since sustainability research are encompassed in “values, background assumptions, and normative orientations” (Popa et al., 2015) that need to be questioned. Therefore, discussion with participants through participatory processes should not only bring projections for the territory but also should allow to bring other questioning modes. This participatory framework should thus allow for a reflexive view of the systemic modelling tool by changing the questioning modes, bringing new perspectives, and providing criticism on the evaluation of alternatives, on the blind spots and more generally, on the approach adopted.

Hence, the participatory aspect is important with regards to the different points listed above. In summary, participatory processes allow to:

- **provide an appropriable and shared, therefore more legitimate, representation of the desirable futures** for the stakeholders of the considered territory;
- **allow in a second step the setting up of actions thanks to back casting** to make the creation of socio-technical alternatives effective;
- **highlight issues that were not considered and question thinking modes used to build the model** and therefore allow to improve its systemic dimension.

The project thus presented has both a modelling and a participatory approach. The interactions between the different parts are multiple but they are part of a general plan which can be simplified as set out below on Figure 1.

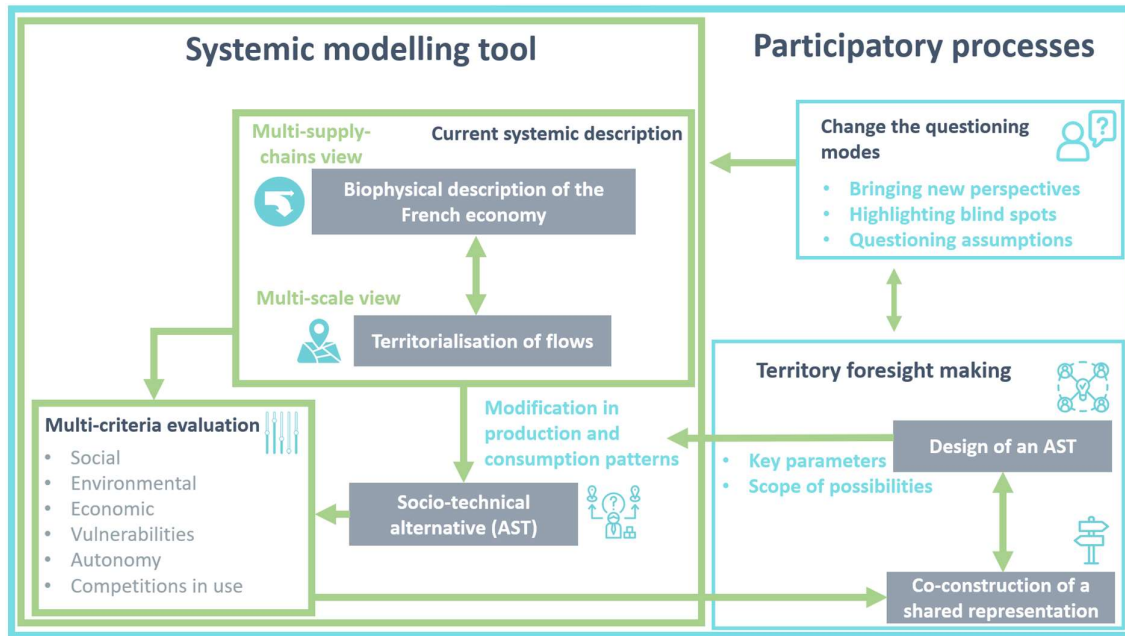

Figure 1 - Project description with the interactions between the systemic tool and the participatory processes. Source: the author.

The general project being presented, the focus of this thesis will be restricted to the modelling part, due to time and data production constraints, the participatory aspects being planned for the next step of the project. In this sense, the next parts will describe how it is intended to make the creation of socio-technical alternatives possible through the use of a systemic modelling tool.

### 1.3 Multi-scale and multi-supply chain biophysical description as a necessary first modelling step

In the general framework of the model, and in order to take into account the supply chains and the territories, the first step is to describe these supply chains and their link with territories.

#### 1.3.1 Biophysical and multi-supply chain description

It is first necessary to establish a formalism of description for the socio-technical organisations. Currently, the two principal manners of describing the economy of a territory are on a monetary or a biophysical basis. These different manners of describing the economy are linked to two major economic registers, respectively environmental economics, which tends to “market nature” (Renou, 2018), and ecological economics, which aims to “anchor economic science in its material, energy and environmental dimensions” (Renou, 2018).

Since a primary motivation is to take account of biophysical limits and environmental pressures in describing production and consumption patterns, it is important to be able to

describe the economy in the appropriate units, namely in terms of biophysical flows. The study presented here therefore connects directly with the ideas of ecological economics.<sup>3</sup>

The description of the economy in biophysical terms involves a categorisation of the raw materials used in human activity, namely: biomass, non-metallic ores, metallic ores and fossil fuels. With these four categories it is possible to describe all the raw materials that will then be used in the more detailed supply chains (European Commission, 2018). These categories of materials can then be linked to their respective supply chains of transformation and consumption as it is described on the Figure 2. The process has been intentionally simplified and is not exhaustive considering the steps it may include on the different supply chains.

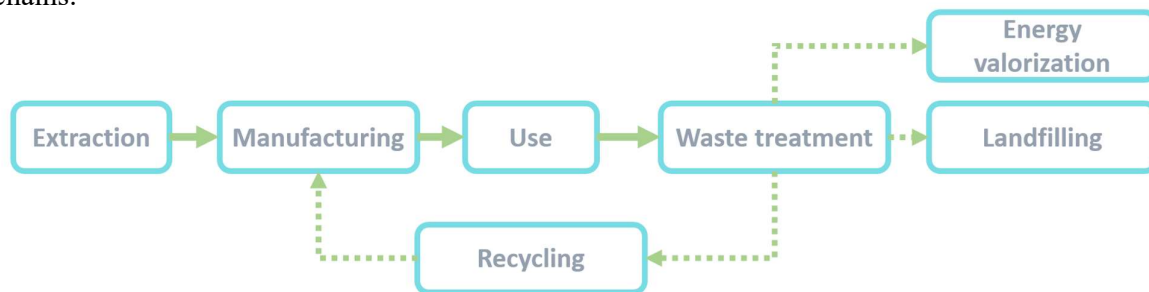

Figure 2 - A classic transformation and consumption supply chain for a raw material  
(adapted from Courtonne, 2016; Kovanda, 2021; Xu et al., 2021)

The whole structure of these supply chains and their interconnections with the other supply chains thus form the description of the biophysical economy as we understand it. Even though the supply chains only offers one of the many prism of study of the issues at stake in a territory, they can account for many issues such as goods and services production, environmental pressures, interdependencies and autonomy of territories as well as information about competitions in resource use (Courtonne, 2016).

### 1.3.2 Multi-scale description

Secondly, rather than simply describing the biophysical economy through the interdependencies of several supply chains, it is necessary to be able to scale differently these supply chains accordingly to the considered territory. This makes it possible to account for the specific layout of supply chains in each territory and thus to highlight the interdependencies of the considered territory to the rest of the system.

This is of particular importance because there are many possibilities to describe a territory: geographically, physically, institutionally, symbolically but it is also possible to describe it through its organisation and its interdependencies with other locations. Indeed, by taking the territory as a “place for coordination between multiple, atomised actors in a situation of asymmetry, with divergent interests, and a place for bringing together diverse objectives, expressed at embedded levels of organisation” (Roux et al., 2003) and as a “place of subsistence

<sup>3</sup> More details about scientific fields to which this study is linked will be further provided in part I.



for people” (Aït-Touati & Coccia, 2021), the territory thus defined involves many different scales of geographical territories. The goal is thus not only to describe what is inside the geographical territory, but even more how it is organised and to list those on whom it depends. Latour, (2021) says in this sense, and adding a human dimension, that to become sustainable “is not to become local [...] but to be able to meet the beings on whom we depend”, thus bringing the notion of dependencies, organisations and different scales at the centre of the debate.

This concept of dependencies makes sense particularly in the case of cities because their existence has been made possible thanks to the possibility of partial or even complete food production relocation (Bognon et al., 2018). But in facts, this idea has become relevant for many types of territories, because specialized agricultural production, and specialized productions and consumptions patterns in general, create supply chains that need to be organised to cross the globe to deliver goods and services (Billen et al., 2014). Moreover, it has been highlighted that France geographical territories are also interdependent with each other (Courtonne et al., 2016; Noë et al., 2016), which requires to find the relevant scale of study. Nevertheless, it should also be taken into account that the relevant scale of study is most of the time multiple because there are in fact several scales embedded in one (Debusson, 2014), which makes the multi-scale description particularly relevant.

After having described what was meant by the biophysical description of the French economy through the multi-supply chains aspect and their anchoring to different scales of territories, it is now necessary to address the issue of modifying these descriptions to create alternatives.

#### **1.4 Modification of territories biophysical economy description to create alternatives**

If the change of consumption and production patterns are to be studied, it is not enough to describe the current situation: it is also necessary to study how to create socio-technical alternatives.

Through the prism of the study of the biophysical economy with the territorialized supply chains, the creation of socio-technical alternatives relies on changing material flows throughout the supply chain. Several changes can be made to a supply chain: the structure of the supply chain can evolve, the value of flows can be changed and the impacts and pressures linked to the flow can change. As an example, to illustrate these three points, it could be imagined that a cooperative for a specific good production is created in the alternative, and that it would redirect flows differently and thus change the physical distribution structure of the supply chain. Regarding the values of flow, it could, among many other possibilities, depend from the quantity of good consumed which could be changed, such as a diminution of motorized individual transportation (Gassner et al., 2021). And finally, to give an example concerning the impacts and pressures linked to the flows, an intensive or extensive food production used to construct the alternative would not have the same impacts among others on the land use, on water eutrophication, on the number of jobs required for the territory or on biodiversity all else being equal.

More technically speaking, to make these supply chain changes possible, a solution is to isolate a subsystem which functions in a coherent manner within the different supply chains composing the sociotechnical alternative (Mauviel, 2021). This subsystem is most of the time a sector of production or consumption of a given good which has specific quantitative characteristics, e.g., for the livestock farming subsystem, the herd size, the feed requirements or the manure production. Then, each sub-system can be declined under different modules of production, or consumption, which frame the sub-system qualitatively in different manners. This allow stakeholders to choose between different alternative modules that meet the same need but which are organised differently and do not have the same impacts, the same size of material flows or the same repercussions on social organisations.

It should be noted that these different modules do not necessarily respond to the same societal framework. Indeed, some module choices are only made possible in some scenarios and are not consistent in others since these alternatives are embedded in different main narratives and fitted into different archetypes of representation of societal and political trajectories (ADEME, 2021; Mauviel, 2021). Illustratively, some examples from the ADEME scenarios to reach carbon neutrality by 2050 suggest creating a socio-technical alternative where mass consumption lifestyles are safeguarded while promoting a sharp reduction in mobility or stabilizing data centre consumption would probably not make sense. It is therefore important to think of a scenario narrative when modifying the subsystems with different modules, to ensure that the choice of modules is consistent across the alternative.

Regarding the sub-systems to identify, several exercises have been carried out for the French and European territory to achieve a more sustainable societal organisation according to the prioritising of certain indicators, such as mitigating and adapting to climate change or reducing the drawbacks of intensive agricultural production (ADEME, 2021; Association Solagro et al., 2016; Billen et al., 2021; négaWatt, 2017; Rauzier et al., 2020; RTE, 2021). These already existing prospective studies allow to frame the different possible modules for each identified subsystem, while not being restricted to them. Indeed, because of the fact that different social groups can identify different modules “characterised by different norms, practices and resources” (ADEME, 2021), the projection studies are necessarily incomplete and must be completed by the participatory modelling approach as explained earlier.

Now, having set out how to describe and change a socio-technical organisation, it is necessary to look at how to evaluate each alternative.

## **1.5 Multi-criteria analysis as a tool to encourage stakeholder discussions about the vision of their future territory**

As said previously, multi-criteria analyses allow to evaluate with different indicators the socio-technical organisations thus created. This perspective allows to better take into account the multidimensional nature of complex systems and is opposed to the classic idea in economics that everything can be reduced to a single indicator unit, i.e., dollars.

In the context of evaluating sustainability, three groups of criteria, which are also commonly presented as the pillars of sustainability principles (Purvis et al., 2019), serve to

evaluate socio-technical alternatives: economic, environmental and social criteria. These types of classic groups of indicators are thus very suitable for describing fairly comprehensively the desirability of a socio-technical alternative. To give some quantitative examples, when it comes to evaluate alternative organisations, the allocation of working time (Manfroni et al., 2021) or the number of jobs can be an interesting social indicator, the number of resources consumed or emissions released can be relevant to take as environmental indicators and the value produced by the sale of the goods can be of interest to take a look at as an economic indicator.

Furthermore, and in our case, specific indicators linked to the material and supply chains approach can be used. Examples include the criteria of vulnerability of both the approach through the territory or the supply chain dependencies and the criteria of competition in the use of materials. However, although the indicators are intended to represent the situation as well as possible, attention should be paid to the multidimensional nature of complex systems which are by nature “technically incommensurable” (Munda, 2004). Thus, any representation brings a significant simplification of reality which does not necessarily takes into account the multiple aspects in the descriptive model.

Beyond this point and in addition to providing some insight into the complex nature of the systems under study, multi-criteria assessments are of great help when stakeholders have to decide on a common ranking of socio-technical alternatives. Indeed, as different actors should be integrated in the process of prospective making, the multi-criteria evaluation should allow to enhance transparency on actor’s assumptions used, on their interests and values considered to rank the different socio-technical alternatives (Munda, 2007). This is particularly important if the participatory process involves decision-making, as agreement must be reached between stakeholders on a trajectory for the territory. To take an example, what priority is given for the territory between social and ecological criteria, or between favouring the territorial economy and its autonomy? These are political issues whose answer depend notably on arbitrations carried out and, ultimately, on the values of the participants to decide on these trade-offs and the multi-criteria assessment is useful in particular to make these choices explicit.

However, it should be noted that just because there is a possibility to rank the alternatives, it does not mean that it is something easy to do in practice. Indeed, there is an “existence of a multiplicity of legitimate values of a society” (Munda, 2004), which makes it difficult to create among the participating stakeholder an “unanimously agreed ranking of sustainability criteria” (Lehmann et al., 2021). Moreover, even with a common agreement on the ranking of sustainability criteria, the weight attached to each criterion is another point to find an agreement on. The “absence of common unit of measurement between plural values” (Martinez-Alier et al., 1998), i.e., what is called by Munda the social incommensurability principle, does not allow each criterion to be easily weighted. Combined with the fact that the result of socio-technical alternatives is very sensitive to changes in the weighing of criteria (Lehmann et al., 2021), it quickly becomes clear that multi-criteria analysis, while allowing for greater discussion, does not answer all the evaluation questions that need to be part of a discussion to sort out these issues (Munda, 2007).

---

Eventually, multi-criteria evaluation, although difficult to carry out in practice because of the incommensurability principles, remains a particularly interesting tool for evaluating and supporting discussions on the desirability of socio-technical organisations.

## 1.6 Research questions

Finally, it is reminded here that the presentation of the main steps of description, modification and evaluation of socio-technical alternatives for the systemic model are part of the more general research project having as a goal to answer the question: “**How is it possible to help the actors of a territory build new socio-technical organisations using the biophysical description of the economy by notably taking into account the planetary boundaries?**”. It is a highly complex issue that does not admit a single solution.

In the present thesis, the answer adopted proposes to make territorial prospective modelling, included in a participative process with the stakeholders of the territory, and based on material flows forming interdependent supply chains at different scales. However, far from being finalised, this project is still an ongoing work and many points require further research. Among the Figure 1, several blocks have not been studied in the same depth. Several important questions therefore remain to be explored, especially on the biophysical description part, being the keystone of the model. They are:

- **What is the theoretical framework, as well as the tools linked to this framework, that allow for a biophysical description of the French economy?**
- **What methodology for describing the French economy and what results can be obtained?**

A third question is also highlighted on the prototype creation of an "operational" model that could represent the modelling of a given human activity only by its environmental character and at a given scale:

- **What could be a first draft of a model, allowing to describe the material reality of a human activity, that could modify and evaluate socio-technical alternatives?**

These issues will be addressed in each part according to the Figure 3. First, part I will describe the academic context and the tools for describing the economy in a biophysical manner. Then, part II will describe the methodology adopted and the results obtained to describe the French economy. Finally, part III will give a first overview of a prototype modelling tool that cuts across several blocks of the project.

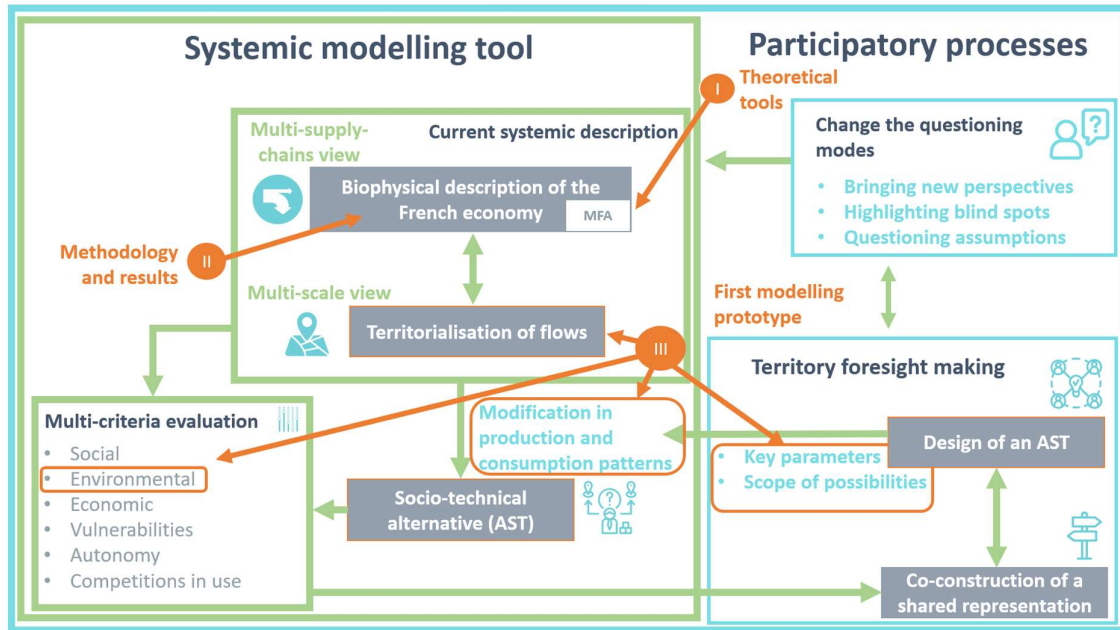

Figure 3 - Figure representing the layout of the report

---

# The theoretical framework and tools that allow a biophysical description of the human activity

To make a biophysical description of the human activity is an idea which takes its roots in several scientific communities that emerged in the second half of the last century and which drew parallels between human activities and natural ecosystems. To understand why this approach is relevant, we need to understand the reasons this prism of study was chosen in the first place.

## 2.1 The emergence of scientific communities thinking about human activity in a new perspective: parallel with natural ecosystems and biophysical accounting

First, ecological economics and its counterpart environmental economics will be discussed. Indeed, both of them could have served as a basis for describing the economy in the model but the biophysical accounting has been retained.

### 2.1.1 The biophysical description of economy: why?

It is important to note that although the biophysical description method of economics is the basis of the systemic model, it is a less common way of studying the links between the economy and the environment than the monetary methodology. Indeed, if one looks at the history of environmental issues, they came to the fore in the field of economic at the end of the 1960s (Debreu et al., 2016). This particular issue gave rise to two schools of thoughts: one within the framework of traditional economics seeking to extend the classical concepts of economics to the environment and resource issues, namely the environmental economy, and another based on the principles of ecological research to study the economy, the ecological economics.

The major difference between these two schools of thought is that they are fundamentally opposed on the manner to articulate the relationship between the economy, society and its environment. Indeed, whereas environmental economics assumes that 'natural capital' can be substituted by financial and technical capital, ecological economics is based on the fact that human societies, and thus the economy embedded in that society, are dependent on the health of its environment (Froger et al., 2016). It is the difference between respectively weak sustainability and strong sustainability (Goodland, 1995), which are represented on figure 4. This fundamental difference in assumptions leads these two scientific communities to use quite different ways of studying the environment. **While environmental economics tries to estimate the "value of our environment"** (Gadrey & Lalucq, 2016) because it can precisely be replaced by technological and financial capital, **ecological economics** intends instead to account for nature through a biophysical approach to the economy and, therefore, **"seeks to understand all the flows of materials and energy drawn and released by the economy into the biosphere"** (Debreu et al., 2016).

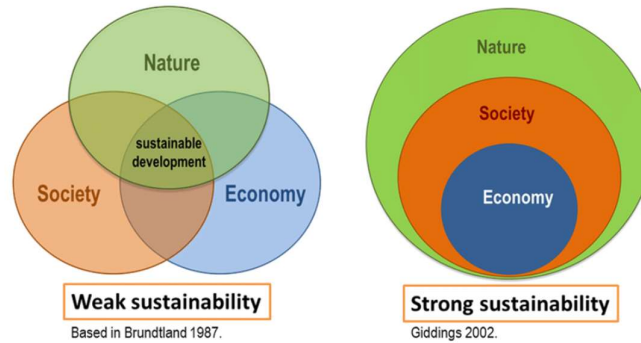

Figure 4 - Weak and strong sustainability and their respective representation of the relationship between the economy, society and the environment (Morandin Ahuerma et al., 2019)

However, in view of the issues set out in the introduction, the search for ways to mitigate the degradation of natural capital through the use of finance or technology seems ineffective. No absolute resource or energy decoupling has been observed yet (Behrens et al., 2007; Krausmann et al., 2009, 2018) and some articles even claim that weak sustainability would “not lead to any form of a sustainable future” (Biely et al., 2018). Indeed, some defend that the “most important step towards avoiding societal collapse is a fundamental change in values” and that “the current direction of progress in science and technology will hasten collapse rather than prevent it” (Huesemann & Huesemann, 2008). As early as 1968, Burton, (1968) even wrote that: “The Achilles heel of the technologists’ approach is, of course, that the present problems of environmental quality arise precisely from the application of technological solutions to problems in the past. The new technologies now being developed may in their turn prove to be only palliatives that will pile up greater difficulties to be confronted at a later date”.

Thus, and although the dominant approach is based on a monetary evaluation of the economy, it is considered that this approach is insufficient to conduct a relevant analysis in view of the current systemic environmental issues. **So, this report focuses on biophysical accounting and is therefore related notably to ecological economics.**

### 2.1.2 Where does the idea of describing a system biophysically come from and which scientific communities has it engendered?

Besides ecological economics, this report relates to other disciplines studying spatial systems or human activities which have also appropriated the concepts of biophysical interactions and interdependencies to describe their systems. These other disciplines, as well as ecological economics, are based on the concepts elaborated by the scientific field of ecology. More precisely, this science studies the relationship between living beings and their environment. In particular, ecology scientists study ecosystems, which can be defined as the “living entities formed by a group of different species in interaction with each other and with their environment on a given spatial scale”(CNRS, 2021) or, in a rather similar form, as a “set of interdependent species [...] and all the physico-chemical conditions [...] that constitute their living conditions.” (Debref et al., 2016). To account for the interaction and interdependence

between species and their environment, ecology scientists notably study the circulation of matter and energy between them which is also called their metabolism (Bahers, 2014).

It is then the **transposition of these ideas to human activity due to environmental issues** (Duchin & Levine, 2008) that has given rise to scientific communities basing their work on the links between humans and their environment, **in particular through the analysis of the flows of matter and energy in a given system**. Their difference lies notably in the disciplinary field that created these communities. Indeed, while ecology economics has been created by economists, industrial ecology has been founded by engineers and territorial ecology was conceived thanks to researchers in planning and urban development. Over the decades these scientific communities have developed their own methodology of analyses which are appropriate to their study prism, but with a common interest in making the system more sustainable. In this report, by desiring to describe the economy through the material flows of supply chains of a given territory, this work places itself at the intersection of these three scientific communities and adopts some of the methodological approaches that they use.

### 2.1.3 Industrial and territorial ecology scientific fields

As our focus on the model is the transformation and circulation of matter along the supply chain, it is interesting to focus first on industrial ecology. This scientific community was born around the 1980s, and is mainly concerned with the appropriation of resources in terms of matter and energy for both production and consumption. It “explicitly recognizes that human industrial activities in the modern industrialized world are characterized by the interdependence of many industries, each industry itself often performing many interconnected production processes, all reliant on inputs of energy and materials and discharging wastes” (Duchin & Levine, 2008).

More precisely, based on these precepts, several scales of study have been historically implanted. Indeed, industrial ecology can both be based on a productive system across the scales or on a productive system in a specific territory. While the former “**attempts to quantify a society’s industrial metabolism**” (Duchin & Levine, 2008), the latter “**aims to optimise resources on a territory**, whether it be energy, water, materials, waste, but also equipment and expertise” (Coppens et al., 2018) in an idea of industrial symbiosis which is guided by the principles of the circular economy.

With the idea to quantify Belgium society’s industrial metabolism, Billen et al., (1983) have described the main supply chains composing its economic system as it can be seen on Figure 5. Their approach is close from the one that is aimed to be taken for the model since they mapped the different supply chains with MFAs, before assessing the environmental pressures linked to these supply chains and opening the debate on a more critical questioning of the economic and political system and its possible reorientation.

The systemic model that is proposed to be built here should in fact be completely related to the approach mentioned above. **It should emphasise the industrial metabolisms of the economy through the description of interdependent supply chains which would in turn make it possible to highlight levers for action to improve the sustainability of the system.**



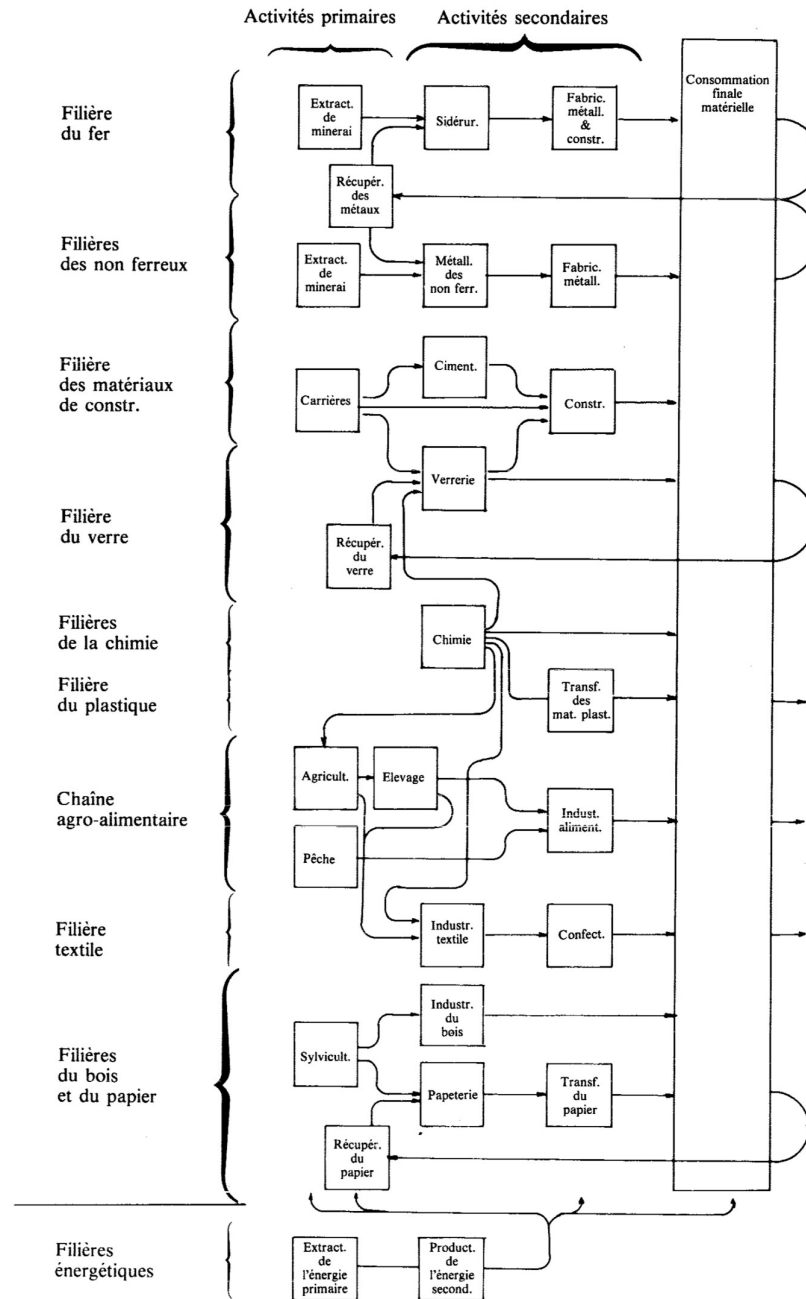

Figure 5 - Main supply chains of the Belgian economic system (Billen et al., 1983).

By focusing on the metabolism of a particular region, the approach is also close to the ideas of territorial ecology. Indeed, this field of study also aims at “**describing, analysing and even transforming the metabolism of territories, based on the analysis of natural and social processes [...] which are at the origin of material and energy flows, which reciprocally transform them**” (Barles, 2014). Territorial ecology also associates “the analysis of actors, institutions, policies, techniques which are at the origin of these flows, i.e., the social dimension of the metabolism, alongside that of the natural processes which guide it” (Choay & Merlin, 2015). Thus, this approach strives to build a territory where the sustainability of

production processes is enhanced (Beaurain & Brullot, 2011) and offers the possibility to introduce a second dimension of coordination and co-construction of a territorial strategy with the actors (Maillefert & Robert, 2014). Finally, if the way of establishing the biophysical description of supply chains through the systemic model were to be placed directly in scientific communities, it would be placed at the intersection with the communities of ecological economics, industrial ecology and territorial ecology, without however being completely reduced to them as they all include additional dimensions of analysis.

Now that the scientific communities have been introduced, it is interesting to examine the different categories of tools for describing the circulation of matter because different methodologies have been developed that could help to build the model.

## 2.2 The different types of material flow studies

Studies of material flows in a system are called **Material Flow Analyses (MFA)**. MFAs are a family of tools which encompass several analytical approaches and measurement tools (OECD, 2008). They can be defined as a “systematic evaluation of materials in a system defined in space and time“ (Baccini & Brunner, 2012). MFAs are not only useful in providing information on material flows, but they also provide information on the main characteristic and on the intrinsic way in which the system operates (Billen et al., 2014). **They are based on the very principle of mass conservation**, founded on the first law of thermodynamics, which states that matter (mass, energy) is conserved during any transformation, and can neither be created nor destroyed by any physical process. This law makes it possible to calculate all the circulations of matter within the system as well as its exchanges with its environment. The term MFA therefore refers to these different kind of material assessments based on the principle of mass conservation.

Several types of material flow assessment methodologies have been created based on these principles. To classify the different types of MFA, a first differentiation can be made on the type of material flows studied. Two different types of materials can be mentioned: substances, e.g., zinc (Yan et al., 2013), carbon (Ma et al., 2012), nitrogen (Billen et al., 2014, 2021), phosphorus (Qiao et al., 2011), but also raw material, semi-finished products and products (Courtonne et al., 2015; Kovanda, 2021; Xu et al., 2021). While substances refer to particular chemical species that are of particular concern regarding their impacts on nature, raw materials, semi-finished products and products refer to materials that are recontextualised in the thermo-industrial society. Thus, if one wants to study the effects of a substance that is known to be problematic, such as nitrogen and phosphorus in agriculture, it is therefore appropriate to use a substance-based prism. On the other hand, if one wants to make a link with creation of goods that meet a social need as well as production and consumption patterns, it is therefore relevant to work with raw materials and products.

A second differentiation can be made based on the purpose of the study and on the essence of what is important: is it the impacts of a given matter on all the different aspects of its environment or the impact of the territory, through its material transformed in industries, on its environment? Indeed, two perspectives exist concomitantly when one wants to make MFAs. In one case, one can be interested in the material and look at the systems affected, while in the

other case, one can be interested in a specific system, e.g., a supply chain, an activity, or a territory (Billen et al., 2014), and look at the materials circulating within it and its impacts. These two seemingly identical approaches are in fact different, because the importance is either on the material itself or on an area of study.

Based on these two main ideas of differentiation, three large families of assessment methodologies can be identified: Substance Flow Analysis (SFA), Economy Wide Material Flow Accounts (EW-MFA) and Material System Analysis (MSA). It is to be noted that some additional MFA subfamilies have been identified (OECD, 2008), but they are too far from the scope of this work to be mentioned.

First, when a substance is studied, the study is called Substance Flow Analysis (SFA). These types of material flow analysis are made when there is a substance that is “known for raising particular concerns as regards the environmental and health risks associated with their production and consumption.” (OECD, 2008). These kind of studies can both be applied in a specific region (Verger et al., 2018), and on a specific matter (Billen et al., 2014). They have received a lot of attention in the field of agriculture impacts, as it can be seen with nitrogen flows in Europe in Annex 1, but also in the metal industry with studies on aluminium (Ciacci et al., 2013), on copper (Bonnin et al., 2013) or on zinc (Yan et al., 2013). However, SFA is only applied to certain substances, and is not focused on the manufacture of a good that meets a need. Thus, SFA does not seem to be relevant for establishing a biophysical description in the model as it is intended here.

Second, if the focus is put on raw materials, semi-finished products or products and it is the exchanges made by the economy with its environment which are the object of interest, one speaks of Economy Wide-Material Flow Accounts (EW-MFA). It is a “statistical accounting framework recording [...] material flows into and out of an economy” (European Commission, 2018) which is mandatory to be reported each year by European countries (Regulation (EU) No 691/2011 of the European Parliament and of the Council of 6 July 2011 on European Environmental Economic Accounts, 2014).

The general purpose of EW-MFA is to highlight the biophysical exchanges between the economy under study, the economy outside the system studied and environment. In this methodology, emphasis is therefore on the interactions at the interface of the system, as it can be seen in Annex 2. However, the emphasis on external relations poses a serious problem when one wants to analyse the economy itself because EW-MFA doesn't take into account the intrinsic modifications of the matter in the economy. In other words, the system under study is a black box, and only its interactions with the environment are taken into account. Thus, this methodology, although interesting for highlighting relationships at the interface of the system, is not interesting for studying supply chains inside the system as it is intended to be done here.

Finally, in the case focus is put on a raw material, a semi-finished product or a product and it is the impacts of an industry which is the object of interest, the study is called a Material System Analysis (MSA). This type of study considers life-cycle-wide inputs and outputs and is applied to materials that are included in an industry process and that “raise particular concerns as to the sustainability of their use, the security of their supply to the economy, and/or

the environmental consequences of their production and consumption.” (OECD, 2008). This kind of study splits the whole industry chain into sub-components by phases of material processing and use. Many MSA have been made on different type of materials, such as aluminium (Liu et al., 2011), food (Ju et al., 2017) or even more recently a whole country economy (Kovanda, 2021). Indeed, Kovanda, (2021) mapped the economy of Czech Republic using a MSA and simple transformation and consumption stages. He called this type of study Economy-Wide Material System Analysis (EW-MSA) and the systematic diagram he used to describe each industry is represented on Figure 6.

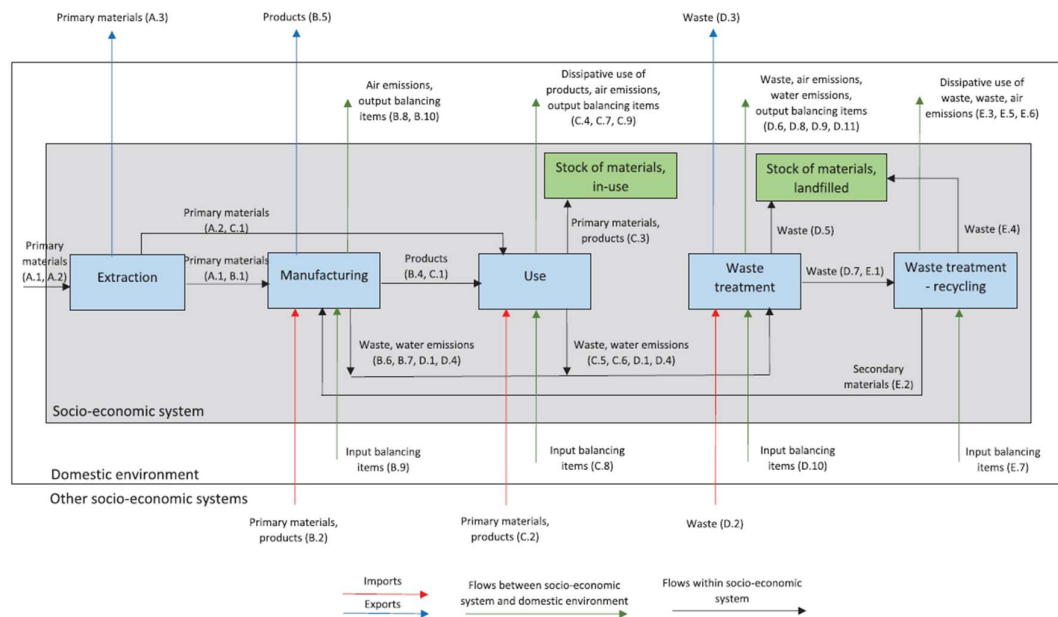
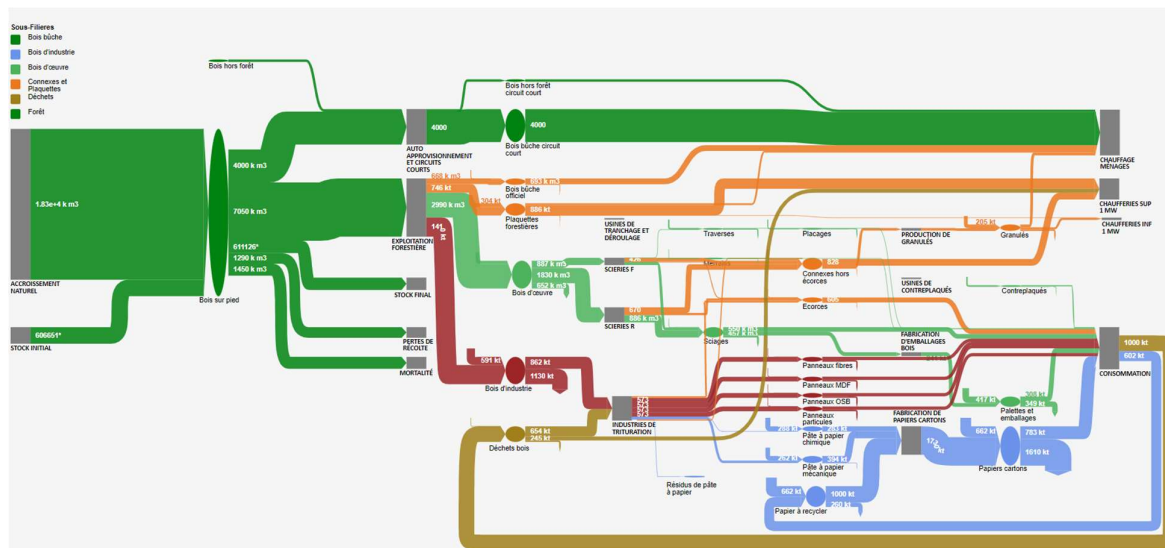

Figure 6 - A visualization of an EW-MSA system, its boundaries and major types of material flows (Kovanda, 2021).

Although being very close to what is expected to build the structure of supply chains for the model, the logic for constructing MSAs is to study an industrial system with life cycle wide inputs and outputs. Here, however, it is more interesting to study the linked flow of products derived from a raw material, as an SFA would do, but then to apply a multi-criteria assessment in a differentiated step. This would allow to build independently the structure of the material chain from the multi-criteria evaluation, which is what is desired here. Moreover, MSAs are focused on the processing industry, whereas here a methodology is sought that focuses on the goods produced, and thus ultimately on the needs of the population. Thus, an intermediary approach has been created where the black box of the industrial economy is open to produce goods, as with MSAs, but where the biophysical description follows products created from a raw material and not life cycle-wide inputs and outputs, as with SFAs. **This approach was named MFA on the level of goods (Baccini & Brunner, 2012) or in other terms Supply chain Material Flow Analysis (SC-MFA) (Courtonne, 2016).**

The very essence of the construction of the SC-MFA is to trace “the associated flows from the extraction of raw materials to the processing, trade and consumption of the [only] derived products based on the resource under consideration” (Courtonne et al., 2015). Another way to put it is that SC-MFA tracks only one base material per supply chain, and thus the mass conservation is performed only on the material of interest itself, and not on the system of transformation, which differs from MSA. To do this, **an identical equivalent material unit must be taken along the supply chain**, such as cubic metres of dry wood as it



can be seen on Figure 7 which represent a Sankey diagram<sup>4</sup> of the forestry supply chain in the French region Grand Est.

*Figure 7 - Sankey diagram of the forestry supply chain in the region Grand Est (Terriflux - Filière Forêt Bois Grand Est, 2021).*

Thus, the subject of study in a SC-MFA is the transformation and usage of a given raw material, and in this sense, one could almost speak of an SFA, except that the subject of study is the good produced, and therefore the response to a societal need. In addition, this methodology of material flow construction takes into account exchanges with surrounding economies, but does not take into account exchanges with the environment, through life cycle wide inputs and outputs as the MSA would do. **This allows to greatly simplify the construction of supply chains and to conduct the multi-criteria analysis in a stage completely dissociated from the construction of the material flows.** This makes it notably possible to modify the flows of the system when ones want to create a socio-technical alternative and to re-evaluate automatically the socio-technical alternative easily.

One of the notable points of this approach is that it allows for the use of national databases, thus avoiding the need for detailed field studies and surveys. More details will be given in Part II.1. which will outline the methodology used to arrive at different supply chain scales based on national data. However, one thing to note with this method of constructing SC-

<sup>4</sup> Sankey diagram is a type of flow diagram in which the width of the arrows is proportional to the flow represented.

MFA is that the detail of supply chains depends directly on the quality of the data used to describe them. Thus, some supply chains may be much less detailed and will give rise to less accurate SC-MFAs. Furthermore, the use of national database allows for the study of flows between industrial sectors but not across collection or distribution networks so these stages will generally not be present on SC-MFAs.

Thus, as it can be understood, the methodology adopted to describe the biophysical description of supply chains is the one of SC-MFA which was created to track the flow of materials that meet a societal need through the production of a good, and to be able to evaluate it in a multi-dimensional way afterwards. To provide the multi-dimensional evaluation which provides further information about the system under study, MFAs have to be coupled with other analysis methods.

## **2.3 Coupling MFAs with other assessing methodologies**

SC-MFA already make it possible to highlight a number of interesting points and to answer, completely or partially, questions such as: “What are the material requirements of an activity or an economy? To what extent is an activity or an economy dependent on external material inputs or on external material markets? How efficiently are material resources being used? Which potentials for improvement in resource productivity exist?” (OECD, 2008).

### **2.3.1 Establishing environmental pressures and impacts due to the production of goods**

However, without further analysis methods, questions such as: “What pressures are associated to each life-cycle stage? What pressures are embodied in a specific consumption? What are the production and consumption footprint of a region?” (Courtonne et al., 2016) remain unanswered. Thus, one of the most observed coupling of methodology assessment with MFAs, and quite logically, is the coupling with Life Cycle Assessments (LCA) (Courtonne et al., 2016; Mancini et al., 2015; Rochat et al., 2013). LCA is a “cradle-to-grave or cradle-to-cradle analysis technique to assess environmental impacts associated with all the stages of a product's life” (Muralikrishna & Manickam, 2017). This coupling is quite simple to do as it allows the impacts of a product to be broken down at the different stages of its transformation chain, thus being highly compatible with the supply chain approach taken here. Among others, this coupling makes it possible to study greenhouse gas emissions, water use, land use change or the energy required for each step along the supply chain. Moreover, as supply chains allow production to be linked to consumption, environmental accounts can both be built from the producer and from the consumer perspective. So, it is possible to estimate what is emitted and what are the resources used by a specific regional activity, as well as to link these impacts to a consumer and to estimate what is emitted and used to produce a given good.

It is to be noticed that the approach used has at least one drawback. Indeed, the information contained within databases to establish material supply chains is rather poor, and it is generally not possible to say precisely which manufacturing process was used. Since some products can be produced by several processes that are more or less polluting, additional

qualitative knowledge is therefore required to obtain information on the process used in a specific region, or country, to match the correct LCA with the completed SC-MFA.

**The coupling MFA/LCA thus makes it possible to take into account the environmental impacts resulting from the processing of the raw material to the end product.** It makes it possible to identify the most impactful stages as well as the basic needs, in terms of space, energy or water for example, to understand the biophysical prerequisites for the existence of such a chain.

Another analysis of MFAs can be performed using Absorbing Markov Chains (AMC). AMC is a “mathematical representation of a system as a collection of states”(Duchin & Levine, 2013) which allows notably to analyse certain properties of a network of flows. This representation applied to MFAs makes it possible to define a specific network of resources within an economy, i.e., to establish a network following resources from their extraction in one region to their incorporation into semi-finished products and then into final goods, regardless of the regions where these stages are located (Duchin & Levine, 2013; Courtonne et al., 2016).

Using this method, one can, for example, produce the maps in Annex 3, which show the flows linked to the bread consumption and their connection with all French regions. AMC can thus show the specialisations as well as the interdependencies between regions in a supply chain. By being able to trace flows, it also allows to directly identify the territories impacted by the resource uses and pollutant emissions established by the further coupling with MFA and LCA.

### 2.3.2 Coupling SC-MFA with economic and social sciences analysing methods

The aim of the coupling with other assessment methodologies is to add not only environmental, but also social and economic elements of analysis.

Couplings of economic models together with MFAs have been performed to provide more exhaustive information to decision makers for over 20 years. Beaussier et al., (2019) distinguish two kinds of coupling: low-level and high-level ones. While the former refers to models that are run separately and in which the outputs of one model are the inputs to the other, the latter refers to models that are linked and run at the same time, interweaving economic, material and environmental variables at the same time. Here, only low-level couplings will be discussed, where the results of the MFA set the framework of the calculations for the economic model.

Due to the existence of a high number of economic models, many kinds of economic coupling can be made with MFAs. Examples include Dellink & Kandelaars, (2000), who coupled an Applied General Equilibrium (AGE) model<sup>5</sup> with a material flow analysis to analyse the impacts of various fiscal policy scenarios on the use of zinc and lead, and their effect on physical and economic flows. This kind of analysis showed notably that a regulating

---

<sup>5</sup> AGE model contains households and production sectors, in which the demand and supply are set with the standards of neo-classical economic theory and which are empirically calibrated (Dellink & Kandelaars, 2000).

tax on the use of a certain material could have negligible impacts for households as long as it is accompanied with a reduction in existing labour taxes. Moreover, this kind of taxes would reduce the total use of materials but at the expense of production for the domestic economy, which would logically be lower.

Another example is the coupling between a bio-economic recursive model<sup>6</sup> and a SC-MFA in the forestry sector (Lenglet et al., 2017). This study showed notably that the sector was mostly unprofitable because the value added of the supply chain was created in other countries. Thus, based on this observation, the authors aimed at examining different subsidies or taxation policies to change the quantities of exported logs and imported wood products. They showed that there was no first best policy option because each scenario had different impacts on wood exportation as well as budgetary and social costs, with high differences in total welfare variations.

Regarding social sciences' perspectives being coupled with MFAs, there are so many of them that it's hard to give an overview of what can be done. Generally, the idea of linkages with social sciences is to bring qualitative arguments of description and understanding of scenarios in addition to the quantitative physical description. For example, Debusson, (2014) provides a grid of analysis for local supply chains, which can be used in order to identify obstacles and levers of action to develop sustainable development strategies for the territories. This grid is composed of three different parts, being actors, collective actions and their environment (see Annex 4). Actors are characterized by both their position and their role in the supply chain, collective actions are qualified by their mode of interaction, their membership, their size and their proximity with the supply chains and finally the context is defined by the social, the policy and the ecological aspects of the interactions between the actors. This kind of segmenting allows the chain to be represented notably from a societal and institutional perspective.

Other more social quantitative linkages can also be established, for example to quantify employment at different steps in a supply chain. As an instance, Courtonne, (2016) crossed data from the ministry of agriculture with the MFA presented in one of his study on forestry (Lenglet et al., 2017) to characterize the labour and material intensiveness of different sectors along the supply chain. By coupling employment, turnover and biophysical data, he highlighted the percentage of self-employment in each sector, the wealth creation along the supply chain and the employment required per material processed. Although these numbers depict a current reality of the chain and cannot be used directly to make projections (Courtonne, 2016), one could imagine making further studies to be able to adapt these numbers to specific scenarios. It could then be possible to estimate the numbers and the type of jobs required along the different supply chains forming a socio-technical alternative.

Thus, it was seen that the scientific communities to which the biophysical description adopted in the model are all related to ecology, that among the various tools used in these

---

<sup>6</sup> The bio-economic recursive model is the FFSM++ model which link an inventory-based model of the resources together with both a partial equilibrium model of the market of forest products and a microeconomic model allocation of the harvested areas. (Lobianco et al., 2015)



communities, the SC-MFA framework will be used and finally, that many economic, social and environmental couplings can be carried out to characterize the supply chain as well as the territories related to it. Next part will describe the methodology established to describe the different sectors with SC-MFAs.

---

## SC-MFA construction methodology and results obtained on the French economy

This part will deal with two aspects: the methodology for constructing the SC-MFA and the results obtained by applying this methodology to several supply chains of the French economy.

### 3.1 SC-MFA construction methodology

To understand why this methodology is used, it is important to understand that it was created in order **to rely only on official data and not to have to resort to specific surveys or studies in a logic of efficiency**. However, official data mostly describe France on a national level, so a downscaling step is required to scale down the SC-MFAs established to the different sub territories composing France.

Furthermore, the methodology of construction of SC-MFAs will be presented as a linear process where each step follows the other, but in reality, it follows much more an iterative method where the construction of the supply chain is made by repeating several steps or going back to the previous steps multiple times.

Regarding the number of steps, the methodology is based on a process composed of five steps:

- **structuration of supply chains;**
- **data collection;**
- **reconciliation of the data;**
- **analysis of the diagrams through visualisation, discussion and confrontation;**
- **downscaling.**

Although the downscaling step is presented here, it has not been implemented for the establishment of French supply chains. Indeed, only the establishment of supply chains at national level was expected during the course of this work. Downscaling will therefore only be presented in the methodology to allow the reader to understand how it is intended to have a multi-scale view of supply chains with national data.

#### 3.1.1 Establishing the structuration of supply chains

To begin with, the structuration of a primary material supply chain is made through the identification of its different derived goods, its successive industries of transformation and its final uses. The derived goods that fall in the scope of study are primary material, semi-finished products, by-products and end products. The successive industries refer to the places where transformations of the derived goods occur and final uses are the sectors of final consumption of the end-products.

To structure a logical framework including these pieces of information and which can in the end be represented by Sankey diagrams, Supply-and-Use Tables (SUTs) (see Table 1

and Table 2) appear to be one of the most convenient ways of organizing the information. They include two different tables: a supply table, which indicates the origin of the goods, and a use table, which indicates the destination of these goods. By combining these two tables, it is possible to describe the whole flows and steps of production and consumption of the supply chain.

	industry 1 .. industry m	imports
product 1 .. product n	$V_{ij} (n,m)$	$I_i (n,1)$

*Table 1 - Supply table and matrices notations. The numbers in brackets indicate the dimensions of the matrices (Courtonne, 2016).*

The information which are in the supply table can be read as: industry  $a$ , with  $a$  in  $[1, m]$ , produces product  $b$ , with  $b$  in  $[1, n]$ , according to the quantity contained in  $V_{ba}$ . Similarly, imports of product  $b$  are entered in vector  $I$  at line  $b$ .

In parallel, if one looks at the resource table, it can be read as follow: industry  $a$  uses product  $b$  according to the quantity contained in  $U_{ba}$ . Moreover, product  $b$  is exported according to the value  $E_b$  and it is consumed according to the value  $C_b$ .

	industry 1 .. industry m	exports	consumption
product 1 .. product n	$U_{ij} (n,m)$	$E_i (n,1)$	$C_i (n,1)$

*Table 2 - Use table and matrices notations (Courtonne, 2016)*

The difficulty of this exercise lies in finding the appropriate level of details for goods, industries and uses. Indeed, the construction of the supply chain requires a good knowledge of its structuration but the gathered data do not necessarily fit exactly the categories that were originally planned. While it is generally interesting to have granularities that are precise enough to have a fine analysis, data do not necessarily reflect such a level of detail. Therefore, the construction is usually not achievable in one go and requires an iterative process in which the SUT creator oscillates between looking for sources of information and trying to fill the tables.

### 3.1.2 Collecting data

Concerning the sources of information, the data mostly rely, if not only, on official statistics at the national scale. They are provided by different institutions. The main source of information is the “Service de l’observation et des statistiques” (SOeS) whose mission is “to organize the socio-economic and statistical observation system for housing, construction, transportation, energy, environment and sustainable development” (*Données et études statistiques pour le changement climatique, l’énergie, l’environnement, le logement, et les transports*, 2022). It provides both monetary data and physical data. In particular, they publish reports on all the topics mentioned above and provide key figures for the various sectors.

Another national agency publishing reports on different materials is the “Agence de l’environnement et de la maîtrise de l’énergie” (ADEME). They have notably published a report on the current use of several material and energy as well as projections for the French industry (Rauzier et al., 2020).

An interesting European direction is the one of Eurostat which role is to construct and publish official statistical data for the European Union at the community level, i.e., for each country. They notably publish material flow and resource productivity accounts data base, but which tend to use categories that are much too general to make supply chains. However, this allows to give orders of magnitude of the material flows circulating at the national levels in the European Union. They also publish statistics on the production of manufactured goods, the data base being called Prodcop. In this case, it is quite detailed since it uses the 6- or 8-digit nomenclature that has direct correspondences with the Combined Nomenclature (CN) used at the world level.

Some sectors have been dealt with by using data provided by specific national agencies, such as the construction sector, which has relied on the « Bureau de recherches géologiques et minières » (BRGM), but also on different unions such as the “Union Nationale des Industries de carrières et matériaux de construction” (UNICEM), the “Centre d’information sur le ciment et ses applications” (infociments) or the « Union Nationale des producteurs de granulats” (UNPG).

Finally, the work was also based on data provided by associations, such as Negawatt for the energy sector. Indeed, since they work on creating foresights of France based on an ambitious energy transition, they provide a large database on current energy production in France.

Besides that, it is to be noted that the more there are sources of data, the more the chance that there is a non-compatibility between different sources is high. The incompatibility can be of different natures, such as a difference in the scope or in nomenclature which both make it difficult to compare data and to use them, a difference in absolute value for a same flow (inconsistency) or a difference in unit, which can be a big deal for the wood sector as an example (Lenglet et al., 2017). Therefore, it is necessary to make the data compatible with each other and to have, in the end, a single unit for all the values.

### 3.1.3 Data reconciliation

In order to solve these data problems, a process of reconciliation providing further physical constraints on the SUTs has been established. The reconciliation is based on the respect of the principle of mass conservation throughout the Sankey diagram and is greatly inspired from the methodology used by Cencic & Rechberger, (2008).

To understand the vocabulary used thereafter, differences between three types of variables must be specified. The term “variables” refers to data representing material flows in MFAs. They are represented in Annex 5, and they are namely:

- Measured variables

- Redundant variables
- Unmeasured variables
  - Determined variables
  - Free variables

Measured variables are values which are filled in by the MFA maker. Redundant variables are thus values that are filled in and constrained by other values.

Unmeasured variables are variables which need to be determined by an algorithm because there is a lack of data. Determined variables are variables that can be calculated based on the already existing values, while free variables are variables which are not constrained by the other values entered and not filled in. Free variables may therefore have a range of possible values which depends directly on how the algorithm establishes the mass balance and how it explores the field of possibilities.

In more details, the reconciliation has two main objectives. The first, is to minimize the difference between input and output data while taking into account the reliability of sources and respecting constraints of material balance. This is directly linked to the uncertainty of measures variables. Indeed, even if they are provided by national agencies, they carry uncertainties, which can be pretty high and which are often not communicated.

Moreover, another important point concerning uncertainties of data is that the output uncertainties of the model are estimated based on the propagation of the input uncertainties. This allows notably to support the discussion with experts on what is robust or not in the model, and thus to see which parts should be given the most resources and time to find more data.

The second objective of the reconciliation process is also to fill the gaps where data is lacking. Indeed, not all official data sources allow for the tracing of a whole supply chain. Thus, it is the reconciliation process which has to calculate both determined and free variables through the MFA to respect the mass conservation principle. In the case of free variables, the output given by the reconciliation is a range of possible values, meaning that there are not enough constraints on the flow to establish its value. However, as it is implemented currently, the reconciliation process still returns a value, while indicating the range of possible.

In view of the above, it is clear that not all data displayed on MFAs have the same degree of certainty. While, measured variables are real data but which carry uncertainty due to the method of reporting, unmeasured variables are just lacking data which need to be filled in by calculations, or even by determining a range of possible values since there is not enough constraints. This forces one to be cautious about the final representation of MFA under the form of a Sankey Diagram as it can be very uncertain, while suggesting that it represents the physical reality of material flows.

### 3.1.4 Analysis of the diagrams

Finally, the analysis of the data is made through a constant back and forth between reconciled data and the Sankey Diagram, in order to understand why such flow has this shape/value. Then, once everything is clarified, Sankey Diagrams can be used for several purposes.

A first step is to look at what the simple visualization of flows tells us about the supply chain. Among others question which can be answered, at least partially by SC-MFAs, one could think of: What are the material prerequisites for manufacturing a good? Is there any vulnerability of a sector, especially with regards to imports and exports of a material? Could there be competition for resources between several processing sectors within a territory? Is there a total dependency of the territory under consideration on other territories? Is the territory specialized in the transformation of a resource?

Most of the time, to get more information, MFAs are also coupled with other analysis methods during this phase, as it was presented in part I.3. These additional analyses allow MFAs to deliver more information through the addition of environmental, social and economic dimensions that were not apparent before and thus, to bring the supply chain back to the heart of the society.

Finally, it is also during this stage that the solidity of the established MFA can be verified with the confrontation of the data with those held by experts of the sectors. Data held by these experts allow them to say whether the structure of the sector is accurate and possible, to specify certain data and thus to increase the level of granularity of the study, as well as to validate the general relevance of the diagram. They can also provide qualitative information on flows, useful for coupling MFAs with other models.

It is to be noted that this step of analysis has not really been achieved completely in this work, since the assignment of the internship was to make the Sankey diagrams of the major sectors of the economy as quickly as possible and not to go into detail on each diagram.

### 3.1.5 Downscaling national MFAs to the scale of territories

Finally, in order to have a multi-scale view of the supply chains while being based on national data, a downscaling step of the material flows established at the national level is required.

The downscaling of the different SC-MFAs requires first the search of other sources of data at the local scale. This is usually possible for some administrative entities such as regions which have specific regional agencies providing data. However, as soon as one moves to the sub-regional level, or to some other division of the space such as a city, it is very complicated to obtain information. So, to tackle this issue, a methodology of national data downscaling has been developed which uses proxy to convert data at the national scale to the one of a given sub-territory. Proxies are intermediate variables that allow, by a simple calculation, to reduce the size of the flow to that of the territory.

To give some examples, these proxies can be number of employees in a given sector, a rate of use between two flows, a number of factories, etc... In fact, anything that could help to go from the national scale to the territory's one. Most of the time, if not always, a simple cross-multiplication is done with one proxy to calculate the missing data. As an example, if a flow of a given material at the national scale is of 500 tonnes and there are 15 employees in its production sector, and that inside the territory there are only 3 employees of this same production sector, the downscaling would result in a territory-wide flow of 100 tonnes. Of course, this is an approximation, and there are non-linearities effects. However, good approximations can be made based on "simple one-explanatory-variable-linear model" (Courtonne et al., 2015).

After the downscaling of the national data at the territory level, it is necessary to repeat the step of analysis of the material flows established.

Now that the SC-MFA construction methodology has been established, the following will focus on the SC-MFA construction perimeter.

## **3.2 SC-MFA construction perimeter**

Before presenting the results of the construction of the SC-MFAs, it is necessary to know which processing and material consumption chains are to be studied.

### **3.2.1 Supply chains that need to be explored**

As said in introduction, raw materials are distributed into four different categories: biomass materials, non-metallic minerals, metals and fossil fuels. These categories can be disaggregated into sub-categories to give a greater detail of the raw-materials, as it can be seen on Figure 8.

Of all the categories described above, biomass has already been extensively studied by some members of the research team. Indeed, this sector is of particular importance because of its key role in the ecological transition and its almost ubiquitous presence over all territories. As a result, many detailed sectors are already given for French territories such as the wood, the cereals, the straw, the meat or the milk sector (Terriflux & STEEP, Ongoing project). As the supply chains of this raw-material category have already been carried out, the biomass sector is outside the scope of this report. Attention will therefore be paid to the other three types of material.

Moreover, the study of the waste sector was also planned. It could be possible to treat each flow of waste straight in the four previously named categories, nevertheless, due to the reality of waste treatments and therefore the structure of underlying data concerning wastes, they'll be treated separately as if they were a fully-fledged material supply chain. The existing links between sectors and their waste will make it possible to draw some connexions between the waste sector and other raw material categories if the need arises later.

Finally, two additional supply chains were to be explored: the energy and the water sector. It is notably due to both their importance in the transition towards a sustainable society, and to the fact that these are two necessary resources for the production. **Thus, six supply**

chains had to be explored, e.g., the non-metallic minerals, the fossil fuels, the metals, the wastes but also the two resource sectors, being composed of the water and the energy sectors.

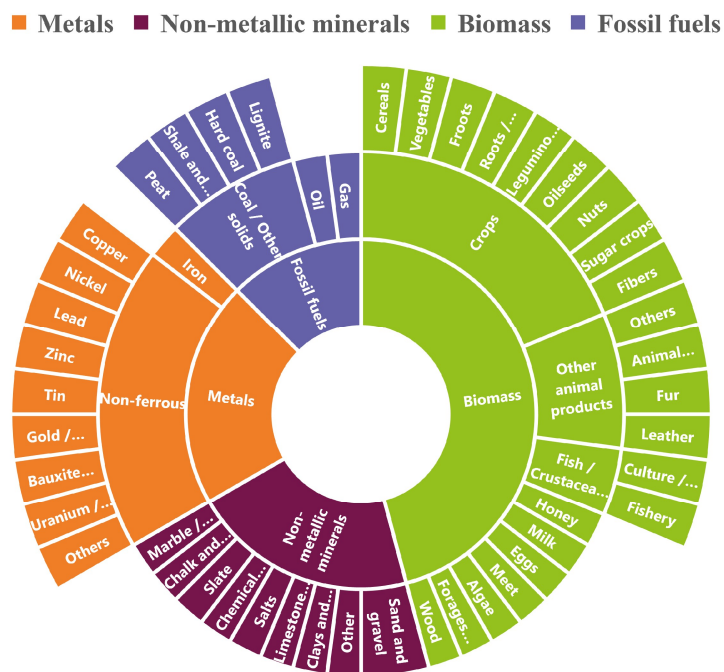

Figure 8 - Raw materials used in supply chains. Source: the author.

### 3.2.2 Weigh of raw materials in France

To give a more explicit representation of the importance of raw material flows (and their linked products), Figure 9 provides a mass-weighted representation of the four raw material sectors (including other products) based on recorded data from Eurostat, (2018). As expected, non-metallic minerals are by far the largest flow in mass (Miatto et al., 2017), accounting for more than 50% of overall material use in France, of which sand and gravel make up the very large proportion of the mass, as it can be seen on Figure 10. Biomass accounts for almost one third of the total mass of used materials, while fossil fuels and metals account respectively for approximately 16 % and 3 % of the total materials use in France. The total apparent French domestic material consumption<sup>7</sup> weighted 760 million of tonnes in 2018 according to data from Eurostat, resulting in an average domestic consumption of materials per French person of approximately 11.3 tonnes.

<sup>7</sup> Domestic Material Consumption (DMC) “is defined as the annual quantity of raw materials extracted from the domestic territory, plus all physical imports minus all physical exports.”



Concerning wastes, their mass for France in 2018 were as high as 343 million of tonnes (SOeS, 2021) representing 45 % of the apparent domestic consumption for the same year. This results in a mass of waste per French person for the year 2018 of 5.1 tonnes

Regarding water and energy flows, they will be treated separately and expressed respectively in millions of m<sup>3</sup> (Mm<sup>3</sup>) and in Terawatt-hour (TWh). The global activity of France led to a consumption of 38 000 Mm<sup>3</sup> of water in 2013 (SOeS, 2017) and to a final consumption of 1830 TWh of energy in 2015, including fuels for transportation (négaWatt, 2017).

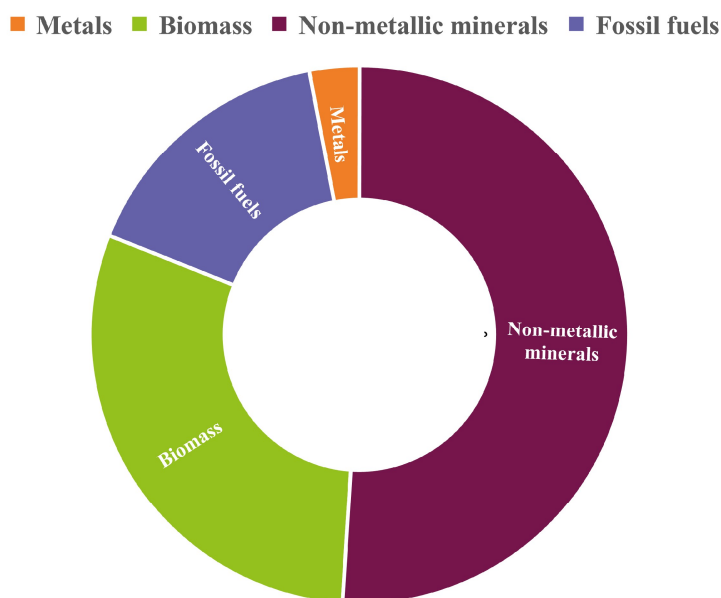

*Figure 9 - Apparent French domestic consumption of materials weighted in mass in 2018.  
Source: data of 2018 processed from the website Eurostat.*

### 3.3 Results for the supply chains embedded in the French economy

Now that the supply chains to be built have been identified, along with an initial view of their material weight, results obtained will be examined at the national scale. In this part, MFAs will be presented under the form of Sankey diagrams. Only two of them will be shown in the main text, for reasons of space use. The others Sankey diagram will be found in Annex 6. It can be noted that, depending on the supply chains, the information can be quite rich, and it is possible to operate a fine decomposition at the level of a given material, or on the contrary, they can be quite poor, and it is only possible to study the materials and their transforming steps aggregated.

In addition, to understand diagrams, it should be noted that colours used do not matter. They are for the most part representative of the materials used, but from time-to-time tests have been done with palettes that have no special relationship to its linked materials, but more in

relation to the manufacturing stage. Furthermore, there will also be hatched flows on some diagrams. This means that these streams are free variables which value is contained in a range, and which are therefore not that much accurate even if represented as such. It means that these values should be treated with caution.

Finally, years are not the same for each Sankey diagram displayed. This is usually due to national or European publication requirements, or to timeliness of the reports, which result in data being present for some years and not for others. For this work, the most recent years were preferred when several data sets were available.

### 3.3.1 Non-metallic minerals

To begin with, the supply chain of non-metallic minerals will be analysed since it is a supply chain that weighs half of the materials used in the French economy.

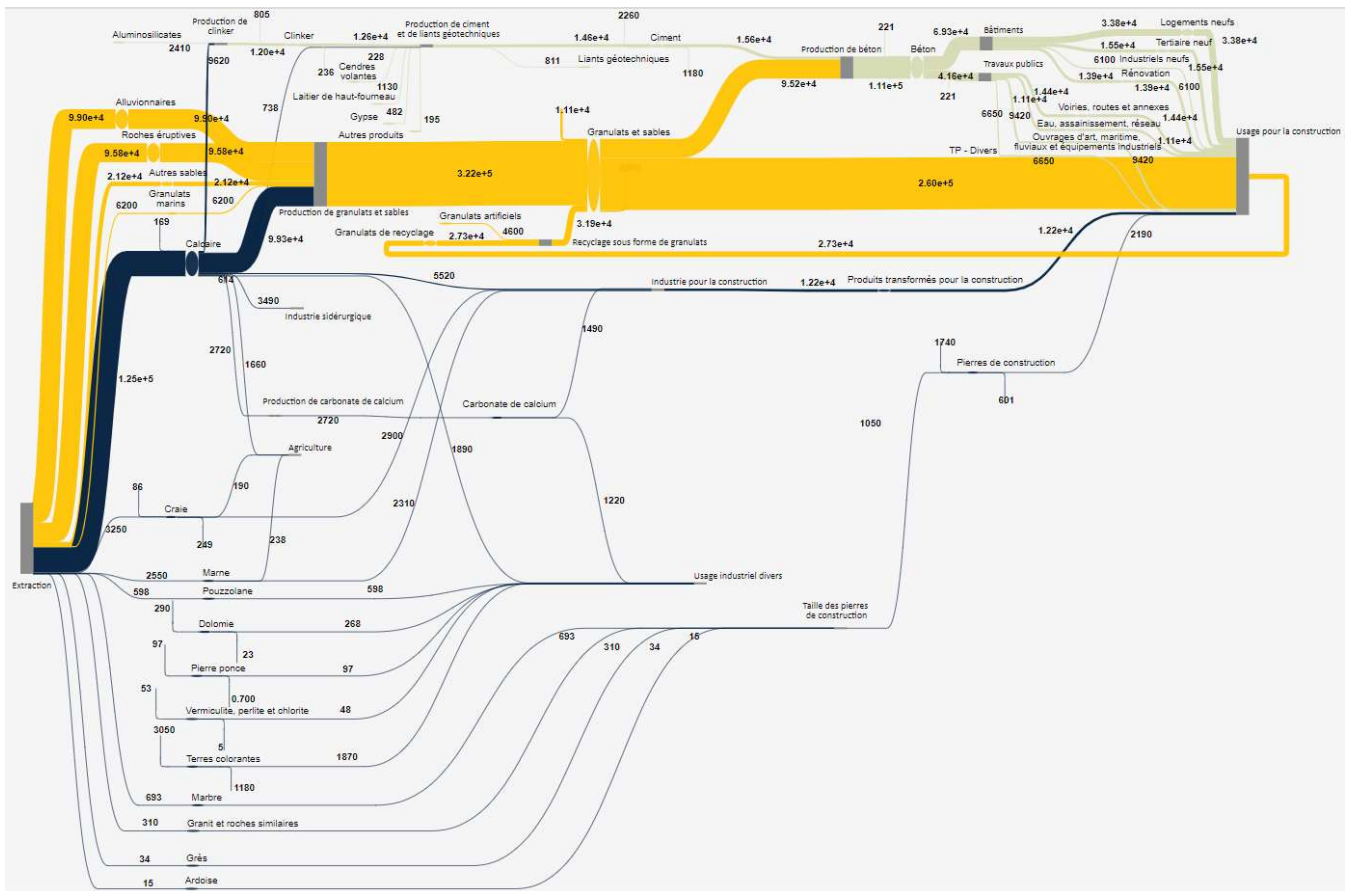

Figure 10 - Sankey diagram of non-metallic minerals for France in 2018 (in thousands of tonnes - kt)

What can be seen first, based on the Figure 10, is the importance of the mass of non-metallic minerals that is used for the construction sector. Indeed, the construction sector uses more than 97 % of the mass of non-metallic minerals, most of its mass coming from granulats. Other consuming sectors are agriculture, steel industry and other miscellaneous industries, which altogether account for less than three percent of the total mass of non-metallic minerals.

Marl, chalk and limestone are used in agriculture because they provide an alkaline input for fields with too acidic a soil, while limestone is used in steel industry to purify and to modify the composition of products obtained in the steel mill.

Moreover, the vast majority of the mass is provided by granulates. Indeed, more than ninety percent of the total mass of non-metallic minerals comes from them. They come mainly from three types of rocks: alluvial, eruptive and limestone rocks. Almost one third of the granulates is directed to the production of concrete. The other two thirds are mainly used in public works, especially roadways and railways.

Only a small fraction of granulates is shown on this Sankey as recycled (31.9 Mt), but this depends on the counting method. Indeed, on this diagram, only granulates that have been recycled on platforms equipped with fixed processing facilities have been counted, which is only a quarter of what is counted as recycled by the UNPG. As a matter of fact, they highlight 121.5 Mt of recycled granulates used for the year 2018 (UNPG, 2020). This includes aggregates extracted and directly reused on site which account for almost half of these granulates, as well as aggregates recycled on mobile platforms. This choice was made because it corresponds to the recycled waste put forward by SOeS, (2021), which is displayed in the waste supply chain in section 3.3.4.

Furthermore, it can also be seen that about two-thirds of the concrete manufactured in France is for building construction, with nearly half of this concrete used for new housing construction, and only one-fifth of this concrete used for building renovation. The remaining third of the concrete is used for public works, in particular for roads, water networks and engineering structures.

Finally, it is also interesting to note that the vast majority of the materials used are extracted directly from French soil, with the exception of a few rocks used in industry, notably for colouring earths, vermiculites, dolomites or sandstones.

### **3.3.2 Fossil fuels**

On the diagram of fossil fuels in Annex 6, it can be seen that it is the opposite of non-metallic minerals: almost everything is imported. Only little bioethanol and biodiesel are produced in France.

Moreover, we can see two things: our dependence on fossil fuels is mainly on oil for transportation and petrochemical industries, and on gas for heating and electricity generation. Coal is used to a much lesser extent, but in an important role in steel industry, as well as a little in the generation of electricity.

Regarding gas, the residential sector is the largest consumer with 26.2 Mt, followed closely by industry with 22 Mt and the tertiary sector with 15 Mt. As for electricity generation, it consumes only 14.3 Mt of gas per year. Very little gas is used in other areas. The part of gas imported and re-exported on this graph is in fact a crossing flow of gas through France.

Concerning oil, we can see that most of it is transformed on French soil, especially for petrochemical uses, but also for the production of diesel and gasoline. Even if most of the fuel

is transformed on French soil, it is still possible to see that a large part of the fuel used in transportation is imported directly, especially for diesel and heavy fuel oil. Concerning its consumption, one can see that diesel is the most used fuel, due to the big rate of diesel motorizations of the private vehicles in France. In fact, households consume the most oil for their travels, followed by company transport, and finally boats and planes. Moreover, biofuels are a small minority of total fuel consumption, accounting for less than 4% of total travel fuel consumption.

### 3.3.3 Metals

In the case of metals, few supply chains have been studied compared to the number of metals in circulation in the French economy. Indeed, only 4 metals were studied, namely steel, aluminium, copper and lead. This is due in particular to a rather flagrant lack of information, because of their dissemination in many finished products. Moreover, many of them are neither transformed nor treated as a waste in France, and there would therefore only be flows in the form of imports, a use flow and a re-export flow in the form of waste, which is not necessarily interesting, except to show the dependence of France on these products. However, it is to be noted that steel, aluminium, copper and lead account for the vast majority of the mass of metals circulating in France.

In the case of steel, it can be noticed on Annex 7 that steel products come as much from the processing of iron ore as from the recycling of steel scraps. There is also nearly the same amount of steel product import than of steel product exports, respectively 12.1 Mt and 13 Mt of steel products.

Only few information is given about the final consumption, being the total amount consumed of approximately 12.5 Mt and the amount of steel of recycled each year. More than eighty percent of steel products which are consumed in France are recycled. Forty percent of the gathered steel products are exported and the other sixty percent are processed back into other steel products. Of these sixty percent, half of the mass is operated in electric steelworks, and the rest is a mix of operating through blast furnaces and foundries.

In the case of aluminium, about one quarter of France consumption is extracted on its territory under the form of bauxite ore, as it can be seen in Annex 8. A great majority of materials is imported, whether it is primary aluminium, secondary aluminium, aluminium products or aluminium scraps. 58% of the importations is under the form of semi-finished aluminium products, or under the form of products containing aluminium. It is to be noted that French consumption of aluminium is of 1.38 Mt, which is approximately 10 times less than steel.

Regarding recycling, 46% of aluminium is collected and, taking into account the imports of aluminium scraps, approximately one third of this aluminium is exported. The rest is oriented towards the recycling process. About half of the aluminium transformed into semi-finished products is secondary aluminium, i.e., aluminium that has undergone a recycling transformation.

In the case of copper, all materials entering the French economy are imported: there is no more copper extraction in France as it can be seen on Figure 11. Approximately one third of the imports are in the form of refined copper, one third in the form of semi-finished products such as cables or rolled products, and one third in the form of finished products. It is to be noted that there are as many semi-finished and finished products which are imported, as which are exported, meaning that France is specialized in the processing of some copper products and/or that there are many flows of copper crossing France.

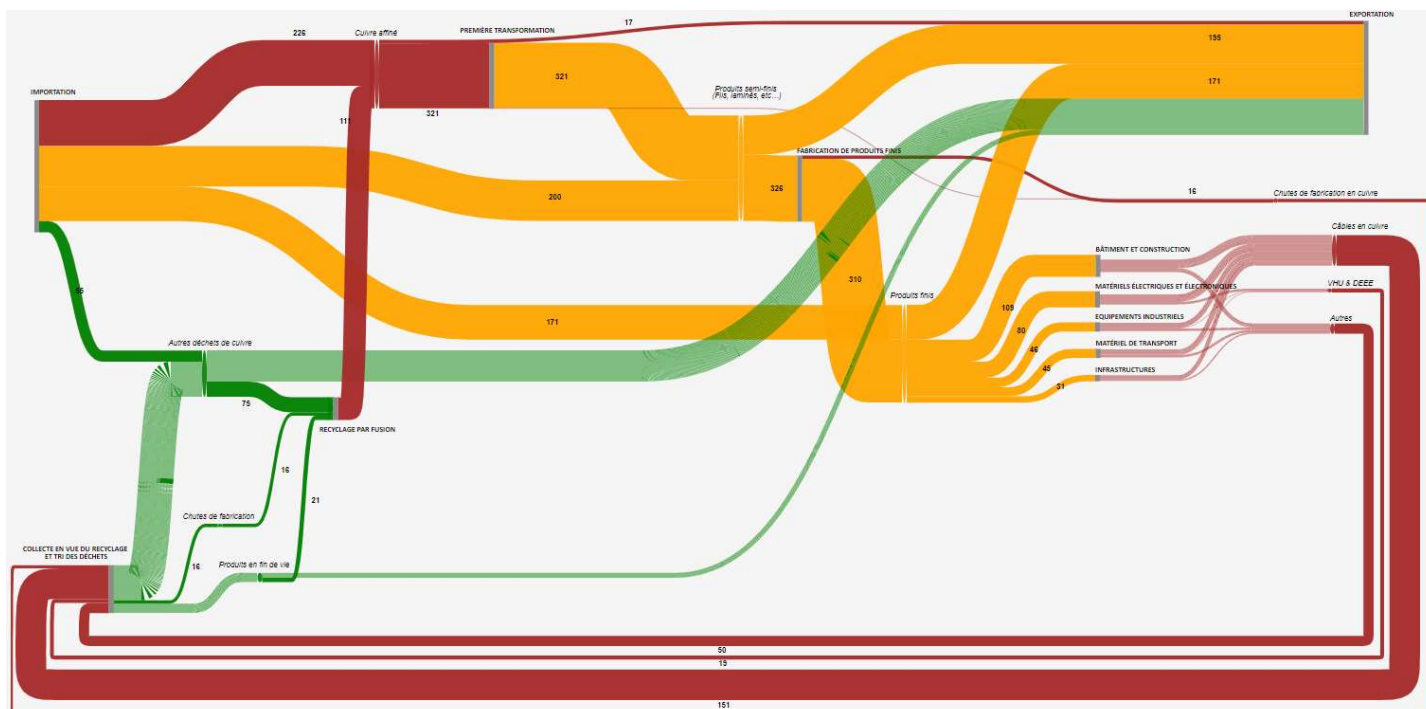

Figure 11 - Sankey diagram of copper for France in 2017 (in kt)

Concerning consumption of finished copper products in France, it is noticeable that 109 kt of copper is used for cables in building construction, 80 kt of copper is used in electrical and electronic equipment, respectively 46 and 45 kt are used in industrial equipment and transport equipment and 31 kt in infrastructure with mostly cables.

Wastes are mainly cables, as well as copper electronics present inside vehicles and Waste from Electrical and Electronic Equipment (WEEE). Their collection is quite good with 77% of copper collected and sorted. 111 kt of collected copper is directly recycled in France with a fusion recycling process. This type of process is made for non-complex materials, which are mostly composed of copper. Thus, more complex copper-based materials are processed abroad in Europe, but also in the rest of the world, with amounts exported of 153 kt.

Finally, in the case of lead, it is visible on Annex 9 that all new materials entering the economy are imported. Most of the imported lead products are in the form of raw lead. The lead is then processed into sheets or plates to produce approximately 100 kt of finished products, mostly lead-acid batteries for vehicles. More than half of these lead batteries are then directly exported.

As far as recycling is concerned, garages, in particular but not exclusively, are obliged to take over the collection of old lead-acid batteries and almost all the lead in circulation is thus collected. Sixty percent of the batteries are recycled by fusion, and the rest of them is exported abroad. Moreover, the year under study was a bit special, because there was a massive destocking of lead batteries for recycling. The reason for this was the higher lead price that year, which led to the sale of these batteries. It is a current practice to stock old lead batteries pending a higher lead price, before destocking everything at the same time.

### **3.3.4 Wastes**

The Sankey diagram of waste in Annex 10 is not very complicated as it reflects the structure of the available data, i.e., how much waste was produced and by which activities, what kind of waste it is, and how it was treated. Many flows are hatched, meaning that it is not clear which activity produces which type of waste, and how each type of waste is treated according to data provided by national agencies.

Concerning the production of wastes, it can be seen that the construction sector is by far the largest producer of waste in mass with 240,000 kt, being close to an order of magnitude more important than the second largest producer of waste: households with 32,000 kt of waste. Then come the industrial and tertiary sectors with respectively 24,500 and 20,400 kt of wastes, as well as sanitation and depollution activities with 22,200 kt.

As expected from the fact that the construction sector is the largest producer of waste, the majority of the waste produced is non-metallic mineral waste. This is followed by household waste, metal waste and biomass waste. Of these wastes, 87,000 kt are landfilled, 22,200 kt are incinerated, with or without energy recovery, 700 kt are spread on land and 215,000 kt fall under the definition of material and organic recycling. Some materials are known to be well-recycled and are thus tracked in recycling percentages, such as aggregates, steel, as we have seen previously, but also composted biomass, glass and paperboard. There are small differences (less than 8 %) regarding the number exposed for granulates and steel compared to previous Sankey diagrams, which is both due to the fact that the considered years are not the same and that there is a small difference in databases used.

### **3.3.5 Energy sector and water sector**

The Sankey diagram of energy in Annex 11 represents the energy used by France in 2015. Each energy is imported, except for green renewable energies which are produced on the French territory. Since data are in TWh, flows are significantly different from those shown in the fossil fuel diagram and which were expressed in kt. However, the same broad conclusions can be drawn regarding the dependence on fossil fuels, as well as their use by the residential, industrial and tertiary sectors.

What can be seen on this graph is the efficiency of nuclear electricity production, being a little more than one third of the energy contained in the consumed uranium, as well as the quantities of energy produced by renewable energy for electricity production and heat generation. It can be noted that biomass is the first source of renewable energy supplied with 141 TWh, followed by dams with 55 TWh, wind turbines and environmental heat generation

with both 21 TWh and photovoltaics with 7 TWh. It is also possible to observe the use of electricity by the different sectors and the amount of electricity exported to the rest of Europe. The residential sector is the largest consumer of electricity with 166 TWh consumed, followed by the tertiary sector with 129 TWh and industry with 111 TWh.

On a different note, it would be also possible to couple the diagram on fossil fuels with this diagram on energy thanks to a methodology of fusion for multi-units data (Borthomieu et al., 2021). This would allow to switch easily from the quantity used in Mt, to the energy it supplies in TWh.

Regarding water, the Sankey diagram in Annex 12 represents water consumed by France in 2013. What is important to note is that the scope of what is here called “water consumed” is broadly the same as that set by the blue water footprint, i.e., direct consumption of surface water or groundwater, with the exception that there are other uses which are also taken into account here such as water consumption for cooling water circuits of nuclear power plants as well as water needs for canal supply (SOeS, 2017).

Moreover, it can be seen that three types of water are consumed: groundwater, surface water and brackish water, which is saltier than freshwater but less than sea water. A first observation is that nuclear power plants are the main water abstractors, with more than 20,000 Mm<sup>3</sup> of water withdrawn each year, including all the brackish water withdrawn, which is unsuitable for other uses, and most of the surface water. Surface water is also consumed for canal supplies, whose water consumption amounts to 5,080 Mm<sup>3</sup>.

Besides, it can be seen that 3,450 Mm<sup>3</sup> of water are consumed by households each year, of which almost forty percent is used for baths and showers and twenty percent for sanitary use. What is also surprising to see is that leaks in the network are extremely important, representing a quarter of the treated and distributed water for a value of 1,340 Mm<sup>3</sup>.

Agriculture consumes approximately as much water as households, with an amount consumed in 2013 of 3,030 Mm<sup>3</sup>, of which more than forty percent of the water is for corn cultivation. Finally, the other industries as well as the tertiary sector consume 2,700 Mm<sup>3</sup> of water, with a very large share of the consumption going to the industries, and in particular the chemical industry which consumes nearly thirty percent of the water needs of the French industry.

The methodology used, the material and resource study perimeter as well as the results obtained in the form of a Sankey diagram have thus been presented in this section.

The next section will focus on showing a first prototype of a socio-technical alternative creation model, since the objective of establishing these material flows is to make an initial description of the economy and to be able to interweave them into a model allowing design of alternatives. There is therefore a need to move from these static descriptions of supply chains to a tool that can be appropriated by the stakeholders in order to construct their alternatives based on a biophysical description of their territory.

---

## Construction of a prototype for creating a socio-technical alternative

The purpose of this work, in addition to establishing the SC-MFAs on a national scale, was also to explore the creation of a simple tool that would allow for modification of a biophysical description of an activity in order to create socio-technical alternatives.

As nothing had been done before on this subject in the research team, it was necessary to simplify the approach presented in introduction to build this prototype. **Thus, the prototype model focused on one sector, at one scale, with one type of evaluation, i.e., an environmental evaluation, and without a participatory framework to question or manipulate it.** It is important to understand here that **this prototype is not really a draft of the model presented in the introduction.** Indeed, it is greatly simplified, but not only: it analyses a sector, cut off from its supply chain, which is not what is desired for the final model. In fact, this first prototype serves above all to understand what are the stakes of modelling which had not yet been thought of, to see how is it possible to concretely allow for the designing of socio-technical organisations, what are the trade-offs which can be put forward with a rather simple modelling of a system, in a few words: to test the viability of such an approach. The sector under study and the main assumptions made to model and evaluate this sector, as well as to enable the design of alternatives, will therefore be detailed below.

### 4.1 Choice of the area to be studied

Several scales of study could have been interesting to implement a first prototype. **However, for time reasons and in order to simplify the supply chain studied, interest was put on a territory where the production of goods is limited: cities.** Indeed, cities import much more material than they export (about 30% less), and some flows are only "crossing flows", which by removing them further increases the relative ratio of material consumption to goods production in these kind of territories (Bahers et al., 2018).

**Regarding the study sector, transportation was chosen to be studied together with an environmental evaluation, since there are many questions pending regarding its sustainability,** whether due to climate changes with greenhouse gas emissions, given that it produces 31% of French Greenhouse Gas (GHG) emissions (Fragkias et al., 2013; Ministère de la transition écologique et solidaire, 2019), due to health issues caused by direct air pollution (Lamsal et al., 2013), or due to numerous other issues such as the heat island effect created by the omnipresence of roads (Nieuwenhuijsen, 2020). In this sense, the major focus of literature regarding the development of more sustainable transportation was made on the reduction of air pollution together with the elimination of CO<sub>2</sub> emissions to invent the post-carbon city (Intergovernmental Panel on Climate Change, 2007), through the promotion of technological evolution of the transport fleet, notably with electric vehicles (Emberger, 2017). Indeed, "the strategy seems to be to replicate the existing car in terms of functionality, size and vehicle autonomy" (Grosclaude et al., 2014).



However, this approach is not relevant to all criteria as it increases resource use or impacts of vehicle manufacture. Yet, such considerations are of primary importance since reports on critical raw material for emerging technologies “reveal a consensus on potentially limiting resources for the electrified vehicle industry” (Directorate-General for Internal Market et al., 2018; Hernandez et al., 2017; Jin et al., 2016). In this regard, maintaining the current modal split of transportation in cities while adopting low-emission propulsion technologies has shown to increase resource consumption and waste generated by cities (Gassner et al., 2021).

Thus, in view of what has been said, it seemed interesting to look at what could be done as a first prototype model in the urban transport sector with an environmental assessment based on material flows. As much work has been undertaken on the environmental assessment of transportation, it was also necessary to draw up an overview of the various already existing contributions on this subject.

## **4.2 Comparison with other approaches to study the field of transportation in France**

Numerous approaches to studying the environmental effects of transportation in France are currently being deployed, orchestrated by different entities, with the vast majority of which aim to foster the diminution of GHG emissions. In our case, some of these approaches are interesting because they give an idea of the measures to be undertaken and quantify them, while others are interesting by the modelling approach they use. Initially, this section will therefore focus on work that has been done on the transition of transport to sustainability in France, even without the modelling aspect, and it will then focus on modelling applications applied to the transport system.

A first interesting project is the plan of transformation of the French economy led by the Shift Project, which has published a guide for low-carbon mobility with recommendations for action (The Shift Project, 2020). It notably highlights that it is necessary to provide a multimodal and systemic response to a deeply entrenched car system which need to be deconstructed and stresses the importance of developing active and shared modes of mobility. However, its policy-oriented approach makes it difficult to appropriate their work and is ultimately quite far from the prototype that is to be developed here. Nonetheless, identified action levers in this report can be significant starting points for use in the prototype, as they can be used as a parameter for designing socio-technical alternatives.

Another approach of transition in mobility embedded in the general transition of society, is the one developed by the French agency of ecological transition in its report “transition 2050” (ADEME, 2021). In this report, they focus on achieving carbon neutrality by identifying four main narratives for society scenarios, and decline French activities for each scenario by 2050. Transportation evolution is detailed through five possible mobility evolutions and each scenario differs greatly on this specific issue. The levers of decarbonation of transportation which allow for mobility evolutions are a moderation of the demand for mobility, a transportation modal shift, a higher occupancy rate of vehicles, an increased energy efficiency of vehicles as well as a decarbonization of the fuels and energies used. This scenario-based report, as well as the main levers it identifies, seems interesting to model several types of

narratives using the tool. It will be seen later that narratives have been developed to expose some results of the urban mobility prototype. However, here again the prism of the transition is notably the one of the carbon constraints, which limits the question of sustainability, and there are no modelling nor material aspects as meant to be used in this report.

On a different note and to move to the modelling side, *En-ROADS Climate Scenario*, (2021) is a policy simulation model that makes it possible to design different scenarios to limit future global warming. Scenario creation is made possible by modifying sliders that allow acceleration, status quo or deceleration of economic and technological development measures to act on global warming. The prism of study is based solely on the energy – economy - GHG emissions nexus with a possibility to change the population, as does the decomposition of the Kaya equation<sup>8</sup>. To make a scenario based on these parameters allows then for an estimation of global warming by 2100. Based on this scenario, the tool offers a multi-indicator panel with notably environmental impacts of scenario-induced warming, such as rising sea levels, ocean acidification or declining agricultural yields. On transport evolutions in particular, two measures can be accentuated or not, namely the electrification of vehicles and the increase of energy efficiency. This tool is therefore quite close to what the project would like to do, allowing fairly simple modification of the study system with sliders and offering a multi-indicator view of the result. However, the study prism is too different as it does not take into account the material issues highlighted in this report, focuses on technological and economic measures only and is ultimately only interested in the issues posed by climate change.

Finally, a last simulation tool based on a model to make simulations for 2050 with a view to decarbonation is the Deep Decarbonation Pathways (DDP) tool, created by “l’Institut du Développement Durable et des Relations Internationales” (IDDRI). This tool allows to create a narrative that describes “the evolution of decarbonisation drivers covering economic, demographic, technical, organisational and behavioural dimensions” (IDDRI, 2021) through sectorial analysis. One of the sectors studied is notably the one of the passenger and freight transport in France. More precisely, storylines on transportation evolution are created through the filling of 8 sections, containing from two to four variables covering the above-mentioned topics. Once the storyline is created, the tool displays different graphs about individual mobility, modal share, budget, time, distance covered, car stock and sales, energy but also emissions for the years 2010 to 2050. This approach is very interesting because it allows the transport system to be modelled using several different types of parameters, and not only technological and economical one, and thus to realise the impact of these same parameters. However, the same critics are made as for the En-ROADS model: the sole prism of climate study cannot take into account the challenges related to the availability and environmental impacts of different materials.

Thus, although it is possible to draw on ideas from existing studies, simulation and modelling tools, the prism of an environmental modelling study of the evolution of material-based transport does not yet seem to have been explored. On the other hand, a study containing

---

<sup>8</sup> The Kaya equation links global emissions (CO<sub>2</sub>) to world population (pop), primary energy consumption (energy) and Gross Domestic Product (GDP) according to the equation:  $CO_2 = pop * \frac{GDP}{pop} * \frac{energy}{GDP} * \frac{CO_2}{energy}$ .

---

scenarios of material requirements for the urban transport sector has been recently carried out (Gassner et al., 2021) and it could serve as a basis for the model.

### **4.3 Methodological approach of Gassner's study on the projection of material uses in the urban transport sector to 2050 and its adaptation to build the prototype**

The study which is referred to is the one carried out by Gassner et al., (2021) which considers the projection of material flows and stocks through a scenario-based analysis of the urban transport sector until 2050 in the city of Vienna. This study is extremely interesting for this project to serve as a base since there is no modelling tool existing, to the author's knowledge, to allow for the designing of alternatives of the urban mobility sector on a material basis. Indeed, since this study establishes the material requirements of urban transport, its methodology could be simplified and adapted to the creation of the desired prototype.

It is worth noting that a scientific paper was written to present how Gassner's paper could be adapted to the construction of this prototype and what results could be obtained (Krieger et al., 2021). Thus, what will be presented thereafter is based in particular on the key points of this article which can be found in Annex 13.

#### **4.3.1 Presentation of the methodology and the results obtained on Vienna's study**

Firstly, to describe the study that could be used as a basis for the prototype, it is to be noted that Gassner et al., (2021) based their model on a bottom-up dynamic stock-flow MFA. This approach is different from the MFAs that were done in part two, as they were based on a top-down approach focused on materials circulating in the French economy as a whole. In this study, the construction of material flows is made such as the mass of each good is multiplied by the number of total goods, hence the name bottom-up. In other words, and with the terms of the article, to calculate Vienna material flows, specific service units (SU) have been considered, such as the number of vehicles of each type, which were then multiplied by specific material intensities (SI), such as a quantity of a given material per vehicle. By deduction, the quantity of materials in stock could be obtained for each year by adding the number of vehicles entering the city and subtracting the number of vehicles being scrapped for the current year.

In regard to specific unitary services, they were classified into two types: those referring to vehicles, and those referring to infrastructures. While the former refers to the different types of vehicles and their number, the latter include infrastructure for new transport, the maintenance of existing infrastructure and the demolition of old transport infrastructures. Concerning vehicles, both freight and passenger vehicles were considered. Finally, with regard to specific material intensities, they were broken down into 13 materials expressed in mass unit, namely: "asphalt & bitumen; aluminium; batteries; brickwork; concrete; copper; glass; gravel & sand; iron & steel; other metals; others (e.g. rubber); plastics; and wood" (Gassner et al., 2020).

Moreover, as their study was placed in a framework of scenario prospective making, four scenarios which began in 2030 and ended in 2050 have been created by calculating different evolutions of service units. These scenarios consist of: the "Business as usual

scenario”, which keeps the current modal and type of propulsion stable, the “Battery electric vehicle fleet scenario”, which notably replaces fossil fuelled cars by non-emitting alternatives, the “Public transport scenario” which accounts for a significant modal shift towards public transport and the “Active mobility scenario” which combine the switch to non-emitting alternatives with a modal shift from car to active mobility.

Regarding the results highlighted by Gassner et al., (2021), two key factors which had a huge impact on material use were “the modal split of transportation and the evolution in the type of vehicles propulsion, which respectively changes considerably future material demand and increases waste generation, notably of batteries” (Krieger et al., 2021). Indeed, scenario which use the most materials are the one that use high private vehicle fleet rates. The “battery electric vehicle fleet scenario” notably presents the highest vehicle material stock of 1.6 Mt whereas the “Public transport scenario” presents the smallest vehicle material stock of 0.76 Mt in 2050. The second scenario therefore achieves a total mass that reduces the stock of materials required by more than half when compared to the first scenario.

Although the second scenario looks more enviable in a sustainability context, it is acknowledged in this article that the material analysis approach also has its blind spots to estimate the sustainability of constructed scenarios. Indeed, “structural, political and social factors [...] that influence modes of transport chosen and affect car ownership decisions were not modelled individually as factors, but are required in order to reach the transformation described in the scenarios” (Gassner et al., 2021).

In fine, the methodology of this article seemed very interesting to be reused to lay the foundations of urban transport material accounting, while continuing to build on it to link these material flows to environmental impacts, and introducing a possibility of alternative designing.

### **4.3.2 Reused methodological bases of Gassner’s article and additions to build the prototype**

In the case of the present report, major changes were made to greatly simplify the methodology used in the previously presented article. Indeed, it turns out to be a little too complete for the objective set here for the prototype.

#### *4.3.2.1 Simplification of the article to lay the foundations for a prototype for modelling the material flows of urban transport*

Based on what was expected for the prototype, four main simplifications have been made. First of all, the logic of representing possible alternatives has changed: it has moved from several scenarios that extend over 20 years, to the representation of an indefinite point in time. Indeed, the logic presented in introduction is to propose alternatives, regardless of the path to reach them, and to quantify their desirability on the basis of environmental indicators. It is therefore to keep with this idea that the scenarios are no longer represented temporally. However, it does not mean that the future they describe are not consistent in the assumptions they make and that they are not linked to a narrative, quite the contrary.

The second main simplification which has been done is in the logic of description of alternatives which changes from a consistent dynamic stock-flow model to a purely annual flow description. This is in fact a direct consequence of the timelessness of the alternatives created making it impossible to make a dynamic model which could determine stocks one year after the other. Thus, only flows can be truly quantifiable with the approach taken in this thesis and therefore only a description of material annual flows will be made.

The third big simplification lies in the details taken on vehicles. Indeed, only one vehicle per type of transport was selected: an active mobility vehicle, an individual motorised vehicle and a public transport vehicle. These vehicles are respectively bicycles, cars and bus whereas in the original study, much greater detail on transport was present, with about ten vehicles taken into account. In addition, vehicle propulsion has been reduced to two types: internal combustion vehicles and battery electric vehicles. For comparison, Gassner et al., (2021) took into account seven different propulsion types.

Finally, the last simplification are the materials which are under study. They were reduced to three, namely steel, aluminium and copper. The sum of these three metals in mass accounts for each 70 and 80% of the mass of each vehicle studied, thus taking into account the majority of their mass in material flows. This was done because the environmental impacts of these particular materials are well known, whereas for materials such as plastics or wood, it depends very much on the process of manufacture.

Regarding the fact that infrastructure materials are not taken into account, it could be argued that it is problematic given their mass which is far more important than that of vehicles. However, without the estimation of stocks, the minimum requirements for infrastructure materials are very hard to assess. In addition, “although the annual material turnover for the vehicles is more than one order of magnitude smaller in comparison to the one for the built infrastructure, the materials used in vehicles are much more valuable and their production or disposal is associated with significantly higher environmental impacts, implying that their reduction is most probably more important for the overall environmental performance of the transport system” (Gassner et al., 2021).

Thus, the alternative created does not have trajectories as it represents a parallel mode of operation, and therefore only quantifies the material flows of vehicles required for annual urban mobility. In addition, simplifications have been made to the vehicles and materials to handle the complexity to a decent level in order to make environmental assessment of the scenarios and to make it possible to design mobility alternatives easily.

#### *4.3.2.2 Environmental assessment of material flows associated with urban mobility in the prototype*

As part of the prototype, annual material flows were coupled with life cycle analyses of the three materials taken into account to estimate their impact.

A first step was to find out which impacts to monitor. Indeed, the number of impacts given should be small enough, so as not to clutter the simulation, but should also allow for the reflection of different environmental issues. The focus was finally put on four impacts. The

first one was greenhouse gas emissions given its widespread use and the fact that it is one of the major environmental problems facing the use of internal combustion engine vehicles. A second one, also well-known, was that of emissions of particulate matter with a diameter of less than 10  $\mu\text{m}$  (PM10), which is a problem for people's health, causing breathing problems, especially for people living in cities. Finally, two indicators of resource use were also displayed, one relating to the water used during the vehicle manufacturing process because available freshwater is a critical resource in the face of climate change, and another simply being the total end mass of vehicles to show the number of materials required to meet the annual needs of mobility of urban people.

With regards to the scope of these impacts, two phases have been taken into account: the phase of vehicle manufacture, as well as vehicle use. Since the focus is on flows of vehicles purchased each year, emissions from direct vehicles, i.e., those emitted over the lifetime of the vehicle, were all accounted for in the year of purchase.

Regarding the sources used for the manufacturing phase, GHG together with PM10 emissions, and water consumption were taken from the estimations of the GREET Model (Argonne, 2021). Indeed, this model notably estimates emissions outputs and water requirements based on LCAs of the materials that constitute them, making it an ideal source for reusing their data. For emissions during the use phase of vehicles, GHG emissions were calculated based on exhaust data displayed in a report from ADEME, (2018), while emissions of fine particulate matter were calculated by taking into account exhaust, brake and tyre emissions using two articles (Charron et al., 2019; Institute for Energy and Transport (Joint Research Centre) et al., 2014).

Finally, to calculate material consumption and gas or particle emissions during the manufacture phase of vehicles, material LCAs were applied to two types of materials: recycled and virgin materials. The rate of each recycled material has been taken according to Sankey diagrams constructed at the national scale. Thus, copper shows a recycling rate of 21.3 % (Bonnin et al., 2013), aluminium a recycling rate of 44.1% (see Annex 8) and steel a recycling rate of 50.1 % (see Annex 7). Recycling percentages taken from the Sankey diagrams are the percentages of recycled material flows going into the manufacture of semi-finished or finished products of the same material, not including material imports. These are therefore national percentages, and it is very likely that the actual percentages for the mobility field are different. However, in view of the simplification approach, no further attempt will be made to estimate more precisely the percentages of recycled material.

After determining which environmental assessments and the scope and calculation used to assess these impacts, it was necessary to allow for the design of urban mobility alternatives in the prototype.

#### *4.3.2.3 Enabling design of urban mobility alternatives*

In order to make it possible to design alternatives, several points had to be considered. Firstly, what kind of parameters is it intended to be changed? Are economic, social, organizational and technological measures being taken into account and more precisely, among

them, which parameters are to be chosen? Secondly, which measures on the producer side, and on the opposite on the consumer side, are taken into account? And last but not least, how the design of alternatives is allowed?

Regarding the answer to the first question, it was clear that economic measures such as taxes on vehicles weight were discarded as a coupling with another model would have been required. However, all other dimensions listed above were among types of parameters envisaged, with a specific highlight on technological parameters, completed by important social and organisational possibilities for change.

For the answer to the second question, both changes on producer and consumer sides should be explored. Levers of action on the production side are usually technological, but may require the changing of different social needs on the consumption side to be accepted, such as a reduction in mass of vehicles through design sobriety. On the opposite, the levers of action on the consumer side are always considered as “social” since they are inscribed in a societal paradigm that encourages certain behaviours, such as the fact to use more bicycles. However, these changes can only be made if the infrastructure is in place to enable this type of behaviour: as an example, a modal shift to the bus involves the creation of bus routes. Thus, the levers of action related to consumers are as much part of social relationships as they are of types of organisations, whether they are infrastructure or institutional organisations.

This said, and more precisely concerning the parameters for designing urban mobility alternatives, they were based in particular on the levers of action highlighted in the various studies in part 4.2. and in part 4.3.1. Thus, with regard to changes in the type of mobility, the possibility of changing the modal share of car and bus was made possible, together with the total mobility demand per inhabitant, as it could be suggested in almost all studies and models created for the urban mobility transition. These parameters are notably based on social and organisational changes, and are oriented towards the consumption of goods.

In addition, it has been made possible to modify the number of individual vehicles owned per inhabitant, as in the DDP tool (IDDRI, 2021). This is a very important parameter from a material and social point of view, as it can reduce drastically the amount of materials required and as no longer owning a personal vehicle implies great changes in the way of living of the majority of people, and therefore on the narrative in which such a lever of action could be envisaged.

Various technological changes in the characteristics of the vehicles have also been made possible, with the lifespan of vehicles which can be improved and the current rate of electrification of cars and buses which can be increased. These changes, and especially electrification, are levers of action that are shown in Gassner’s study as well as in all reports and online models for making simulations. What is new, however, and which cannot be taken into account in the other tools because of their approach, is a lever of action being a change in the mass of cars as a result of two levers of action: intentional sobriety in the manufacture of vehicles, as well as the replacement of steel by aluminium in the structure of the vehicle which could make vehicles lighter according to the prospective work made by a study of the ADEME (Rauzier et al., 2020).

These 11 action levers have thus been implemented in the tool in such a way that they can be modulated by a third-party user. The modification of these parameters was made possible by the use of sliders, as in the case of the *En-ROADS Climate Scenario*, (2021) model. It now remains to be seen what kind of results can be obtained with the modulation of these parameters.

#### 4.4 Three narratives of organisations with very different impacts

Firstly, in order to make alternatives, it was necessary to create a reference scenario. In this sense, it was chosen to use data from a real city: the city of Lyon and its hinterlands. To create this scenario, data from Lyon as well as national data from 2015 were extracted<sup>9</sup> and computed into the model. They were notably vehicle ownership, annual mobility of capita, lifespan of buses and cars, and the number of people living in the city and its surroundings.

This made it possible to model the number of vehicles purchased annually, and to compare the output of the modelling to data provided by the *Insee - Institut National de La Statistique et Des Études Économiques*, (2022). The difference between the model output for the number of vehicles expected to be purchased in 2015 and actual vehicle purchases according to 2015 official statistics is less than 3% for each vehicle type. This shows that the model's computational structure (see Annex 13 for further details of the calculation methodology), allows to reiterate an existing situation, and subsequently assess its impacts.

Once this baseline scenario was created and its consistency verified, several other narratives were created to serve as socio-technical alternatives of urban mobility. As one of the major concerns displayed by most of the current actors is to reduce GHG emissions, it was decided to create three narratives seeking to reduce greenhouse gas emissions by at least 50%, while playing on different parameters. The narratives had to be quite simple in order to understand the impacts of a change in parameters. Thus, only one or two parameters were changed in each scenario compared to the baseline scenario.

The main parameters on which it was decided to build narratives were: electrification, modal shift and car ownership. Electrification was chosen because it is presently the most highlighted lever for decarbonising mobility. It is also mentioned as a lever of action in all the studies mentioned above, which makes it an essential parameter for the creation of a narrative. Concerning the modal shift towards active modes of transport as well as towards public transport, this is also a measure widely encouraged in studies such as those of The Shift Project, those of ADEME and it is a modelling possibility given by the DDP model which has been reiterated here. Finally, with regard to reducing the number of cars owned by residents, this is a measure to reduce GHG emissions which has rarely been mentioned for reasons of possibility with current infrastructures but also for reason of perception facing the dominant paradigm. Thus, it has not been implemented much in reports or models, because agencies generally prefer to talk about sobriety of travel (ADEME, 2021), which refers both to the idea of owning

---

<sup>9</sup> The city of Lyon had notably been chosen as a case study because it had easily accessible data for this type of exercise (Agence d'urbanisme aire métropolitaine Lyonnaise, 2018).



less, but also of travelling less. However, it is to be noted that the DDP model for transportation gives the possibility to change the vehicle ownership rate to design scenarios of decarbonation, which reinforced the idea that this parameter could be interesting.

Based on these 3 parameters, three alternative organisations of urban mobility have been created. A first alternative (S1 – BEV) looks at the impact of an all-electric switch from 0.91 to 100%, while maintaining the current modal split and vehicle characteristics. A second alternative (S2 – PT) accounts for a large modal shift from individual motorised mobility to public transport as well as to active transport, while keeping the electrification as in the baseline scenario. In this alternative, the modal share of the car is halved and the modal shares of bus and bicycle are both multiplied by a factor of 5, resulting in a mobility of about 47% by bus, 45% by car and 8% by bicycle. One final alternative (S3 – PT-CAR) was carried out, using the assumptions of the second scenario, but adding a decrease in vehicle ownership proportional to the modal shift. Thus, vehicle ownership has been divided per a factor two, values being thus lowered from 0.485 to about 0.240 vehicles per capita.

In fact, these three alternatives could very well be fit into society narratives that could be similar to the four scenarios made by the ADEME, (2021). While the full switch to electric vehicles would be embedded in a “green technologies” narrative which focuses on addressing environmental challenges through technological solutions, the second alternative could probably be close to the “territorial cooperations” narrative which sees society changing to adopt pragmatic territorial cooperation. Finally, the last alternative could be included in the “frugal generation” scenario, which considers important changes, especially in the ways of transportation, with an exacerbated frugality and sobriety. Of course, in reality, it will probably be a mix of these measures that will be applied, and one of these alternatives will not be "chosen". However, some measures will be promoted more than others depending on the dominant paradigm.

Based on these scenarios, values of environmental impacts have been returned by the prototype, as it can be seen in Annex 14. Some of the results have been put on Figure 12 to compare these different impacts relatively to the baseline scenario. It is notably shown that while S1 – BEV and S2 – PT increase resource uses and decrease emissions, S3 – PT-CAR allows to decrease both resource use and total emissions. The scenario that best achieves to lower GHG emissions by dividing them per a factor 10 compared to the baseline scenario is S1-BEV, which switches all thermal vehicles to electric. This is achieved in part thanks to a French electricity mix with very little carbon content, and a major productive breakthrough in the manufacturing pace of electric vehicles. However, it is to be noted that alternative S3 – PT-CAR is the best in terms of overall environmental impact reduction. It is also the only one that reduces the resources extracted compared to the reference scenario, but it is acknowledge here that this alternative also involves major social changes.

What is also interesting to see is that modal transport alone cannot reduce resource use, it must be accompanied by a reduction in vehicle ownership as the scenario S2 – PT uses more resources than the baseline scenario, while reducing GHG and PM10 emissions by about 50%. This is something that can be expected as a result given that modal shift and car ownership

were two variables considered as independent in the modelling, although they probably would not be in reality.

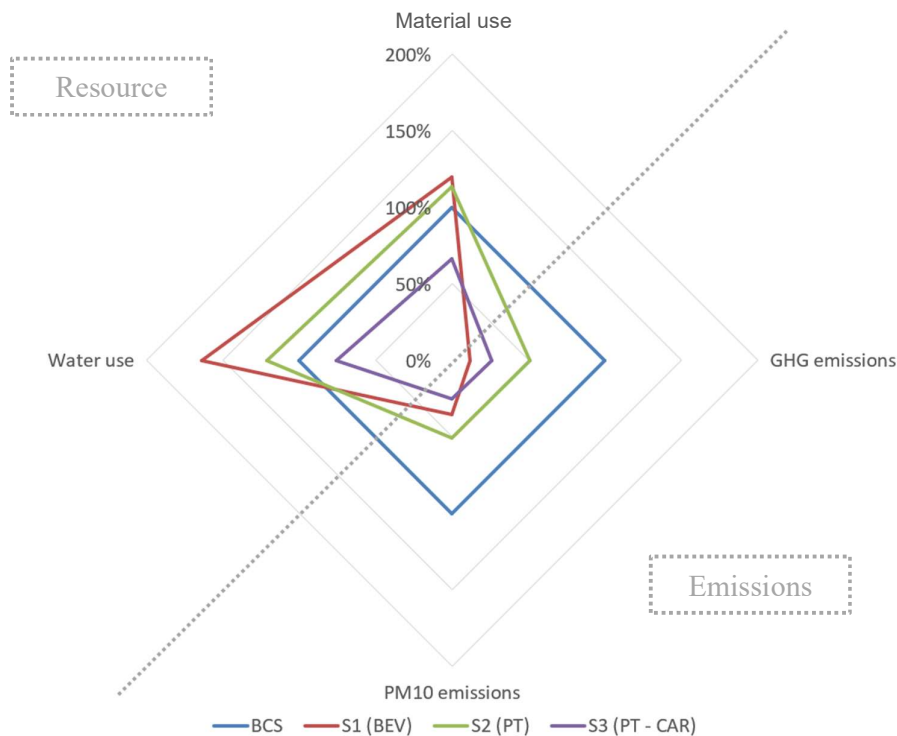

*Figure 12 - Direct and indirect impacts based on 4 environmental criteria of three urban mobility alternatives for the city of Lyon.*

Thus, the prototype made it possible to draw up operating alternatives based on a fairly simple change of parameters. These alternatives have been shown to have different environmental impacts, with strong resource impacts when purely technological measures were involved. This prototype was also used to test ways of varying parameters, as well as to see if environmental trade-offs could be highlighted quite simply. This prototype has finally given a glimpse of what the creation of a model would look like, while showing the complexity of building it.

## 4.5 Perspectives and limitations

Although the prototype is interesting, there are still many areas for improvement. Indeed, more than technical improvements and consolidations of computational and scope assumptions for materials and vehicles to make the prototype more complete, many more implementations would be needed to match what is ultimately expected to be built as a systemic model.

### 4.5.1 Perspectives for the prototype

The first major transformation that would be necessary would be to start from a different biophysical description than the one used here. Indeed, it would be necessary to start, not from a bottom-up MFA built based on data of a territory, but rather from a SC-MFA. However, we have seen with the SC-MFAs constructed in part II that the degree of granularity

reached was very far from the one used for the decomposition made by Gassner et al., (2021). Thus, a kind of convergence of the two methods should be operated, to make national data proxies based on the material data used for the bottom-up MFA, in order to build these supply-chains at the scale of a given territory. However, the convergence of these two methods relies on the use of data that may not yet exist. An important task would therefore be to examine which links would be feasible based on existing available data, and which would require further study.

In addition, the prototype has been constructed on the urban mobility sector completely independently of all other consumption and production sectors. This is in total opposition to the systemic aspect, and in particular to the notions of interdependencies that should in fine be highlighted with such a model. Thus, other sectors necessary for the organisation of our society should be implemented and linked to the supply chains involved in mobility to emphasise the different material and territorial interdependencies.

The evaluations should also be explored in more detail. With the prototype on urban mobility, it has been seen that there could be alternatives that favour resource consumption while reducing emissions, or alternatives that allow all environmental indicators to be lowered, but no social or vulnerability evaluation were conducted in parallel, thus limiting the discussion on the desirability of the scenarios. Indeed, with the alternative S3 – PT-CAR, all impacts were reduced, but it is unknown what this would mean in terms of mobility possibilities, of living environment or of societal assumptions for the scenario to happen? In fact, it was not possible to answer these questions and therefore, a multi-criteria analysis should be carried out, together with the coupling to other types of tools, to ensure the systemic nature of the model, and to provide elements of answer to such questions.

More than perfecting this prototype, it is also important to keep in mind the unintended side-effects of this type of modelling and the limits to its application.

#### **4.5.2 Limitations of the approach taken**

A main limitation is the fact that the approach rests on a model. Thus, it is necessary to insist on the fact that modelling is necessarily a simplification of reality which highlights certain characteristics of the system, but which cannot represent it in its entirety. Thus, one must not expect to have more answers when looking at the outputs of the model than the modelling can provide. In particular, it must be prevented above all to draw conclusions from what is not intended to be represented.

Here in particular, care must be taken not to believe that the modelled alternative is a necessarily attainable point, as the range of action levers might be quite unachievable, materially, as well as societally. Indeed, the way of modelling is to show the trends of change according to the levers of action used, and thus to see which levers have the most impact and which impacts, not to provide a space of possibilities for alternatives.

Moreover, although the approach is intended to be fairly accurate, the quantification imposed by the modelling still has a margin of uncertainty. Particularly in supply chains, the quality of the data is not necessarily proven on all stages, with differences that can be

significant, or data that is missing. Thus, one should always look at the relevance of the results and not take them as an absolute certainty.

Finally, care must be taken not to jump to conclusions based on impacts quantified by alternatives to establish their overall desirability. Indeed, it is necessary to couple the quantified descriptions with more qualitative descriptions to get an overview of what such an alternative could have as repercussions on daily life. And even with coupling with other tools, many aspects cannot even be modelled and will basically be blind spots in the study, such as political, cultural or religious issues, the model being only based on material relations.

---

## Conclusion

On the grounds of the observation that a change is needed in production and consumption patterns, the construction of a model for the design of socio-technical alternatives based on the description of multi-supply chains and multi-scale biophysical economy has been started. However, as this project was, and still is, ongoing, further work was needed particularly on the description of the economy.

Thus, a first work was carried out on the theoretical framework allowing a biophysical description of the French economy. It was shown that the monetary description did not seem sufficient to address environmental issues whereas the biophysical description proved to be much more appropriate. Then, methodologies to describe biophysically economy have been explored. It has been found that studies of interest were called Material Flow Analysis and that they were based on the principle of mass conservation. Based on their specificities, it was decided to use Supply Chain – Material Flow Analysis which trace the associated flow of the derived products of a given resource. SC-MFA notably allows for coupling with other analyses rather simply, giving the modelling tool a possibility of multi-dimensional evaluation of biophysical descriptions.

A second task, which was to establish material flow analyses of certain supply-chains of the French economy, was then completed. To do so, it was necessary to describe the methodology used to construct the material flow analyses of supply chains. Overall, this methodology was carried out in four steps which was to structure the supply chain with SUTs, to reconcile data collected to construct SC-MFAs based on the principle of mass conservation, before representing and analysing results in the form of Sankey diagram. This methodology was then applied to several types of materials, being non-metallic ores, fossil fuels, metals and wastes. Additional work was carried out on two other resources: water and energy. The structuring of these material supply chains has made it possible to give a first draft of description of the French biophysical economy which can serve, with a further work on their granularity, as a basis for the model intended to be built here.

Finally, a third work was carried out, namely the construction of an initial model prototype which goal was to understand the issues of modelling, as well as to look at the feasibility of evaluating and designing alternatives with a biophysical foundation. Due to sustainability issues of the urban mobility, it was chosen to work on this case study by modelling and enabling the design of socio-technical alternatives, as well as including their environmental assessment. To do so, studies and tools providing policy levers or design options for the transition of the transport sector were first reviewed.

Secondly, after finding that no alternative designing tool for urban transport funded on a material basis existed, a paper highlighting scenario on transport material flows and stocks in the city of Vienna up to 2050 was analysed. This paper was then taken as a basis for the material analysis of this sector with some modifications. They included: simplifying the methodology and the scope of vehicles and materials considered, linking materials to their life cycle analysis and including the design of alternatives to the baseline scenario. The baseline scenario was built using data from the city of Lyon as a case study, and the methodology and the result of

the construction of this prototype led to the writing of an article. The prototype thus built has shown being able to model quite accurately the situation of Lyon and could produce environmental assessments of urban mobility alternatives. Hence, even with few parameters and environmental evaluation, this prototype was able to show some interesting results highlighting that the modelling through biophysical flows should be further explored.

Thus, this work has shown interesting perspectives for continuing to build the multi-supply chain and multi-scale systemic biophysical model. Firstly, the supply chains explored could be used in the multi-supply chain model, with further work on granularity, on territorialization and on the sectors concerned. Secondly, the prototype could further integrate supply-chains and insert material interconnexions with other sectors. And finally, the prototype could be developed further to include other evaluation rather than just environmental ones, before possibly being inserted into a participatory process which also needs to be further explored.

## Annexes

### Annex 1 - Example of an SFA at the European Scale

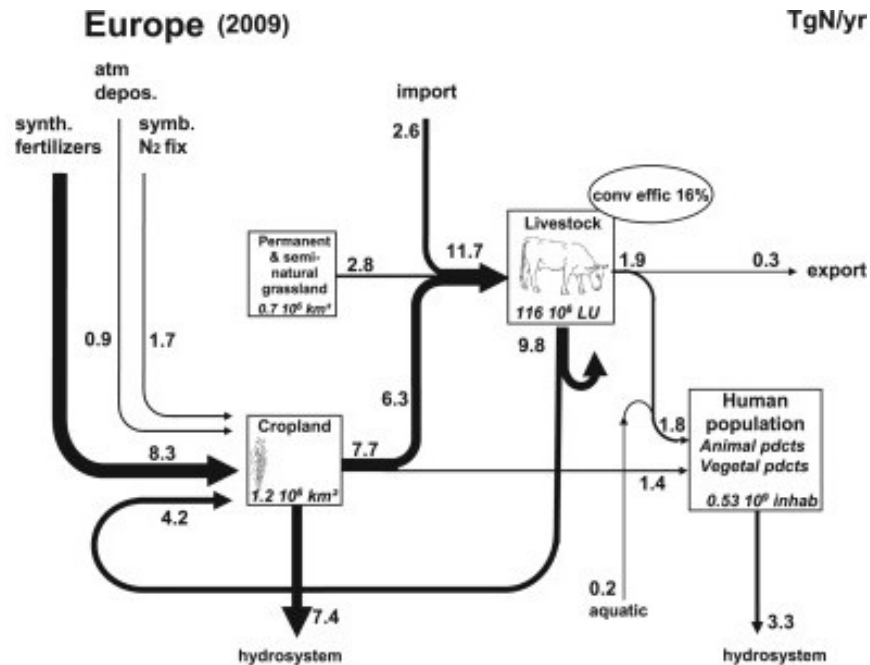

Fluxes of protein-N within Europe in 2009, in TgN/yr, according to the Generic Representation of Agro-Food Systems scheme. (Billen et al., 2014)

### Annex 2 - Scope of economy-wide material flow accounts

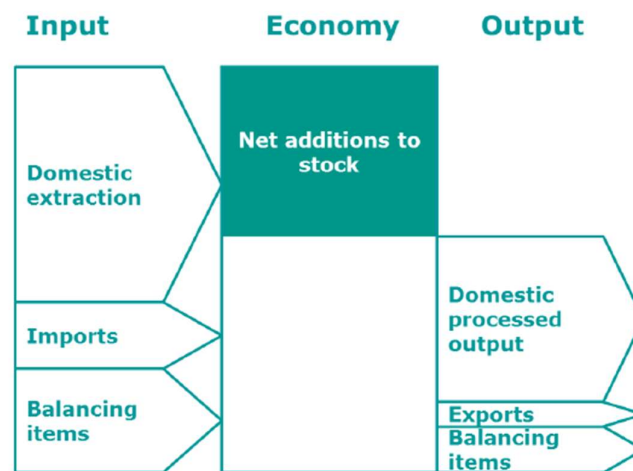

Simplified scope of economy-wide material flow accounts (European Commission, 2018)

### Annex 3 - Tracing the flows linked to bread consumed in region Provence-Alpes-Côte-d'Azur thanks to a coupling AMC / SC-MFA

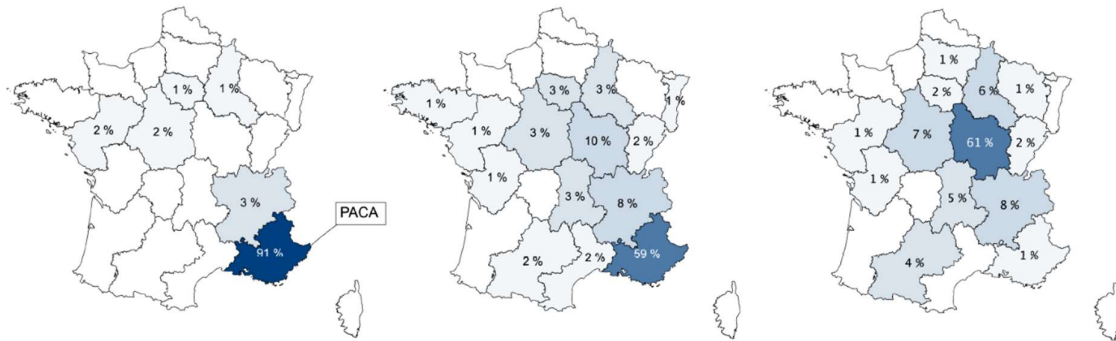

The supply chain of bread consumed in Provence-Alpes-Côte-d'Azur region. From left to right: supply areas for bread, flour used for bread and wheat used for bread. A darker colour indicates a greater contribution. (Courtonne et al., 2016)

### Annex 4 - Grid of analysis for studying local supply chains

Actor	Type	Producer, transformer, distributor, consumer, supporting activity
	Role	Initiator, coordinator, participant, funder
Collective action	Interaction mode	Interaction, coordination, coopeation
	Membership	Market, redistributive (public), reciprocity spheres
	Size	Number of people or entities, scope of action or of influence
	Proximity	Geographical, organizational, institutional proximities
Environment	Policy and governance	Stakes and objectives of policies
	Social context	Well-being stakes
	Natural context	Ecological stakes

Grid of analysis for studying local supply chains and their relationship to sustainability dynamics. (Courtonne, 2016; Debuissou, 2014)

### Annex 5 – Types of variables

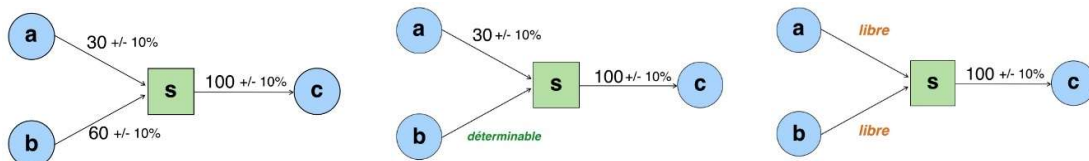

On the left, all variables are redundant. In the middle, the flow b to S will be a determined variable, and finally on the right, both the flow a and b are free variables since there are not constrained.



## Annex 6 - Sankey diagram of fossil fuels

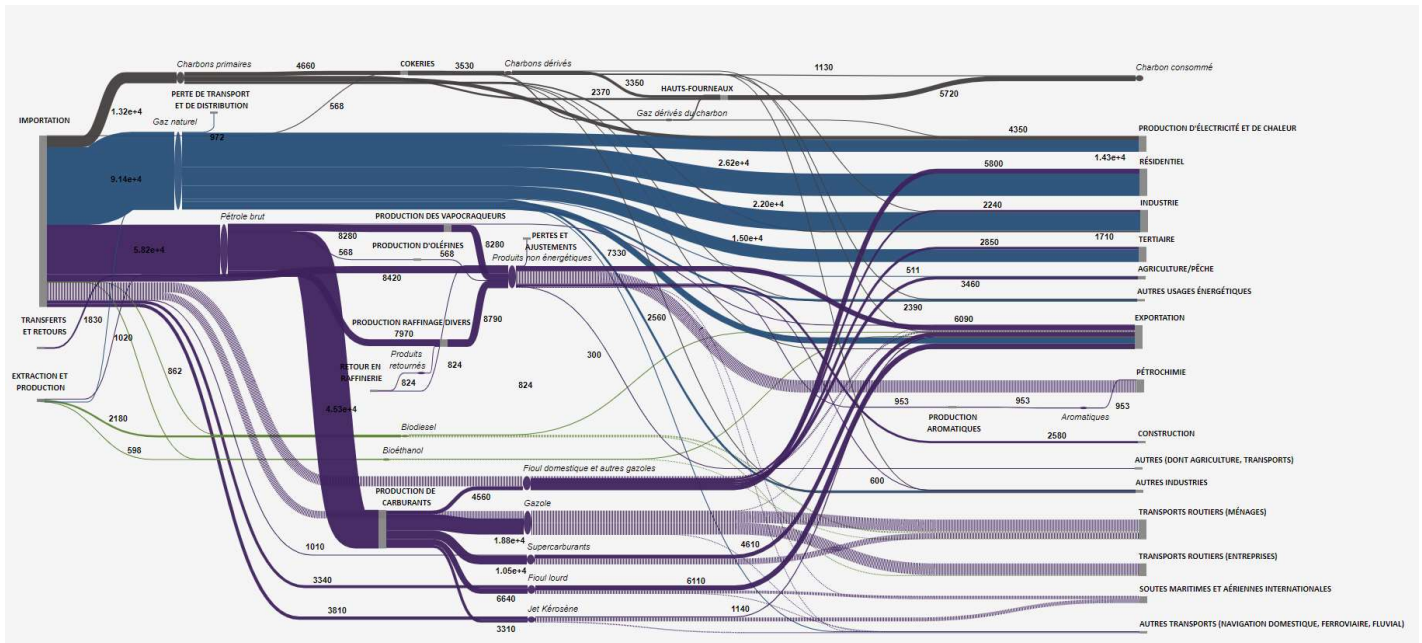

Sankey diagram of fossil fuels for France in 2015-2016 (in kt)

## Annex 7 - Sankey diagram of steel

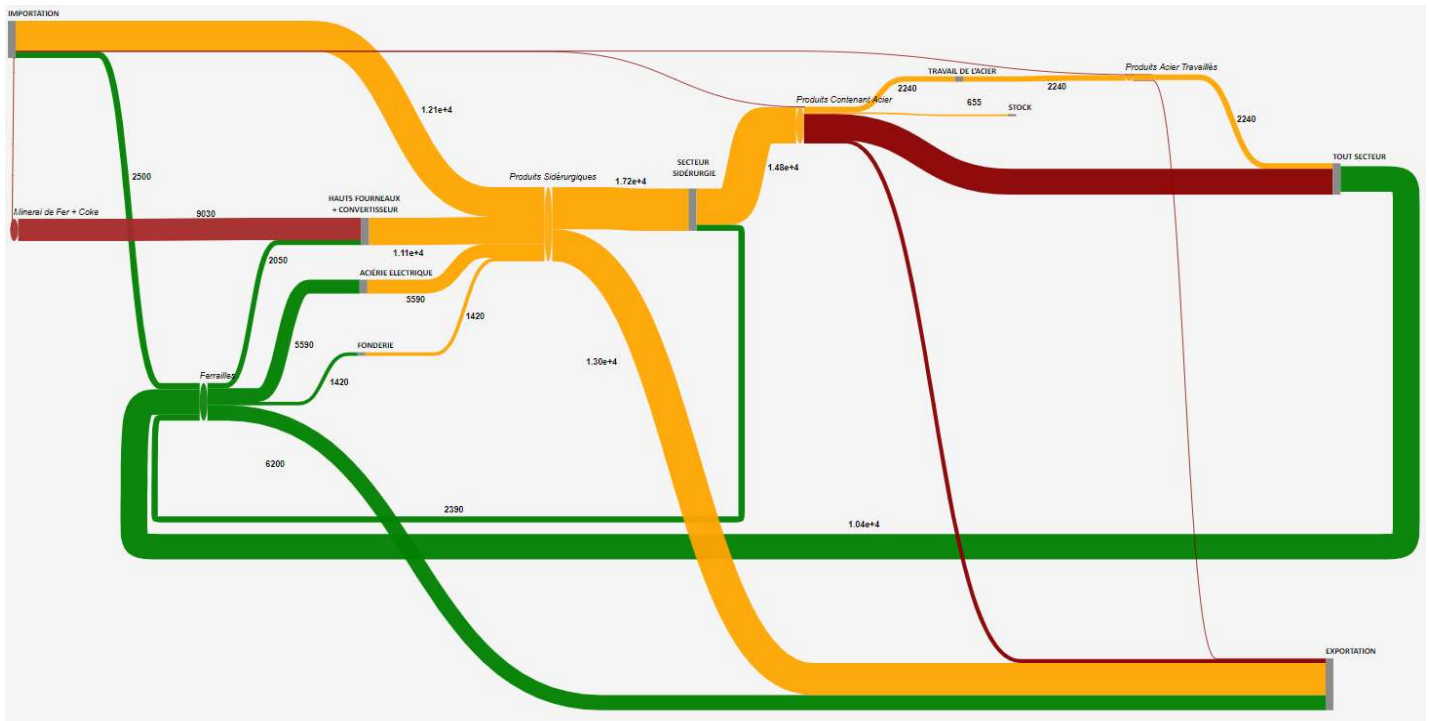

Sankey diagram of steel for France in 2014 (in kt)

### Annex 8 - Sankey diagram of aluminium

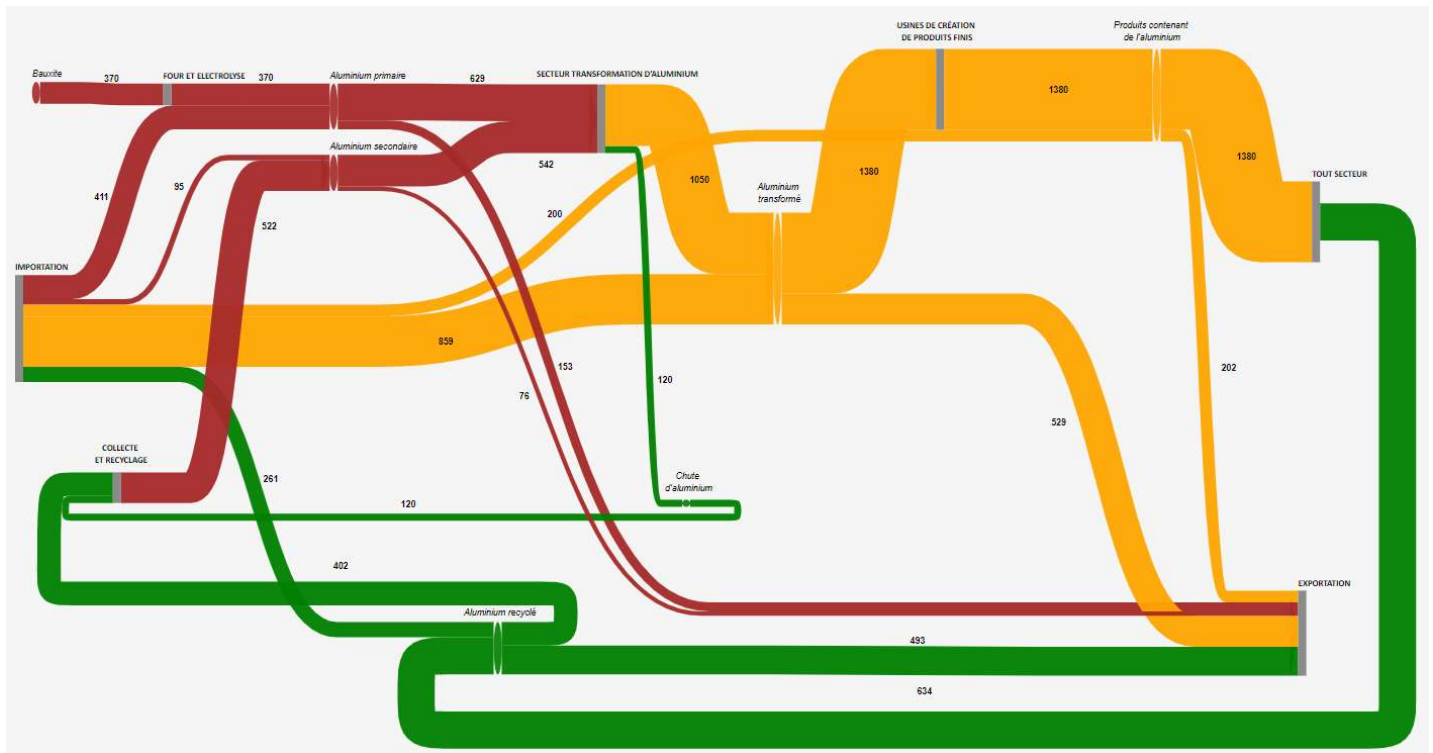

Sankey diagram of aluminium for France in 2014 (in kt)

### Annex 9 - Sankey diagram of lead

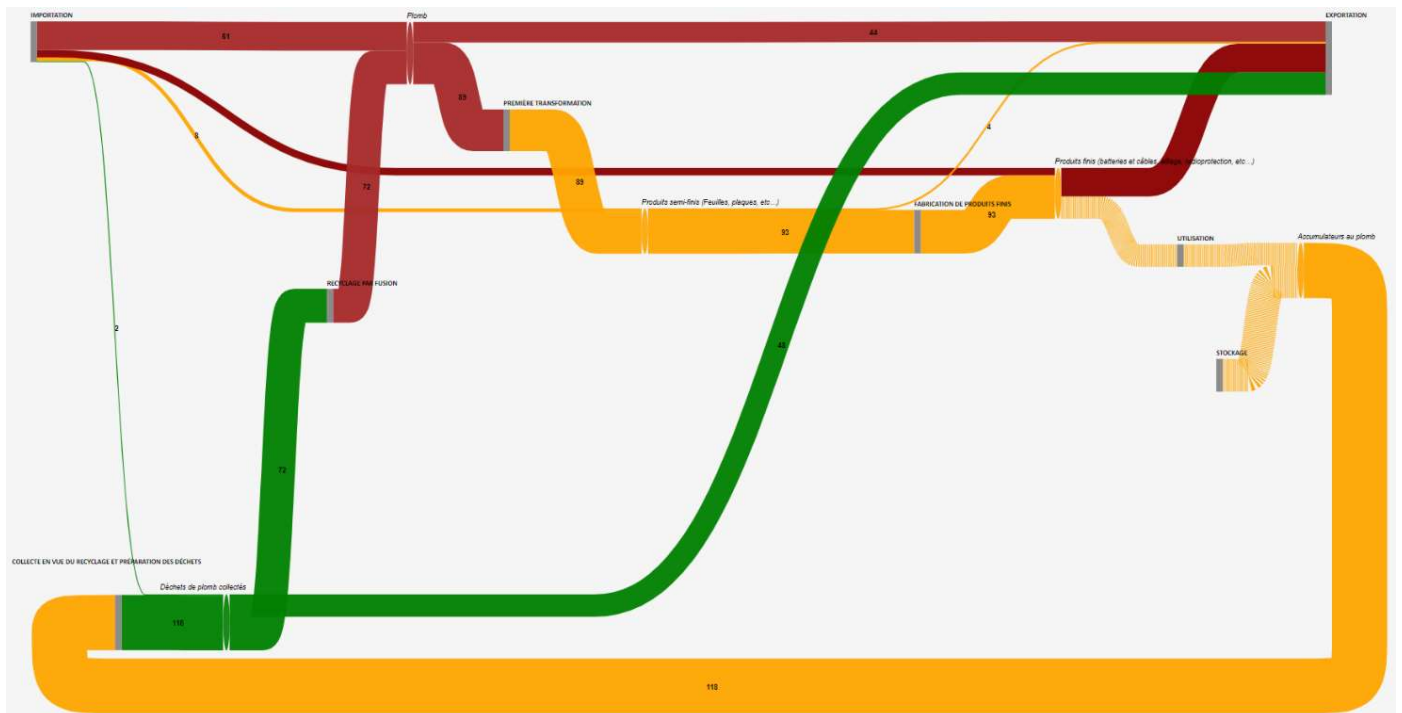

Sankey diagram of lead for France in 2017 (in kt)

## Annex 10 - Sankey diagram of wastes

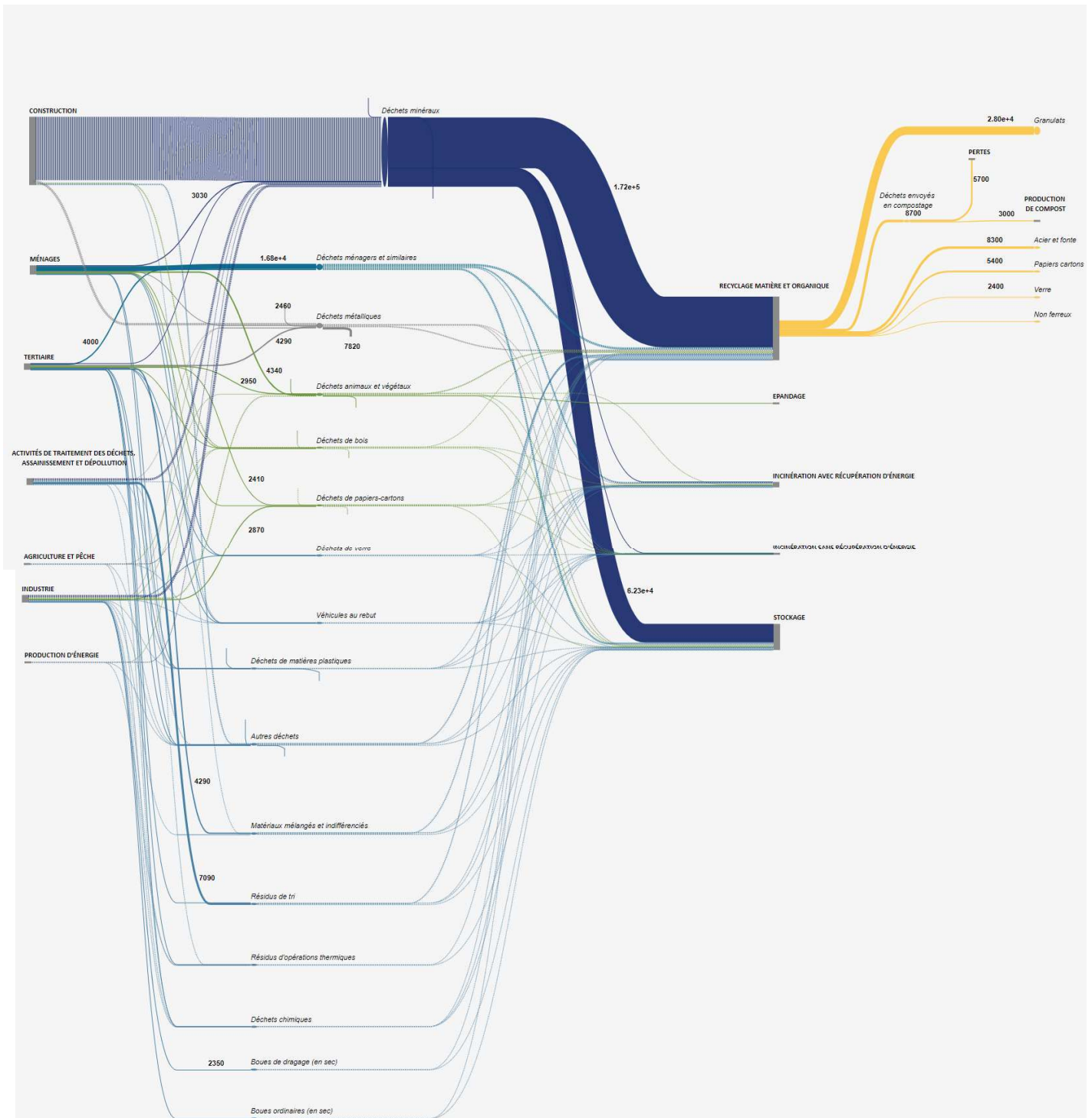

Sankey diagram of wastes for France in 2016-2018 (in kt)

## Annex 11 - Sankey diagram of energy

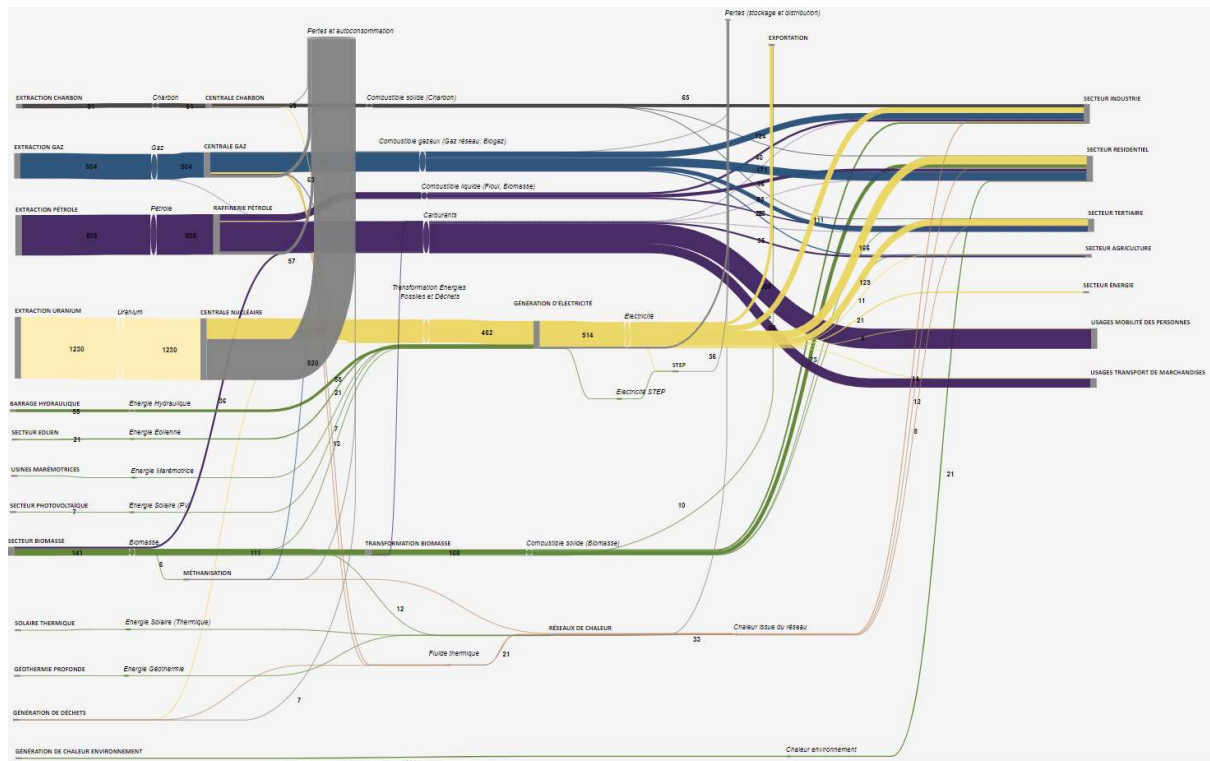

Sankey diagram of energy for France in 2015 (TWh)

## Annex 12 - Sankey diagram of water

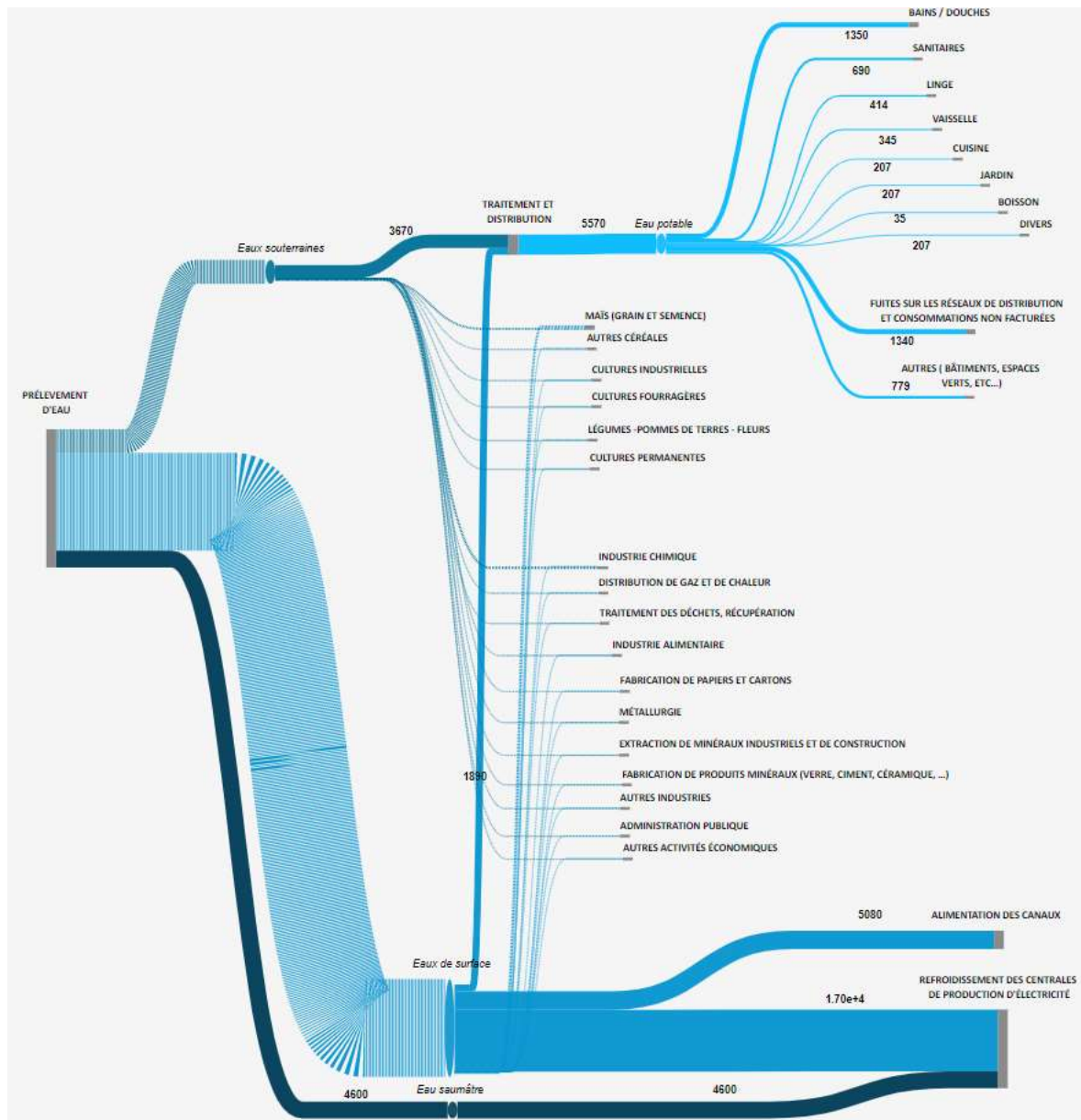

Sankey diagram of water for France in 2013 (in Mm<sup>3</sup>)

*Annex 13 - Article written to present the prototype*

**A modelling tool for designing urban mobility alternatives and evaluating their direct and indirect environmental impacts**

Krieger Emmanuël<sup>1</sup>, Mangeot Mathieu<sup>2</sup>, Courtonne Jean-Yves<sup>1</sup>, Mandil Guillaume<sup>1</sup>, Sturm Peter<sup>1</sup>

emmanuel.krieger@inria.fr ; mathieu.mangeot@inria.fr ; jean-yves.courtonne@inria.fr ;  
guillaume.mandil@inria.fr ; peter.sturm@inria.fr

<sup>1</sup>Univ. Grenoble Alpes, CNRS, Inria, LJK , STEEP, 38000 Grenoble, France

<sup>2</sup>Univ. Savoie Mont Blanc, CNRS, Inria, LJK, STEEP, 38000 Grenoble, France

Currently, most cities' technical and administrative services are organized in silos, thus hindering any holistic approach to urban planning. In the case of urban mobility, they tend to focus only on direct emissions of greenhouse gases and particles harmful to health, but indirect impacts such as material requirement and associated environmental pressures are usually overlooked. This is problematic in a systemic perspective as ecological transitions policies (e.g. development of renewables energies) typically rely on larger metal consumption and imply additional resource constraints. One should therefore check that suggested mobility policies are feasible from a resource point of view. In this context, a prototype tool based on a bottom-up analysis for the city of Lyon was created. The preliminary results show that a main parameter for reducing the impact of urban mobility is the rate of motorized personal vehicle ownership, and that changing the modal share is not enough to have a beneficial effect on all indirect impacts. Another result is that a reduction in vehicle mass through the substitution of steel by aluminium is more environmentally impactful in terms of indirect manufacturing indicators. In the end, the aim of this tool is to be used as a pedagogical model to engage a dialogue with the stakeholders of the territory considered by informing the debate on possible socio-technical alternatives for city/territorial planning.

Keywords — urban mobility, modelling tool, scenario creation, stakeholder participation

## I. INTRODUCTION

Transportation plays a particular role in urban planning since general human activity depends directly on the possibility of human to move through the town and its surroundings.(Grosclaude, Rajendra, and Tubiana 2014) Transports are a source of many questionings on their sustainability, including health issues caused by direct air pollution,(Lamsal et al. 2013) contribution to climate change(Fragkias et al. 2013) among many other issues.(Nieuwenhuijsen 2020) The reduction of air pollution together with the elimination of CO<sub>2</sub> emissions to invent the post-carbon city has been lately a major subject of literature.(Intergovernmental Panel on Climate Change 2007; Zawieska and Pieriegud 2018)

The main approach to tackle the issue of sustainable mobility has been to promote the technological evolution of the transport fleet, notably through electric vehicles, (Emberger 2017) and “the strategy seems to be to replicate the existing car in terms of functionality, size

and vehicle autonomy” (Grosclaude, Rajendra, and Tubiana 2014). However, this approach misses the point when it comes to consider this issue under a systemic point of view. Indeed, this prism of study is too restrictive to capture the situation holistically and while this solution effectively decreases the air pollution in cities, it doesn’t address several problems such as the requirements for resources to build vehicles or the impacts of their manufacture. Yet, such considerations are of primary importance. Indeed, purely technological changes towards low-carbon emission technologies are resource-intensive and reports on critical raw material for emerging technologies “reveal a consensus on potentially limiting resources for the electrified vehicle industry” (Directorate-General for Internal Market et al. 2018; Hernandez et al. 2017; Jin, Kim, and Guillaume 2016). In this regard, maintaining the current modal split of transportation in cities while adopting low-emission propulsion technologies has shown to increase resource consumption and waste generated by cities (Gassner et al. 2021). It is therefore important to take into account not only technological developments, but also other variables, such as the modal split, when seeking a more sustainable city in terms of emissions and rationalization of resource use.

In this context, it is necessary to provide a possibility for local actors, whether they are decision makers or citizens, to compare the different possibilities for mobility development of their city. Indeed, Banister, (2008) has highlighted that among seven elements which are necessary to promote sustainable mobility, two key elements were the information provided and the involvement of the actors. In this sense, Hickman & Banister, (2015) have identified that scenario building offers a viable solution to explicitly include sustainable mobility in city development. One example of application is the four scenarios constructed for the urban transport of the city of Vienna until 2050 by Gassner et al., (2021). They shed lights on possible future material turnovers thanks to a bottom-up Material Flow Analysis (MFA) approach. Notably, their study estimates the future stocks and flows of material in the city of Vienna for all types of transport and for their required infrastructures. However, because this study is highly detailed, it is complicated to replicate their methodology to other cities in a short period of time since the need of local data is too important. In addition, their scenario tool was not designed to be easily used to create other sets of scenarios.

This being said and more generally, our article is embedded in a wider project that aims to provide information and raise awareness about systemic issues of stakeholders of a territory, whether a city or a wider region. To achieve this goal, we believe that it is interesting to highlight different strategies for structuring human activity through the co-construction of scenarios which present different impacts on the socio-technical organisation of society and on our environment. Achieving sustainable urban mobility is an interesting case study because it includes many possible choices of development. For sustainable mobility, an aspect of the transition which is too often neglected for decision making seems to be the materials required for the scenarios. This can be detrimental in the future as the ecological transition from a system dependent on fossil fuels to one dependent on metallic resources invariably raises questions about the vulnerability and the impacts of such an evolution. Thus, the present article aims at investigating the creation of a simple prototype tool exploring futures for urban mobility. It could be manipulated by stakeholders with a systemic perspective. In order to achieve this goal, the tool should notably take into account resources use, based on the work that has been

---

achieved by Gassner et al., (2021), which is, to our knowledge, the most in-depth article on this issue.

This article will therefore first present the methodology of Gassner et al., (2021) to model the projection of material stocks and flows in Vienna through scenarios. In the next section, the authors' position will be described with respect to the previously presented article, together with the main hypothesis for the prototype's scope. The final section will describe the construction of an initial prototype of a participatory decision support tool for the French city of Lyon, according to what has been stated in the previous sections.

## II. METHODOLOGICAL APPROACH OF GASSNER ET AL. (2021)

### A. Description of the functioning of the model

Gassner et al. (2021) based their model on a bottom-up dynamic stock-flow MFA to determine the future material flows and stocks of the city of Vienna until 2050. They considered specific service units (SU), such as the number of vehicles or the length of metro networks, combined with specific material intensities to calculate flows of material for each year and by deduction, the addition and subtraction to the stock each year. Different scenarios have been created by calculating possible development of the SUs in order to model several possible futures. The time window analysed begins in 2016 and ends in 2050. Two specific phases can be differentiated: the first one from 2016 to 2030 gives an evolution of SUs based on current projects of network extension and is common to all scenarios, while the period from 2030 to 2050 is different for each scenario depending on the policies assumed.

The scope of the transport system analysed is the one comprised within the administrative border of Vienna. With regard to the transport system itself, the objects of study are the materials used for new transport infrastructure, maintenance of existing infrastructure and demolition of old transport infrastructure, as well as the materials used solely for the manufacture of vehicles. Concerning vehicles, both freight and passenger vehicles are considered. Finally, with regard to materials, 13 materials expressed in mass units are taken into account: “asphalt & bitumen; aluminium; batteries; brickwork; concrete; copper; glass; gravel & sand; iron & steel; other metals; others (e.g. rubber); plastics; and wood” (Gassner, Lederer, and Fellner 2020).

### B. Scenarios and results of their model

The four different scenarios devised all start in year 2030 and each represents a possible future pathway, namely:

- the “Business as usual scenario” which extrapolates the current state, e.g., keeps the current modal and type of propulsion steady;
- the “Battery electric vehicle fleet scenario” which mainly replaces fossil fuelled cars by non-emitting alternatives;
- the “Public transport scenario” which reflects a significant modal shift from car to public transport together with a switch to non-emitting alternatives;



- the “Active mobility scenario” which reflects a significant modal shift from car to active mobility, e.g., walking and cycling, together with a switch to non-emitting alternatives.

For all their scenarios, Gassner et al. considered that the population development of Vienna would lead to a more than 10% increase in population in 2050, and the demand of passenger travel would remain stable as well as the material intensity per SU.

Regarding the results, their model has shown that, even though infrastructures have a long lifespan, the material stock evolution from 2030 to 2050 directly depends on the scenario. Indeed, a high modal share of motorized individual transport keeps the material stock constant to around 54 t/capita, while a significant shift in the modal split could reduce the material stock per capita of the infrastructure system up to 46 t/capita, and this, taking into account the expected population increase by 2050. The scenario with higher resource intensity is the one that use high private vehicle fleet rates. In this sense, the “battery electric vehicle fleet scenario” presents the highest vehicle material stock of 1.6 Mt whereas the “Public transport scenario” presents the smallest vehicle material stock of 0.76 Mt in 2050, thus showing the impact of a different choice of development of the modal split for the future.

In the case of the present article, major changes are made to greatly simplify this model and certain aspects are added to give greater variability to the scenarios.

### III. PURPOSE AND ASSUMPTIONS FOR BUILDING A PROTOTYPE AIMING AT RAISING AWARENESS ON SYSTEMIC ISSUES

#### A. Awareness raising on systemic issues through the use of a modelling tool

As it has been said in introduction, the aim of the modelling tool is to sensitise the different actors of the city to a systemic approach, particularly with regards to materials issues which are not well known. Our approach is intended to be collaborative, based on a participatory research framework, giving stakeholders the opportunity to illustrate a possible future based on the set of parameters they want to explore. Thus, the tool provided must be simple enough to be accessible to all and integrate a diversity of key variable parameters which must be determined.

The two key parameters identified by Gassner et al., (2021) concerning the variation of materials were the modal split of transportation and the evolution in the type of vehicles propulsion, which respectively changes considerably future material demand and increases waste generation, notably of batteries. Therefore, we want to reiterate the possibility to choose between these two parameters in the prototype. However, we also want to add other parameters that can structure the material demand as well as indicators that must provide the user information to evaluate the scenario.

Such a goal therefore implies major changes in the scope of Gassner et al.’s study as well as on the calculation methodology to be applicable in our case.

#### B. Simplifications of the model

Many simplifications have been made, both in the quantity of data and in the functioning of the model to allow the variation of key parameters. The four most important changes are:

- a "timeless" scenario logic, i.e., the description of a point of arrival in the future without depicting the path to get to that point,
- the shift to a purely annual flow logic,
- the limitation to the transportation of passenger through 3 vehicles and finally,
- the change in the material scope to only a limited number of metals used in vehicles.

The first change is focused in the very logic of scenario representation. While Gassner et al., (2021) have tackled the issue of describing possible future developments for the city of Vienna transport system until 2050, the prototype we carry out describes alternatives without a time logic. These alternatives can be conceived as “possible arrival points”. In practice, the scenarios are made by allowing the user to vary the base parameter set, such as the modal split, the rate of occupancy of vehicles, the weight of vehicles, etc..., and by giving user feedback on the impact of the arrival state using several indicators, which can be for instance greenhouse gas (GHG) emissions or a quantity of material. As said before, the logic is thus to put forward alternatives of operation and to quantify their desirability based on indicators, rather than creating scenarios based on parameters which vary through annual change until 2050. To obtain this, the arrival state is therefore perceived as a stationary state in which the variations in the stock, being the flows, are constant.

Regarding the shift from a stock and flow accounting model to a purely flow model, this simplification arises from the fact that one wants to place oneself timelessly in an alternative which makes it difficult to describe the state of stocks since they are directly linked to the evolution of flows through time.

Concerning vehicles, only cars, bus and bicycles were considered as they each represent a type of transport, e.g., motorized private transport, public transport and active transport (see TABLE II. ). It allows the user to understand orders of magnitude for the category of transport studied. Moreover, two types of propulsion for motorized vehicles have been taken into account: Internal Combustion Engines (ICE) vehicles and electric vehicles.

Table 1 - Vehicles included in the study

	Type of vehicles				
	<i>Public transport vehicles</i>		<i>Personal motorized vehicles</i>		<i>Active mobility vehicles</i>
Vehicles	ICE bus	Electric bus	ICE car	Electric car	Bicycle

Finally, only the materials used to build the vehicles are used, and among them, only details about three metals: aluminium, copper and steel. The choice not to take into account infrastructures is made because the global material stock is not modelled making it complicated

to estimate the requirements of infrastructures flows based on vehicle flows since many infrastructures are already existing in the city. Moreover, it is to be noted that “although the annual material turnover for the vehicles is more than one order of magnitude smaller in comparison to the one for the built infrastructure, the materials used in vehicles are much more valuable and their production or disposal is associated with significantly higher environmental impacts, implying that their reduction is most probably more important for the overall environmental performance of the transport system.” (Gassner et al. 2021) Concerning the choice to take into account only three metals for the description of vehicles, it is because their summed weight represent more than 70% of the weight for each considered vehicle when data provided by Gassner et al., (2021) are used. Furthermore, the respective masses of each metal in the batteries for electric vehicles have been taken into account and added to their respective material category, so that batteries are no longer a material in itself. This differs from the study by Gassner et al. where batteries were counted as a material on its own.

These simplifications have also been set up to handle the complexity and to keep it to a decent level because as we will see in the next section, other parameters have been added with the idea of increasing the modelling possibilities. The monitoring indicators have also been extended to describe different impacts on the vehicles in order to assess the relevance of the scenarios thus created.

### C. Additional parameters included in the collaborative prototype tool

As for Gassner et al. (2021), the main point of the prototype is to make scenarios based notably on evolutions of the city modal split and on electrification. In this perspective, the tool does include these two parameters. However, as said previously, the tool is intended to offer more parameter sets.

To this end, several parameters have been added. All of them are taken into account in the study of Gassner et.al. but in contrast to their study, they are not set on long-term trends or considered fixed over time.

Indicators are also major components of the prototype as they provide information on the impact of the scenario created. Two types of indicators have been incorporated: some reflect the impact of simply buying a vehicle, such as the material amount and its impact on water use, and others reflect the use of the car, such as the direct greenhouse gas emitted during its use.

Each indicator has been taken to highlight a different issue regarding urban mobility. For example, the material quantity has been taken to represent the material vulnerability, particulate matter with a diameter of less than 10 micrometers (PM10) emissions account for air pollution which is a major issue of city mobility, GHG emissions are able to give information on the impact of transportation evolution on climate and water use represents the direct needs in water which already suffers scarcity in some regions (Seckler, Barker, and Amarasinghe 1999).

## IV. DESCRIPTION OF THE PROTOTYPE FOR STUDYING MOBILITY IN THE CITY OF LYON

### A. Presentation of the model

To model an alternative scenario, the user is invited to use different sliders which represent the choices for the evolution of the key parameters presented above. Therefore, several sliders have been structured in such a way that it is possible to vary all the following parameters:

- The mobility demand per capita (varies between 0 and 20 000 p.km/capita);
- The modal split for mobility between buses, cars and bicycles (a rate between 0 and 100% for each vehicle);
- The average number of cars and bicycles per capita (comprised between 0 and 1 for both vehicles);
- The average lifespan of cars, buses and bicycles, which make it possible to renew vehicles to a greater or lesser extent (varies between 5 and 30 years, depending on the vehicles considered);
- The electrification rate of cars and buses (a rate between 0 and 100%);
- The rate of mass reduction, whether by substitution of steel by aluminium, as assumed by a forward-looking scenario established by Rauzier et al., (2020), or by a cut into the mass of the vehicle, arising from the idea of a sobriety in material uses (a rate between 0 and 100% representing the implementation of mass reduction measures).

To understand the consequences of a change in a parameter, indicators in the form of vertical bars or pie charts give the results of the scenario to the user in real time. Namely, they are:

- The percentage share of each type of vehicle purchased for the scenario (pie chart);
- The total material required to build these vehicles, with a distinction between the 3 metals considered, the 3 metals in the Li-ion batteries, the rest of metals for the batteries and the rest of materials required to build the vehicles (under the form of a vertical bar);
- The total amount of water used to process materials (vertical bar);
- The total amount of GHG emitted for the manufacture of metals, and also the emission during the usage phase of the vehicle (vertical bar);
- The total amount of PM10 particles emitted during the manufacture of the metals, as well as the emissions during the usage phase of the vehicle (vertical bars). PM10 take into account tyres, brakes and exhaust emissions for each type of vehicle, except for bicycles where their value is considered to be 0 during the usage phase and then moving down to the next line.

#### B. Assumptions for calculation and parametrisation

After having described the main features in the first section, the calculations to obtain the different results of the scenarios will be detailed thereafter. Concerning the superscripts present on the different variables, the “ref” stands for “year of reference” which is based on real data from the year 2015 and accounts thus for a constant. Other variables are based on the input of the user.

More precisely, the first five equations will detail how the inputs of the users are taken into account to calculate the base data to produce a scenario. The first variable to be calculated is the number of vehicles for the scenario. It is calculated differently depending on vehicles. Buses are assumed to be bought directly based on the demand of transport of inhabitants (eq. 1). The assumption made for this calculation is that the covered mobility demand per buses remains constant over time.

$$N_{bus} = \frac{(d * r_{bus}) * N_{bus}^{ref}}{d^{ref} * r_{bus}^{ref}} \quad (1)$$

where  $N_{bus}$  is the number of buses purchased,  $d$  is the mobility demand per capita and  $r_{bus}$  is the percentage of the mobility demand assigned to buses per capita.

Concerning cars and bicycles, they are underused in average compared to the distance they could travel per year when taking national travel average made per inhabitant (Association négaWatt 2017), so only their age and the rate of vehicle per inhabitant is a factor of renewal (eq. 2).

$$N_{pv} = \frac{i^{ref} * n_{pv}}{a_{pv}} \quad (2)$$

where  $N_{pv}$  is the number of personal vehicles purchased, which can be cars or bicycles,  $i$  is the number of inhabitants in the considered territory,  $n_{pv}$  is the number of vehicles per inhabitant and  $a_{pv}$  is the average lifespan of the vehicle.

Then, for cars and buses, it is possible to implement a rate of electrification which will give the final number of vehicles by propulsion (eq. 3 and eq. 4).

$$N_{pv/bus}^{EV} = N_{pv/bus} * r_{EV} \quad (3)$$

$$N_{pv/bus}^{ICEV} = N_{pv/bus} * (1 - r_{EV}) \quad (4)$$

where  $N_{pv/bus}^{EV}$  and  $N_{pv/bus}^{ICEV}$  are respectively the number of electric buses and cars and the number of internal combustion engine buses and cars and  $r_{EV}$  is the rate of electrification.

Finally, the user can also change the mass of the cars only, whether by substitution of steel by aluminium, or by reducing the global weight of the car by sobriety of design, according to equation 5. Although the substitution of steel for aluminum may be seen as weakening vehicles, it is now considered an important factor in weight reduction projections (Rauzier et al., 2020).

$$m_{EV/ICEV} = m_{EV/ICEV}^{ref} + r_{substitution} * (-c^{steel} * q_{EV/ICEV}^{steel} + c^{alu} * q_{EV/ICEV}^{alu}) - r_{sobriety} * c^{sobriety} * m_{EV/ICEV}^{ref} * \left( \frac{q_{EV/ICEV}^{steel}}{q_{EV/ICEV}^{mtot}} + \frac{q_{EV/ICEV}^{alu}}{q_{EV/ICEV}^{mtot}} + \frac{q_{EV/ICEV}^{copper}}{q_{EV/ICEV}^{mtot}} \right) \quad (5)$$

where  $m_{EV/ICEV}$  is the total weight of a single electric or internal combustion engine car,  $r_{substitution}$  and  $r_{sobriety}$  are rates that go from 0 to 100 % which account for the implantation of weight reduction measures,  $c^j$  with  $j$  in [steel, alu, sobriety] (see TABLE III. ), refers to a constant of maximum mass change comprised between 0 and 1 and finally  $q_{EV/ICEV}^k$  with  $k$  in [steel, alu, copper, mtot], refers to the quantity of each metal per vehicle with  $q_{EV/ICEV}^{mtot}$  representing the quantity of the summed mass of the 3 metals in the vehicle considered.

Based on the calculation of these values, a total amount of material is displayed to the user as well as GHG emissions and water used to produce these materials. The calculation of the total mass of materials is simply the multiplication of the unit mass value of vehicles by their number. However, a distinction is made in the final display of the scenario by differentiating between the three metals considered for the vehicles, the three metals used for their battery and the remaining mass of the vehicle being composed of other materials.

Concerning the water use, GHG and PM10 emissions related to manufacture of metals, they are calculated as follow (eq. 6):

$$M_{water/GHG/PM10} = \sum_{pv,bus} \sum_l m_{pv,bus}^l * N_{pv,bus} * I_{water/GHG/PM10}^l \quad (6)$$

where  $M_{water/GHG/PM10}$  is the total mass of water used or GHG and PM10 emitted for the current scenario,  $m_{pv,bus}^l$  is the mass of the metal with  $l$  in [steel, aluminium, copper] in the considered vehicle, and  $I_{water/GHG/PM10}^l$  is the impact of the metal manufacture expressed in kg of water used or in kg of GHG and PM10 emitted per kg of metal  $l$  used.

The impact  $I_{water/GHG/PM10}^l$  takes into account 2 kinds of process: a process for virgin materials, and a process for recycled materials. Therefore,  $I_{water/GHG/PM10}^l$  can be further decomposed (eq. 7) :

$$I_{water/GHG/PM10}^l = r_{recycled}^{l,ref} * I_{water/GHG/PM10}^{l,recycled} + (1 - r_{recycled}^{l,ref}) * I_{water/GHG/PM10}^{l, virgin} \quad (7)$$

where  $r_{recycled}^{l,ref}$  is a fix rate of recycled material  $l$  used in the French national economy and  $I_{water/GHG/PM10}^{l,recycled}$  and  $I_{water/GHG/PM10}^{l, virgin}$  are the respective impacts of the recycled and virgin metal manufacture expressed in kg of water used or in kg of GHG emitted per kilogram of metal  $l$  used.

Finally, direct emissions are also calculated for GHG and PM10, based on the mobility demand for each vehicle according to equation 8. What can be seen is that direct emissions of the whole usage phase of the vehicles are considered.

$$I_{GHG/PM10} = \sum_{pv,bus} \frac{N_{pv,bus} * I_{pv,bus}^{km} * d_{pv,bus} * a_{pv,bus}}{p_{pv,bus}} \quad (8)$$

where  $I_{GHG/PM10}$  is the total emission in tons of GHG or PM10 concerning usage phase of vehicles for the current scenario,  $I_{pv,bus}^{km}$  is the emissions of GHG or PM10 per vehicle and is expressed in t/p.km,  $d_{pv,bus}$  is the mobility demand of the vehicle,  $a_{pv,bus}$  is the average age of the type of vehicle considered and  $p_{pv,bus}$  is the average number of passenger per vehicle.

### C. Results

With these assumptions and calculations, it is now possible to create several scenarios. Some typical scenarios are imagined here, but it is possible for the user to create new different scenarios.

Table II. Value of the different constants changing the mass of vehicle

	Constants		
	$c^{steel}$	$c^{alu}$	$c^{sobriety}$
Percentage	54 %	35 %	20 %

As a reference scenario, the year 2015 for the city of Lyon and its hinterland (the metropole and the rest of the Rhone department) is modelled with actual statistics at the Lyon and at the national scale. This scenario does not return the number of vehicles purchased according to official sources in 2015, but the number of vehicles estimated to be purchased in 2015 from the modelling. The difference between the output of the model regarding the number of vehicles that should be purchased in 2015 and the real vehicle purchases according to official statistics of 2015 is of less than 3% for each type of vehicle when taking the calibration made with the data in the “reference scenario” from table 3. Thus, the assumptions of calculations of the prototype are relevant since they allow to describe a reality rather precisely. In addition to this base scenario, five others have been created to understand the implications of different strategies to change the urban mobility.

A first scenario looks at the impact of an all-electric switch from 0.91 to 100%, while maintaining the current modal split and vehicle characteristics. The results in table 4 show that for such a scenario the total weight of vehicles materials increase from 20%, while the mass of the 3 metals covered decreases from approximately 17%. This is due to the fact that electric vehicles are less demanding in steel while this metal makes up the majority of the car’s body. Apart from steel, this scenario requires more aluminium and copper which quantity increase by respectively 72% and 662 %. This has direct consequences on the water necessary to manufacture these 3 metals since the water demand increases by 64 %, accounting for approximately 760 000 tons (or m3) of supplementary water required. The same effect is observed on GHG emissions required for the manufacture, i.e., an increase of 13%. These two increases are due mainly to the aluminium manufacturing process which requires a lot more water (up to a factor 75) than the process of steel, and releases more GHG.

A remarkable effect of the switch to electric is that the GHG emissions in usage phase have decrease by 85%, of approximately 1 Mt, thanks to a French electricity mix with very little direct carbon emissions. Exhaust emissions have also drastically decreased, since PM10 emissions have been cut by 65%. Yet, more than one third is still remaining because tires and brakes are still emitted in the same quantity, as the number of cars has not decreased. So, we see that although direct GHG and PM10 emissions have been reduced, copper consumption has exploded and aluminium consumption and water resources needed to manufacture these vehicles have increased significantly. Thus, this scenario would be more relevant from a climate and urban health perspective. However, it would also be less suiting from a water use perspective and from the new vulnerability created and linked to the copper supply.

Table III. Different scenario and their parameters

Scenarios	$d$ ( $p.km/capita$ )	$r_{bus}$ (%)	$r_{car}$ (%)	$n_{cars}$ ( $n/1000$ $capita$ )	$n_{bicycles}$ ( $n/1000$ $capita$ )	$a_{cars}$ (years)	$a_{bus}$ (years)	$a_{bicycles}$ (years)	$r_{EV}$ (%)	$r_{substitution}$ (%)	$r_{sobriety}$ (%)
Reference scenario	12262	9,44	89	485	960	17	10	20	0.91	0	0
Electrified scenario	12262	9,44	89	485	960	17	10	20	100	0	0
High reduction in mass of cars	12262	9,44	89	485	960	17	10	20	0.91	100	100
High share of bus and bicycle hpv <sup>a</sup>	12262	47.2	44.5	485	960	17	10	20	0.91	0	0
High share of bus and bicycle lpv <sup>b</sup>	12262	47.2	44.5	100	960	17	10	20	0.91	0	0
Low impact scenario	6131	90	0	0	1000	17	15	30	100	0	0

A second scenario, the “High reduction in mass of cars” has been made to look at the consequences in a decline in the average mass of cars. As it might be expected, the total mass of materials decreases, by more than a factor two. As for the electrification scenario, the needs in water drastically increase from approximately 76% because of the substitution between steel and aluminium. This effect would not have been seen if only a sobriety reduction in mass would have been implemented. Concerning GHG and PM10, both emissions linked to manufacture decrease because of the overall lower demand for metals. Emissions linked to usage phase are stable because the reduction of pollutant emissions together with the mass of the vehicle has not yet been implemented. However, a reduction from 3 to 7% of energy requirements can be expected per 10% reduction in mass (Serrenho, Norman, and Allwood 2017). Overall, this scenario allows mainly for a reduction of material resource uses but increases water consumption due to a greater use of aluminium as it consumes between 10 and 75 times more water than steel, depending on whether it is a recycled material or not.

A third and a fourth scenarios are dedicated to modelling the increase in the modal share of public transport and cycling with however one assumption that differentiates the two: the rate of car ownership as well as its use. While in the first scenario, ownership of cars remains the same and only its use decreases, in the second scenario, both

ownership of cars and its use decline. Assumptions for scenario one is that the use of both bicycles and buses is increased by a factor 5, and use of car is decreased by the corresponding amount of p.km.

For the scenario with low-rate ownership, car ownership is decreased approximately by a factor 5 and the use of car by a factor close to 4.5. The loss of travel by car is compensated by the increase of bus use by a factor 5 and a lot more of active mobility share in mobility.

The results of these two scenarios are drastically different. Indeed, while the amount of material required for the scenario with high level of car ownership is 14% higher than the base case of 2015, the scenario with low level of car ownership allows to divide by a factor close to 2.6 the material requirements. Impacts of material manufactures such as water use and GHG and PM10 emissions follow the same trend: they are proportional to the quantity of materials required. However, due to a different ownership of cars, direct emissions are not the same since less cars are available to emit which implies increased carpooling at constant car travel demand. Therefore, the scenario with high modal share of public transport and high car ownership already decreases by a factor of around 2 direct emissions due to the greater efficiency of the bus in terms of emissions per passenger. But the second scenario goes further by diminishing direct GHG and PM10 emissions by a factor of almost 10 compared to the reference scenario. Thus, the rate of ownership of personal vehicles, as well as their use, is a determining factor both for the amount of material used and for direct emissions.

Table IV. Results of the different scenarios

	Total weight of vehicles (t)	Mass of the 3 metals (t)	Mass of the 3 metals in Li-ion batteries (t)	Total water used for all metals (t)	Total GHG emitted by metals manufacture (t)	Total GHG emitted in usage phase (t)	Total PM10 emitted in usage phase (t)	Total PM10 emitted by metals manufacture (t)
Reference scenario	79176	56239	47	1203824	122487	1148366	213	73
Electrified scenario	94765	46937	5147	1971429	138767	171677	75	74
High reduction in mass of cars	49088	26151	47	2124817	97749	1148366	213	51
High share of bus and bicycle hpva	90005	64986	48	1458851	143282	579211	107	85
High share of bus and bicycle lpvb	30310	22807	11	588523	52251	123498	23	31
Low impact scenario	15064	10132	191	348622	25819	708	1	15

The last scenario, called the “low impact” scenario, pushes the use of buses and bicycles to the extreme, while reducing the global travel demand per capita. It is assumed that no one has a personal vehicle anymore, that the travel demand is halved and fulfilled to 90% by buses and that every inhabitant has a bicycle. Electrification of buses is 100% and the age of vehicles before being bought back is increased by 5 years for buses and 10 for bicycles. This scenario is roughly a lower limit of what can be done in terms of impacts on all aspects of materials, water use and emissions. The material and indirect impacts are divided by a factor more than 5 and direct emissions of GHG are divided by close to 4 orders of magnitude.

## V. CONCLUSION

To elaborate a systemic participatory tool on urban mobility, a study of the modelling methodology related to the materials requirements of the urban transport system of Vienna by Gassner et. al, (2021) has been conducted. The objective and assumptions for the construction of our prototype aiming at raising awareness of some systemic problems of urban mobility has then been presented. Finally, first results of the prototype have been highlighted.

More precisely, the results have shown that a main parameter for reducing the impact of urban mobility is personal vehicle ownership, and that changing the modal share is not enough to have a beneficial effect on all indirect impacts. This must be combined with a reduction in vehicle mass, an extension of vehicle life and a reduction in the number of vehicles on the road. In addition, the prototype has shown that general trend towards electrification can indeed drastically reduce GHG and PM10 emissions in France, but poses more significant material and water use problems.

Several perspectives exist for the continuation of this work. Firstly, a technical improvement of the prototype is envisaged on several points to arrive at a more sophisticated tool. Secondly, multi-criteria assessment with social and economic fields is also envisaged, as environmental assessment alone is far from fully reflecting the situation. This can be seen in particular in the scenario of a drastic reduction of vehicles, which does not reflect the general



trends and individual aspirations of our current society. Thirdly, the concrete use of this tool in a participative framework is envisaged with urban actors in real conditions.

The long-term objective of the authors is to generalize this approach to all sectors of the economy and to pinpoint systemic interactions between sectors and environmental pressures.

#### REFERENCES

- [1] Association négaWatt, 2017. Scénario négaWatt 2017-2050 : hypothèses et résultats. <https://negawatt.org/Scenario-negaWatt-2017-2050-hypotheses-et-resultats> (accessed September 2, 2021)
- [2] Banister, D. 2008. The sustainable mobility paradigm. *Transport Policy*, 15(2): 73–80
- [3] Directorate-General for Internal Market, I., Bobba, S., Claudiu, P., et al., 2018. Report on critical raw materials and the circular economy. *Publications Office of the European Union*.
- [4] Emberger, G. 2017. Low carbon transport strategy in Europe: A critical review. *International Journal of Sustainable Transportation*, 11(1): 31–35.
- [5] Fragkias, M., Lobo, J., Strumsky, D., et al., 2013. Does Size Matter? Scaling of CO2 Emissions and U.S. Urban Areas. *PLoS One*, 8(6): e64727.
- [6] Gassner, A., Lederer, J., and Fellner, J. 2020. Material stock development of the transport sector in the city of Vienna. *Journal of Industrial Ecology*, 24(6): 1364–1378
- [7] Gassner, A., Lederer, J., Kovacic, G. et al., 2021. Projection of material flows and stocks in the urban transport sector until 2050 – A scenario-based analysis for the city of Vienna. *Journal of Cleaner Production*, 311: 127591.
- [8] Grosclaude, J.-Y., Rajendra, K. P., and Tubiana, L. 2014. *Regards sur la terre 2014, Dossier: Les promesses de l'innovation durable*. Armand Colin.
- [9] Hernandez, M., Messagie, M., De Gennaro, M. et al., 2017. Resource depletion in an electric vehicle powertrain using different LCA impact methods. *Resources, Conservation and Recycling*, 120 : 119–130.
- [10] Hickman, R., and Banister, D. 2015. *Transport, Climate Change and the City*. Routledge.
- [11] Intergovernmental Panel on Climate Change (Ed.). 2007. Transport and its infrastructure. In *Climate Change 2007—Mitigation of Climate Change: Working Group III contribution to the Fourth Assessment Report of the IPCC*, 323–386. Cambridge Univ. Press.
- [12] Jin, Y., Kim, J., and Guillaume, B. 2016. Review of critical material studies. *Resources, Conservation and Recycling*, 113, 77–87.
- [13] Lamsal, L. N., Martin, R. V., Parrish, D. D., et al., N. A. 2013. Scaling Relationship for NO2 Pollution and Urban Population Size: A Satellite Perspective. *Environmental Science & Technology*, 47(14): 7855–7861.
- [14] Nieuwenhuijsen, M. J. 2020. Urban and transport planning pathways to carbon neutral, liveable and healthy cities; A review of the current evidence. *Environment International*, 140: 105661.
- [15] Rauzier E., Verzat B., Letz T., et al., 2020. Transition industrielle - Prospective énergie matière : vers un outil de modélisation des niveaux de production. <https://librairie.ademe.fr/changement-climatique-et-energie/340-transition-industrielle-prospective-energie-matiere-vers-un-outil-de-modelisation-des-niveaux-de-production.html> (accessed August 15, 2021)
- [16] Seckler, D., Barker, R., and Amarasinghe, U. 1999. Water Scarcity in the Twenty-first Century. *International Journal of Water Resources Development*, 15(1–2): 29–42.
- [17] Serrenho, A. C., Norman, J. B., and Allwood, J. M. 2017. The impact of reducing car weight on global emissions: The future fleet in Great Britain. *Philosophical Transactions. Series A, Mathematical, Physical, and Engineering Sciences*, 375(2095): 20160364
- [18] Zawieska, J., and Pieriegud, J. 2018. Smart city as a tool for sustainable mobility and transport decarbonisation. *Transport Policy*, 63: 39–50.

*Annex 14 - Results displayed by the prototype regarding alternatives designed*

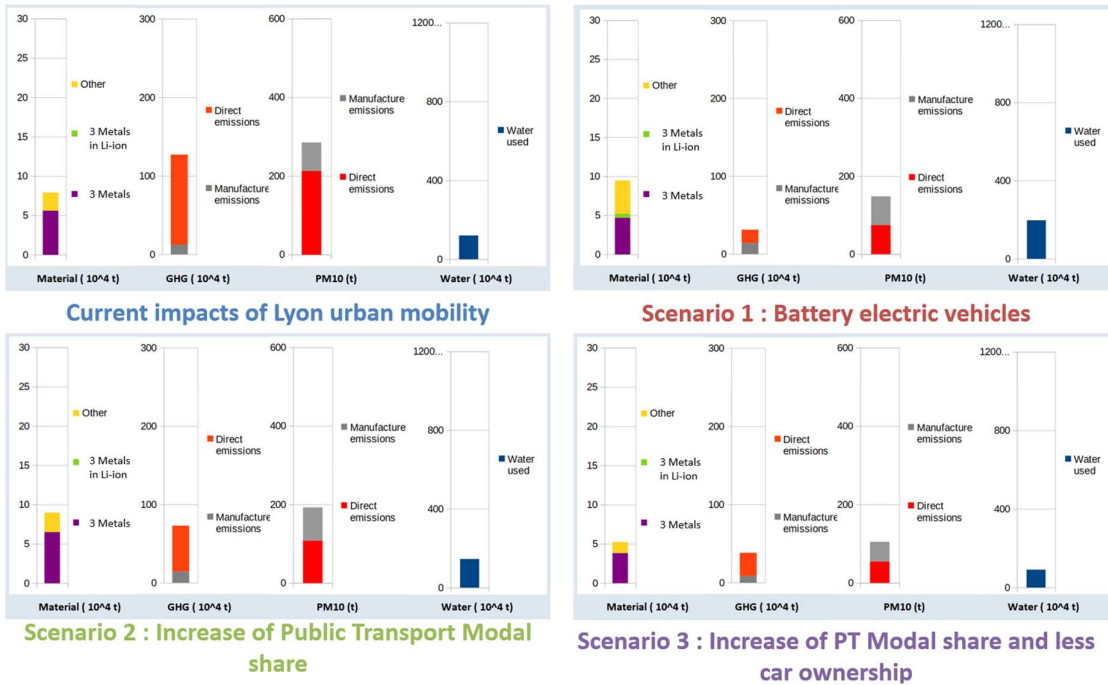

Environmental impacts displayed by the prototype for the reference scenario of the city of Lyon in 2015 and for 3 urban mobility alternatives.

## Bibliography

ADEME. (2018). *Bilan transversal de l'impact de l'électrification par segment—Projet E4T*. <https://bibliothèque.ademe.fr/mobilite-et-transport/1267-bilan-transversal-de-l-impact-de-l-electrification-par-segment.html>

ADEME. (2021). *Transition(s) 2050—Choisir Maintenant—Agir pour le Climat* (ADEME Editions). <https://transitions2050.ademe.fr/>

Agence d'urbanisme aire métropolitaine Lyonnaise. (2018). *Pratiques de déplacements sur les bassins de vie du Scot de l'agglomération lyonnaise | Urbalyon*. <https://www.urbalyon.org/fr/observatoire-des-deplacements/pratiques-de-deplacements-sur-les-bassins-de-vie-du-scot-de>

Aït-Touati, F., & Coccia, E. (2021). *Le cri de Gaïa : Penser la Terre avec Bruno Latour* (Les empêcheurs de penser en rond).

Argonne. (2021). *GREET Model*. <https://greet.es.anl.gov/>

Arnstein, S. R. (1969). A Ladder Of Citizen Participation. *Journal of the American Institute of Planners*, 35(4), 216–224. <https://doi.org/10.1080/01944366908977225>

Association Solagro, Couturier, C., & Charru, M. (2016). *Afterres 2050*.

Baccini, P., & Brunner, P. (2012). *Metabolism of the Anthroposphere: Analysis, evaluation, design (2nd edition)*. The MIT Press. <https://doi.org/10.7551/mitpress/8720.001.0001>

Bahers, J.-B. (2014). Métabolisme territorial et filières de récupération-recyclage : Le cas des déchets d'équipements électriques et électroniques (DEEE) en Midi-Pyrénées. *Développement durable et territoires. Économie, géographie, politique, droit, sociologie*, Vol. 5, n°1, Article Vol. 5, n°1. <https://doi.org/10.4000/developpementdurable.10159>

Bahers, J.-B., Barles, S., & Durand, M. (2018). Urban Metabolism of Intermediate Cities: The Material Flow Analysis, Hinterlands and the Logistics-Hub Function of Rennes and Le Mans (France). *Journal of Industrial Ecology*, 23(3), 686. <https://doi.org/10.1111/jiec.12778>

Barles, S. (2014). L'écologie territoriale et les enjeux de la dématérialisation des sociétés: L'apport de l'analyse des flux de matières. *Développement durable et territoires. Économie, géographie, politique, droit, sociologie*, Vol. 5, n°1, Article Vol. 5, n°1. <https://doi.org/10.4000/developpementdurable.10090>

Basco-Carrera, L., Warren, A., van Beek, E., Jonoski, A., & Giardino, A. (2017). Collaborative modelling or participatory modelling? A framework for water resources management. *Environmental Modelling & Software*, 91, 95–110. <https://doi.org/10.1016/j.envsoft.2017.01.014>

- Beurain, C., & Brulot, S. (2011). L'écologie industrielle comme processus de développement territorial: Une lecture par la proximité. *Revue d'Economie Regionale Urbaine*, *Avril*(2), 313–340.
- Beaussier, T., Caurla, S., Bellon-Maurel, V., & Loiseau, E. (2019). Coupling economic models and environmental assessment methods to support regional policies: A critical review. *Journal of Cleaner Production*, *216*, 408–421. <https://doi.org/10.1016/j.jclepro.2019.01.020>
- Behrens, A., Giljum, S., Kovanda, J., & Niza, S. (2007). The material basis of the global economy: Worldwide patterns of natural resource extraction and their implications for sustainable resource use policies. *Ecological Economics*, *64*(2), 444–453. <https://doi.org/10.1016/j.ecolecon.2007.02.034>
- Biely, K., Maes, D., & Van Passel, S. (2018). The idea of weak sustainability is illegitimate. *Environment, Development and Sustainability*, *20*(1), 223–232. <https://doi.org/10.1007/s10668-016-9878-4>
- Billen, G., Aguilera, E., Einarsson, R., Garnier, J., Gingrich, S., Grizzetti, B., Lassaletta, L., Le Noë, J., & Sanz-Cobena, A. (2021). Reshaping the European agro-food system and closing its nitrogen cycle: The potential of combining dietary change, agroecology, and circularity. *One Earth*, *4*(6), 839–850. <https://doi.org/10.1016/j.oneear.2021.05.008>
- Billen, G., Lassaletta, L., & Garnier, J. (2014). A biogeochemical view of the global agro-food system: Nitrogen flows associated with protein production, consumption and trade. *Global Food Security*, *3*(3), 209–219. <https://doi.org/10.1016/j.gfs.2014.08.003>
- Billen, G., Toussaint, F., & Peeters, P. (1983). *L'écosystème Belgique : Essai d'écologie industrielle*. Bruxelles : Centre de recherche et d'information socio-politiques.
- Bognon, S., Barles, S., Billen, G., & Garnier, J. (2018). Approvisionnement alimentaire parisien du XVIII e au XXI e siècle: Les flux et leur gouvernance. Récit d'une trajectoire socioécologique. *Natures Sciences Sociétés*, *26*(1), 17–32. <https://doi.org/10.1051/nss/2018017>
- Bonnin, M., Azzaro-Pantel, C., Pibouleau, L., Domenech, S., & Villeneuve, J. (2013). Development and validation of a dynamic material flow analysis model for French copper cycle. *Chemical Engineering Research and Design*, *91*(8), 1390–1402.
- Börjeson, L., Höjer, M., Dreborg, K.-H., Ekvall, T., & Finnveden, G. (2006). Scenario types and techniques: Towards a user's guide. *Futures*, *38*(7), 723–739. <https://doi.org/10.1016/j.futures.2005.12.002>
- Borthomieu, A., Courtonne, J.-Y., Jost, V., Mandil, G., & Sturm, P. (2021). *Vers des tables en flux physiques de l'économie française*. 1. <https://hal.inria.fr/hal-03180993>
- Burton, I. (1968). The Quality of the Environment: A Review. *Geographical Review*, *58*(3), 472–481. <https://doi.org/10.2307/212567>

- Calame, P. (2011). *'Essai sur l'oeconomie'—L'encyclopédie du développement durable*. Mayer Charles Leopold Eds. <http://encyclopedie-dd.org/encyclopedie/developpement-durable/1-4-le-developpement-durable-en/essai-sur-l-oeconomie.html>
- Cencic, O., & Rechberger, H. (2008). Material Flow Analysis with Software STAN. *EnviroInfo*.
- Charron, A., Polo-Rehn, L., Besombes, J.-L., Golly, B., Buisson, C., Chanut, H., Marchand, N., Guillaud, G., & Jaffrezo, J.-L. (2019). Identification and quantification of particulate tracers of exhaust and non-exhaust vehicle emissions. *Atmospheric Chemistry and Physics*, 19(7), 5187–5207. <https://doi.org/10.5194/acp-19-5187-2019>
- Choay, F., & Merlin, P. (2015). *Dictionnaire de l'urbanisme et de l'aménagement* (Presses Universitaires de France-P.U.F.).
- Ciacci, L., Chen, W., Passarini, F., Eckelman, M., Vassura, I., & Morselli, L. (2013). Historical evolution of anthropogenic aluminum stocks and flows in Italy. *Resources, Conservation and Recycling*, 72, 1–8. <https://doi.org/10.1016/j.resconrec.2012.12.004>
- CNRS. (2021). *Les écosystèmes*. Sagascience. [https://www.cnrs.fr/cw/dossiers/dosbiodiv/index.php?pid=decouv\\_chapA&zoom\\_id=zoom\\_a1\\_3](https://www.cnrs.fr/cw/dossiers/dosbiodiv/index.php?pid=decouv_chapA&zoom_id=zoom_a1_3)
- Coppens, M., Descos, I., RDC, E., Pellerin, C., & AKTECO. (2018). *L'écologie industrielle et territoriale*. ADEME Editions. <https://librairie.ademe.fr/dechets-economie-circulaire/1070-l-ecologie-industrielle-et-territoriale.html>
- Courtonne, J.-Y. (2016). *Environmental assessment of territories through supply chain analysis: Biophysical accounting for deliberative decision-aiding*. Business administration. Université Grenoble Alpes, NNT : 2016GREAG004.
- Courtonne, J.-Y., Alapetite, J., Longaretti, P.-Y., Dupré, D., & Prados, E. (2015). Downscaling material flow analysis: The case of the cereal supply chain in France. *Ecological Economics*, 118, 67–80. <https://doi.org/10.1016/j.ecolecon.2015.07.007>
- Courtonne, J.-Y., Longaretti, P.-Y., Alapetite, J., & Dupré, D. (2016). Environmental Pressures Embodied in the French Cereals Supply Chain. *Journal of Industrial Ecology*, 20(3), 423–434. <https://doi.org/10.1111/jiec.12431>
- Debref, R., Nieddu, M., & Vivien, F.-D. (2016). Flux de matières et d'énergie : Produire dans les limites de la biosphère. *L'Economie politique*, 69(1), 24–35.
- Debuisson, M. (2014). *Les modes d'interaction pour une dynamique territoriale soutenable : Un apport à l'écologie territoriale* [Phdthesis, Université de Technologie de Troyes]. <https://halshs.archives-ouvertes.fr/tel-01162416>
- Dellink, R. B., & Kandelaars, P. P. A. A. H. (2000). An empirical analysis of dematerialisation: Application to metal policies in The Netherlands. *Ecological Economics*, 33(2), 205–218. [https://doi.org/10.1016/S0921-8009\(99\)00138-X](https://doi.org/10.1016/S0921-8009(99)00138-X)

Directorate-General for Internal Market, I., Bobba, S., Claudiu, P., Huygens, D., Alves Dias, P., Gawlik, B., Tzimas, E., Wittmer, D., Nuss, P., Grohol, M., Saveyn, H., Buraoui, F., Orveillon, G., Hámor, T., Slavko, S., Mathieux, F., Gislev, M., Torres De Matos, C., Blengini, G. A., ... Garbarino, E. (2018). *Report on critical raw materials and the circular economy*. Publications Office of the European Union. <https://data.europa.eu/doi/10.2873/167813>

*Données et études statistiques pour le changement climatique, l'énergie, l'environnement, le logement, et les transports*. (2022). Données et études statistiques pour le changement climatique, l'énergie, l'environnement, le logement, et les transports. <https://www.statistiques.developpement-durable.gouv.fr>

Duchin, F., & Levine, S. H. (2008). Industrial Ecology. In S. E. Jørgensen & B. D. Fath (Eds.), *Encyclopedia of Ecology* (pp. 1968–1975). Academic Press. <https://doi.org/10.1016/B978-008045405-4.00627-3>

Duchin, F., & Levine, S. H. (2013). Embodied Resource Flows in a Global Economy. *Journal of Industrial Ecology*, 17(1), 65–78. <https://doi.org/10.1111/j.1530-9290.2012.00498.x>

Durand, D. (2010). *La systémique* (Presses Universitaires de France). <https://www.cairn.info/la-systemique--9782130578895.htm>

Emberger, G. (2017). Low carbon transport strategy in Europe: A critical review. *International Journal of Sustainable Transportation*, 11(1), 31–35. <https://doi.org/10.1080/15568318.2015.1106246>

*En-ROADS Climate Scenario*. (2021). <https://en-roads.climateinteractive.org/scenario.html>

Etxano, I., & Villalba-Eguiluz, U. (2021). Twenty-five years of social multi-criteria evaluation (SMCE) in the search for sustainability: Analysis of case studies. *Ecological Economics*, 188, 107131. <https://doi.org/10.1016/j.ecolecon.2021.107131>

European Commission. (2018). *Economy-wide material flow accounts handbook: 2018 edition*. <https://doi.org/10.2785/158567>

European Communities (Ed.). (2001). *Economy-wide material flow accounts and derived indicators: A methodological guide*. Luxembourg: Office for Official Publications of the European Communities.

European Environment Agency (EEA). (2017). *Perspectives on transitions to sustainability—European Environment Agency* (Publication No. 25/2017).

European Environment Agency (EEA). (2019). *The sustainability transition in Europe in an age of demographic and technological change* (Publication No. 23/2019).

Eurostat. (2018). *Material flow accounts*. [https://ec.europa.eu/eurostat/databrowser/view/env\\_ac\\_mfa/default/table?lang=fr](https://ec.europa.eu/eurostat/databrowser/view/env_ac_mfa/default/table?lang=fr)

Fragkias, M., Lobo, J., Strumsky, D., & Seto, K. C. (2013). Does Size Matter? Scaling of CO2 Emissions and U.S. Urban Areas. *PLOS ONE*, 8(6), e64727. <https://doi.org/10.1371/journal.pone.0064727>

- Froger, G., Calvo-Mendieta, I., Petit, O., & Vivien, F.-D. (2016). Qu'est-ce que l'économie écologique ? *L'Economie politique*, 69(1), 8–23.
- Gadrey, J., & Lalucq, A. (2016). Que valent les méthodes d'évaluation monétaire de la nature ? *L'Economie politique*, 69(1), 76–87.
- Gassner, A., Lederer, J., & Fellner, J. (2020). Material stock development of the transport sector in the city of Vienna. *Journal of Industrial Ecology*, 24(6), 1364–1378. <https://doi.org/10.1111/jiec.13024>
- Gassner, A., Lederer, J., Kovacic, G., Mollay, U., Schremmer, C., & Fellner, J. (2021). Foresight of material flows and stocks in the urban transport sector until 2050 – A scenario-based analysis for the city of Vienna. *Journal of Cleaner Production*, 311, 127591. <https://doi.org/10.1016/j.jclepro.2021.127591>
- Geels, F. W. (2005). The dynamics of transitions in socio-technical systems: A multi-level analysis of the transition pathway from horse-drawn carriages to automobiles (1860–1930). *Technology Analysis & Strategic Management*, 17(4), 445–476. <https://doi.org/10.1080/09537320500357319>
- Geels, F. W. (2010). Ontologies, socio-technical transitions (to sustainability), and the multi-level perspective. *Research Policy*, 39(4), 495–510. <https://doi.org/10.1016/j.respol.2010.01.022>
- Geels, F. W., & Schot, J. (2007). Typology of sociotechnical transition pathways. *Research Policy*, 36(3), 399–417. <https://doi.org/10.1016/j.respol.2007.01.003>
- Goodland, R. (1995). The Concept of Environmental Sustainability. *Annual Review of Ecology and Systematics*, 26, 1–24.
- Grosclaude, J.-Y., Rajendra, K. P., & Tubiana, L. (2014). *Regards sur la terre 2014, Dossier : Les promesses de l'innovation durable* (Armand Colin).
- Haas, W., Krausmann, F., Wiedenhofer, D., Lauk, C., & Mayer, A. (2020). Spaceship earth's odyssey to a circular economy—A century long perspective. *Resources, Conservation and Recycling*, 163, 105076. <https://doi.org/10.1016/j.resconrec.2020.105076>
- Haberl, H., Wiedenhofer, D., Erb, K.-H., Görg, C., & Krausmann, F. (2017). The Material Stock–Flow–Service Nexus: A New Approach for Tackling the Decoupling Conundrum. *Sustainability (Switzerland)*, 9. <https://doi.org/10.3390/su9071049>
- Hernandez, M., Messagie, M., De Gennaro, M., & Van Mierlo, J. (2017). Resource depletion in an electric vehicle powertrain using different LCA impact methods. *Resources, Conservation and Recycling*, 120, 119–130. <https://doi.org/10.1016/j.resconrec.2016.11.005>
- Holmberg, J., & Robert, K.-H. (2000). Backcasting—A framework for strategic planning. *International Journal of Sustainable Development & World Ecology*, 7(4), 291–308. <https://doi.org/10.1080/13504500009470049>

- Holtz, G., Alkemade, F., de Haan, F., Köhler, J., Trutnevyte, E., Luthe, T., Halbe, J., Papachristos, G., Chappin, E., Kwakkel, J., & Ruutu, S. (2015). Prospects of modelling societal transitions: Position paper of an emerging community. *Environmental Innovation and Societal Transitions*, 17, 41–58. <https://doi.org/10.1016/j.eist.2015.05.006>
- Huesemann, M. H., & Huesemann, J. A. (2008). Will progress in science and technology avert or accelerate global collapse? A critical analysis and policy recommendations. *Environment, Development and Sustainability*, 10(6), 787–825. <https://doi.org/10.1007/s10668-007-9085-4>
- IDDDRI. (2021). *What we do – the DDP initiative*. <https://ddpinitiative.org/discover/>
- Insee—Institut national de la statistique et des études économiques. (2022). <https://www.insee.fr/fr/accueil>
- Institute for Energy and Transport (Joint Research Centre), Grigoratos, T., & Martini, G. (2014). *Non-exhaust traffic related emissions - Brake and tyre wear PM: Literature review*. Publications Office of the European Union. <https://data.europa.eu/doi/10.2790/21481>
- Intergovernmental Panel on Climate Change (Ed.). (2007). Transport and its infrastructure. In *Climate Change 2007—Mitigation of Climate Change: Working Group III contribution to the Fourth Assessment Report of the IPCC* (pp. 323–386). Cambridge University Press. <https://doi.org/10.1017/CBO9780511546013.009>
- Jin, Y., Kim, J., & Guillaume, B. (2016). Review of critical material studies. *Resources, Conservation and Recycling*, 113, 77–87. <https://doi.org/10.1016/j.resconrec.2016.06.003>
- Ju, M., Osako, M., & Harashina, S. (2017). Food loss rate in food supply chain using material flow analysis. *Waste Management*, 61, 443–454. <https://doi.org/10.1016/j.wasman.2017.01.021>
- Kovanda, J. (2021). Economy-wide material system analysis: Mapping material flows through the economy. *Journal of Industrial Ecology*. <https://doi.org/10.1111/jiec.13142>
- Krausmann, F., Gingrich, S., Eisenmenger, N., Erb, K.-H., Haberl, H., & Fischer-Kowalski, M. (2009). Growth in global materials use, GDP and population during the 20th century. *Ecological Economics*, 68, 2696–2705. <https://doi.org/10.1016/j.ecolecon.2009.05.007>
- Krausmann, F., Lauk, C., Haas, W., & Wiedenhofer, D. (2018). From resource extraction to outflows of wastes and emissions: The socioeconomic metabolism of the global economy, 1900–2015. *Global Environmental Change*, 52, 131–140. <https://doi.org/10.1016/j.gloenvcha.2018.07.003>
- Krieger, E., Mangeot, M., Courtonne, J.-Y., Mandil, G., & Sturm, P. (2021). *A modelling tool for designing urban mobility alternatives and evaluating their direct and indirect environmental impacts*. International Conference on Future is Urban 2021.
- Lamsal, L. N., Martin, R. V., Parrish, D. D., & Krotkov, N. A. (2013). Scaling Relationship for NO<sub>2</sub> Pollution and Urban Population Size: A Satellite Perspective. *Environmental Science & Technology*, 47(14), 7855–7861. <https://doi.org/10.1021/es400744g>



Latour, B. (2021). *Où suis-je ? Leçons du confinement à l'usage des terrestres* (Les empêcheurs de penser en rond).

Le service de l'observation et des statistiques (SOeS). (2017). *Les prélèvements d'eau douce en France : Les grands usages en 2013 et leur évolution depuis 20 ans | Données et études statistiques*. Ministère de l'environnement, de l'énergie et de la mer en charge des relations internationales sur le climat.

Le service de l'observation et des statistiques (SOeS). (2021). *Bilan 2018 de la production de déchets en France*. Ministère de la transition écologique.

Leach, M., Scoones, I., & Stirling, A. (2007). *Pathways to Sustainability: An overview of the STEPS Centre approach* (STEPS Approach Paper, Brighton: STEPS Centre).

Lehmann, P., Ammermann, K., Gawel, E., Geiger, C., Hauck, J., Heilmann, J., Meier, J.-N., Ponitka, J., Schicketanz, S., Stemmer, B., Tafarte, P., Thrän, D., & Wolfram, E. (2021). Managing spatial sustainability trade-offs: The case of wind power. *Ecological Economics*, 185, 107029. <https://doi.org/10.1016/j.ecolecon.2021.107029>

Lenglet, J., Courtonne, J.-Y., & Caurla, S. (2017). Material flow analysis of the forest-wood supply chain: A consequential approach for log export policies in France. *Journal of Cleaner Production*, 165, 1296–1305. <https://doi.org/10.1016/j.jclepro.2017.07.177>

Liu, G., Bangs, C. E., & Müller, D. B. (2011). Unearthing Potentials for Decarbonizing the U.S. Aluminum Cycle. *Environmental Science & Technology*, 45(22), 9515–9522. <https://doi.org/10.1021/es202211w>

Lobianco, A., Delacote, P., Caurla, S., & Barkaoui, A. (2015). The importance of introducing spatial heterogeneity in bio-economic forest models: Insights gleaned from FFSM++. *Ecological Modelling*, 309–310, 82–92. <https://doi.org/10.1016/j.ecolmodel.2015.04.012>

Lorius, C., & Carpentier, L. (2011). *Voyage dans l'anthropocène*. Actes Sud.

Lumbroso, S. (2019). *Prospective et stratégies pour l'environnement : Entre fabrique des futurs et situation de gestion, quelles prises pour l'action ?* [These de doctorat, Université Paris-Saclay (ComUE)]. <http://www.theses.fr/2019SACLA001>

Ma, D., Hu, S., Zhu, B., & Jin, Y. (2012). Carbon substance flow analysis and CO2 emission scenario analysis for China. *Clean Technologies and Environmental Policy*, 14. <https://doi.org/10.1007/s10098-012-0452-y>

Maddison, A. (2001). *The World Economy: A Millennial Perspective*. OECD.

Maillefert, M., & Robert, I. (2014). Écologie industrielle, économie de la fonctionnalité, entreprises et territoires : Vers de nouveaux modèles productifs et organisationnels ? *Développement durable et territoires. Économie, géographie, politique, droit, sociologie*, Vol. 5, n°1, Article Vol. 5, n°1. <https://doi.org/10.4000/developpementdurable.10177>

- Mancini, L., Benini, L., & Sala, S. (2015). Resource footprint of Europe: Complementarity of material flow analysis and life cycle assessment for policy support. *Environmental Science & Policy*, *54*, 367–376. <https://doi.org/10.1016/j.envsci.2015.07.025>
- Manfroni, M., Velasco-Fernández, R., Pérez-Sánchez, L., Bukkens, S. G. F., & Giampietro, M. (2021). The profile of time allocation in the metabolic pattern of society: An internal biophysical limit to economic growth. *Ecological Economics*, *190*, 107183. <https://doi.org/10.1016/j.ecolecon.2021.107183>
- Martinez-Alier, J., Munda, G., & O'Neill, J. (1998). Weak comparability of values as a foundation for ecological economics. *Ecological Economics*, *26*(3), 277–286. [https://doi.org/10.1016/S0921-8009\(97\)00120-1](https://doi.org/10.1016/S0921-8009(97)00120-1)
- Mauviel, O. (2021). *Modular approach to material flow analysis*. French Regional Conference on Complex Systems - FRCCS 2021.
- Meadows, D., Meadows, D., & Randers, J. (1972). *The Limits to Growth*. Universe Books.
- Milkoreit, M. (2017). Imaginary politics: Climate change and making the future. *Elementa: Science of the Anthropocene*, *5*, 62. <https://doi.org/10.1525/elementa.249>
- Ministère de la transition écologique et solidaire, C. général au développement durable. (2019). *Les émissions de gaz à effet de serre du secteur des transports*. L'environnement en France - Rapport sur l'état de l'environnement. <https://ree.developpement-durable.gouv.fr/themes/defis-environnementaux/changement-climatique/emissions-de-gaz-a-effet-de-serre/article/les-emissions-de-gaz-a-effet-de-serre-du-secteur-des-transports>
- Morandin Ahuerma, I., Contreras Hernández, A., Ayala-Ortiz, D., & Pérez-Maqueo, O. (2019). Socio-Ecosystemic Sustainability. *Sustainability*, *11*, 3354. <https://doi.org/10.3390/su11123354>
- Munda, G. (2004). Munda, G.: Social Multi-Criteria Evaluation: Methodological Foundations and Operational Consequences. *European Journal of Operational Research* *158*(3), 662-677. *European Journal of Operational Research*, 662–677. [https://doi.org/10.1016/S0377-2217\(03\)00369-2](https://doi.org/10.1016/S0377-2217(03)00369-2)
- Munda, G. (2007). *Social Multi-Criteria Evaluation for a Sustainable Economy* (2008e édition). Springer-Verlag Berlin and Heidelberg GmbH & Co. K.
- Muralikrishna, I. V., & Manickam, V. (2017). Chapter Five—Life Cycle Assessment. In I. V. Muralikrishna & V. Manickam (Eds.), *Environmental Management* (pp. 57–75). Butterworth-Heinemann. <https://doi.org/10.1016/B978-0-12-811989-1.00005-1>
- négaWatt. (2017). *Scénario négaWatt 2017 | Diagramme complet 2015*. <https://negawatt.org/scenario/sankeys/2015>
- Nieuwenhuijsen, M. J. (2020). Urban and transport planning pathways to carbon neutral, liveable and healthy cities; A review of the current evidence. *Environment International*, *140*, 105661. <https://doi.org/10.1016/j.envint.2020.105661>

Noë, J. L., Billen, G., Lassaletta, L., Silvestre, M., & Garnier, J. (2016). La place du transport de denrées agricoles dans le cycle biogéochimique de l'azote en France : Un aspect de la spécialisation des territoires. *Cahiers Agricultures*, 25, UNSP 15004. <https://doi.org/10.1051/cagri/2016002>

Organisation for Economic Co-operation and Development (OECD). (2008). *Measuring material flows and resource productivity Volume I*. Organisation for Economic Co-operation and Development, Paris.

Pachoud, C., Da Re, R., Ramanzin, M., Bovolenta, S., Gianelle, D., & Sturaro, E. (2020). Tourists and Local Stakeholders' Perception of Ecosystem Services Provided by Summer Farms in the Eastern Italian Alps. *Sustainability*, 12(3), 1095. <https://doi.org/10.3390/su12031095>

Pauliuk, S., & Hertwich, E. G. (2015). Socioeconomic metabolism as paradigm for studying the biophysical basis of human societies. *Ecological Economics*, 119, 83–93. <https://doi.org/10.1016/j.ecolecon.2015.08.012>

Popa, F., Guillermin, M., & Dedeurwaerdere, T. (2015). A pragmatist approach to transdisciplinarity in sustainability research: From complex systems theory to reflexive science. *Futures*, 65, 45–56. <https://doi.org/10.1016/j.futures.2014.02.002>

Purvis, B., Mao, Y., & Robinson, D. (2019). Three pillars of sustainability: In search of conceptual origins. *Sustainability Science*, 14(3), 681–695. <https://doi.org/10.1007/s11625-018-0627-5>

Qiao, M., Zheng, Y.-M., & Zhu, Y.-G. (2011). Material flow analysis of phosphorus through food consumption in two megacities in northern China. *Chemosphere*, 84(6), 773–778. <https://doi.org/10.1016/j.chemosphere.2011.01.050>

Quist, J. (2007). *Backcasting for a Sustainable Future: The Impact After 10 Years*. Eburon Uitgeverij B.V.

Quist, J., & Vergragt, P. (2006). Past and future of backcasting: The shift to stakeholder participation and a proposal for a methodological framework. *Futures*, 38(9), 1027–1045. <https://doi.org/10.1016/j.futures.2006.02.010>

Rauzier, E., VERZAT, B., LETZ, T., & METIVIER, S. (2020). *Transition industrielle - Prospective énergie matière : Vers un outil de modélisation des niveaux de production* (Expertises). <https://bibliothèque.ademe.fr/changement-climatique-et-energie/340-transition-industrielle-prospective-energie-matiere-vers-un-outil-de-modelisation-des-niveaux-de-production.html>

Regulation (EU) No 691/2011 of the European Parliament and of the Council of 6 July 2011 on European environmental economic accounts (Text with EEA relevance), (2014). <http://data.europa.eu/eli/reg/2011/691/2014-06-16/eng>

Renou, G. (2018). Repenser l'économie dans une perspective écologique. Une cartographie des principaux enjeux. *Lectures*. <https://journals.openedition.org/lectures/29548#ftn10>

Rochat, D., Binder, C. R., Diaz, J., & Jolliet, O. (2013). Combining Material Flow Analysis, Life Cycle Assessment, and Multiattribute Utility Theory. *Journal of Industrial Ecology*, 17(5), 642–655. <https://doi.org/10.1111/jiec.12025>

Roux, E., Gumuchian, H., Grasset, E., & Lajarge, R. (2003). *Les acteurs, ces oubliés du territoire* (p. 186). Economica. <https://halshs.archives-ouvertes.fr/halshs-00329376>

RTE. (2021). *Futurs énergétiques 2050 : Les scénarios de mix de production à l'étude permettant d'atteindre la neutralité carbone à l'horizon 2050*.

Sachs, J. D. (2015). *The Age of Sustainable Development* (p. 544 Pages). Columbia University Press.

Savaget, P., Geissdoerfer, M., Kharrazi, A., & Evans, S. (2019). The theoretical foundations of sociotechnical systems change for sustainability: A systematic literature review. *Journal of Cleaner Production*, 206, 878–892. <https://doi.org/10.1016/j.jclepro.2018.09.208>

Seiffert, M. E. B., & Loch, C. (2005). Systemic thinking in environmental management: Support for sustainable development. *Journal of Cleaner Production*, 13(12), 1197–1202. <https://doi.org/10.1016/j.jclepro.2004.07.004>

Smith, A., Stirling, A., & Berkhout, F. (2005). The governance of sustainable socio-technical transitions. *Research Policy*, 34(10), 1491–1510. <https://doi.org/10.1016/j.respol.2005.07.005>

Steffen, W., Broadgate, W., Deutsch, L., Gaffney, O., & Ludwig, C. (2015). The trajectory of the Anthropocene: The Great Acceleration. *The Anthropocene Review*, 2(1), 81–98. <https://doi.org/10.1177/2053019614564785>

Steffen, W., Richardson, K., Rockstrom, J., Cornell, S. E., Fetzer, I., Bennett, E. M., Biggs, R., Carpenter, S. R., de Vries, W., de Wit, C. A., Folke, C., Gerten, D., Heinke, J., Mace, G. M., Persson, L. M., Ramanathan, V., Reyers, B., & Sorlin, S. (2015). Planetary boundaries: Guiding human development on a changing planet. *Science*, 347(6223), 1259855–1259855. <https://doi.org/10.1126/science.1259855>

Terriflux, & STEEP. (Ongoing project). *Portfolio of AFM operated*. <https://www.terriflux.fr/portfolio>

*Terriflux—Filière forêt bois Grand Est*. (2021). [https://www.terriflux.fr/fm/userfiles//filier\\_foret\\_bois\\_grand\\_est/index.html](https://www.terriflux.fr/fm/userfiles//filier_foret_bois_grand_est/index.html)

The Shift Project. (2020). *Guide pour une mobilité quotidienne bas carbone*. <https://theshiftproject.org/guide-de-la-mobilite-quotidienne-bas-carbone/>

Union Nationale des Produits de Granulats (UNPG). (2020). *L'industrie française des granulats*.

United Nations Environment Program (UNEP). (2010). Assessing the environmental impacts of consumption and production. *International Journal of Sustainability in Higher Education*. <https://10.1108/ijshe.2010.24911daf.001>

- 
- Verger, Y., Petit, C., Barles, S., Billen, G., Garnier, J., Esculier, F., & Maugis, P. (2018). A N, P, C, and water flows metabolism study in a peri-urban territory in France: The case-study of the Saclay plateau. *Resources, Conservation and Recycling*, *137*, 200. <https://doi.org/10.1016/j.resconrec.2018.06.007>
- Wiedmann, T., Lenzen, M., Keyßer, L. T., & Steinberger, J. K. (2020). Scientists' warning on affluence. *Nature Communications*, *11*(1), 3107. <https://doi.org/10.1038/s41467-020-16941-y>
- Wiedmann, T. O., Schandl, H., Lenzen, M., Moran, D., Suh, S., West, J., & Kanemoto, K. (2015). The material footprint of nations. *Proceedings of the National Academy of Sciences*, *112*(20), 6271–6276. <https://doi.org/10.1073/pnas.1220362110>
- Xu, M., Chen, D., Yu, Y., Chen, Z., Zhang, Y., Liu, B., Fu, Y., & Zhu, B. (2021). Assessing resource consumption at the subnational level: A novel accounting method based on provincial selected material consumption. *Journal of Industrial Ecology*, *25*, 580–592. <https://doi.org/10.1111/jiec.13065>
- Yan, L., Wang, A., Chen, Q., & Li, J. (2013). Dynamic material flow analysis of zinc resources in China. *Resources, Conservation, and Recycling*. <https://doi.org/10.1016/j.resconrec.2013.03.004>