



**HAL**  
open science

## Mathematically modelling the retina: what for ?

Bruno Cessac

► **To cite this version:**

Bruno Cessac. Mathematically modelling the retina: what for?. 4 ème congrès de la société de physiologie et biologie intégrative, Sep 2021, Nice, France. hal-03331835

**HAL Id: hal-03331835**

**<https://inria.hal.science/hal-03331835>**

Submitted on 2 Sep 2021

**HAL** is a multi-disciplinary open access archive for the deposit and dissemination of scientific research documents, whether they are published or not. The documents may come from teaching and research institutions in France or abroad, or from public or private research centers.

L'archive ouverte pluridisciplinaire **HAL**, est destinée au dépôt et à la diffusion de documents scientifiques de niveau recherche, publiés ou non, émanant des établissements d'enseignement et de recherche français ou étrangers, des laboratoires publics ou privés.

# Mathematically modelling the retina: what for ?

B. Cessac, Université Côte d'Azur, INRIA,  
Biovision team and Neuromod Institute  
Sophia Antipolis, France



# The visual system

# The visual system

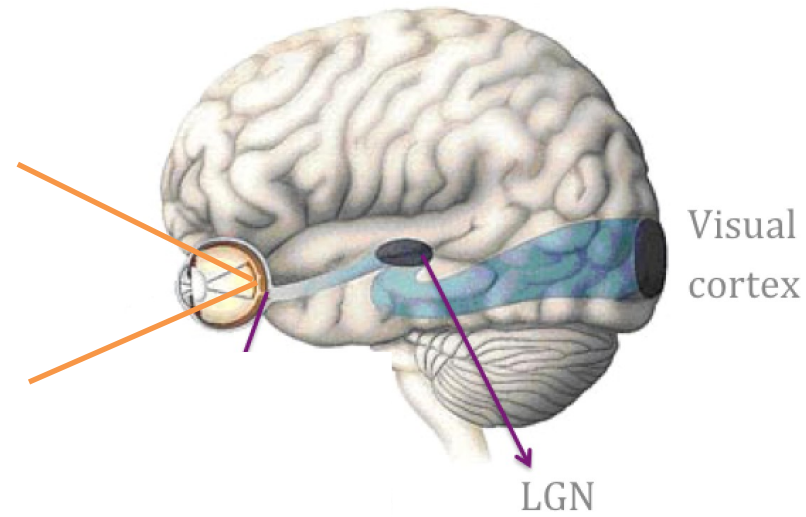
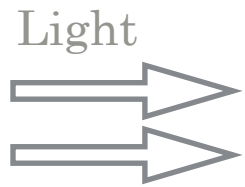

# The visual system

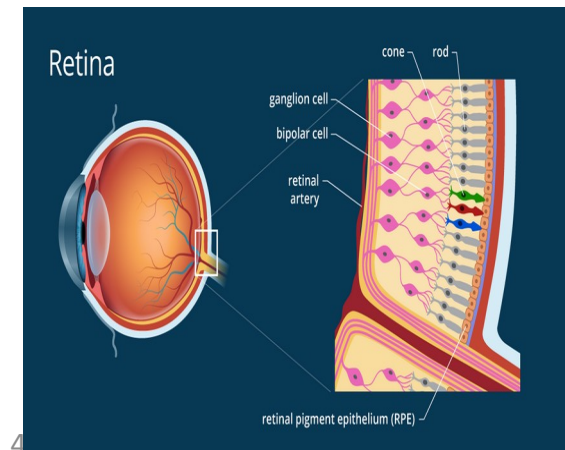
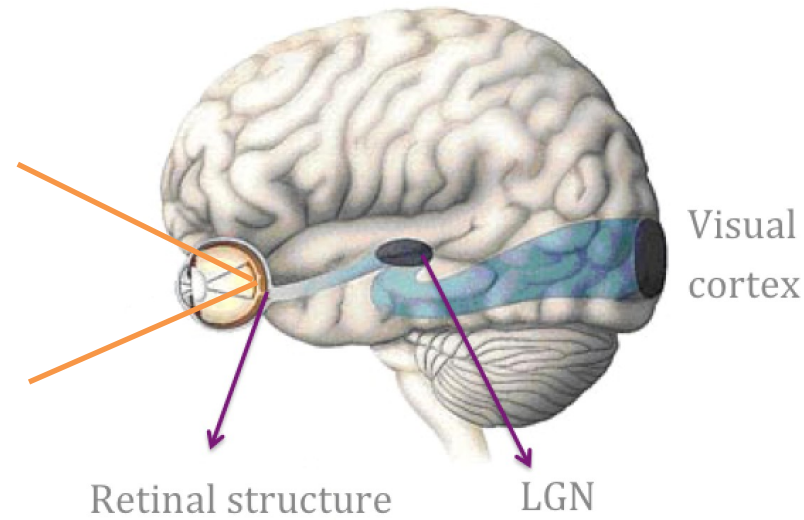
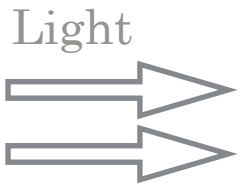

# The visual system

## Retina's layered structure

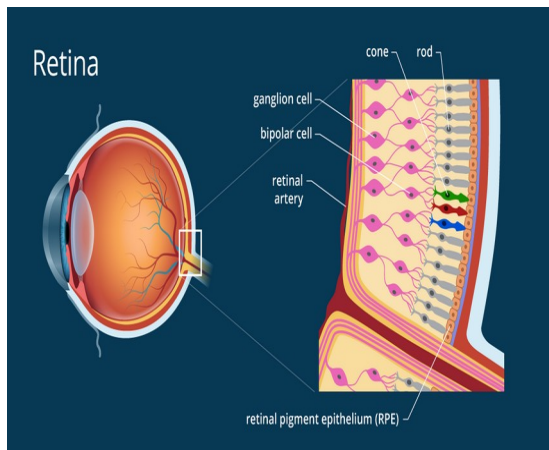
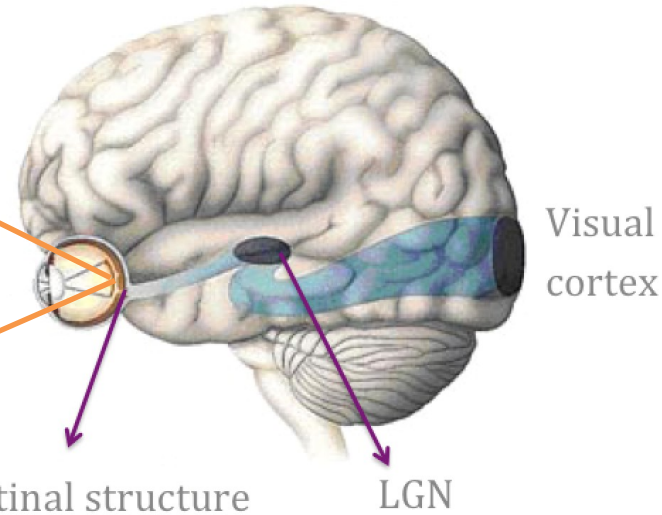
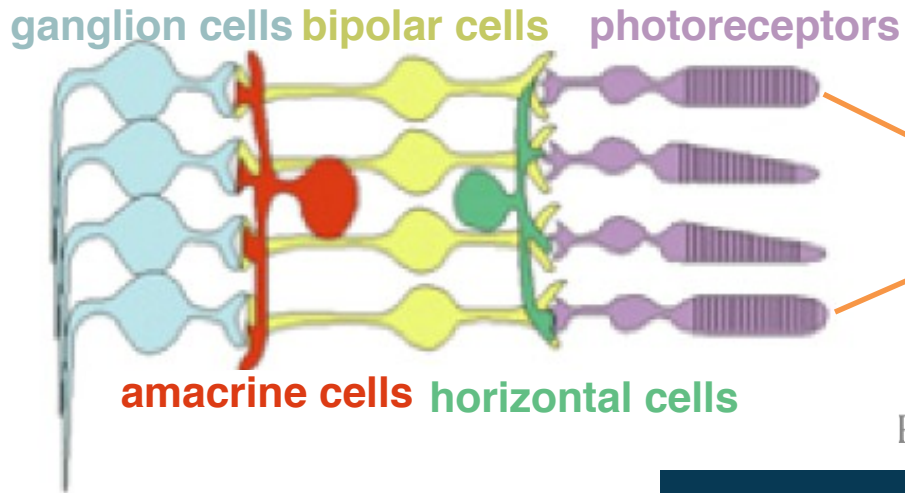

# The visual system

## Retina's layered structure

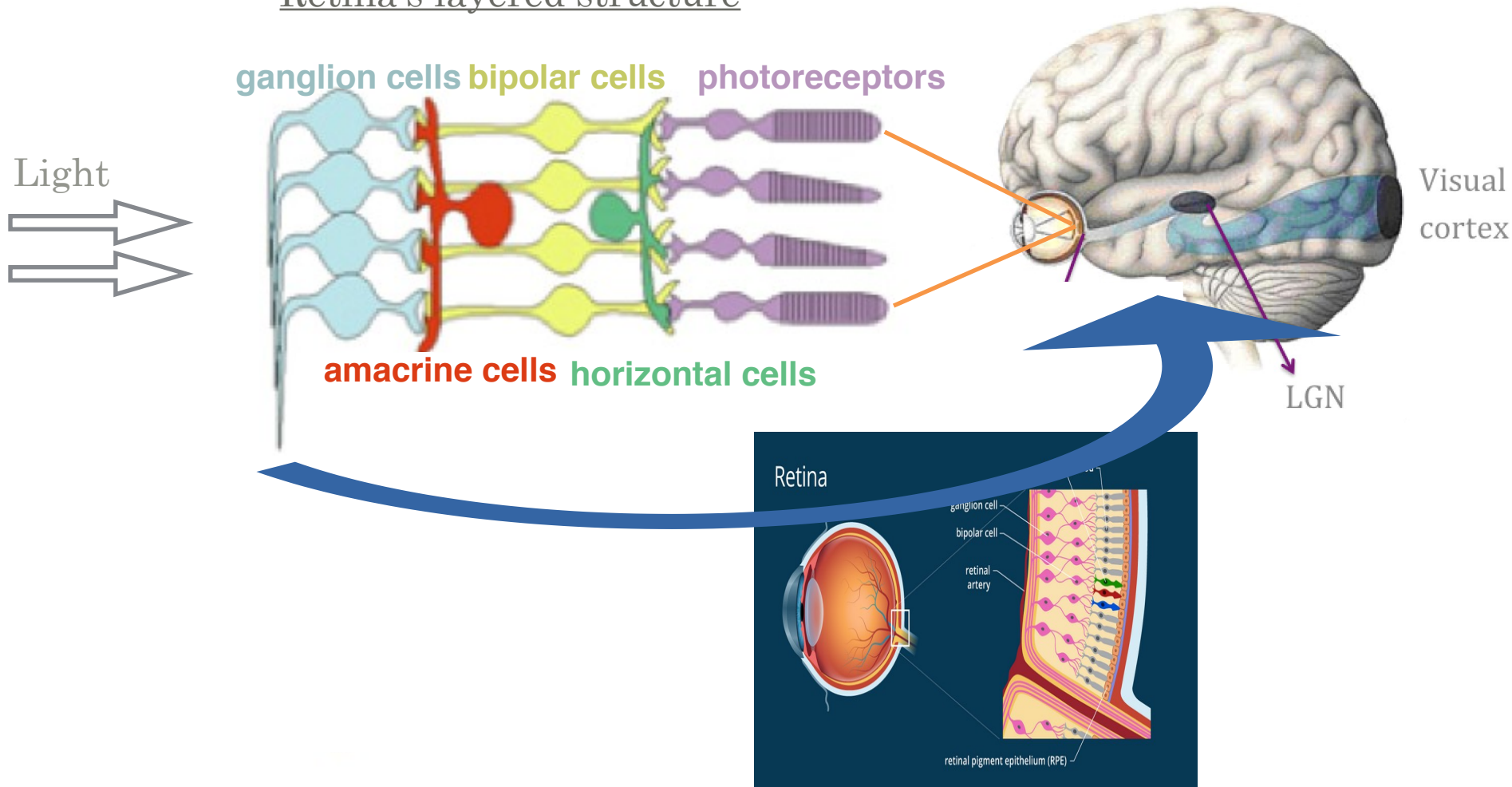

# The visual system

## Retina's layered structure

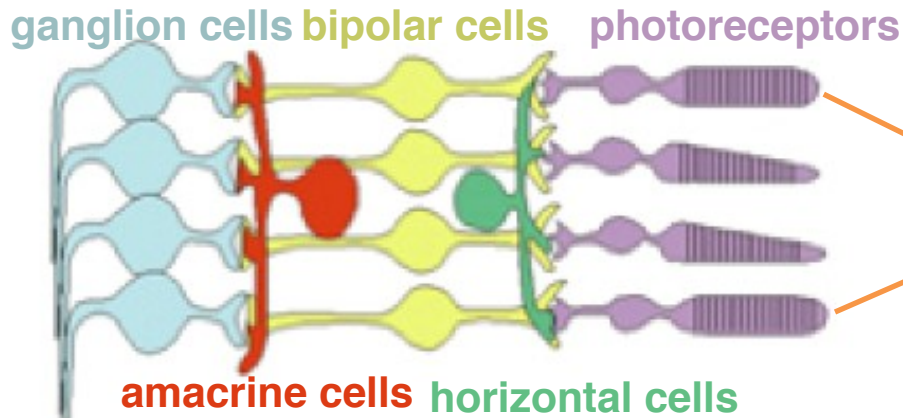

Light

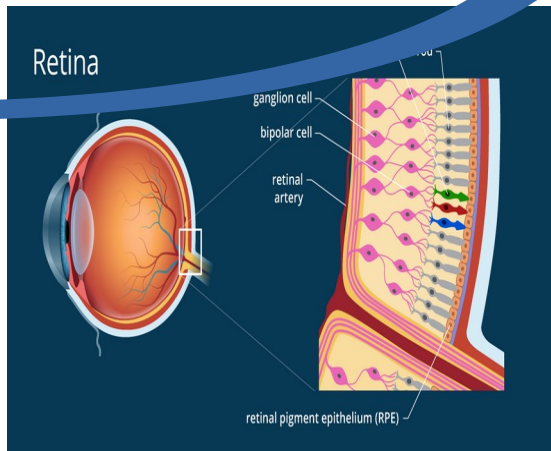
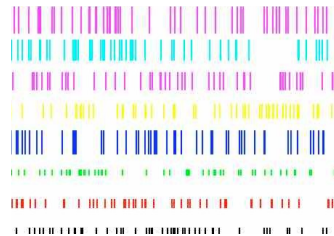
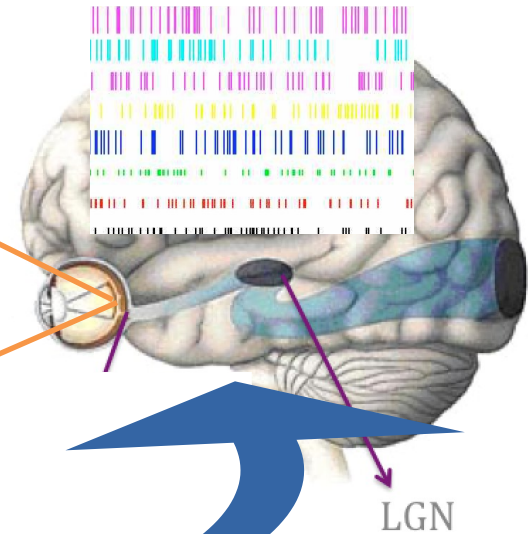



# The visual system

## Retina's layered structure

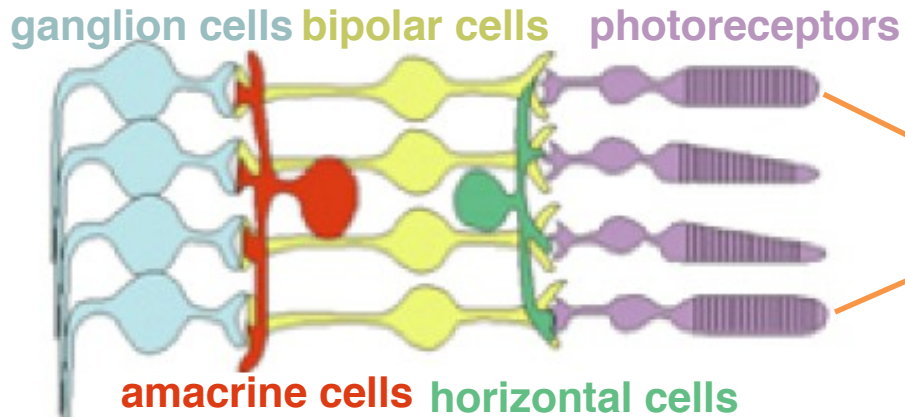

Light

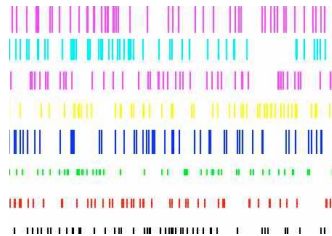
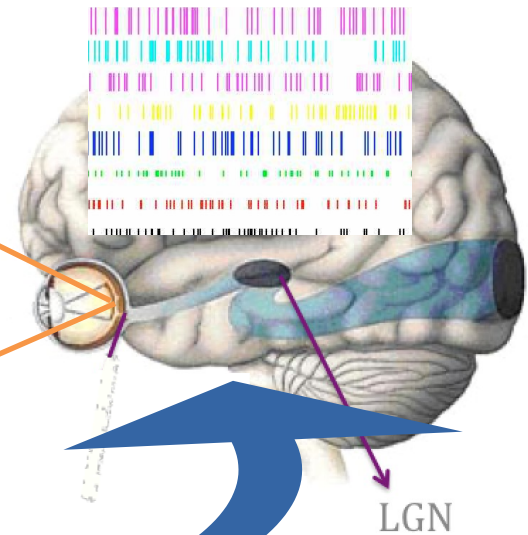

« Information » flux

# The visual system

Encoder

Decoder

Retina's layered structure

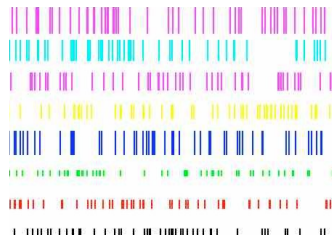
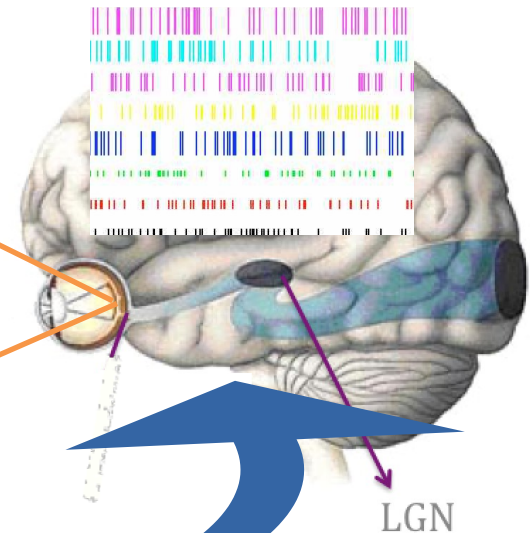
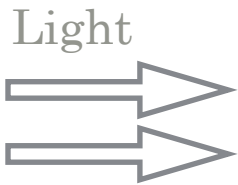
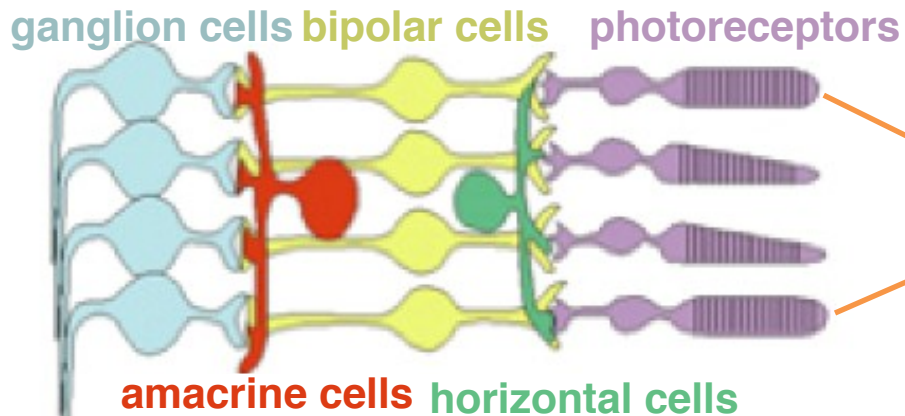

« Information » flux

# The visual system

Encoder

Decoder

Retina's layered structure

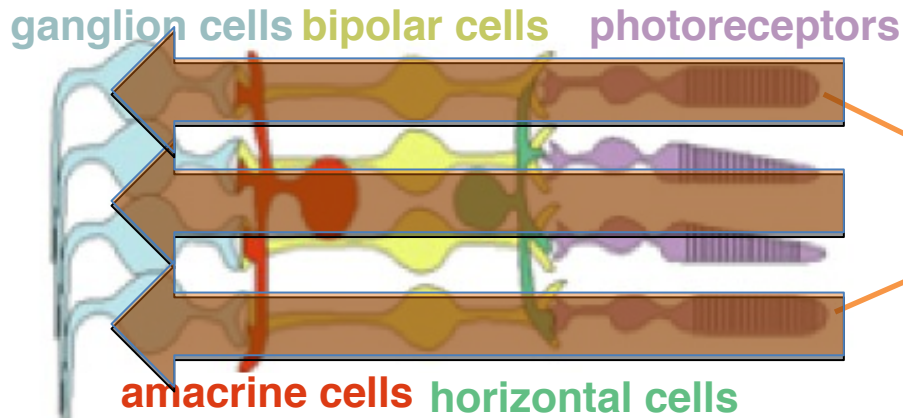

Light

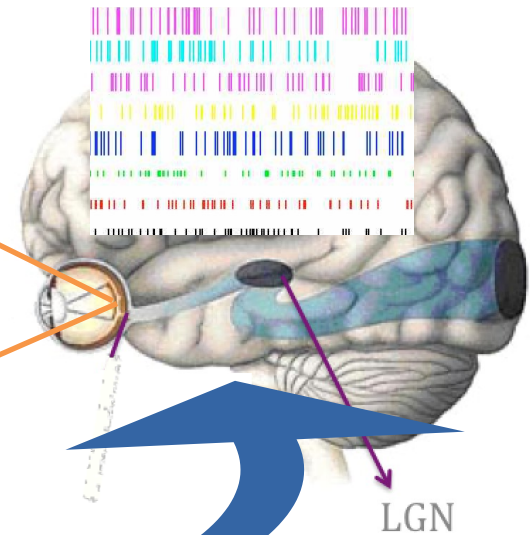

Visual cortex

LGN

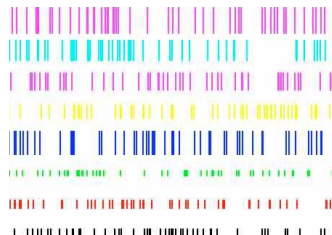

« Information » flux

# The visual system

Encoder

Decoder

Retina's layered structure

ganglion cells bipolar cells photoreceptors

amacrine cells horizontal cells

Light

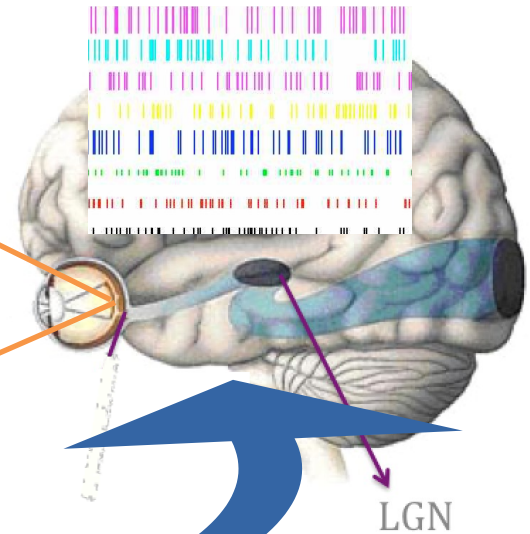
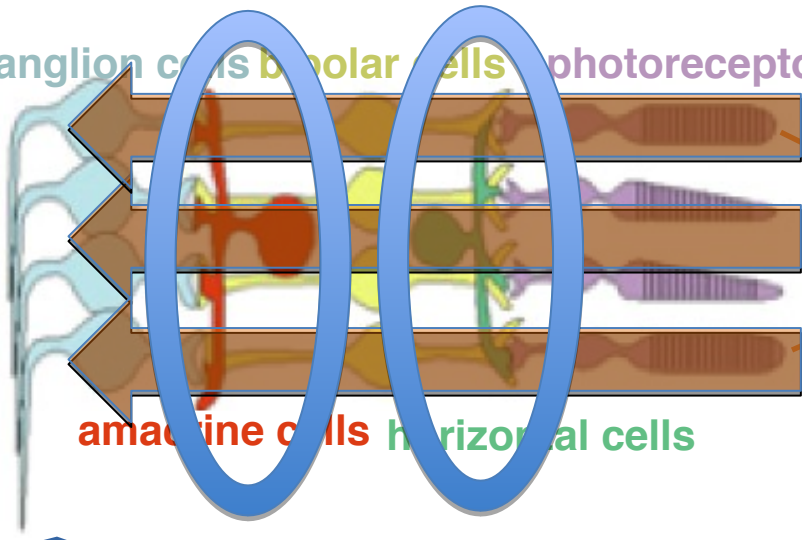
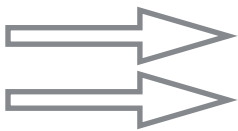

Visual cortex

LGN

« Information » flux

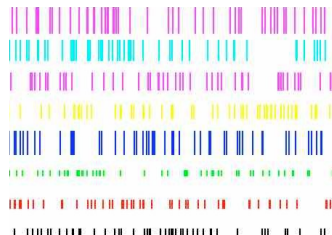

# The visual system

**Horizontal cells contributes to the center surround structure of receptive fields (basic « bricks » of vision)**

# The visual system

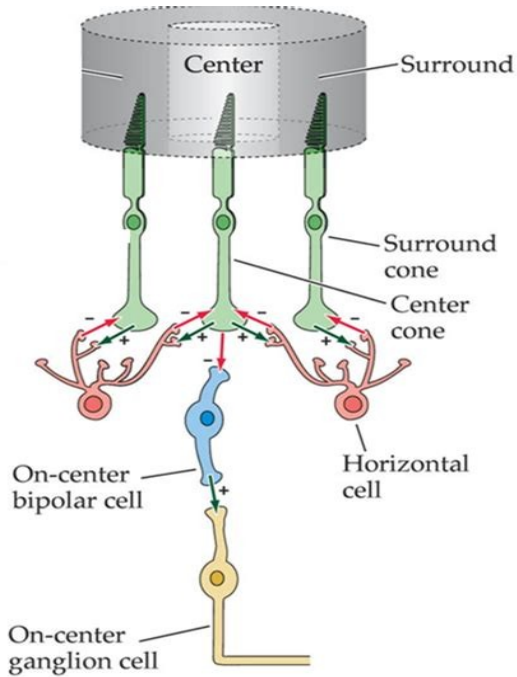

**Horizontal cells contributes to the center surround structure of receptive fields (basic « bricks » of vision)**

# The visual system

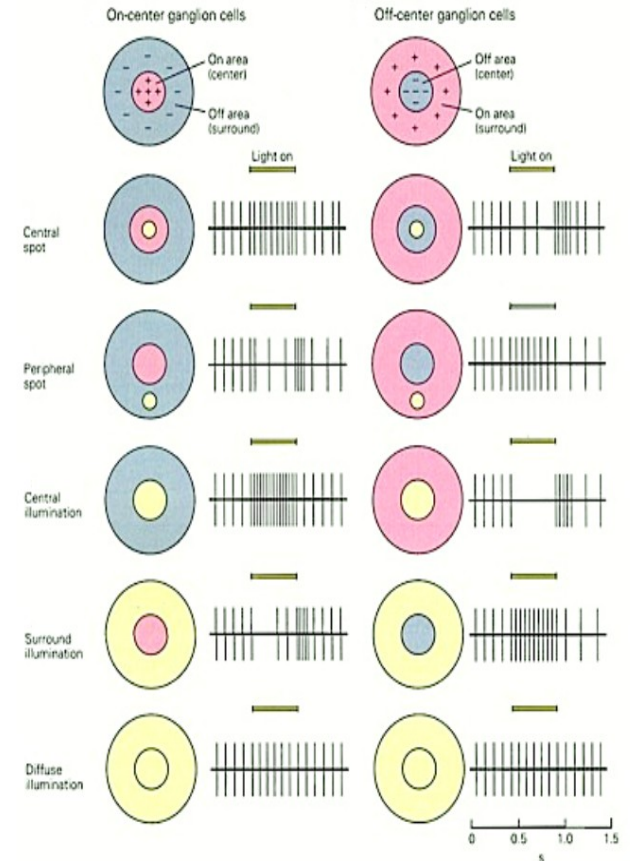
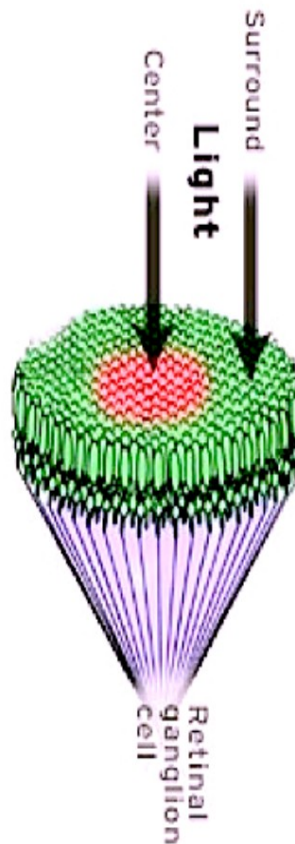
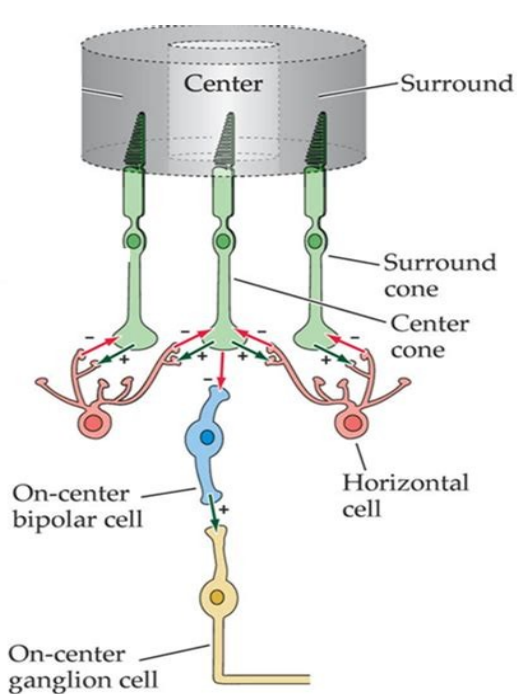

**Horizontal cells contributes to the center surround structure of receptive fields (basic « bricks » of vision)**

# The visual system

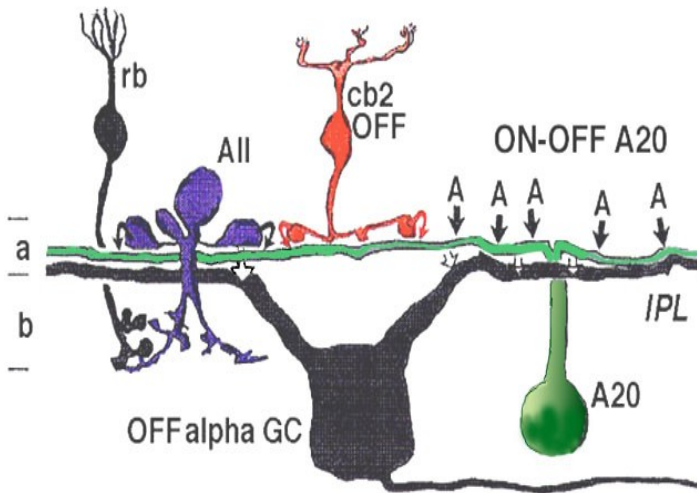
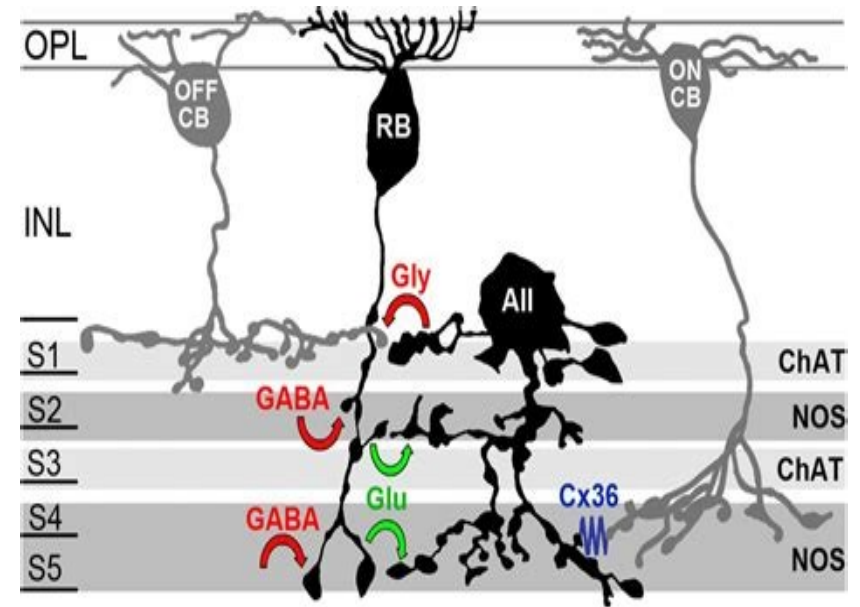

Fig. 27. Wiring diagram of the ON-OFF A20 amacrine cell (displaced).



**Amacrine cells are involved in many fundamental retina « circuits » like the rod cone pathway, or direction sensitivity but their role is still not well understood.**



# The visual system

Encoder

Decoder

Retina's layered structure

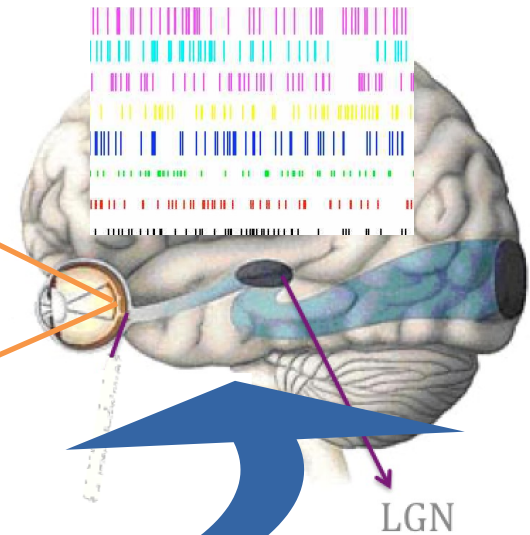
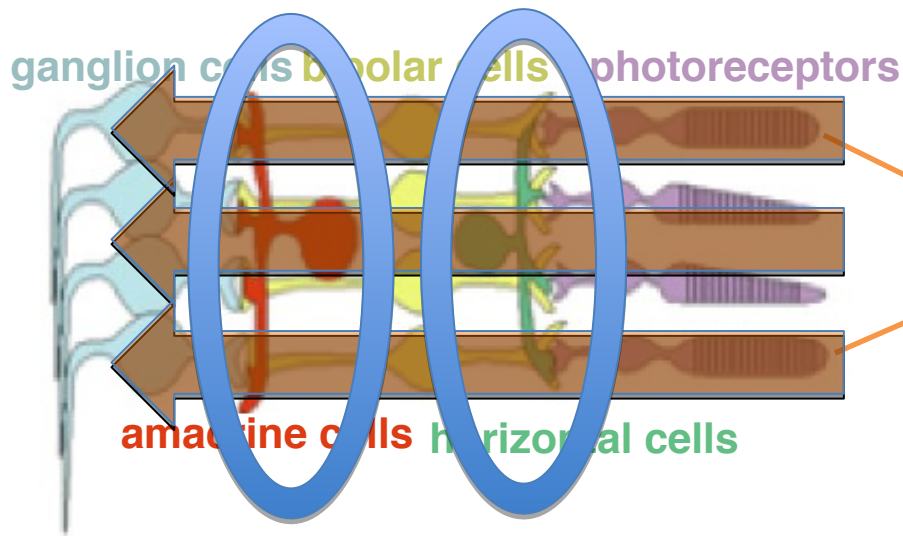

« Information » flux

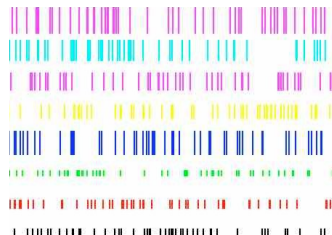

# The visual system

Encoder

Decoder

Retina's layered structure

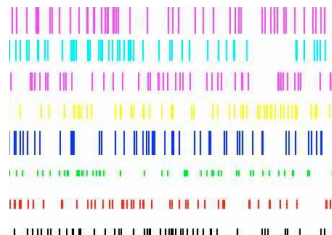
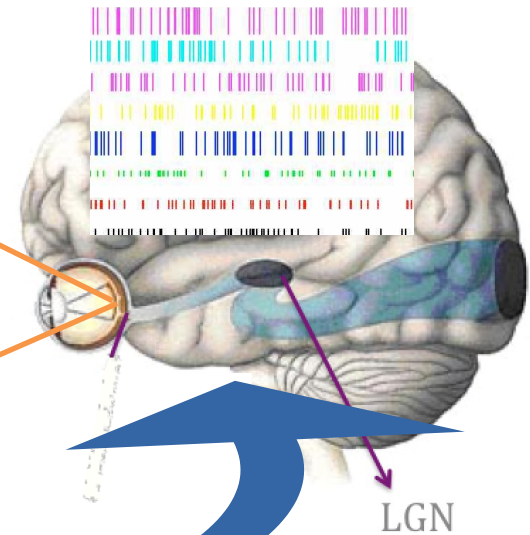
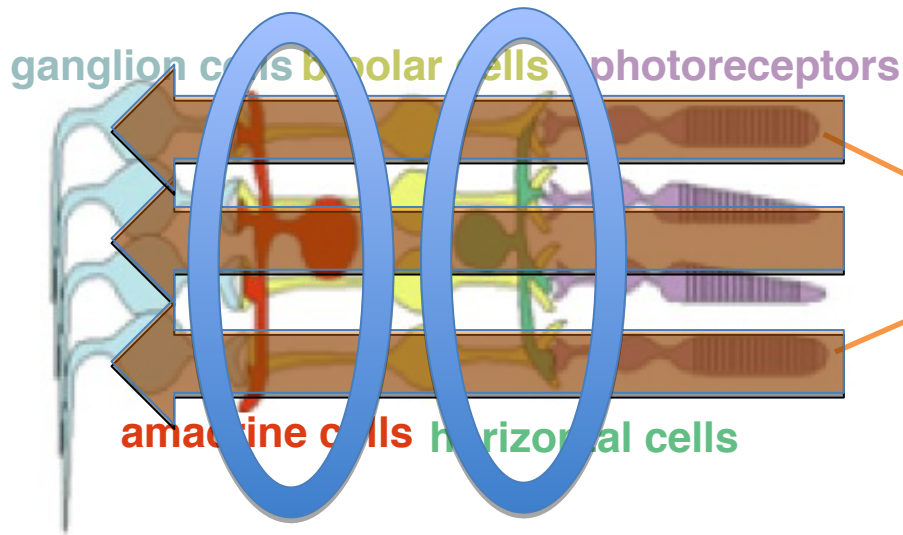

« Information » flux

# The visual system

Encoder

Decoder

Retina's layered structure

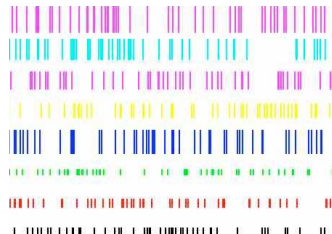
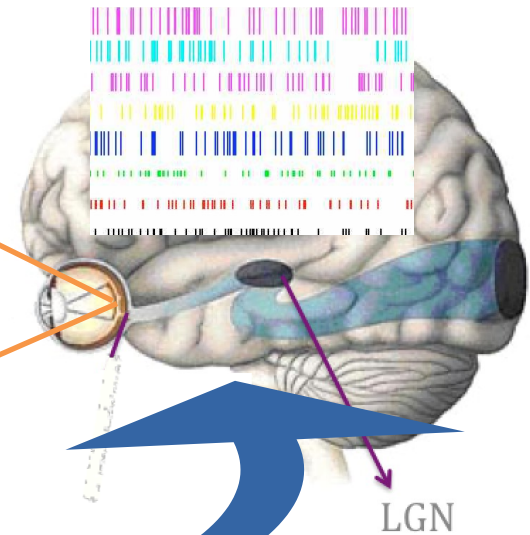
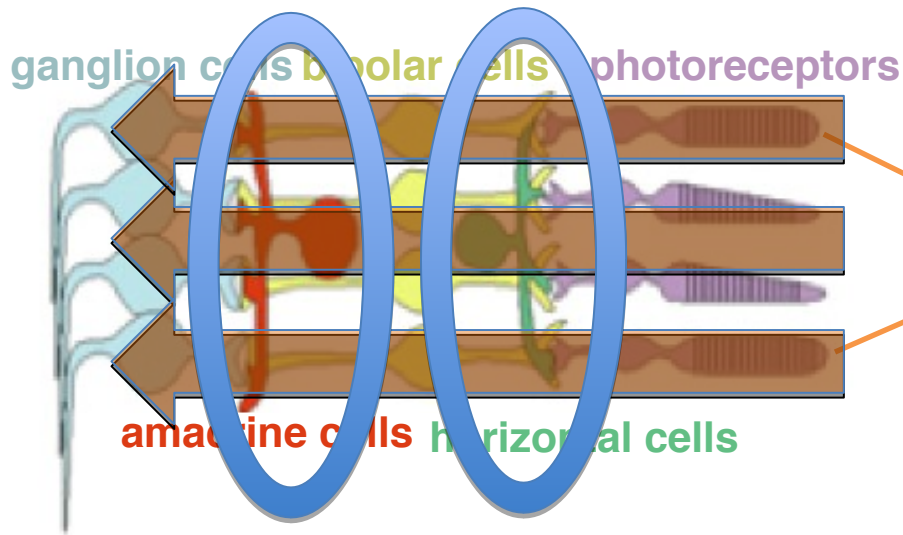

« Information » flux

# The visual system

Encoder

Decoder

Retina's layered structure

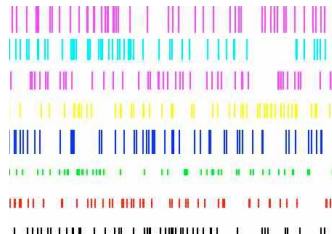
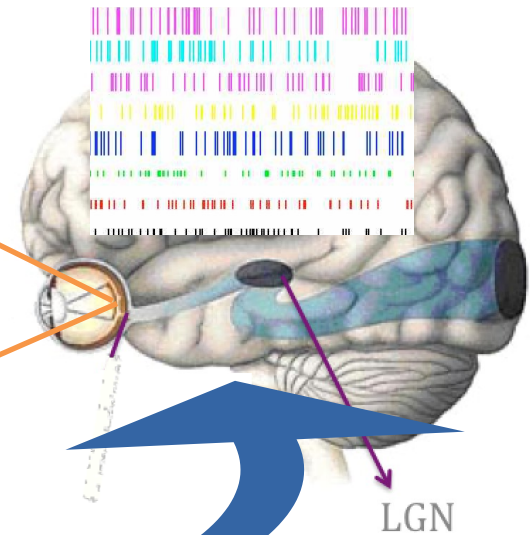
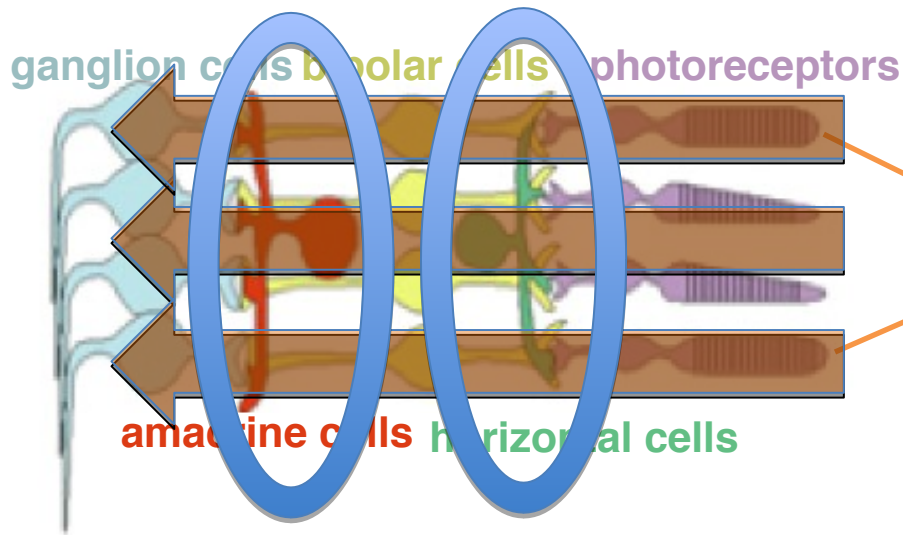

« Information » flux

# The visual system

Encoder

Decoder

Retina's layered structure

.... handles motion and spatio-temporal structures.

Static images do not exist.

How does the retina encode this huge information to be efficiently and rapidly decoded by the brain ?

« Information » flux

# Brief summary

- The retina is organized into a feedforward and lateral structure made of specific cell types and specific synapses.

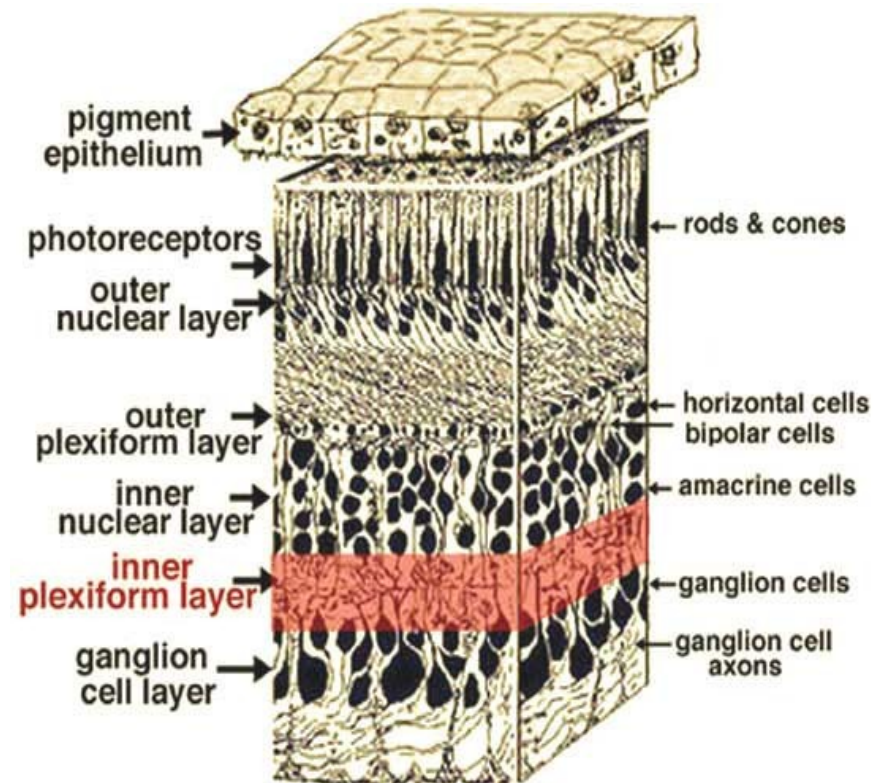
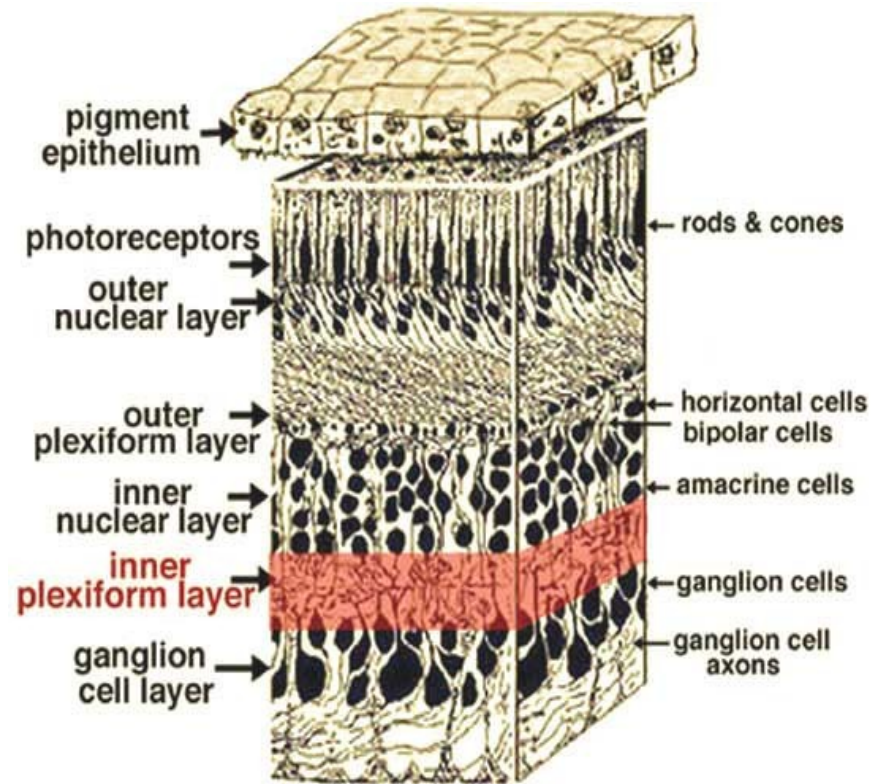

*Fig. 7. 3-D block of retina with the inner plexiform layer highlighted (red).*

From <http://webvision.org.es>

# Brief summary

- The retina is organized into a feedforward and lateral structure made of specific cell types and specific synapses.
- Local circuits, involving a few cells and synapses, process the local visual information.



*Fig. 7. 3-D block of retina with the inner plexiform layer highlighted (red).*

# Brief summary

- The retina is organized into a feedforward and lateral structure made of specific cell types and specific synapses.
- Local circuits, involving a few cells and synapses, process the local visual information.
- These circuits tile the whole retina, spanning the whole visual field.

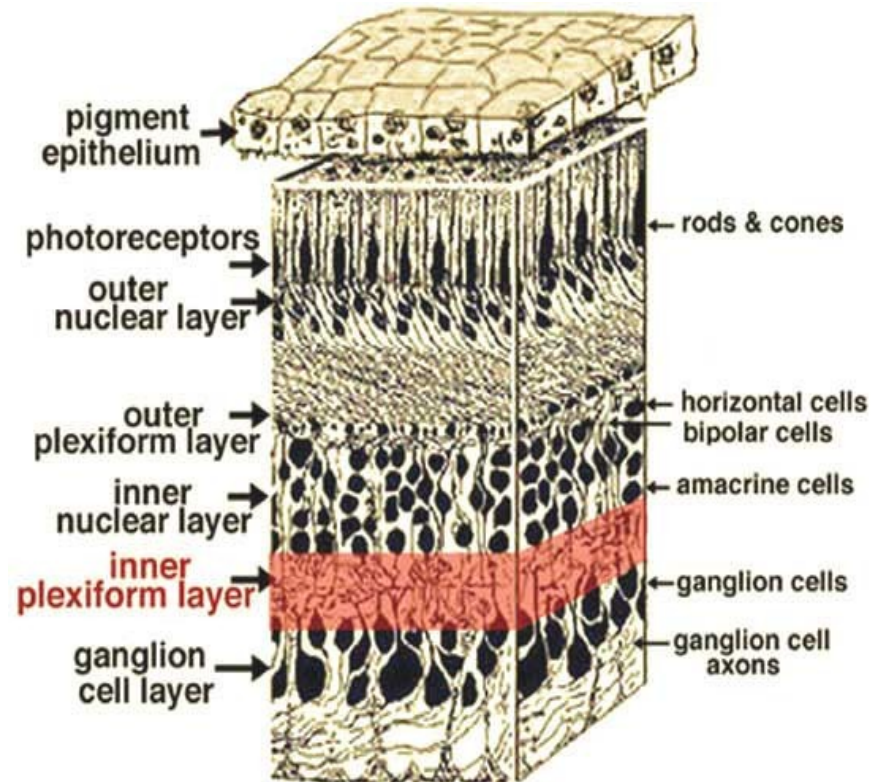

*Fig. 7. 3-D block of retina with the inner plexiform layer highlighted (red).*



# Brief summary

- The retina is organized into a feedforward and lateral structure made of specific cell types and specific synapses.
- Local circuits, involving a few cells and synapses, process the local visual information.
- These circuits tile the whole retina, spanning the whole visual field.
- The output of each circuit is a spike train, encoding the visual information from Gcells to thalamus and visual cortex.

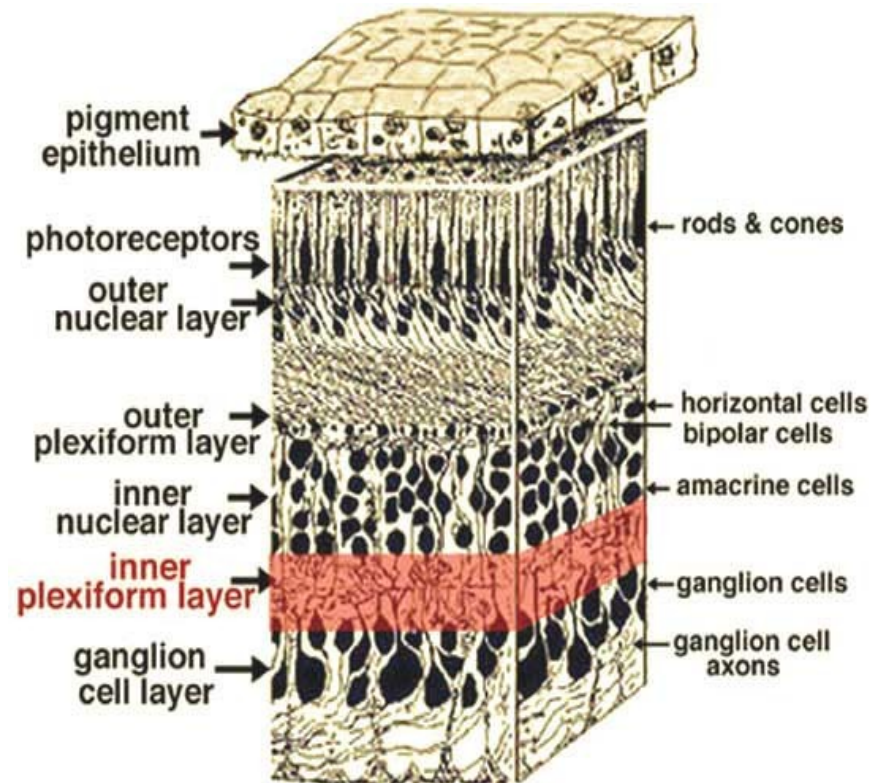

Fig. 7. 3-D block of retina with the inner plexiform layer highlighted (red).

# Brief summary

- The retina is organized into a feedforward and lateral structure made of specific cell types and specific synapses.
- Local circuits, involving a few cells and synapses, process the local visual information.
- These circuits tile the whole retina, spanning the whole visual field.
- The output of each circuit is a spike train, encoding the visual information from Gcells to thalamus and visual cortex.
- These circuits are entangled (sharing cells).

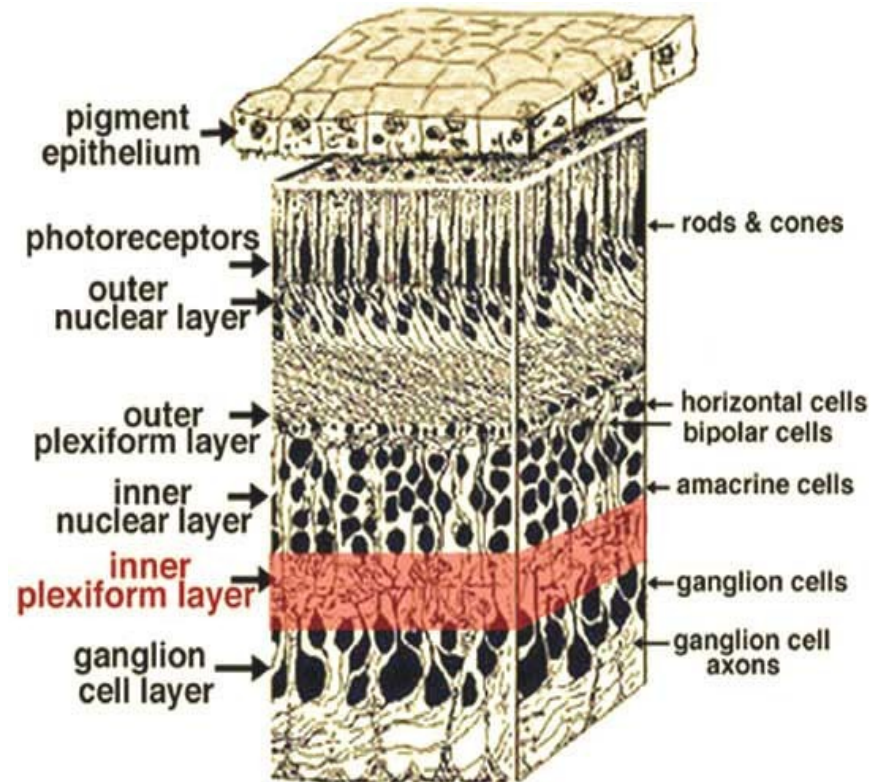

Fig. 7. 3-D block of retina with the inner plexiform layer highlighted (red).

From <http://webvision.org.es>

# A modeller point of view

1. The retina is a ***high dimensional, non autonomous and noisy*** dynamical system, layered and structured, with ***non stationary and spatially inhomogeneous entries*** (visual scenes).
-

# A modeller point of view

1. The retina is a ***high dimensional, non autonomous and noisy*** dynamical system, layered and structured, with ***non stationary and spatially inhomogeneous entries*** (visual scenes).
2. ***Local circuits*** of non linear cells, connected with non linear synapses efficiently process the ***local visual information***. These local circuits are connected together, spanning the whole retina in a ***regular tiling***.

# A modeller point of view

1. The retina is a ***high dimensional, non autonomous and noisy*** dynamical system, layered and structured, with ***non stationary and spatially inhomogeneous entries*** (visual scenes).
  2. ***Local circuits*** of non linear cells, connected with non linear synapses efficiently process the ***local visual information***. These local circuits are connected together, spanning the whole retina in a ***regular tiling***.
  3. The conjunction of non linearities and regular structure can produce highly complex ***spatio-temporal*** dynamics.
-

# A modeller point of view

1. The retina is a ***high dimensional, non autonomous and noisy*** dynamical system, layered and structured, with ***non stationary and spatially inhomogeneous entries*** (visual scenes).
2. ***Local circuits*** of non linear cells, connected with non linear synapses efficiently process the ***local visual information***. These local circuits are connected together, spanning the whole retina in a ***regular tiling***.
3. The conjunction of non linearities and regular structure can produce highly complex ***spatio-temporal*** dynamics.
4. The retina is sensitive to ***changes in its physiology*** (development, pharmacology, pathologies). These changes can be addressed from the point of view of ***bifurcations theory***.

# The Biovision lab

## **Understanding the normal visual system at neuronal and perceptual levels**

- *Better understanding the early visual system*
- *Reading, moving, behaving in 3D virtual environments*
- *Analysis of visual media and user perception*

## **Understanding the impact of low vision at neuronal and perceptual levels**

- *Modeling of retinal prostheses stimulation and cortical responses*
- *Understanding eccentric vision pointing for selection and identification*
- *Understanding low vision impact on attentional and oculo-motor behaviors when reading*
- *Attentional and behavioural studies using virtual reality*

## **Diagnosis, rehabilitation, and low vision aids**

- *Exploring new solutions for diagnosis*
- *Designing rehabilitation methods in virtual reality (VR)*
- *Developing innovative vision-aid digital systems*

# Retinal waves

Random dynamical structures in the  
developing visual system

**D. Karvouniari (PhD 2014-2018)**, Biovision team, INRIA, Sophia Antipolis

L. Gil, InPhyNi, Nice-Sophia-Antipolis

O. Marre, Institut de la Vision, Paris

S. Picaud, Institut de la Vision, Paris

B. Cessac, Biovision team, INRIA, Sophia Antipolis

Acknowledgement: M. Hennig (U. Edinburgh), E. Sernagor (U. Newcastle).



# The structure of the adult retina

## Retina's layered structure

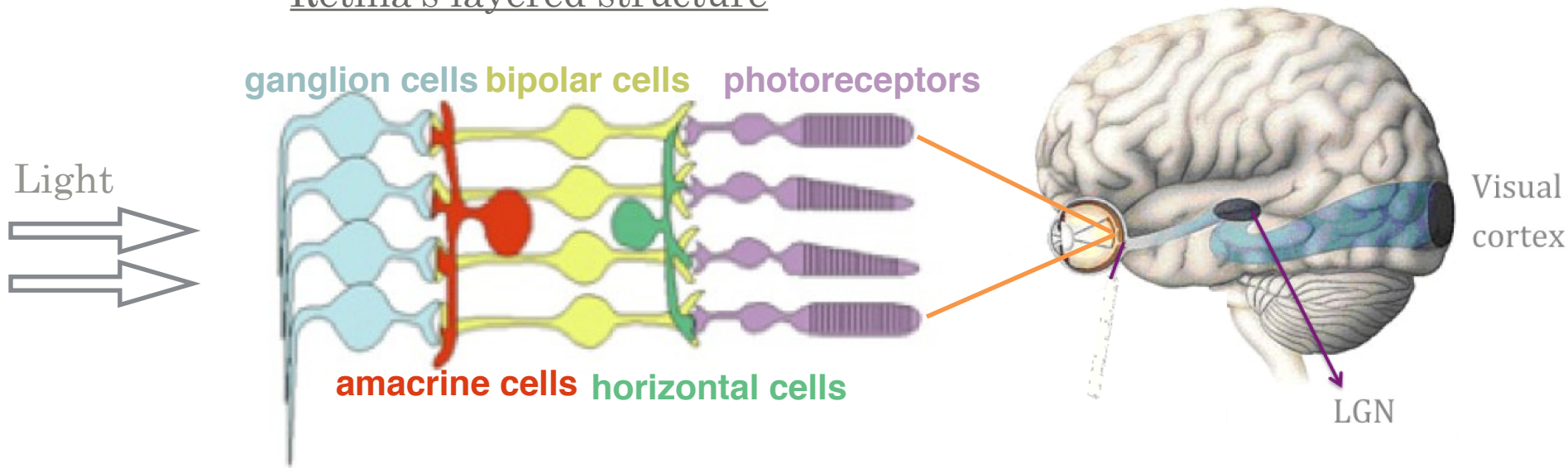

# The structure of the retina during development

Retina's layered structure  
is shaped during development

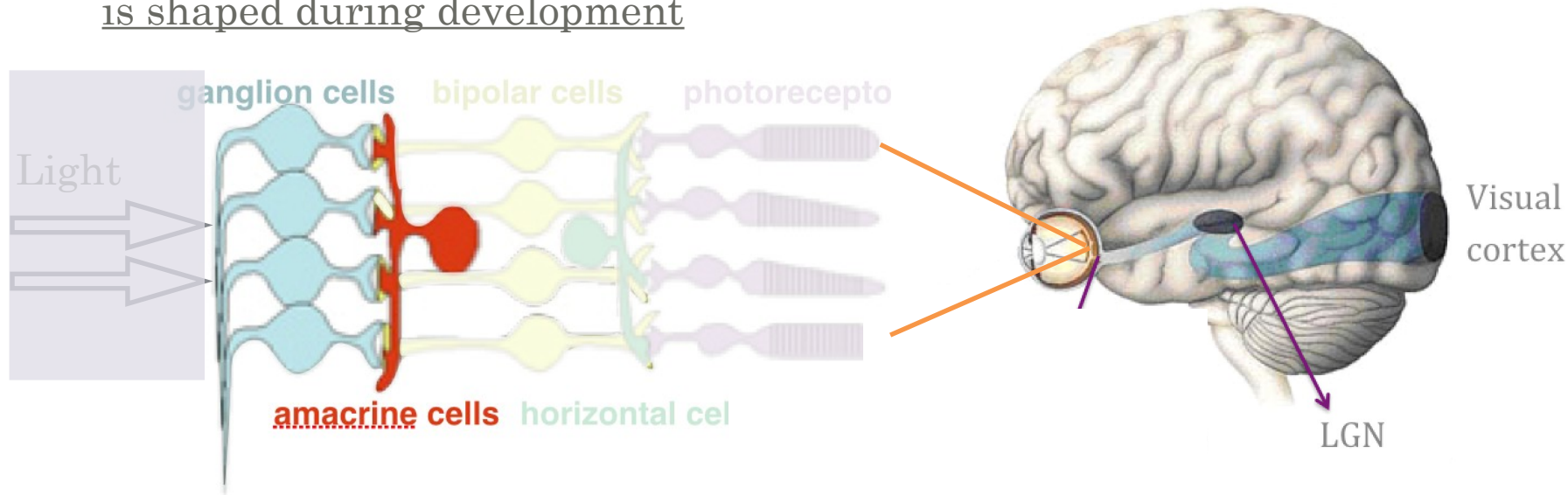

But How?



Retinal waves!

# Retinal waves

Spontaneous spatio-temporal waves during development  
Disappear short after birth when vision is functional

Recordings from the retina

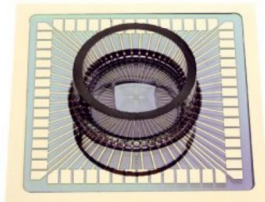
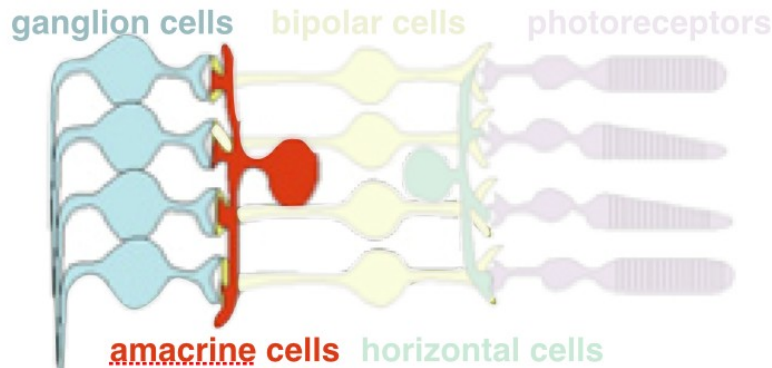

**Multi-electrode array (MEA)**

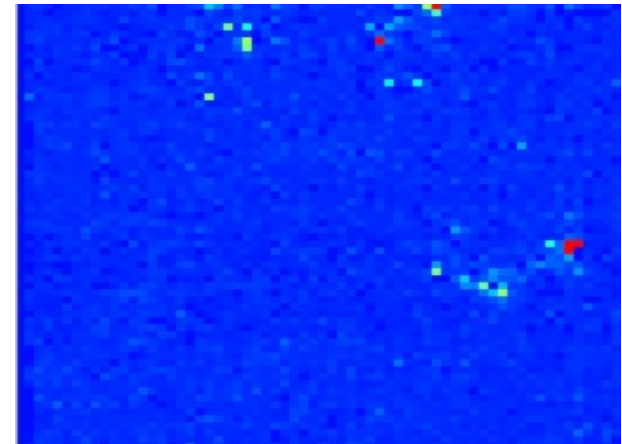

*MEA recording of the voltage from a mouse retina (courtesy E Sernagor).*

# Variability within retinal waves

## i) Across species

Godfrey et al. 2007

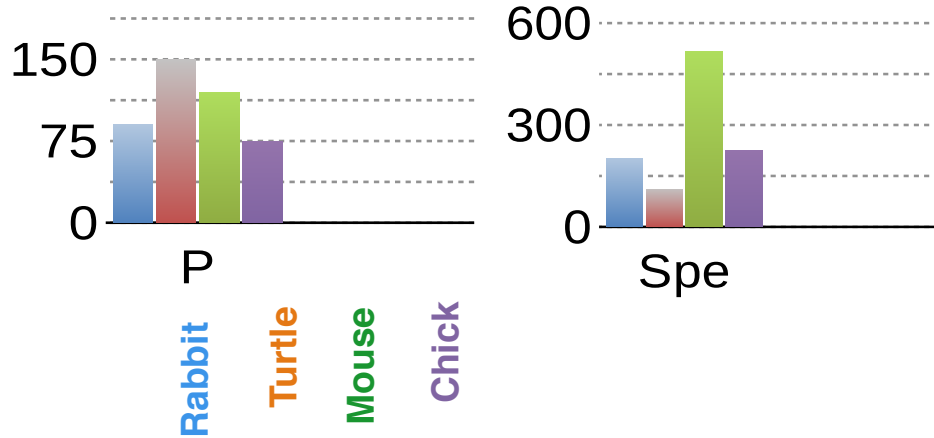

# Variability within retinal waves

## i) Across species

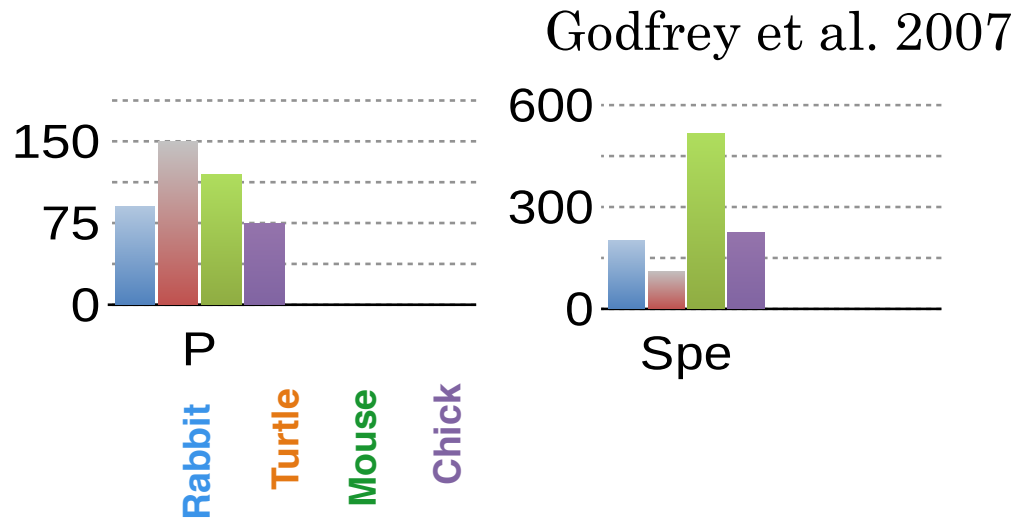

## ii) Development

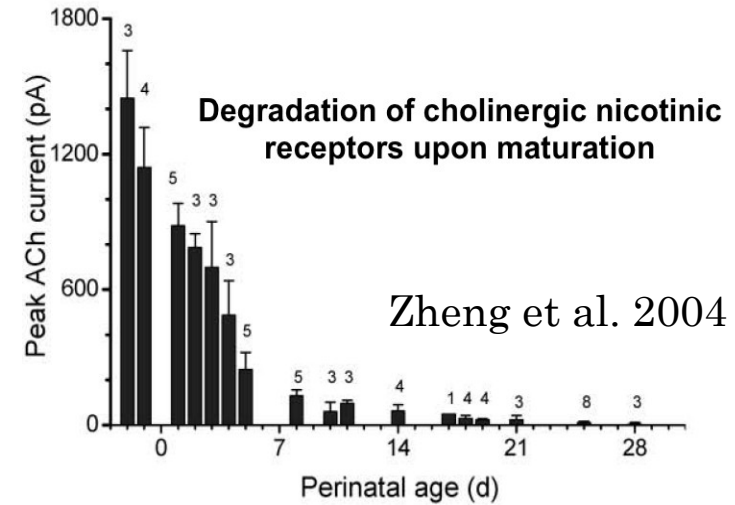

# Variability within retinal waves

## i) Across species

Godfrey et al. 2007

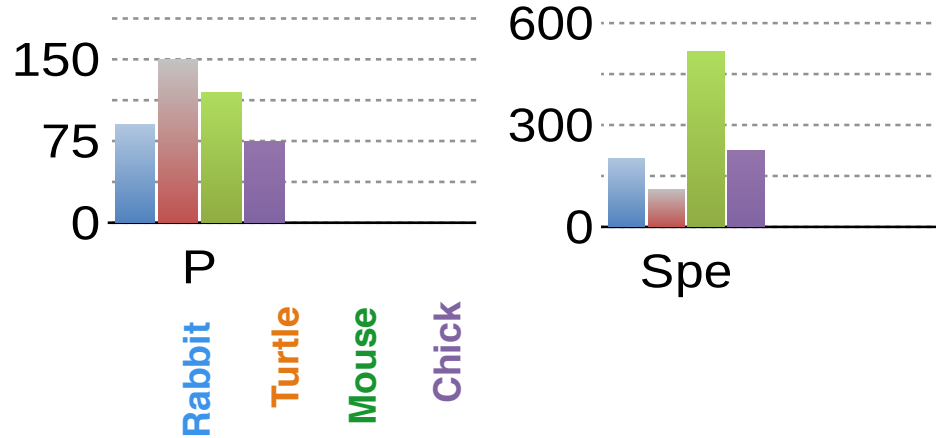

## ii) Development

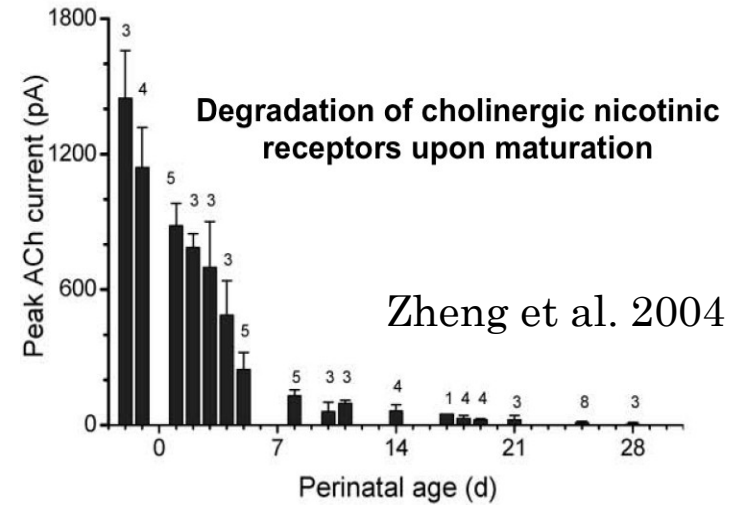

## iii) Pharmacology

P4

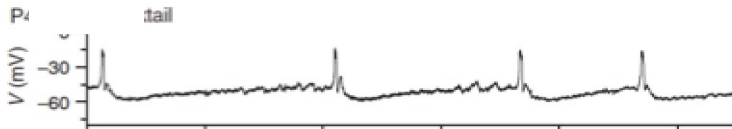

P8

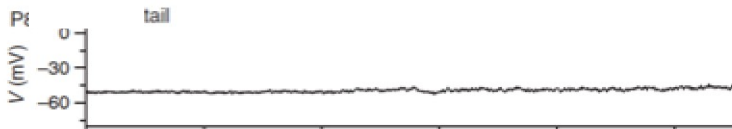

0 Time (sec) 50

# Variability within retinal waves

## i) Across species

Godfrey et al. 2007

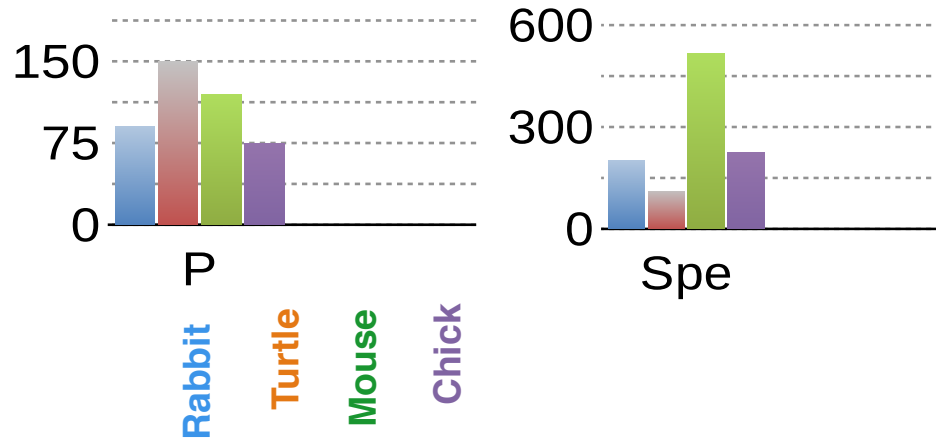

## ii) Development

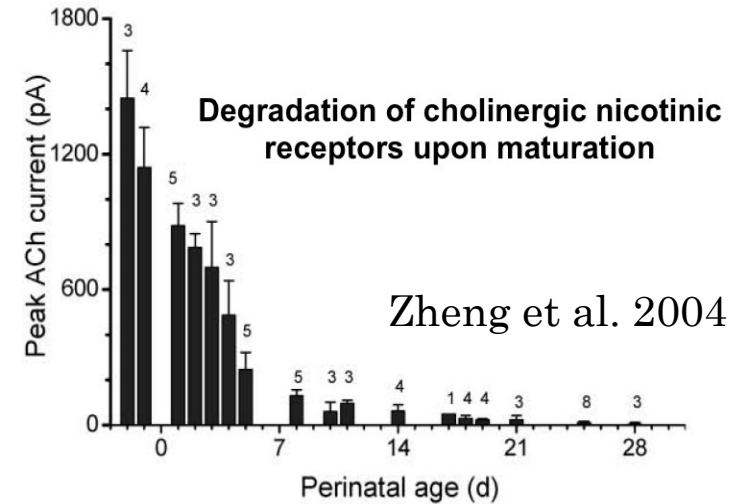

## iii) Pharmacology

P4

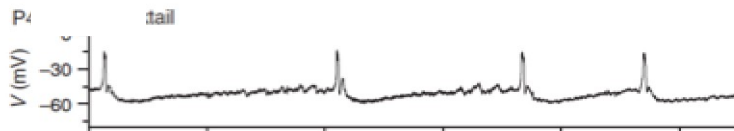

P8



0 Time (sec) 50

## iv) Spatial Variability

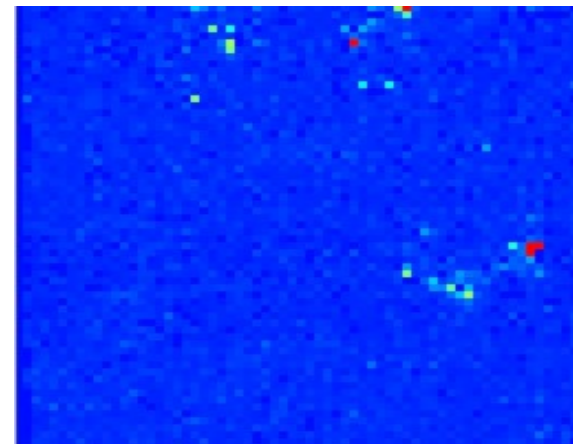

# Variability within retinal waves

## i) Across species

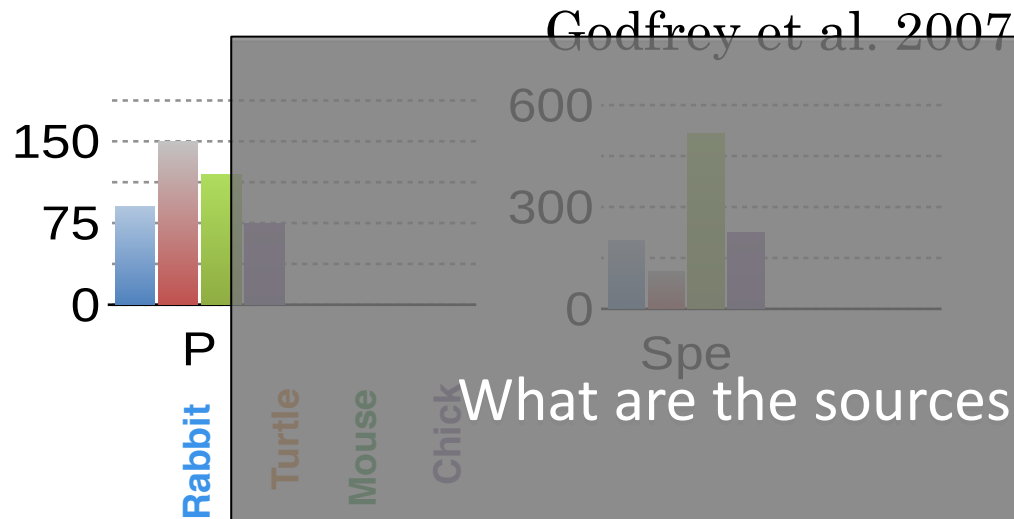

## ii) Development

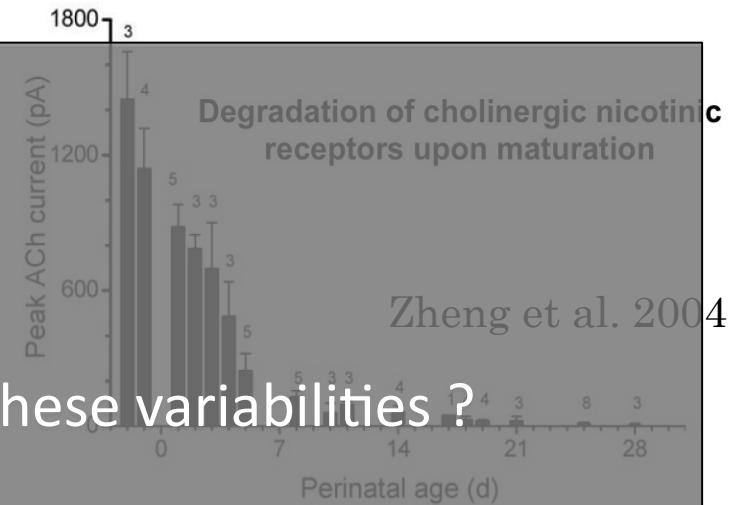

What are the sources of these variabilities?

## iii) Pharmacology

P4



P8



0 Time (sec) 50

## iv) Spatial Variability

Is there a unique, global, mechanism explaining them?



# A network model for stage II retinal waves

*A biophysical model explains the spontaneous bursting behavior in the developing retina*

*Dora Matzakos-Karvouniari, Lionel Gil, Elaine Orendorff, Olivier Marre, Serge Picaud, Bruno Cessac*

*Scientific Reports, Nature Publishing Group, 2019, 9 (1), pp.1-23. [10.1038/s41598-018-38299-4](https://doi.org/10.1038/s41598-018-38299-4)*

$$\left\{ \begin{array}{l} C_m \frac{dV_i}{dt} = -g_L(V_i - V_L) - g_C M_\infty(V_i)(V_i - V_C) - g_K N_i(V_i - V_K) \\ \quad - G_{sAHP}(R_i)(V_i - V_K) - G_A(\{A_k\}_{k \in \mathcal{B}_i})(V_i - V_A) \\ \\ \tau_N \frac{dN_i}{dt} = \Lambda(V_i)(N_\infty(V_i) - N_i) \\ \\ \tau_C \frac{dC_i}{dt} = -\frac{\alpha_C}{H_X} C_i + C_0 - \delta_C g_C M_\infty(V_i)(V_i - V_C) \\ \\ \tau_S \frac{dS_i}{dt} = \alpha_S(1 - S_i)C_i^4 - S_i \\ \\ \tau_R \frac{dR_i}{dt} = \alpha_R S_i(1 - R_i) - R_i \\ \\ \frac{dA_i}{dt} = -\mu A_i + \beta_A T_A(V_i), \end{array} \right.$$

# A network model for stage II retinal waves

N neurons, 6 N equations

$$\left\{ \begin{array}{l}
 C_m \frac{dV_i}{dt} = -g_L(V_i - V_L) - g_C M_\infty(V_i)(V_i - V_C) - g_K N_i(V_i - V_K) \\
 \quad - G_{sAHIP}(R_i)(V_i - V_K) - G_A(\{A_k\}_{k \neq i})(V_i - V_A) \\
 \tau_N \frac{dN_i}{dt} = \Lambda(V_i)(N_\infty(V_i) - N_i) \\
 \tau_C \frac{dC_i}{dt} = -\frac{\alpha_C}{H_X} C_i + C_0 - \delta_C g_C M_\infty(V_i)(V_i - V_C) \\
 \tau_S \frac{dS_i}{dt} = \alpha_S(1 - S_i)C_i^4 - S_i \\
 \tau_R \frac{dR_i}{dt} = \alpha_R S_i(1 - R_i) - R_i \\
 \frac{dA_i}{dt} = -\mu A_i + \beta_A T_A(V_i),
 \end{array} \right.$$

~ 20 parameters per neuron

(But neurons are assumed identical)

# A network model for stage II retinal waves

N neurons, 6 N equations

$$\left\{ \begin{array}{l} C_m \frac{dV_i}{dt} = -g_L(V_i - V_L) - g_C M_\infty(V_i)(V_i - V_C) - g_K N_i(V_i - V_K) \\ \quad - G_{s \sim HP}(R_i)(V_i - V_K) - G_A(\{A_k\}_{1 \sim n})(V_i - V_A) \\ \tau_N \frac{dN_i}{dt} = \Lambda(V_i)(N_\infty(V_i) - N_i) \\ \tau_C \frac{dC_i}{dt} = -\frac{\alpha_C}{H_X} C_i + C_0 - \delta_C g_C M_\infty(V_i)(V_i - V_C) \\ \tau_S \frac{dS_i}{dt} = \alpha_S(1 - S_i)C_i^4 - S_i \\ \tau_R \frac{dR_i}{dt} = \dots \\ \frac{dA_i}{dt} = \dots \end{array} \right.$$

~ 20 parameters per neuron

(But neurons are assumed identical)

Time scale separation

- Fast**  $V, N$ .  $\tau_L = 11$  ms,  $\tau_N = 5$  ms.
- Medium**  $C, A$ .  $\tau_C = 2$  s,  $\tau_A = 1.86$  s.
- Slow**  $S, R$ .  $\tau_R = \tau_S = 44$  s.

# Spontaneous Bursting Mechanism of SACs

■ Bursting  
■ sAHP

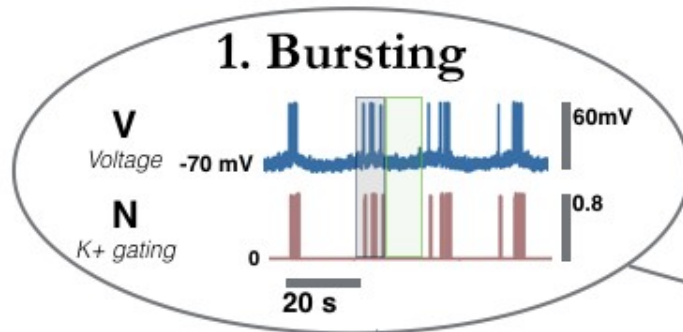

Increase of Calcium load during bursting

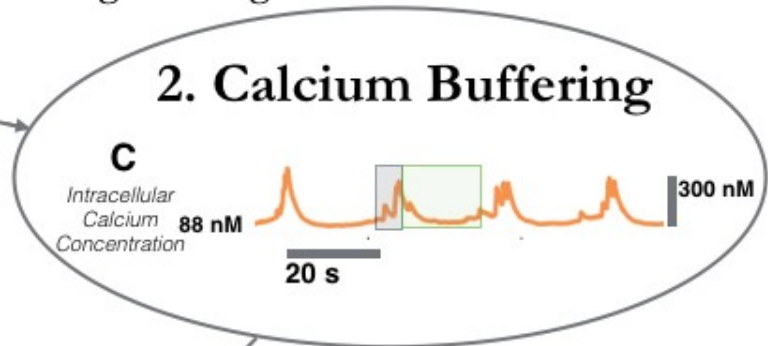

Bursting starts again when the Calcium load is low enough

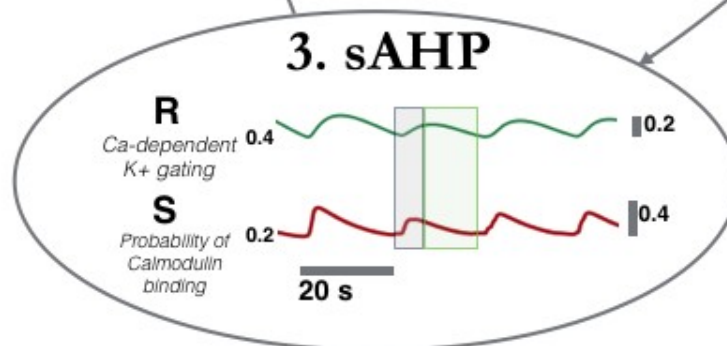

Calcium controls the sAHP phase. Voltage is low and Calcium starts offloading

# Spontaneous Bursting Mechanism of SACs

**Bursting**  
 **sAHP**

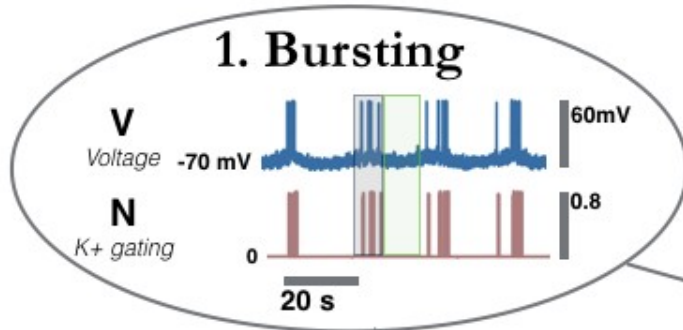

Increase of Calcium load during bursting

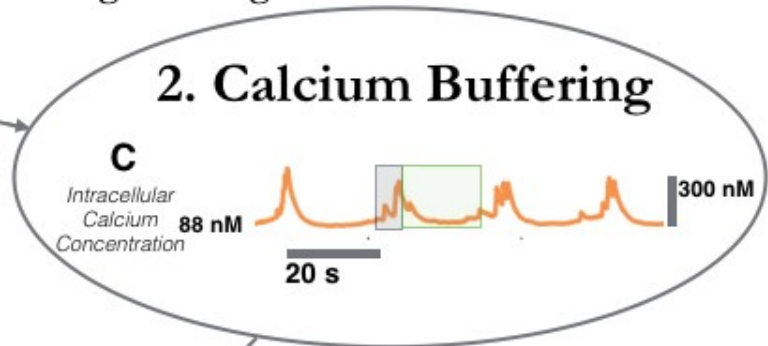

Bursting starts again when the Calcium load is low enough

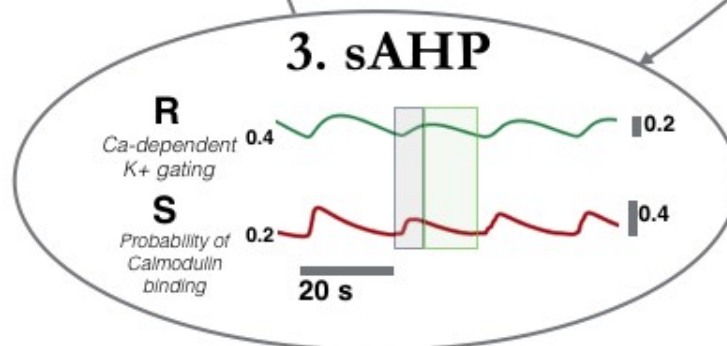

Calcium controls the sAHP phase. Voltage is low and Calcium starts offloading

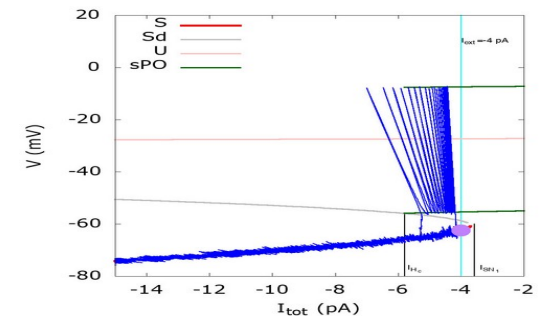

# Waves propagation

$$g_{\text{Ach}}^m = 0.03 \text{ nS}$$

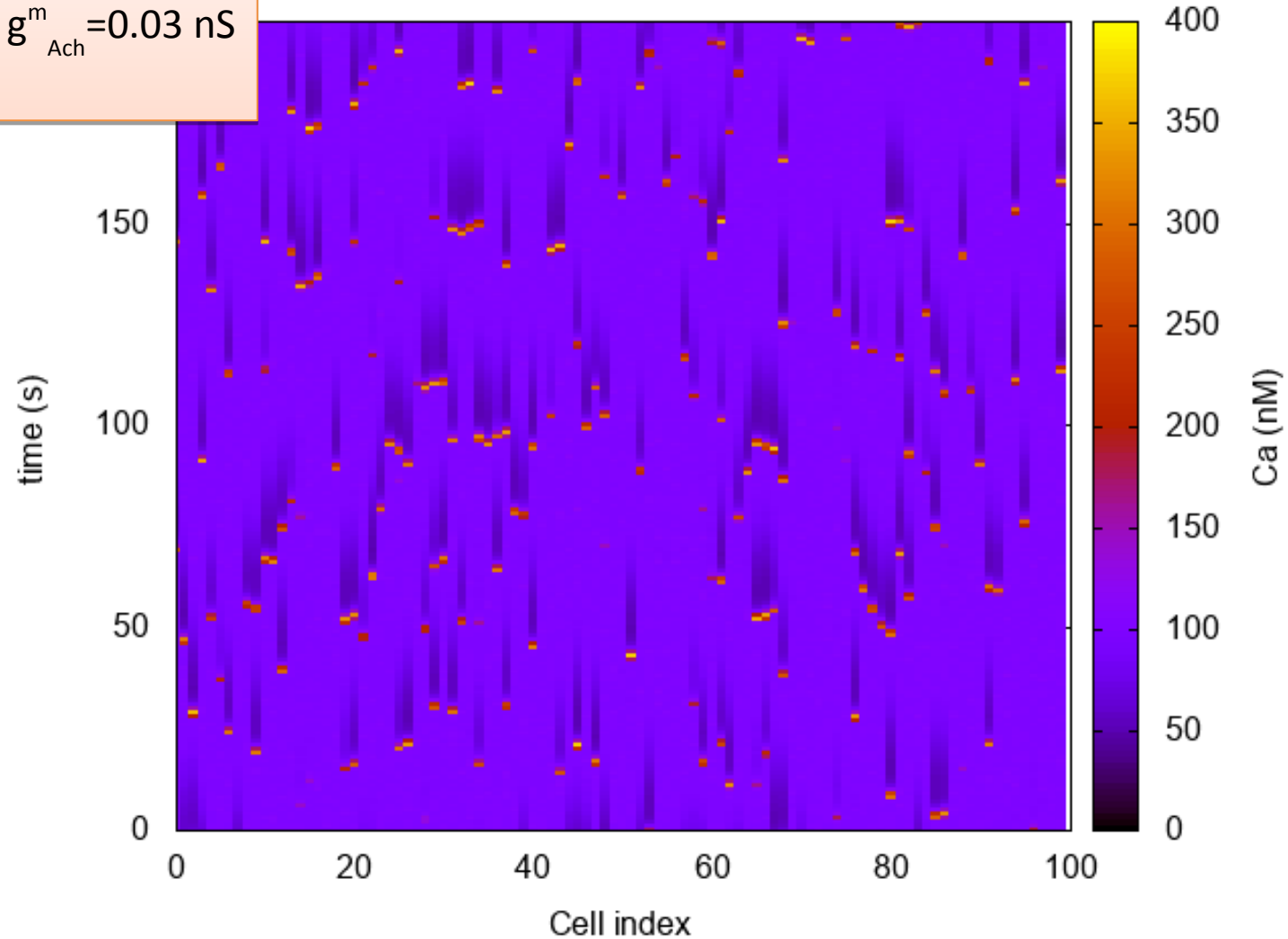

# Waves propagation

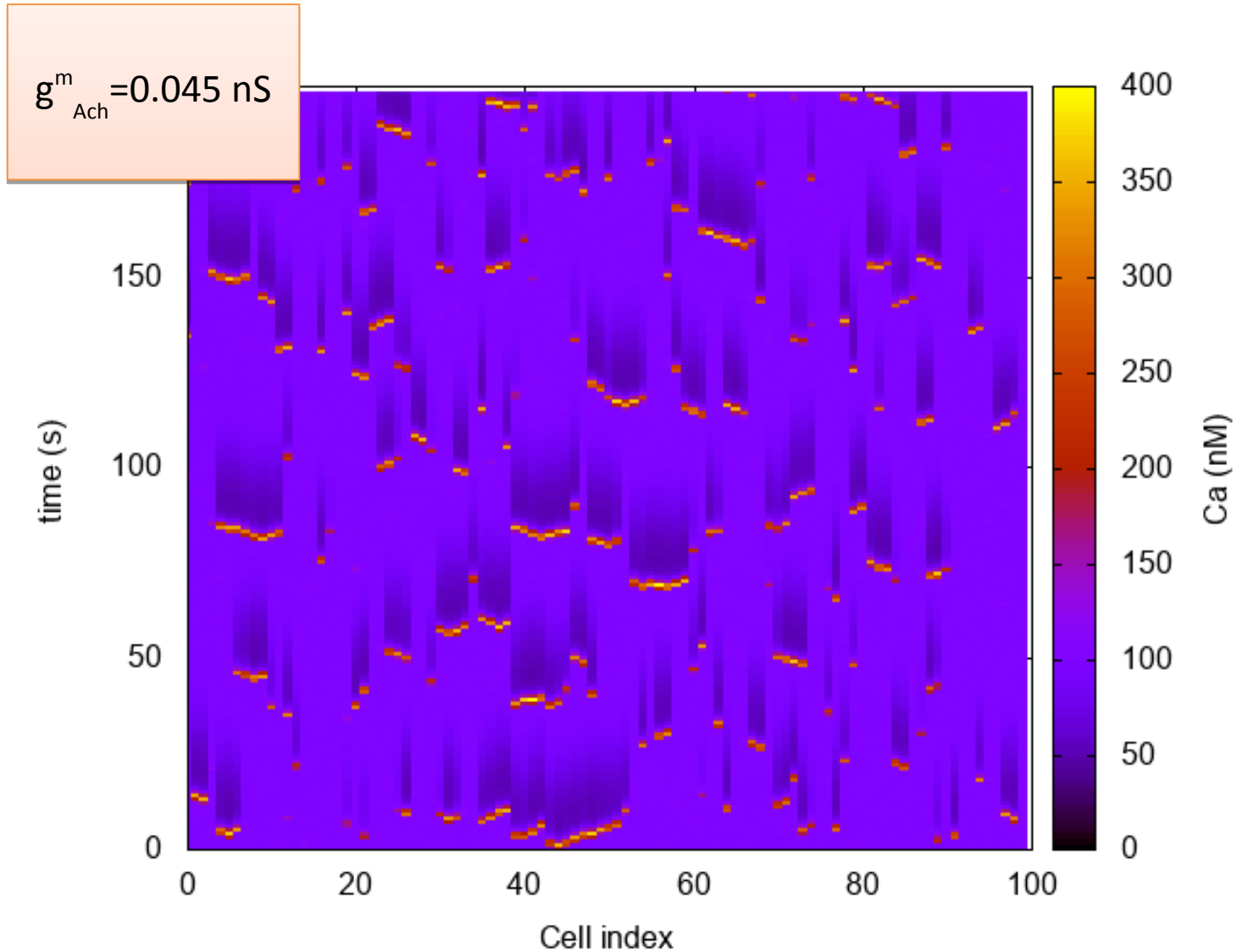

# Waves propagation

$$g_{\text{Ach}}^m = 0.07 \text{ nS}$$

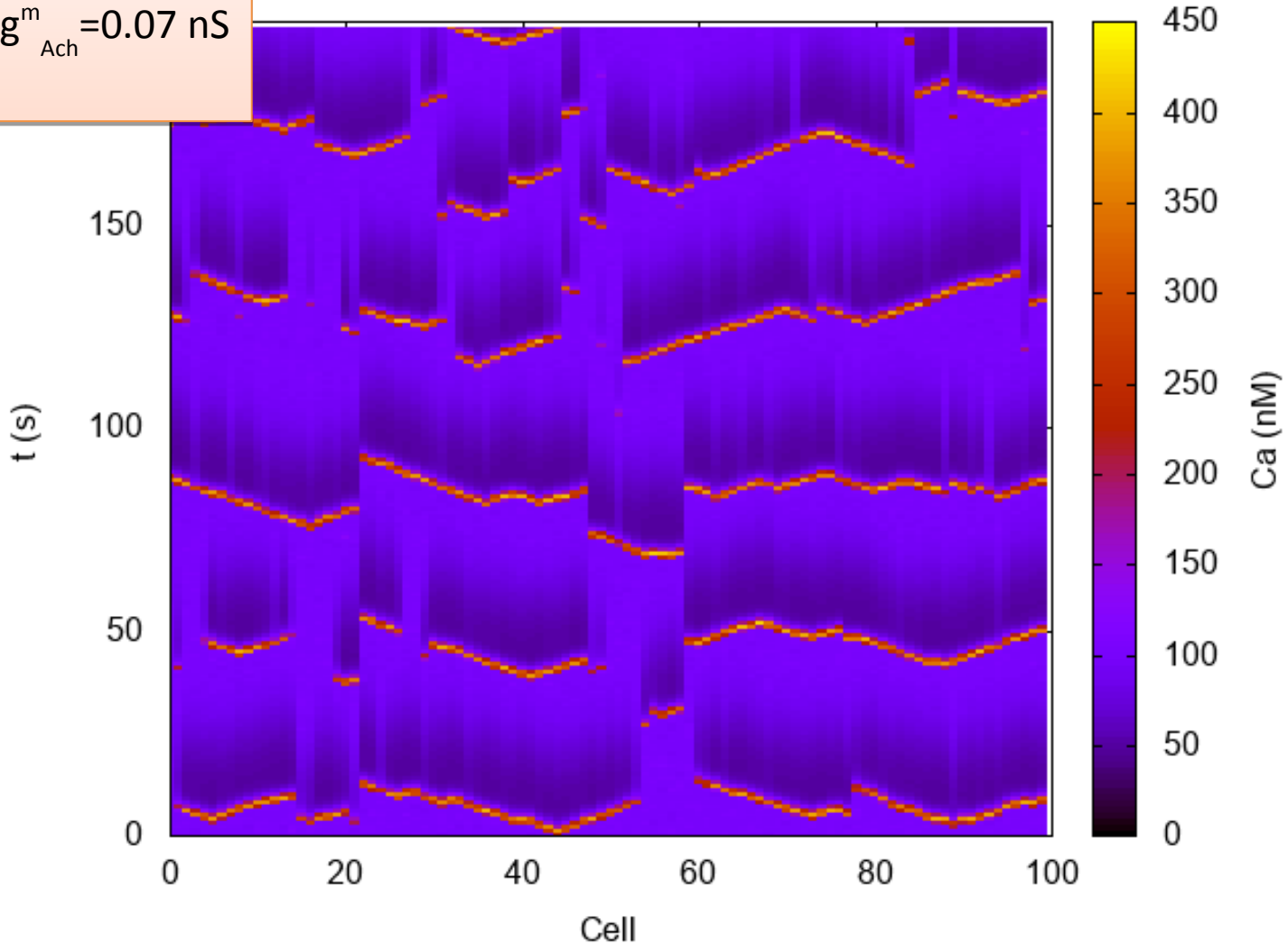



# Waves propagation

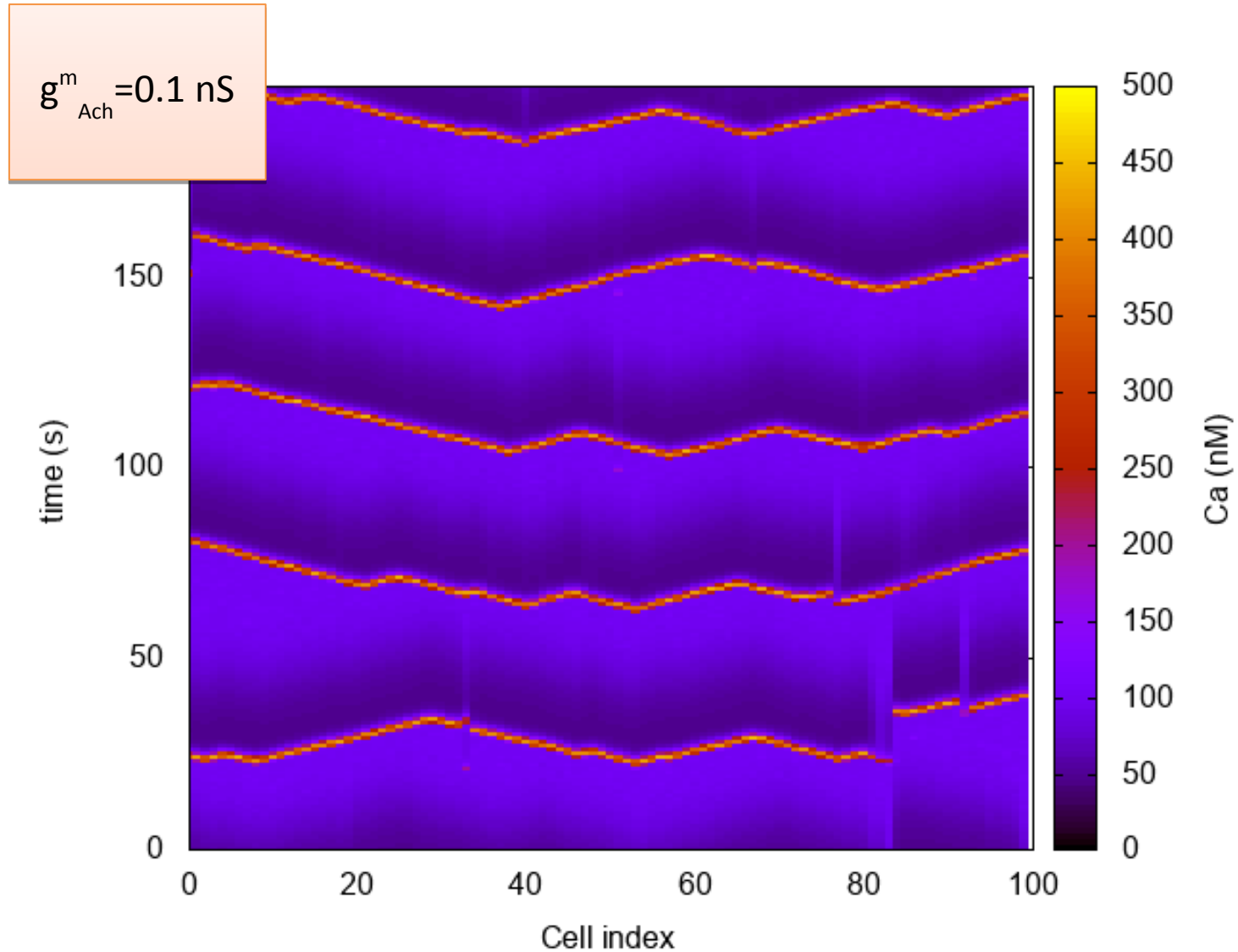

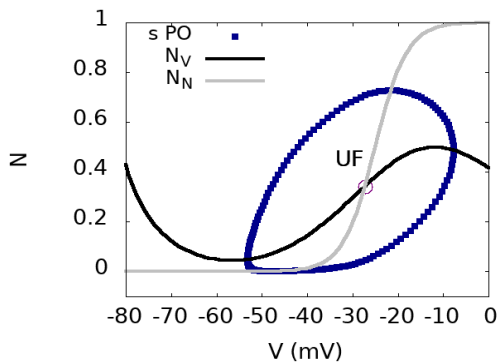

C

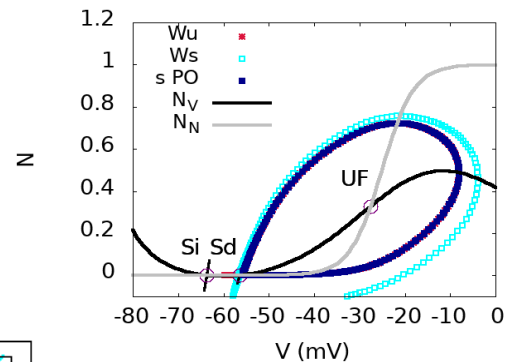

D

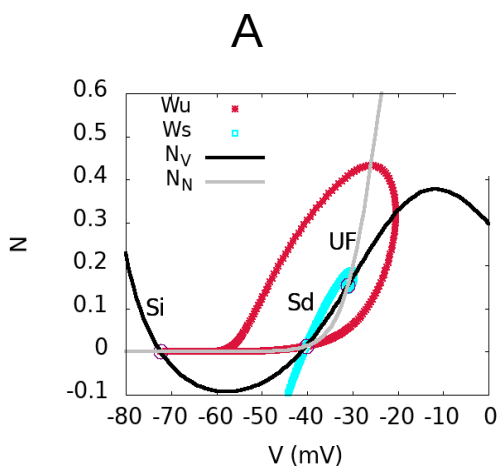

A

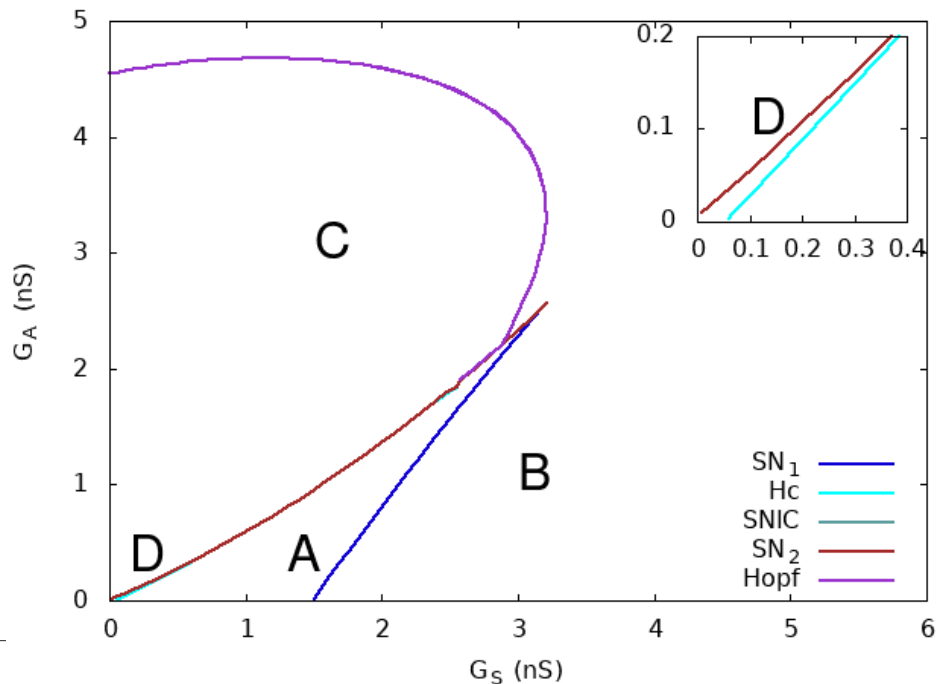

B

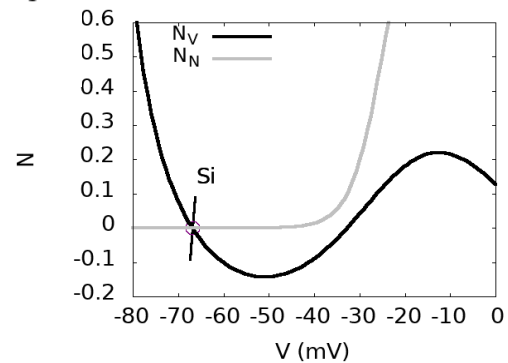

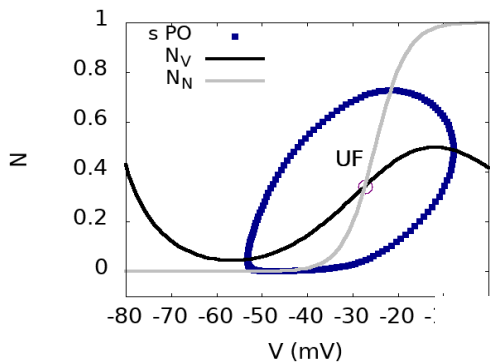

C

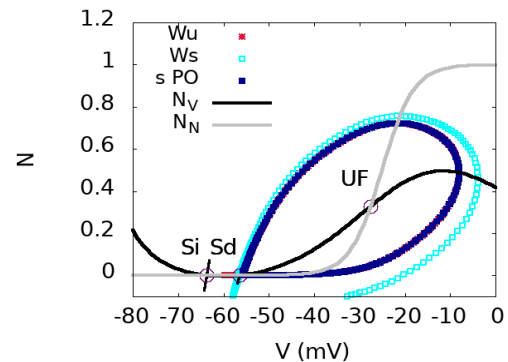

D

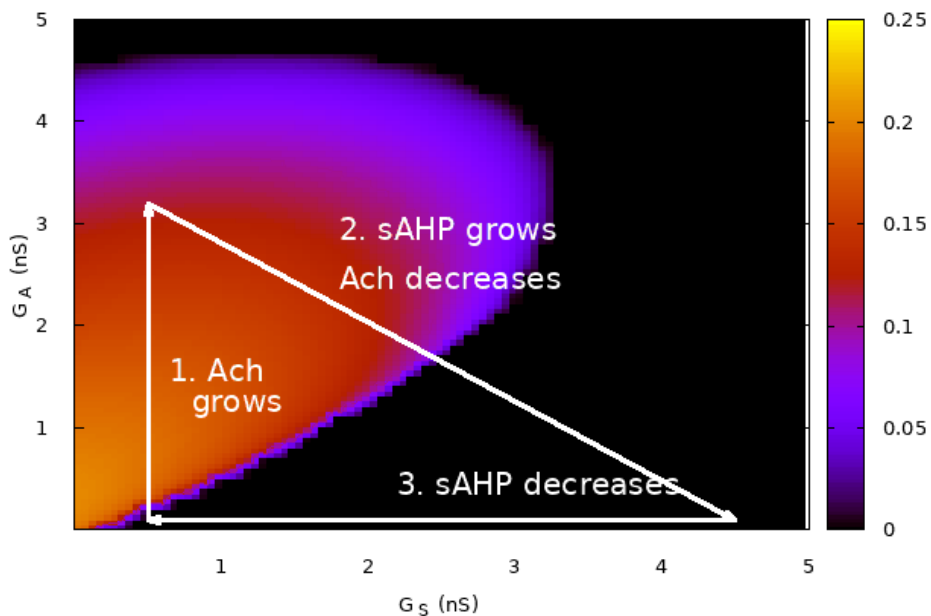

A

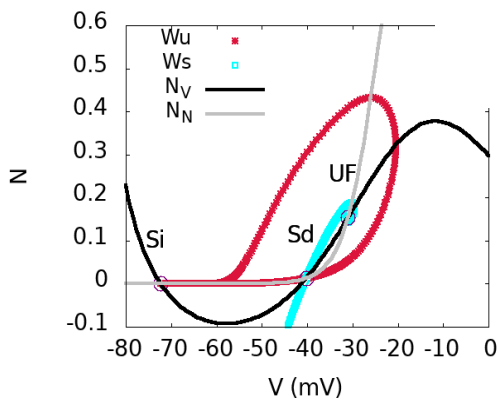

B

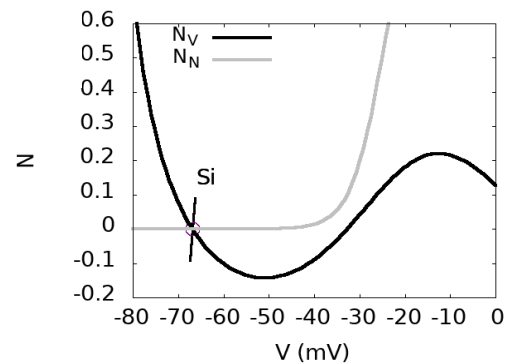

# Main mechanisms

- There is a **competition** between 2 mechanisms:
  - Refractoriness and desynchronisation (sAHP).
  - Mutual excitation and synchronisation (Acetylcholine).
- There is an intermediate regime of coupling, where **variability** is maximum.
- Therefore there is a wide repertoire of patterns
  - **Weak coupling** leads to small **localized activity**
  - **Moderate coupling** leads to **propagating patterns**
  - **Strong coupling** leads to **complete synchrony** of neurons

# Variability within retinal waves

## i) Across species

Godfrey et al. 2007

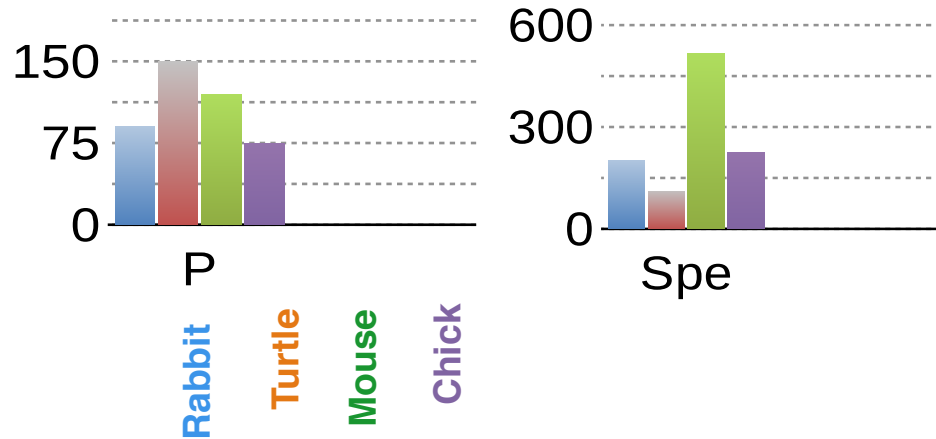

## ii) Development

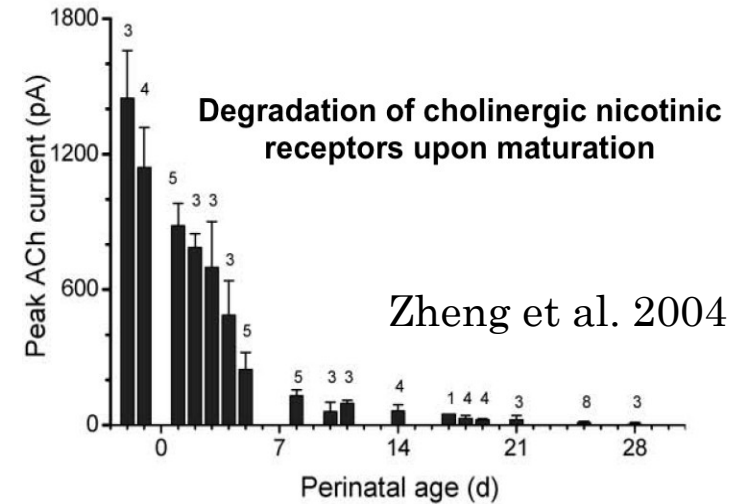

## iii) Pharmacology

P4

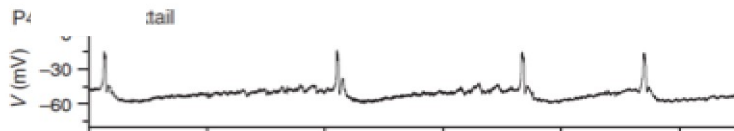

P8

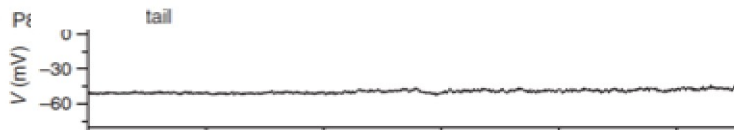

## iv) Spatial Variability

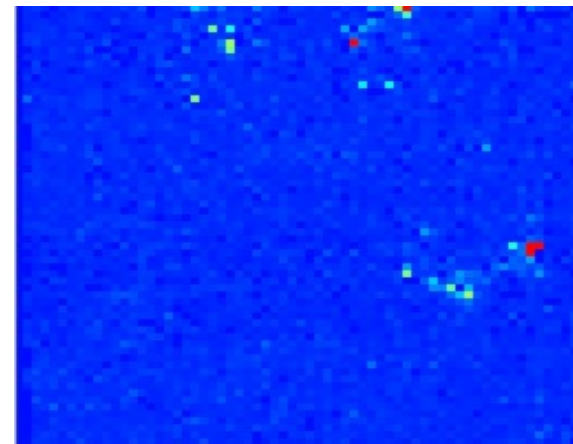

# Variability within retinal waves

## i) Across species

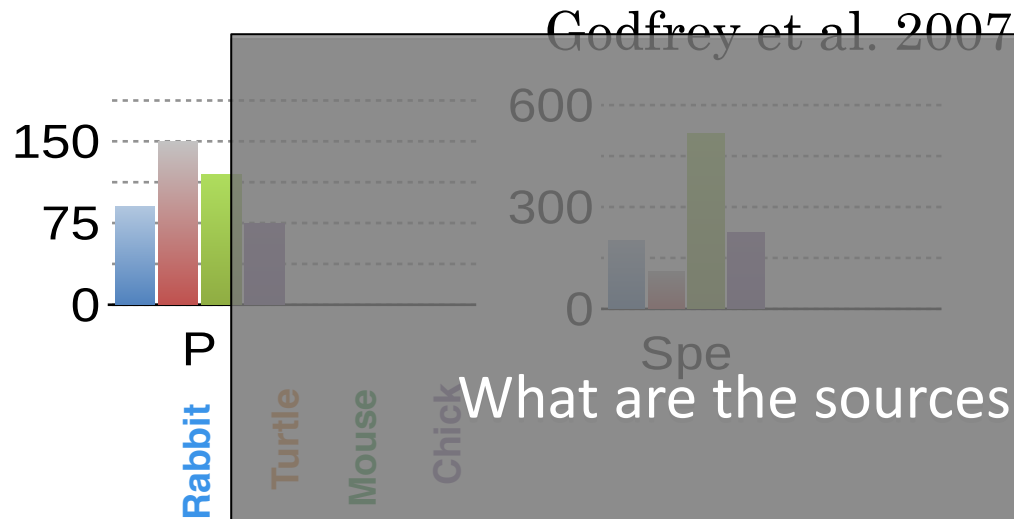

## ii) Development

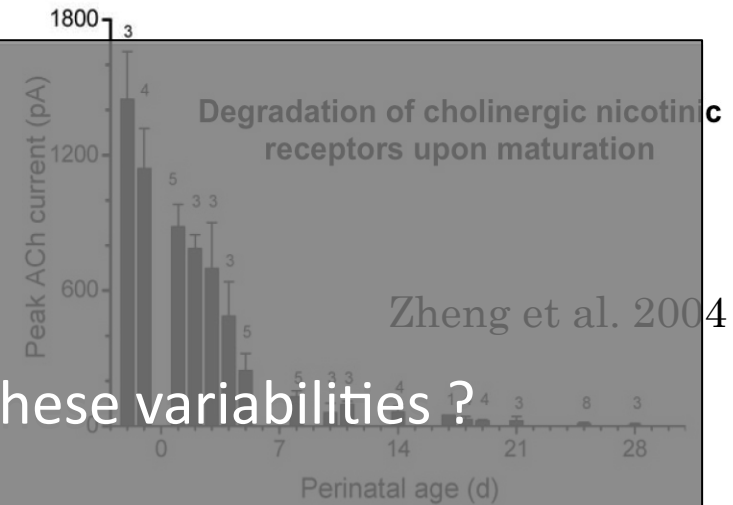

What are the sources of these variabilities?

## iii) Pharmacology

P4



P8



0 Time (sec) 50

## iv) Spatial Variability

Is there a unique, global, mechanism explaining them?

# Variability within retinal waves

## i) Across species

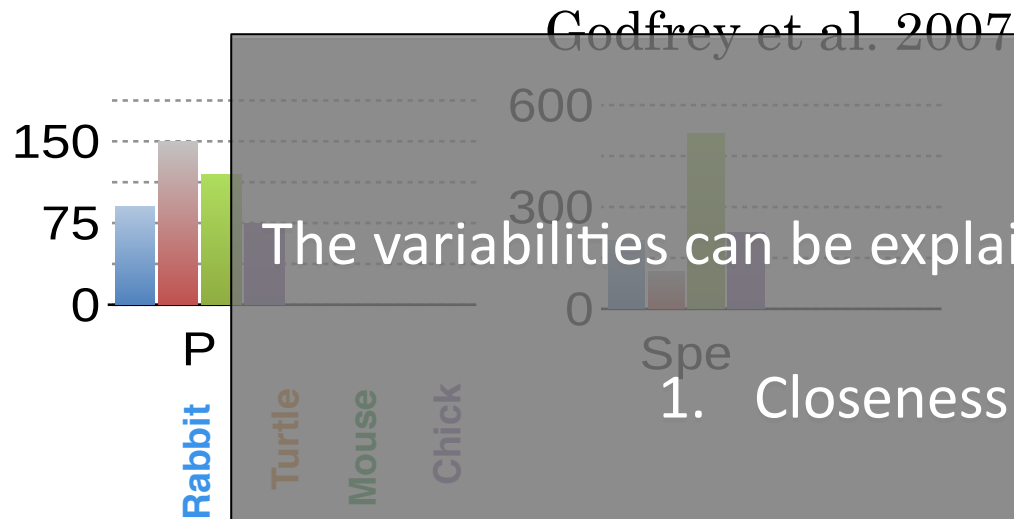

## ii) Development

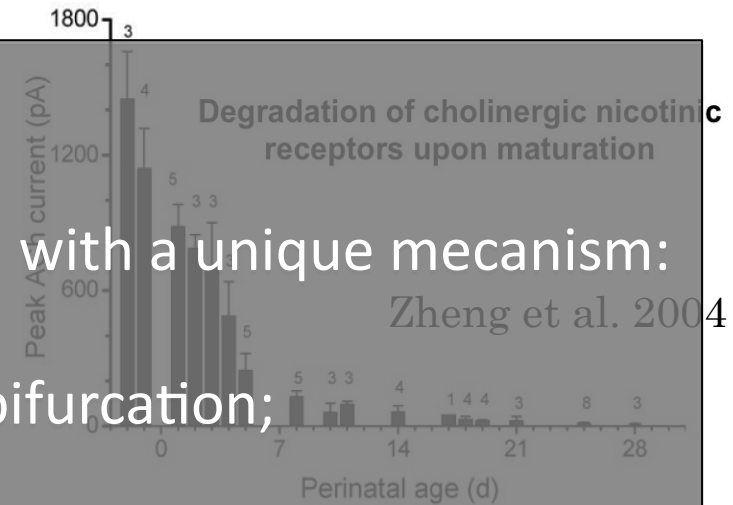

The variabilities can be explained with a unique mechanism:

1. Closeness to bifurcation;

2. Dynamic coupling via Ach.

## iii) Pharmacology

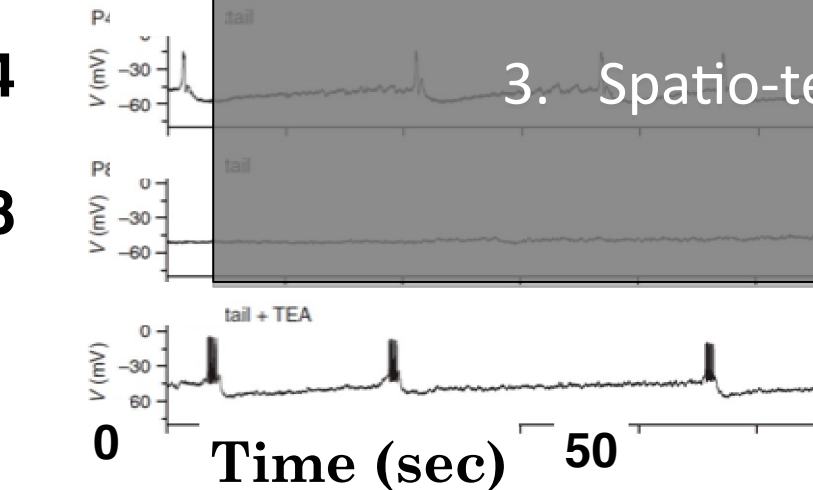

3. Spatio-temporal variability of sAHP.

## iv) Spatial Variability





# Retinal anticipation

## Random connectivity and motion anticipation

**S. Souihel (PhD 2016-2019)**, Biovision team,  
INRIA, Sophia Antipolis

F. Chavane, INT, Marseille

A. Destexhe, UNIC, Paris

O. Marre, Institut de la Vision, Paris

B. Cessac, Biovision team, INRIA, Sophia Antipolis



Project : ANR Trajectory.

# The visual flow

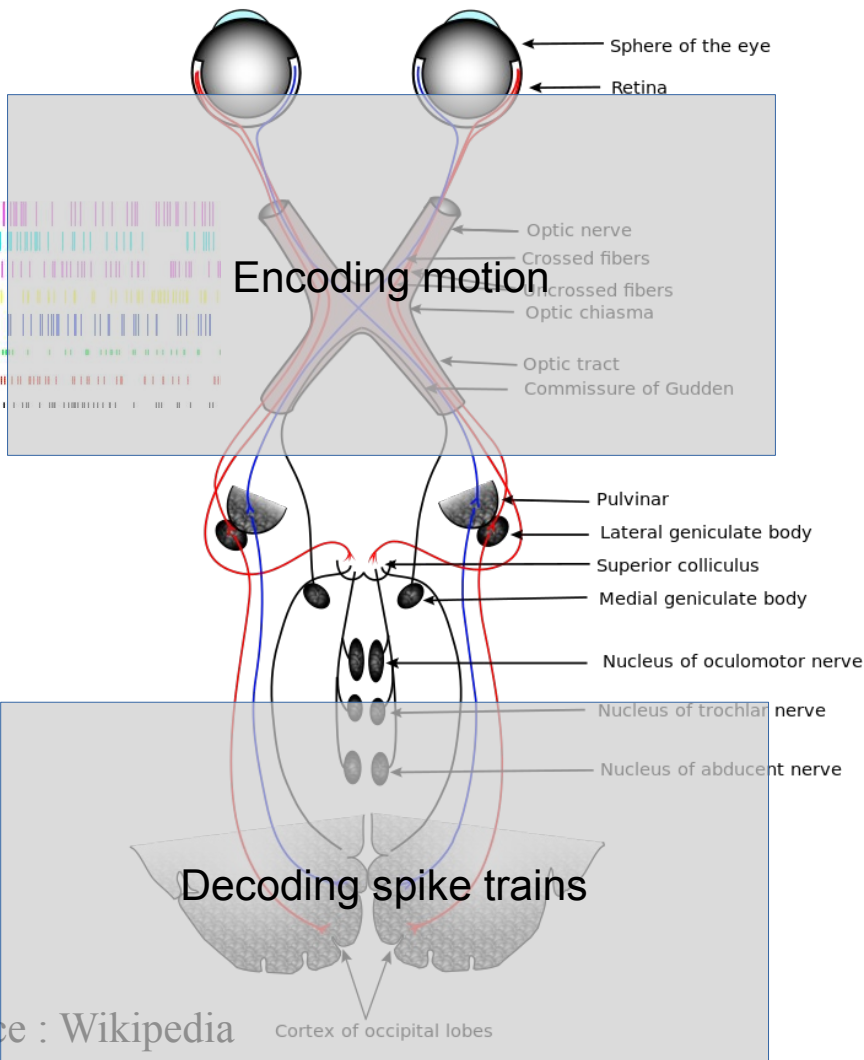

- **The retina is NOT a camera**
- High transduction rate : 1 photon can trigger a membrane voltage variation of ~1 mV
- Able to detect approaching motion
- Able to detect differential motion
- Sensitive to « surprise » in a visual scene
- Able to perform motion anticipation

# The visual flow

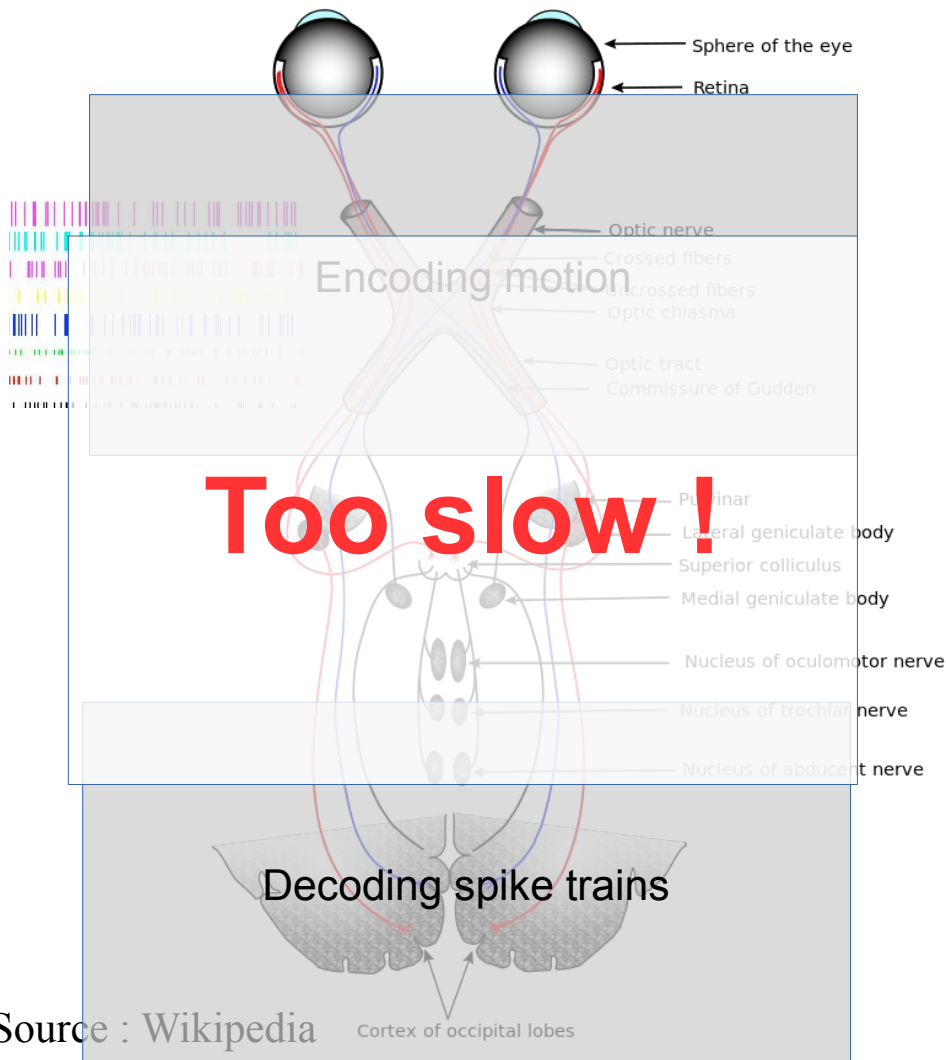

- **The retina is NOT a camera**
- High transduction rate : 1 photon can trigger a membrane voltage variation of ~1 mV
- Able to detect approaching motion
- Able to detect differential motion
- Sensitive to « surprise » in a visual scene
- Able to perform motion anticipation

# Visual Anticipation

**Anticipation** is carried out by the primary visual cortex (V1) through an activation wave

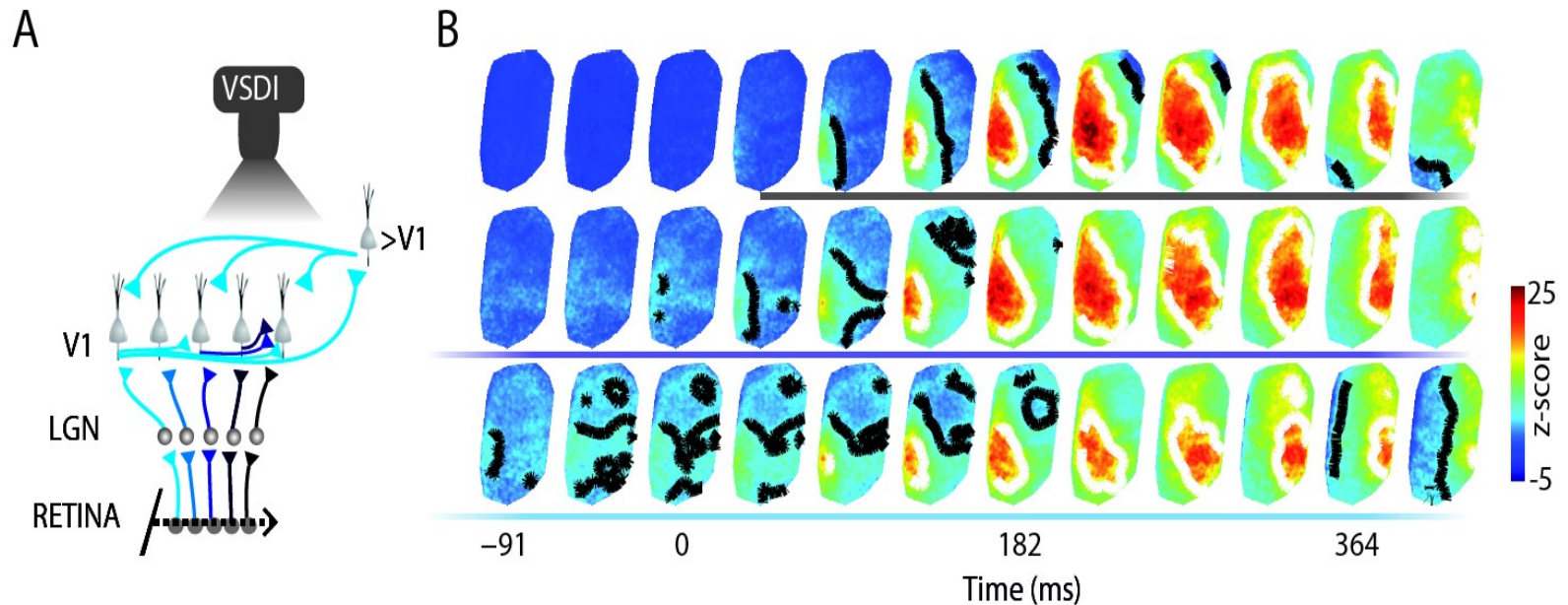

Source : Benvenuti et al. 2015

# Visual Anticipation

**Anticipation** also takes place in the retina

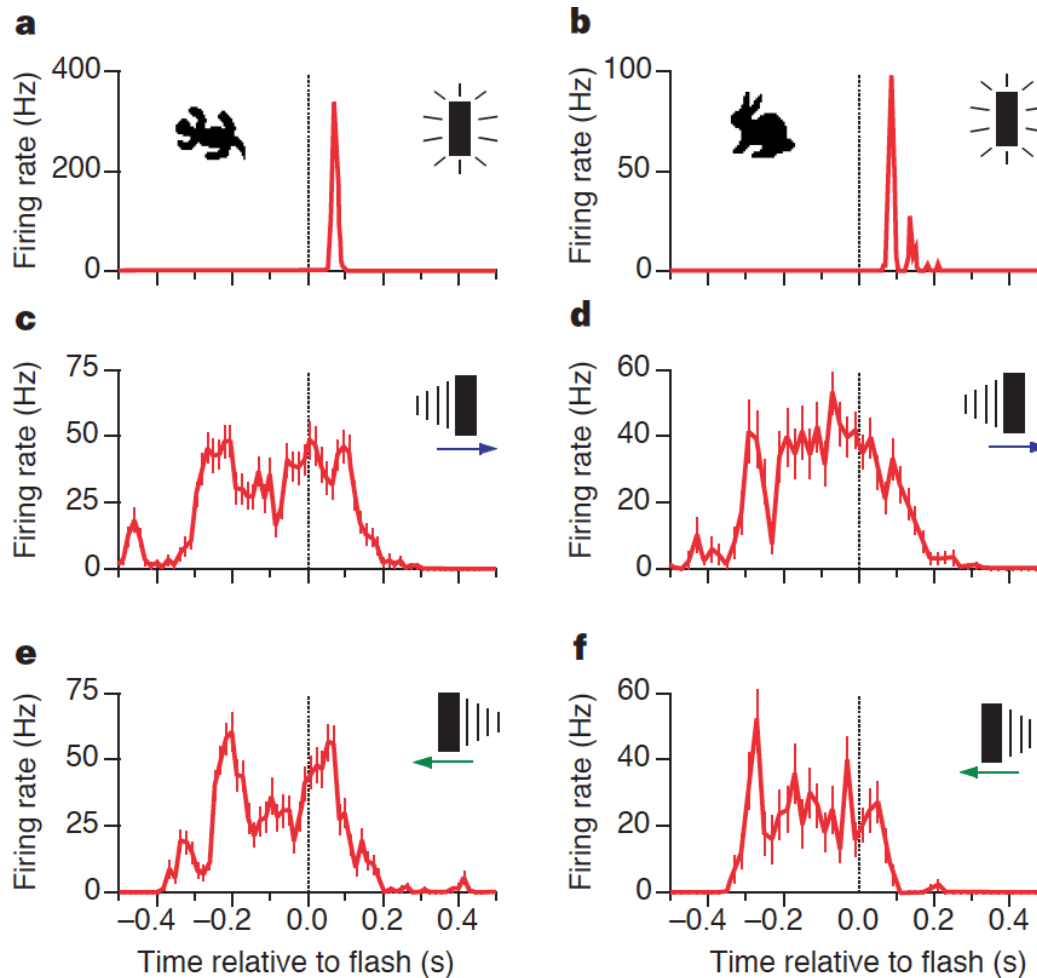

Source :  
Berry et al.  
1999

# Building a 2D retina model for motion anticipation

Souihel S., Cessac B., "On the potential role of lateral connectivity in retinal anticipation", Journal of Mathematical Neuroscience, BioMed Central, 2021, 11, [10.1186/s13408-020-00101-z](https://doi.org/10.1186/s13408-020-00101-z)

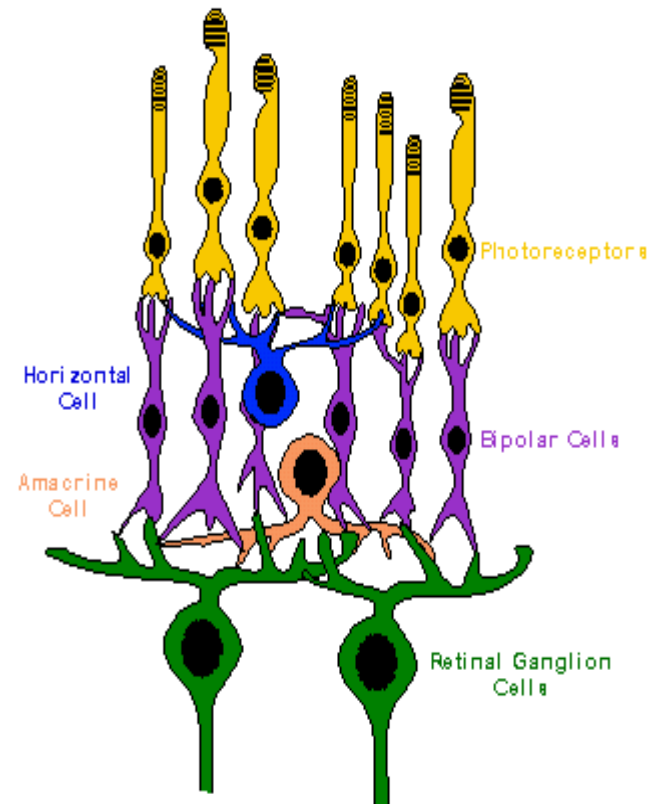
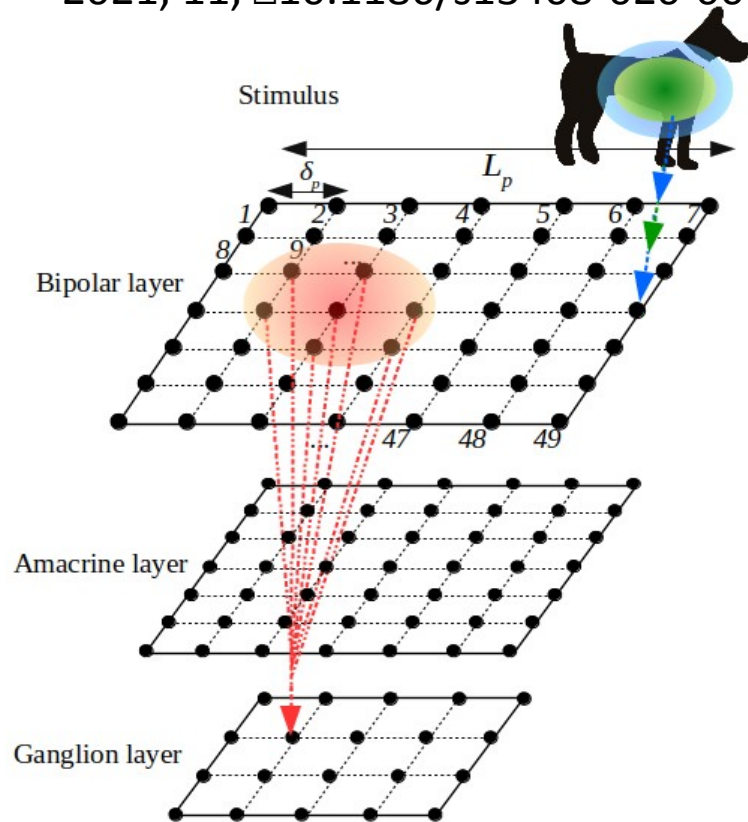

# Building a 2D retina model for motion anticipation

Souihel S., Cessac B., "On the potential role of lateral connectivity in retinal anticipation", Journal of Mathematical Neuroscience, BioMed Central, 2021, 11, [10.1186/s13408-020-00101-z](https://doi.org/10.1186/s13408-020-00101-z)

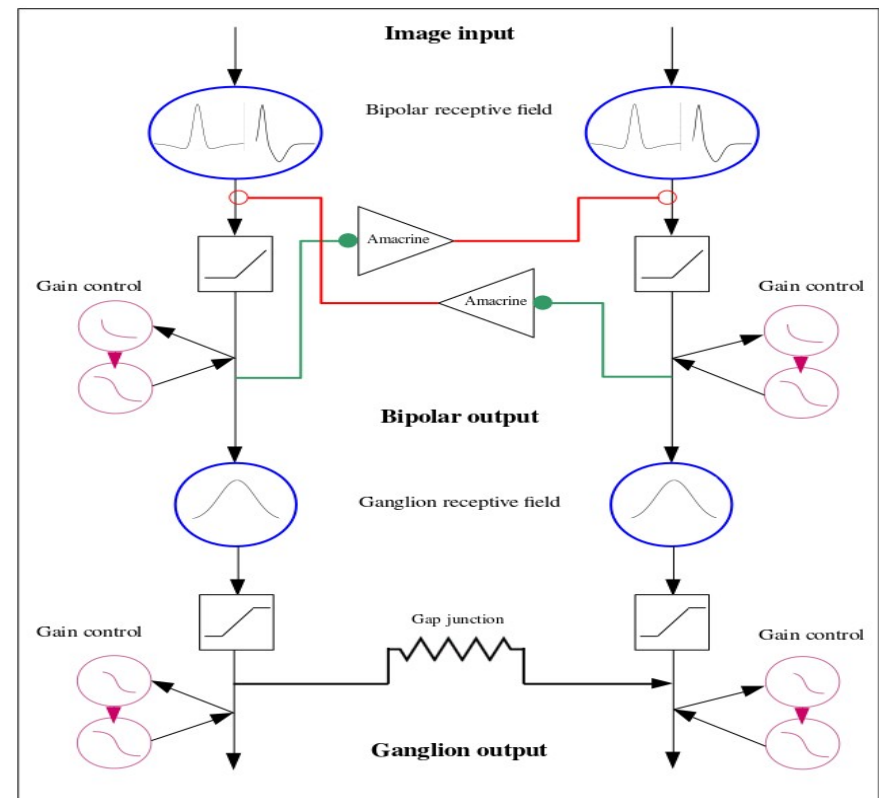
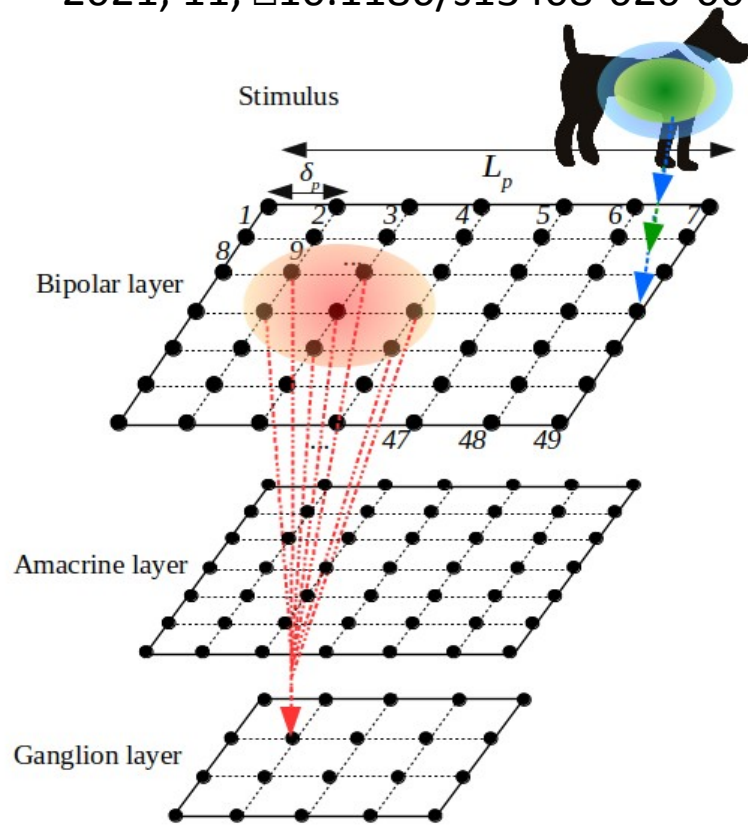

# Building a 2D retina model for motion anticipation

Souihel S., Cessac B., “On the potential role of lateral connectivity in retinal anticipation”, Journal of Mathematical Neuroscience, BioMed Central, 2021, 11, [10.1186/s13408-020-00101-z](https://doi.org/10.1186/s13408-020-00101-z)

$$\begin{cases} \frac{dV_{B_i}}{dt} = -\frac{1}{\tau_B}V_{B_i} + \sum_{j=1}^{N_A} W_{B_i}^{A_j} V_{A_j} + F_{B_i}(t), \\ \frac{dV_{A_j}}{dt} = -\frac{1}{\tau_A}V_{A_j} + \sum_{i=1}^{N_B} W_{A_j}^{B_i} R_{B_i}, \\ \frac{dA_{B_i}}{dt} = -\frac{A_{B_i}}{\tau_a} + h_B \mathcal{N}(V_{B_i}). \end{cases}$$

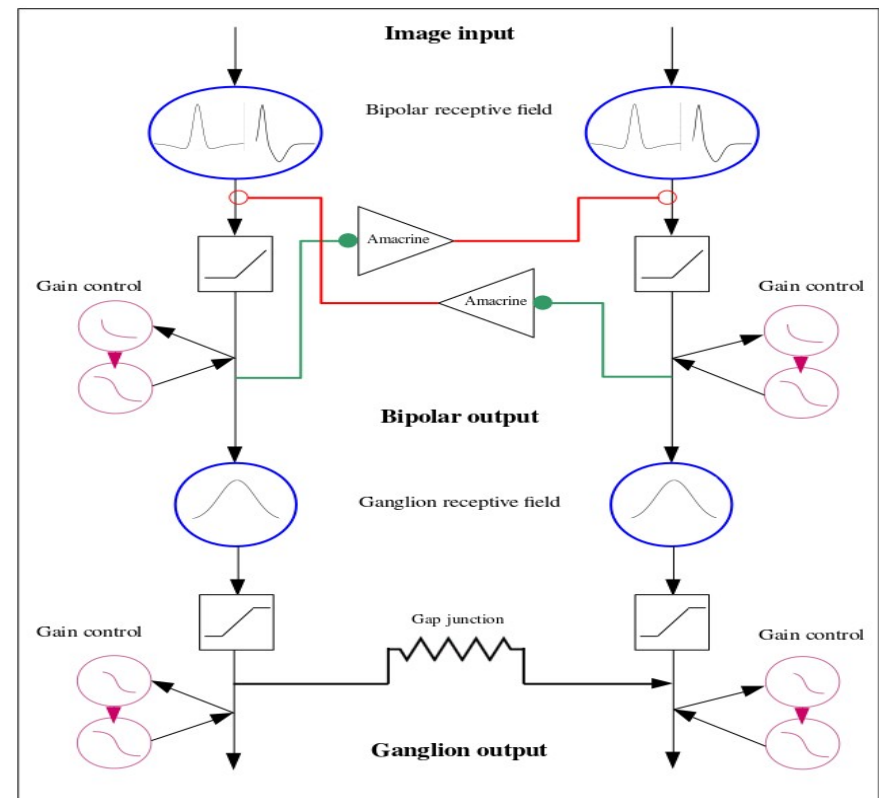



# Building a 2D retina model for motion anticipation

Souihel S., Cessac B., "On the potential role of lateral connectivity in retinal anticipation", Journal of Mathematical Neuroscience, BioMed Central, 2021, 11, [10.1186/s13408-020-00101-z](https://doi.org/10.1186/s13408-020-00101-z)

## Stimulus dependent drive

$$\begin{cases} \frac{dV_{B_i}}{dt} = -\frac{1}{\tau_B} V_{B_i} + \sum_{j=1}^{N_A} W_{B_i}^{A_j} V_{A_j} + F_{B_i}(t), \\ \frac{dV_{A_j}}{dt} = -\frac{1}{\tau_A} V_{A_j} + \sum_{i=1}^{N_B} W_{A_j}^{B_i} R_{B_i}, \\ \frac{dA_{B_i}}{dt} = -\frac{A_{B_i}}{\tau_a} + h_B \mathcal{N}(V_{B_i}). \end{cases}$$

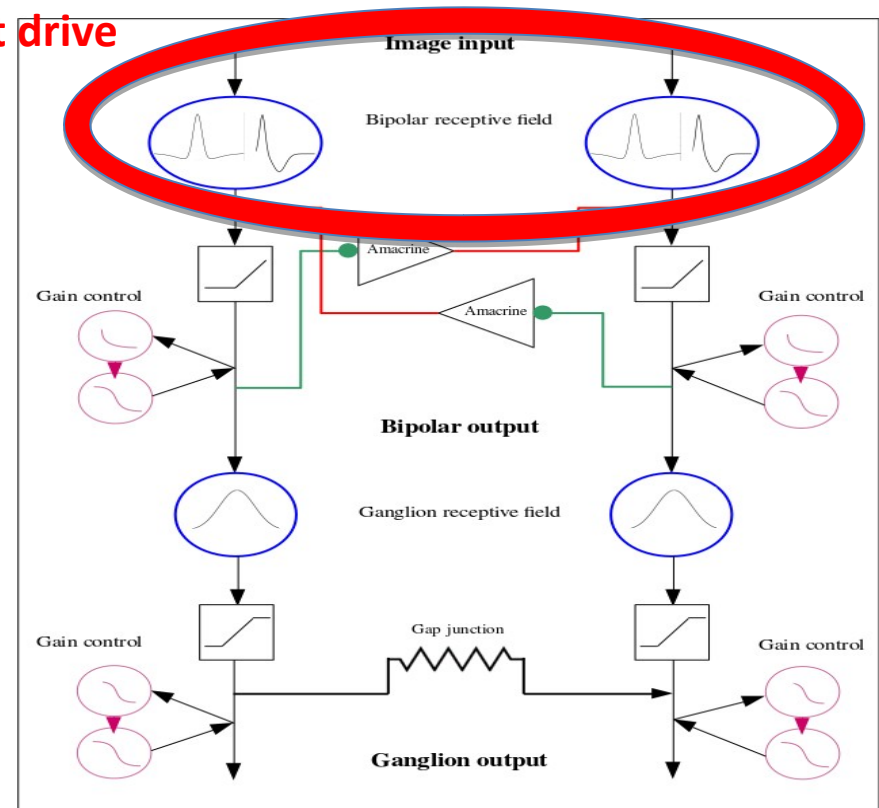

# Building a 2D retina model for motion anticipation

Souihel S., Cessac B., "On the potential role of lateral connectivity in retinal anticipation", Journal of Mathematical Neuroscience, BioMed Central, 2021, 11, [10.1186/s13408-020-00101-z](https://doi.org/10.1186/s13408-020-00101-z)

$$\left\{ \begin{aligned} \frac{dV_{B_i}}{dt} &= -\frac{1}{\tau_B} V_{B_i} + \sum_{j=1}^{N_A} W_{B_i}^{A_j} V_{A_j} + F_{B_i}(t), \\ \frac{dV_{A_j}}{dt} &= -\frac{1}{\tau_A} V_{A_j} + \sum_{i=1}^{N_B} W_{A_j}^{B_i} R_{B_i}, \\ \frac{dA_{B_i}}{dt} &= -\frac{A_{B_i}}{\tau_a} + h_B \mathcal{N}(V_{B_i}). \end{aligned} \right.$$

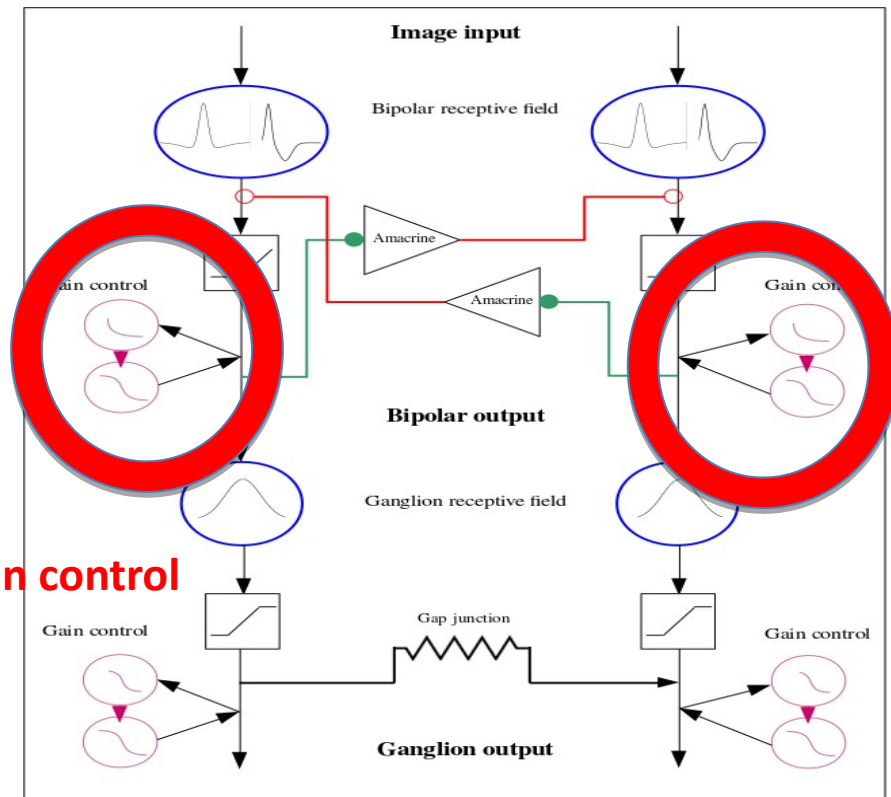

**Non linear gain control**

# Building a 2D retina model for motion anticipation

Souihel S., Cessac B., "On the potential role of lateral connectivity in retinal anticipation", Journal of Mathematical Neuroscience, BioMed Central, 2021, 11, [10.1186/s13408-020-00101-z](https://doi.org/10.1186/s13408-020-00101-z)

$$\frac{dV_{B_i}}{dt} = -\frac{1}{\tau_B} V_{B_i} + \sum_{j=1}^{N_A} W_{B_i}^{A_j} V_{A_j} + F_{B_i}(t),$$

$$\frac{dV_{A_j}}{dt} = -\frac{1}{\tau_A} V_{A_j} + \sum_{i=1}^{N_B} W_{A_j}^{B_i} R_{B_i},$$

$$\frac{dA_{B_i}}{dt} = -\frac{A_{B_i}}{\tau_a} + h_B \mathcal{N}(V_{B_i}).$$

**Non linear gain control**

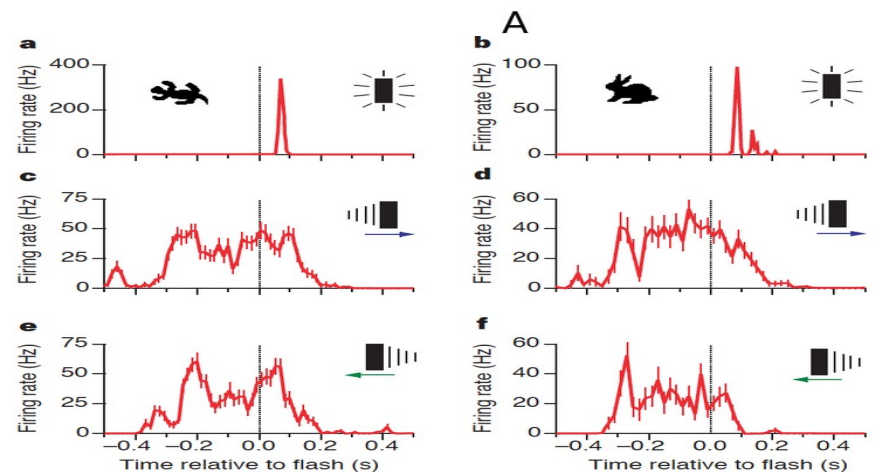
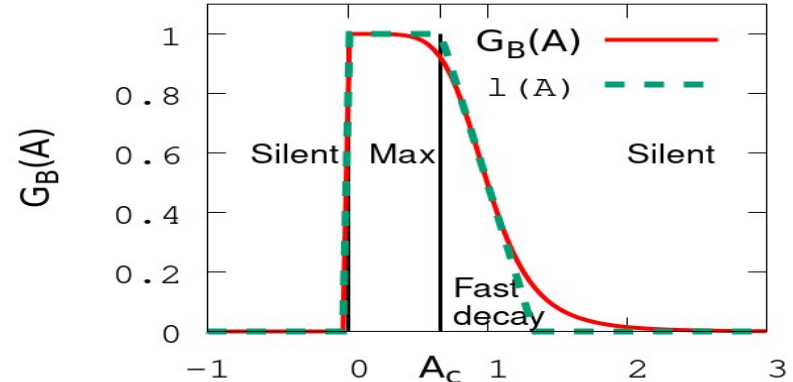

# Building a 2D retina model for motion anticipation

Souihel S., Cessac B., "On the potential role of lateral connectivity in retinal anticipation", Journal of Mathematical Neuroscience, BioMed Central, 2021, 11, [10.1186/s13408-020-00101-z](https://doi.org/10.1186/s13408-020-00101-z)

**Inhibition**

$$\left\{ \begin{aligned} \frac{dV_{B_i}}{dt} &= -\frac{1}{\tau_B} V_{B_i} + \sum_{j=1}^N W_{B_i}^{A_j} V_{A_j} + F_{B_i}(t), \\ \frac{dV_{A_j}}{dt} &= -\frac{1}{\tau_A} V_{A_j} + \sum_{i=1}^{N_B} W_{A_j}^{B_i} R_{B_i}, \\ \frac{dA_{B_i}}{dt} &= -\frac{A_{B_i}}{\tau_a} + h_B \mathcal{N}(V_{B_i}). \end{aligned} \right.$$

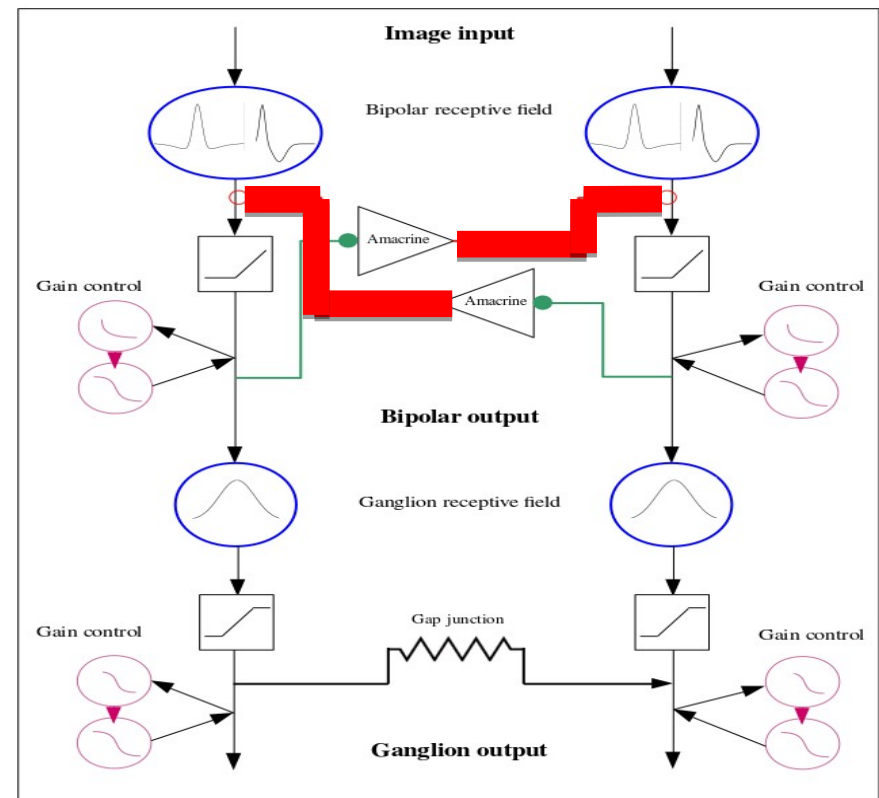

# Building a 2D retina model for motion anticipation

Souihel S., Cessac B., "On the potential role of lateral connectivity in retinal anticipation", Journal of Mathematical Neuroscience, BioMed Central, 2021, 11, [10.1186/s13408-020-00101-z](https://doi.org/10.1186/s13408-020-00101-z)

$$\left\{ \begin{aligned} \frac{dV_{B_i}}{dt} &= -\frac{1}{\tau_B} V_{B_i} + \sum_{j=1}^{N_A} W_{B_i}^{A_j} V_{A_j} + F_{B_i}(t), \\ \frac{dV_{A_j}}{dt} &= -\frac{1}{\tau_A} V_{A_j} + \sum_{i=1}^B W_{A_j}^{B_i} R_{B_i}, \\ \frac{dA_{B_i}}{dt} &= -\frac{A_{B_i}}{\tau_a} + h_B \mathcal{N}(V_{B_i}). \end{aligned} \right.$$

**Excitation**

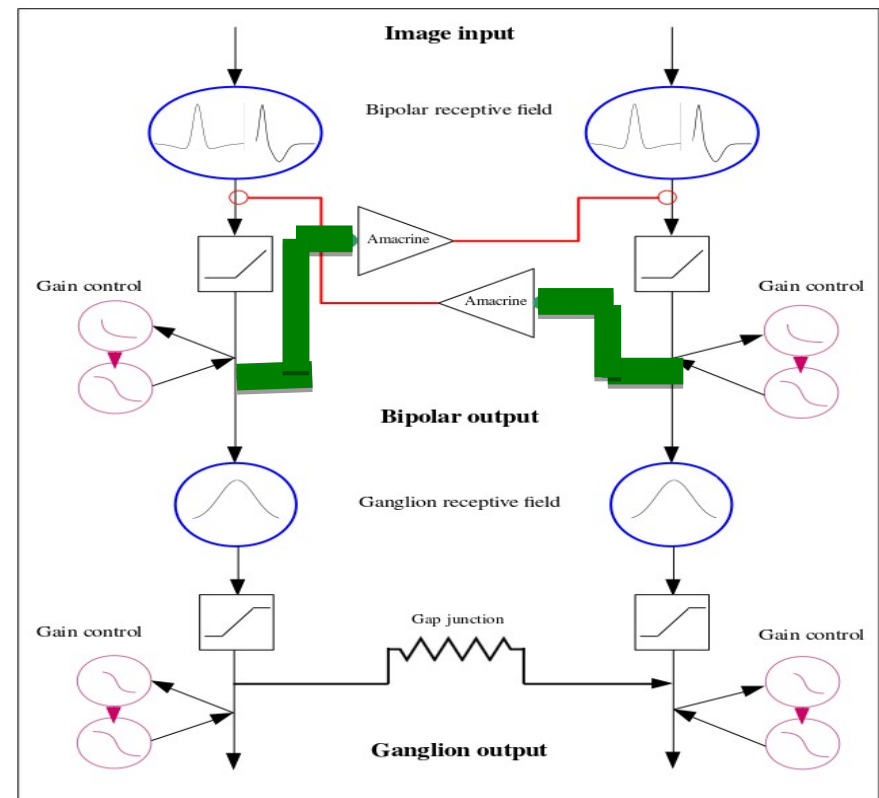

# Building a 2D retina model for motion anticipation

Souihel S., Cessac B., “On the potential role of lateral connectivity in retinal anticipation”, Journal of Mathematical Neuroscience, BioMed Central, 2021, 11, [10.1186/s13408-020-00101-z](https://doi.org/10.1186/s13408-020-00101-z)

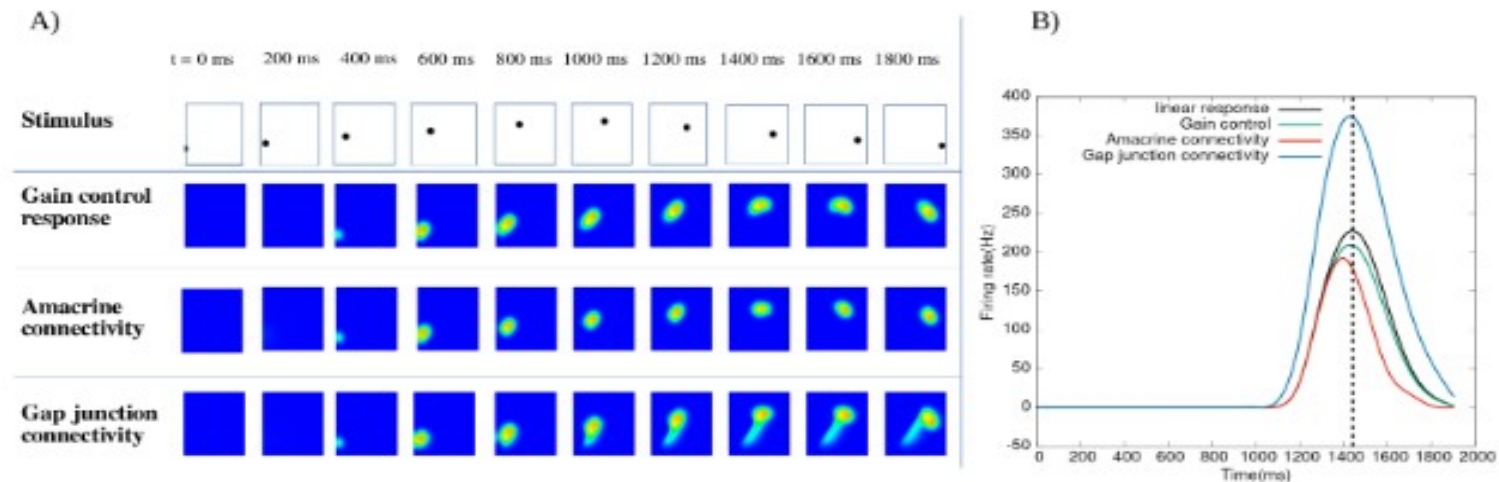

Figure 15: **Effect of anticipatory mechanisms on a parabolic trajectory.** A) Response to a dot moving along a parabolic trajectory. The first line shows the stimulus, the second line shows the GCells response with gain control, the third line presents the effect of lateral ACells connectivity with  $w = 0.3 \text{ ms}^{-1}$ , and the last line shows the effect of asymmetric gap junctions with  $v_{gap} = 9 \text{ mm/s}$ . B) Time course response of a cell responding to the dot near the trajectory turning point. Linear response corresponds to the response to the stimulus without gain control.



# Retino-cortical model of anticipation

- A retino-cortical (V1) model of anticipation (with F. Chavane, S. Chemla, A. Destexhe, S. Souihel, M. Di Volo).

# Retino-cortical model of anticipation

- A retino-cortical (V1) model of anticipation (with F. Chavane, S. Chemla, A. Destexhe, S. Souihel, M. Di Volo).

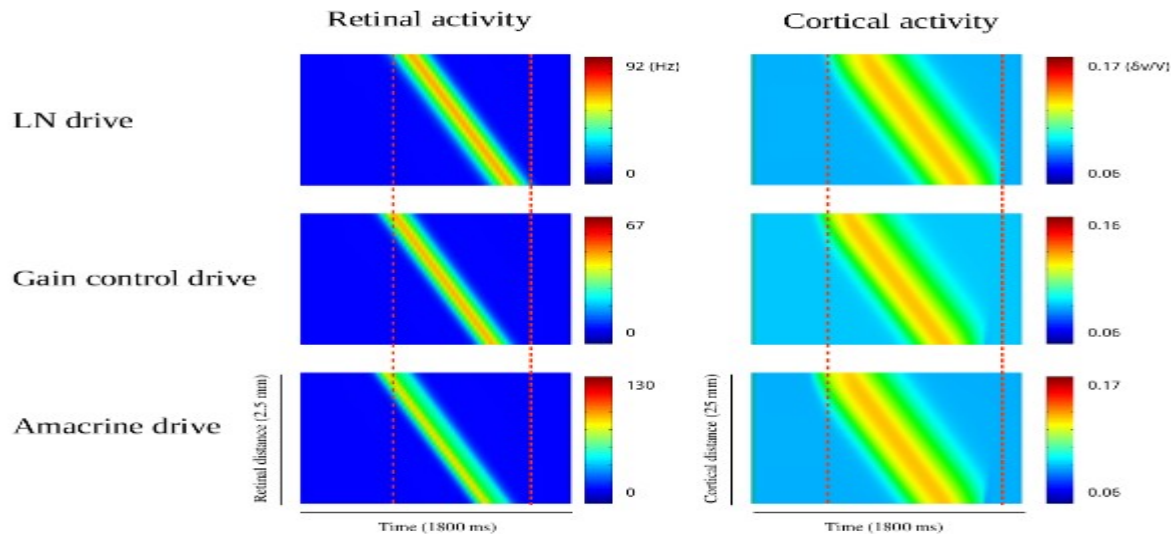

Figure 11: Comparing the spatio-temporal activity with the different drives. Left column figures display the spatio-temporal retinal activity with different anticipatory mechanisms, and the right column displays the corresponding spatio-temporal cortical activity. The red dashed lines denote the start and the end times of the LN retinal and cortical activities, as a reference base.



# Retino-cortical model of anticipation

- A retino-cortical (V1) model of anticipation (with F. Chavane, S. Chemla, A. Destexhe, S. Souihel, M. Di Volo).
- Is our model able to anticipate more complex trajectories, with accelerations for instance ?
- How to calibrate connectivity using biology ?
- How does anticipation affect higher order correlations ?
- Would it be possible to design psycho-physical tests clearly showing the role of the retina in visual anticipation ?



# A question about retinal coding

R. Cofré, CIMFAV, Facultad de Ingenieria,  
Universidad de Valparaiso, Valparaiso, Chile

Ignacio Ampuero, Departamento de Informatica,  
Universidad Tecnica Federico Santa Maria,  
Valparaiso, Chile

# The visual system

Encoder

Decoder

Retina's layered structure

ganglion cells bipolar cells photoreceptors

amacrine cells horizontal cells

Light

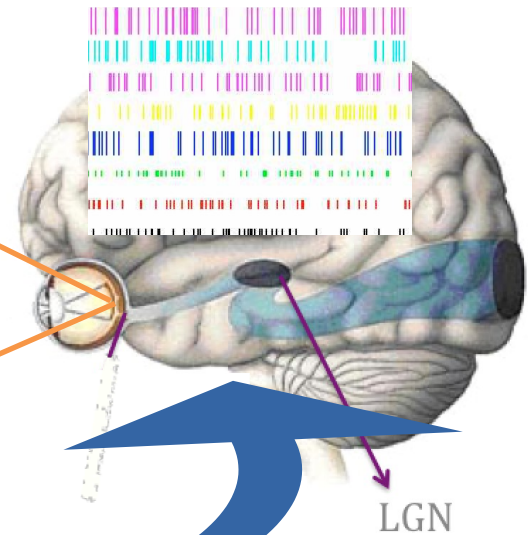
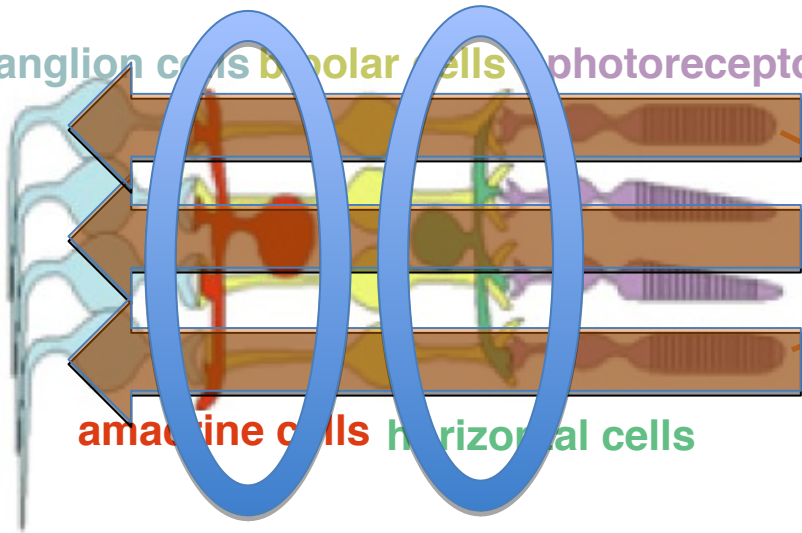
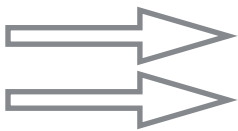

Visual cortex

LGN

« Information » flux

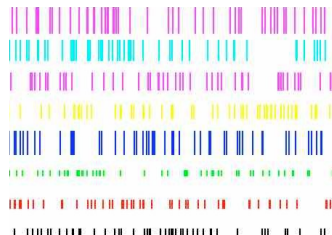

# Spontaneous spiking activity

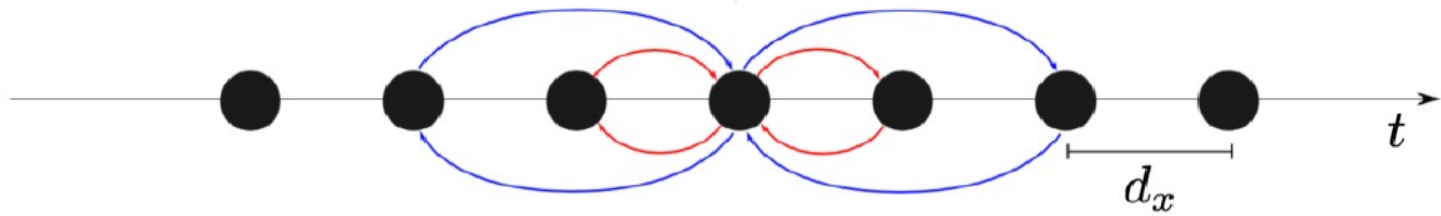

# Spontaneous spiking activity

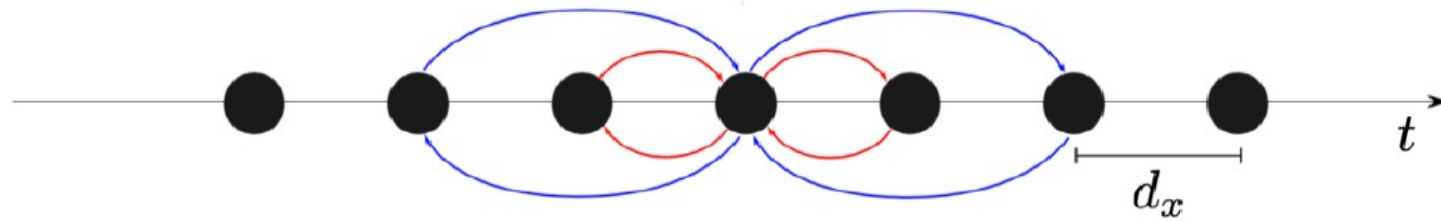

# Spontaneous spiking activity

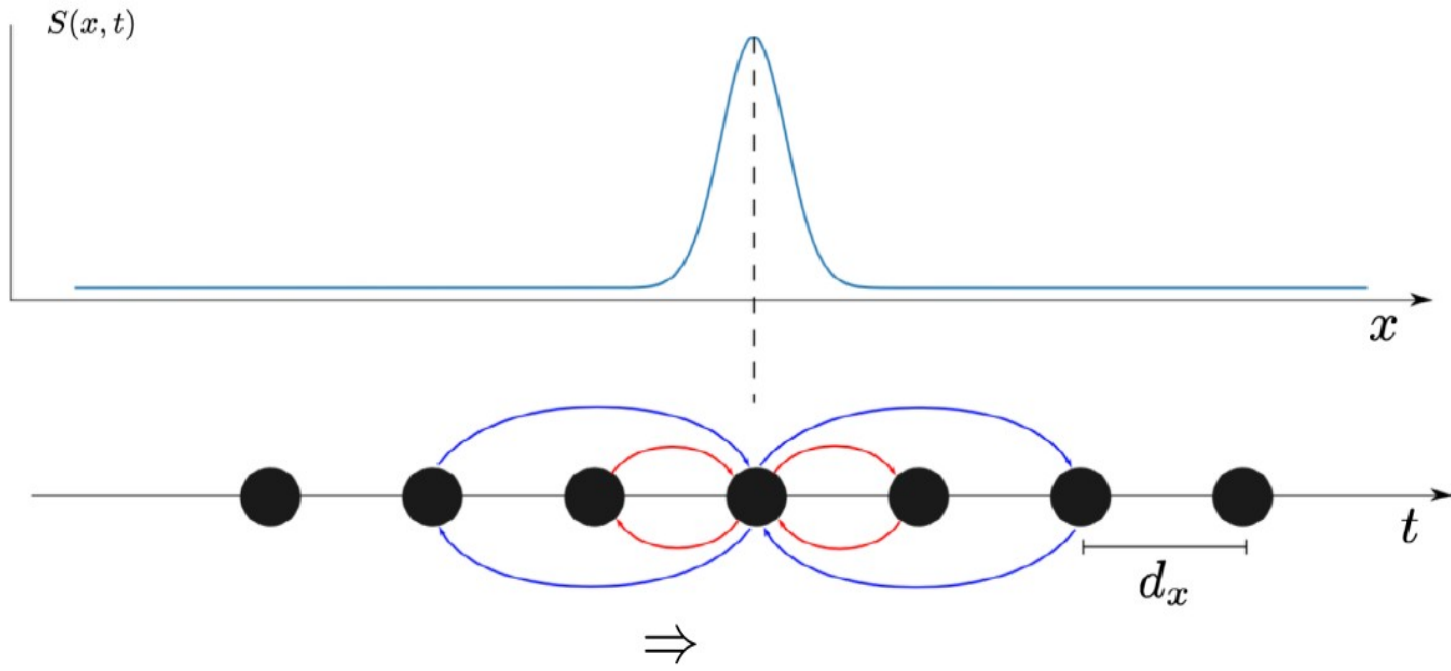

# Spontaneous spiking activity

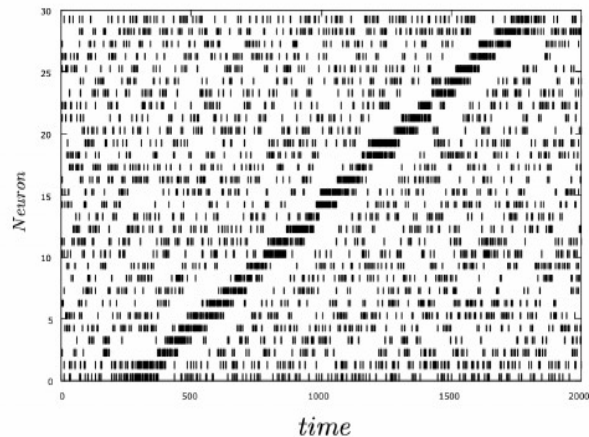
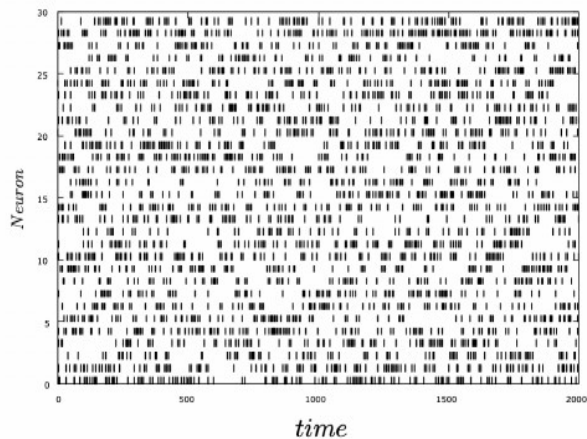
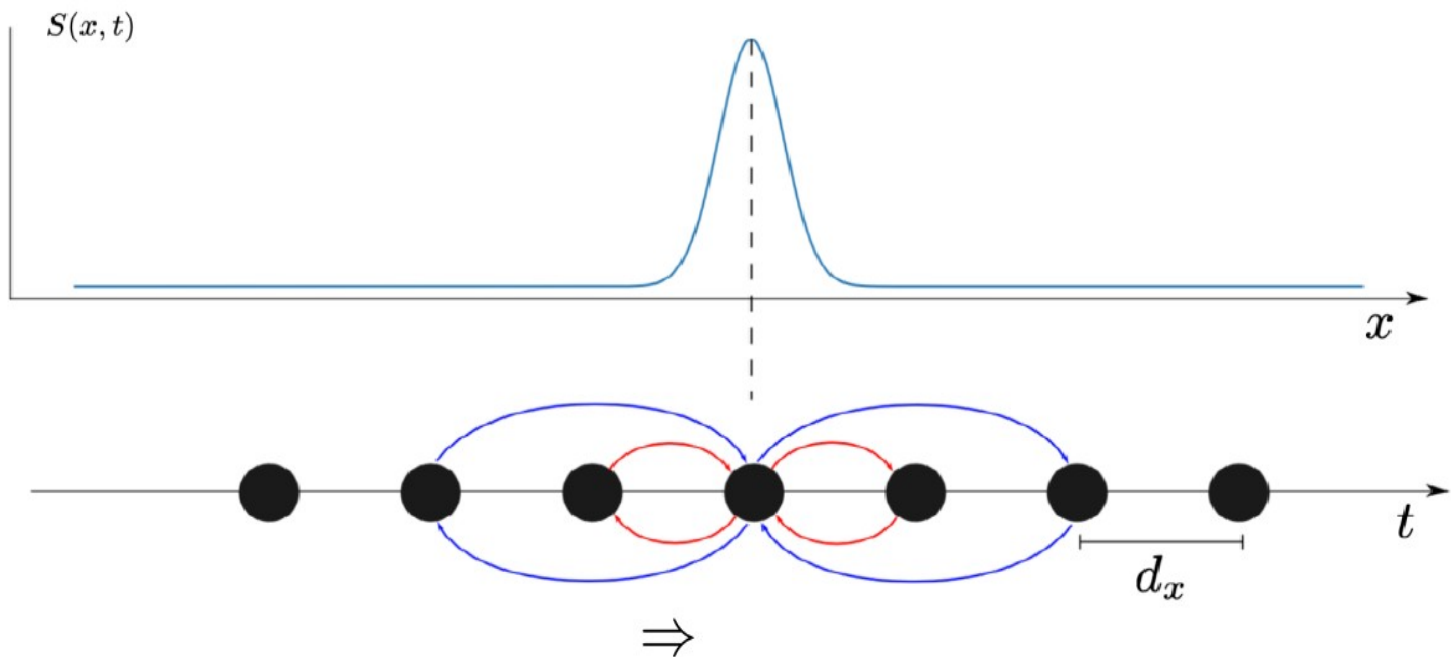



# Spontaneous spiking activity

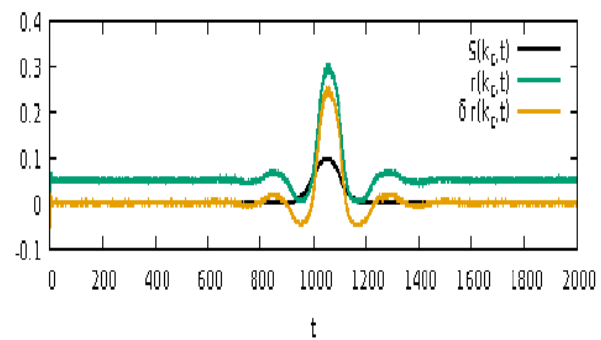
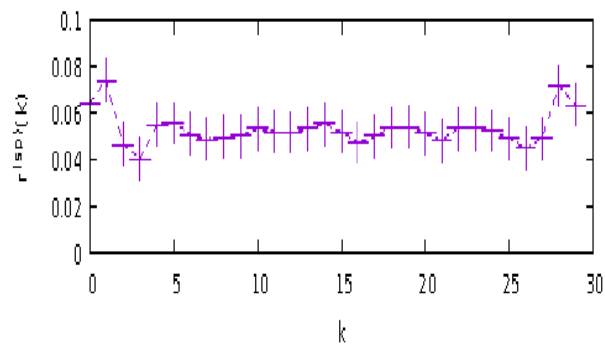
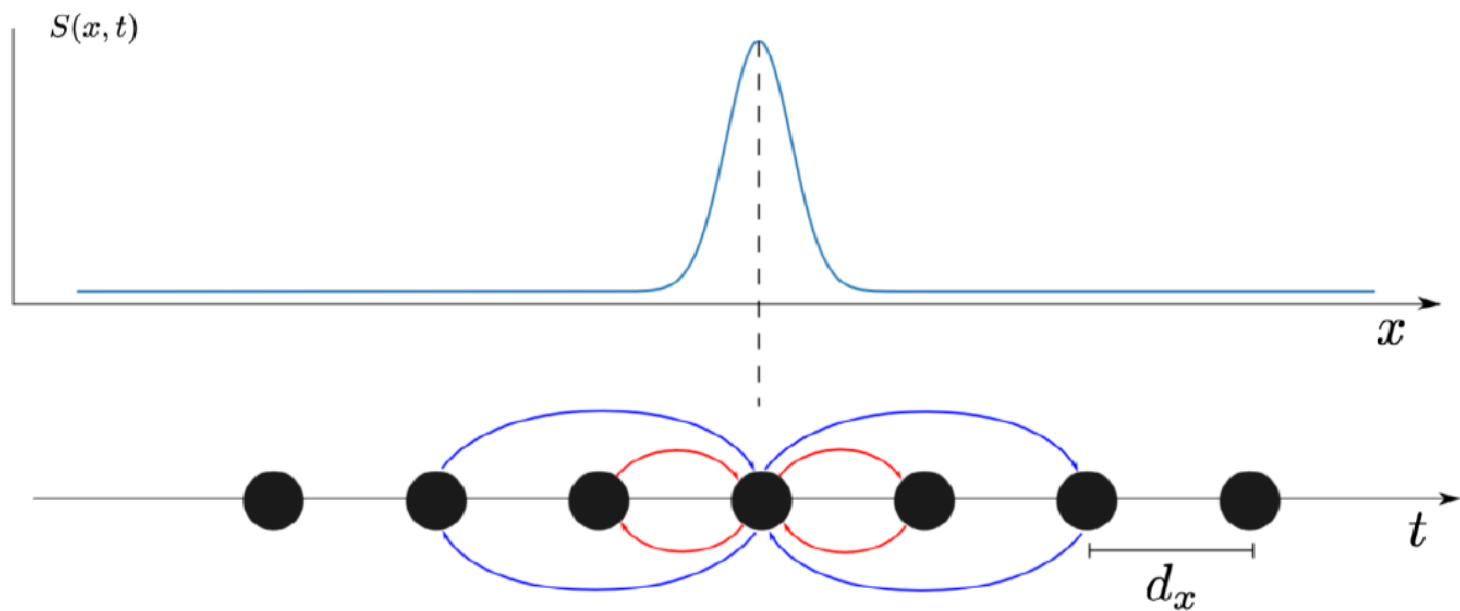

Sample averaging (non stationary)

# Spontaneous spiking activity

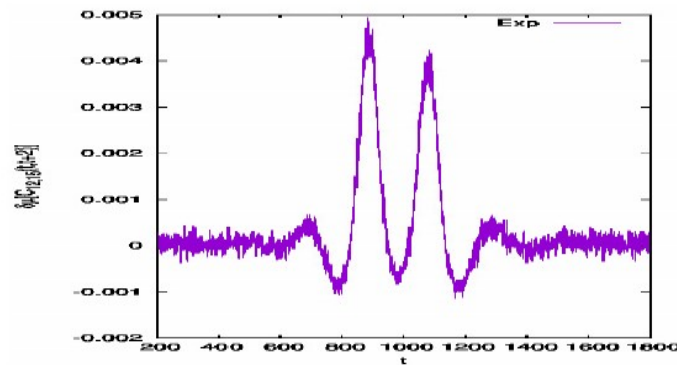
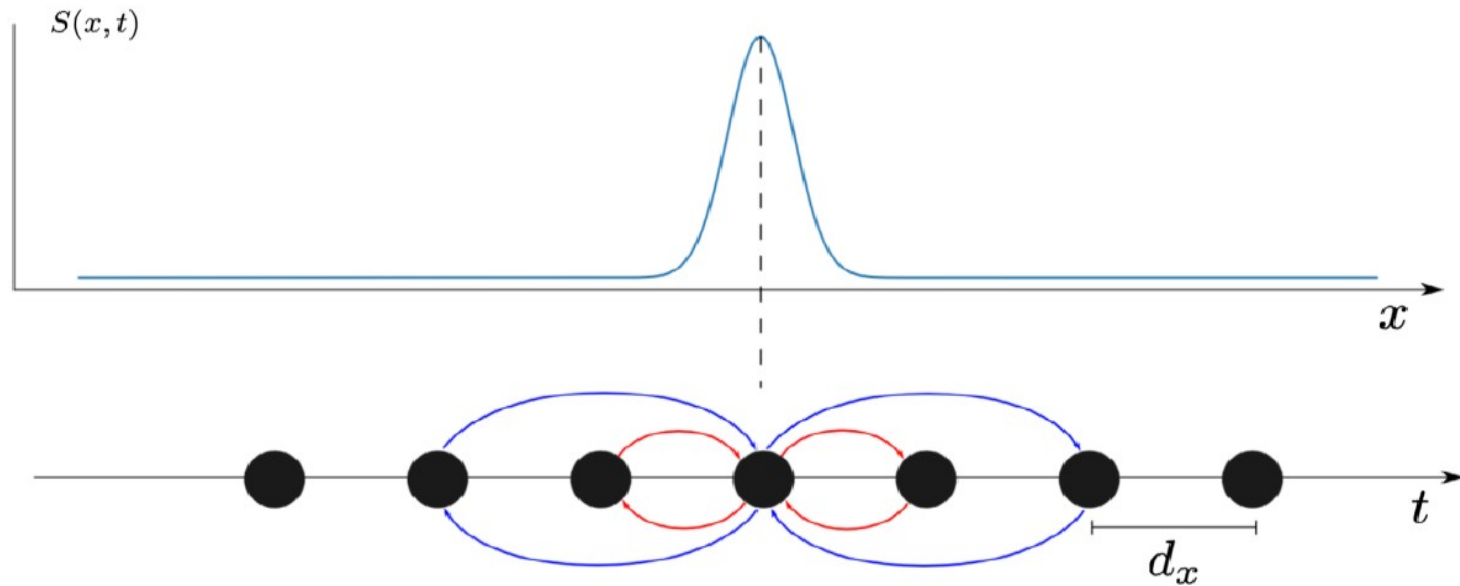

Variation in the correlation  $C_{12,15}(t, t+2)$

Correlation variations are triggered by the stimulus, but they are constrained by the network dynamics.

How to compute the spatio-temporal response of a neuronal network to a time dependent stimulus ?

Can we compute the time variation of spike-observables as a function of the stimulus and spontaneous dynamics ?

B. Cessac, I. Ampuero, R. Cofre, Linear response for spiking neuronal networks with unbounded memory. Entropy, MDPI, 2021, 23 (2), pp.155.

# Response to stimuli

B. Cessac, I. Ampuero, R. Cofre, Linear response for spiking neuronal networks with unbounded memory. Entropy, MDPI, 2021, 23 (2), pp.155.

GIF model without stimulus  $\Rightarrow$  *stationary Gibbs distribution*.

*time-dependent* stimulus  $S(t) \Rightarrow$  *non stationary Gibbs distribution*.

*How is the average of an observable  $f(\omega, t)$  affected by the stimulus ?*

If  $S$  is weak enough:  $\delta\mu[f(t)] = [\kappa_f * S](t)$  , (linear response).

$$\kappa_{k,f}(t - t_1) = \frac{1}{C_k} \sum_{r=-\infty}^{n=[t]} C^{(sp)} \left[ f(t, \cdot), \frac{\mathcal{H}_k^{(1)}(r, \cdot)}{\sigma_k(r-1, \cdot)} \int_{\tau_k(r-1, \cdot)}^{r-1} S_k(t_1) \Gamma_k(t_1, r-1, \cdot) dt_1 \right]$$

# Firing rates

Computations have been done using the INRIA Pranas software, B. Cessac et al, *Frontiers in Neuroinformatics*, Vol 11, page 49, (2017).

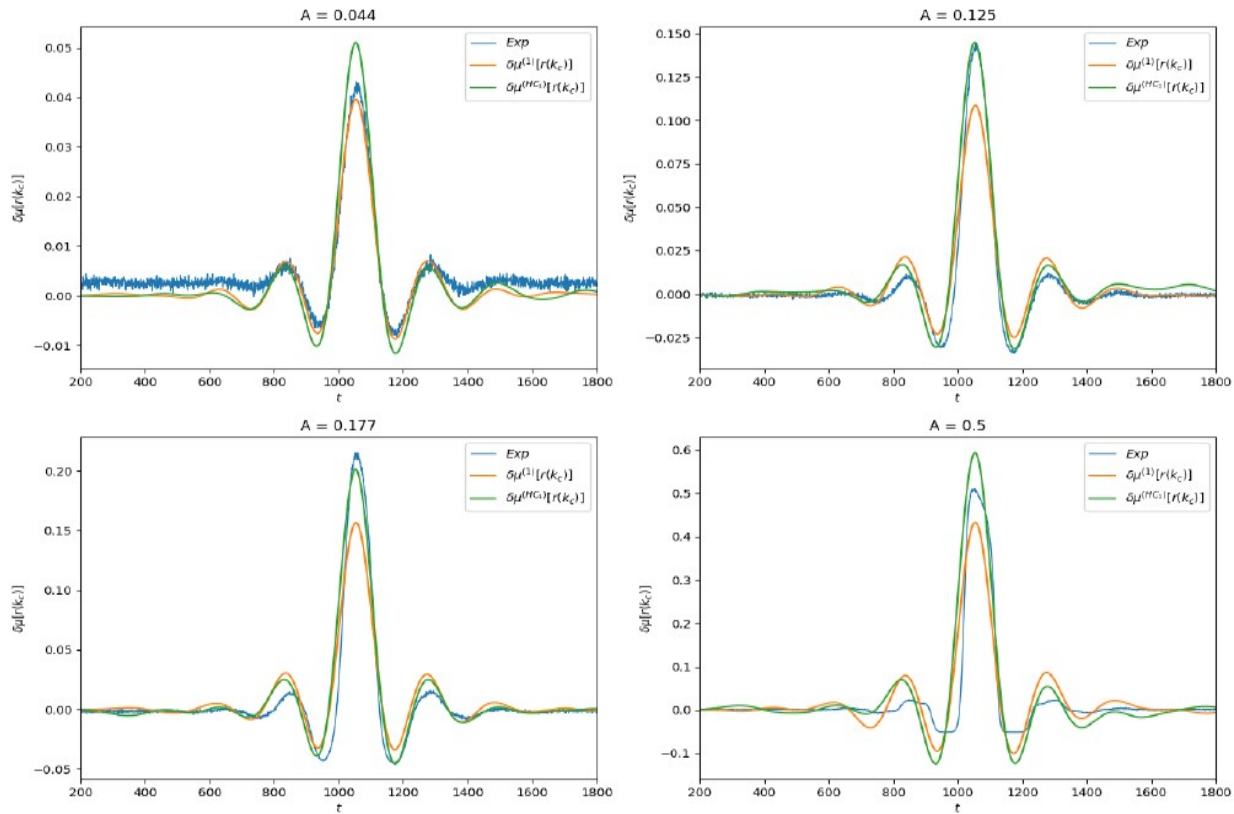

Figure: Linear response of  $f(\omega, n) = \omega_{k_c}(n)$  for different values of stimulus amplitude  $A$ .

# Higher order observable

Computations have been done using the INRIA Pranas software, B. Cessac et al, *Frontiers in Neuroinformatics*, Vol 11, page 49, (2017).

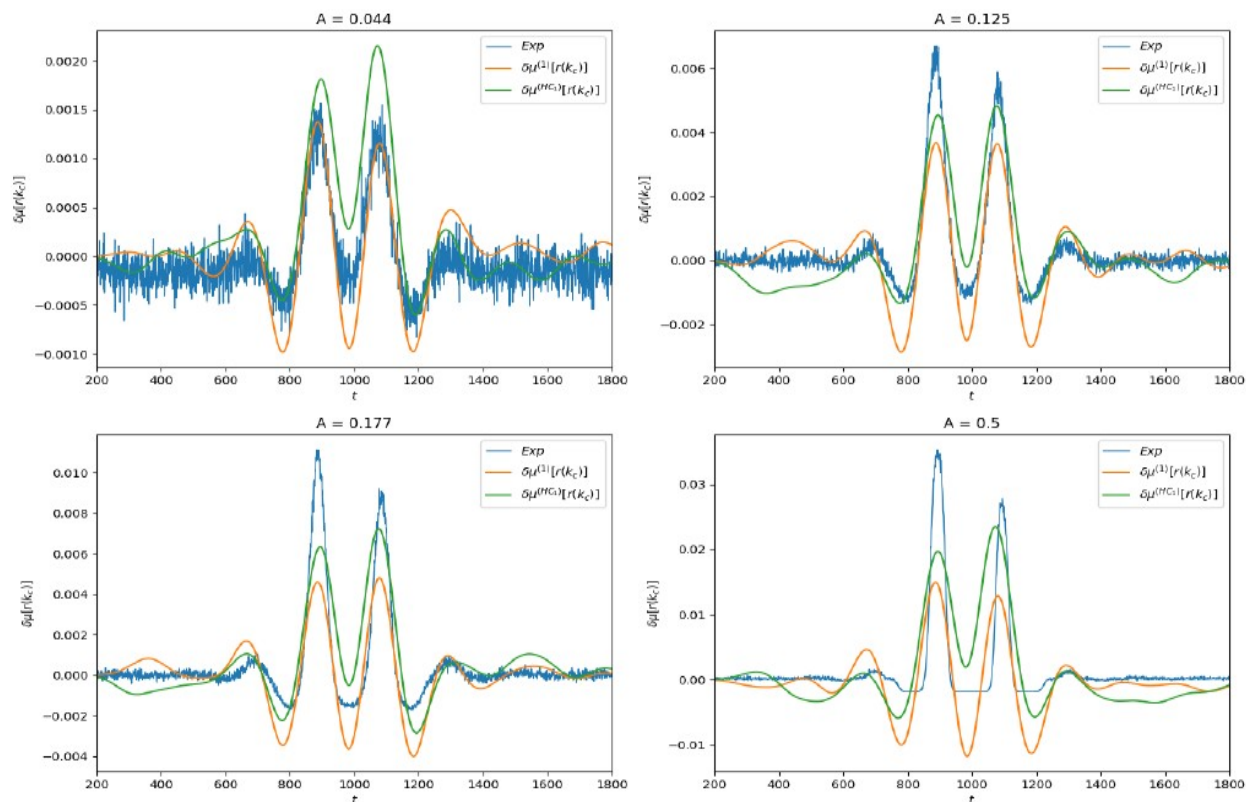

Figure: Linear response of the observable  $f(n, \omega) = \omega_{k_c - 2}(n - 3)\omega_{k_c}(n)$ .

# Conclusions

- Visual entries are neither stationary, nor spatially regular.
- The « longitudinal » pathways PhotoReceptors => Bipolar cells => Ganglion cells efficiently encode the visual information into parallel flows.
- Lateral connectivity (Horizontal and Amacrine) cells contributes to visual encoding as well. Horizontal cells contribute to the shaping of spatio-temporal receptive fields. What is the role of Amacrine cells ?
- On the basis of biophysical modelling + mathematical analysis we found that Amacrine cells may generate, from the non stationary stimulus, spatio-temporal correlations (waves) contributing to better deciphering a visual scene (anticipation).
- This is very different from the « efficient coding » paradigm where longitudinal pathways are assumed to be independent. We switch from a paradigm of « rate » decoding to « correlations » decoding.

Thanks 😊