



HAL
open science

**NeuroMat webinars 2021 Sao Paulo Brasil Available at
https://www.youtube.com/watch?v=BJ-5O-HJg_Y**

Bruno Cessac

► **To cite this version:**

Bruno Cessac. NeuroMat webinars 2021 Sao Paulo Brasil Available at https://www.youtube.com/watch?v=BJ-5O-HJg_Y. NeuroMat webinars 2021 Sao Paulo Brasil, Jun 2021, Sao Paulo, Brazil. hal-03331825

HAL Id: hal-03331825

<https://inria.hal.science/hal-03331825v1>

Submitted on 2 Sep 2021

HAL is a multi-disciplinary open access archive for the deposit and dissemination of scientific research documents, whether they are published or not. The documents may come from teaching and research institutions in France or abroad, or from public or private research centers.

L'archive ouverte pluridisciplinaire **HAL**, est destinée au dépôt et à la diffusion de documents scientifiques de niveau recherche, publiés ou non, émanant des établissements d'enseignement et de recherche français ou étrangers, des laboratoires publics ou privés.

The retina as a dynamical system

B. Cessac, Université Côte d'Azur, INRIA,
Biovision team and Neuromod Institute
Sophia Antipolis, France

The INRIA logo is a stylized, cursive script in a gradient of red and orange colors.The logos for the University of Côte d'Azur and the NeuroMod Institute. The University logo features a circular pattern of dots above the text 'UNIVERSITÉ CÔTE D'AZUR'. The NeuroMod logo features a stylized brain icon above the text 'NeuroMod'.

The retina and its dynamics

The visual system

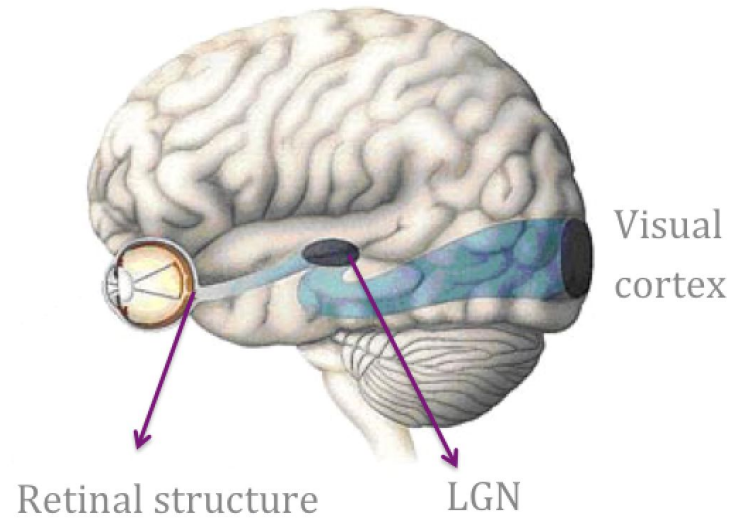

The visual system

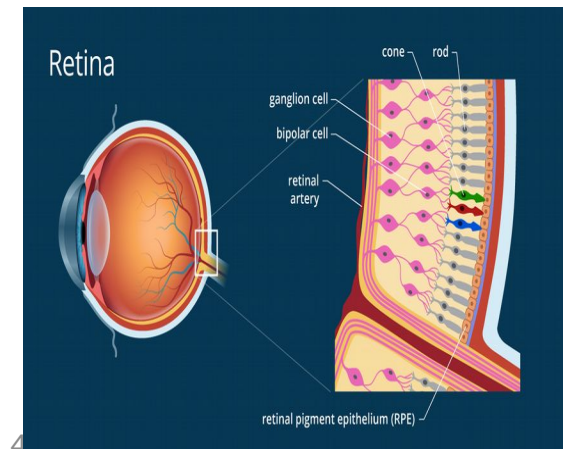
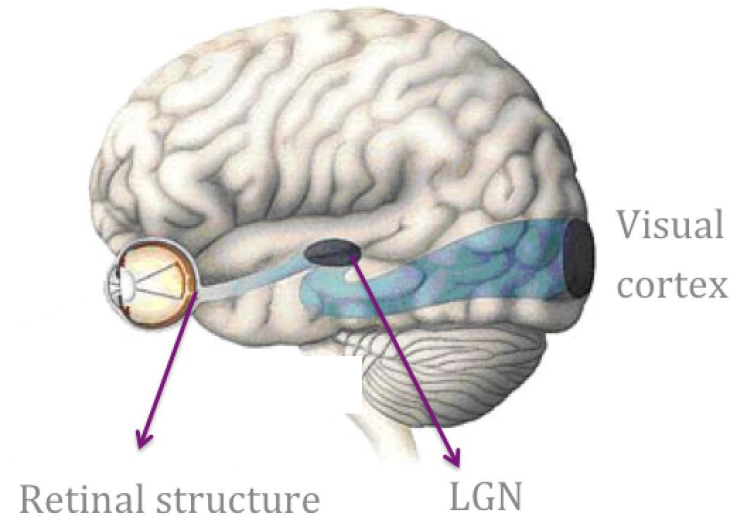

The visual system

Retina's layered structure

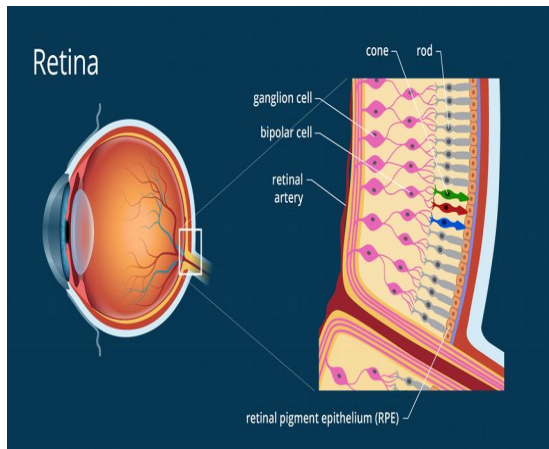
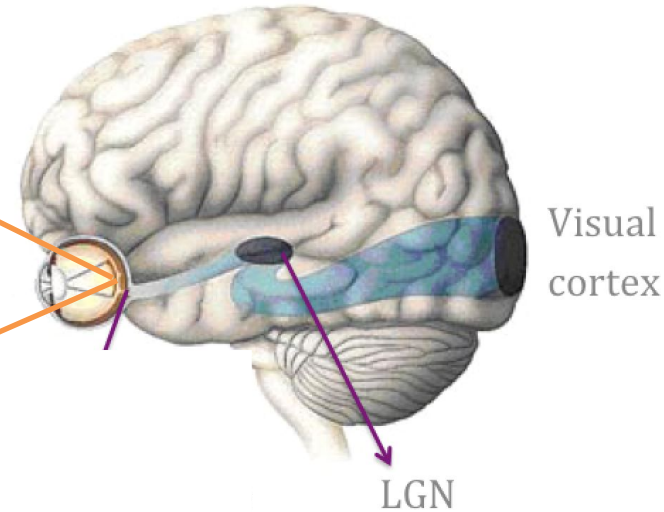
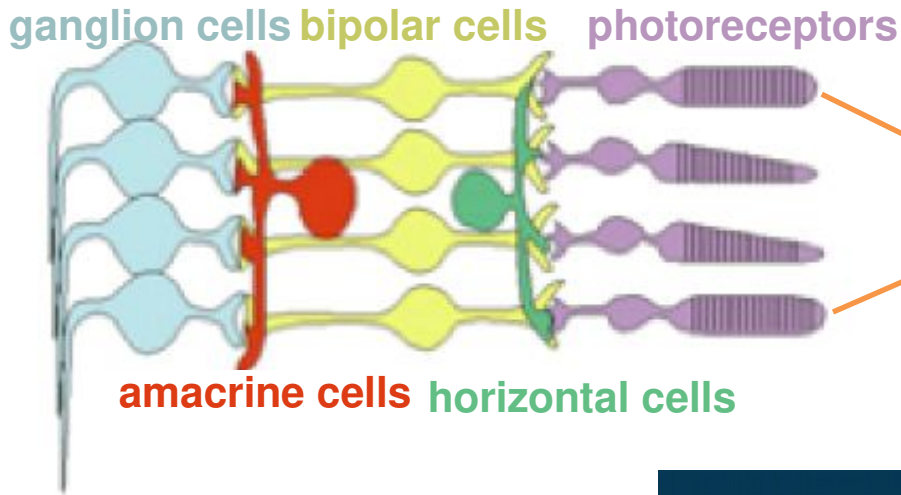

The visual system

Retina's layered structure

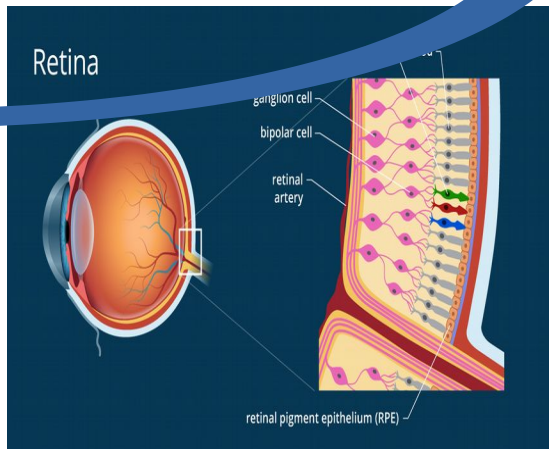
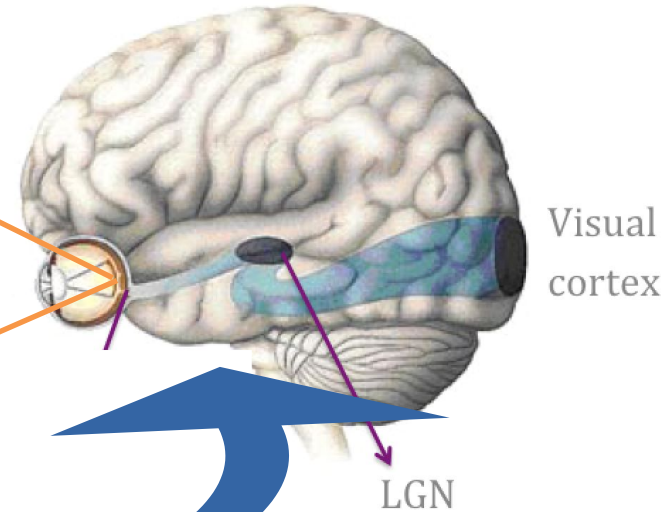
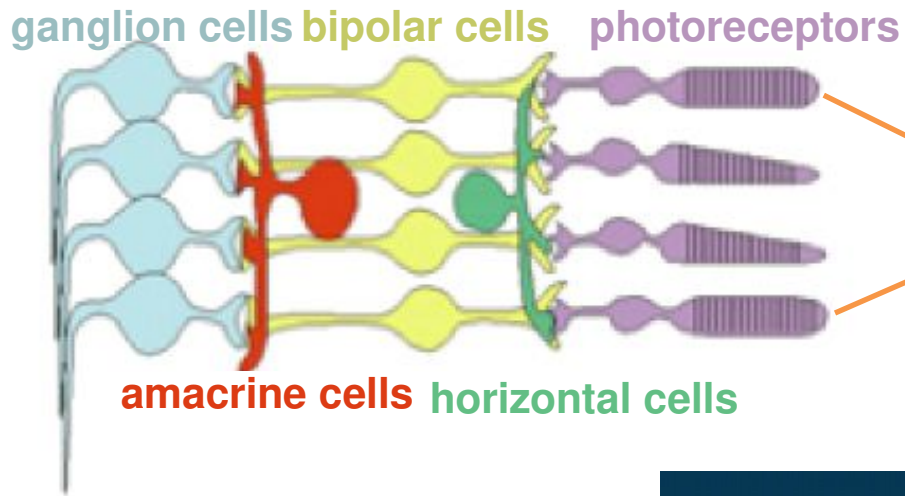

The visual system

Retina's layered structure

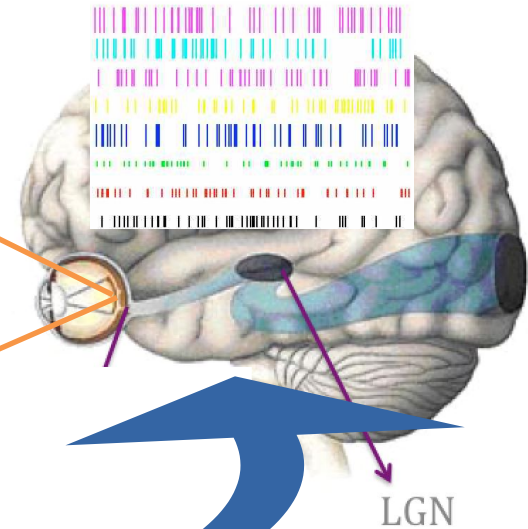
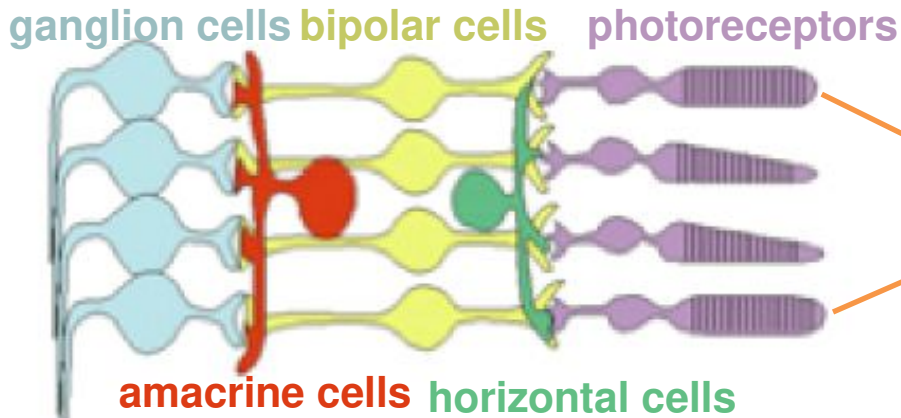

Visual cortex

LGN

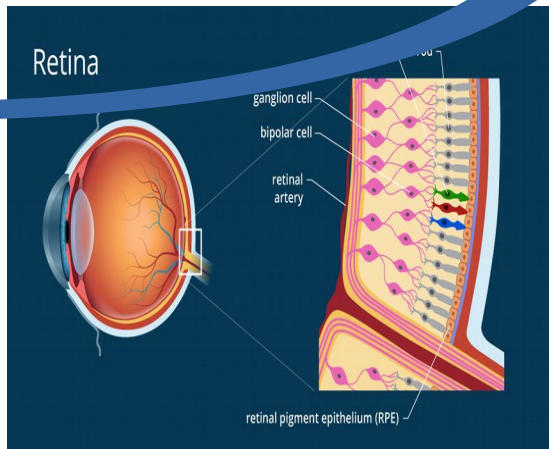
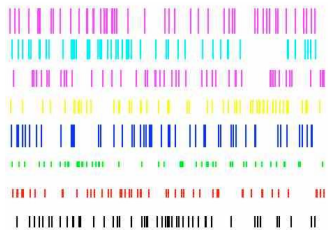

The visual system

Retina's layered structure

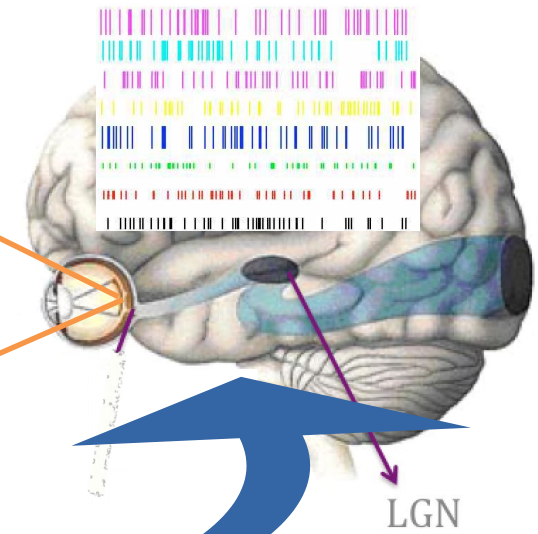
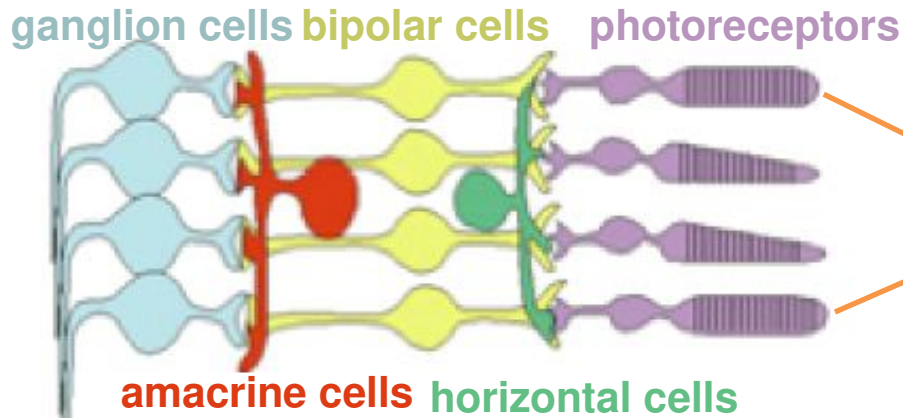

Visual cortex

LGN

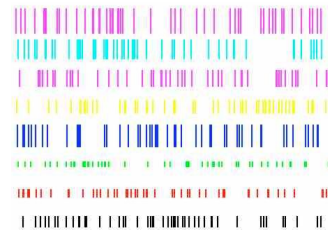

« Information » flux

The visual system

Encoder

Decoder

Retina's layered structure

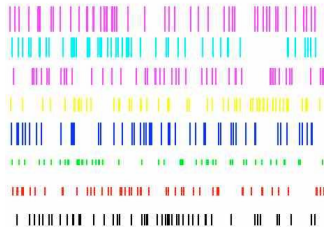
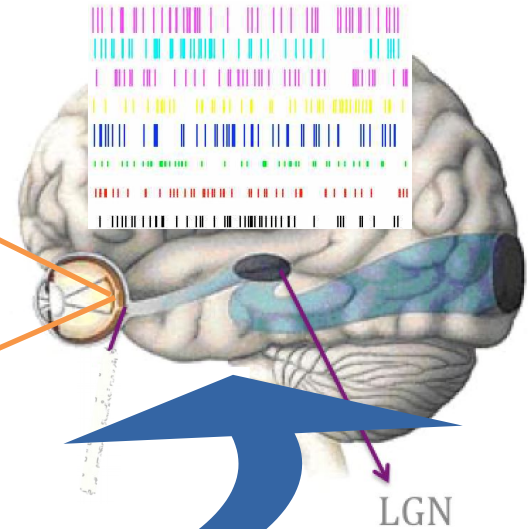
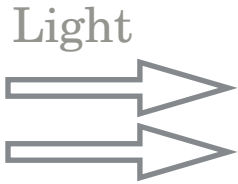
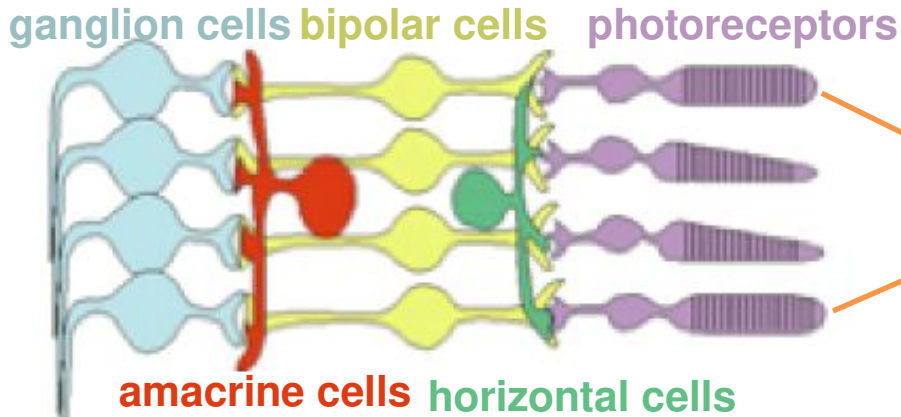

« Information » flux

The visual system

Encoder

Decoder

Retina's layered structure

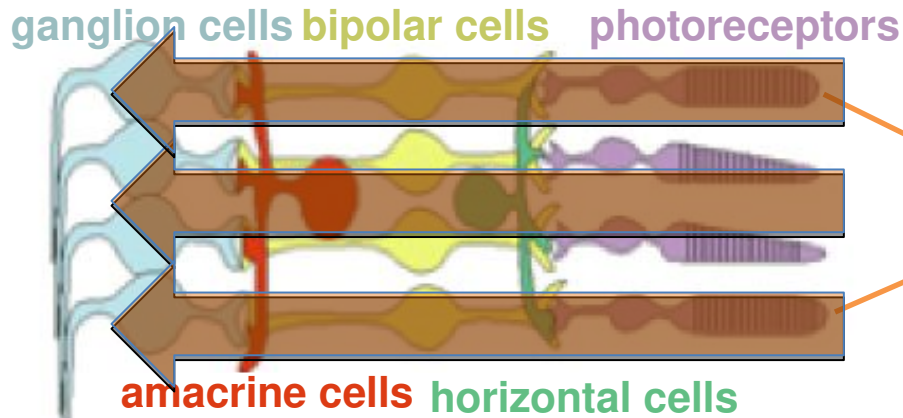

Light

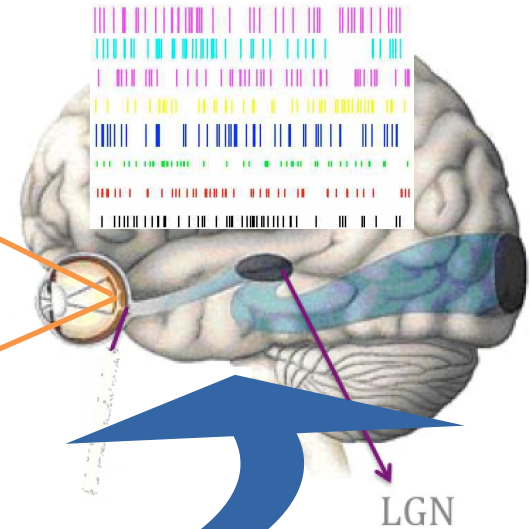

Visual cortex

LGN

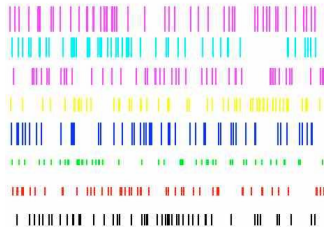

« Information » flux

The visual system

Encoder

Decoder

Retina's layered structure

ganglion cells bipolar cells photoreceptors

amacrine cells horizontal cells

Light

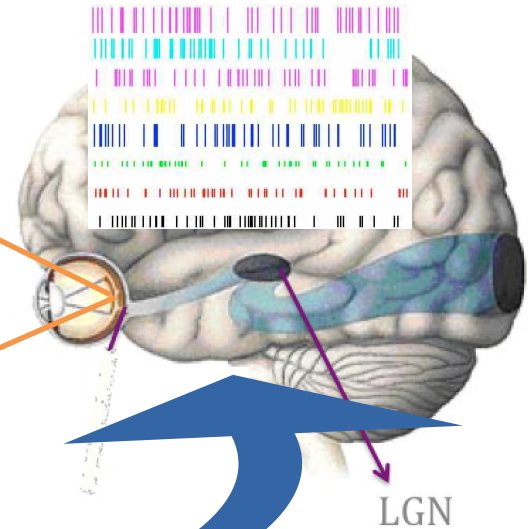
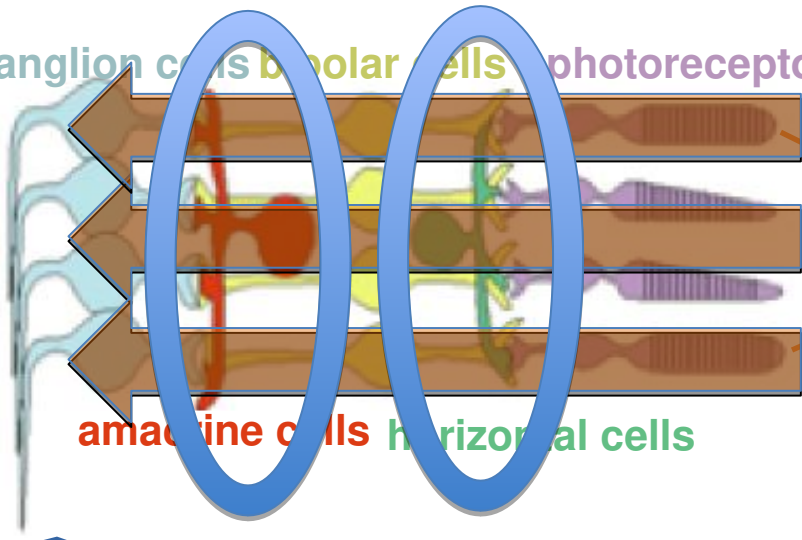
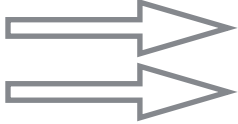

Visual cortex

LGN

« Information » flux

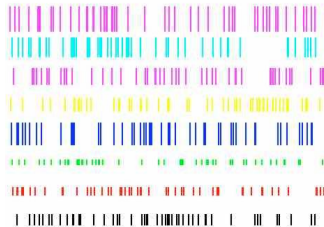

The visual system

Encoder

Decoder

Retina's layered structure

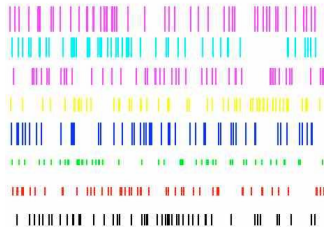
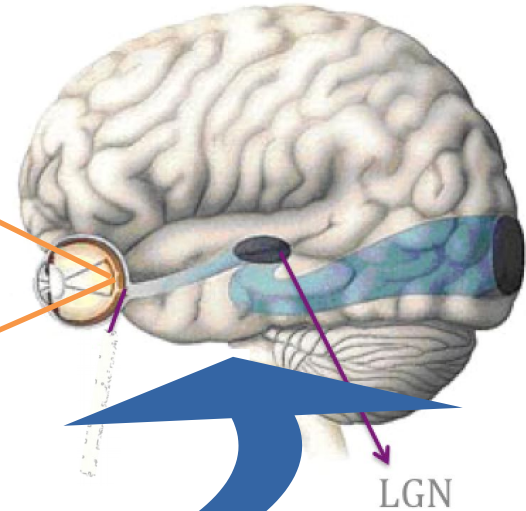
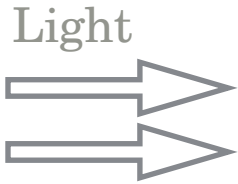
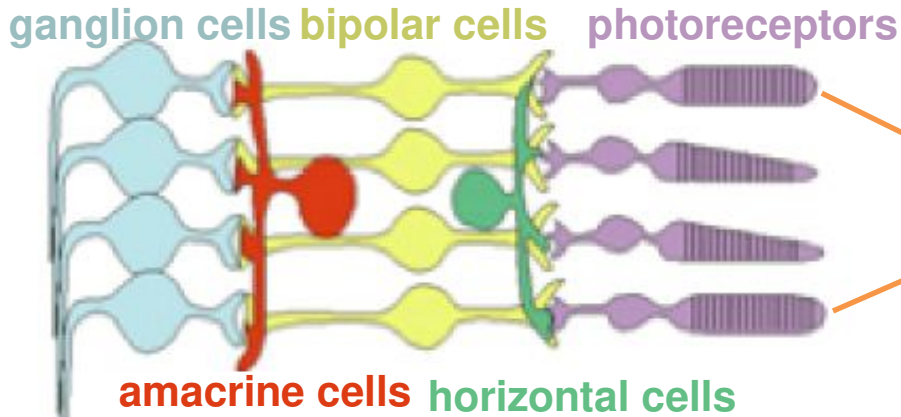

« Information » flux

The visual system

Retina's layered structure

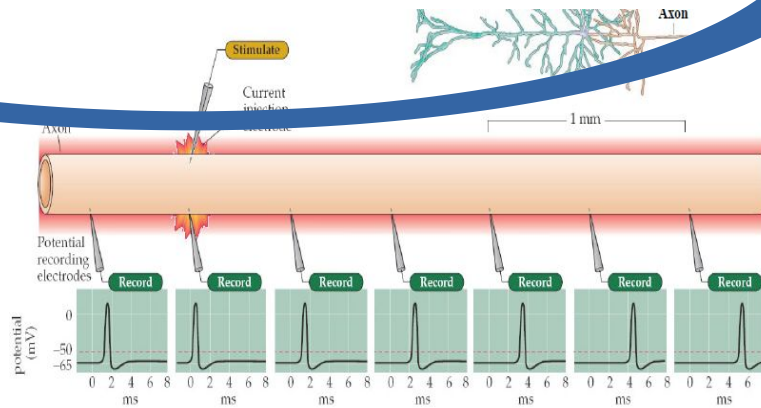
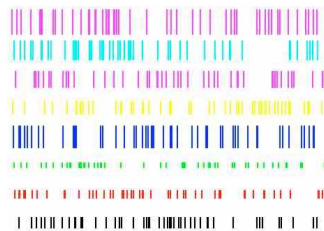
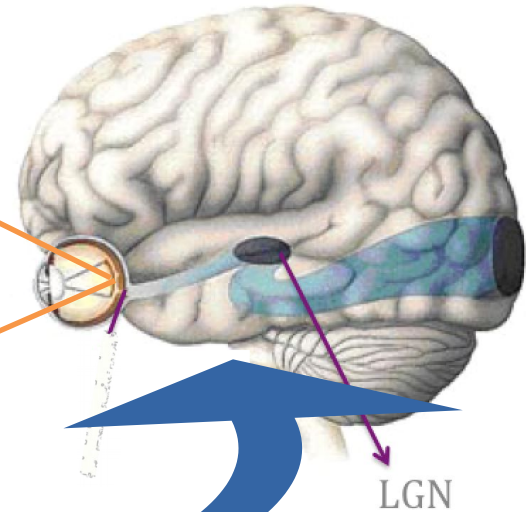
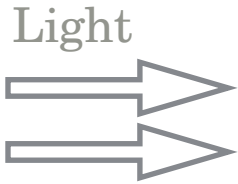
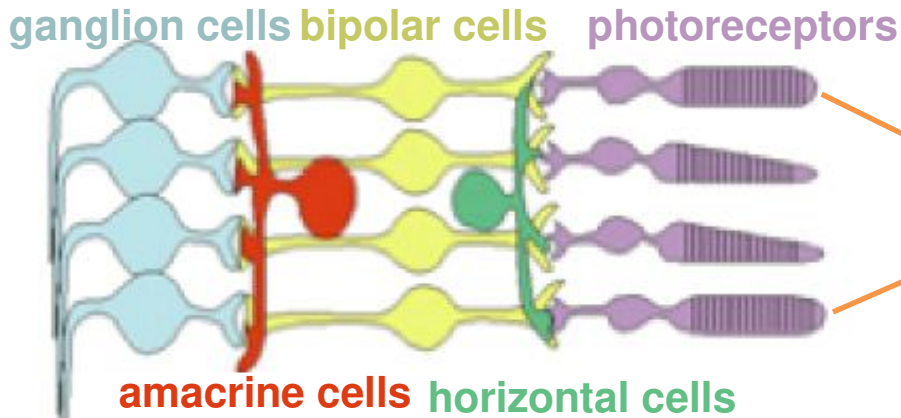

Active axonal conduction

The visual system

Retina's layered structure

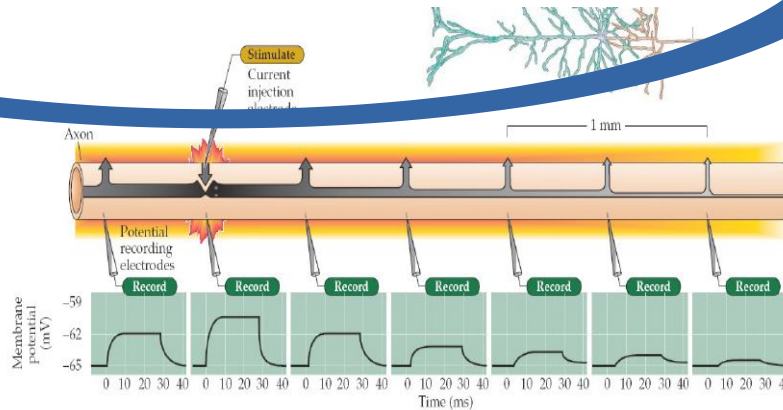
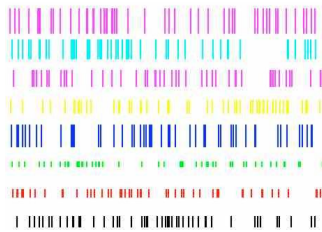
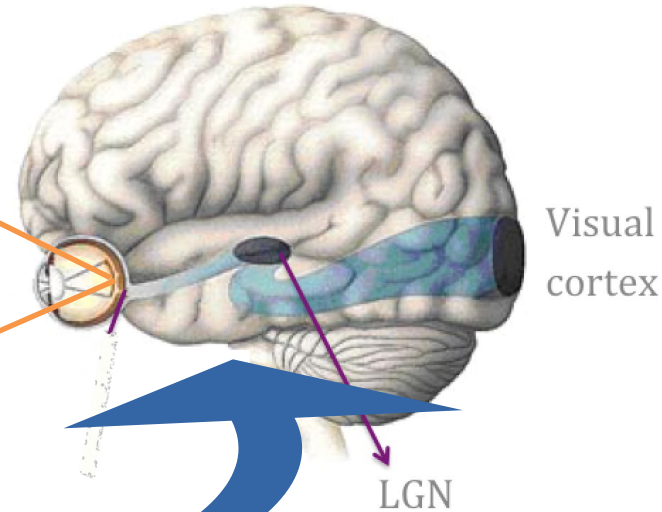
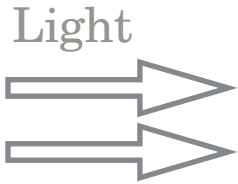
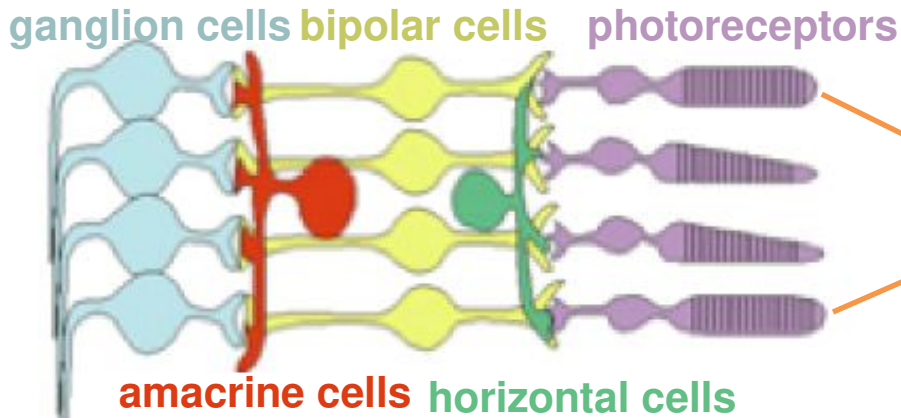

Passive
Ohmic
conduction

The visual system

Retina's layered structure

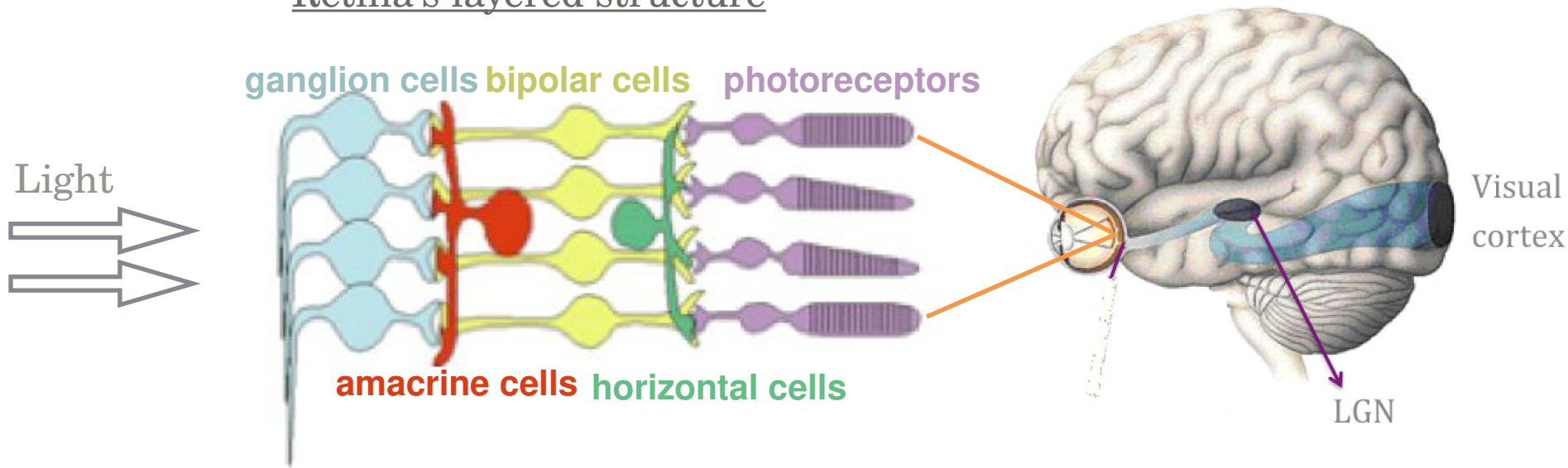

Most neurons in the retina do not spike (except Gcells) =>

« Analogic » computing.

The visual system

Retina's layered structure

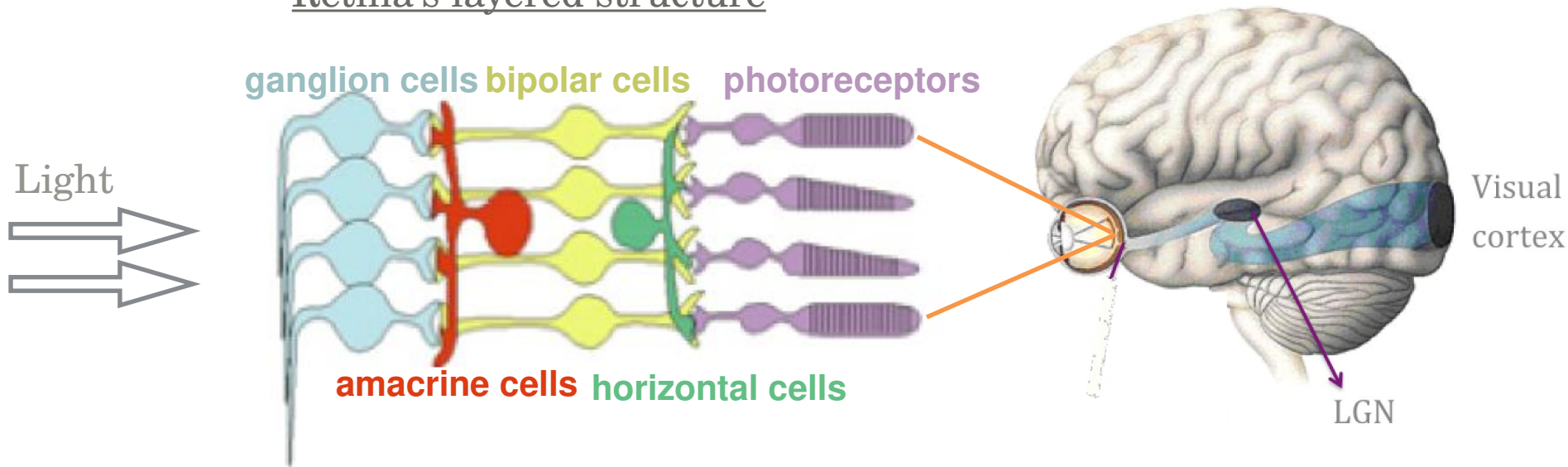

Most neurons in the retina do not spike (except Gcells) =>

« Analogic » computing.

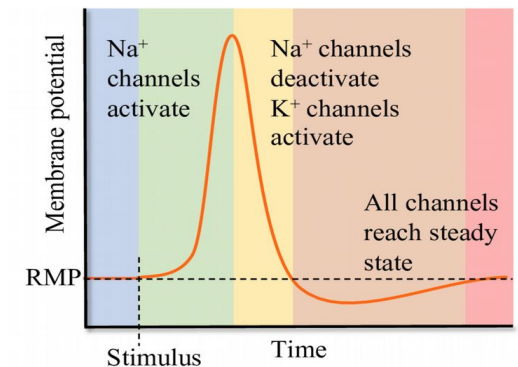

The visual system

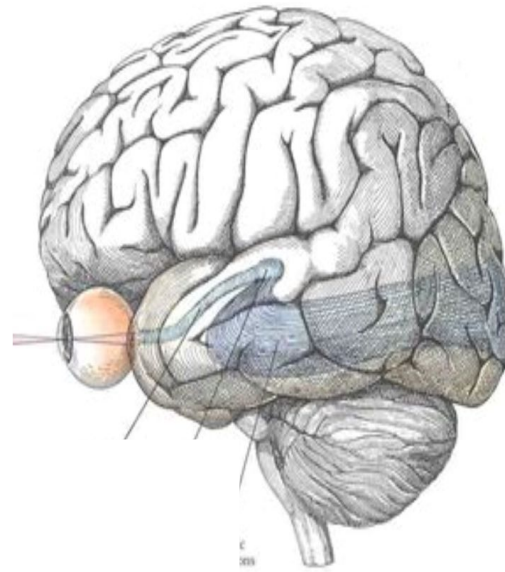

The visual system

Cortical columns

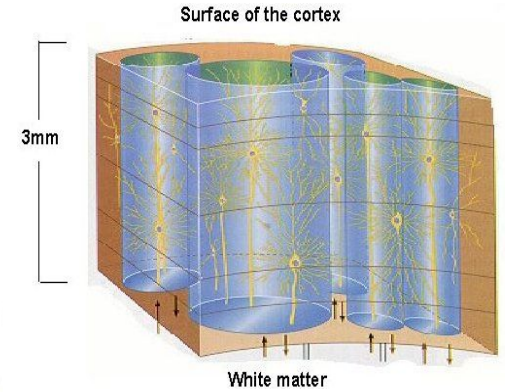
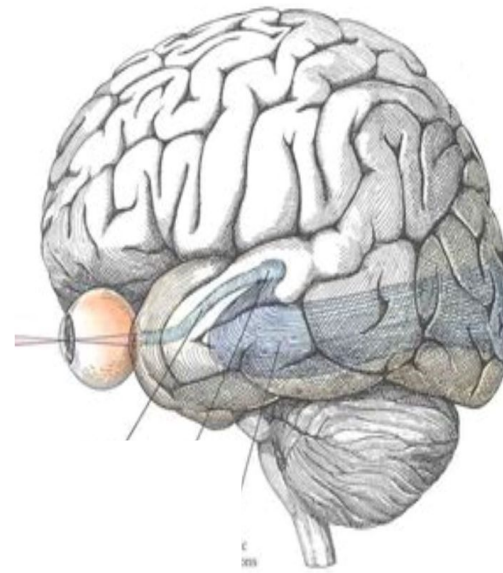

The visual system

Cortical columns

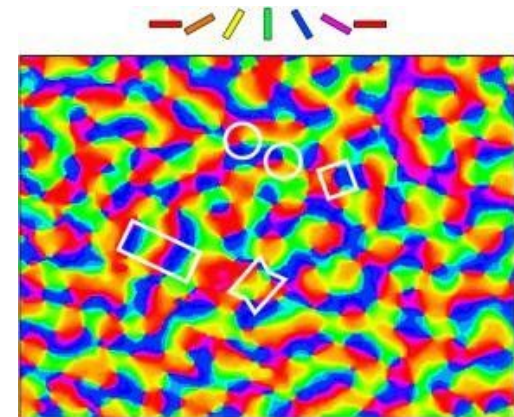
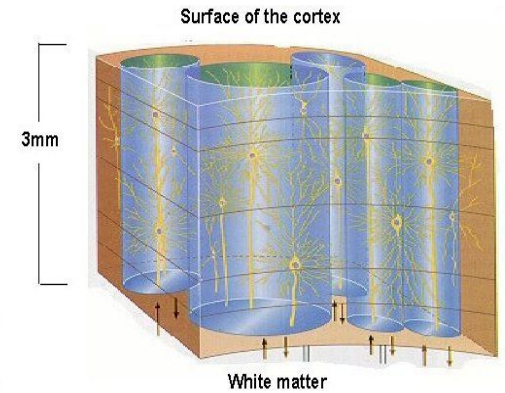
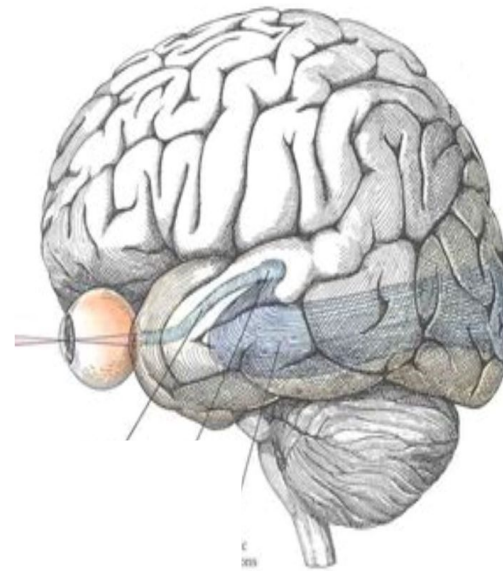

The visual system

Small cylinders, of diameter 0.1~1mm, crossing cortex layers, with about 10^3 - 10^4 neurons, from different types, strongly connected.

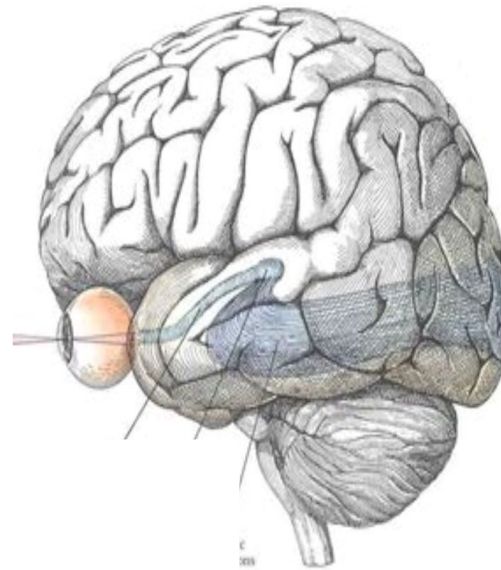

Cortical columns

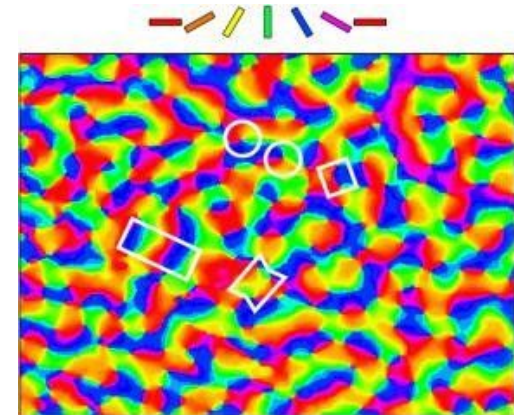
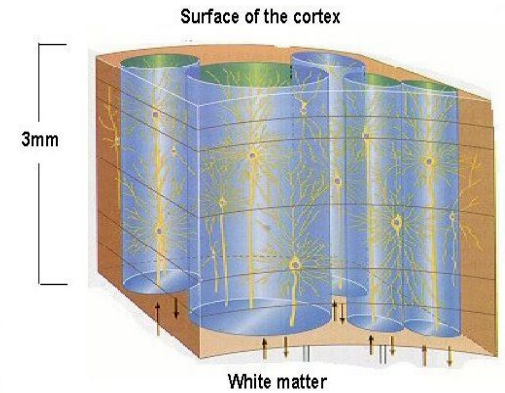

The visual system

Small cylinders, of diameter 0.1~1mm, crossing cortex layers, with about 10^3 - 10^4 neurons, from different types, strongly connected.

=>

« Field » mesoscopic description (mean-field, neural fields).

Individual neurons and synapses do not matter.

Population dynamics, PDEs, statistical physics, large deviations ...

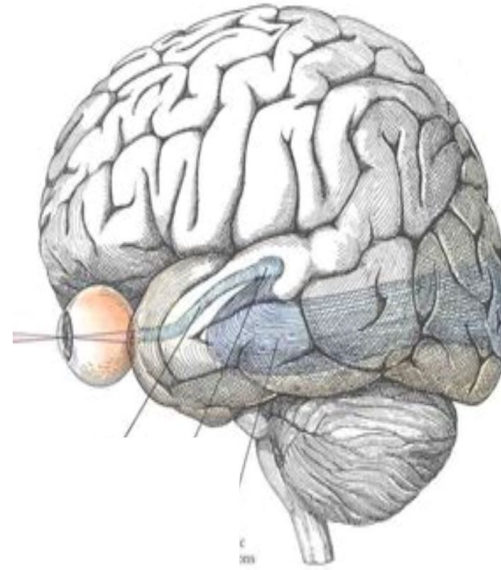

Cortical columns

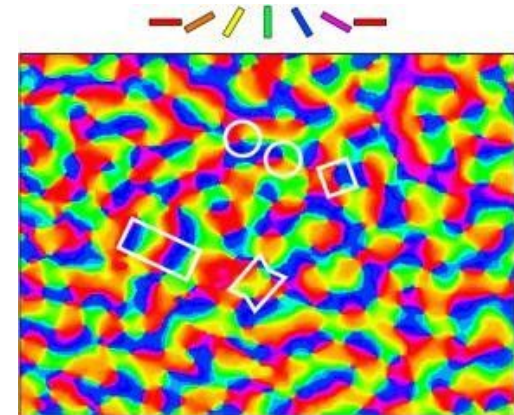
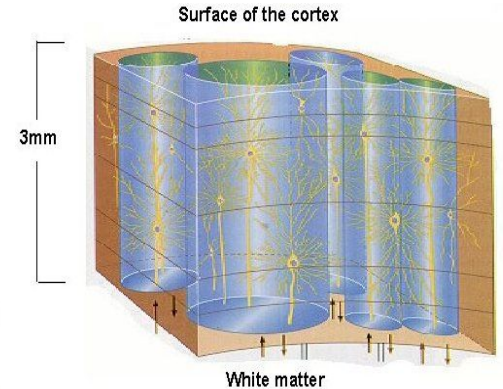

The visual system

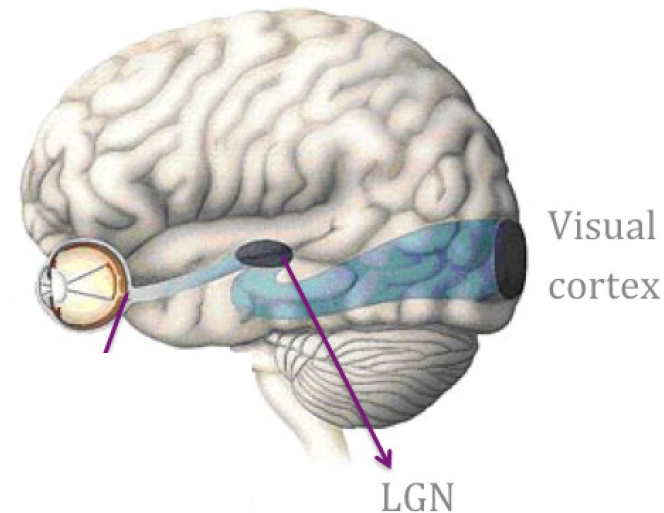

« Information » is processed by spikes.

Individual neurons and synapses do not matter.

Population dynamics, PDEs, statistical physics, large deviations ...

The visual system

Retina's layered structure

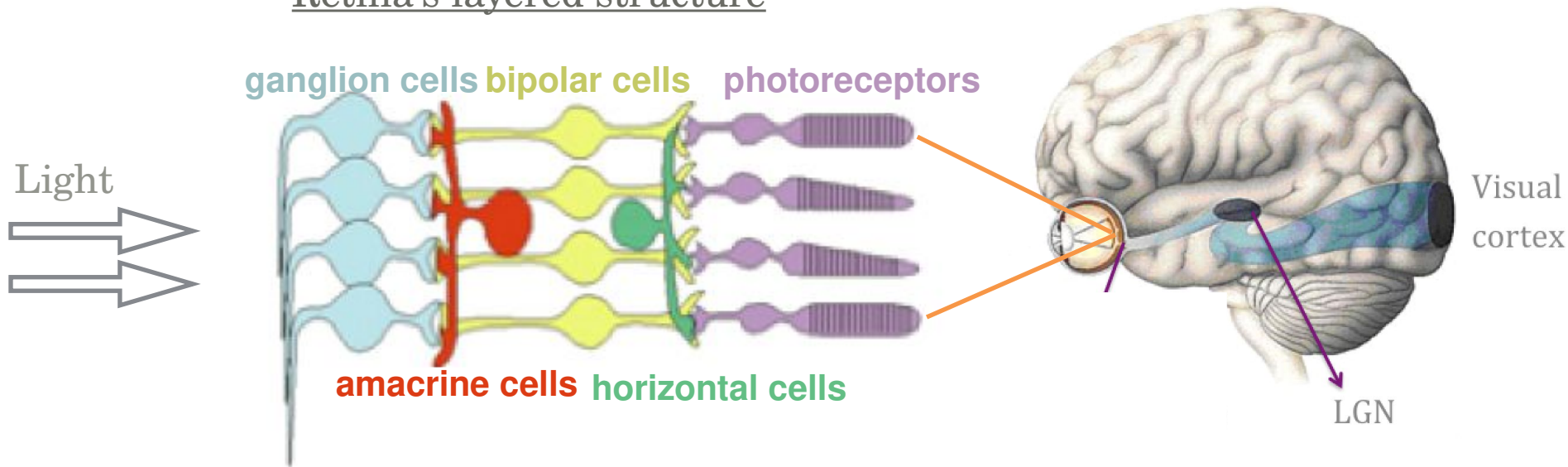

« Information » is processed by spikes.

Individual neurons and synapses do not matter.

Population dynamics, PDEs, statistical physics, large deviations ...

The visual system

Retina's layered structure

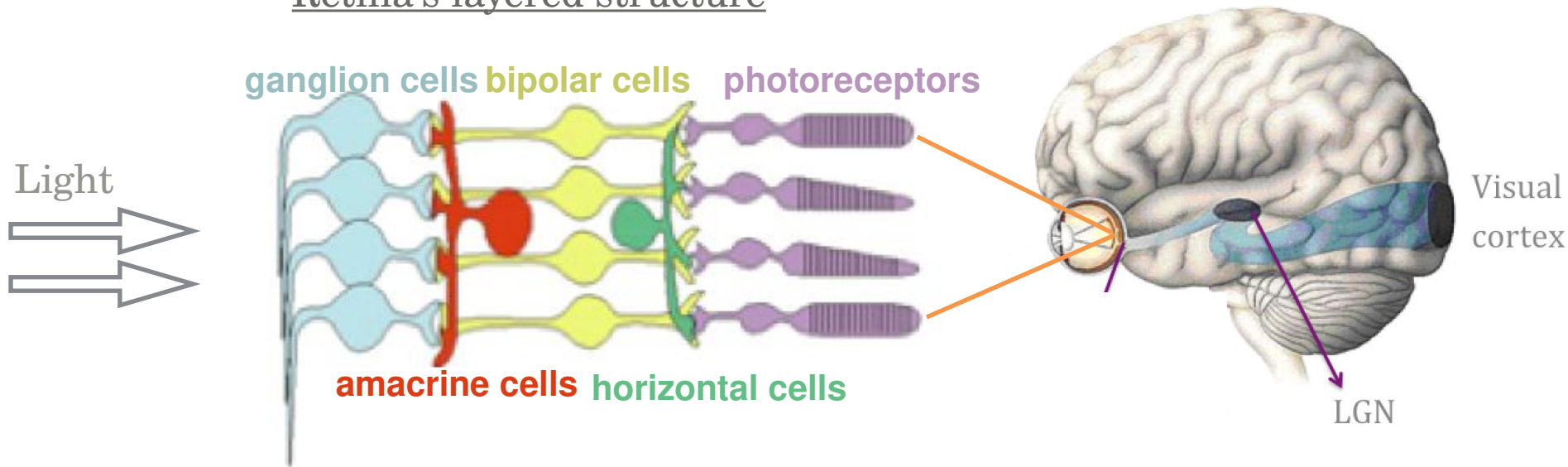

Analogic computing.

No spikes except at GCells

**Individual neurons and synapses
DO matter.**

**Dedicated circuits made of a few
neurons and synapses process the
local visual information.**

**« Information » is processed by
spikes.**

**Individual neurons and synapses do
not matter.**

**Population dynamics, PDEs,
statistical physics, large
deviations ...**

The visual system

Retina's layered structure

ganglion cells bipolar cells photoreceptors

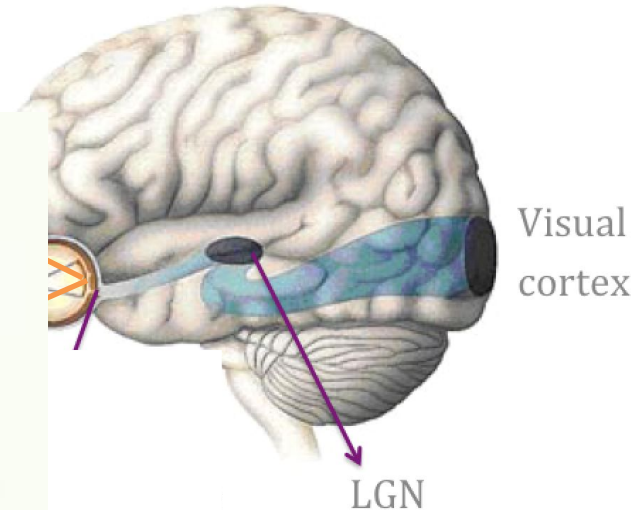
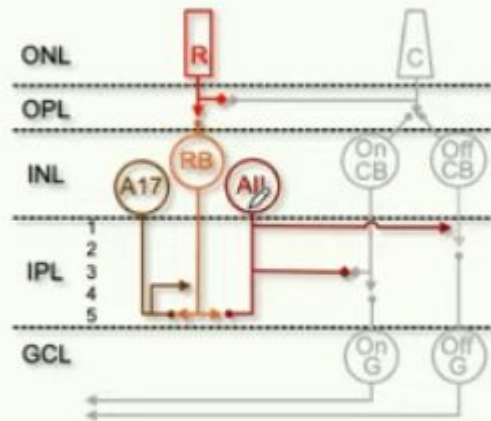
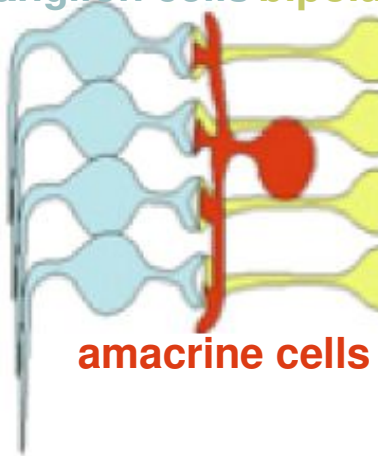
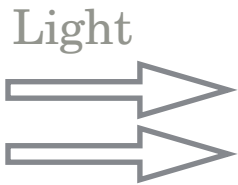

Analogic computing.

No spikes except at GCells

Individual neurons and synapses DO matter.

Dedicated circuits made of a few neurons and synapses process the local visual information.

**See J. Diamond talk at
<https://www.youtube.com/watch?v=sB29yq-ewYI&t=1036s>**

« Information » is processed by spikes.

Individual neurons and synapses do not matter.

Population dynamics, PDEs, statistical physics, large deviations ...

The visual system

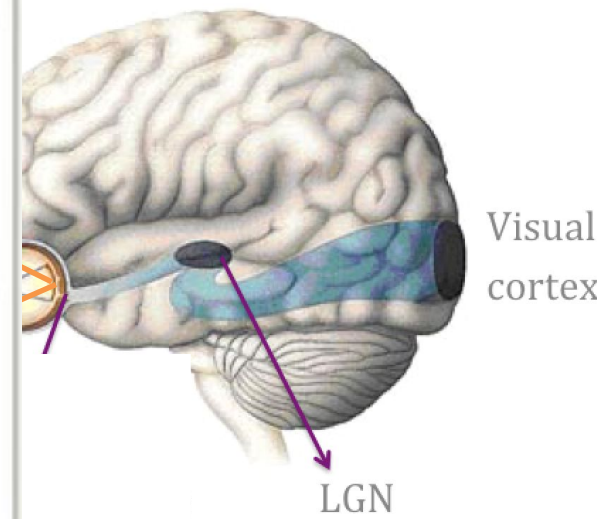
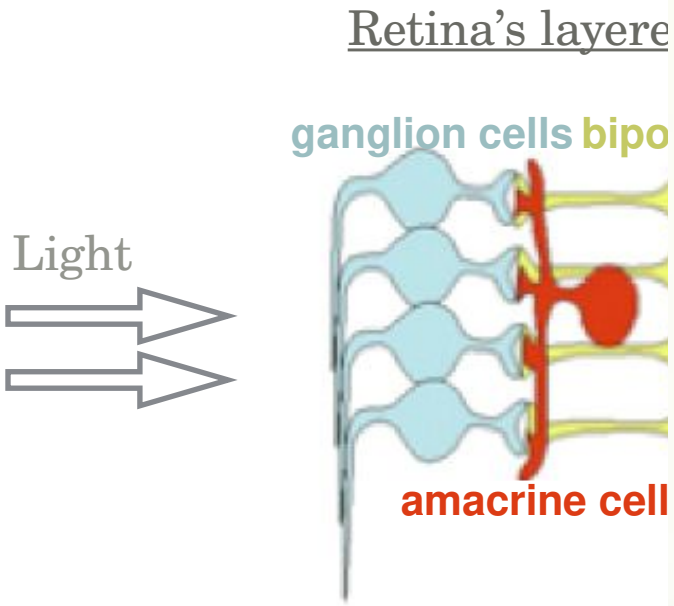

Analogic computing.
 No spikes except at GCells
 Individual neurons and synapses DO matter.
 Dedicated circuits made of a few neurons and synapses process the local visual information.

See J. Diamond talk at
<https://www.youtube.com/watch?v=sB29yq-ewYI&t=1036s>

Information is processed by spikes.
 Individual neurons and synapses do not matter.
 Population dynamics, PDEs, statistical physics, large deviations ...

The visual system

Retina's layered structure

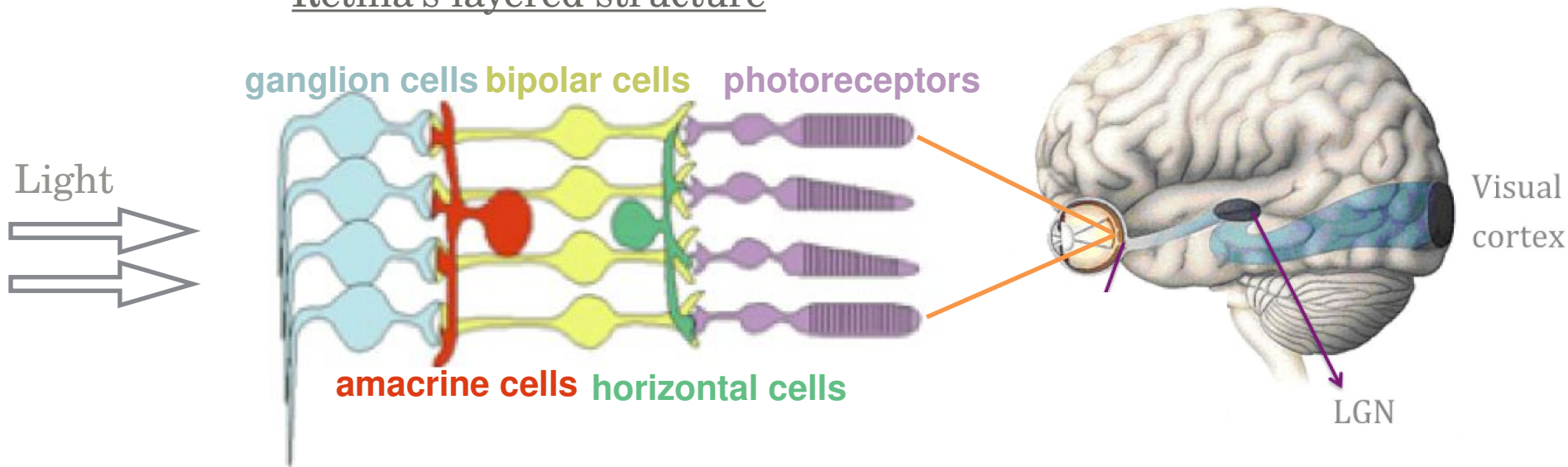

Analogic computing.

No spikes except at GCells

**Individual neurons and synapses
DO matter.**

**Dedicated circuits made of a few
neurons and synapses process the
local visual information.**

**« Information » is processed by
spikes.**

**Individual neurons and synapses do
not matter.**

**Population dynamics, PDEs,
statistical physics, large
deviations ...**

A modeller point of view

1. The retina is a ***high dimensional, non autonomous and noisy*** dynamical system, layered and structured, with ***non stationary and spatially inhomogeneous entries*** (visual scenes).
-

A modeller point of view

1. The retina is a ***high dimensional, non autonomous and noisy*** dynamical system, layered and structured, with ***non stationary and spatially inhomogeneous entries*** (visual scenes).
2. ***Local circuits*** of non linear cells, connected with non linear synapses efficiently process the ***local visual information***. These local circuits are connected together, spanning the whole retina in a ***regular tiling***.

A modeller point of view

1. The retina is a ***high dimensional, non autonomous and noisy*** dynamical system, layered and structured, with ***non stationary and spatially inhomogeneous entries*** (visual scenes).
 2. ***Local circuits*** of non linear cells, connected with non linear synapses efficiently process the ***local visual information***. These local circuits are connected together, spanning the whole retina in a ***regular tiling***.
 3. The conjunction of non linearities and regular structure can produce a highly ***disordered spatio-temporal*** dynamics.
-

A modeller point of view

1. The retina is a ***high dimensional, non autonomous and noisy*** dynamical system, layered and structured, with ***non stationary and spatially inhomogeneous entries*** (visual scenes).
2. ***Local circuits*** of non linear cells, connected with non linear synapses efficiently process the ***local visual information***. These local circuits are connected together, spanning the whole retina in a ***regular tiling***.
3. The conjunction of non linearities and regular structure can produce a highly ***disordered spatio-temporal*** dynamics.
4. The retina is sensitive to ***changes in its physiology*** (development, pharmacology, pathologies). These changes can be addressed from the point of view of ***bifurcations theory***.

The Biovision lab

Understanding the normal visual system at neuronal and perceptual levels

- *Better understanding the early visual system*
- *Reading, moving, behaving in 3D virtual environments*
- *Analysis of visual media and user perception*

Understanding the impact of low vision at neuronal and perceptual levels

- *Modeling of retinal prostheses stimulation and cortical responses*
- *Understanding eccentric vision pointing for selection and identification*
- *Understanding low vision impact on attentional and oculo-motor behaviors when reading*
- *Attentional and behavioural studies using virtual reality*

Diagnosis, rehabilitation, and low vision aids

- *Exploring new solutions for diagnosis*
- *Designing rehabilitation methods in virtual reality (VR)*
- *Developing innovative vision-aid digital systems*

Retinal waves

Random dynamical structures in the
developing visual system

D. Karvouniari (PhD 2014-2018), Biovision team, INRIA, Sophia Antipolis

L. Gil, InPhyNi, Nice-Sophia-Antipolis

O. Marre, Institut de la Vision, Paris

S. Picaud, Institut de la Vision, Paris

B. Cessac, Biovision team, INRIA, Sophia Antipolis

Acknowledgement: M. Hennig (U. Edinburgh), E. Sernagor (U. Newcastle).

The structure of the adult retina

Retina's layered structure

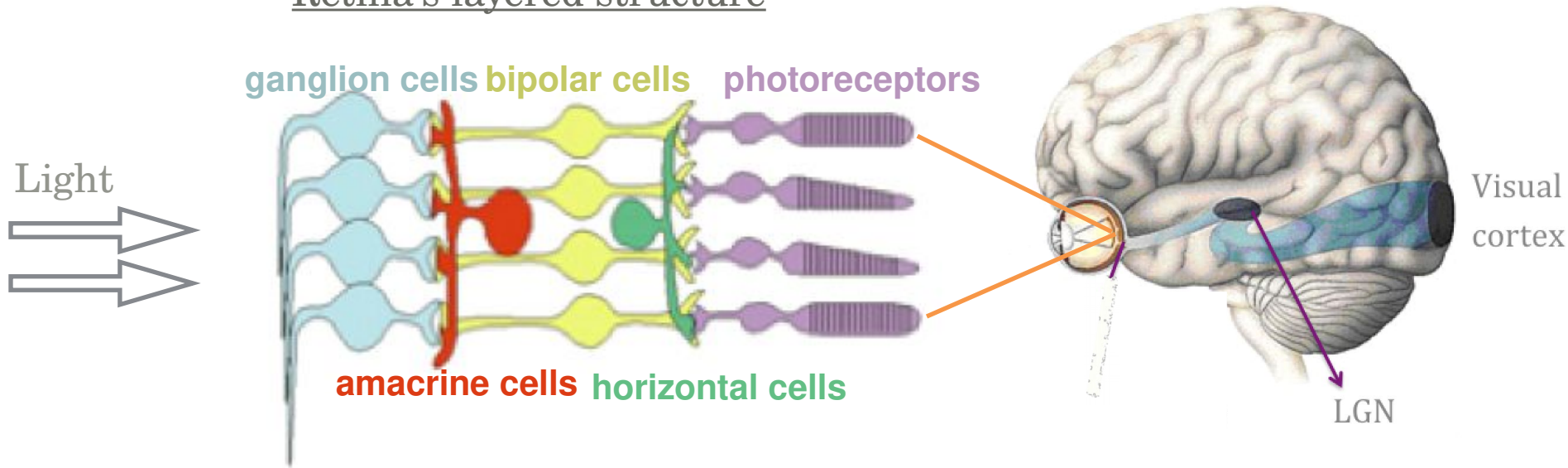

The structure of the retina during development

Retina's layered structure
is shaped during development

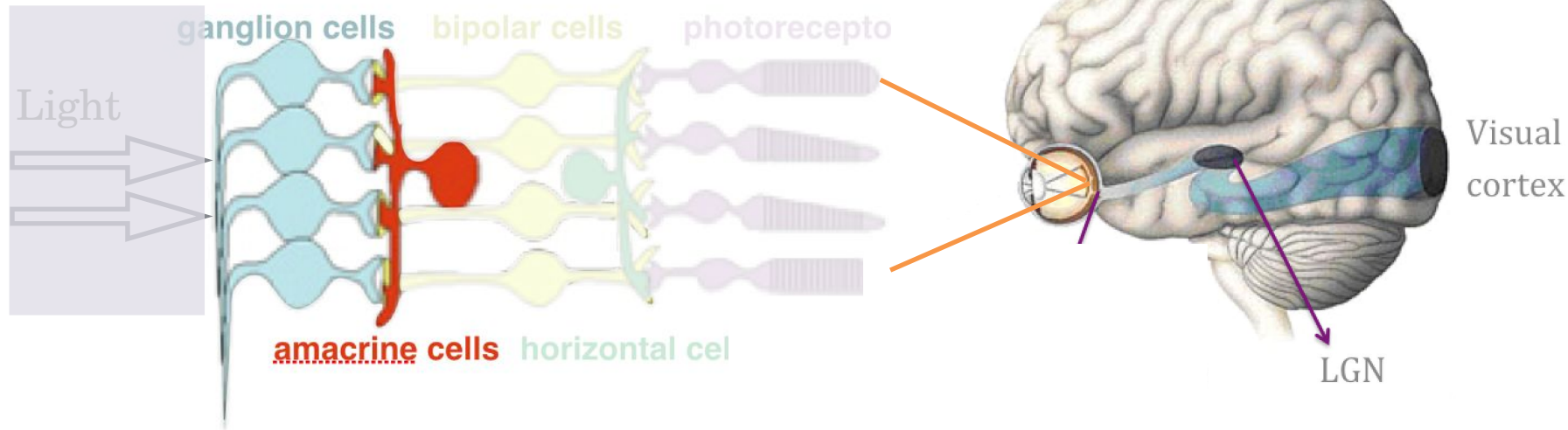

But How?



Retinal waves!

Retinal waves

Spontaneous spatio-temporal waves during development
Disappear short after birth
when vision is functional

Recordings from the retina

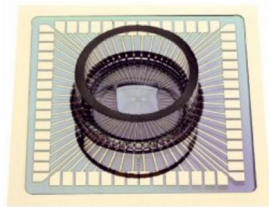
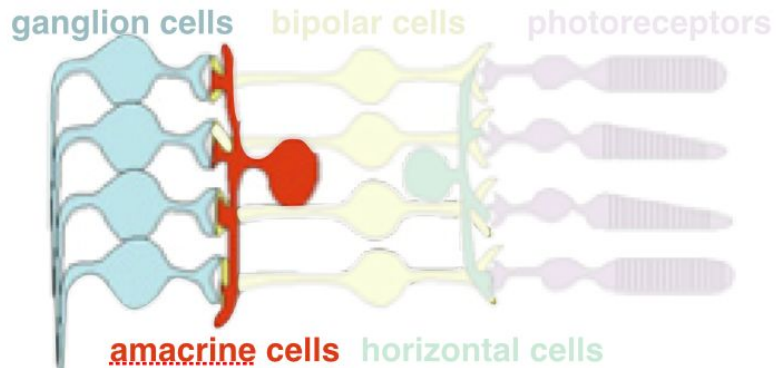

Multi-electrode array (MEA)

MEA recording of the voltage from a mouse retina (courtesy E Sernagor).

Stages of Retinal Waves During Development

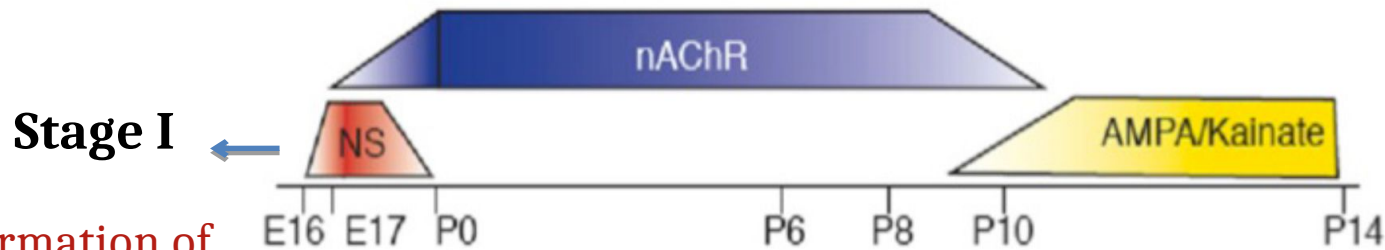

- Formation of retina circuitry
- Chemical synapses not formed yet
- Gap junction-mediated

Stages of Retinal Waves During Development

Stage II

- Retinotopic mapping
- Nicotinic Acetylcholine Receptors (nAChR)

Stage I

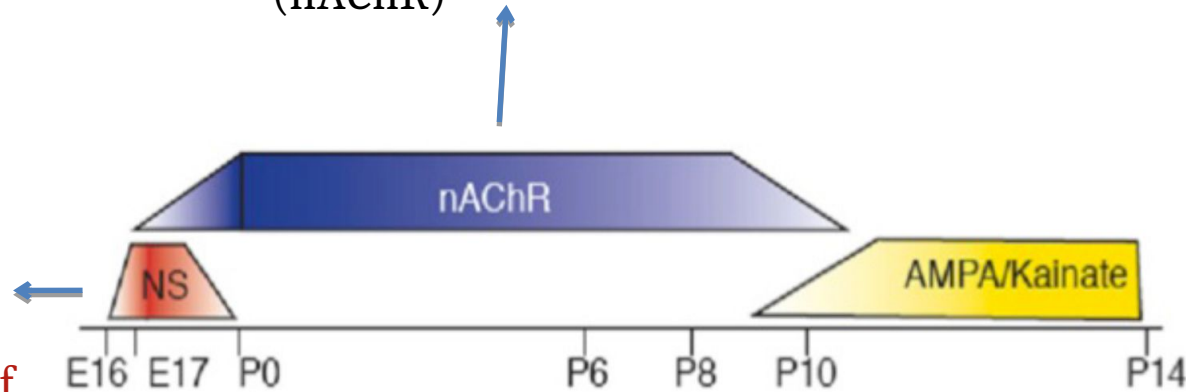

- Formation of retina circuitry
- Chemical synapses not formed yet
- Gap junction-mediated

Stages of Retinal Waves During Development

Stage II

- Retinotopic mapping
- Nicotinic Acetylcholine Receptors (nAChR)

Stage III

- Disappear when vision is functional
- Glutamate – AMPA receptors

Stage I

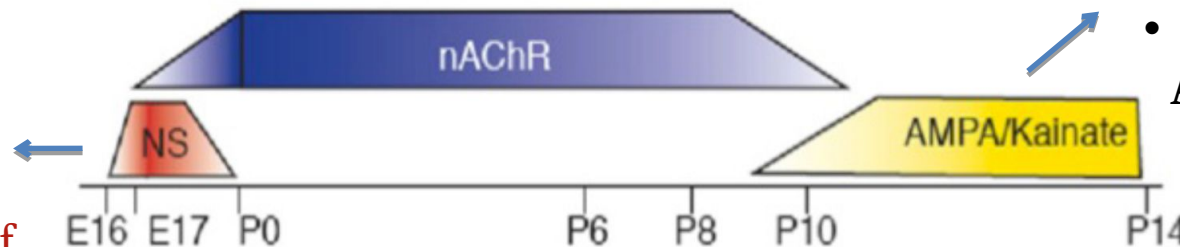

- Formation of retina circuitry
- Chemical synapses not formed yet
- Gap junction-mediated

Variability within retinal waves

i) Across species

Godfrey et al. 2007

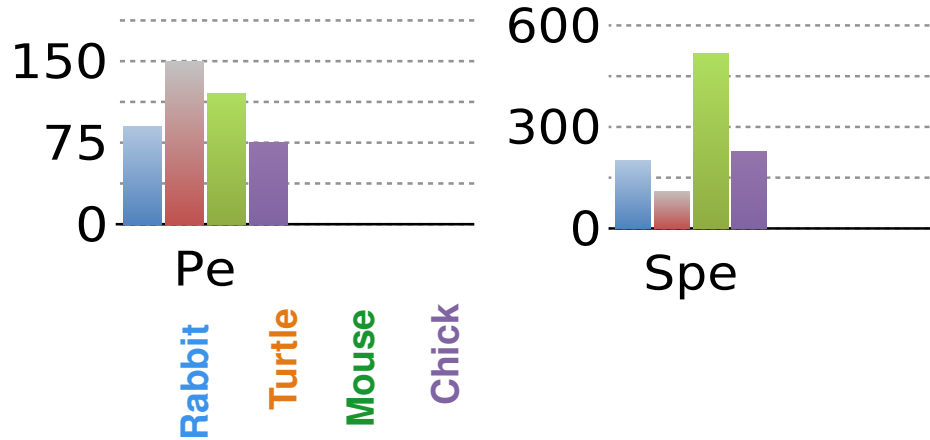

Variability within retinal waves

i) Across species

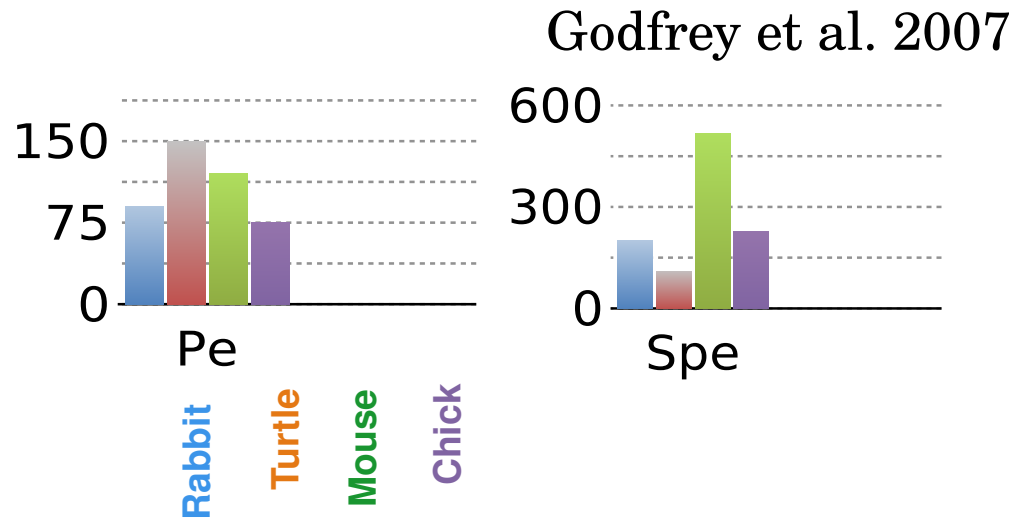

ii) Development

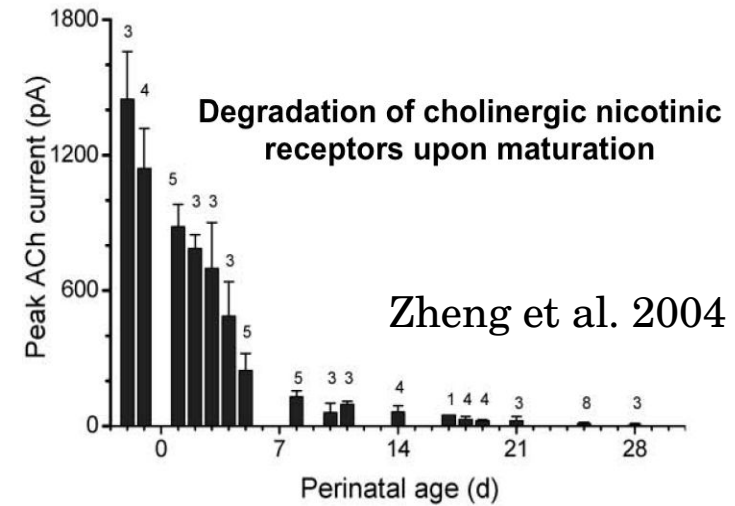

Variability within retinal waves

i) Across species

Godfrey et al. 2007

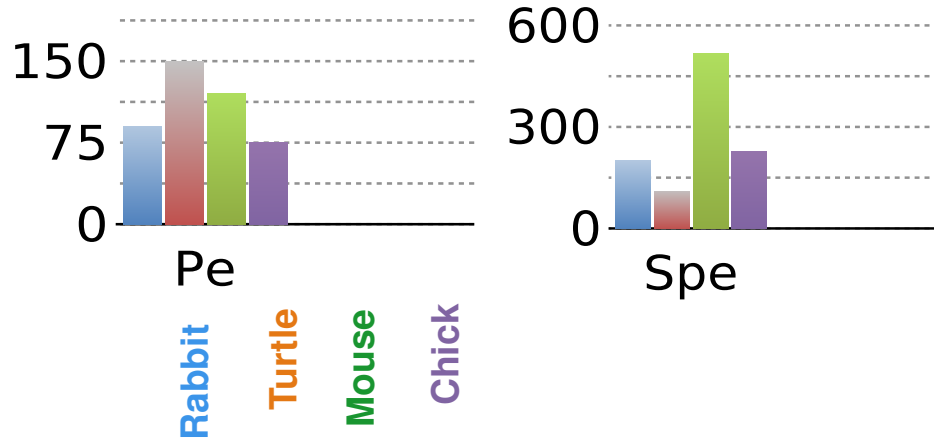

ii) Development

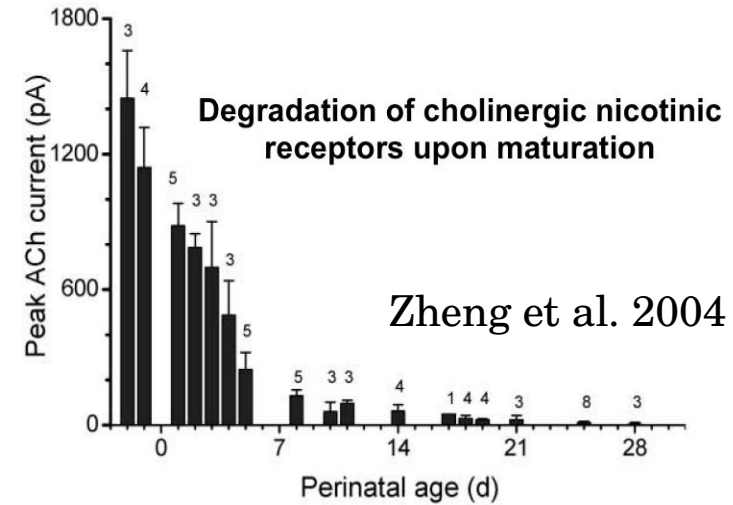

iii) Pharmacology

P4

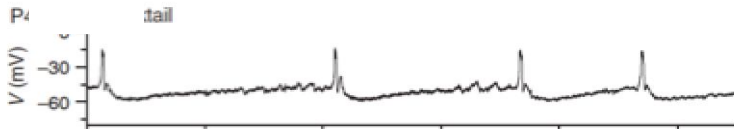

P8

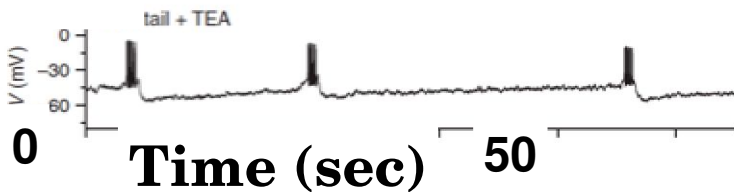

Variability within retinal waves

i) Across species

Godfrey et al. 2007

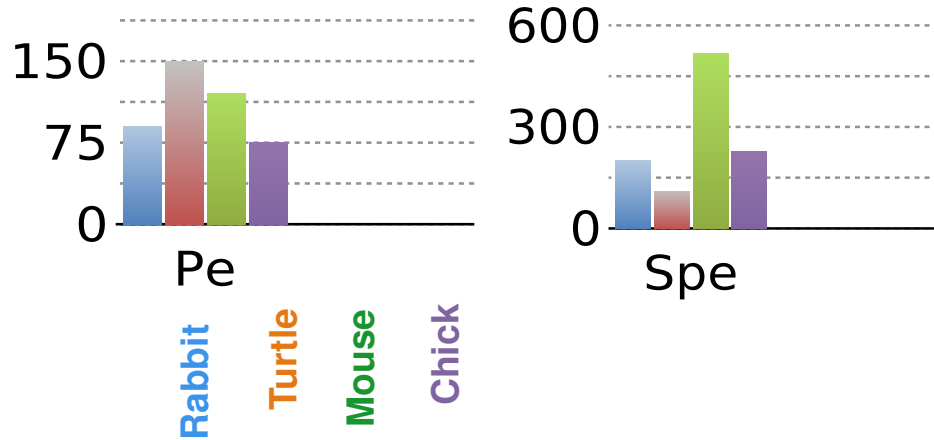

ii) Development

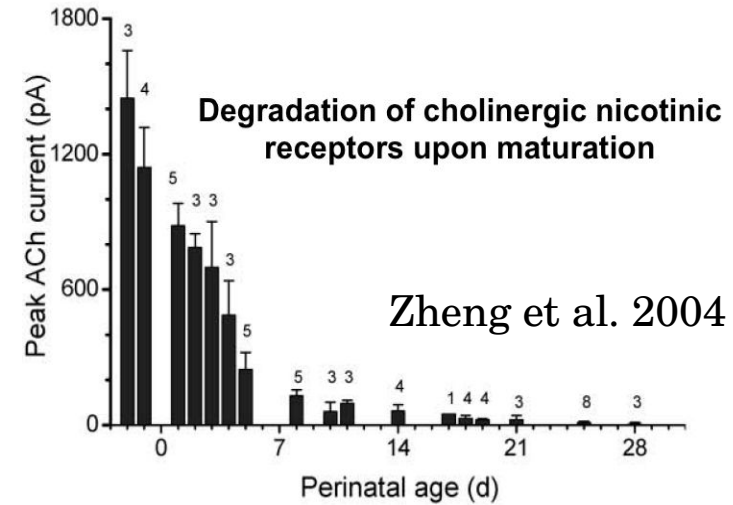

iii) Pharmacology

P4

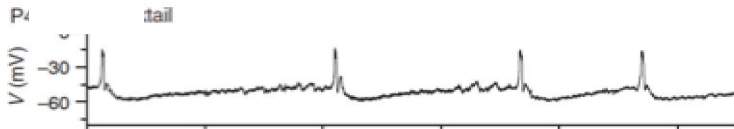

P8



0 Time (sec) 50

iv) Spatial Variability

Variability within retinal waves

i) Across species

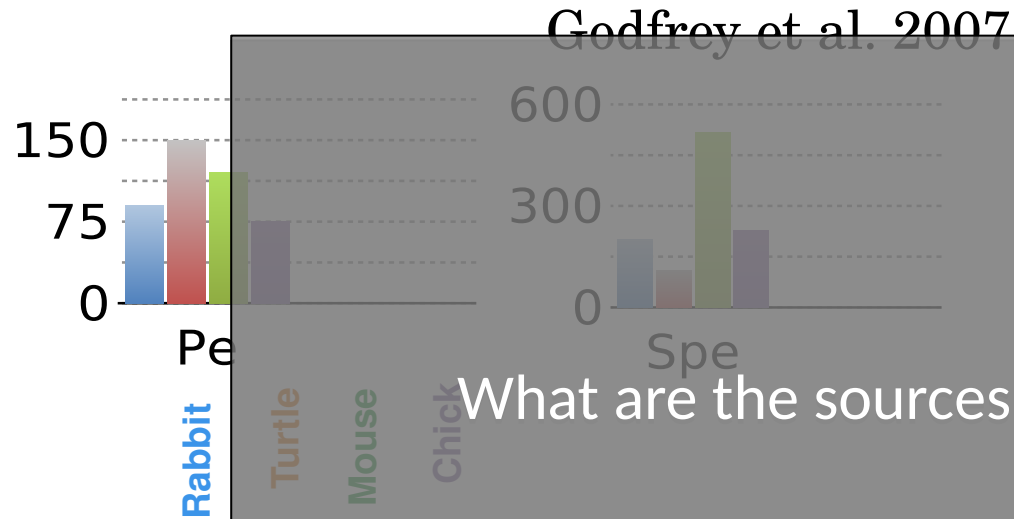

ii) Development

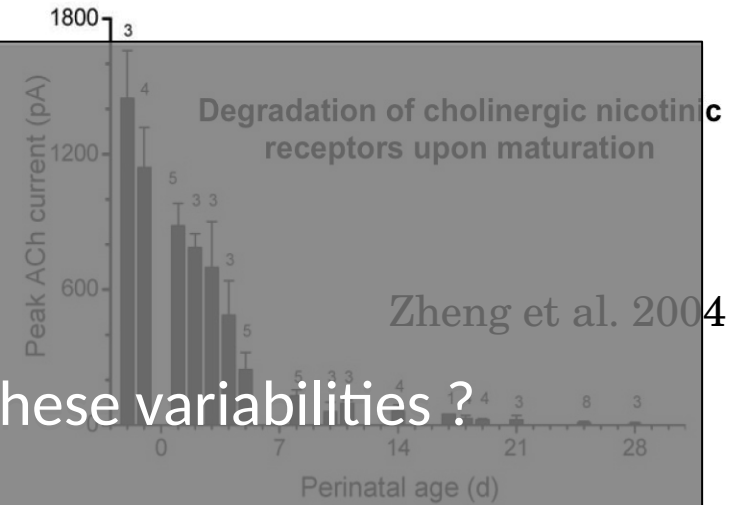

What are the sources of these variabilities?

iii) Pharmacology

P4



P8

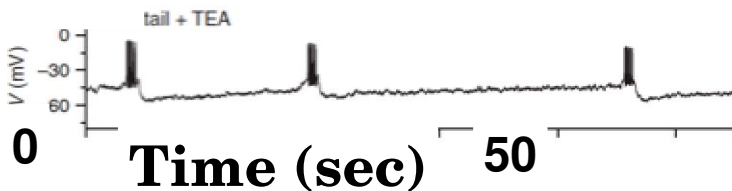

iv) Spatial Variability

Is there a unique, global, mechanism explaining them?

Focus on stage II retinal waves

Stage II retinal waves are well studied experimentally and there is already existing work on their modeling

**Stage II
(cholinergic
retinal waves)**

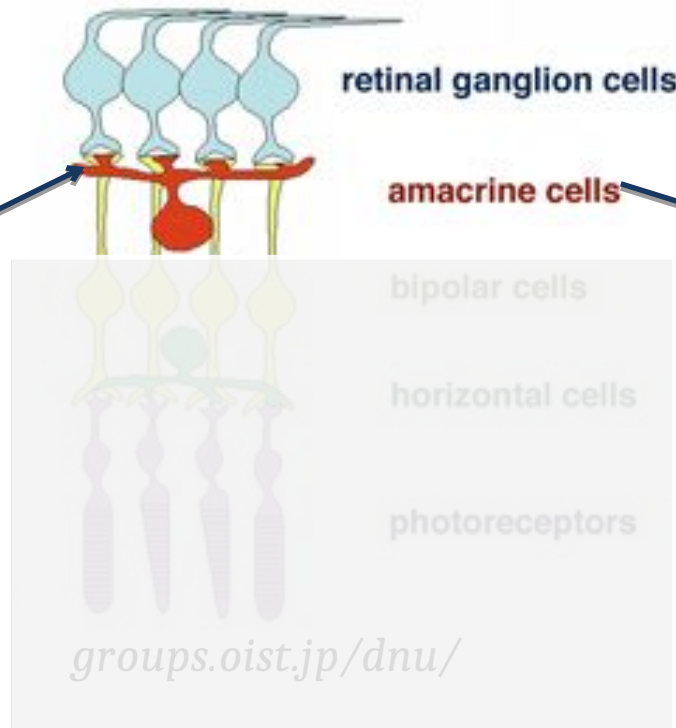

Starburst Amacrine Cell (SAC)

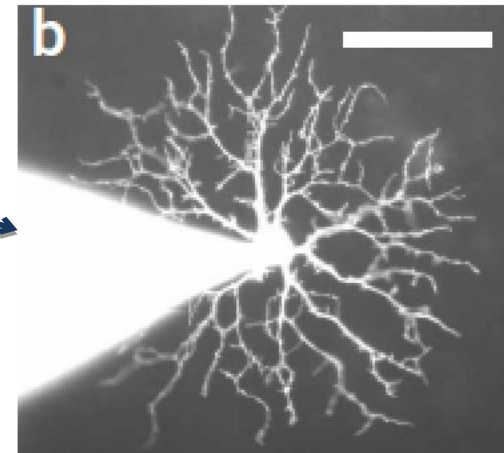

Zheng et al. 2006

Experiments for the emergence of retinal waves

Retinal waves require three components:

- i) Spontaneous bursting activity

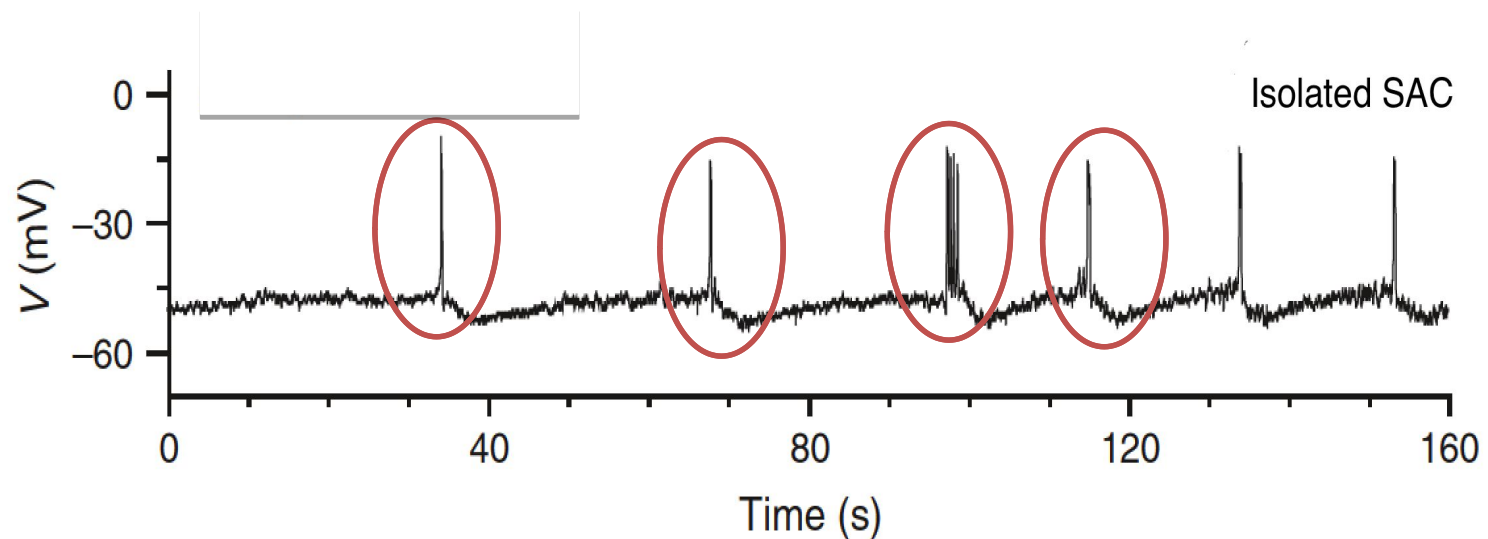

Experiment for isolated neurons,
Zheng et al., 2006, Nature

Experiments for the emergence of retinal waves

Retinal waves require three components:

- i) Spontaneous bursting activity
- ii) Refractory mechanism (slow After HyperPolarisation- sAHP)

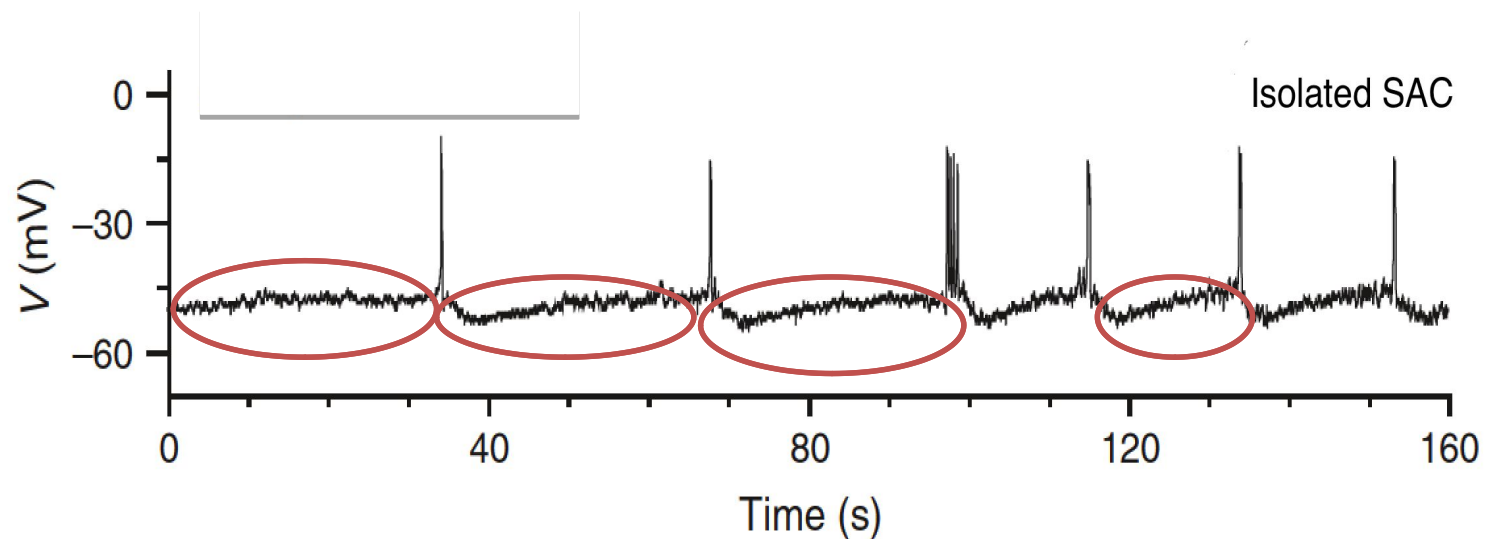

Experiment for isolated neurons,
Zheng et al., 2006, Nature

Experiments for the emergence of retinal waves

Retinal waves require three components:

- i) Spontaneous bursting activity
- ii) Refractory mechanism (slow After HyperPolarisation- sAHP)
- iii) Coupling (through Acetylcholine neurotransmitter)

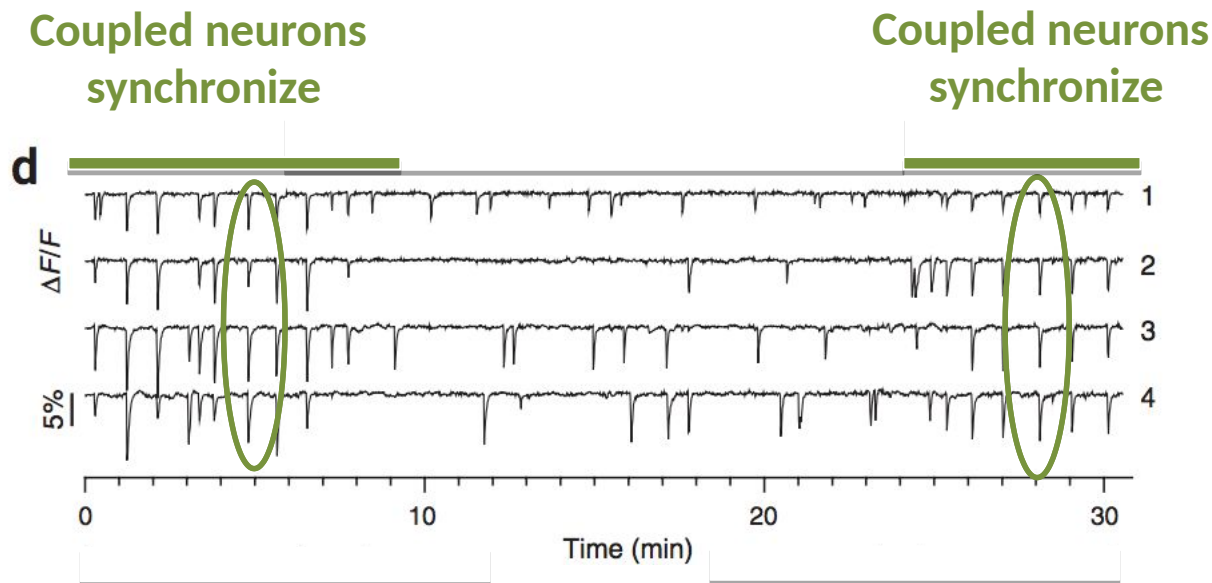

Experiment for coupled and isolated neurons, Zheng et al., 2006, Nature

Experiments for the emergence of retinal waves

Retinal waves require three components:

- i) Spontaneous bursting activity
- ii) Refractory mechanism (slow After HyperPolarisation- sAHP)
- iii) Coupling (through Acetylcholine neurotransmitter)

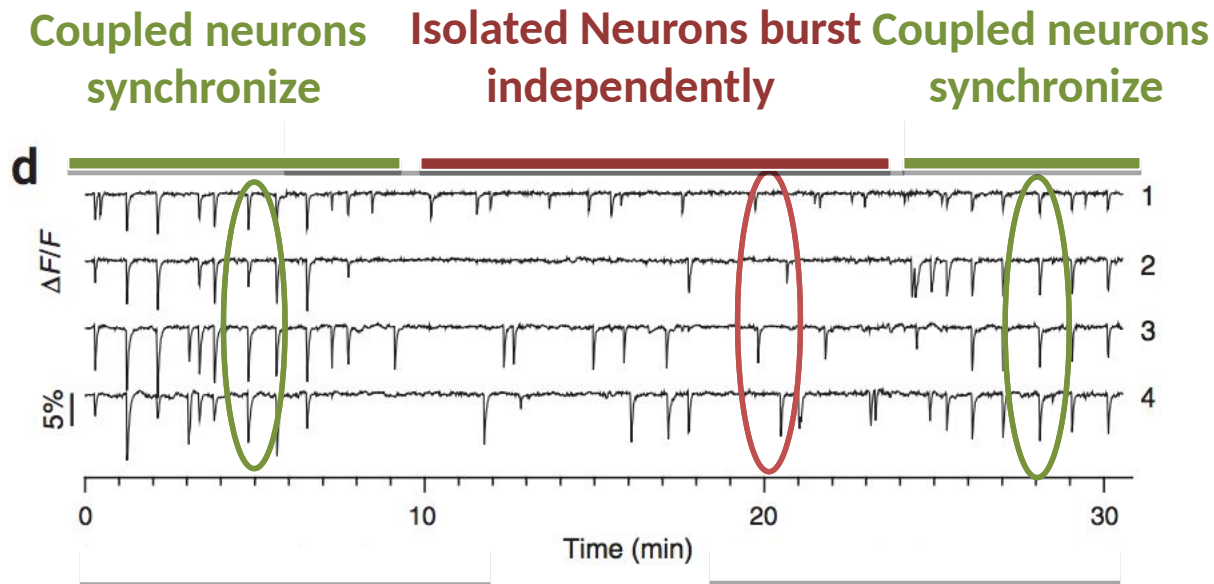

Experiment for coupled and isolated neurons, Zheng et al., 2006, Nature

Experiments for the emergence of retinal waves

Retinal waves require three components:

Several models of stage II retinal waves have been proposed already:

ii) Refractory mechanism (slow After HyperPolarisation- sAHP)

iii) Coupling (through Acetylcholine neurotransmitter)

- Feller et al Neuron, 1997.
- Eglon et al, J. Neuroscience 2000.
- Godfrey & Swindale. PLoS Comput Biol, 2007.
- Hennig et al, J. Neuroscience, 2009
- Lansdell et al, PLoS Computational Biology, 2014.

But none of them as studied simultaneously these 3 aspects:

- (i) realistic model of spontaneous bursting
- (ii) sAHP biophysical modelling
- (iii) realistic Ach interaction.

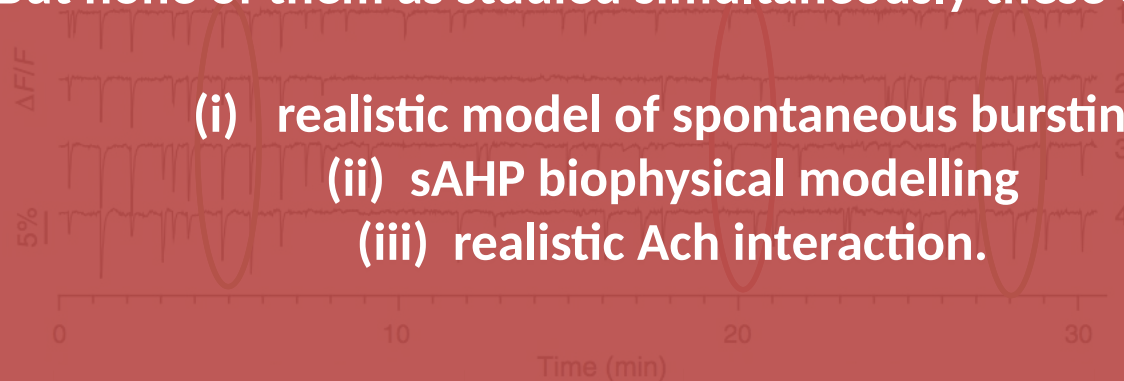

Experiment for coupled and isolated neurons, Zheng et al., 2006, Nature

A network model for stage II retinal waves

A biophysical model explains the spontaneous bursting behavior in the developing retina
Dora Matzakos-Karvouniari, Lionel Gil, Elaine Orendorff, Olivier Marre, Serge Picaud, Bruno Cessac
Scientific Reports, Nature Publishing Group, 2019, 9 (1), pp.1-23. (10.1038/s41598-018-38299-4)

A network model for stage II retinal waves

Membrane potential dynamics

$$C_m \frac{\partial V}{\partial t} = -g_L^M (V - V_L) - g_{Ca}(V)(V - V_{Ca}) - g_K N (V - V_K)$$

$$\tau_N \frac{\partial N}{\partial t} = \Lambda(V)(N_\infty(V) - N)$$

**Morris-Lecar &
Fast K⁺ channels**

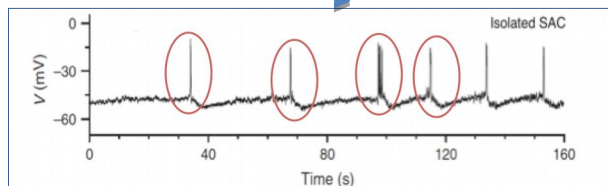

A network model for stage II retinal waves

Membrane potential dynamics

$$C_m \frac{\partial V_i}{\partial t} = -g_L^M (V_i - V_L) - g_{Ca}(V_i)(V_i - V_{Ca}) - g_K N_i (V_i - V_K) - g_{sAHP} R_i^4 (V_i - V_K) - \sum_j g_{j,Ach}(A_j)(V_i - V_{Ach})$$

$$\tau_N \frac{\partial N}{\partial t} = \Lambda(V)(N_\infty(V) - N)$$

**Morris-Lecar &
Fast K⁺ channels**

**sAHP current
Refractory
mechanism**

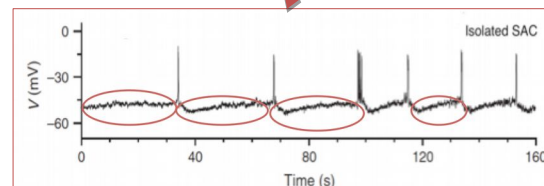
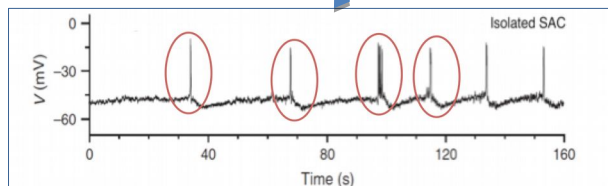

sAHP current

- **Definition**
 - Slow After Hyperpolarisation Current
 - Calcium-dependent slow potassium channels
- **Mechanism**
 - Model SK-like channels (Abel et al. 2004)
 - Gating Mechanism: **Four** ions Ca^{2+} bind to Calmodulin (CaM)

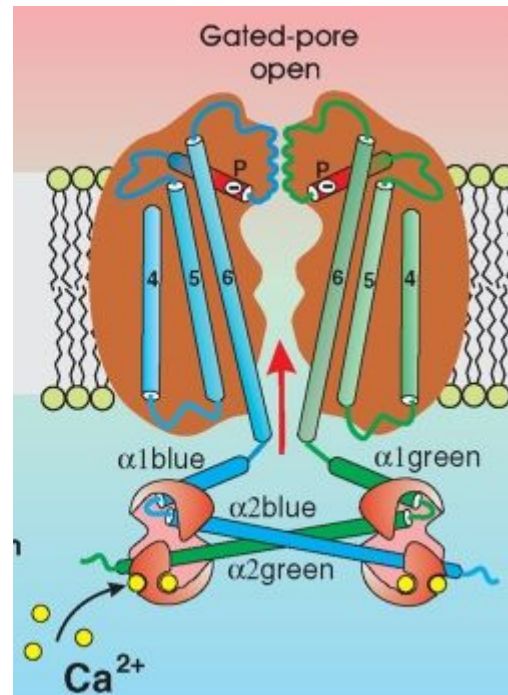
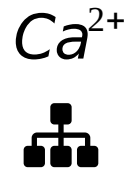
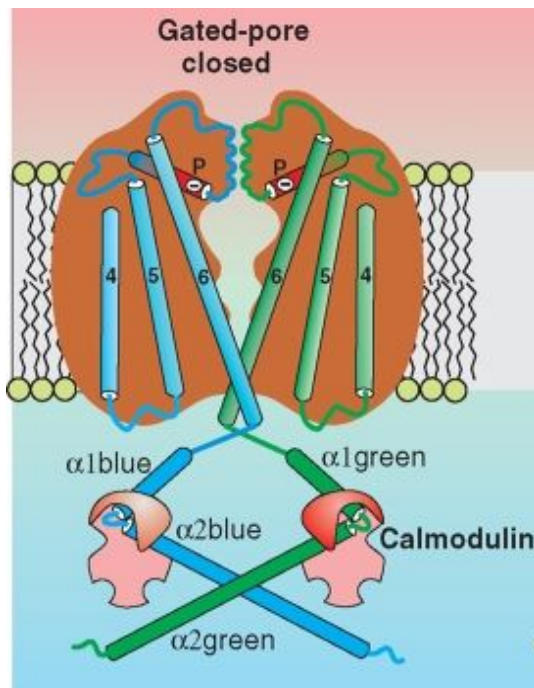

Calcium gated
potassium
channel

superhimik.livejournal.com/

sAHP current

- Four Ca^{2+} ions bound to calmodulin open the channel
- I_{SAHP} current depends on gating variable R as follows:

$$I_{SAHP} = g_{SAHP}^m R^4 (V - V_K) \quad (\text{Hennig et al. 2009})$$

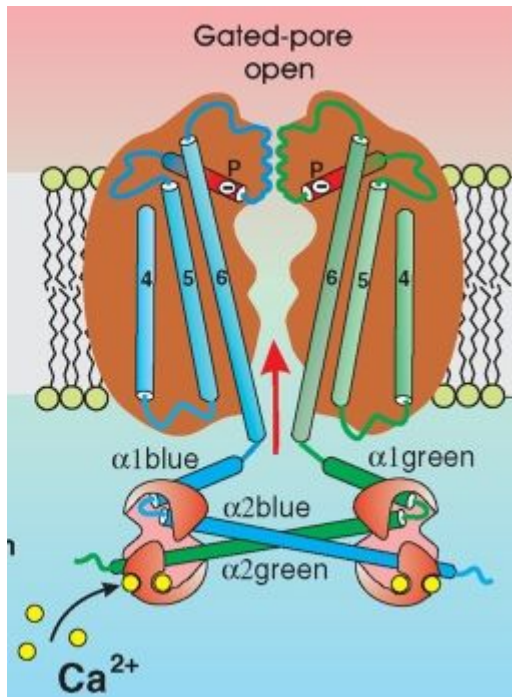

The conductance is proportional to the fourth power of R because four terminals are needed to open the channel.

superhimik.livejournal.com/

Set of equations for sAHP current

Activated Ca-gated K⁺ channel

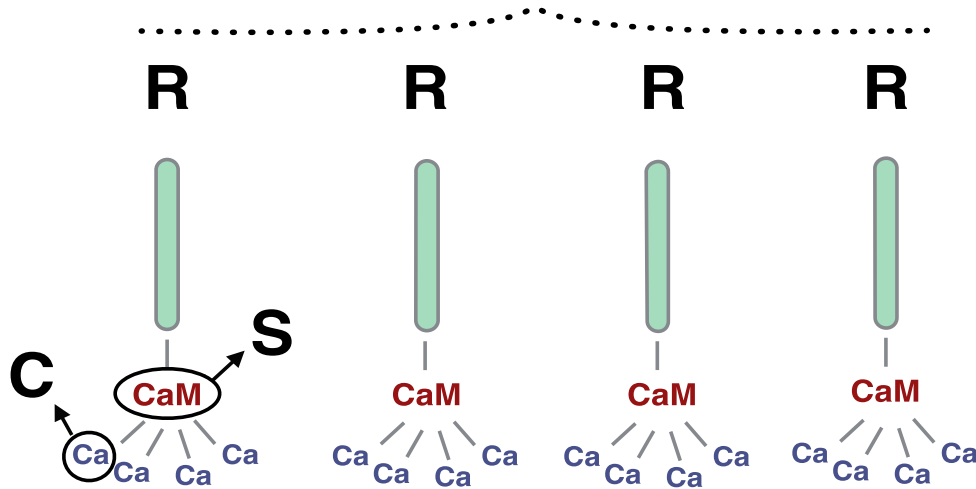

Gating mechanism

All 4 subunits R of the channel are bound to activate the channel



Saturated Calmodulin molecule (CaM) bind to each channel subunit



4 Calcium ions bound to each saturated Calmodulin complex S

Set of equations for sAHP current

Activated
Ca-gated K⁺ channel

$$\tau_R \frac{dR}{dt} = a_R S(1 - R) - R$$

R : Probability that one terminal of the channel is open

$$\tau_S \frac{dS}{dt} = -S + a_S C^4(1 - S)$$

S : Fraction of saturated calmodulin concentration (CaM)

$$\tau_{Ca} \frac{dC}{dt} = -a_R \frac{C}{H_x} + C_o + \delta_{Ca} I_{Ca}(V)$$

C : Intracellular Calcium concentration

SACs Network

Model synaptic interactions

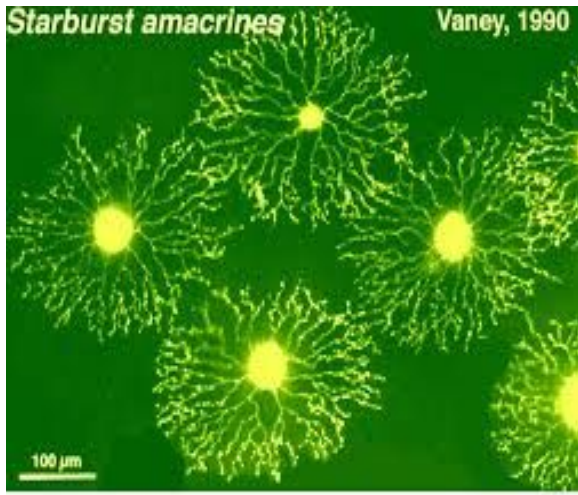
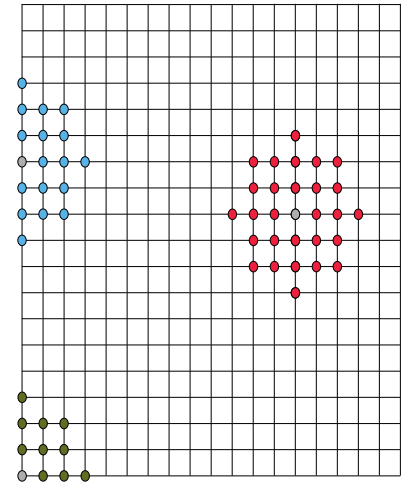
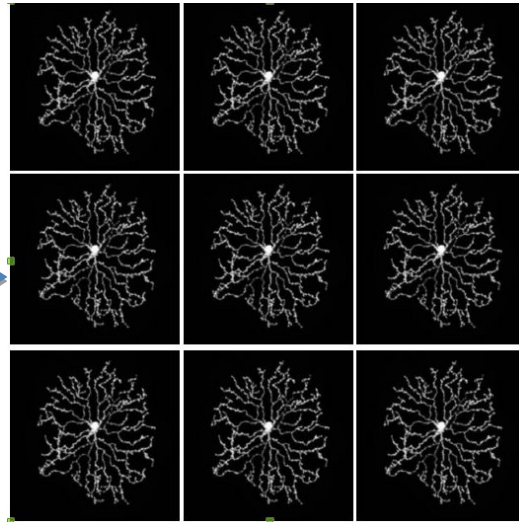

Fig 7. Starburst amacrine cells are stained with Lucifer yellow in whole-mount rabbit retina.



SACs realistic connections

SACs on a lattice

SACs become points on a lattice

Acetylcholine current

- Molecular nicotinic receptors (nAChR)
- Two molecules of acetylcholine bind to open a nicotinic channel
- The nicotinic conductance depends on the second power of the acetylcholine neurotransmitter concentration A

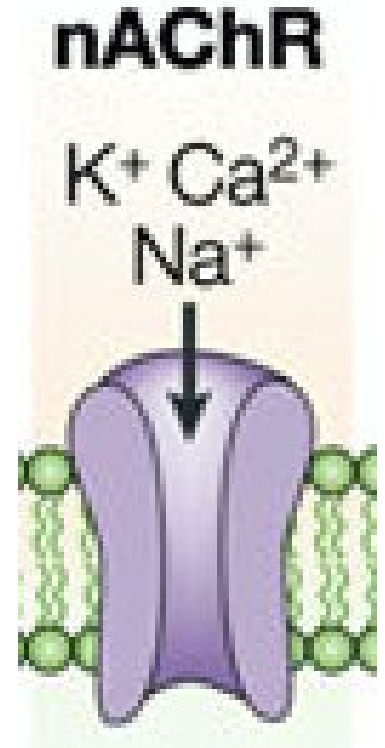

$$g_{ACh} = g_{ACh}^m \frac{A^2}{K_d^2 + A^2}$$

A network model for stage II retinal waves

Membrane potential dynamics

$$C_m \frac{\partial V_i}{\partial t} = -g_L^M (V_i - V_L) - g_{Ca} (V_i) (V_i - V_{Ca}) - g_K N_i (V_i - V_K) - g_{sAHP} R_i^4 (V_i - V_K) - \sum_j g_{j,Ach} (A_j) (V_i - V_{Ach})$$

$$\tau_N \frac{\partial N}{\partial t} = \Lambda(V) (N_\infty(V) - N)$$

**Morris-Lecar &
Fast K⁺ channels**

**sAHP current
Refractory
mechanism**

**Ach current
Network
effect**

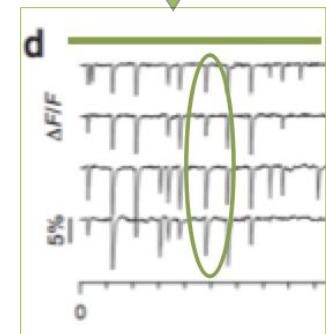
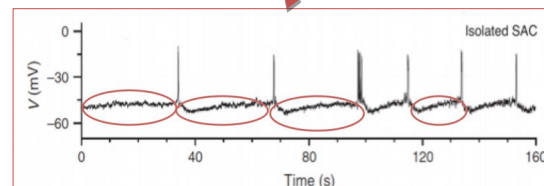
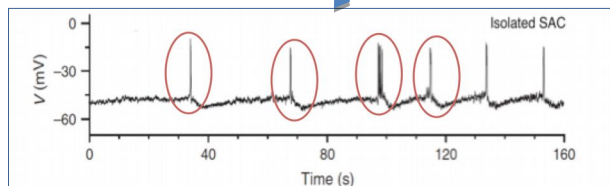

A network model for stage II retinal waves

A biophysical model explains the spontaneous bursting behavior in the developing retina
Dora Matzakos-Karvouniari, Lionel Gil, Elaine Orendorff, Olivier Marre, Serge Picaud, Bruno Cessac
Scientific Reports, Nature Publishing Group, 2019, 9 (1), pp.1-23. (10.1038/s41598-018-38299-4)

$$\left\{ \begin{array}{l} C_m \frac{dV_i}{dt} = -g_L(V_i - V_L) - g_C M_\infty(V_i)(V_i - V_C) - g_K N_i(V_i - V_K) \\ \quad - G_{sAHP}(R_i)(V_i - V_K) - G_A(\{A_k\}_{k \in \mathcal{B}_i})(V_i - V_A) \\ \\ \tau_N \frac{dN_i}{dt} = \Lambda(V_i)(N_\infty(V_i) - N_i) \\ \\ \tau_C \frac{dC_i}{dt} = -\frac{\alpha_C}{H_X} C_i + C_0 - \delta_C g_C M_\infty(V_i)(V_i - V_C) \\ \\ \tau_S \frac{dS_i}{dt} = \alpha_S(1 - S_i)C_i^4 - S_i \\ \\ \tau_R \frac{dR_i}{dt} = \alpha_R S_i(1 - R_i) - R_i \\ \\ \frac{dA_i}{dt} = -\mu A_i + \beta_A T_A(V_i), \end{array} \right.$$

A network model for stage II retinal waves

N neurons, 6 N equations

$$\left\{ \begin{array}{l}
 C_m \frac{dV_i}{dt} = -g_L(V_i - V_L) - g_C M_\infty(V_i)(V_i - V_C) - g_K N_i(V_i - V_K) \\
 \quad - G_{sAHP}(R_i)(V_i - V_K) - G_A(\{A_k\}_{k=1, \dots, n})(V_i - V_A) \\
 \tau_N \frac{dN_i}{dt} = \Lambda(V_i)(N_\infty(V_i) - N_i) \\
 \tau_C \frac{dC_i}{dt} = -\frac{\alpha_C}{H_X} C_i + C_0 - \delta_C g_C M_\infty(V_i)(V_i - V_C) \\
 \tau_S \frac{dS_i}{dt} = \alpha_S(1 - S_i)C_i^4 - S_i \\
 \tau_R \frac{dR_i}{dt} = \alpha_R S_i(1 - R_i) - R_i \\
 \frac{dA_i}{dt} = -\mu A_i + \beta_A T_A(V_i),
 \end{array} \right.$$

~ 20 parameters per neuron
(But neurons are assumed identical)

A network model for stage II retinal waves

N neurons, 6 N equations

$$\left\{ \begin{array}{l} C_m \frac{dV_i}{dt} = -g_L(V_i - V_L) - g_C M_\infty(V_i)(V_i - V_C) - g_K N_i(V_i - V_K) \\ \quad - G_{sAHP}(R_i)(V_i - V_K) - G_A(\{A_k\}_{k=1}^n)(V_i - V_A) \\ \tau_N \frac{dN_i}{dt} = \Lambda(V_i)(N_\infty(V_i) - N_i) \\ \tau_C \frac{dC_i}{dt} = -\frac{\alpha_C}{H_X} C_i + C_0 - \delta_C g_C M_\infty(V_i)(V_i - V_C) \\ \tau_S \frac{dS_i}{dt} = \alpha_S(1 - S_i)C_i^4 - S_i \\ \tau_R \frac{dR_i}{dt} = \alpha_R(1 - R_i)C_i^4 - R_i \\ \frac{dA_i}{dt} = \alpha_A(1 - A_i)C_i^4 - A_i \end{array} \right.$$

~ 20 parameters per neuron
(But neurons are assumed identical)

Time scale separation

Fast V, N . $\tau_L = 11$ ms, $\tau_N = 5$ ms.

Medium C, A . $\tau_C = 2$ s, $\tau_A = 1.86$ s.

Slow S, R . $\tau_R = \tau_S = 44$ s.

Spontaneous Bursting Mechanism of SACs

■ Bursting
■ sAHP

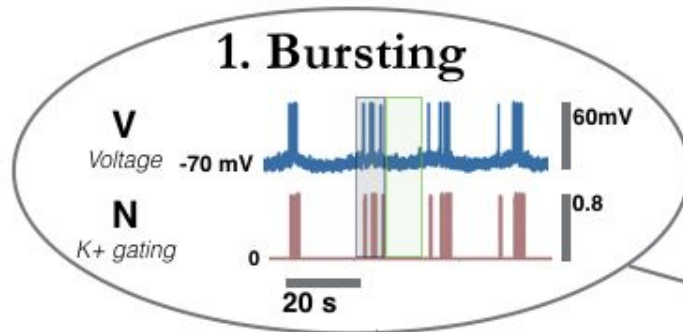

Increase of Calcium load during bursting

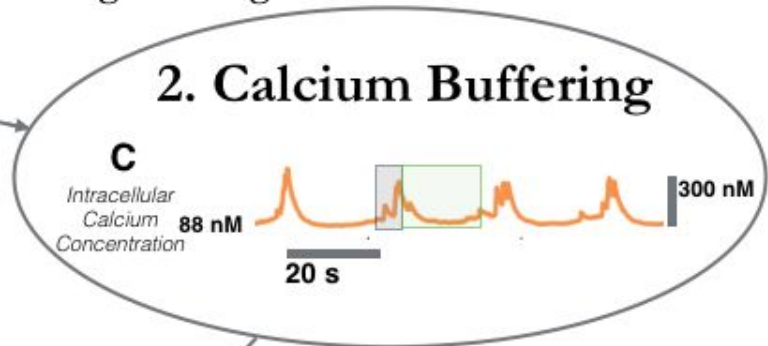

Bursting starts again when the Calcium load is low enough

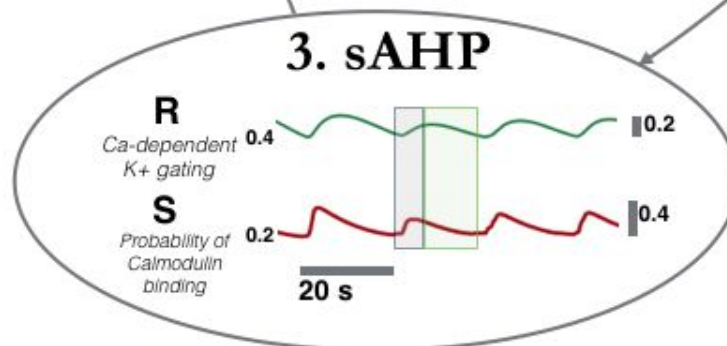

Calcium controls the sAHP phase. Voltage is low and Calcium starts offloading

Fast time scale

Fast time scale

Morris-Lecar model with fast dynamics, in the presence of a slow external current

$$\begin{cases} \frac{dV}{dt_f} = -\tilde{g}_L(V - V_L) - \tilde{g}_C M_\infty(V)(V - V_C) - \tilde{g}_K N(V - V_K) + I_{\text{ext}} \\ \frac{dN}{dt_f} = \frac{\tau_L}{\tau_N} \Lambda(V)(N_\infty(V) - N) \end{cases}$$

Fast time scale

Morris-Lecar model with fast dynamics, in the presence of a slow external current

$$\begin{cases} \frac{dV}{dt_f} = -\tilde{g}_L(V - V_L) - \tilde{g}_C M_\infty(V)(V - V_C) - \tilde{g}_K N(V - V_K) + I_{ext} \\ \frac{dN}{dt_f} = \frac{\tau_L}{\tau_N} \Lambda(V)(N_\infty(V) - N) \end{cases}$$

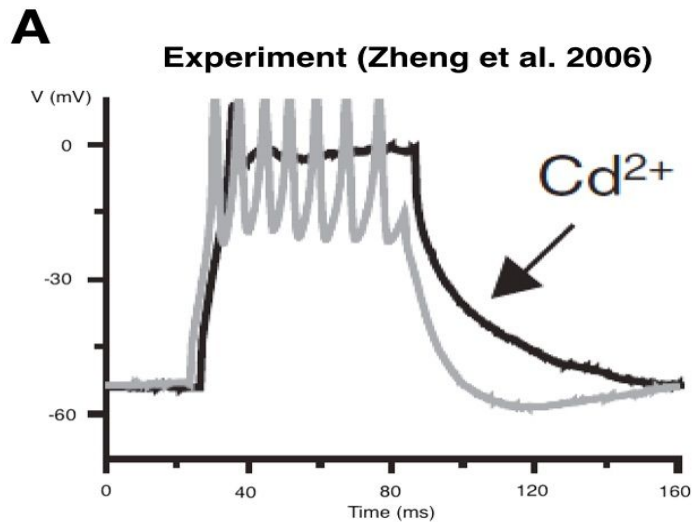

Experiment by Zheng et al. 2006,
Nature

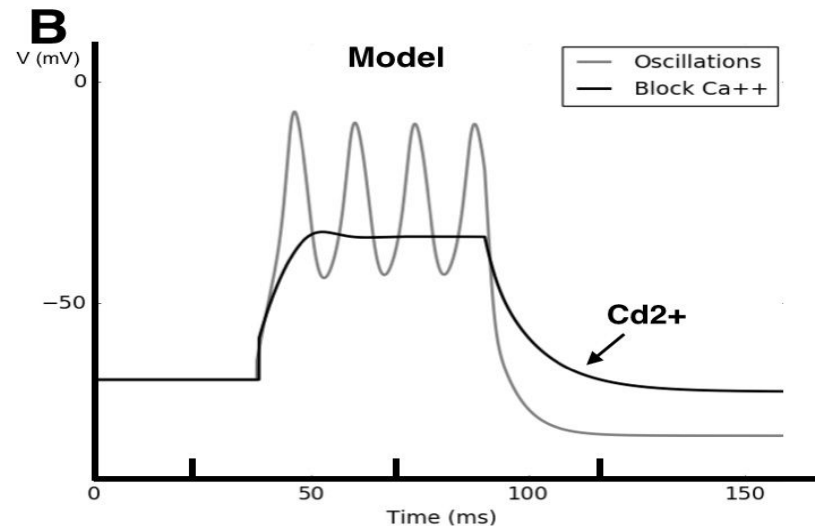

Model. Tuning parameters V_1, V_2, V_3, V_4 from ML adjusted to reproduce the experiment

Bifurcation diagram of M-L model

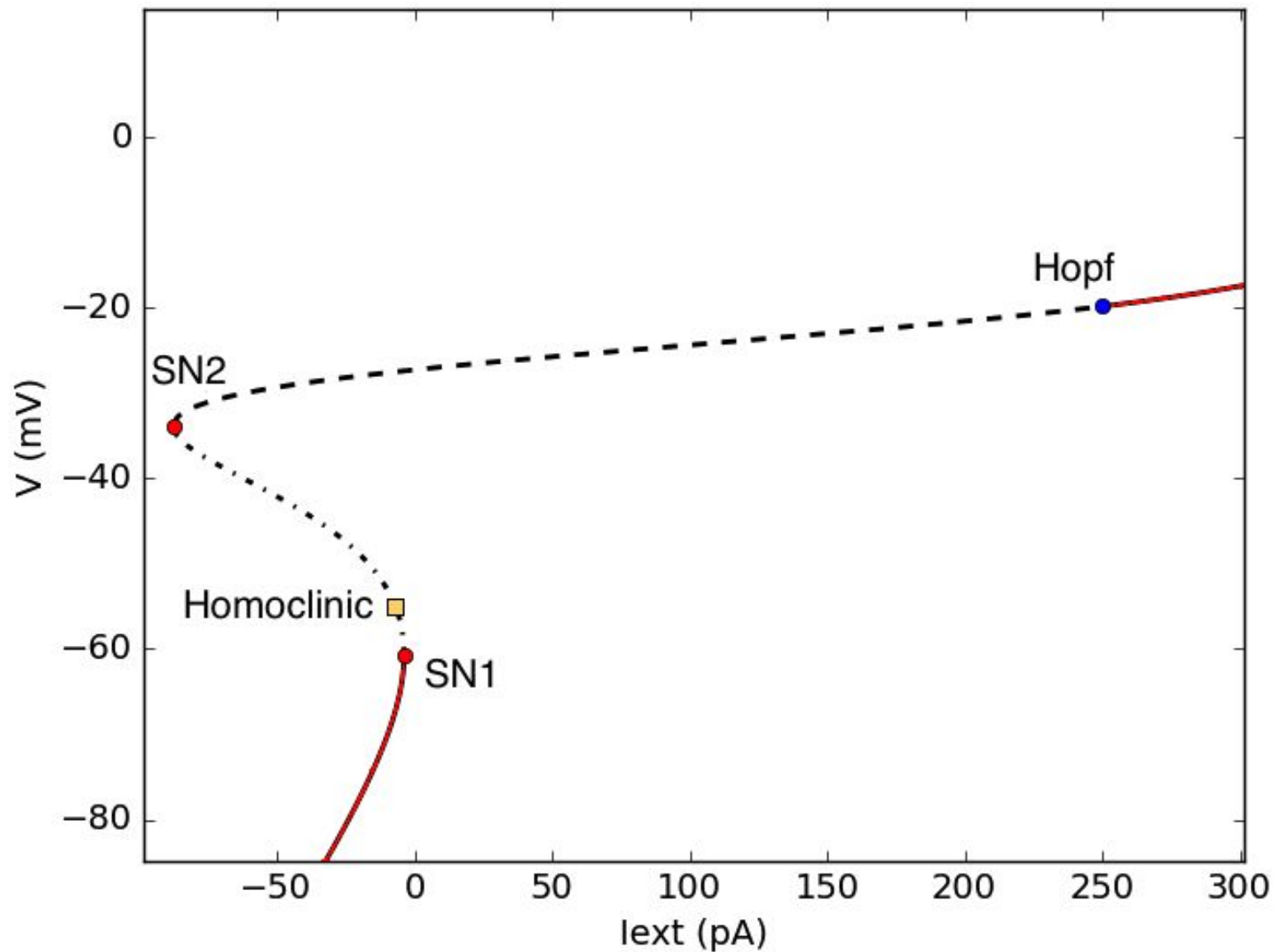

Bifurcation diagram of M-L model

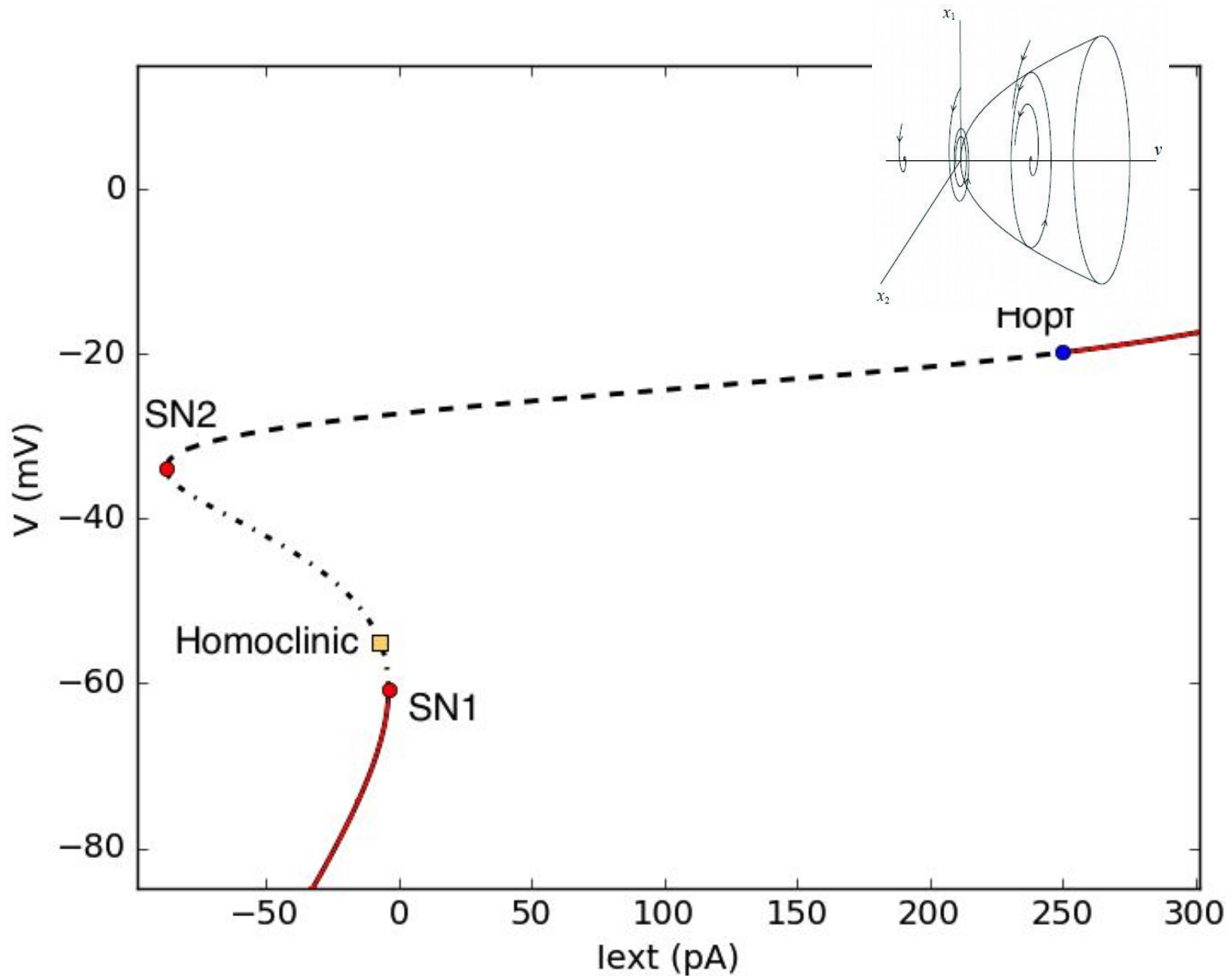

Bifurcation diagram of M-L model

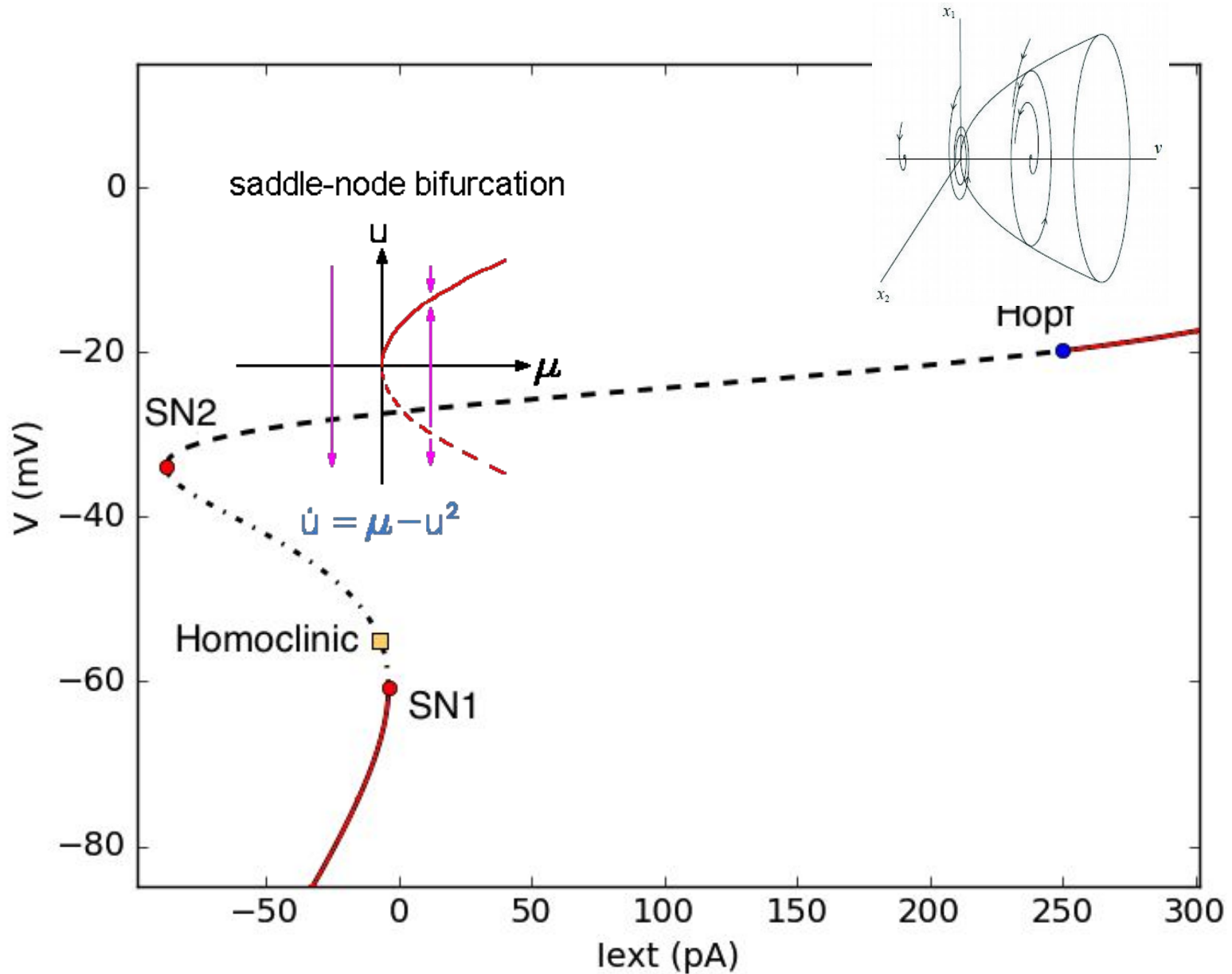

Bifurcation diagram of M-L model

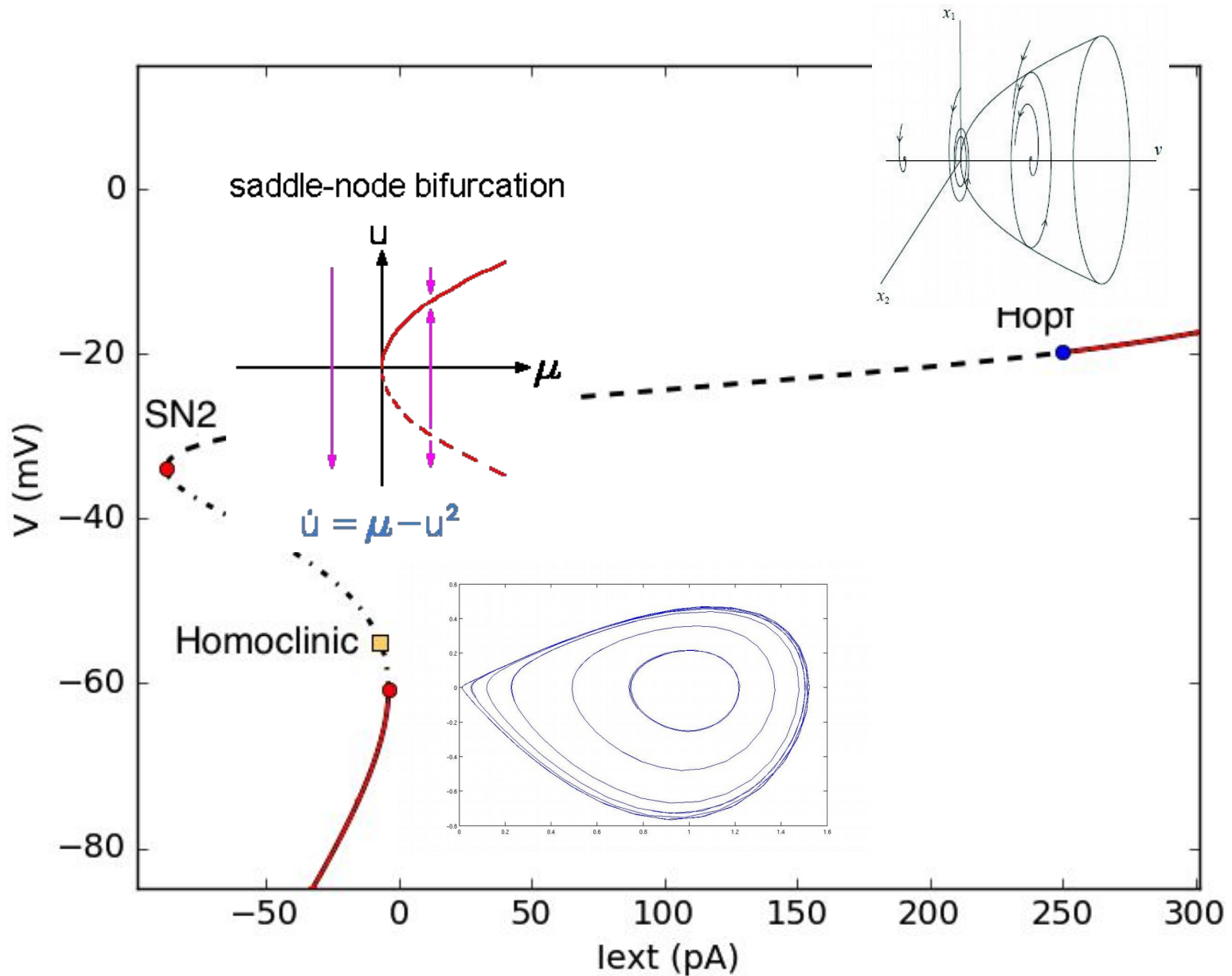

The mechanism of bursting

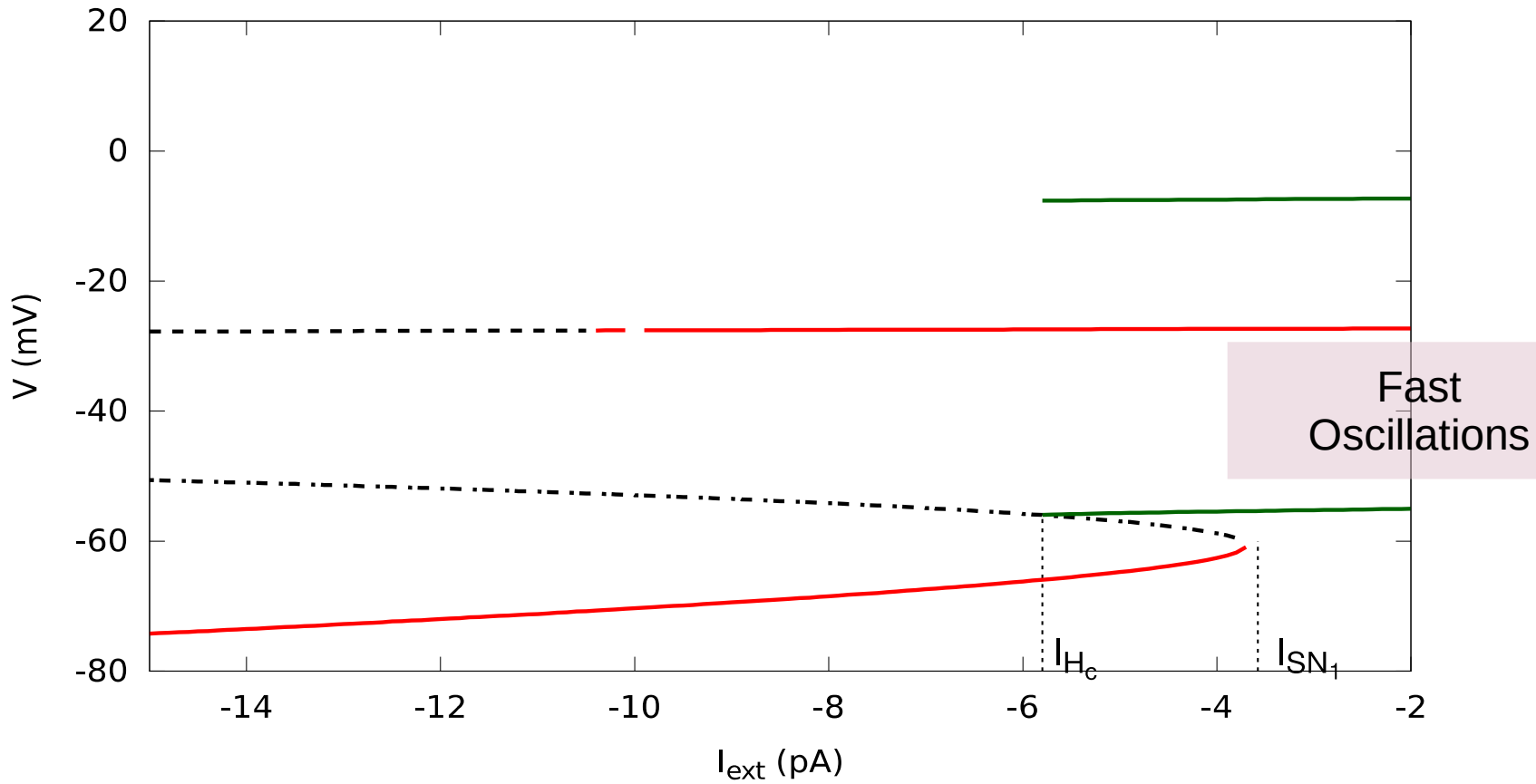

Stable
Fixed point

Fast
Oscillations

The mechanism of bursting (noise induced)

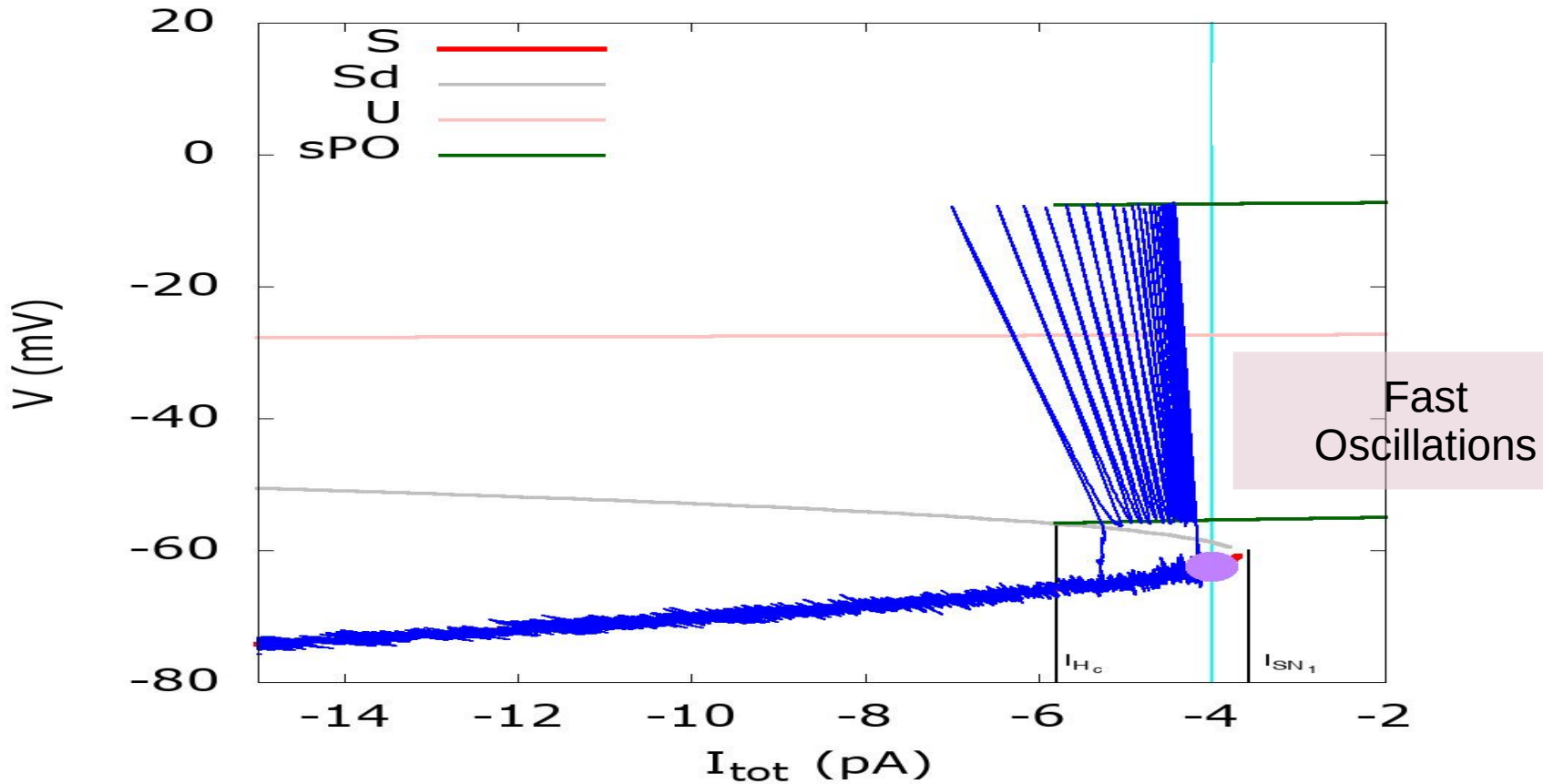

Stable
Fixed point

Spontaneous Bursting Mechanism of SACs

Bursting
 sAHP

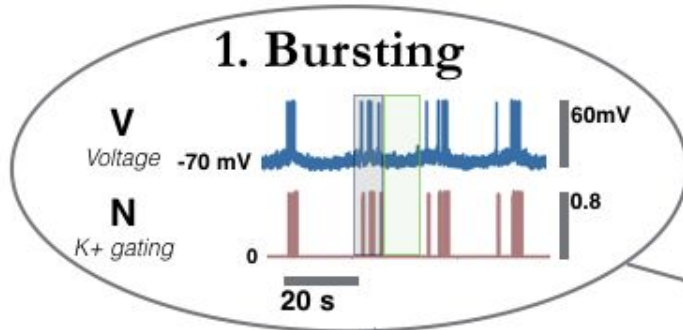

Increase of Calcium load during bursting

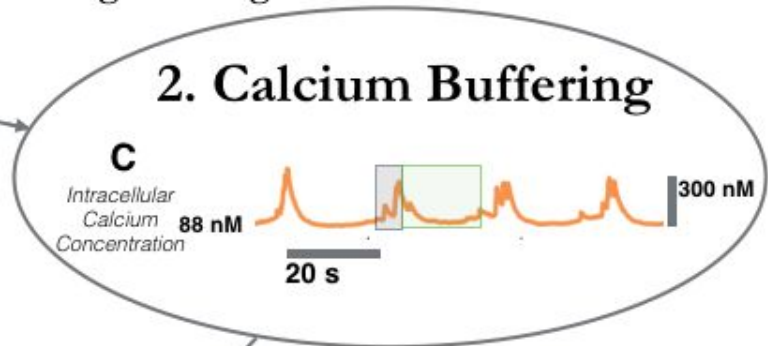

Bursting starts again when the Calcium load is low enough

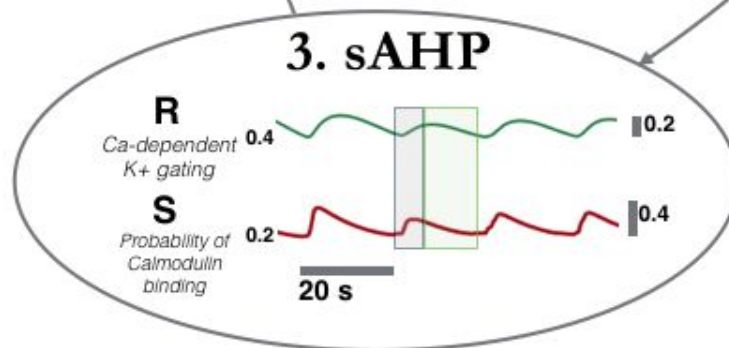

Calcium controls the sAHP phase. Voltage is low and Calcium starts offloading

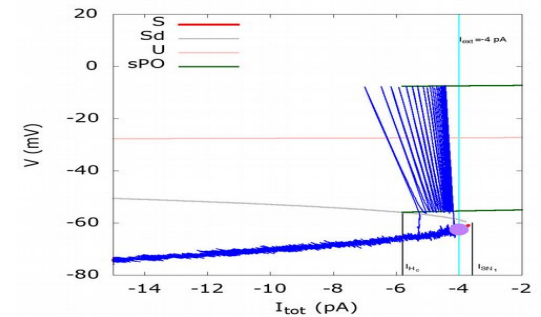

Variability within retinal waves

Pharmacological effects can be explained and predicted from bifurcations analysis (variations of physiological parameters).

A biophysical model explains the spontaneous bursting behavior in the developing retina

Dora Matzakos-Karvouniari, Lionel Gil, Elaine Orendorff, Olivier Marre, Serge Picaud, Bruno Cessac

Scientific Reports, Nature Publishing Group, 2019, 9 (1), pp.1-23. (10.1038/s41598-018-38299-4)

iii) Pharmacology

P4

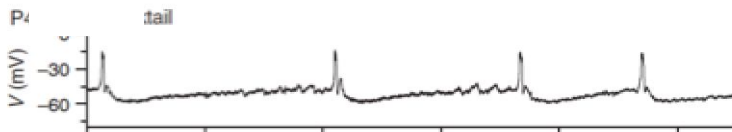

P8

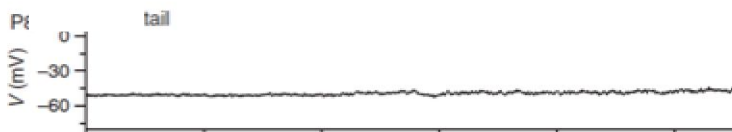

0 Time (sec) 50

Cellular mechanisms of stage II retinal waves

Cellular mechanisms of stage II retinal waves

C. Synchrony through Acetylcholine

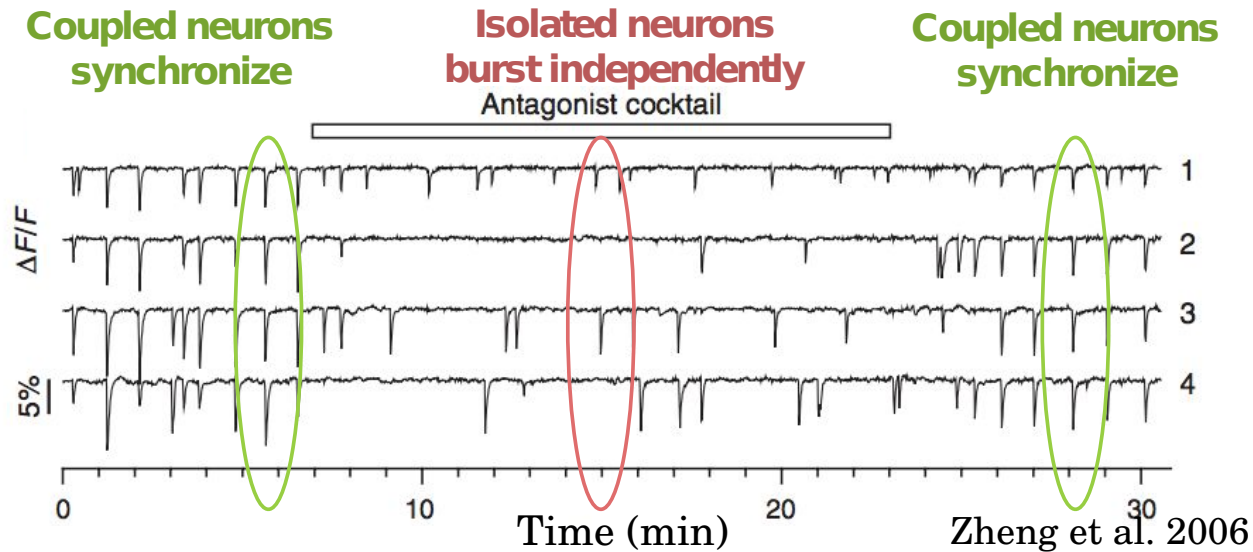

Mutual excitatory connections between SACs through Acetylcholine

A network model for stage II retinal waves

Morris-Lecar

$$C_m \frac{\partial V_i}{\partial t} = -g_L^M (V_i - V_L) - g_{Ca} (V_i) (V_i - V_{Ca}) - g_K N_i (V_i - V_K) - g_{sAHP} R_i^4 (V_i - V_K) - \sum_j g_{j,Ach} (A_j) (V_i - V_{Ach})$$

$$\tau_N \frac{\partial N}{\partial t} = \Lambda(V) (N_\infty(V) - N)$$

**Morris-Lecar &
Fast K+ channels
(kV3)**

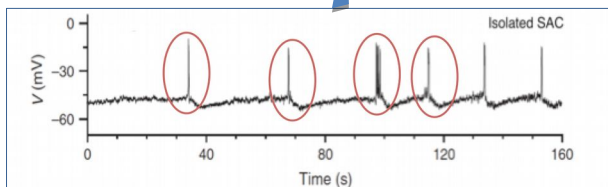

**sAHP current
Refractory
mechanism**

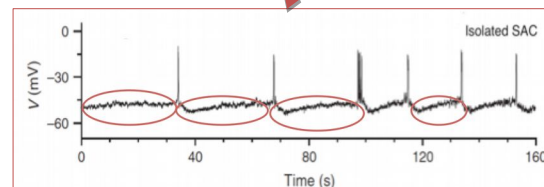

**Ach current
Network
effect**

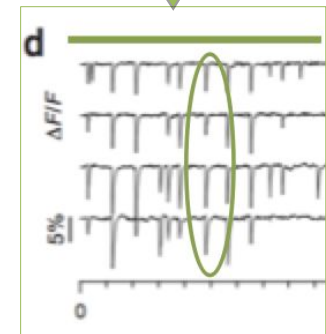

Acetylcholine current

- Molecular nicotinic receptors (nAChR)
- Two molecules of acetylcholine bind to open a nicotinic channel
- The nicotinic conductance depends on the second power of the acetylcholine neurotransmitter concentration A

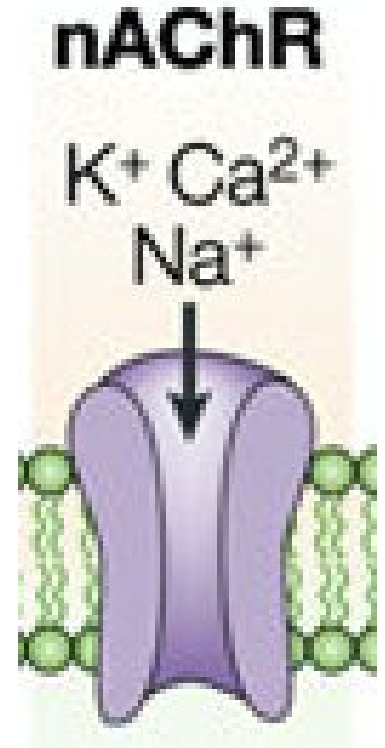

$$g_{ACh} = g_{ACh}^m \frac{A^2}{K_d^2 + A^2}$$

Waves propagation

$$g_{\text{Ach}}^m = 0.03 \text{ nS}$$

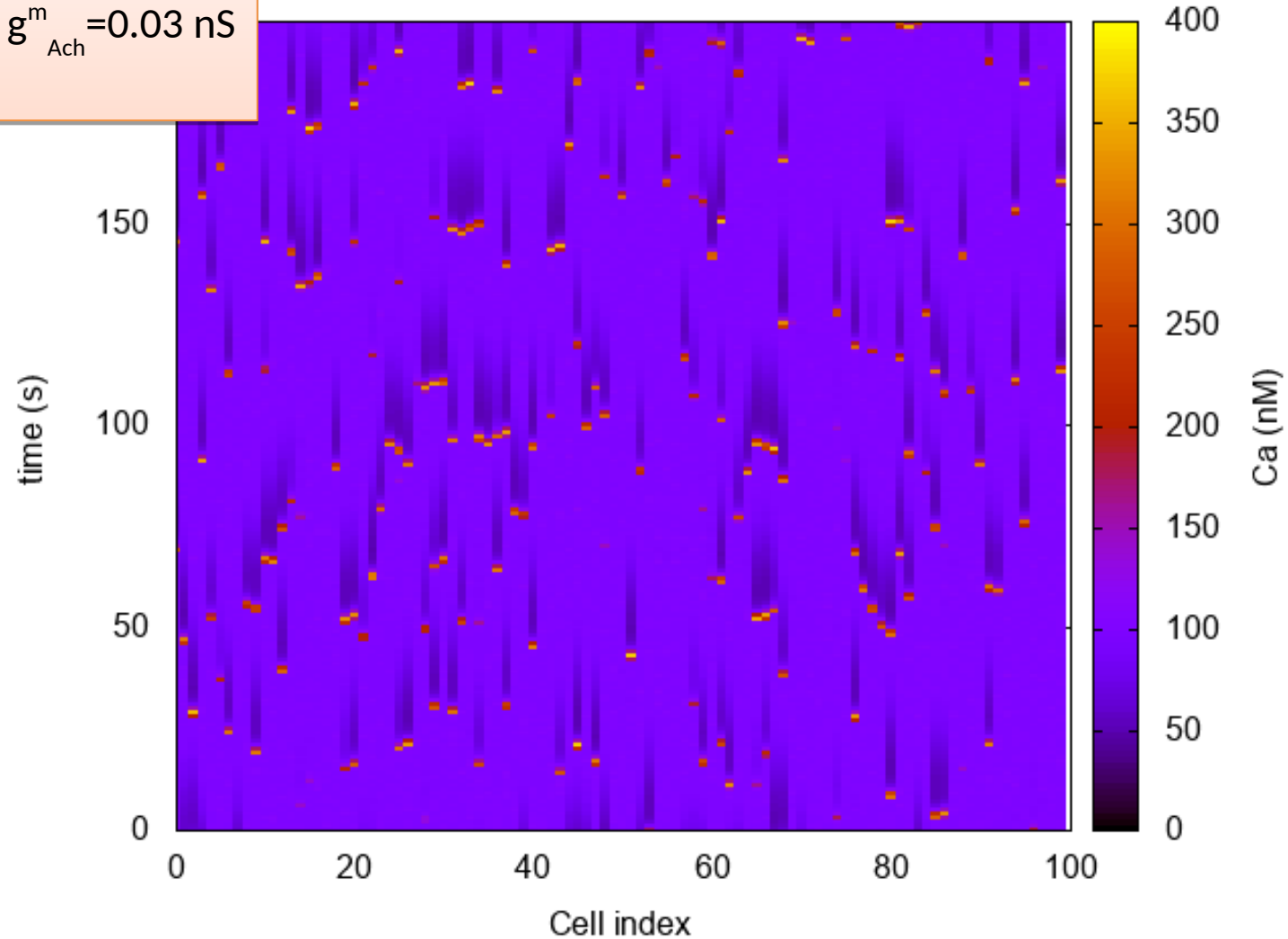

Waves propagation

$$g_{\text{Ach}}^m = 0.045 \text{ nS}$$

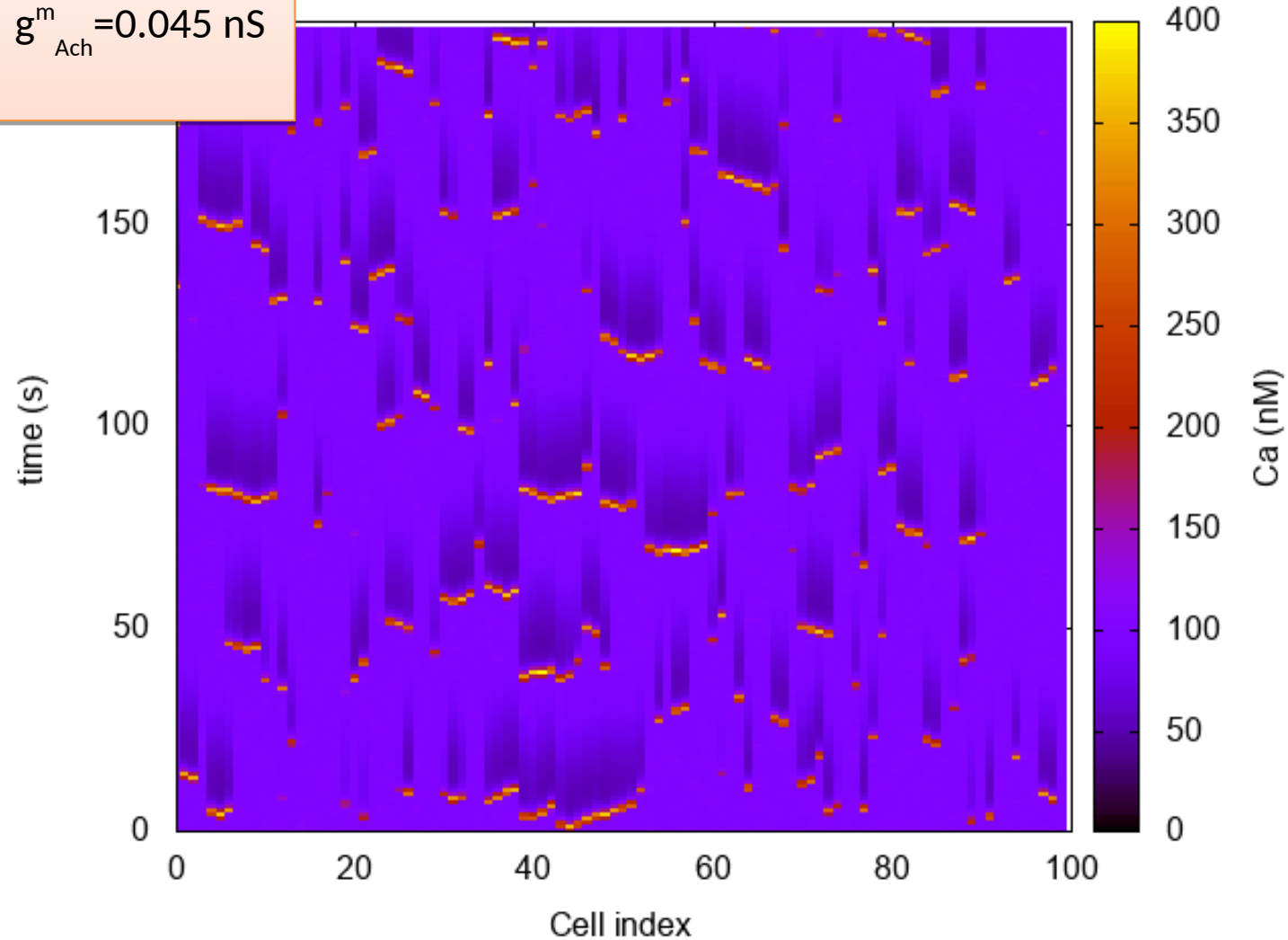

Waves propagation

$$g_{\text{Ach}}^m = 0.07 \text{ nS}$$

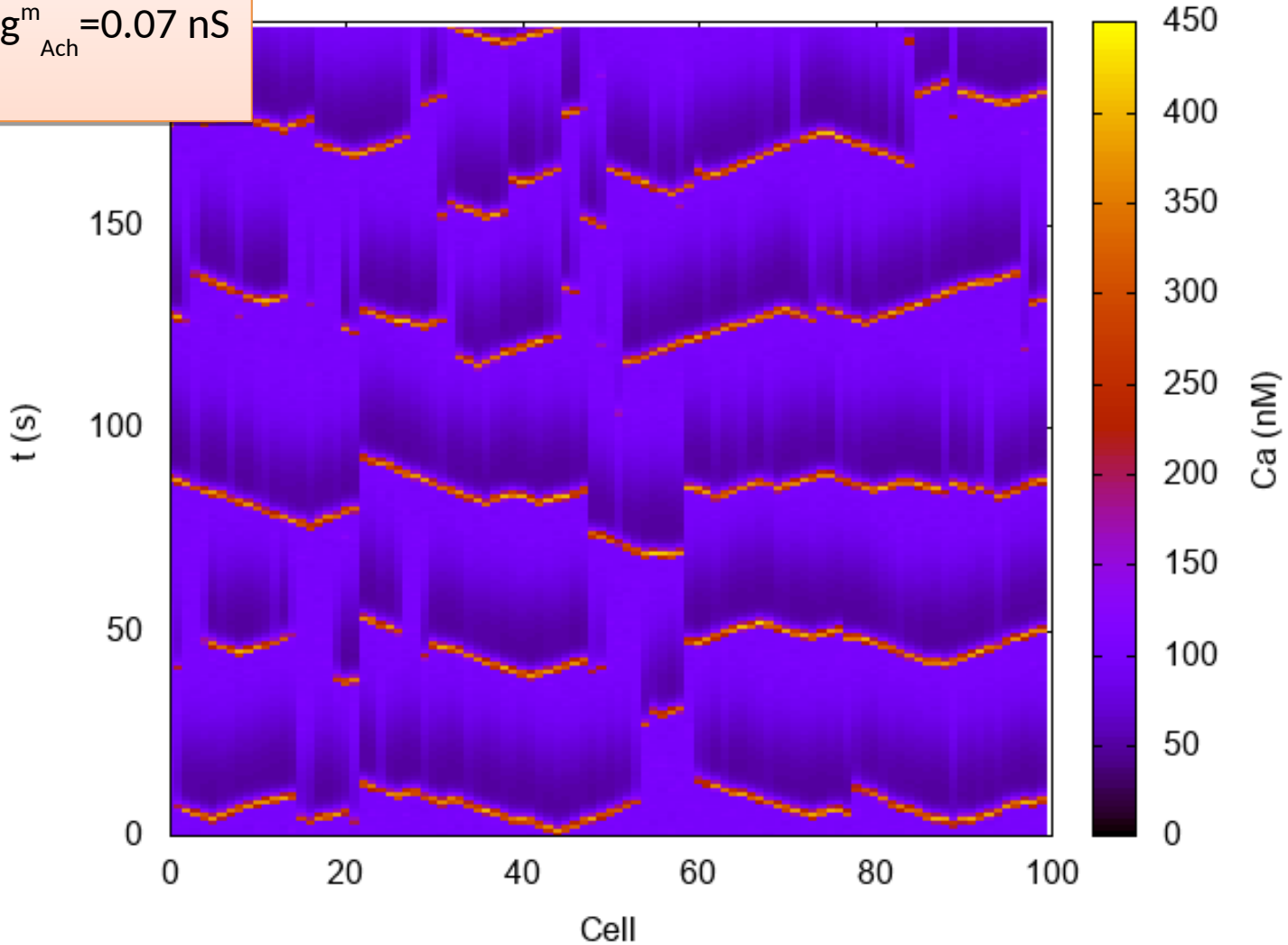

Waves propagation

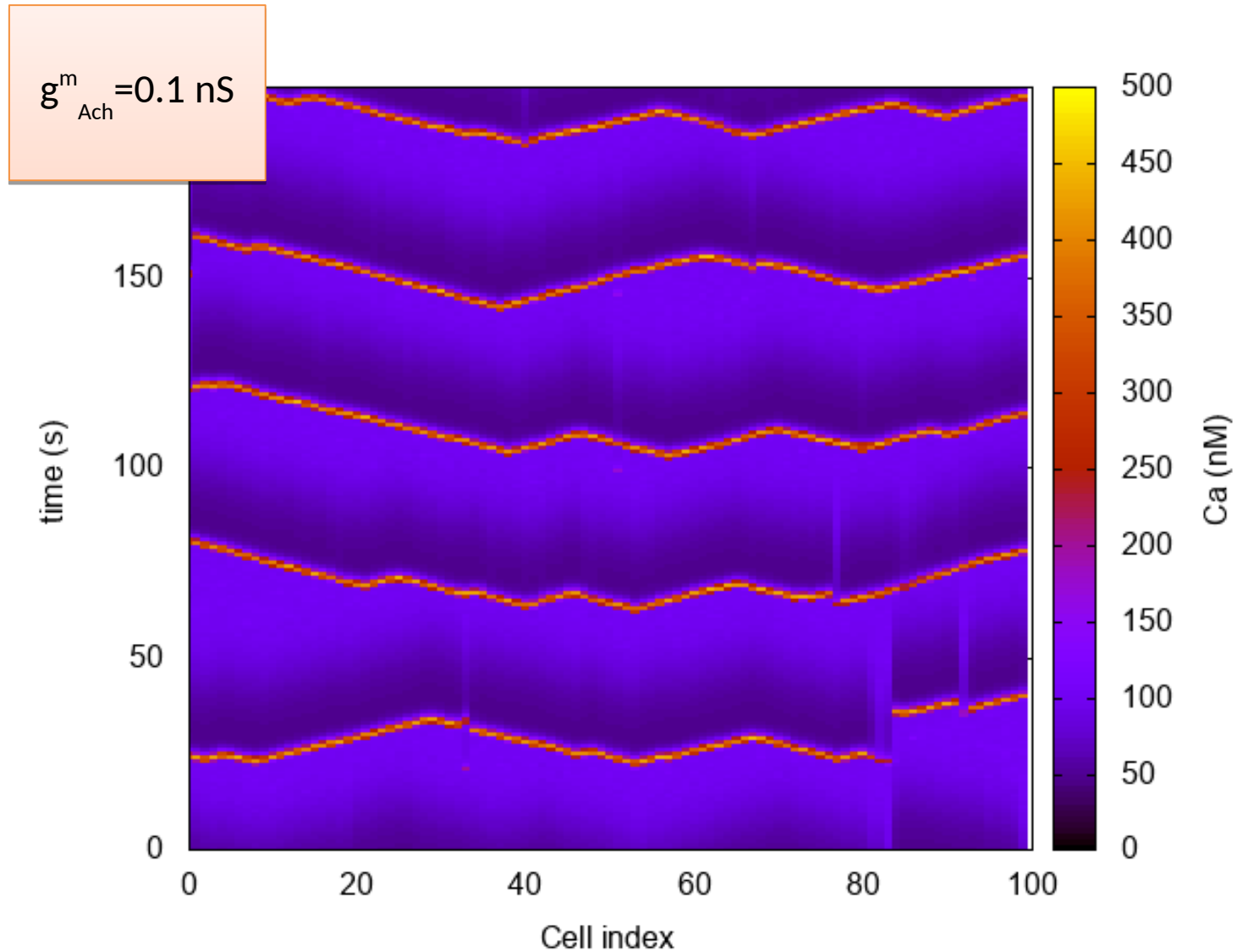

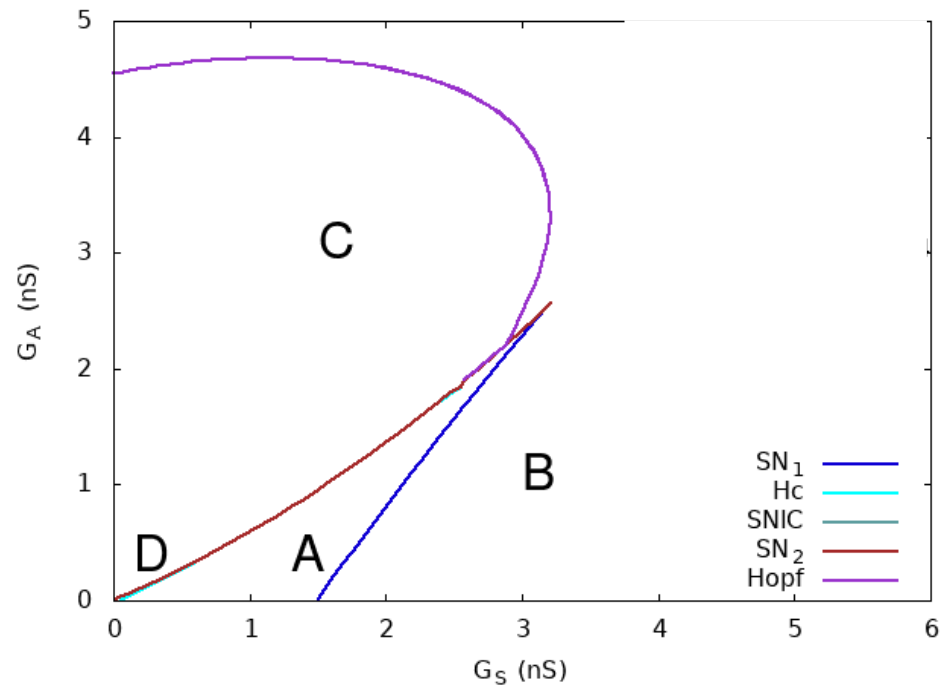

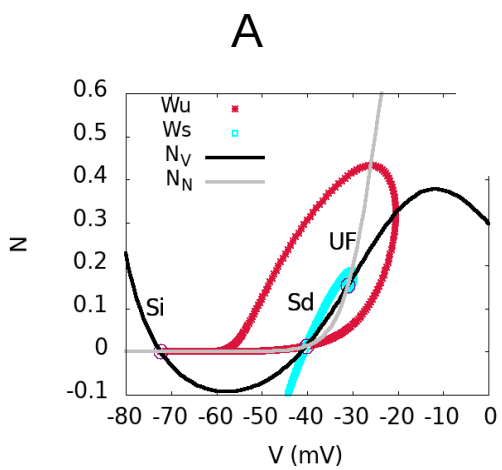
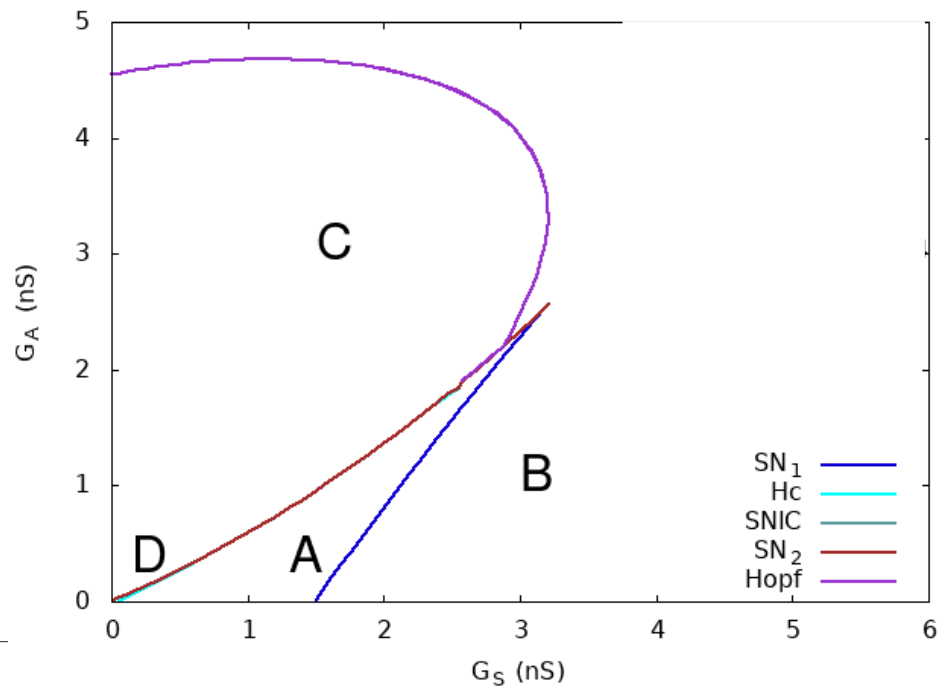

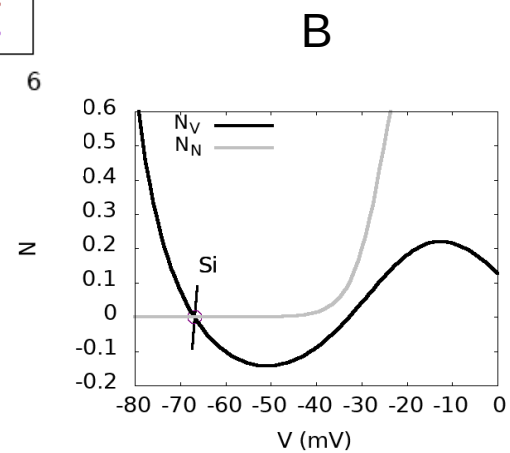
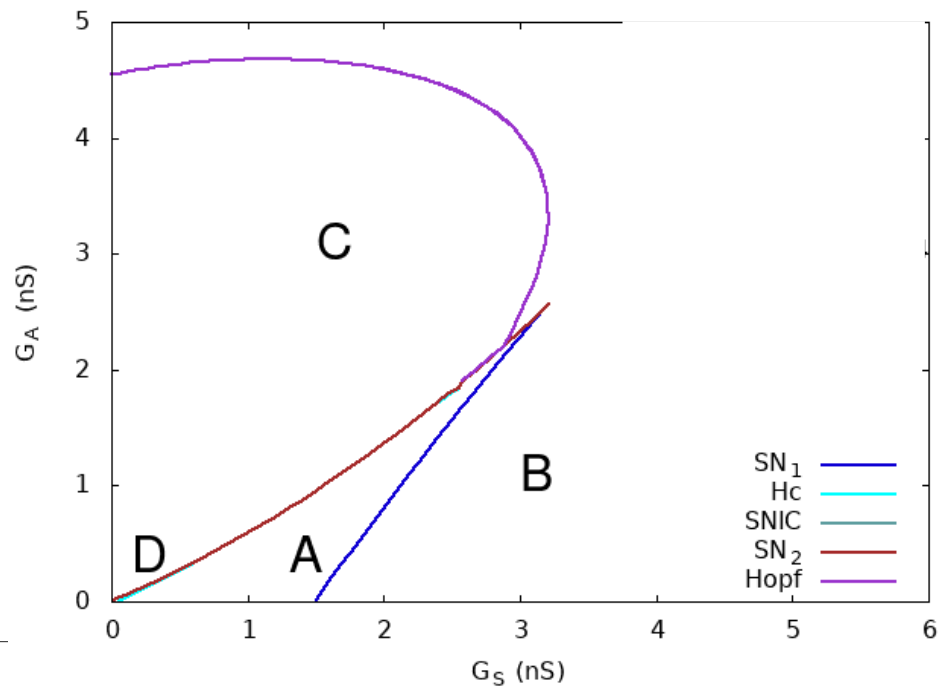
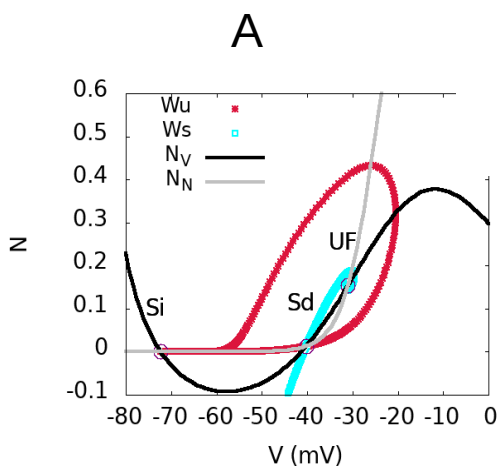

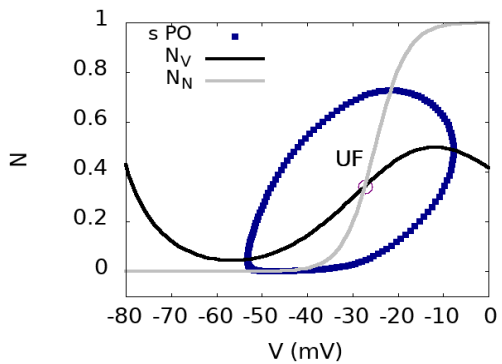

C

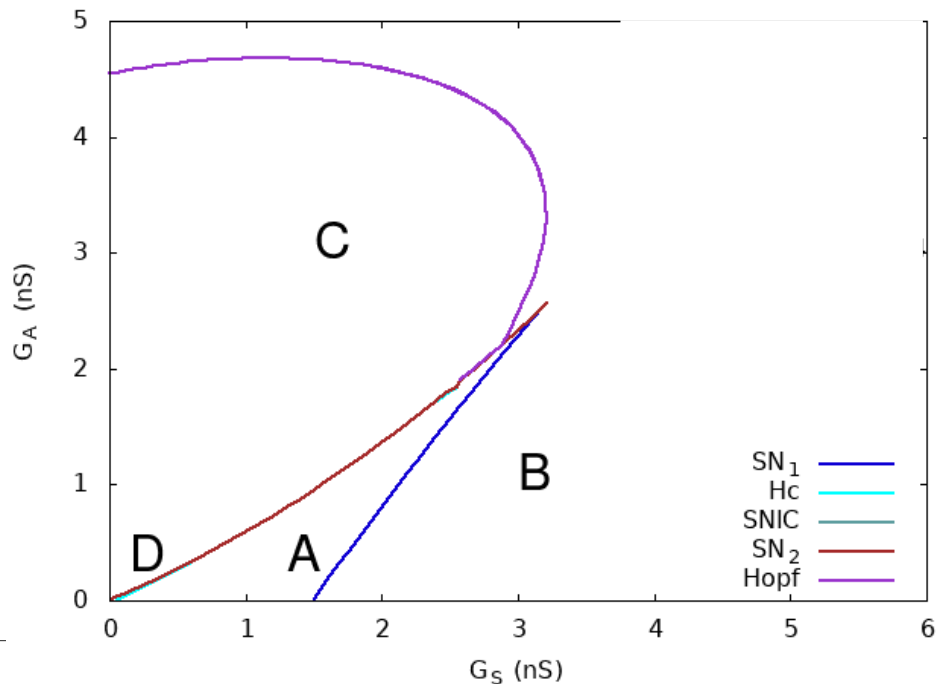

A

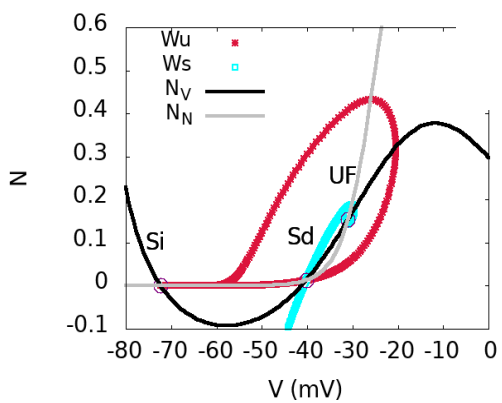

B

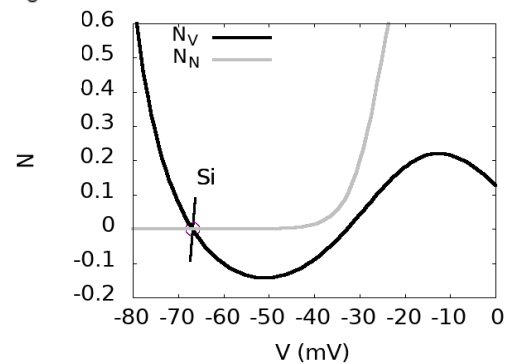

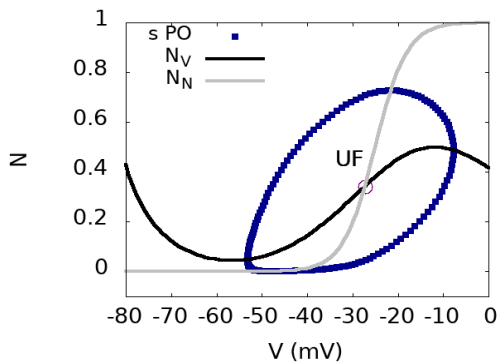

C

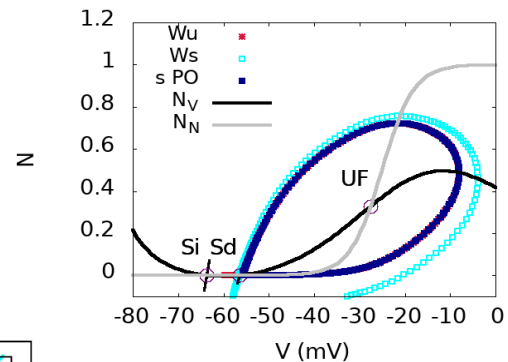

D

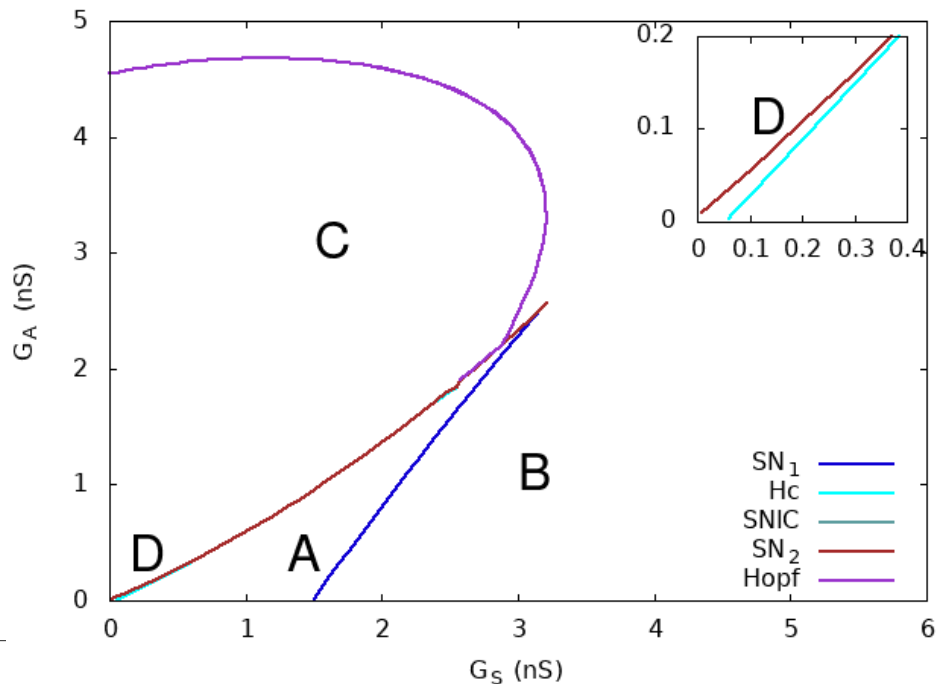

A

B

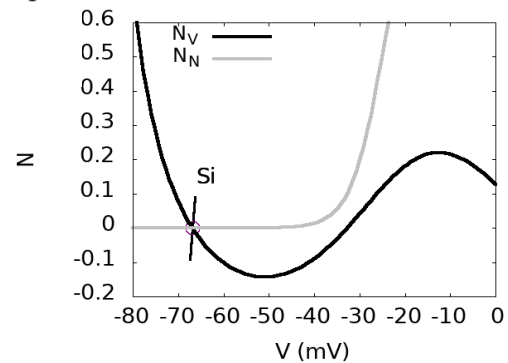
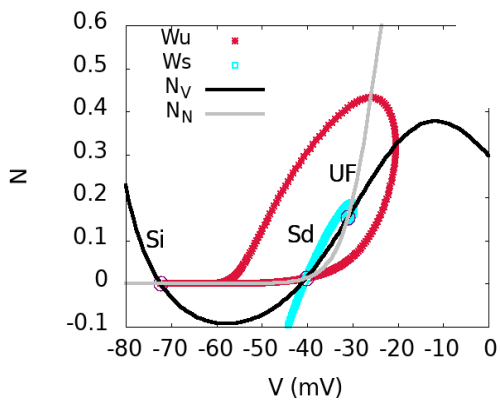

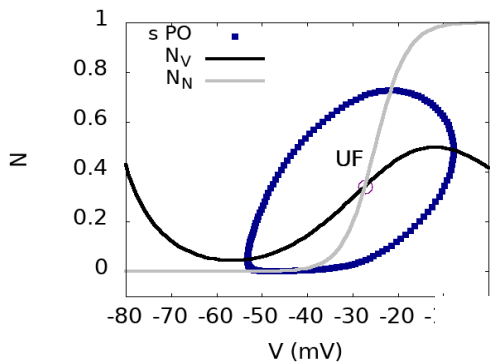

C

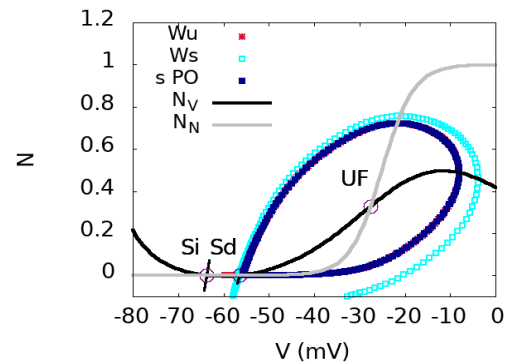

D

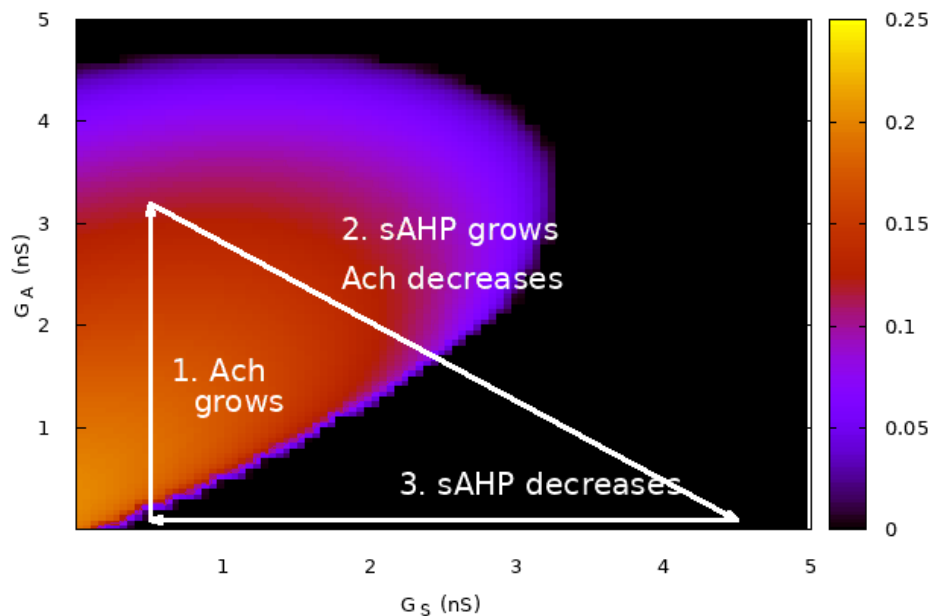

A

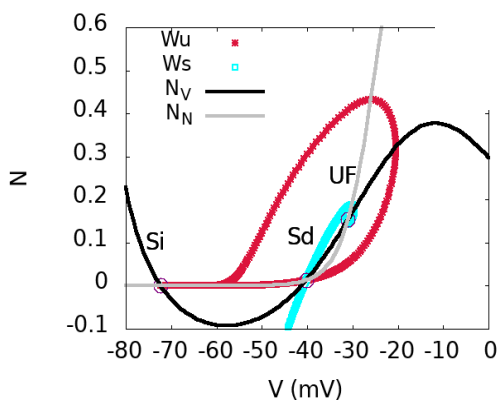

B

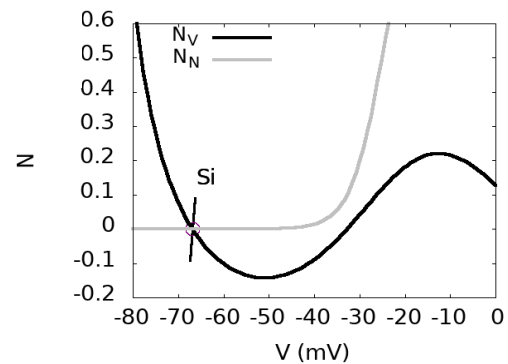

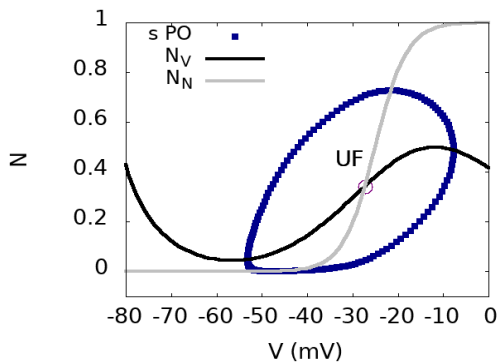

C

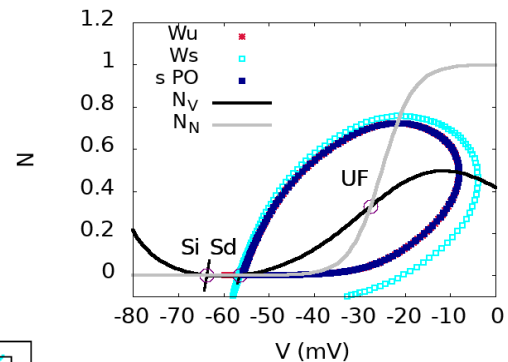

D

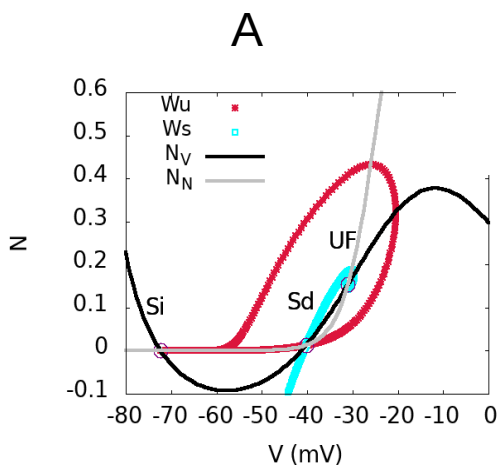

A

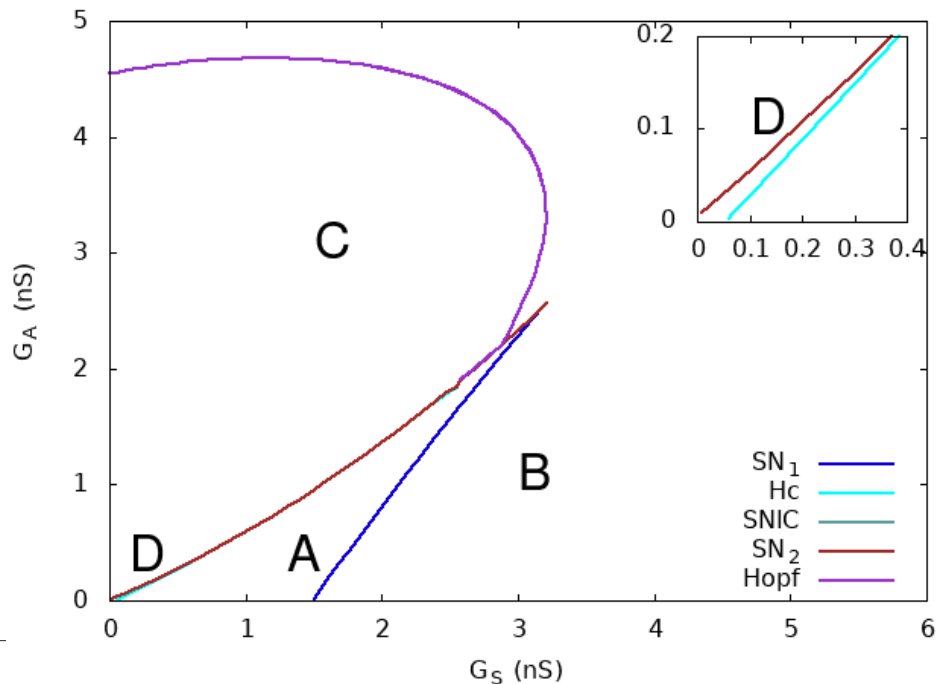

B

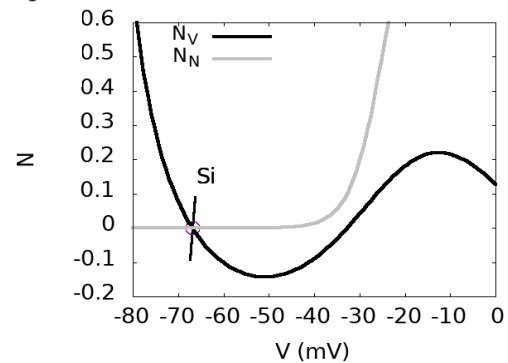

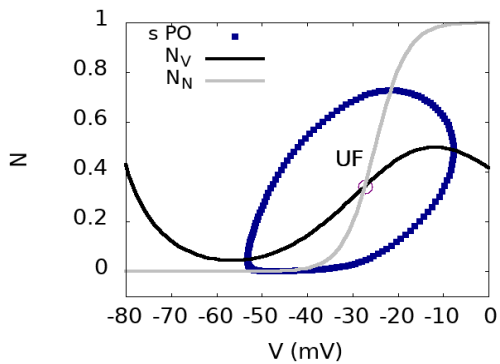

C

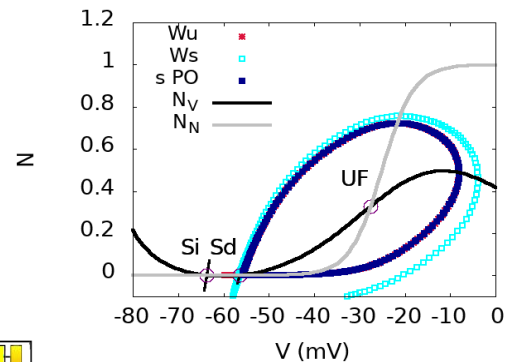

D

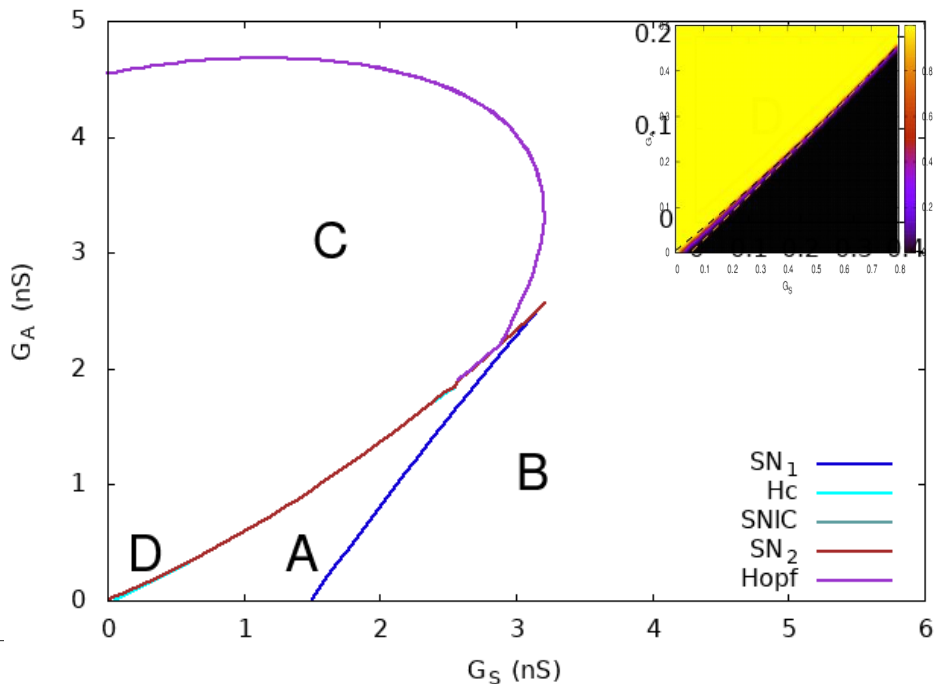

B

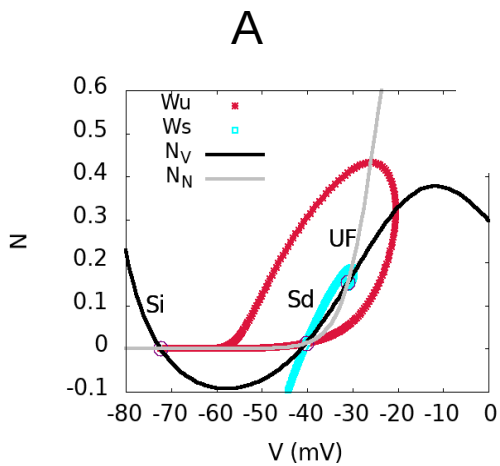

A

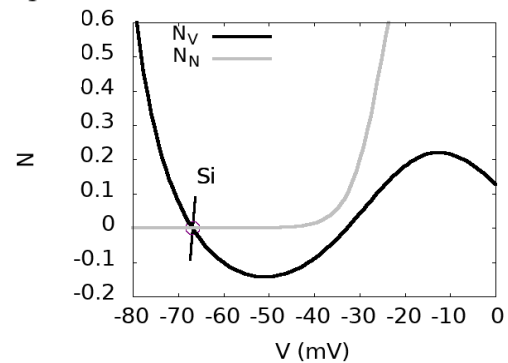

N

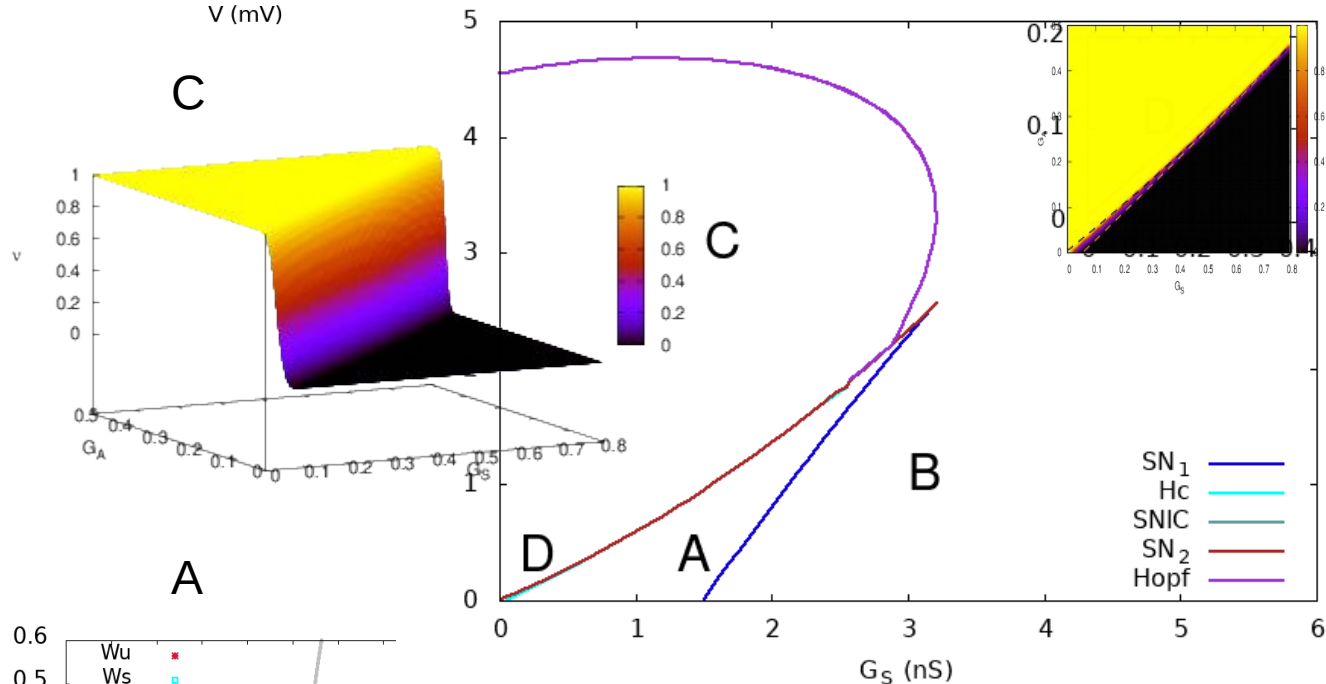
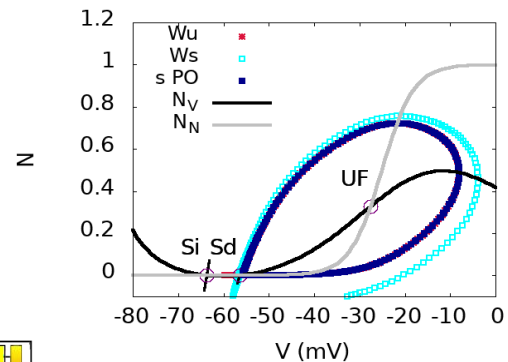
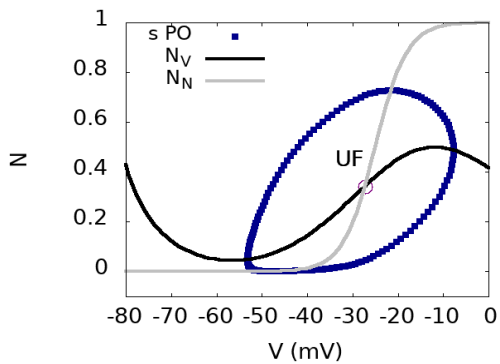

D

B

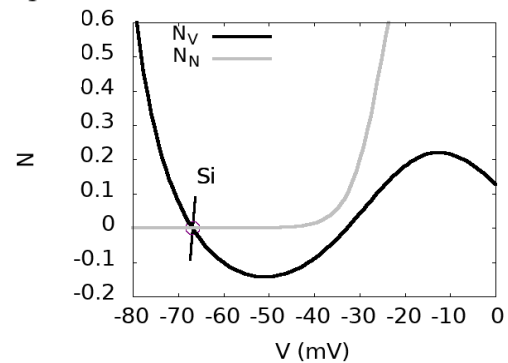
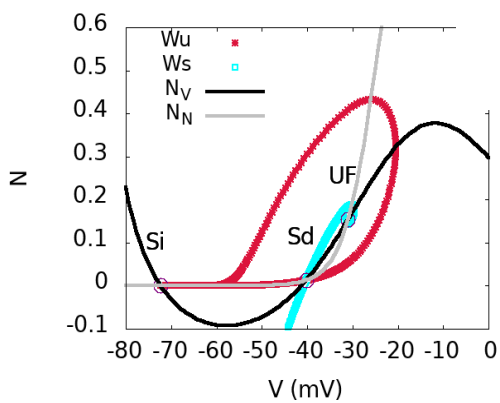

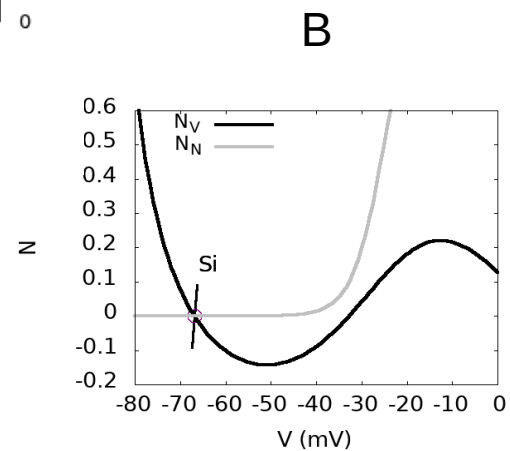
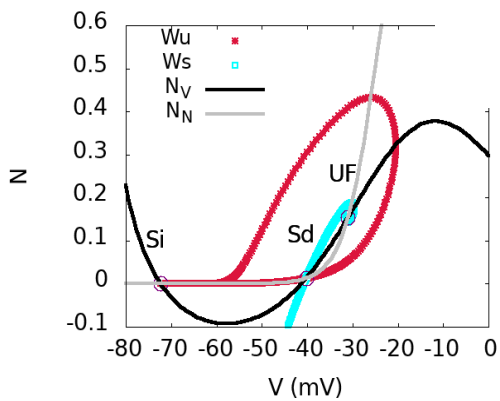
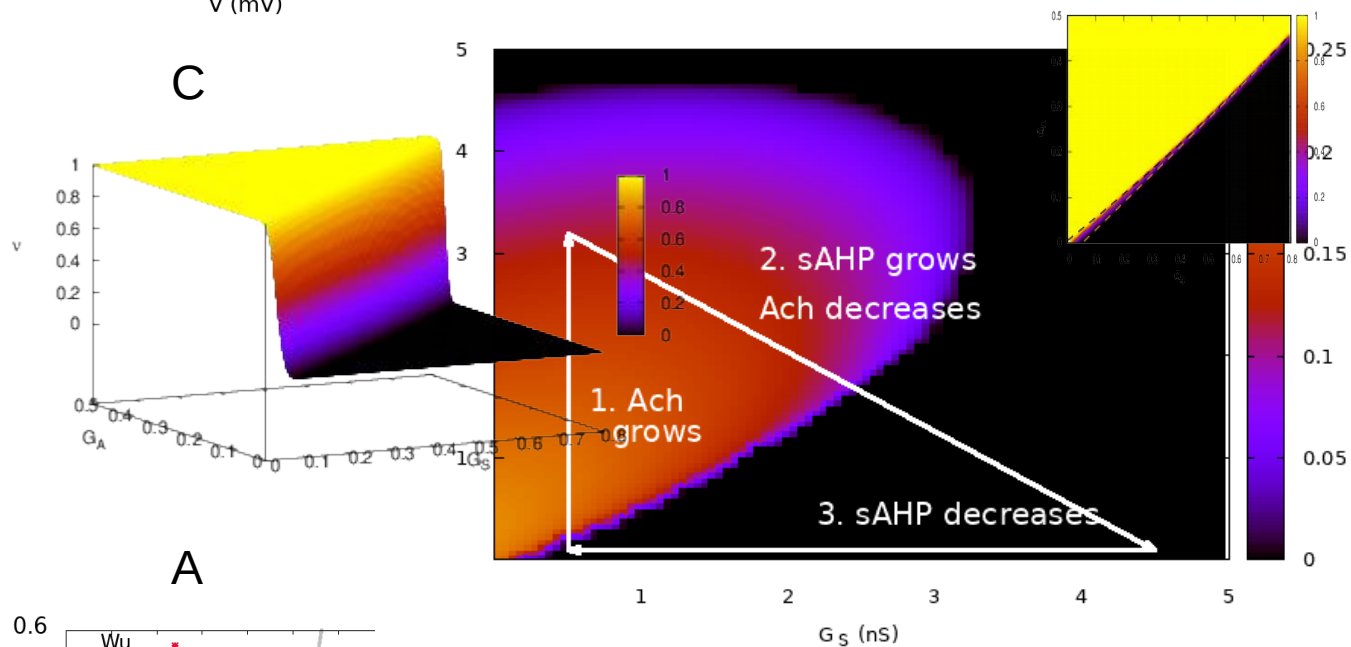
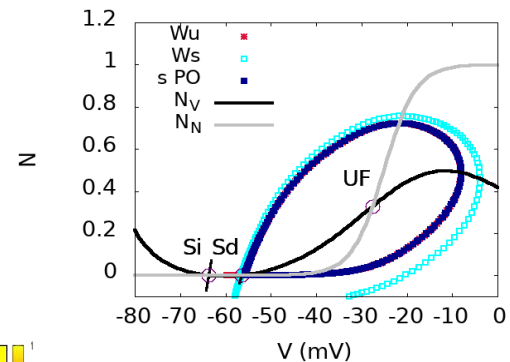
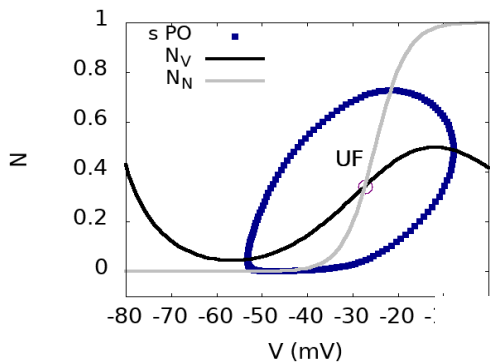

D

B

Waves propagation

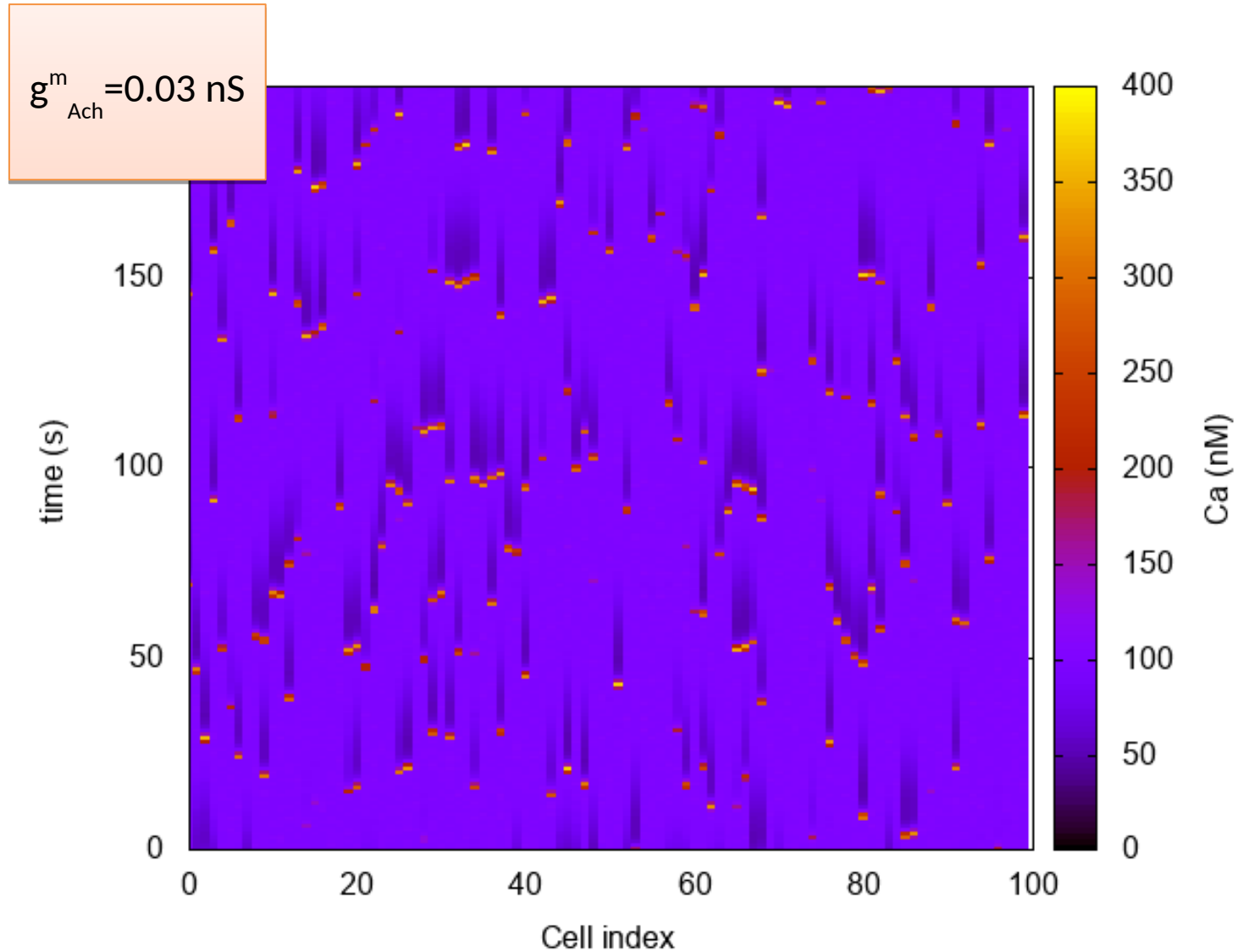

Waves propagation

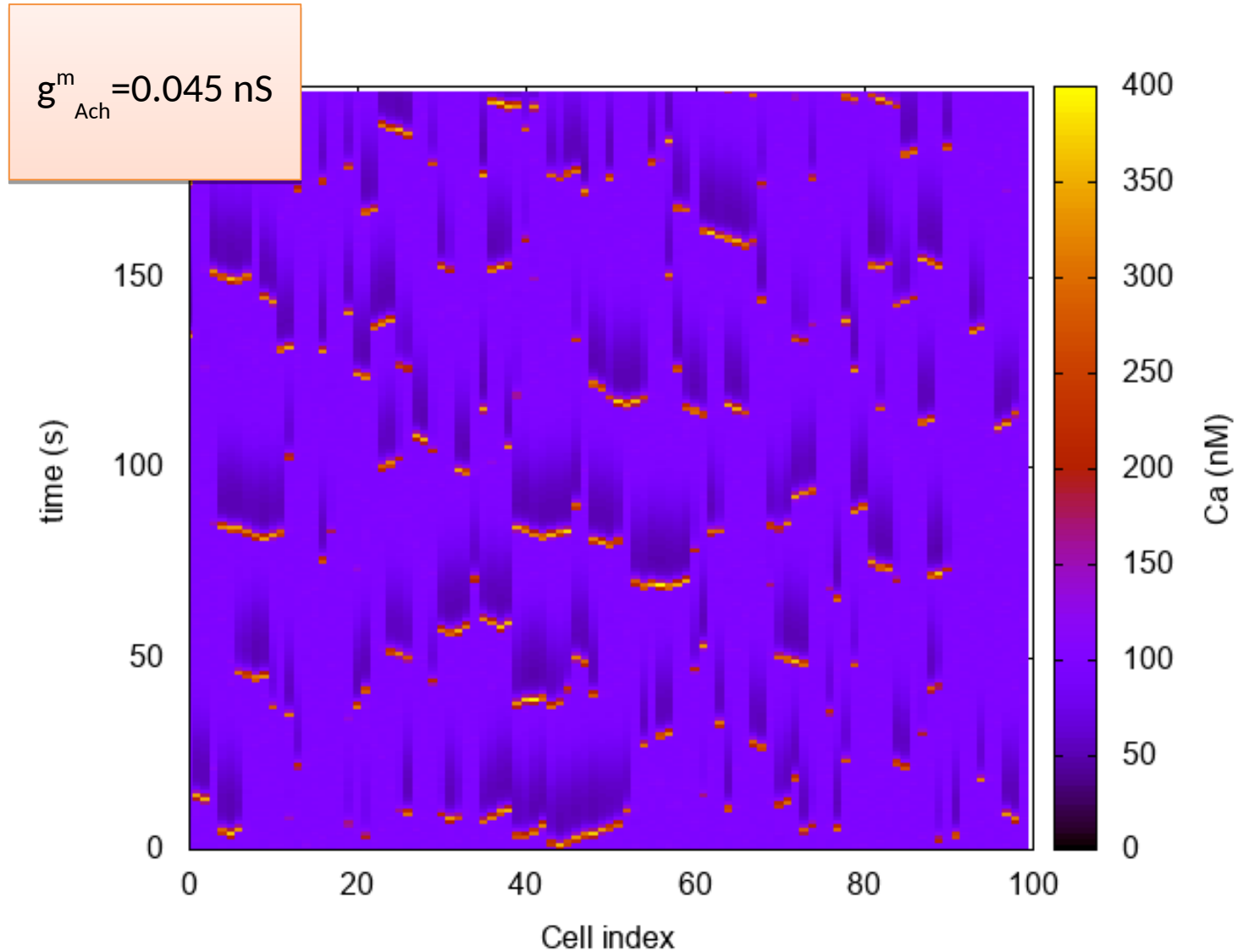

Waves propagation

$$g_{\text{Ach}}^m = 0.07 \text{ nS}$$

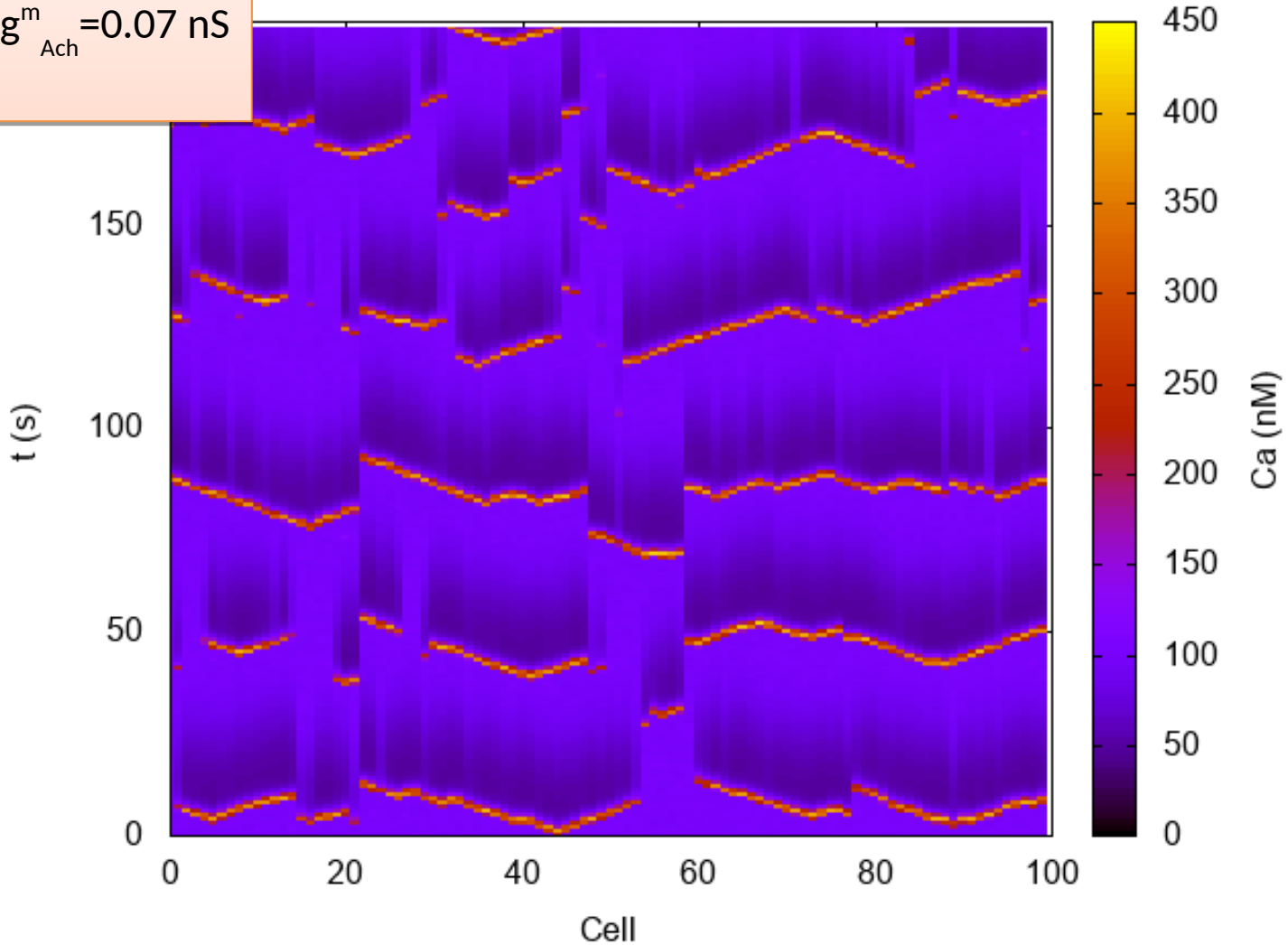

Waves propagation

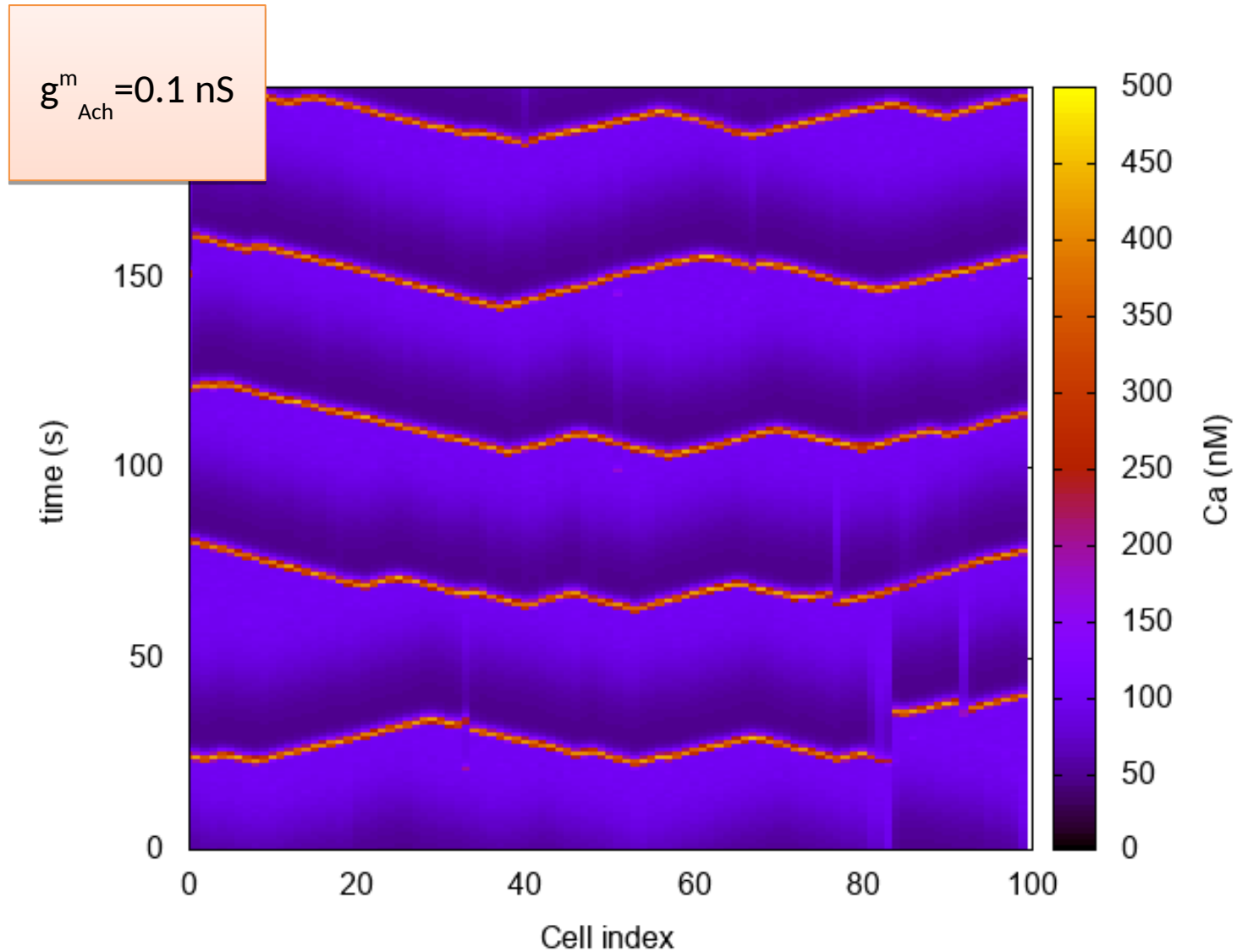

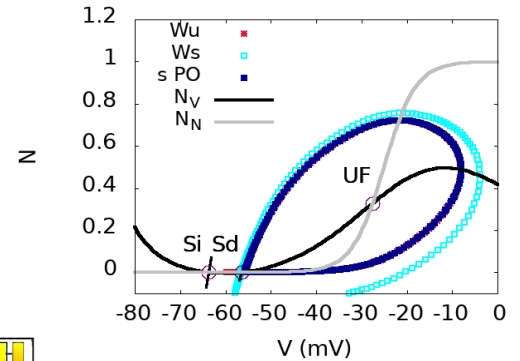
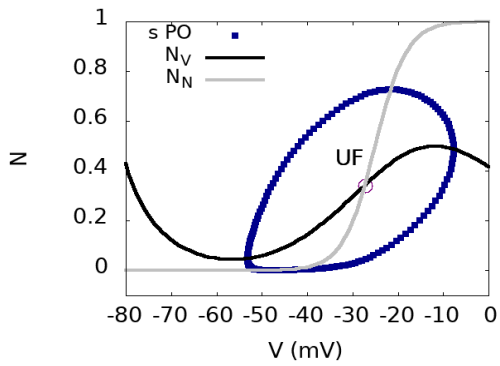

C

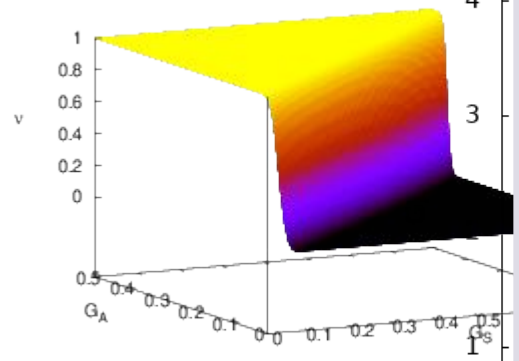

Question n° 1 to mathematicians :
 Is it possible to compute explicitly the probability to jump from Si to sPO for a given set of parameters g_S , g_A as well as the distribution of jumping times ?

D

A

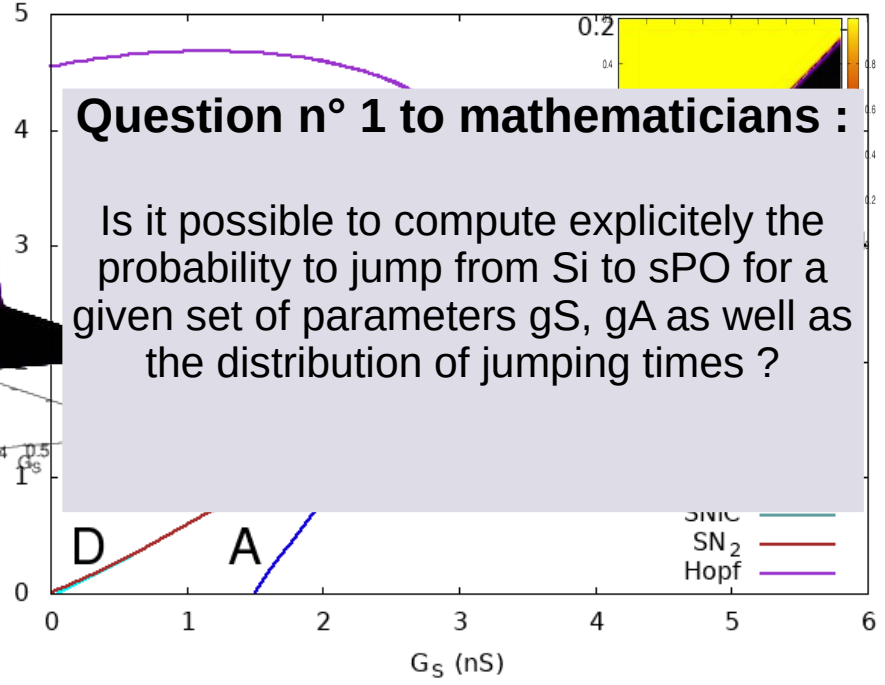
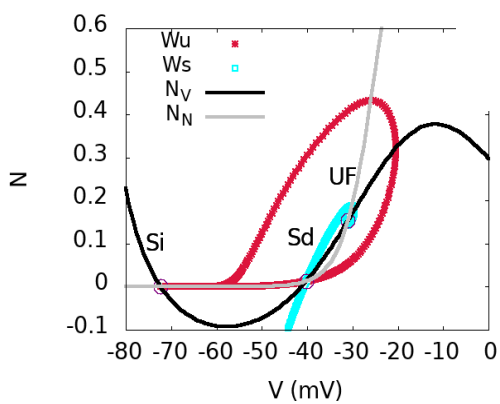

B

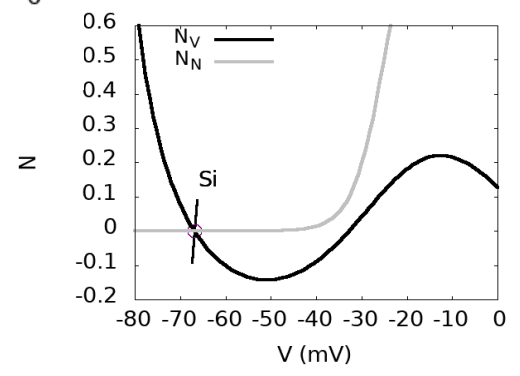

Waves size distribution

lin-log

log-log

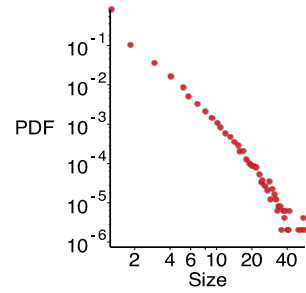
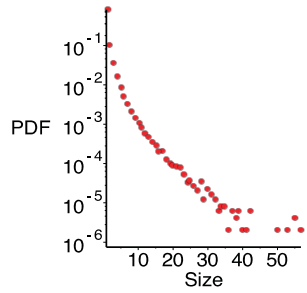
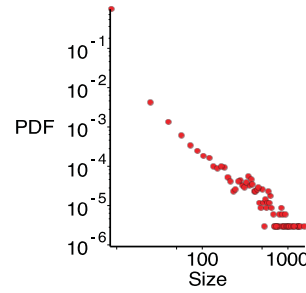
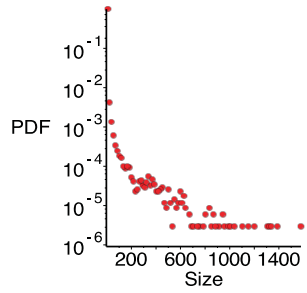
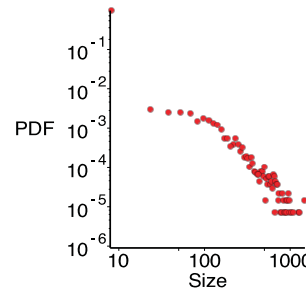
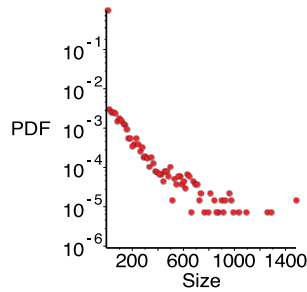
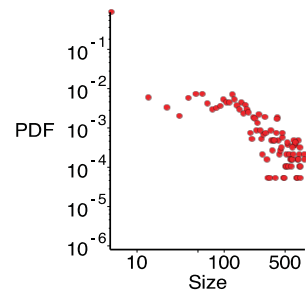
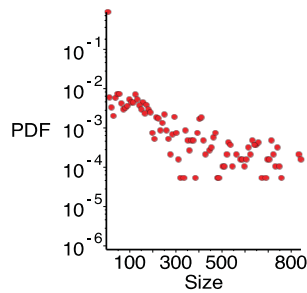
A**B****C****E**

Interburst(s)

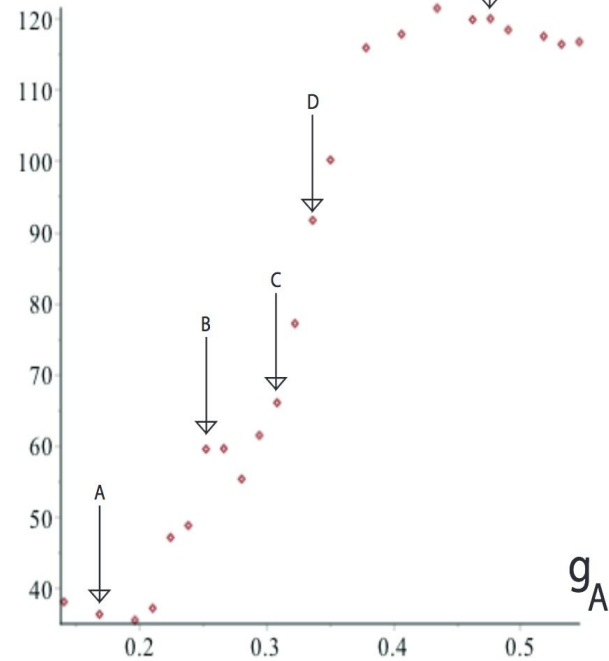

N-neuron model

- There is a **competition** between 2 mechanisms:
 - **Period variability** which tends **to desynchronise**
 - **Acetylcholine** which tends **to synchronise**
- There is an intermediate regime of coupling, where **variability** is maximum
- Therefore there is a wide repertoire of patterns
 - **Weak coupling** leads to small **localised activity**
 - **Moderate coupling** leads to **propagating patterns**
 - **Strong coupling** leads to **complete synchrony** of neurons

Variability within retinal waves

i) Across species

Godfrey et al. 2007

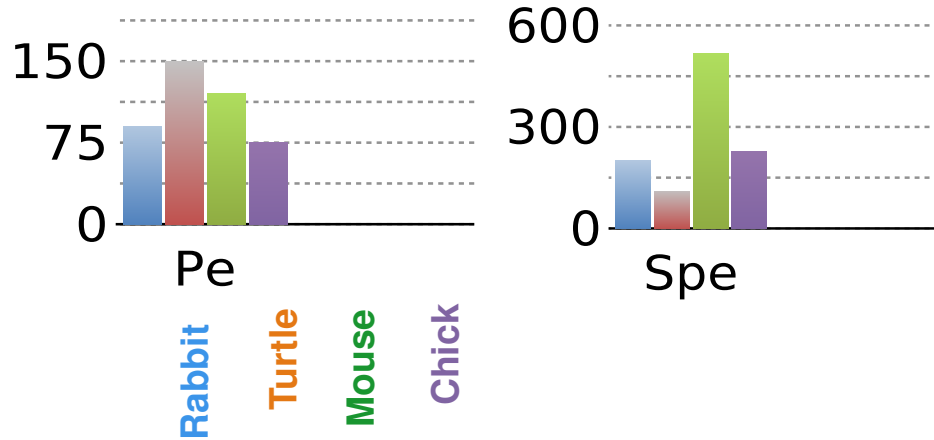

ii) Development

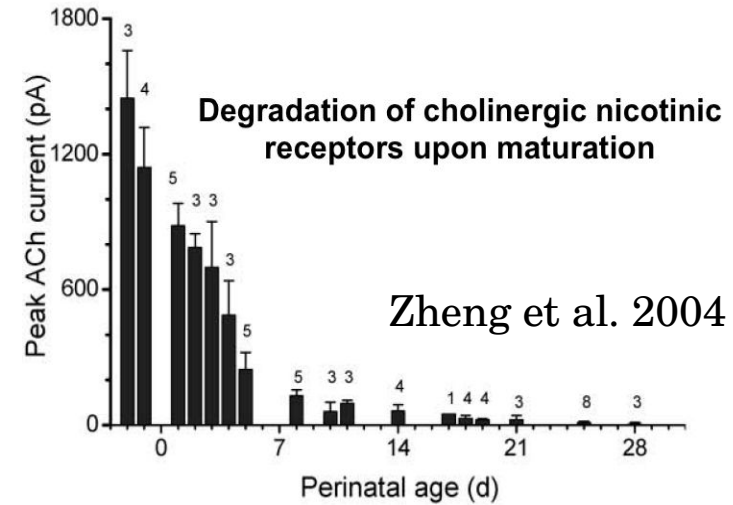

iii) Pharmacology

P4

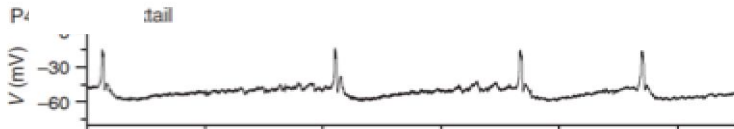

P8



0 Time (sec) 50

iv) Spatial Variability

Variability within retinal waves

i) Across species

Godfrey et al. 2007



ii) Development

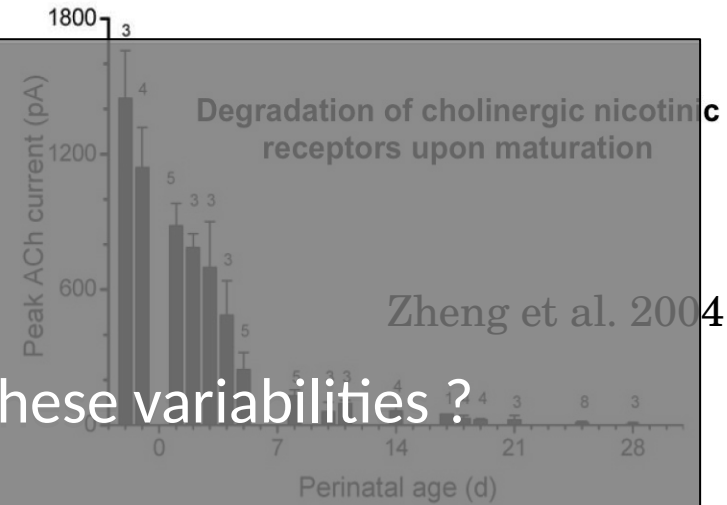

What are the sources of these variabilities?

iii) Pharmacology

P4



P8

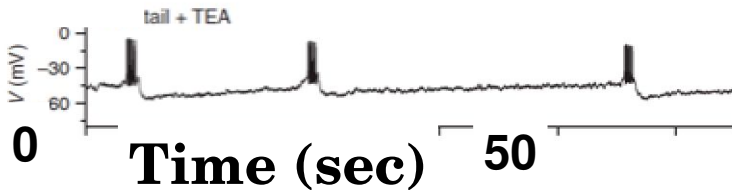

iv) Spatial Variability

Is there a unique, global, mechanism explaining them?

Variability within retinal waves

i) Across species

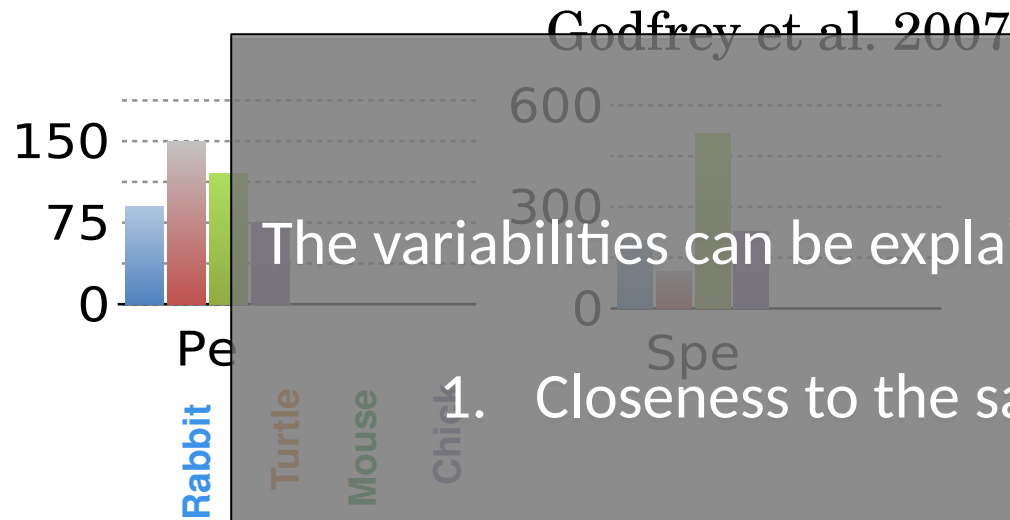

ii) Development

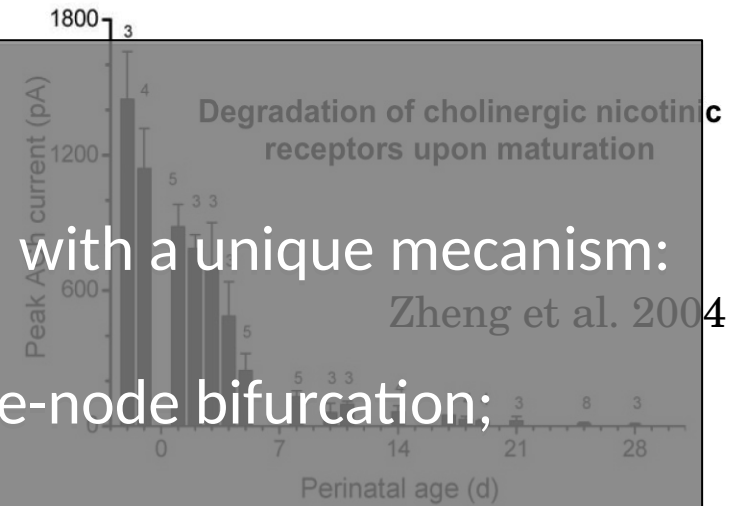

The variabilities can be explained with a unique mechanism:

1. Closeness to the saddle-node bifurcation;

2. Dynamic coupling via Ach.

3. Spatio-temporal variability of sAHP.

iii) Pharmacology

iv) Spatial Variability

P4



P8



0 Time (sec) 50

Variability within retinal waves

i) Across species

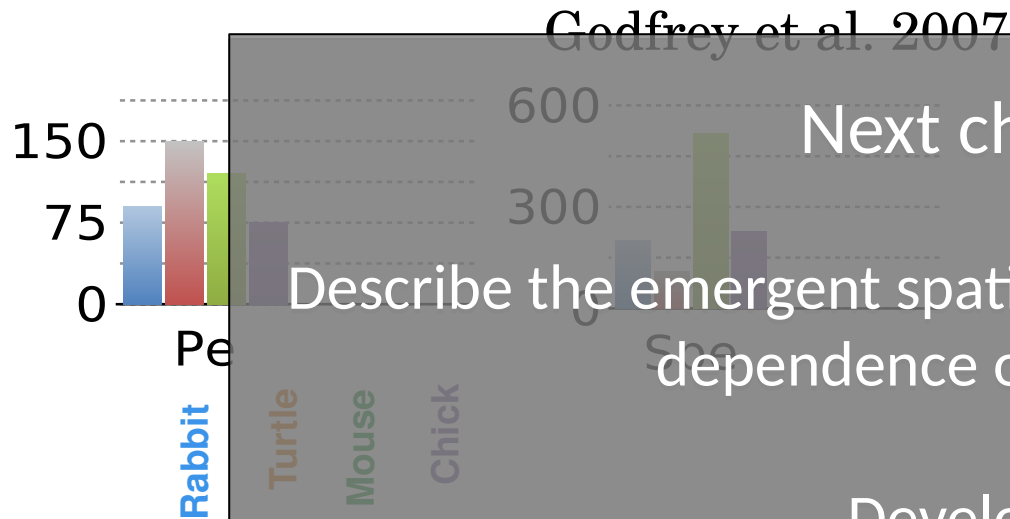

ii) Development

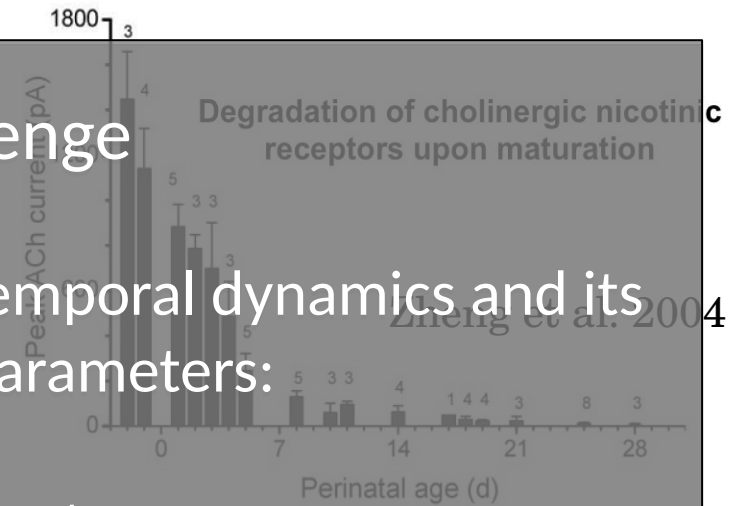

Next challenge

Describe the emergent spatio-temporal dynamics and its dependence on parameters:

Development

iii) Pharmacology

P4



P8



0 Time (sec) 50

iv) Spatial Variability

Pharmacological control

Pathologies.

Retinal anticipation

Random connectivity and motion anticipation

S. Souihel (PhD 2016-2019), Biovision team,
INRIA, Sophia Antipolis

F. Chavane, INT, Marseille

A. Destexhe, UNIC, Paris

O. Marre, Institut de la Vision, Paris

B. Cessac, Biovision team, INRIA, Sophia Antipolis



Project : ANR Trajectory.

The visual flow

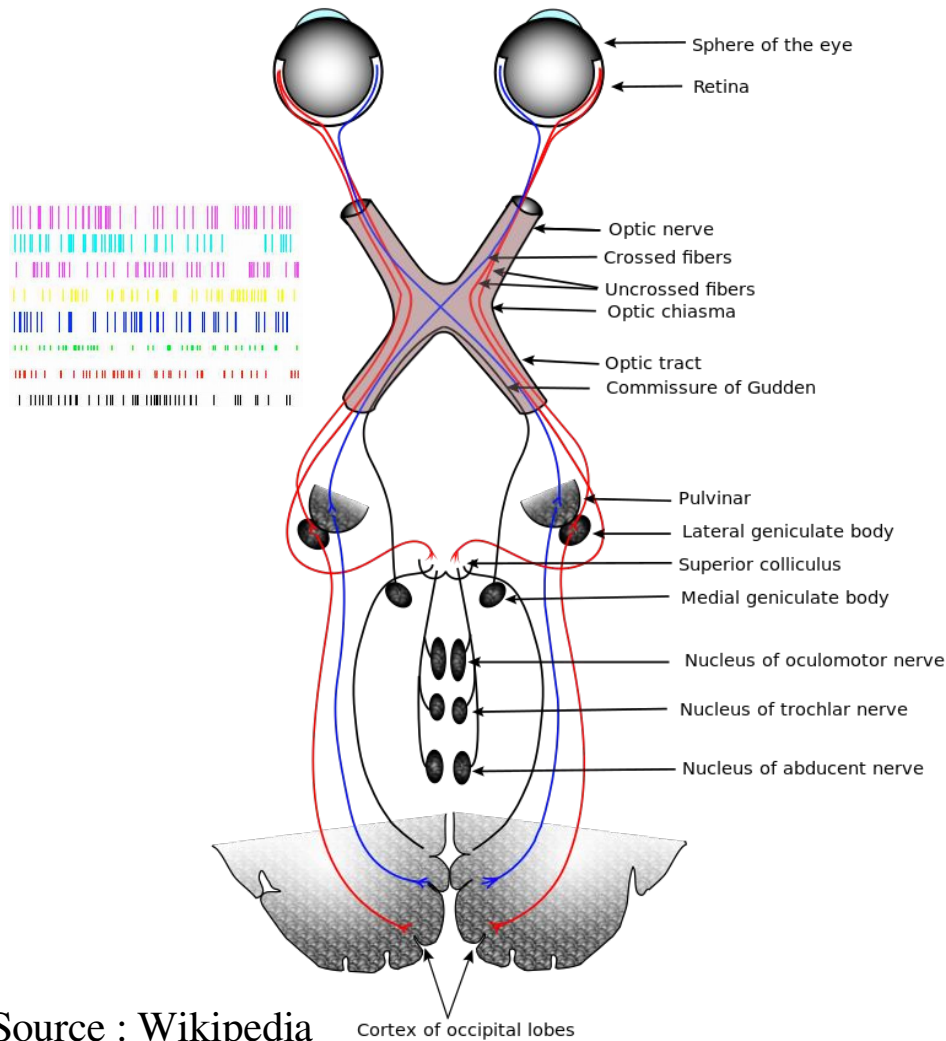

Source : Wikipedia

The visual flow

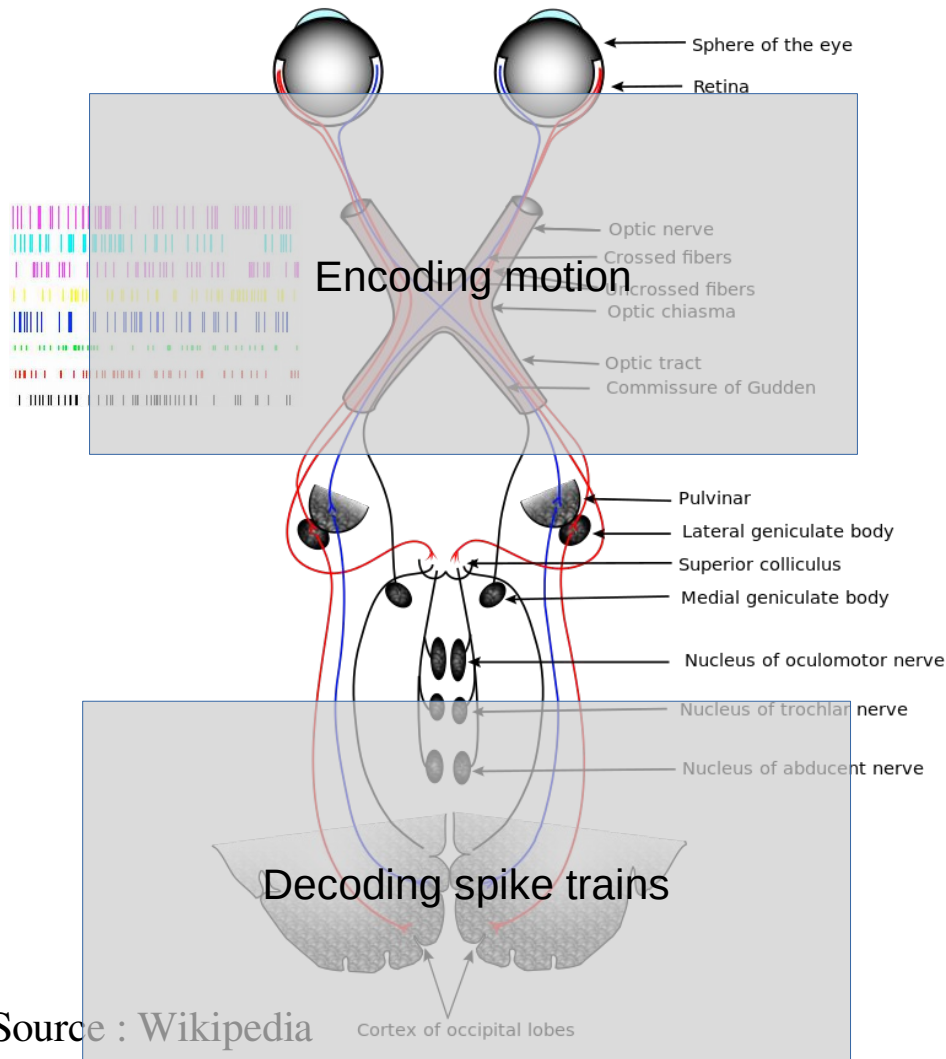

The visual flow

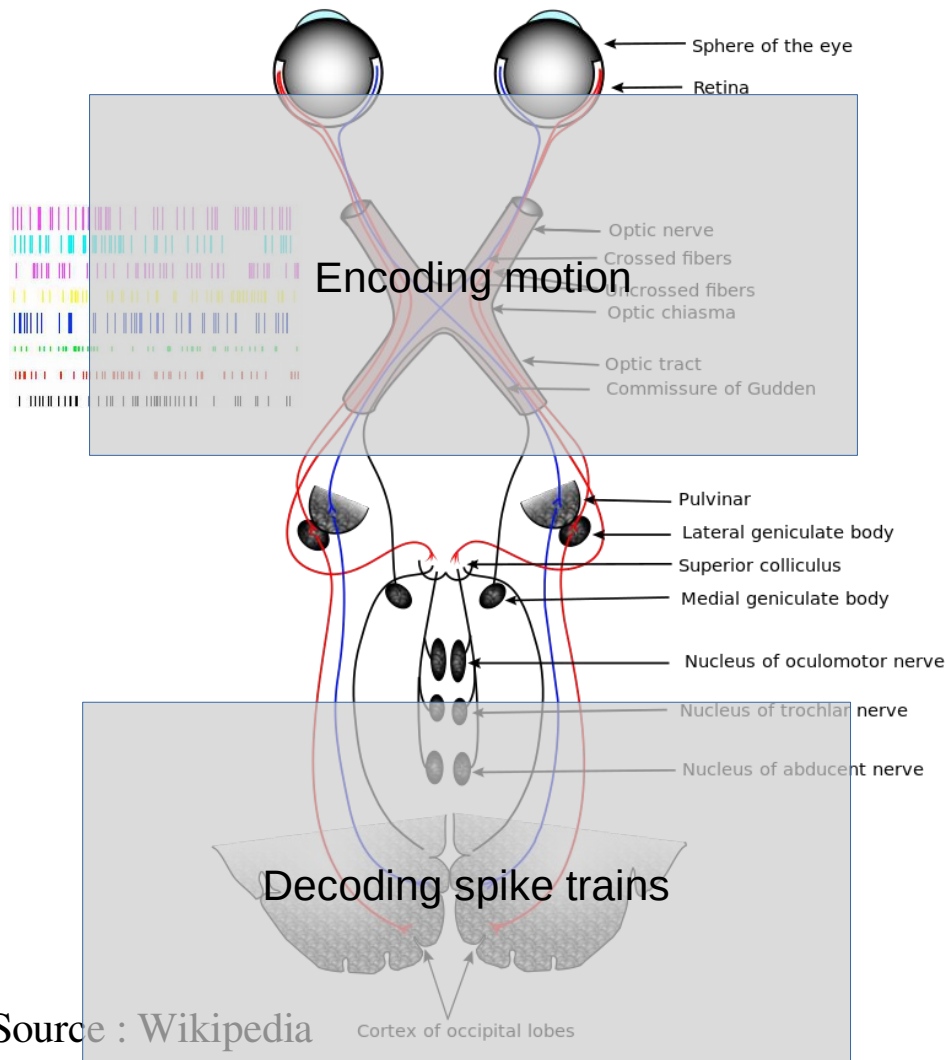

- **The retina is NOT a camera**
- High transduction rate : 1 photon can trigger a membrane voltage variation of ~1 mV
- Able to detect approaching motion
- Able to detect differential motion
- Sensitive to « surprise » in a visual scene
- Able to perform motion anticipation

The visual flow

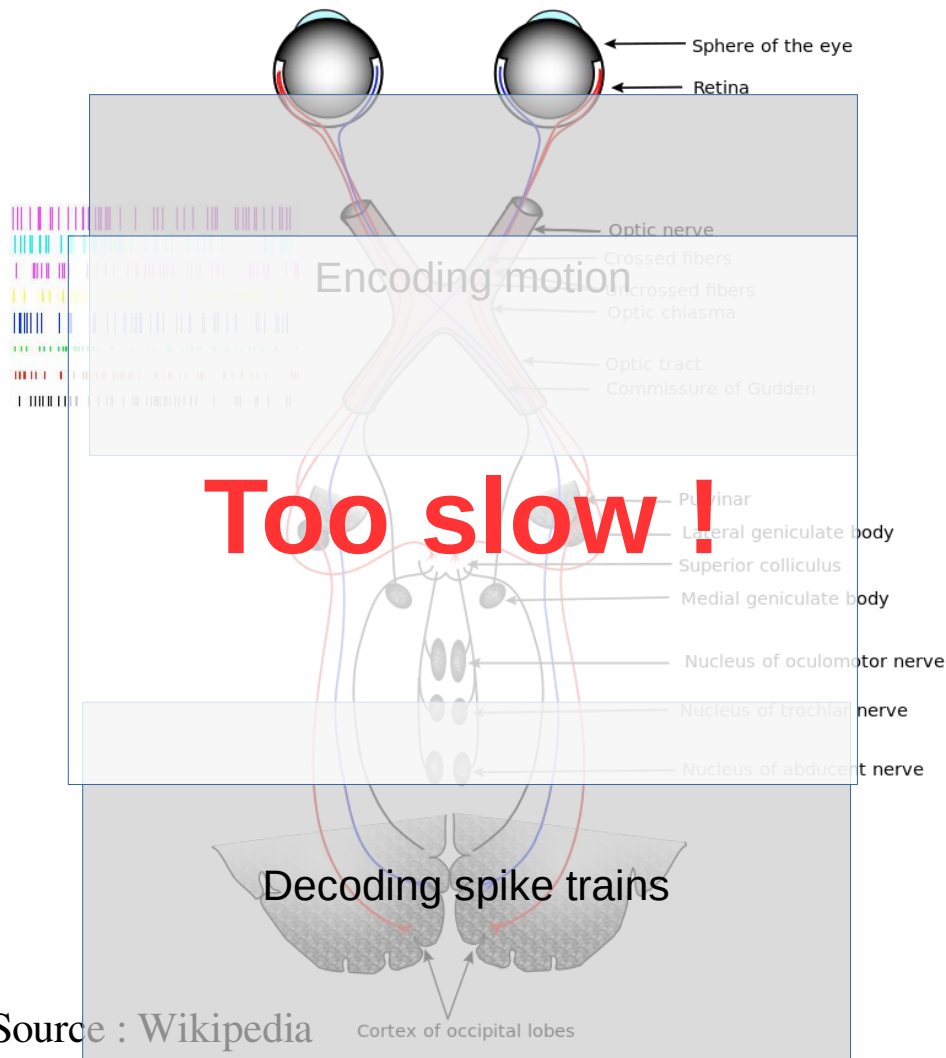

- **The retina is NOT a camera**
- High transduction rate : 1 photon can trigger a membrane voltage variation of ~1 mV
- Able to detect approaching motion
- Able to detect differential motion
- Sensitive to « surprise » in a visual scene
- Able to perform motion anticipation

Visual Anticipation

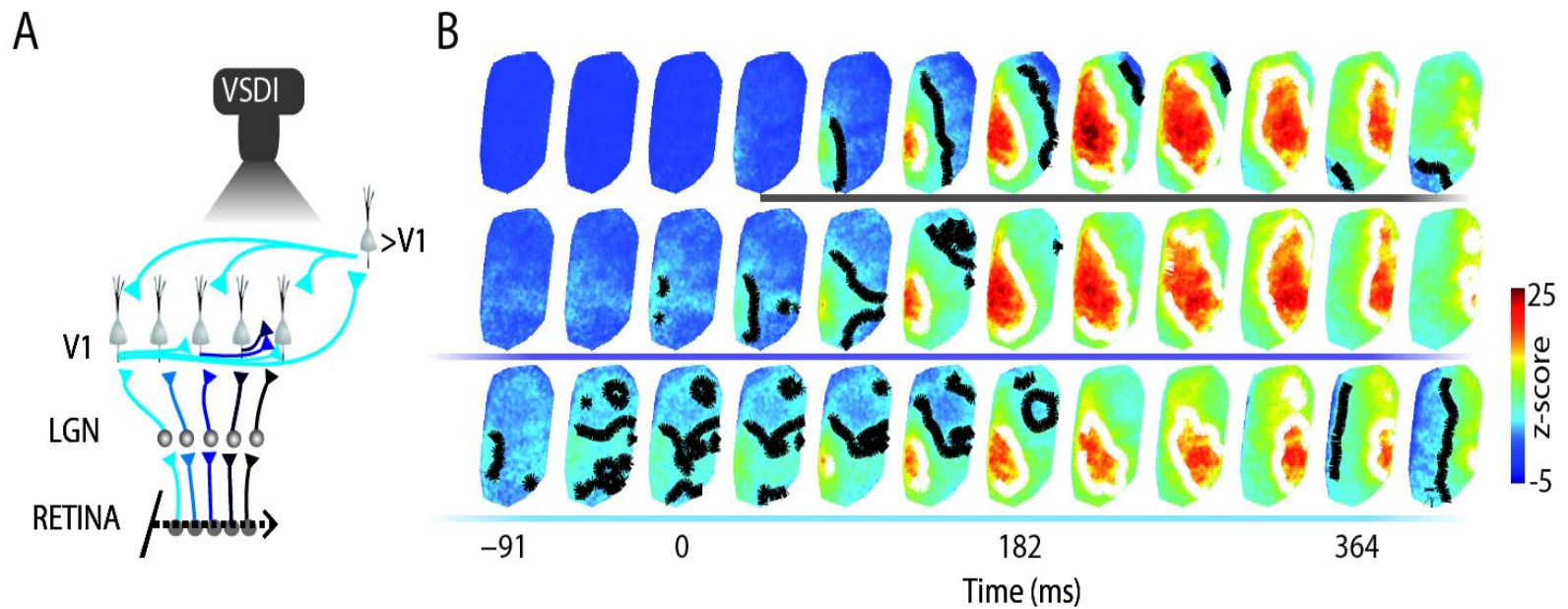

Source : Benvenuti et al. 2015

Visual Anticipation

Anticipation is carried out by the primary visual cortex (V1) through an activation wave

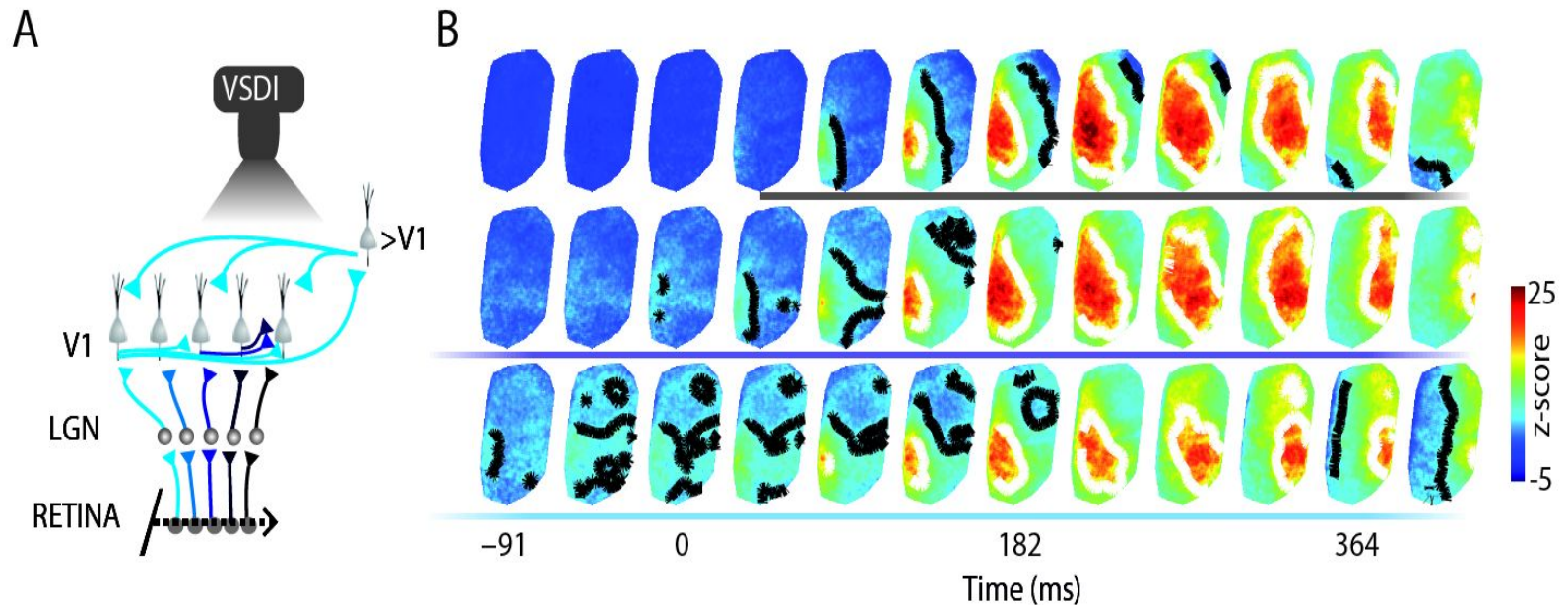

Source : Benvenuti et al. 2015

Visual Anticipation

Anticipation also takes place in the retina

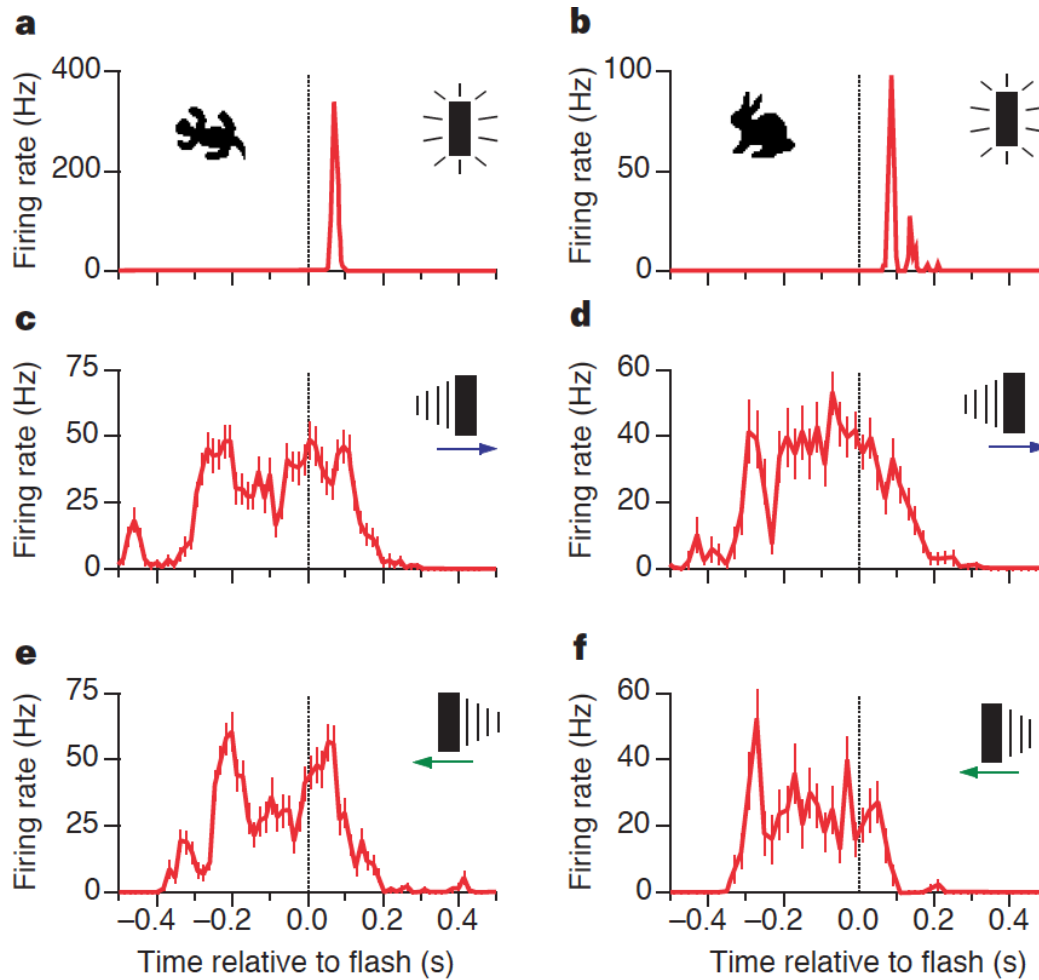

Source :
Berry et al.
1999

Building a 2D retina model for motion anticipation

Souihel S., Cessac B., “On the potential role of lateral connectivity in retinal anticipation”, *Journal of Mathematical Neuroscience*, BioMed Central, 2021, 11, {10.1186/s13408-020-00101-z}

Building a 2D retina model for motion anticipation

Souihel S., Cessac B., “On the potential role of lateral connectivity in retinal anticipation”, Journal of Mathematical Neuroscience, BioMed Central, 2021, 11, {10.1186/s13408-020-00101-z}

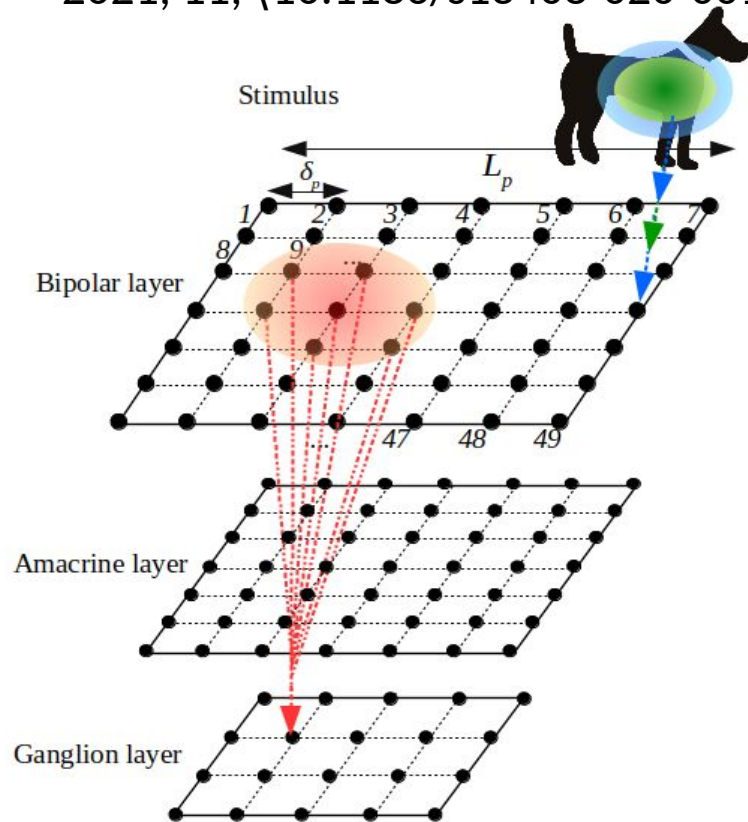

Building a 2D retina model for motion anticipation

Souihel S., Cessac B., "On the potential role of lateral connectivity in retinal anticipation", Journal of Mathematical Neuroscience, BioMed Central, 2021, 11, (10.1186/s13408-020-00101-z)

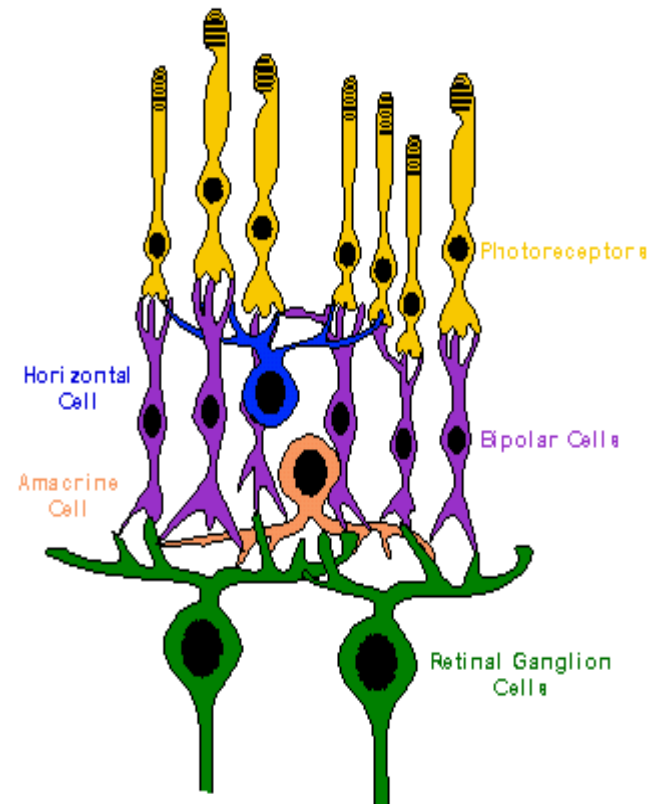
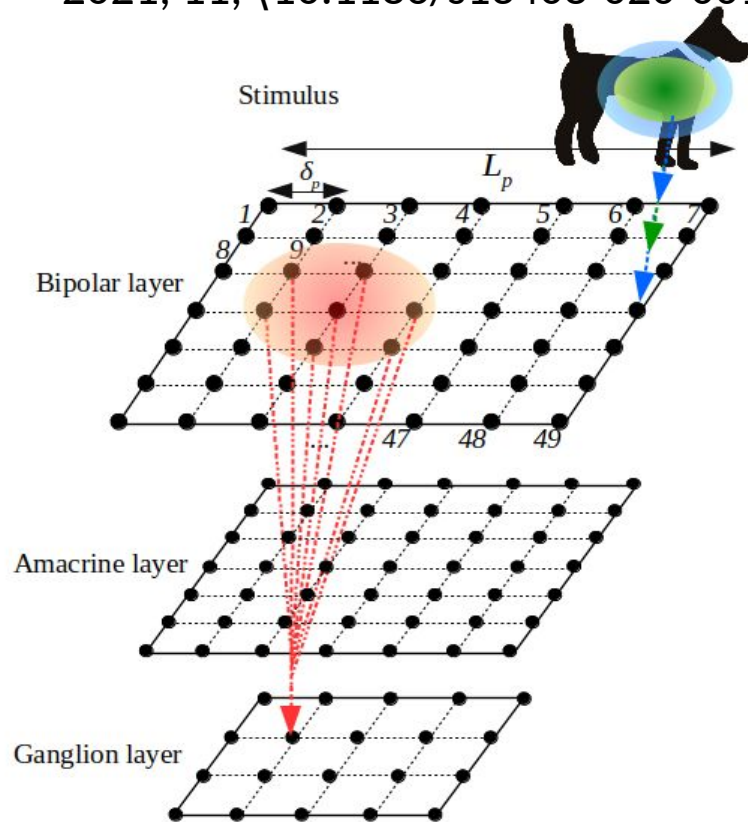

Building a 2D retina model for motion anticipation

Souihel S., Cessac B., "On the potential role of lateral connectivity in retinal anticipation", Journal of Mathematical Neuroscience, BioMed Central, 2021, 11, {10.1186/s13408-020-00101-z}

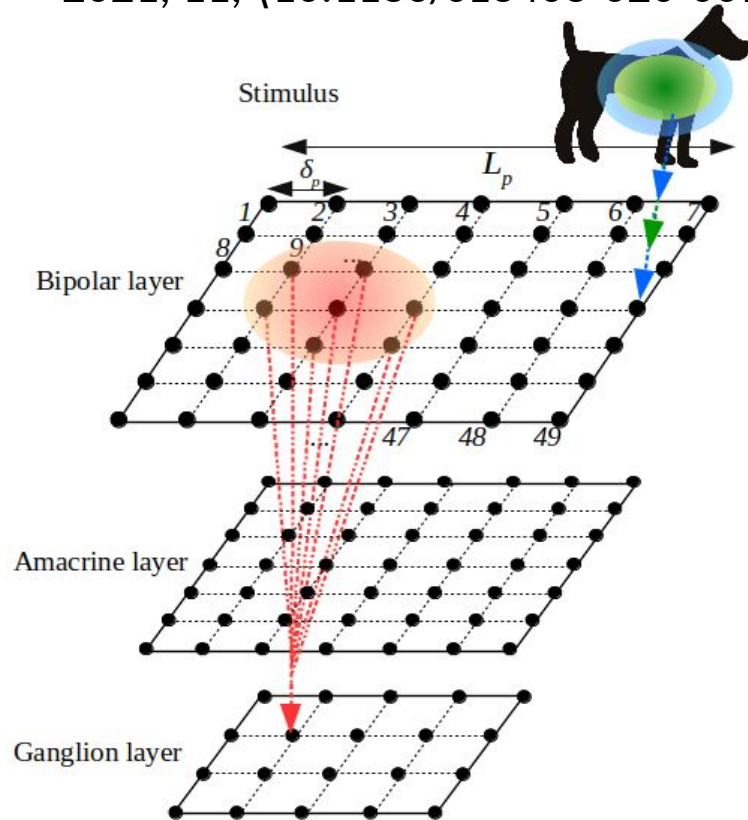

Modelled by a convolution kernel

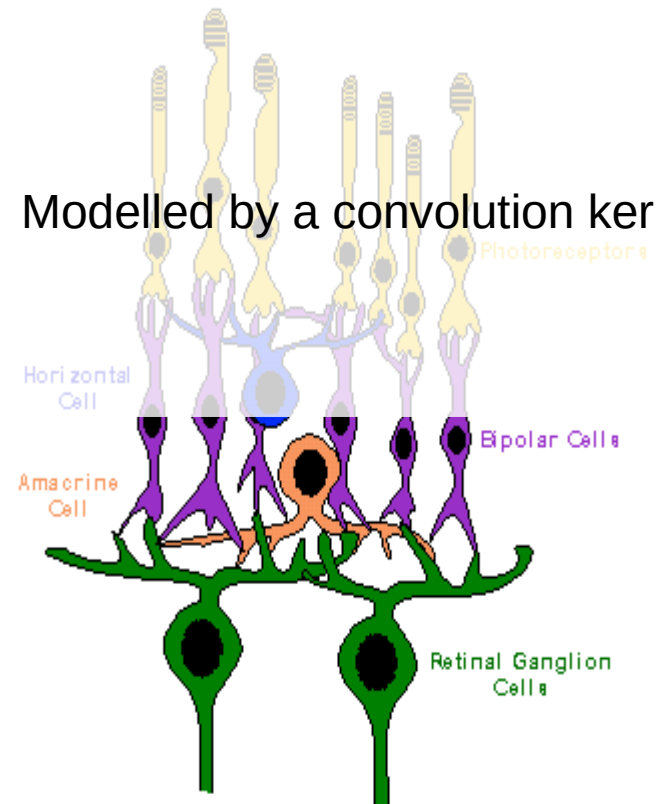

Building a 2D retina model for motion anticipation

Souihel S., Cessac B., "On the potential role of lateral connectivity in retinal anticipation", Journal of Mathematical Neuroscience, BioMed Central, 2021, 11, <10.1186/s13408-020-00101-z>

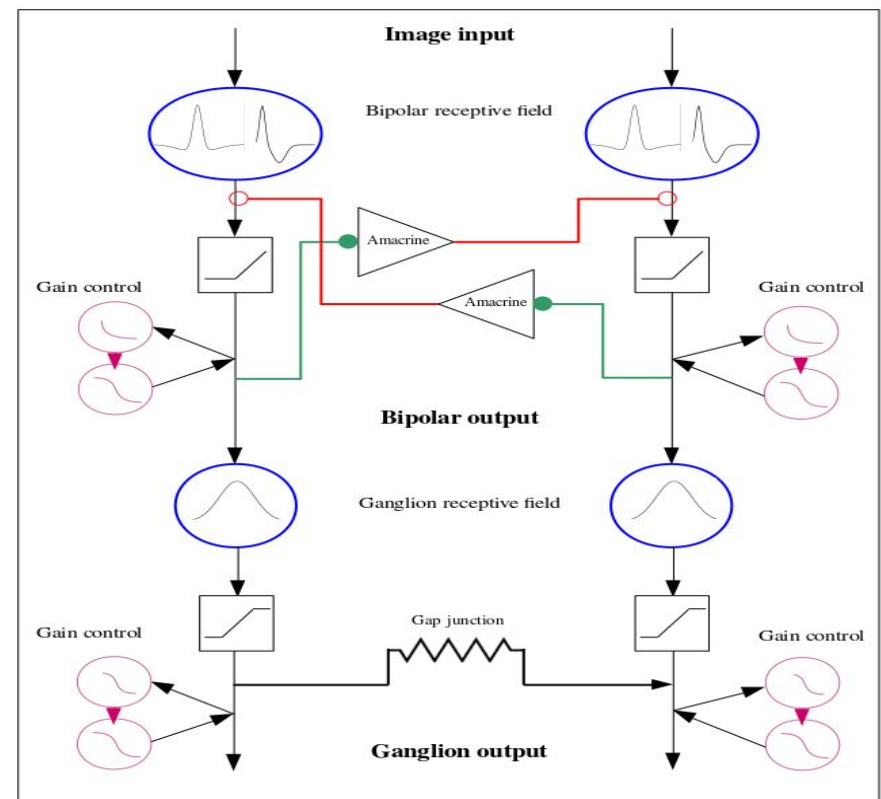
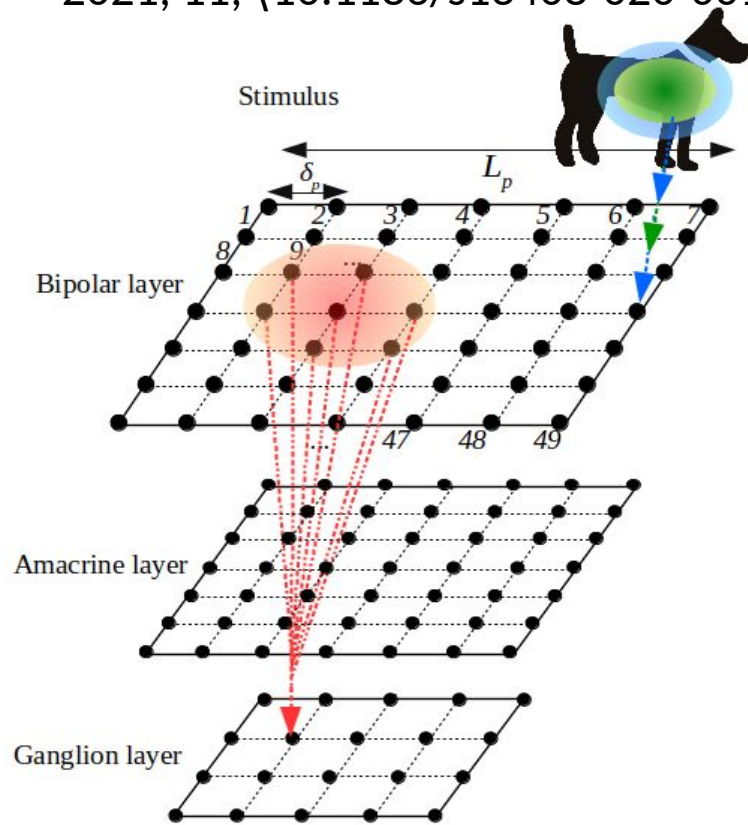

Building a 2D retina model for motion anticipation

Souihel S., Cessac B., “On the potential role of lateral connectivity in retinal anticipation”, Journal of Mathematical Neuroscience, BioMed Central, 2021, 11, {10.1186/s13408-020-00101-z}

$$\begin{cases} \frac{dV_{B_i}}{dt} = -\frac{1}{\tau_B} V_{B_i} + \sum_{j=1}^{N_A} W_{B_i}^{A_j} V_{A_j} + F_{B_i}(t), \\ \frac{dV_{A_j}}{dt} = -\frac{1}{\tau_A} V_{A_j} + \sum_{i=1}^{N_B} W_{A_j}^{B_i} R_{B_i}, \\ \frac{dA_{B_i}}{dt} = -\frac{A_{B_i}}{\tau_a} + h_B \mathcal{N}(V_{B_i}). \end{cases}$$

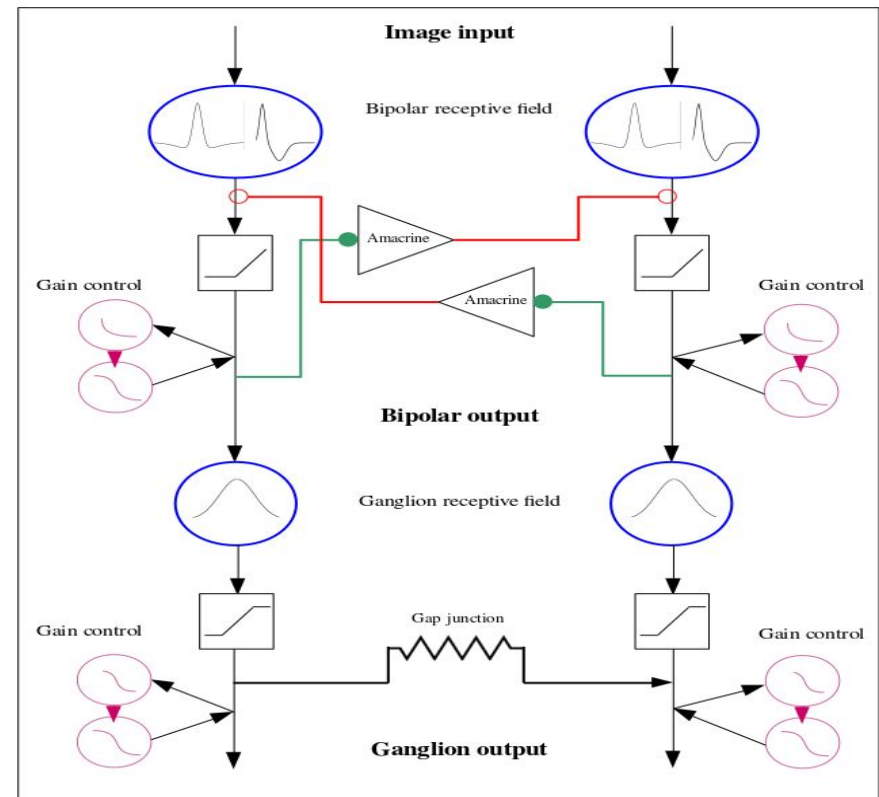

Building a 2D retina model for motion anticipation

Souihel S., Cessac B., "On the potential role of lateral connectivity in retinal anticipation", Journal of Mathematical Neuroscience, BioMed Central, 2021, 11, <10.1186/s13408-020-00101-z>

Stimulus dependent drive

$$\left\{ \begin{aligned} \frac{dV_{B_i}}{dt} &= -\frac{1}{\tau_B} V_{B_i} + \sum_{j=1}^{N_A} W_{B_i}^{A_j} V_{A_j} + F_{B_i}(t), \\ \frac{dV_{A_j}}{dt} &= -\frac{1}{\tau_A} V_{A_j} + \sum_{i=1}^{N_B} W_{A_j}^{B_i} R_{B_i}, \\ \frac{dA_{B_i}}{dt} &= -\frac{A_{B_i}}{\tau_a} + h_B \mathcal{N}(V_{B_i}). \end{aligned} \right.$$

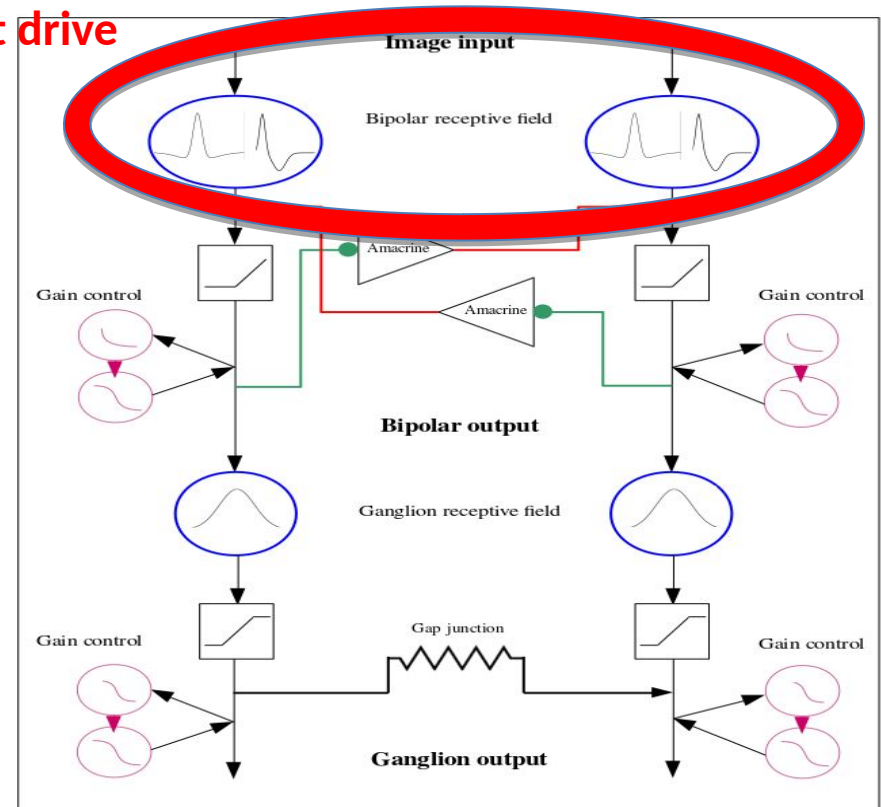

Building a 2D retina model for motion anticipation

Souihel S., Cessac B., "On the potential role of lateral connectivity in retinal anticipation", Journal of Mathematical Neuroscience, BioMed Central, 2021, 11, {10.1186/s13408-020-00101-z}

$$\left\{ \begin{aligned} \frac{dV_{B_i}}{dt} &= -\frac{1}{\tau_B} V_{B_i} + \sum_{j=1}^{N_A} W_{B_i}^{A_j} V_{A_j} + F_{B_i}(t), \\ \frac{dV_{A_j}}{dt} &= -\frac{1}{\tau_A} V_{A_j} + \sum_{i=1}^{N_B} W_{A_j}^{B_i} R_{B_i}, \\ \frac{dA_{B_i}}{dt} &= -\frac{A_{B_i}}{\tau_a} + h_B \mathcal{N}(V_{B_i}). \end{aligned} \right.$$

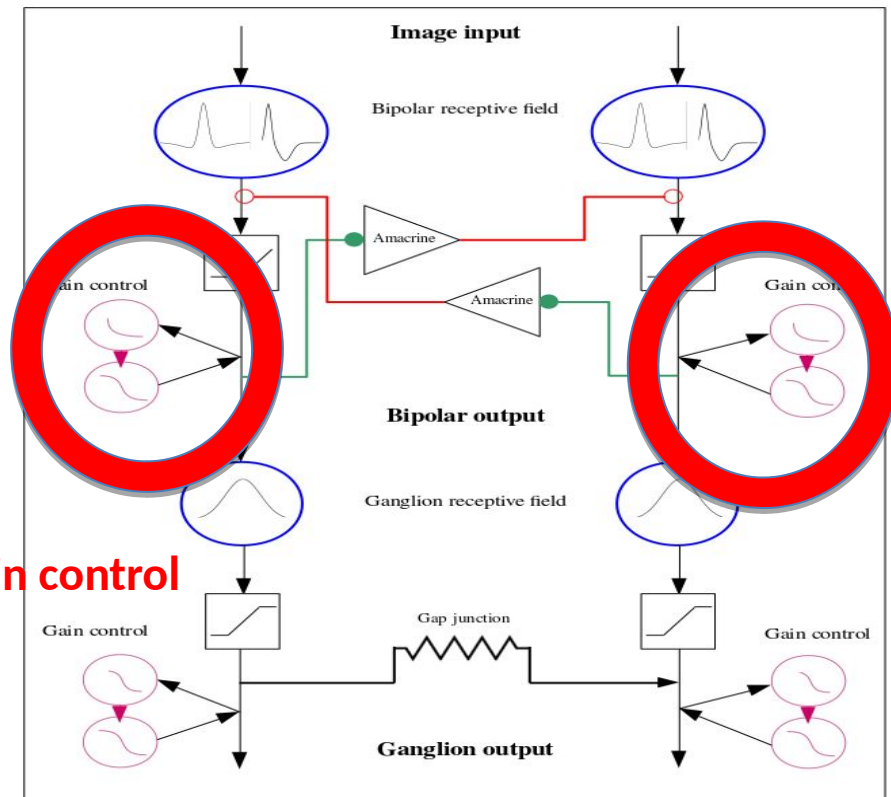

Building a 2D retina model for motion anticipation

Souihel S., Cessac B., “On the potential role of lateral connectivity in retinal anticipation”, Journal of Mathematical Neuroscience, BioMed Central, 2021, 11, {10.1186/s13408-020-00101-z}

$$\left\{ \begin{aligned} \frac{dV_{B_i}}{dt} &= -\frac{1}{\tau_B} V_{B_i} + \sum_{j=1}^{N_A} W_{B_i}^{A_j} V_{A_j} + F_{B_i}(t), \\ \frac{dV_{A_j}}{dt} &= -\frac{1}{\tau_A} V_{A_j} + \sum_{i=1}^{N_B} W_{A_j}^{B_i} R_{B_i}, \\ \frac{dA_{B_i}}{dt} &= -\frac{A_{B_i}}{\tau_a} + h_B \mathcal{N}(V_{B_i}). \end{aligned} \right.$$

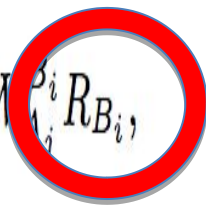

Non linear gain control

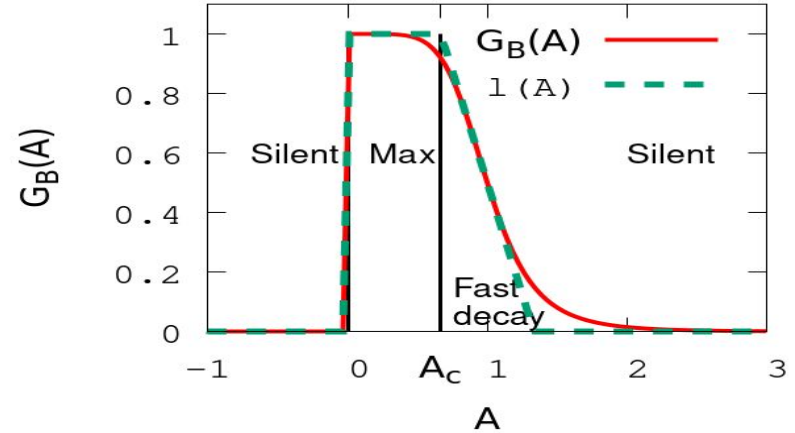

Building a 2D retina model for motion anticipation

Souihel S., Cessac B., "On the potential role of lateral connectivity in retinal anticipation", Journal of Mathematical Neuroscience, BioMed Central, 2021, 11, <10.1186/s13408-020-00101-z>

$$\left\{ \begin{aligned} \frac{dV_{B_i}}{dt} &= -\frac{1}{\tau_B} V_{B_i} + \sum_{j=1}^{N_A} W_{B_i}^{A_j} V_{A_j} + F_{B_i}(t), \\ \frac{dV_{A_j}}{dt} &= -\frac{1}{\tau_A} V_{A_j} + \sum_{i=1}^{N_B} W_{A_j}^{B_i} R_{B_i}, \\ \frac{dA_{B_i}}{dt} &= -\frac{A_{B_i}}{\tau_a} + h_B \mathcal{N}(V_{B_i}). \end{aligned} \right.$$

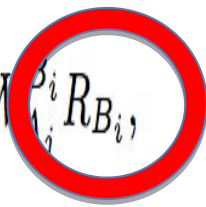

Non linear gain control

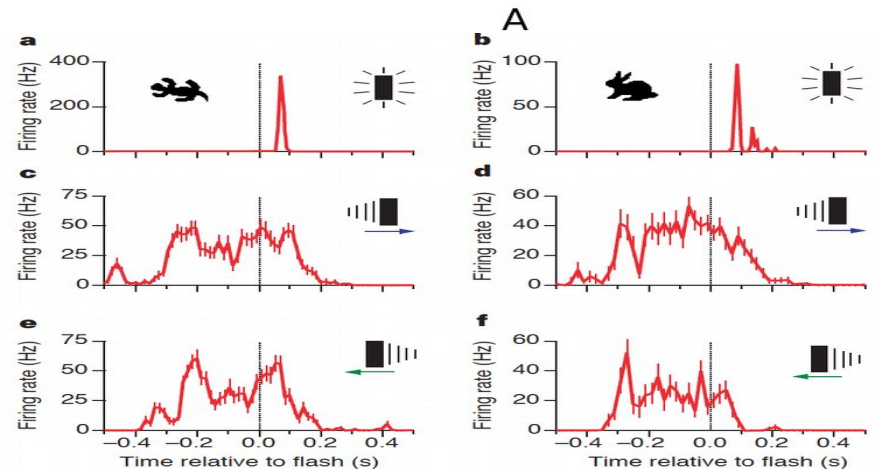
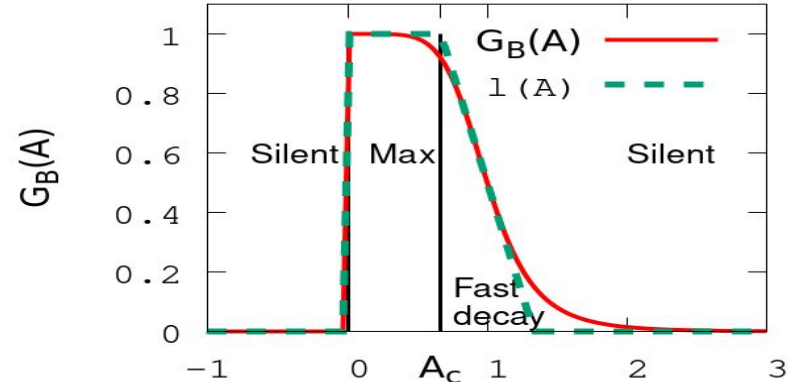

Building a 2D retina model for motion anticipation

Souihel S., Cessac B., “On the potential role of lateral connectivity in retinal anticipation”, Journal of Mathematical Neuroscience, BioMed Central, 2021, 11, <10.1186/s13408-020-00101-z>

Inhibition

$$\left\{ \begin{aligned} \frac{dV_{B_i}}{dt} &= -\frac{1}{\tau_B} V_{B_i} + \sum_{j=1}^N W_{B_i}^{A_j} V_{A_j} + F_{B_i}(t), \\ \frac{dV_{A_j}}{dt} &= -\frac{1}{\tau_A} V_{A_j} + \sum_{i=1}^{N_B} W_{A_j}^{B_i} R_{B_i}, \\ \frac{dA_{B_i}}{dt} &= -\frac{A_{B_i}}{\tau_a} + h_B \mathcal{N}(V_{B_i}). \end{aligned} \right.$$

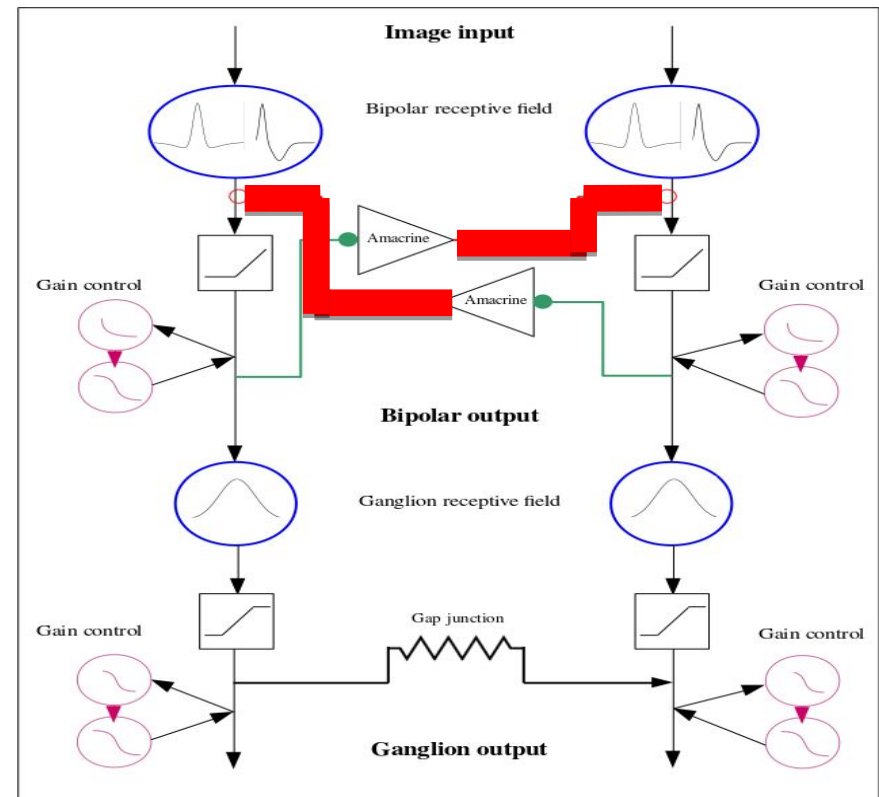

Building a 2D retina model for motion anticipation

Souihel S., Cessac B., "On the potential role of lateral connectivity in retinal anticipation", Journal of Mathematical Neuroscience, BioMed Central, 2021, 11, <10.1186/s13408-020-00101-z>

$$\left\{ \begin{aligned} \frac{dV_{B_i}}{dt} &= -\frac{1}{\tau_B} V_{B_i} + \sum_{j=1}^{N_A} W_{B_i}^{A_j} V_{A_j} + F_{B_i}(t), \\ \frac{dV_{A_j}}{dt} &= -\frac{1}{\tau_A} V_{A_j} + \sum_{i=1}^B W_{A_j}^{B_i} R_{B_i}, \\ \frac{dA_{B_i}}{dt} &= -\frac{A_{B_i}}{\tau_a} + h_B \mathcal{N}(V_{B_i}). \end{aligned} \right.$$

Excitation

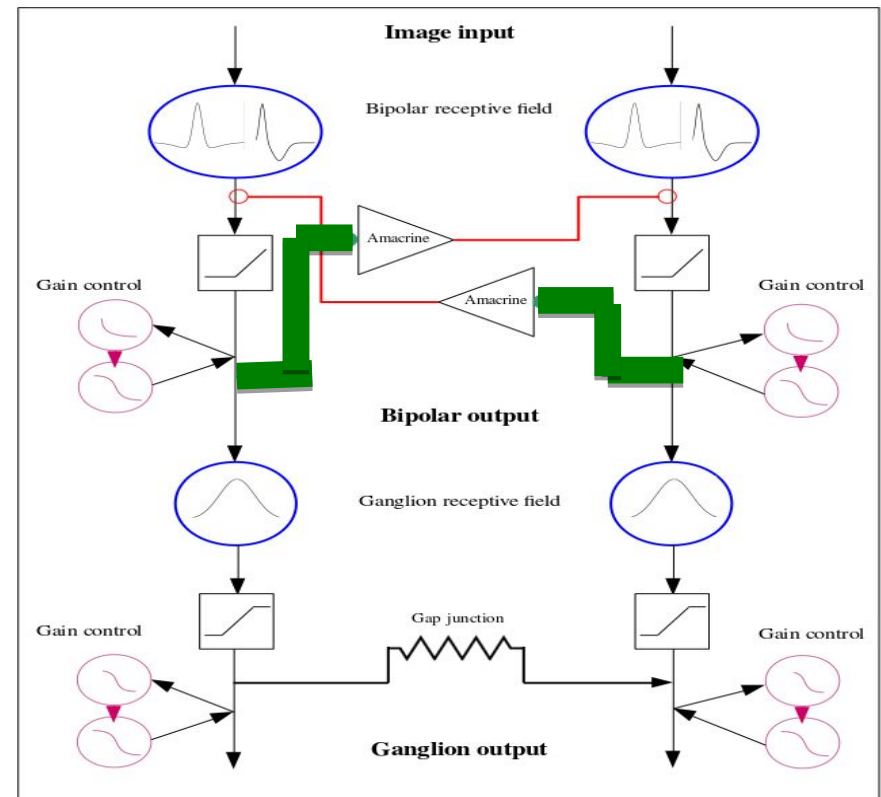

Building a 2D retina model for motion anticipation

Souihel S., Cessac B., "On the potential role of lateral connectivity in retinal anticipation", Journal of Mathematical Neuroscience, BioMed Central, 2021, 11, <10.1186/s13408-020-00101-z>

Linear regime

$$\frac{d\vec{\chi}}{dt} = \mathcal{L} \cdot \vec{\chi} + \vec{F}(t).$$

$$\mathcal{L} = \begin{pmatrix} -\frac{I_{N,N}}{\tau_B} & W_B^A & 0_{N,N} \\ W_A^B & -\frac{I_{N,N}}{\tau_A} & 0_{N,N} \\ h_B I_{N,N} & 0_{N,N} & -\frac{I_{N,N}}{\tau_a} \end{pmatrix}$$

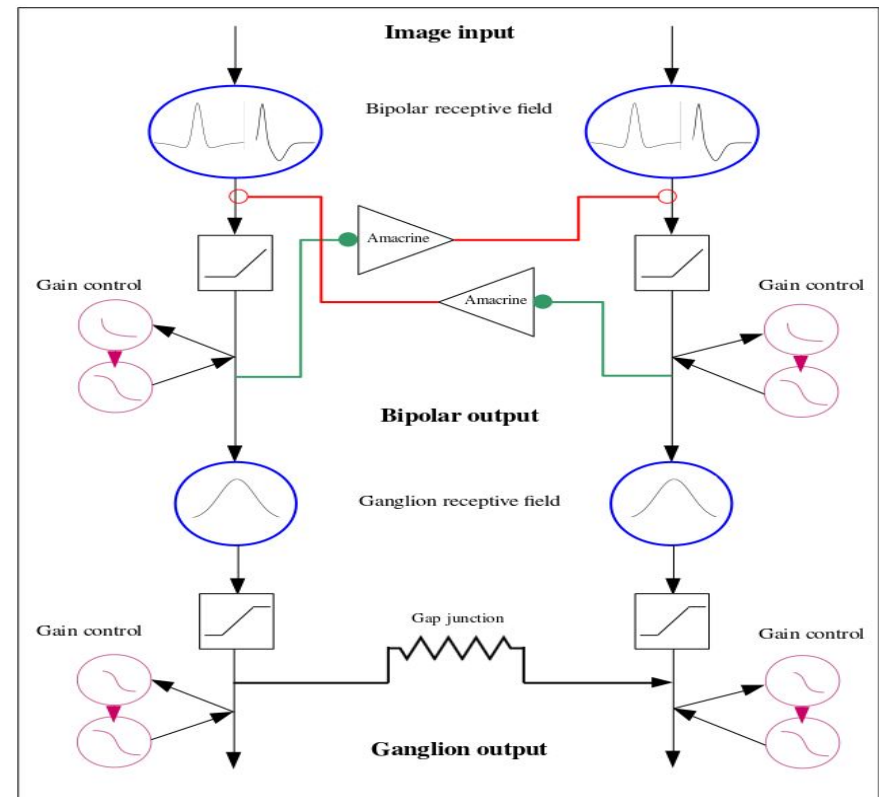

Building a 2D retina model for motion anticipation

Souihel S., Cessac B., “On the potential role of lateral connectivity in retinal anticipation”, Journal of Mathematical Neuroscience, BioMed Central, 2021, 11, {10.1186/s13408-020-00101-z}

Linear regime

$$\frac{d\vec{\chi}}{dt} = \mathcal{L} \cdot \vec{\chi} + \vec{F}(t).$$

$$\mathcal{L} = \begin{pmatrix} -\frac{I_{N,N}}{\tau_B} & W_B^A & 0_{N,N} \\ W_A^B & -\frac{I_{N,N}}{\tau_A} & 0_{N,N} \\ h_B I_{N,N} & 0_{N,N} & -\frac{I_{N,N}}{\tau_a} \end{pmatrix}$$

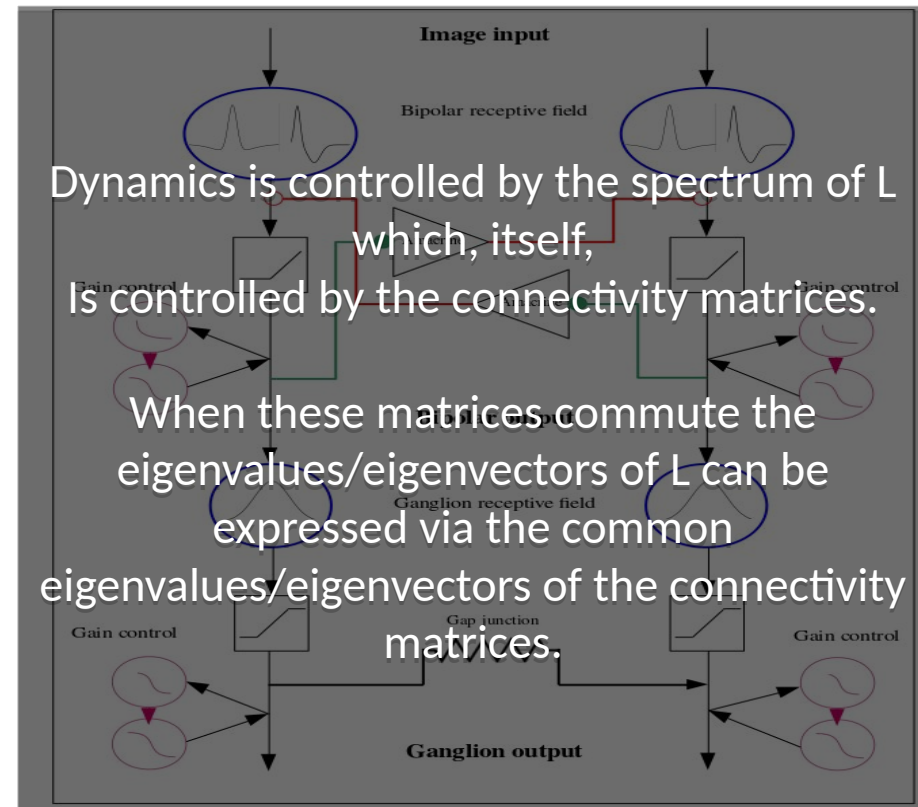

Building a 2D retina model for motion anticipation

Souihel S., Cessac B., “On the potential role of lateral connectivity in retinal anticipation”, Journal of Mathematical Neuroscience, BioMed Central, 2021, 11, {10.1186/s13408-020-00101-z}

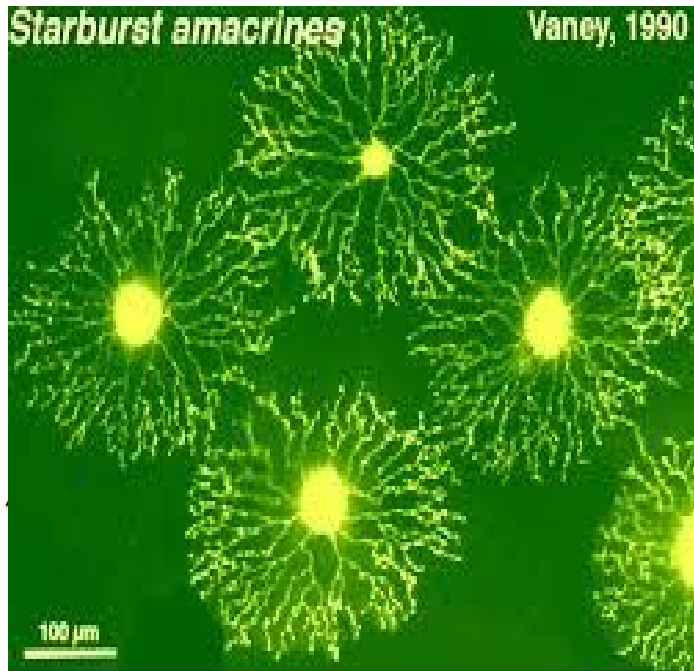
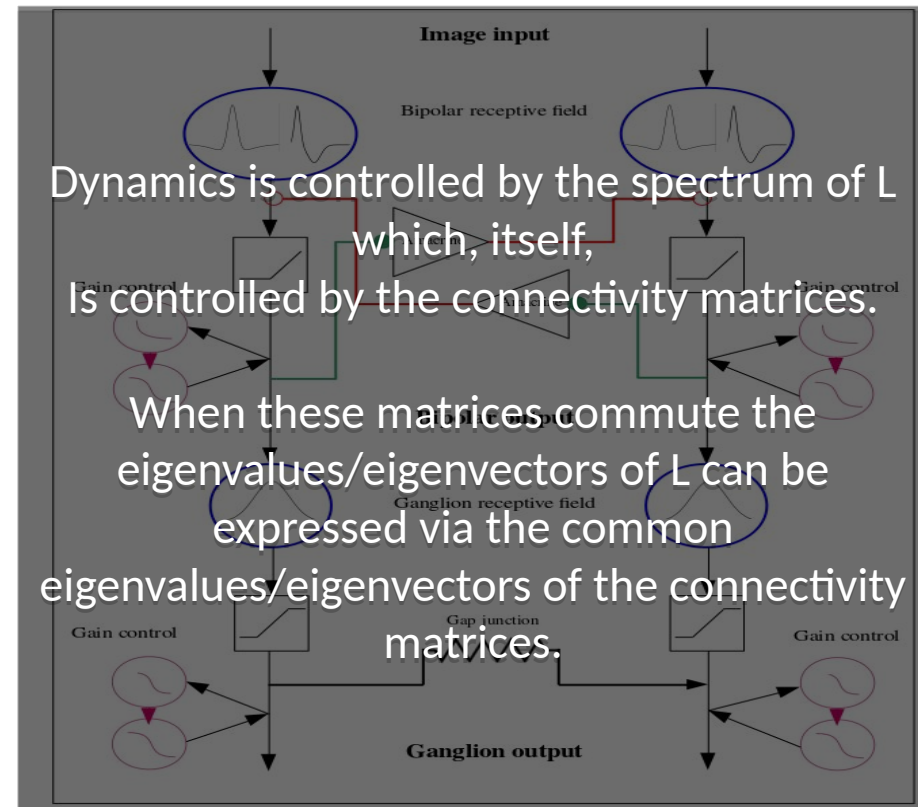
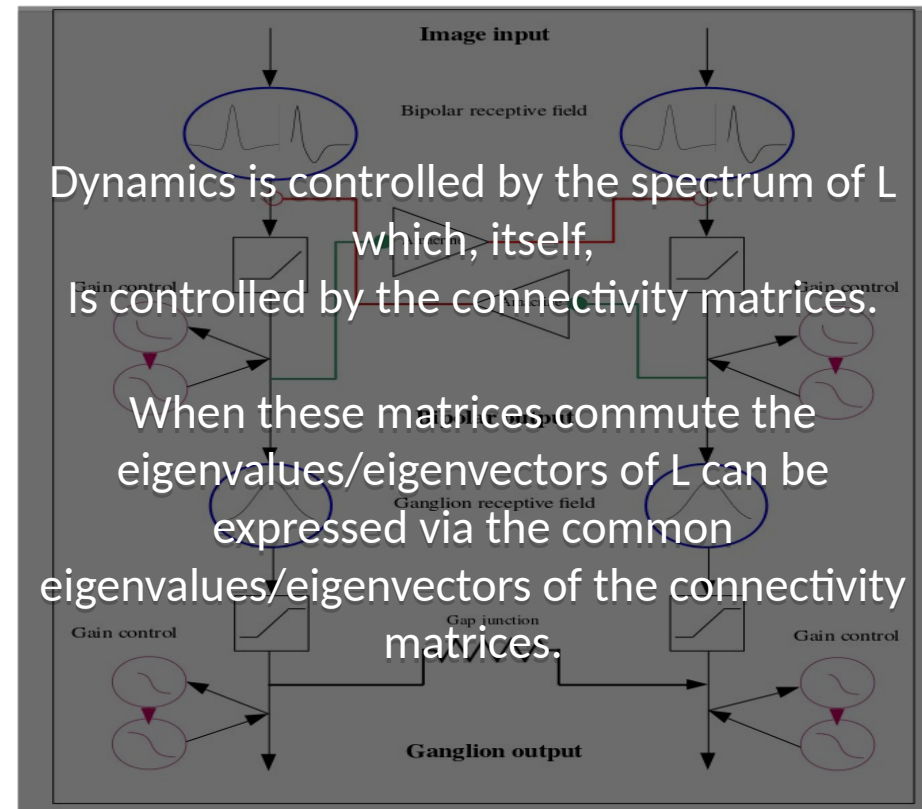
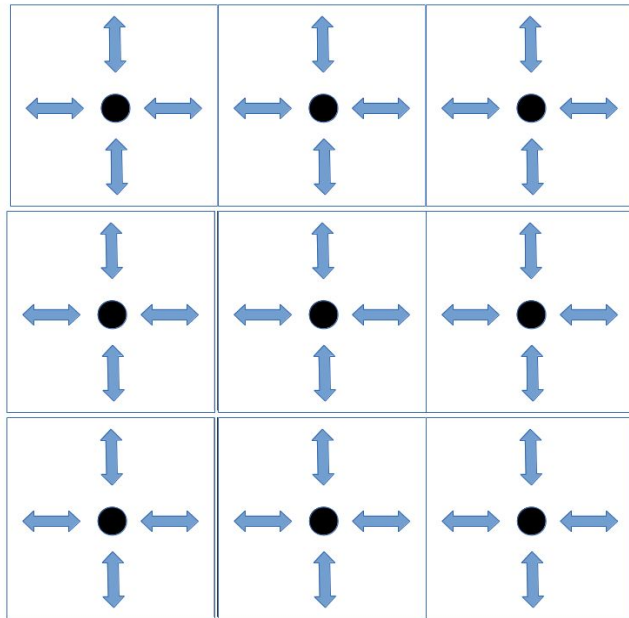

Fig. 7. Starburst amacrine cells are stained with Lucifer yellow in whole-mount rabbit retina.



Building a 2D retina model for motion anticipation

Souihel S., Cessac B., “On the potential role of lateral connectivity in retinal anticipation”, Journal of Mathematical Neuroscience, BioMed Central, 2021, 11, {10.1186/s13408-020-00101-z}



Building a 2D retina model for motion anticipation

Souihel S., Cessac B., “On the potential role of lateral connectivity in retinal anticipation”, Journal of Mathematical Neuroscience, BioMed Central, 2021, 11, {10.1186/s13408-020-00101-z}

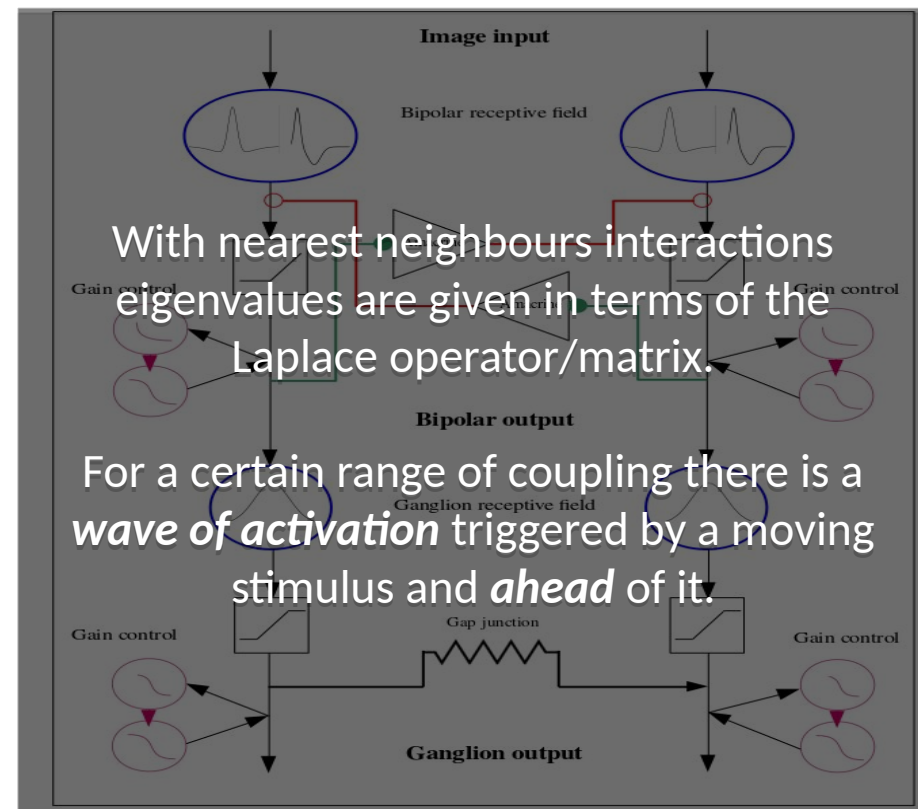
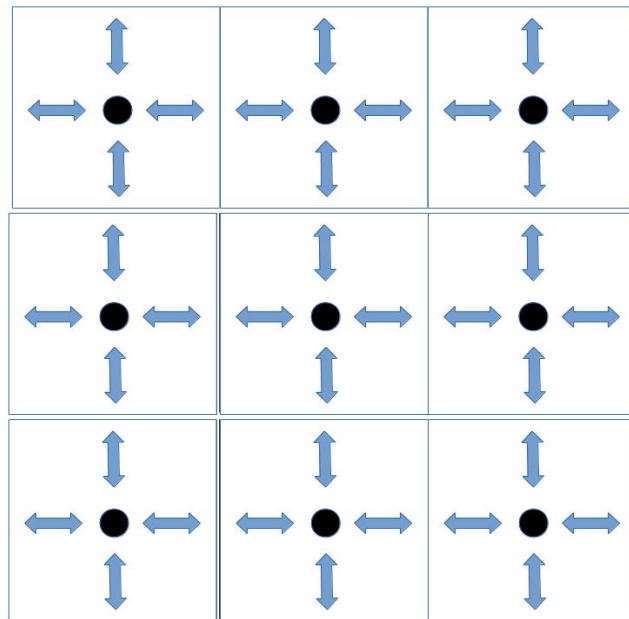

Building a 2D retina model for motion anticipation

Souihel S., Cessac B., “On the potential role of lateral connectivity in retinal anticipation”, Journal of Mathematical Neuroscience, BioMed Central, 2021, 11, {10.1186/s13408-020-00101-z}

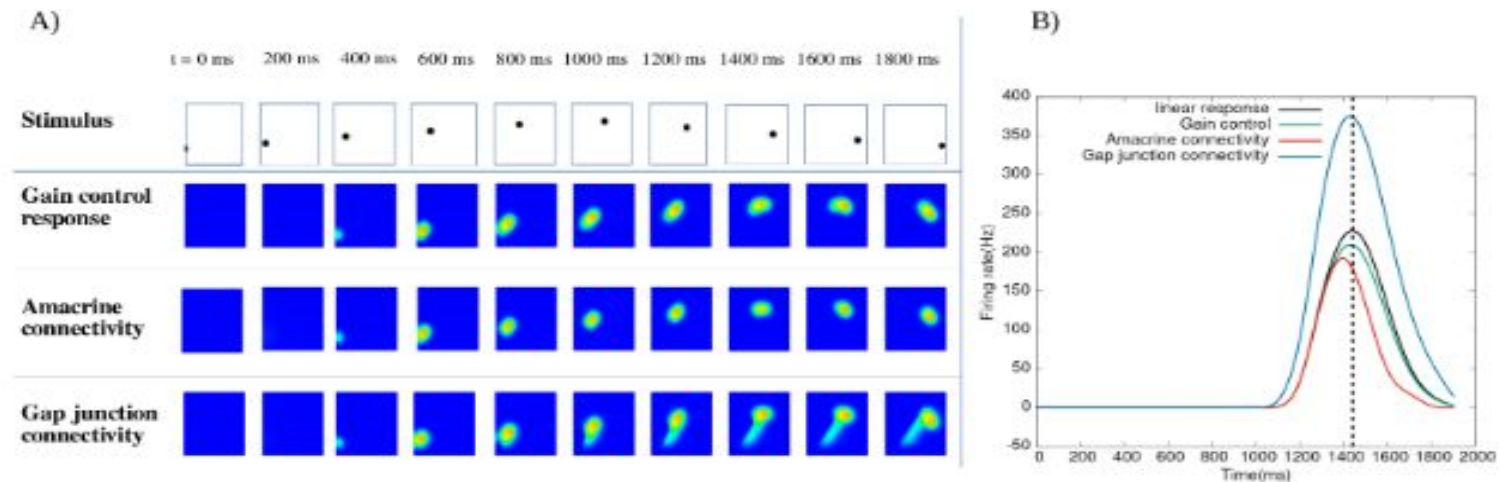
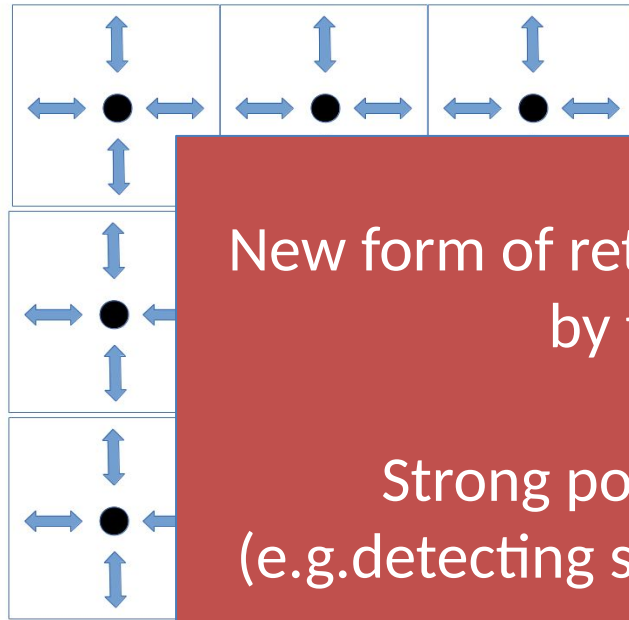

Figure 15: **Effect of anticipatory mechanisms on a parabolic trajectory.** A) Response to a dot moving along a parabolic trajectory. The first line shows the stimulus, the second line shows the GCells response with gain control, the third line presents the effect of lateral ACells connectivity with $w = 0.3 \text{ ms}^{-1}$, and the last line shows the effect of asymmetric gap junctions with $v_{gap} = 9 \text{ mm/s}$. B) Time course response of a cell responding to the dot near the trajectory turning point. Linear response corresponds to the response to the stimulus without gain control.

ns
he
Gain control
is a
oving
Gain control

Building a 2D retina model for motion anticipation

Souihel S., Cessac B., "On the potential role of lateral connectivity in retinal anticipation", Journal of Mathematical Neuroscience, BioMed Central, 2021, 11, {10.1186/s13408-020-00101-z}



New form of retinal anticipation induced by the network.

Strong potential implications (e.g. detecting surprise in a visual scene)

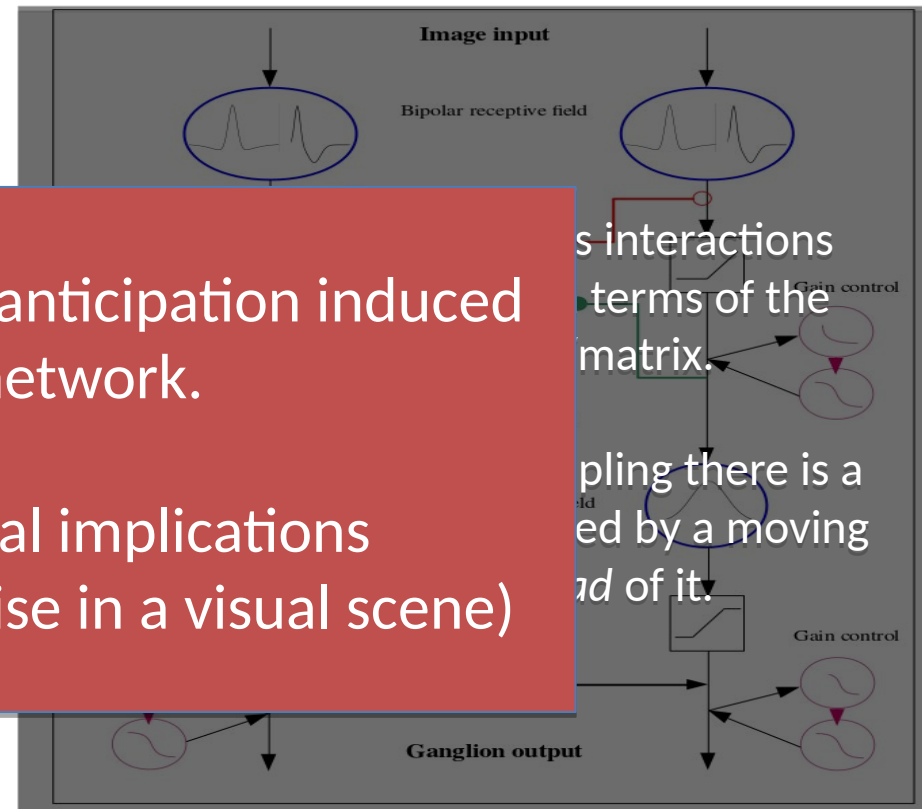

Building a 2D retina model for motion anticipation

Souihel S., Cessac B., “On the potential role of lateral connectivity in retinal anticipation”, Journal of Mathematical Neuroscience, BioMed Central, 2021, 11, {10.1186/s13408-020-00101-z}

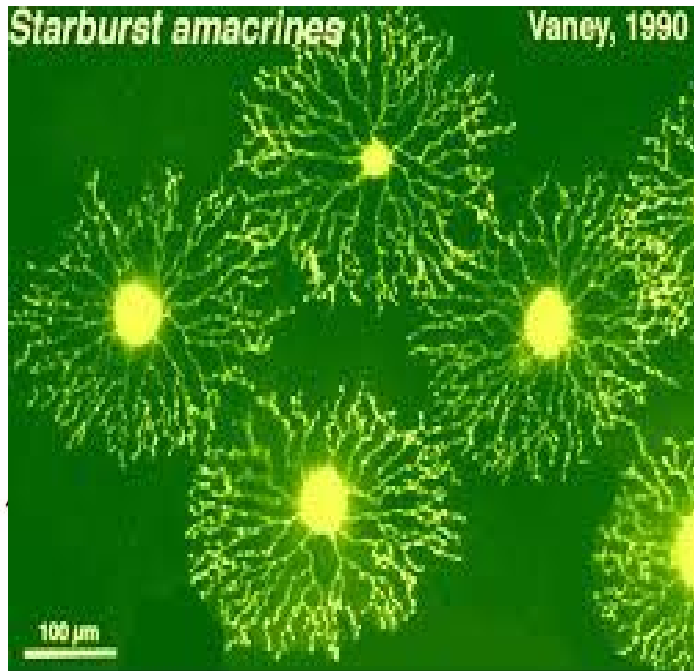
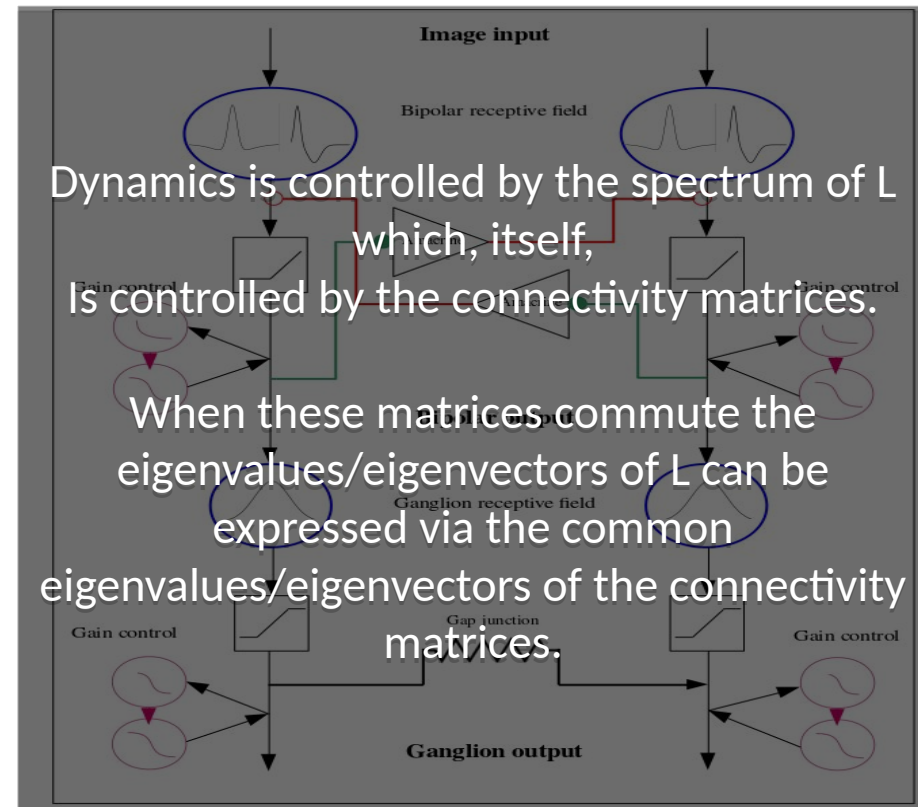

Fig. 7. Starburst amacrine cells are stained with Lucifer yellow in whole-mount rabbit retina.



Building a 2D retina model for motion anticipation

Souihel S., Cessac B., “On the potential role of lateral connectivity in retinal anticipation”, Journal of Mathematical Neuroscience, BioMed Central, 2021, 11, {10.1186/s13408-020-00101-z}

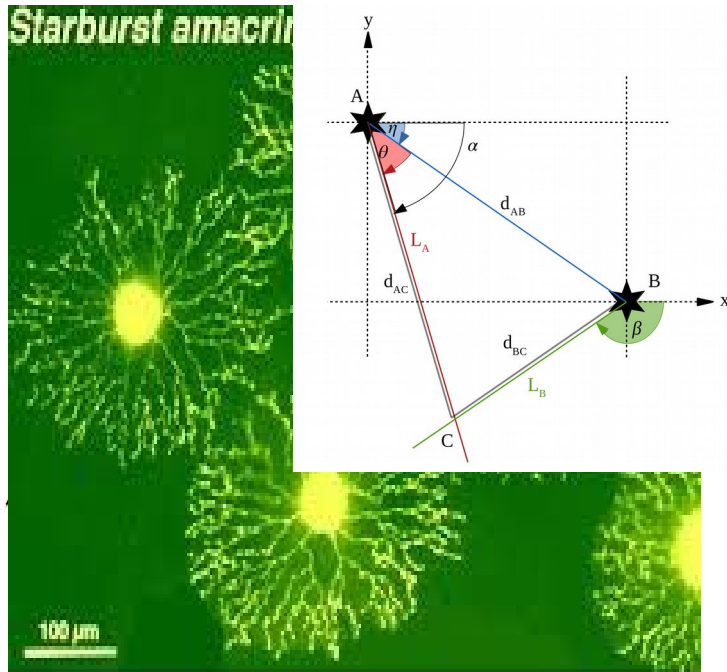
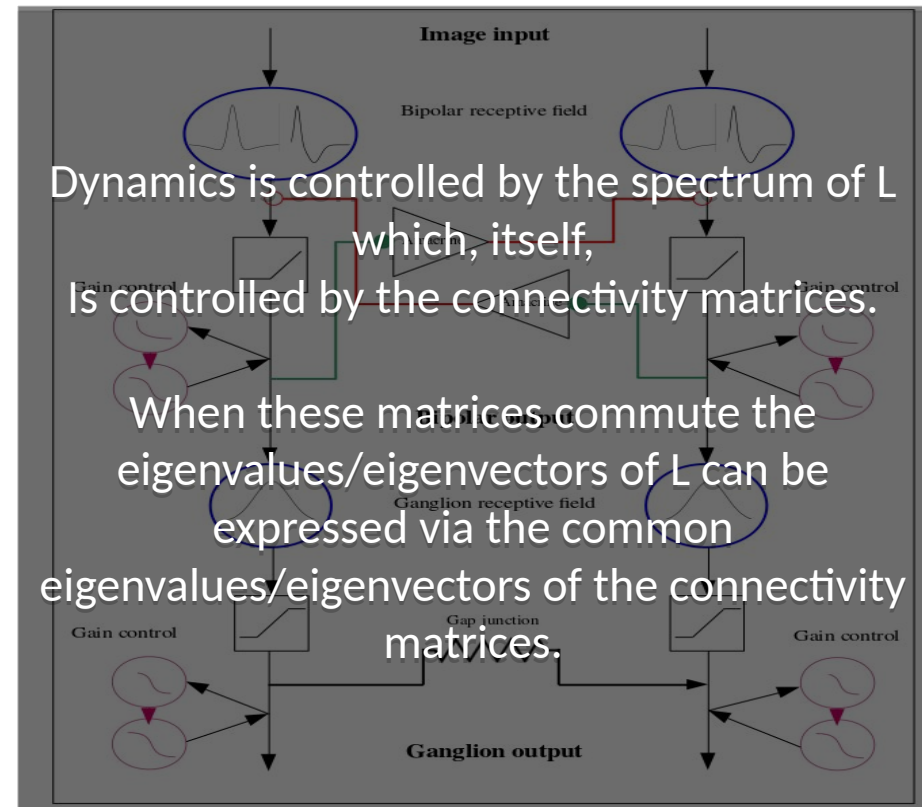

Fig 7. Starburst amacrine cells are stained with Lucifer yellow in whole-mount rabbit retina.



Building a 2D retina model for motion anticipation

Souihel S., Cessac B., "On the potential role of lateral connectivity in retinal anticipation", Journal of Mathematical Neuroscience, BioMed Central, 2021, 11, {10.1186/s13408-020-00101-z}

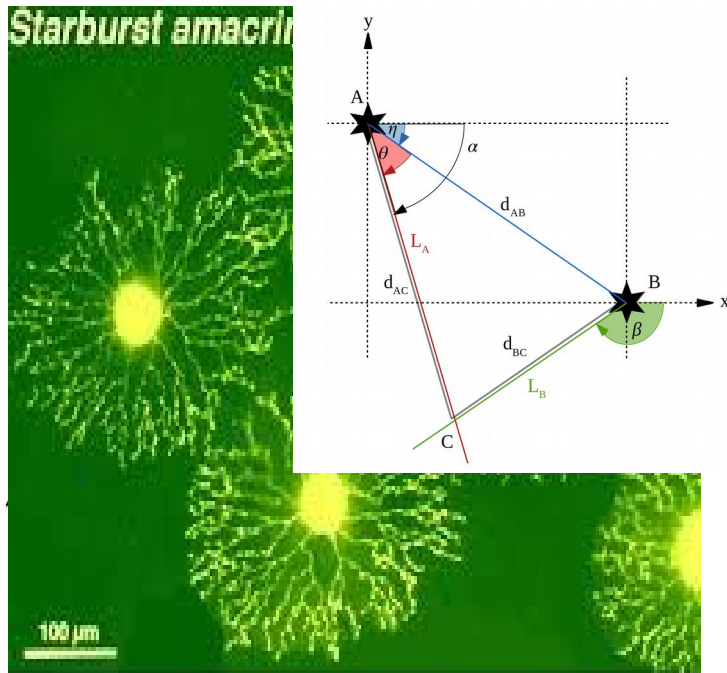
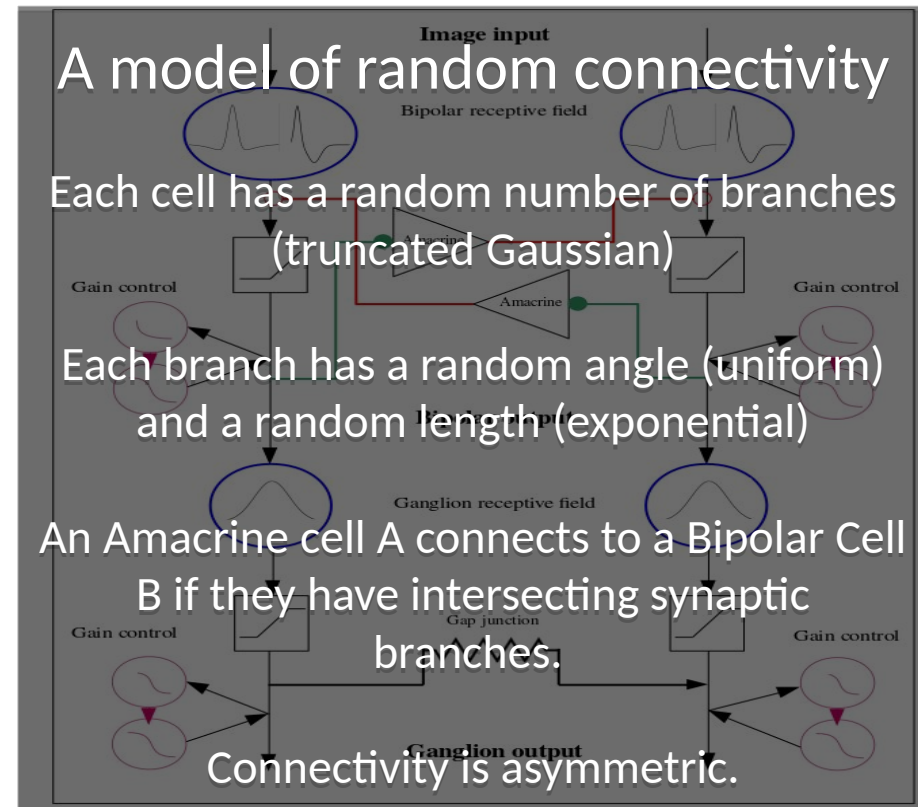

Fig 7. Starburst amacrine cells are stained with lucifer yellow in whole-mount rabbit retina.



Building a 2D retina model for motion anticipation

Souihel S., Cessac B., “On the potential role of lateral connectivity in retinal anticipation”, Journal of Mathematical Neuroscience, BioMed Central, 2021, 11, {10.1186/s13408-020-00101-z}

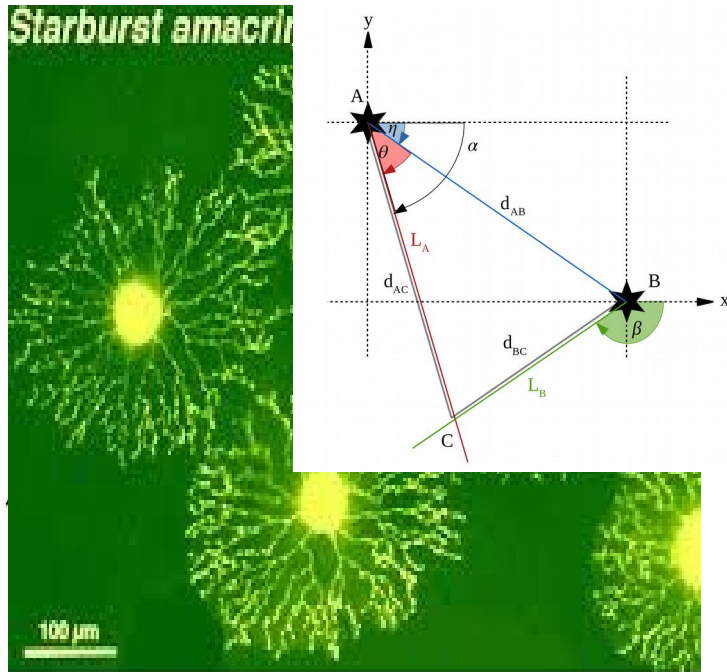
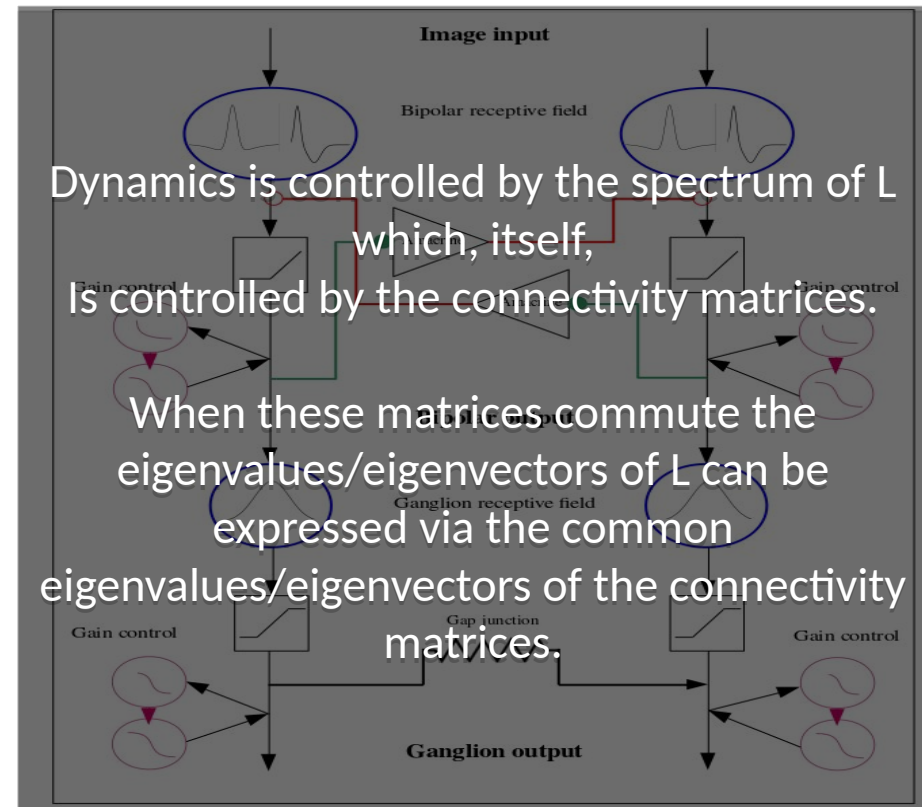
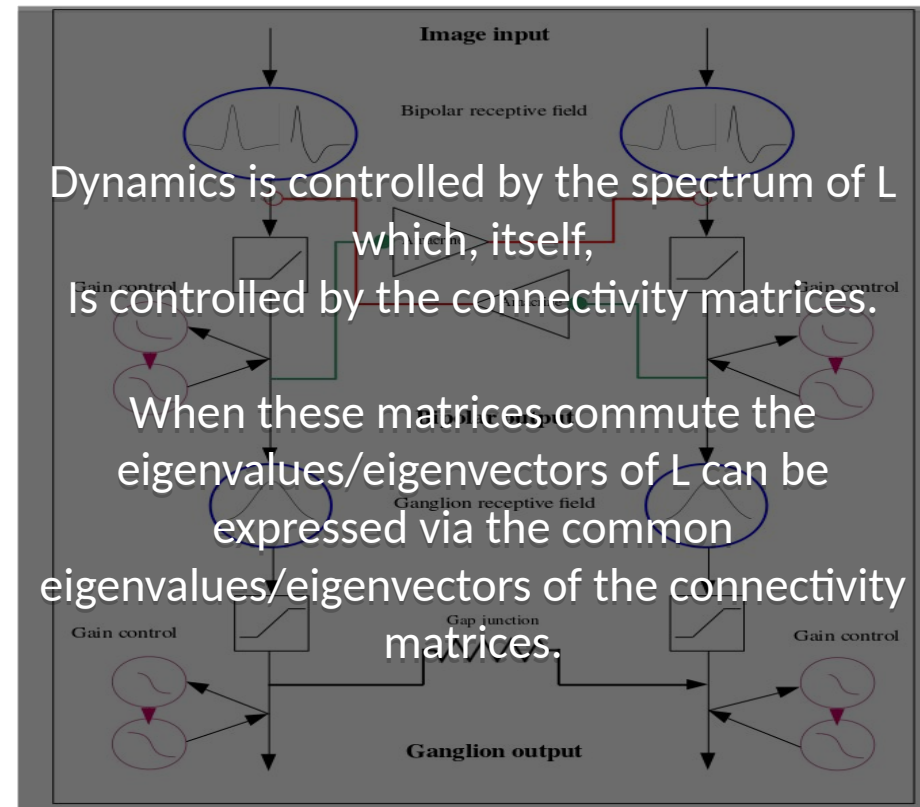
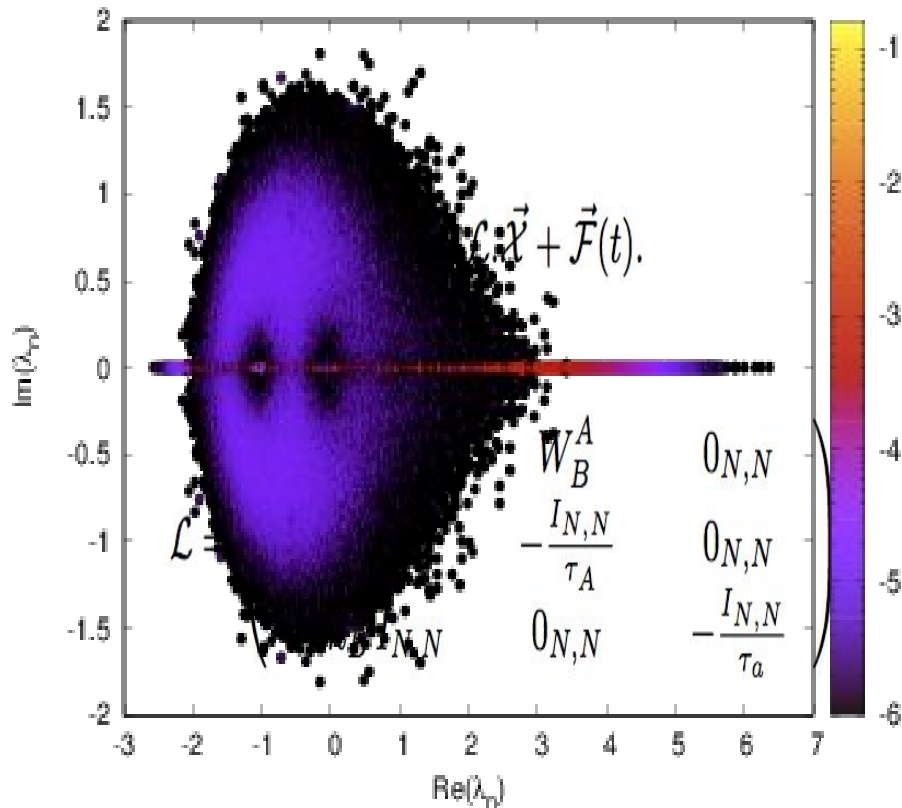

Fig 7. Starburst amacrine cells are stained with Lucifer yellow in whole-mount rabbit retina.



Building a 2D retina model for motion anticipation

Souihel S., Cessac B., “On the potential role of lateral connectivity in retinal anticipation”, Journal of Mathematical Neuroscience, BioMed Central, 2021, 11, <10.1186/s13408-020-00101-z>



Building a 2D retina model for motion anticipation

Souihel S., Cessac B., “On the potential role of lateral connectivity in retinal anticipation”, Journal of Mathematical Neuroscience, BioMed Central, 2021, 11, {10.1186/s13408-020-00101-z}

$$\frac{d\vec{\chi}}{dt} = \mathcal{L} \cdot \vec{\chi} + \vec{F}(t).$$

$$\mathcal{L} = \begin{pmatrix} -\frac{I_{N,N}}{\tau_B} & W_B^A & 0_{N,N} \\ W_A^B & -\frac{I_{N,N}}{\tau_A} & 0_{N,N} \\ h_B I_{N,N} & 0_{N,N} & -\frac{I_{N,N}}{\tau_a} \end{pmatrix}$$

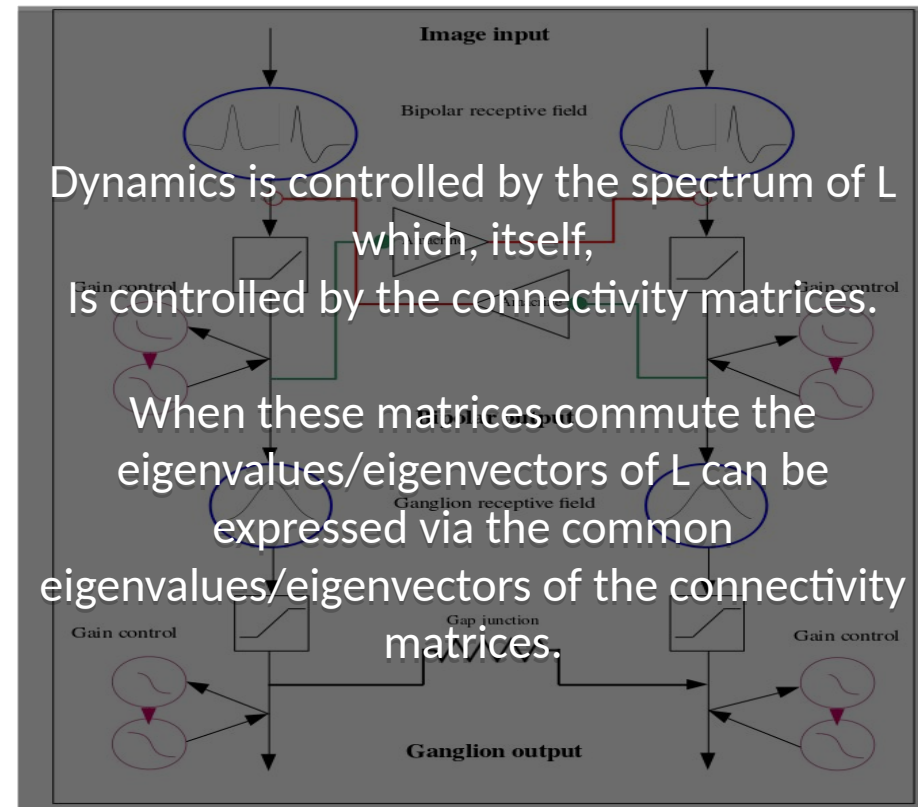

Building a 2D retina model for motion anticipation

Souihel S., Cessac B., "On the potential role of lateral connectivity in retinal anticipation", Journal of Mathematical Neuroscience, BioMed Central, 2021, 11, <10.1186/s13408-020-00101-z>

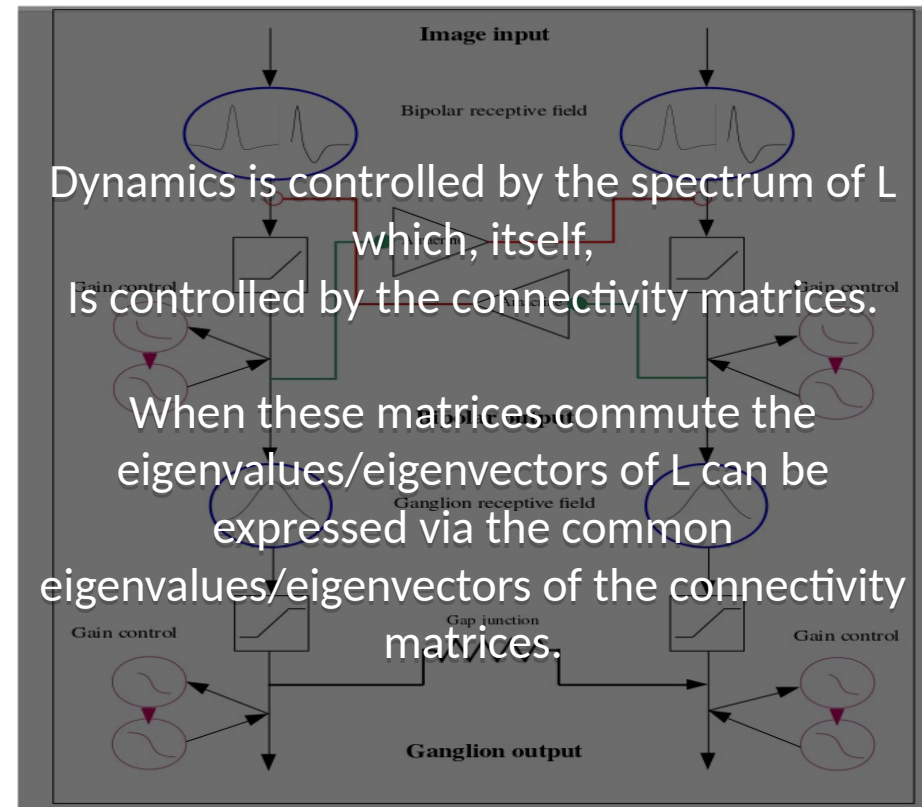
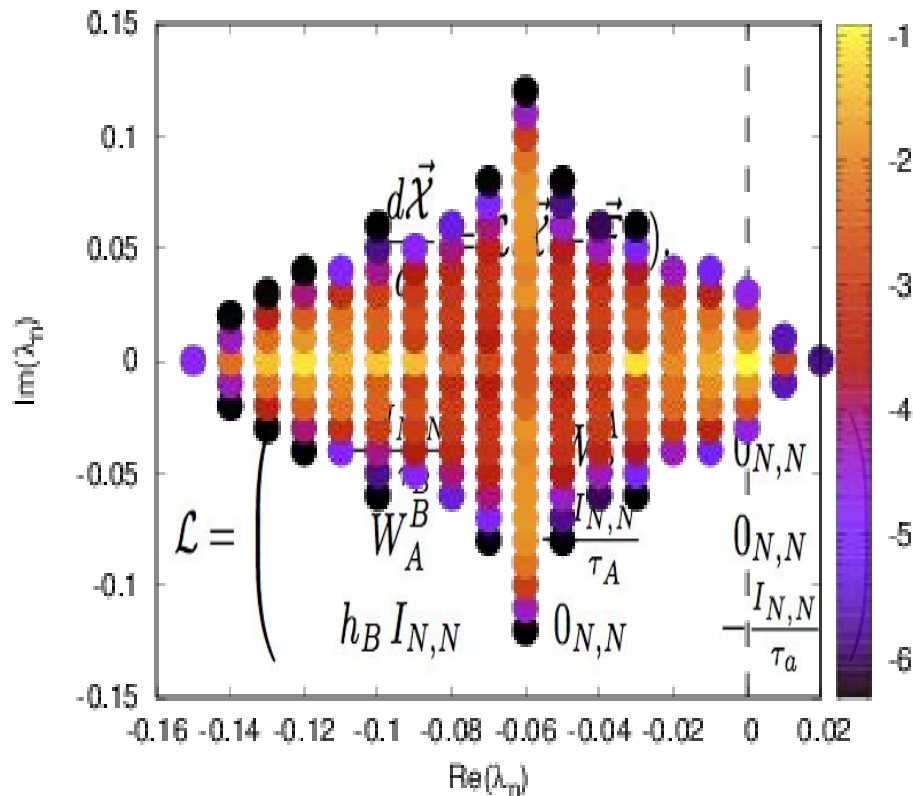

Building a 2D retina model for motion anticipation

Souihel S., Cessac B., “On the potential role of lateral connectivity in retinal anticipation”, Journal of Mathematical Neuroscience, BioMed Central, 2021, 11, <10.1186/s13408-020-00101-z>

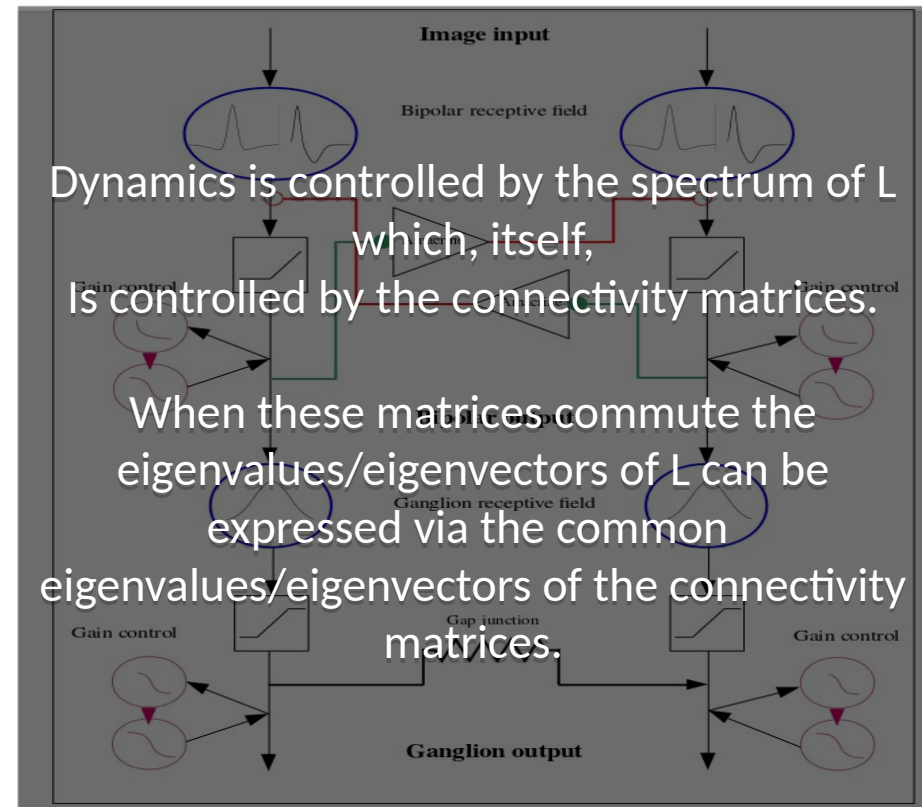
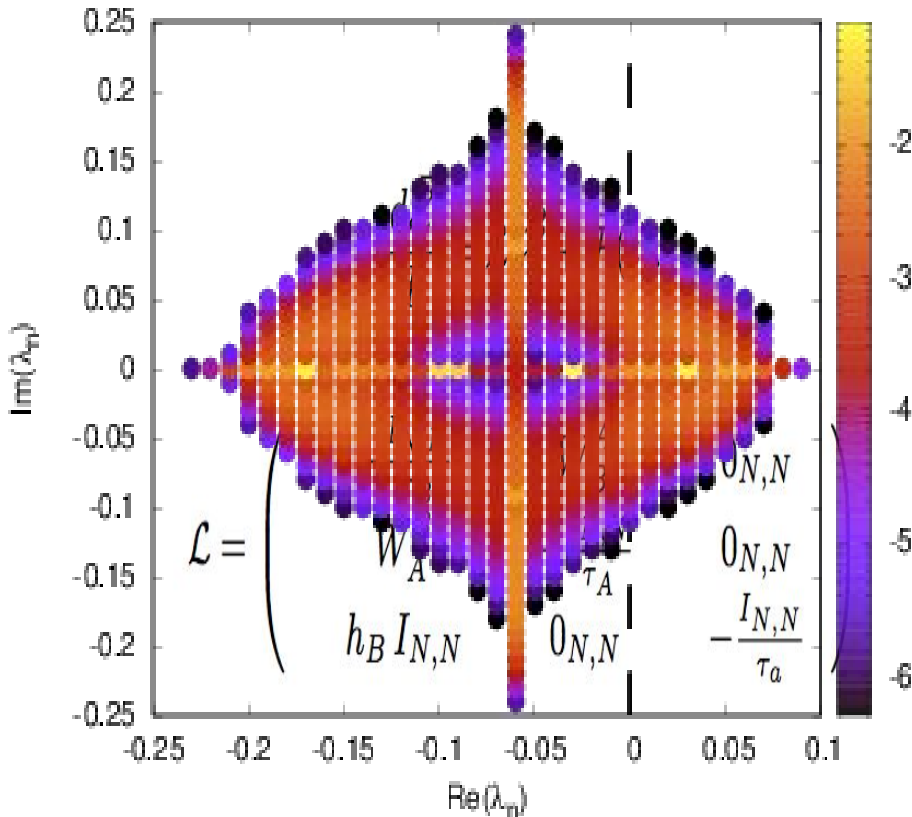

Building a 2D retina model for motion anticipation

Souihel S., Cessac B., “On the potential role of lateral connectivity in retinal anticipation”, Journal of Mathematical Neuroscience, BioMed Central, 2021, 11, <10.1186/s13408-020-00101-z>

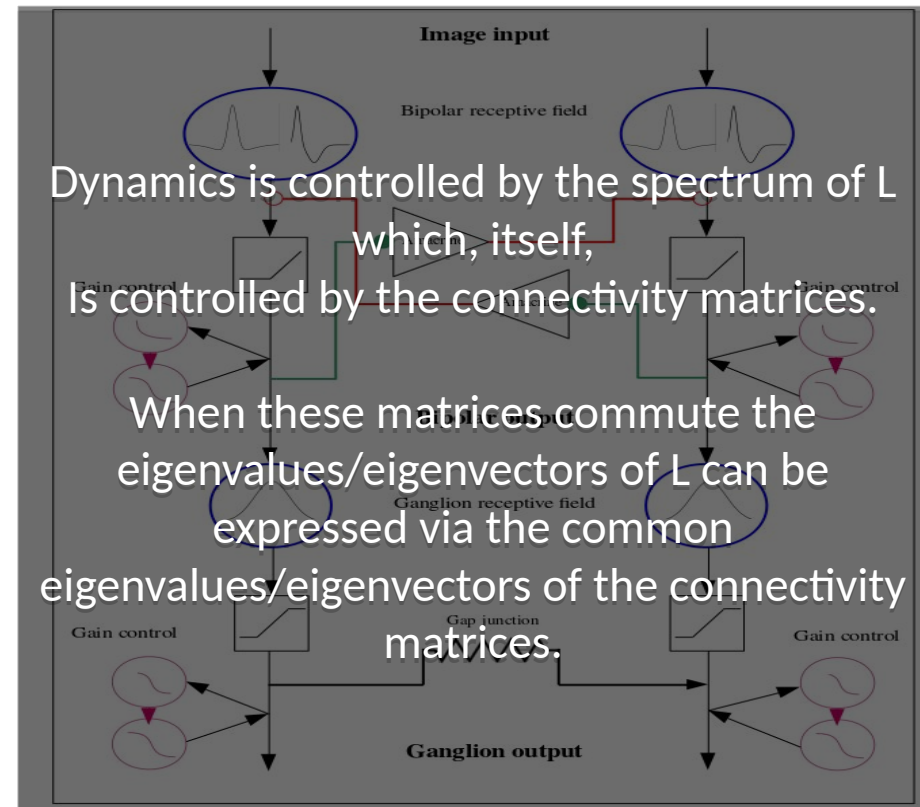
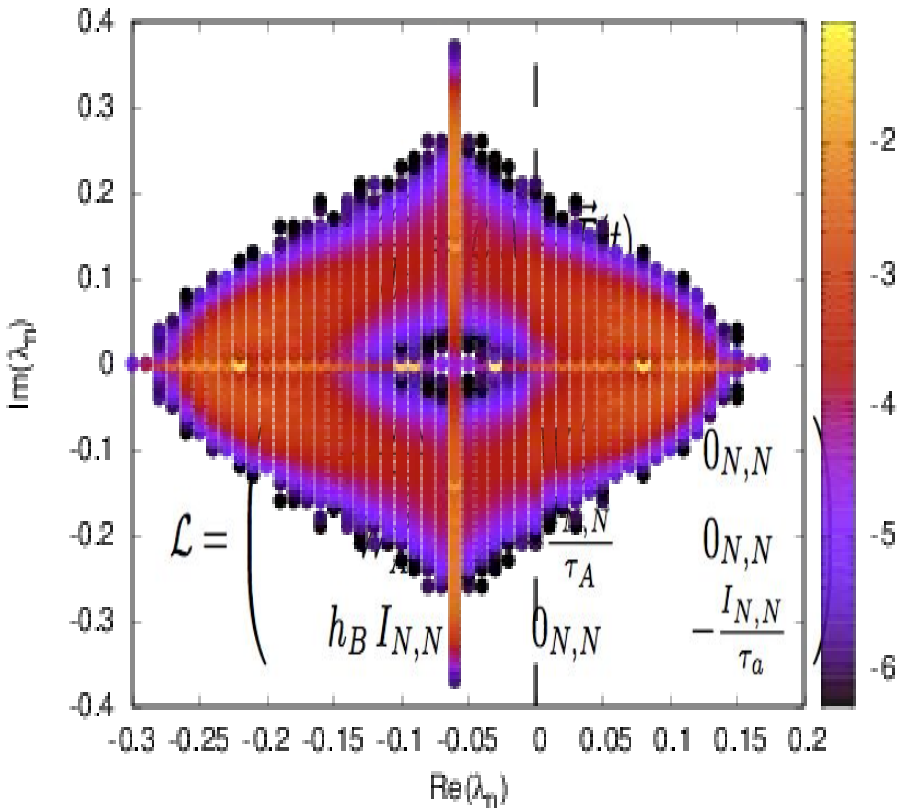

Building a 2D retina model for motion anticipation

Souil
retin

Question N°2 to mathematicians :

Any known mathematical results about the spectrum (complex eigenvalues/eigenvectors) of this type of random matrices ?

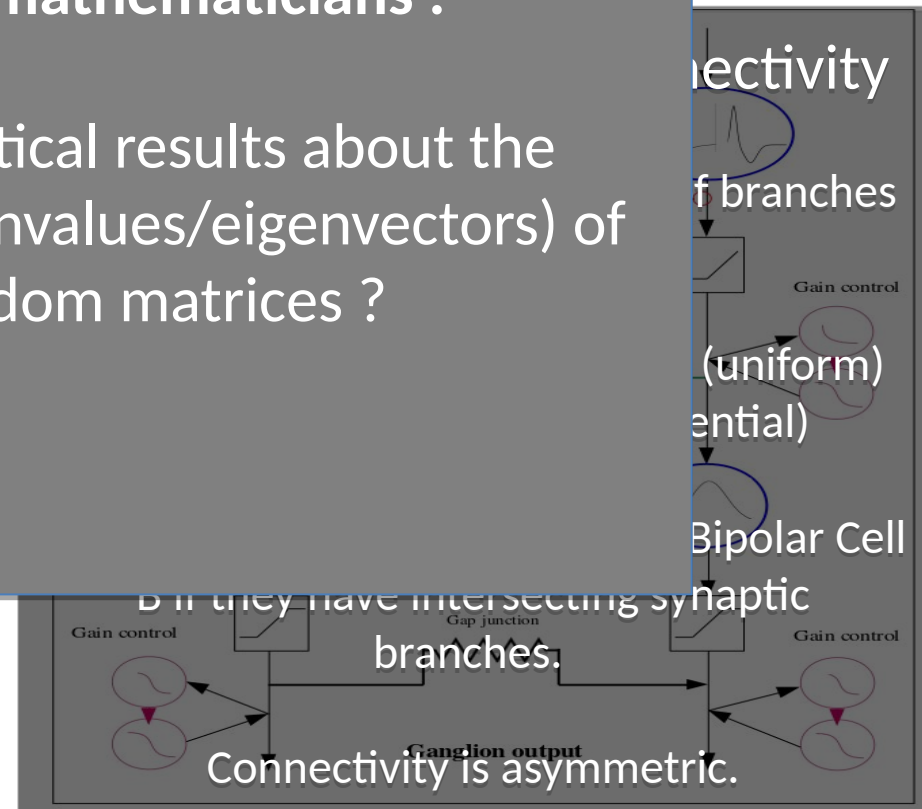
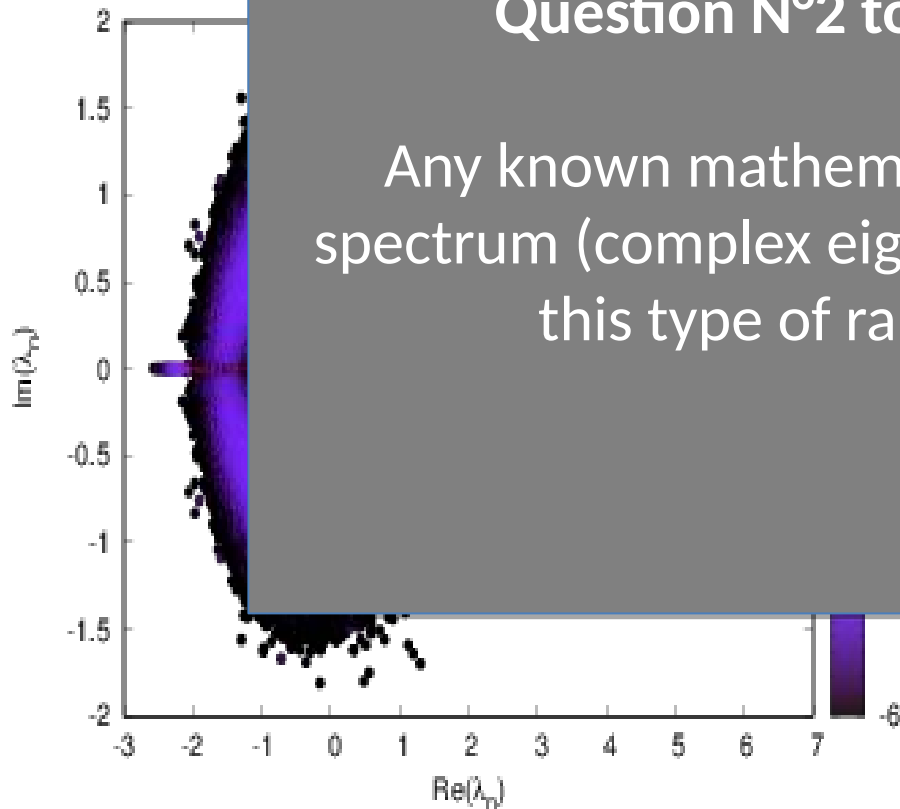

Perspectives

- A retino-cortical (V1) model of anticipation (with F. Chavane, S. Chemla, A. Destexhe, S. Souihel, M. Di Volo).

Perspectives

- A retino-cortical (V1) model of anticipation (with F. Chavane, S. Chemla, A. Destexhe, S. Souihel, M. Di Volo).

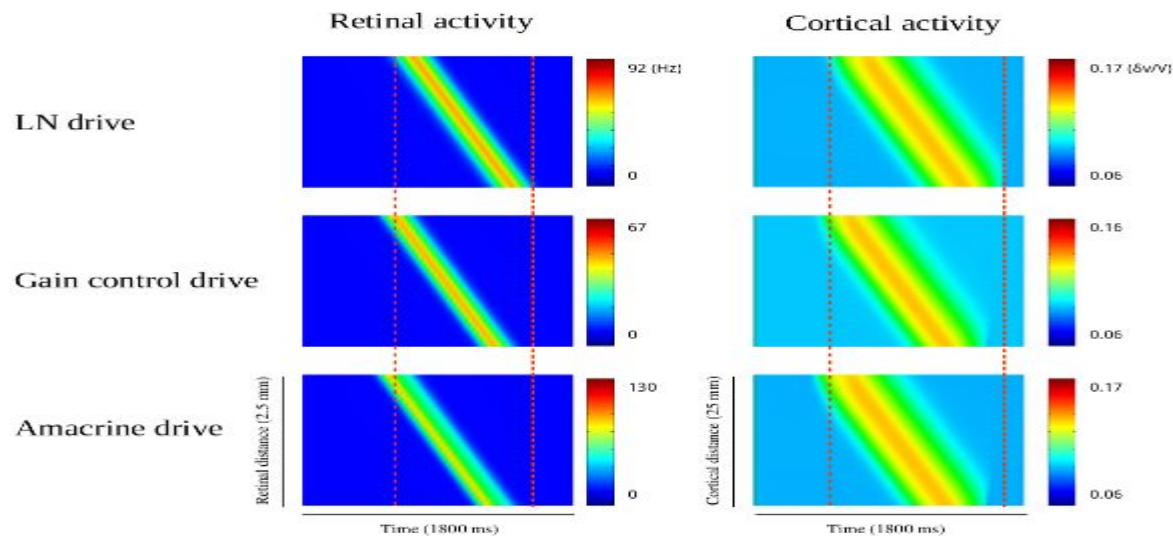

Figure 11: Comparing the spatio-temporal activity with the different drives. Left column figures display the spatio-temporal retinal activity with different anticipatory mechanisms, and the right column displays the corresponding spatio-temporal cortical activity. The red dashed lines denote the start and the end times of the LN retinal and cortical activities, as a reference base.

Perspectives

- A retino-cortical (V1) model of anticipation (with F. Chavane, S. Chemla, A. Destexhe, S. Souihel, M. Di Volo).
- Is our model able to anticipate more complex trajectories, with accelerations for instance ?
- How to calibrate connectivity using biology ?
- How does anticipation affect higher order correlations ?
- Would it be possible to design psycho-physical tests clearly showing the role of the retina in visual anticipation ?

Linear response for spiking neuronal networks with unbounded memory

R. Cofré, CIMFAV, Facultad de Ingenieria,
Universidad de Valparaiso, Valparaiso, Chile

Ignacio Ampuero, Departamento de Informatica,
Universidad Tecnica Federico Santa Maria,
Valparaiso, Chile

Spontaneous spiking activity

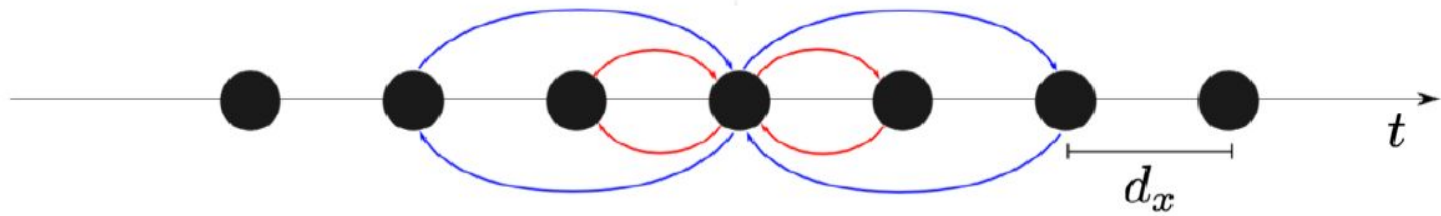

Spontaneous spiking activity

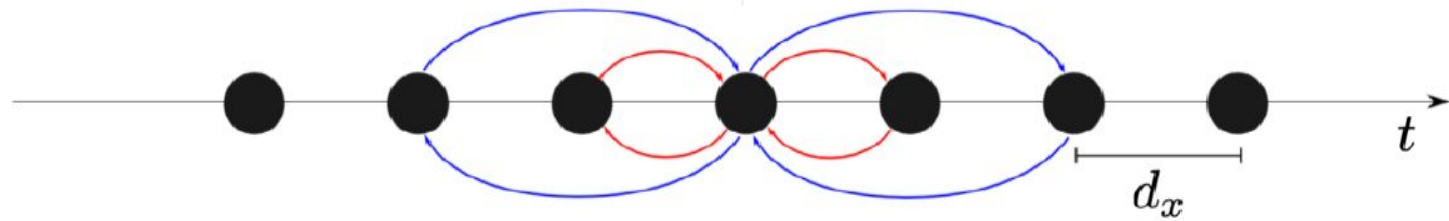

Spontaneous spiking activity

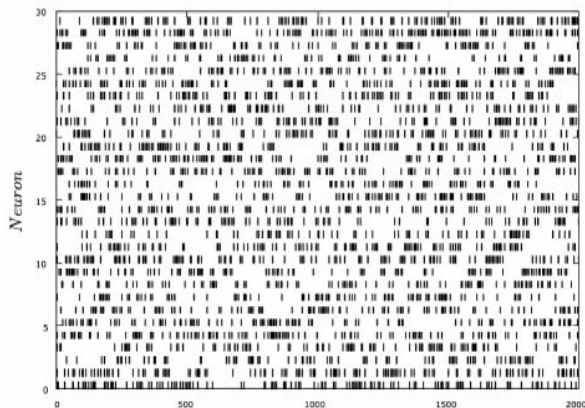
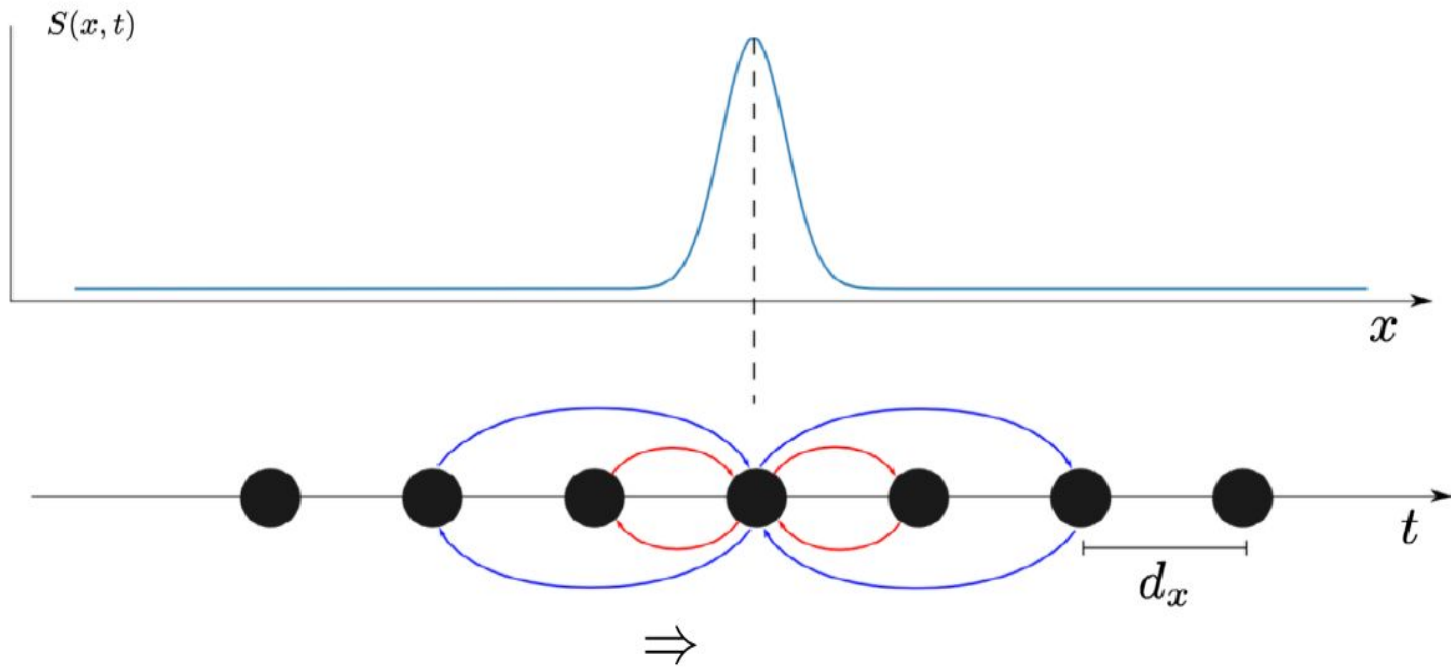

Spontaneous spiking activity

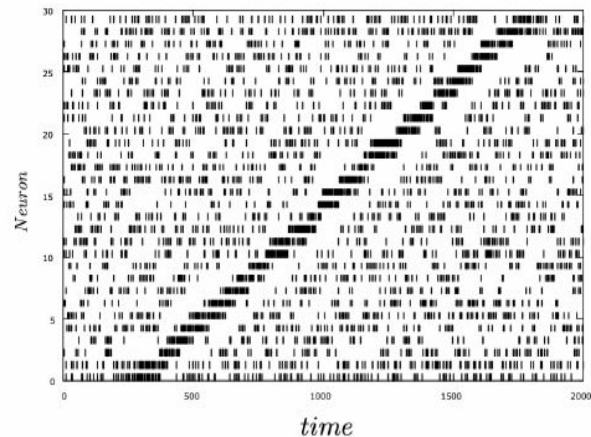
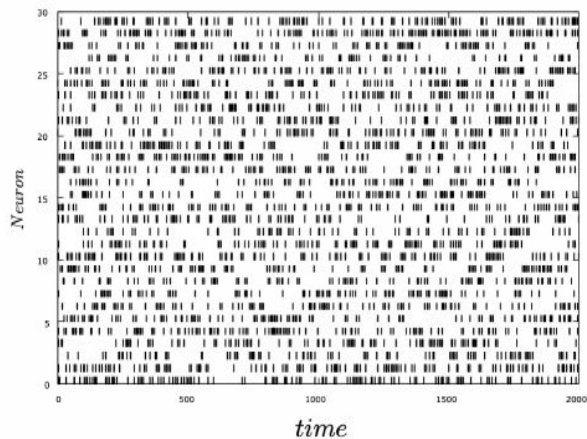
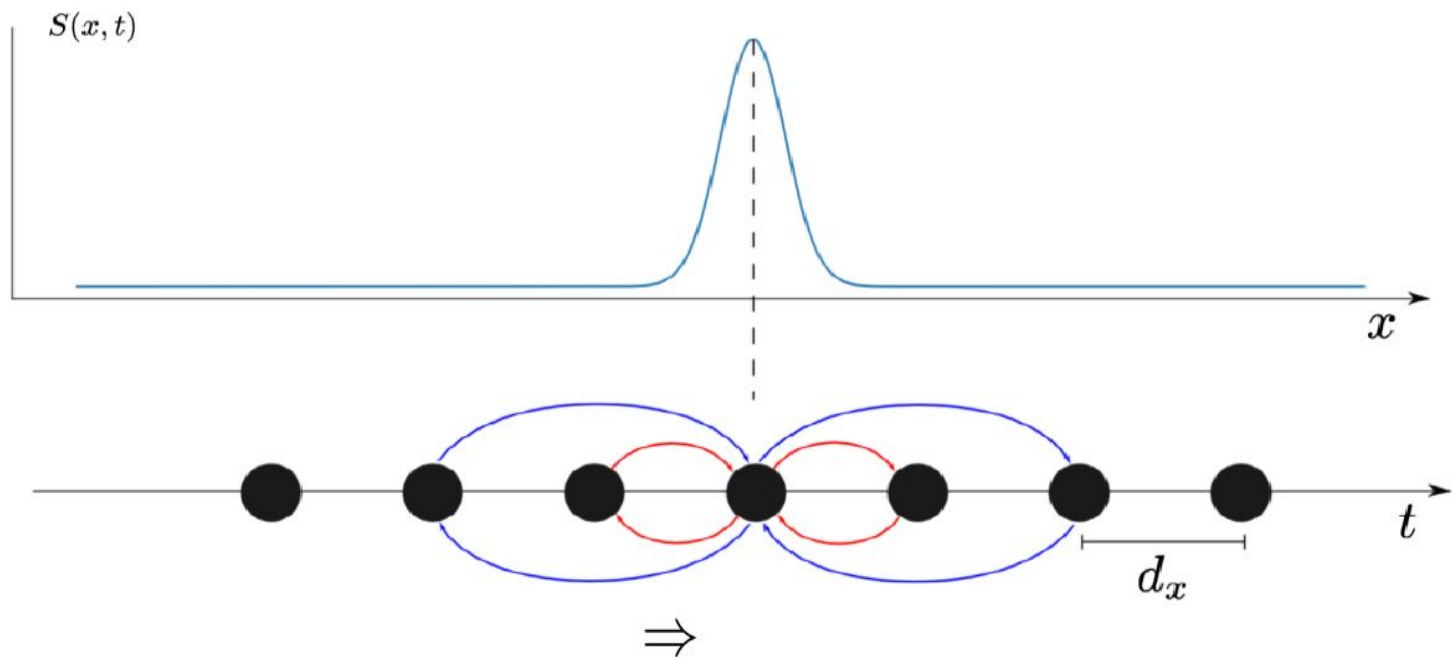

Spontaneous spiking activity

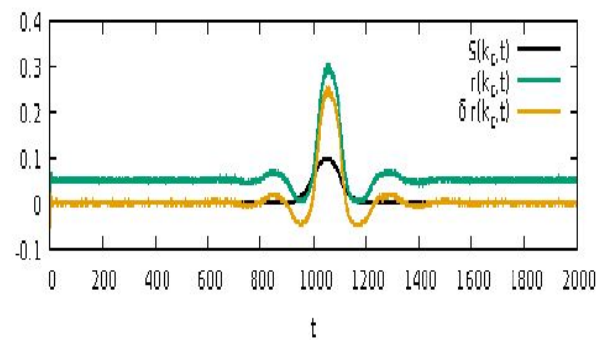
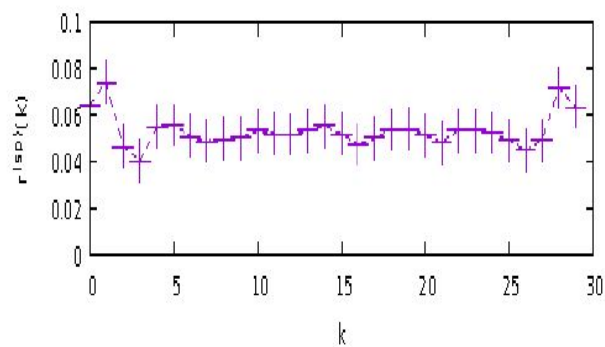
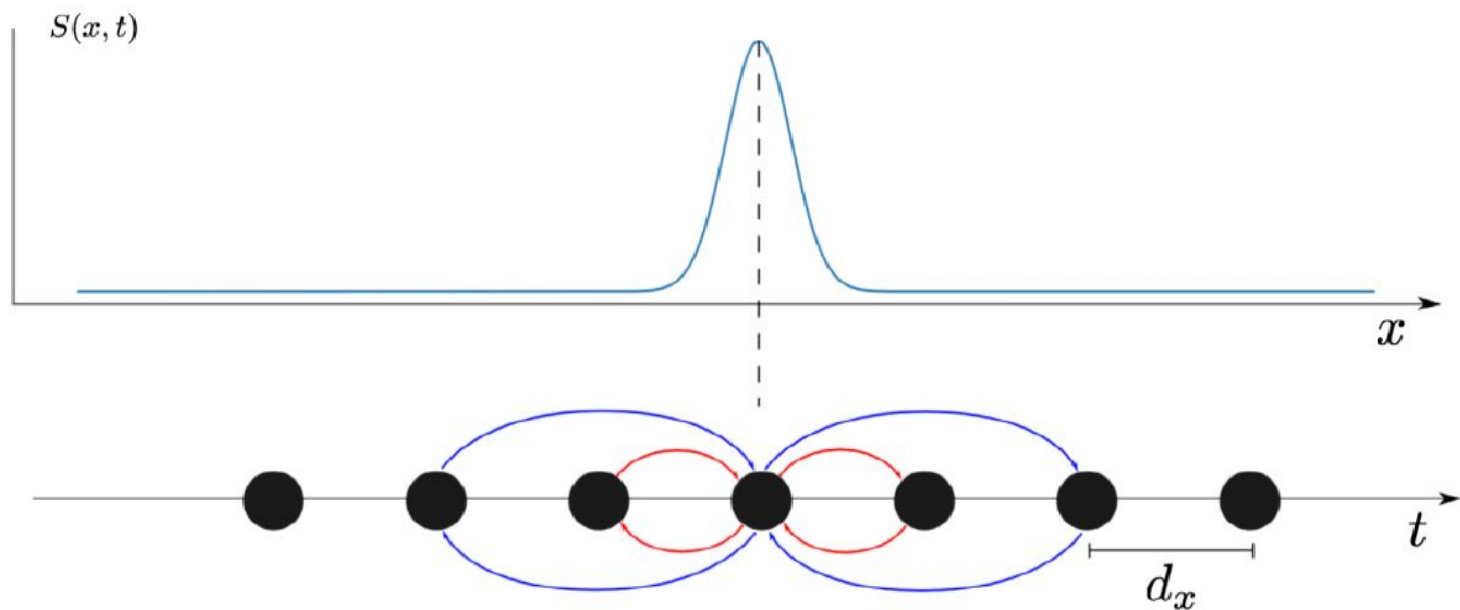

Sample averaging (non stationary)

Spontaneous spiking activity

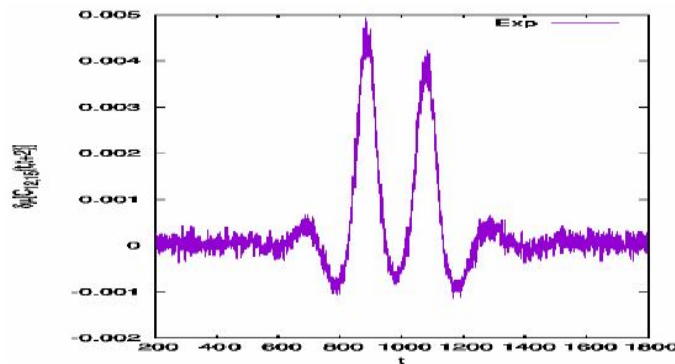
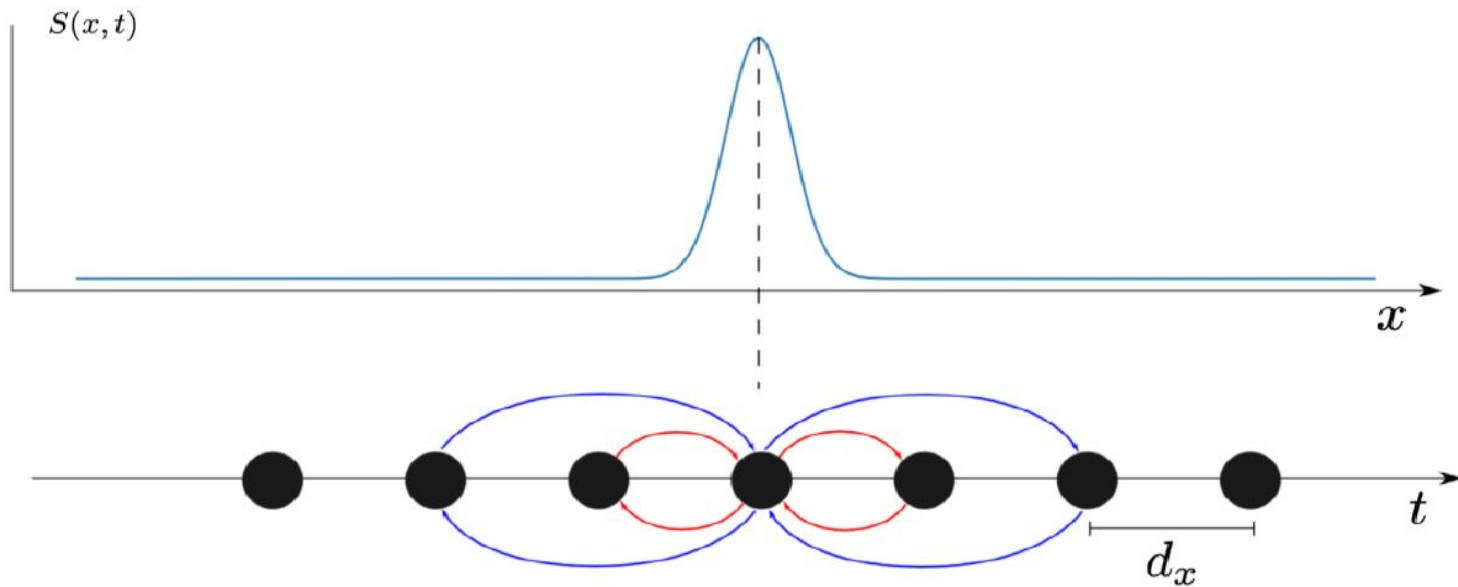

Variation in the correlation $C_{12,15}(t, t+2)$

Correlation variations are triggered by the stimulus, but they are constrained by the network dynamics.

How to compute the spatio-temporal response of a neuronal network to a time dependent stimulus ?

Can we compute the time variation of spike-observables as a function of the stimulus and spontaneous dynamics ?

B. Cessac, I. Ampuero, R. Cofre, Linear response for spiking neuronal networks with unbounded memory. *Entropy*, MDPI, 2021, 23 (2), pp.155.

Response to stimuli

B. Cessac, I. Ampuero, R. Cofre, Linear response for spiking neuronal networks with unbounded memory. Entropy, MDPI, 2021, 23 (2), pp.155.

GIF model without stimulus \Rightarrow *stationary Gibbs distribution*.

time-dependent stimulus $S(t) \Rightarrow$ *non stationary Gibbs distribution*.

How is the average of an observable $f(\omega, t)$ affected by the stimulus ?

If S is weak enough: $\delta\mu[f(t)] = [\kappa_f * S](t)$, (linear response).

$$\kappa_{k,f}(t - t_1) = \frac{1}{C_k} \sum_{r=-\infty}^{n=[t]} C^{(sp)} \left[f(t, \cdot), \frac{\mathcal{H}_k^{(1)}(r, \cdot)}{\sigma_k(r-1, \cdot)} \int_{\tau_k(r-1, \cdot)}^{r-1} S_k(t_1) \Gamma_k(t_1, r-1, \cdot) dt_1 \right]$$

Firing rates

Computations have been done using the INRIA Pranas software, B. Cessac et al, *Frontiers in Neuroinformatics*, Vol 11, page 49, (2017).

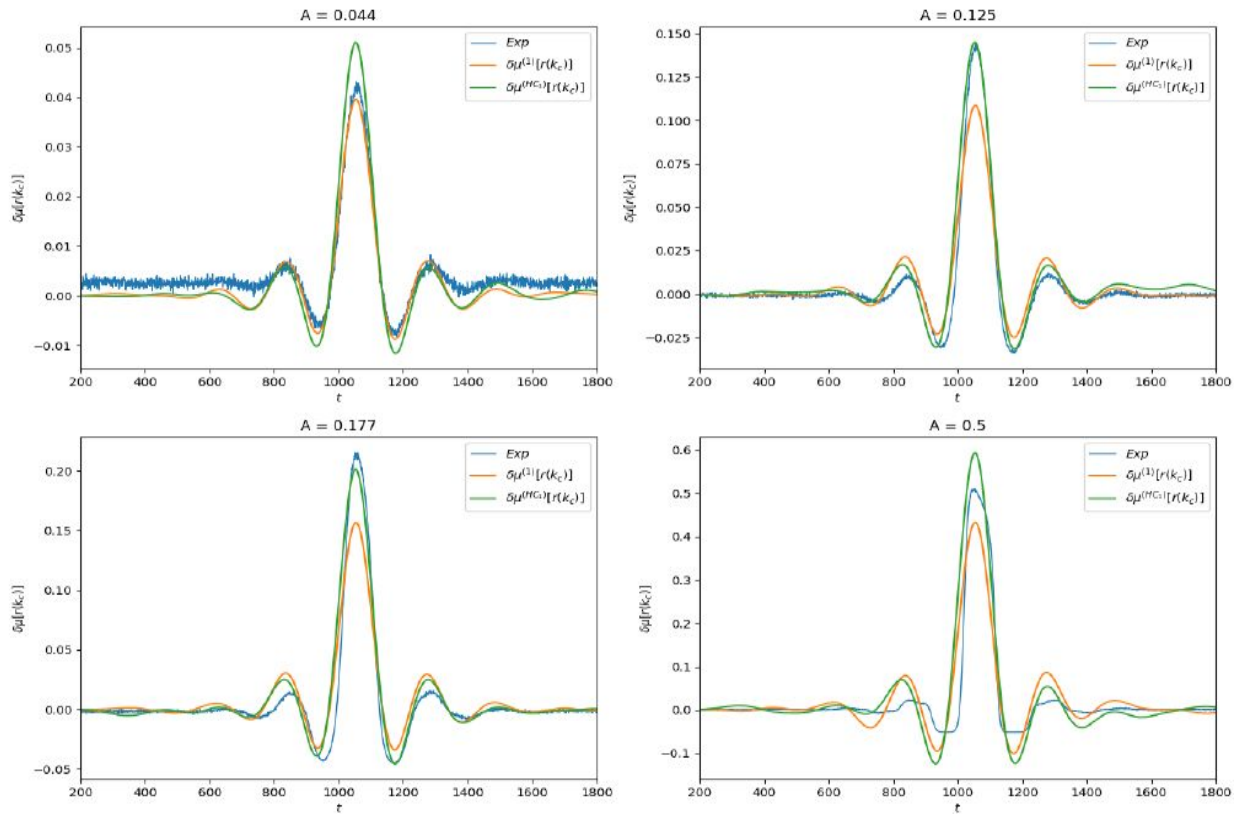

Figure: Linear response of $f(\omega, n) = \omega_{k_c}(n)$ for different values of stimulus amplitude A .

Higher order observable

Computations have been done using the INRIA Pranas software, B. Cessac et al, *Frontiers in Neuroinformatics*, Vol 11, page 49, (2017).

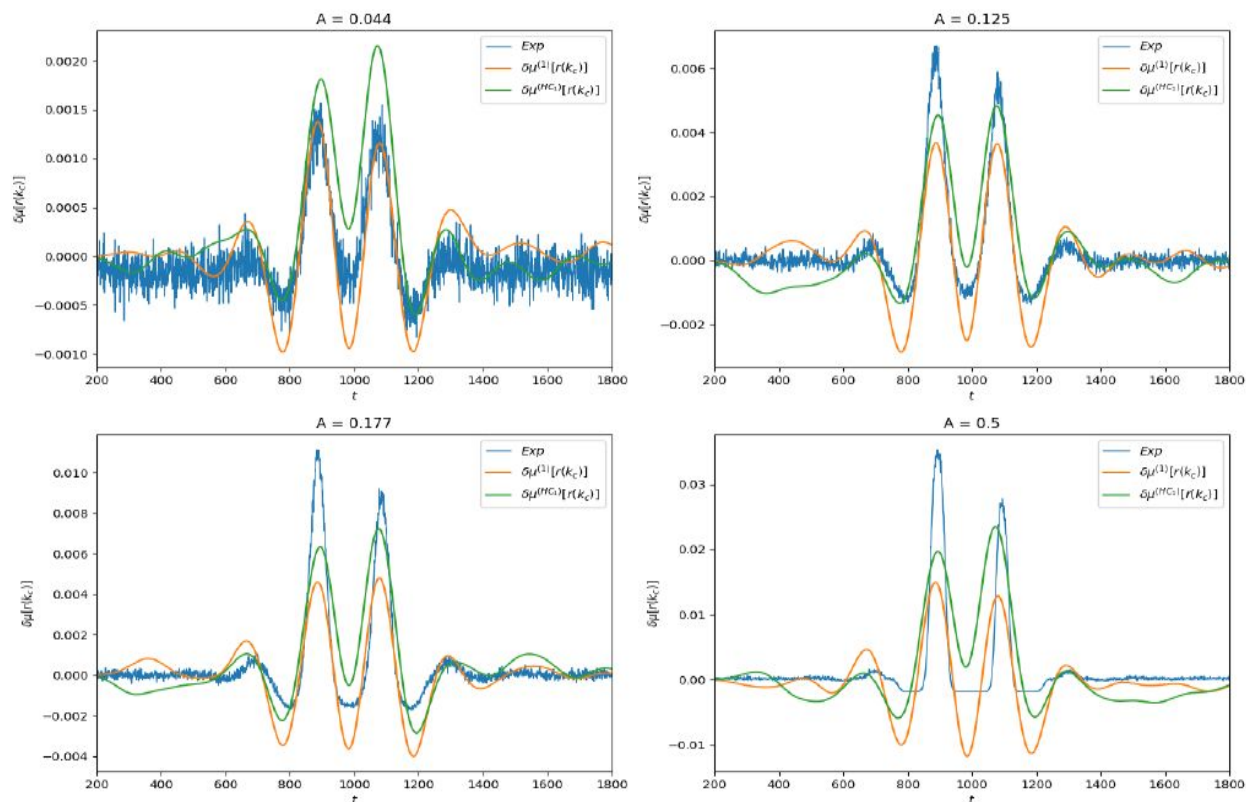

Figure: Linear response of the observable $f(n, \omega) = \omega_{k_c - 2}(n - 3)\omega_{k_c}(n)$.

Higher order observable

Computations have been done using the INRIA Pranas software, B. Cessac et al, *Frontiers in Neuroinformatics*, Vol 11, page 49, (2017).

Question N°3 to mathematicians :

Would it be possible to extend this linear response in a more general context (Hawkes processes, Galves-Löcherbach model) ?

200 400 600 800 1000 1200 1400 1600 1800 200 400 600 800 1000 1200 1400 1600 1800
t t

Figure: Linear response of the observable $f(n, \omega) = \omega_{k_C - 2}(n - 3)\omega_{k_C}(n)$.

Thanks ◀◀