



HAL
open science

The retina as a dynamical system

Bruno Cessac

► **To cite this version:**

Bruno Cessac. The retina as a dynamical system. Dynamics Days 2021 Nice, Aug 2021, Nice, France.
hal-03331814

HAL Id: hal-03331814

<https://inria.hal.science/hal-03331814>

Submitted on 2 Sep 2021

HAL is a multi-disciplinary open access archive for the deposit and dissemination of scientific research documents, whether they are published or not. The documents may come from teaching and research institutions in France or abroad, or from public or private research centers.

L'archive ouverte pluridisciplinaire **HAL**, est destinée au dépôt et à la diffusion de documents scientifiques de niveau recherche, publiés ou non, émanant des établissements d'enseignement et de recherche français ou étrangers, des laboratoires publics ou privés.

The retina as a dynamical system

B. Cessac, Université Côte d'Azur, INRIA,
Biovision team and Neuromod Institute
Sophia Antipolis, France



The retina and its dynamics

The visual system

Retina's layered structure

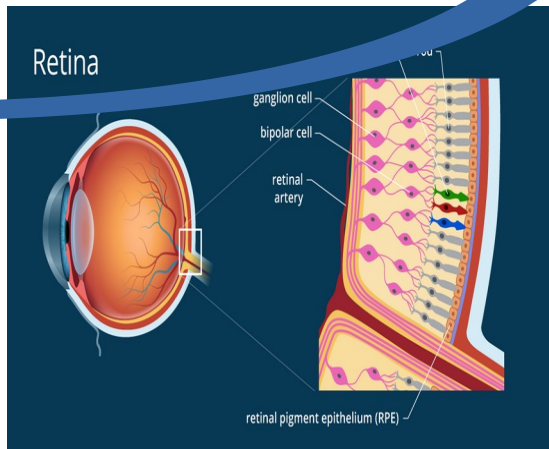
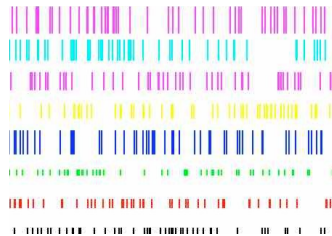
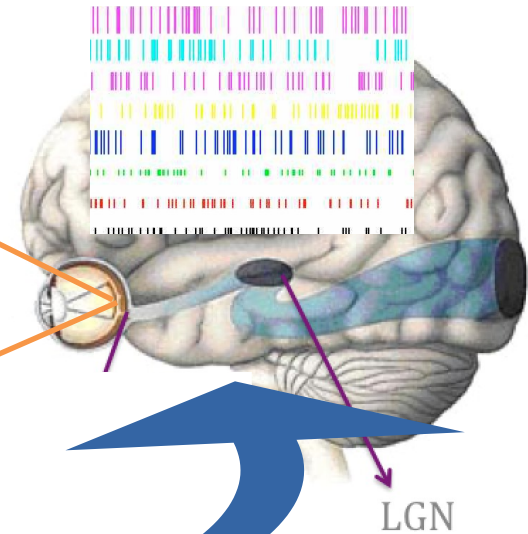
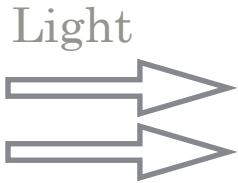
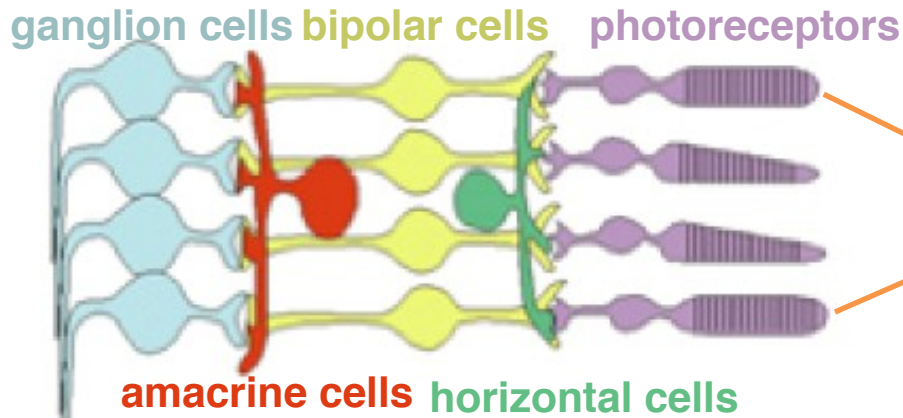

The visual system

« Encoder »

« Decoder »

Retina's layered structure

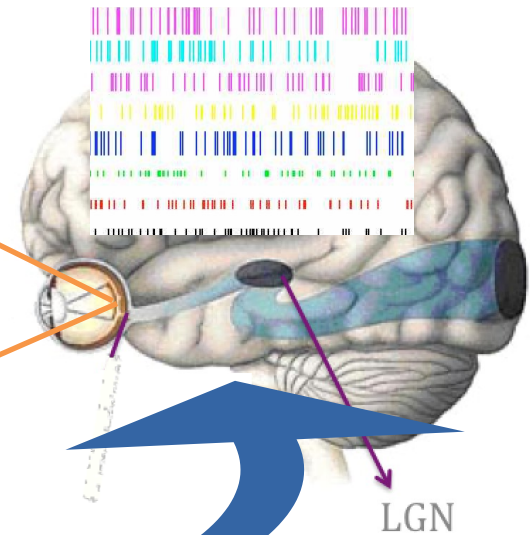
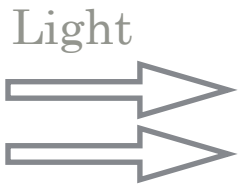
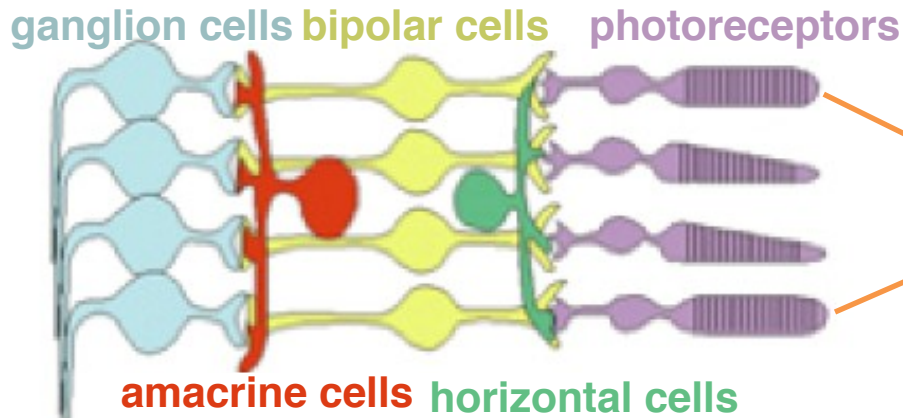

Visual cortex

LGN

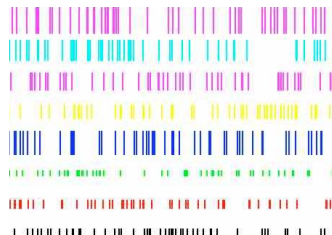

« Information » flux

The visual system

« Encoder »

« Decoder »

Retina's layered structure

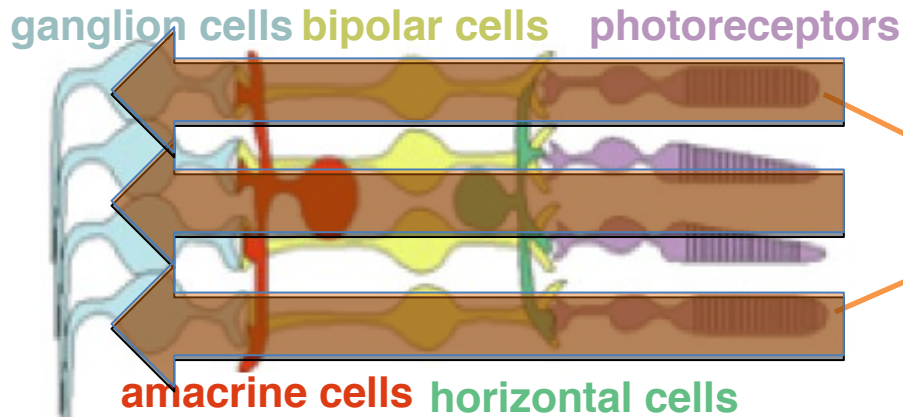

Light

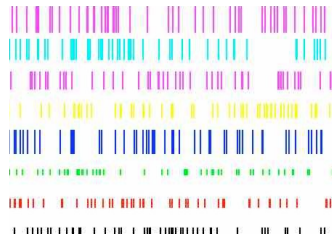
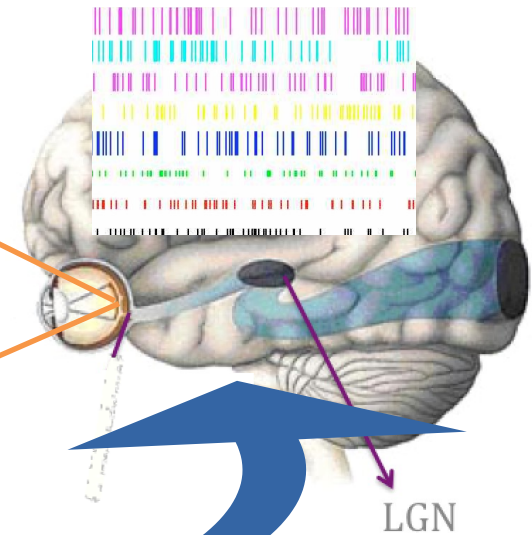

« Information » flux

The visual system

« Encoder »

« Decoder »

Retina's layered structure

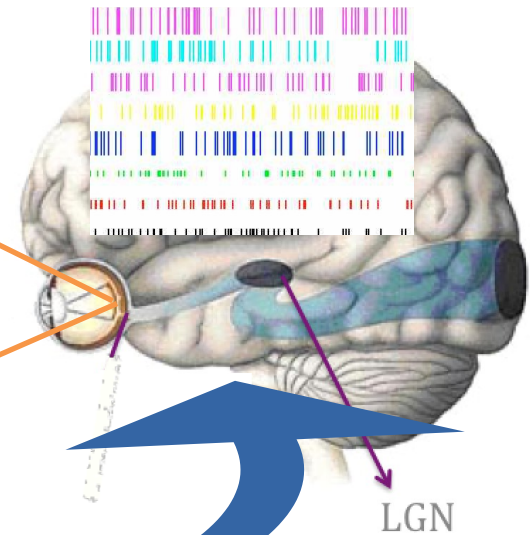
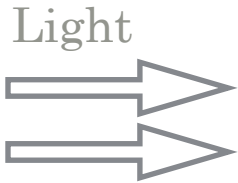
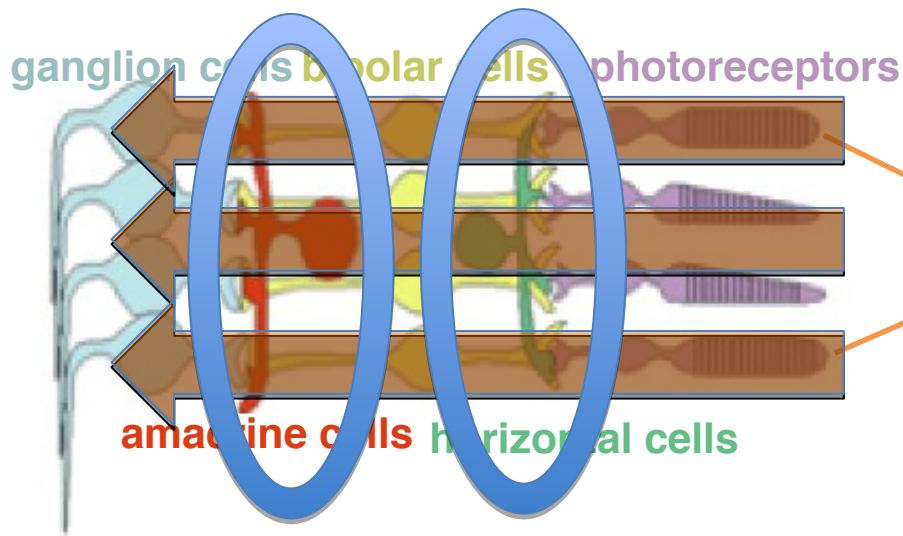

Visual cortex

LGN

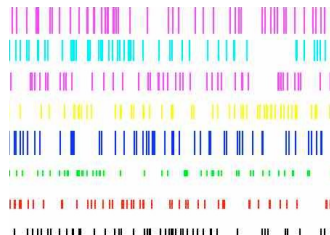

« Information » flux

The visual system

Retina's layered structure

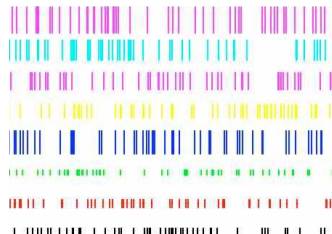
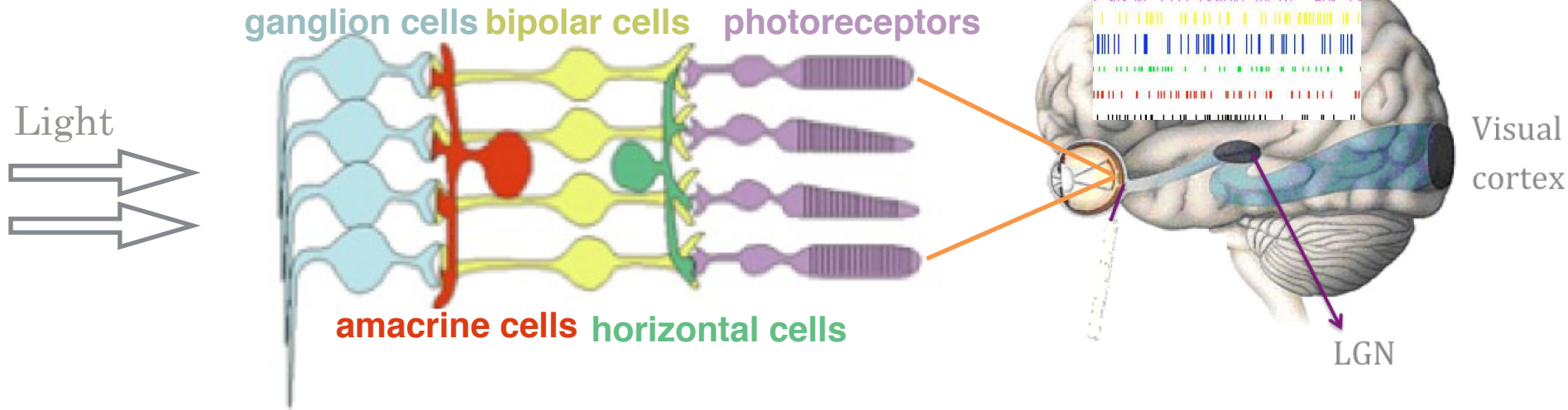

Most neurons in the retina do not spike (except Gcells) =>

« Analogic » computing.

The visual system

Retina's layered structure

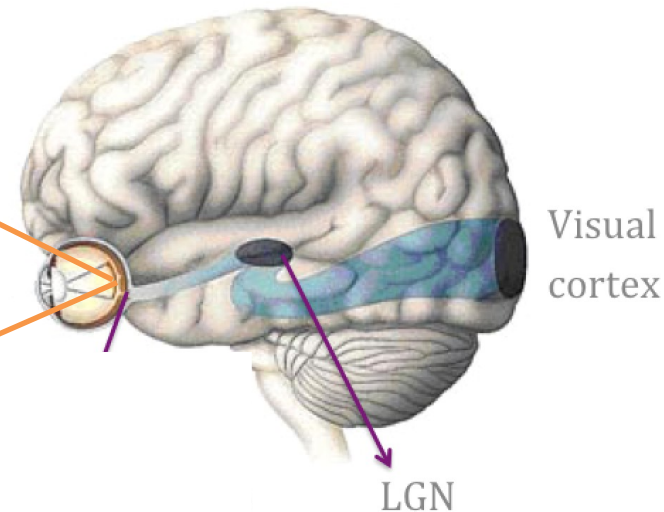
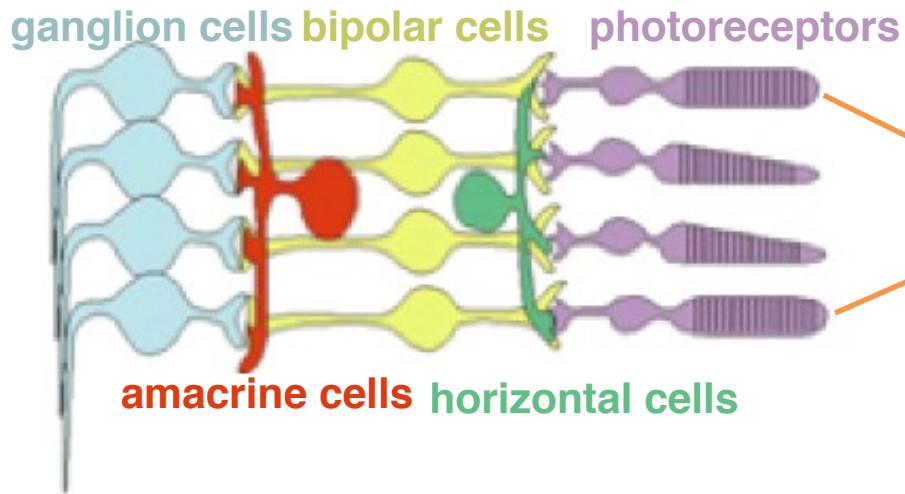

Stimuli are non stationary, with spatio-temporal correlations.

A modeller point of view

1. The retina is a ***high dimensional, non autonomous and noisy*** dynamical system, layered and structured, with ***non stationary and spatially inhomogeneous entries*** (visual scenes).
2. ***Local circuits*** of non linear cells, connected with non linear synapses efficiently process the ***local visual information***. These local circuits are connected together, spanning the whole retina in a ***regular tiling***.
3. The conjunction of non linearities and regular structure can produce a highly complex ***spatio-temporal*** dynamics.
4. The retina is sensitive to ***changes in its physiology*** (development, pharmacology, pathologies). These changes can be addressed from the point of view of ***bifurcations theory***.

Retinal anticipation

Random connectivity and motion
anticipation

S. Souihel (PhD 2016-2019), Biovision team,
INRIA, Sophia Antipolis

F. Chavane, INT, Marseille

A. Destexhe, UNIC, Paris

O. Marre, Institut de la Vision, Paris

B. Cessac, Biovision team, INRIA, Sophia Antipolis



Project : ANR Trajectory.

Visual Anticipation

Anticipation is carried out by the primary visual cortex (V1) through an activation wave

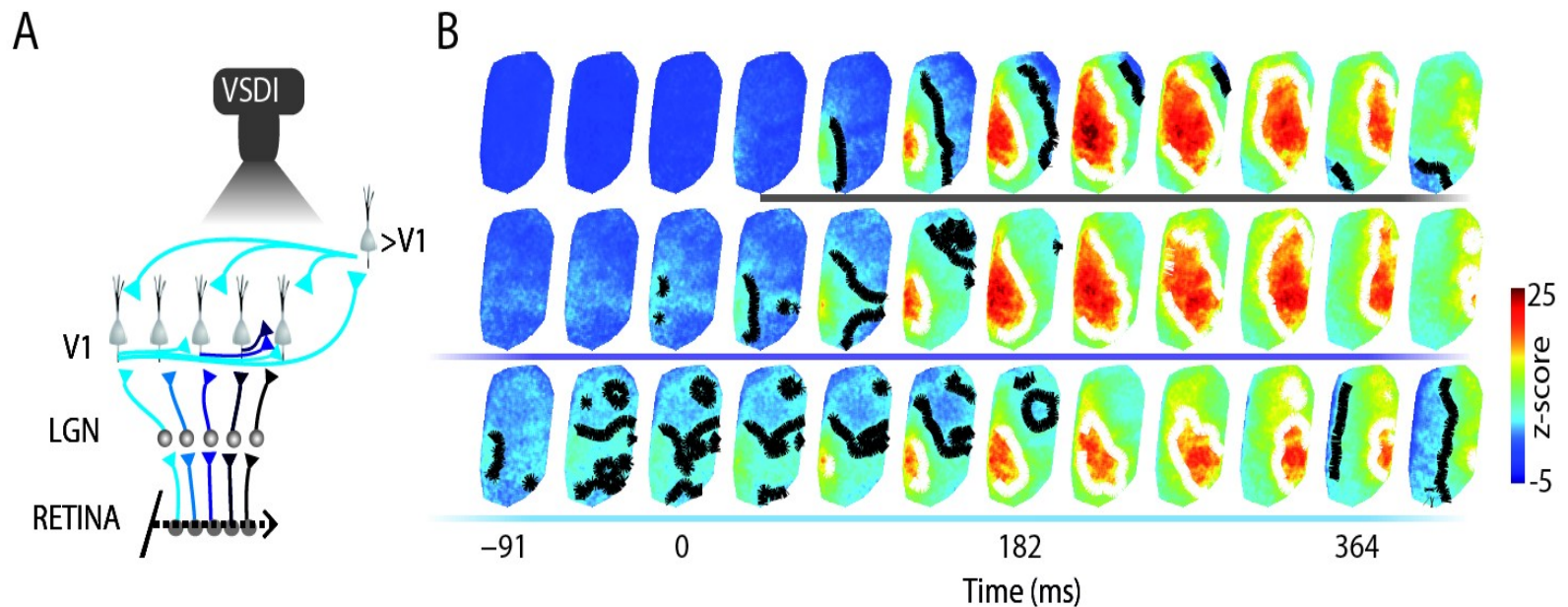

Source : Benvenutti et al. 2015

Visual Anticipation

Anticipation also takes place in the retina

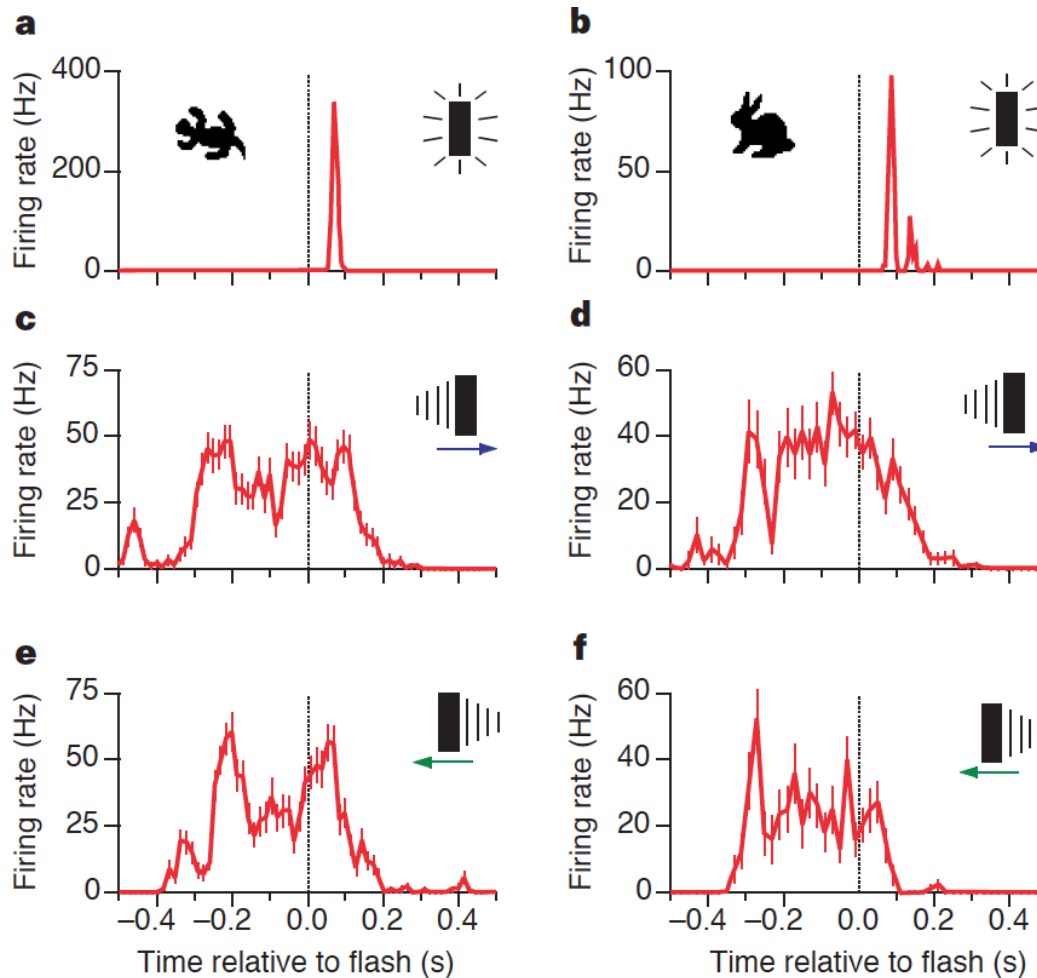

Source :
Berry et al.
1999

Building a 2D retina model for motion anticipation

Souihel S., Cessac B., "On the potential role of lateral connectivity in retinal anticipation", Journal of Mathematical Neuroscience, BioMed Central, 2021, 11, [10.1186/s13408-020-00101-z](https://doi.org/10.1186/s13408-020-00101-z)

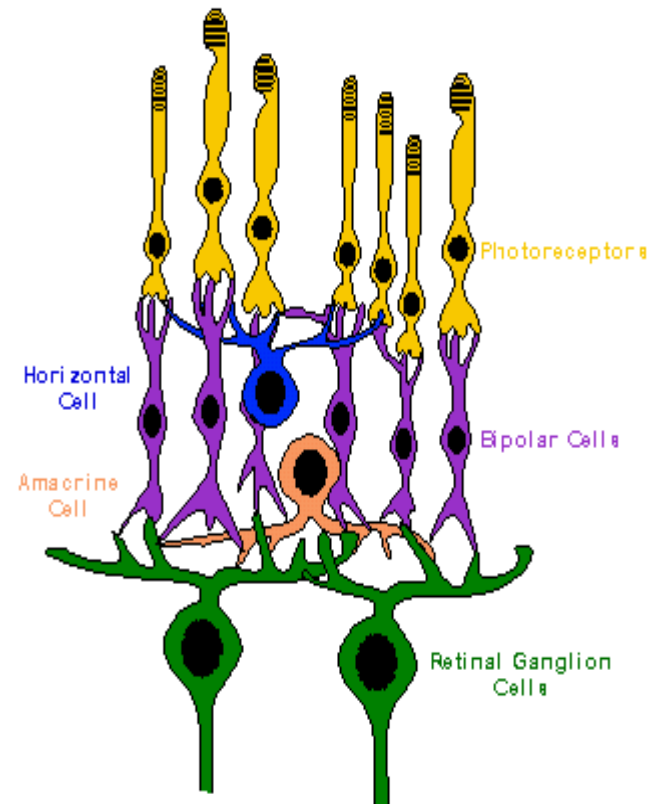
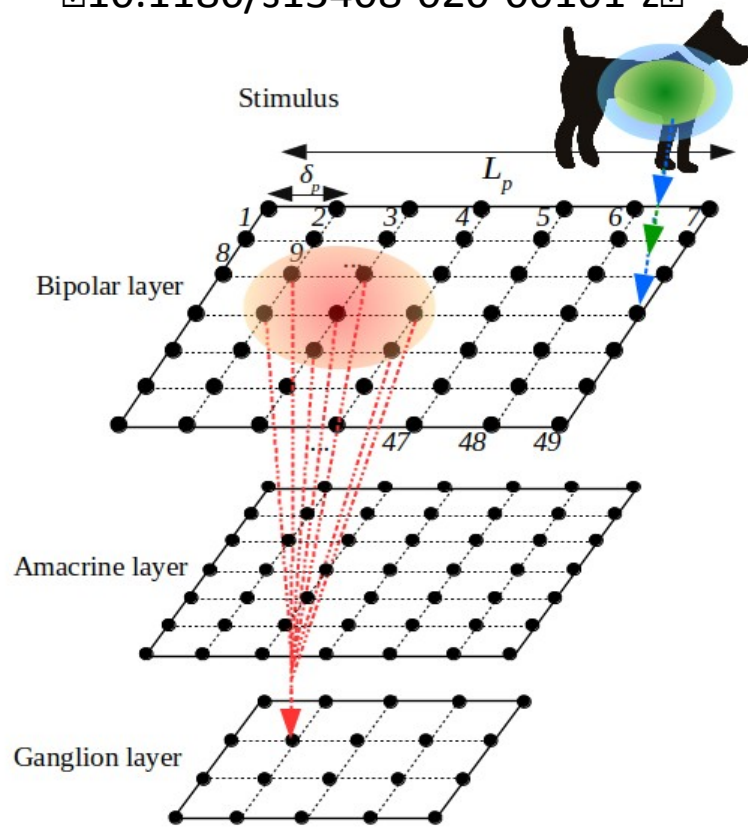

Building a 2D retina model for motion anticipation

Souihel S., Cessac B., "On the potential role of lateral connectivity in retinal anticipation", Journal of Mathematical Neuroscience, BioMed Central, 2021, 11, [10.1186/s13408-020-00101-z](https://doi.org/10.1186/s13408-020-00101-z)

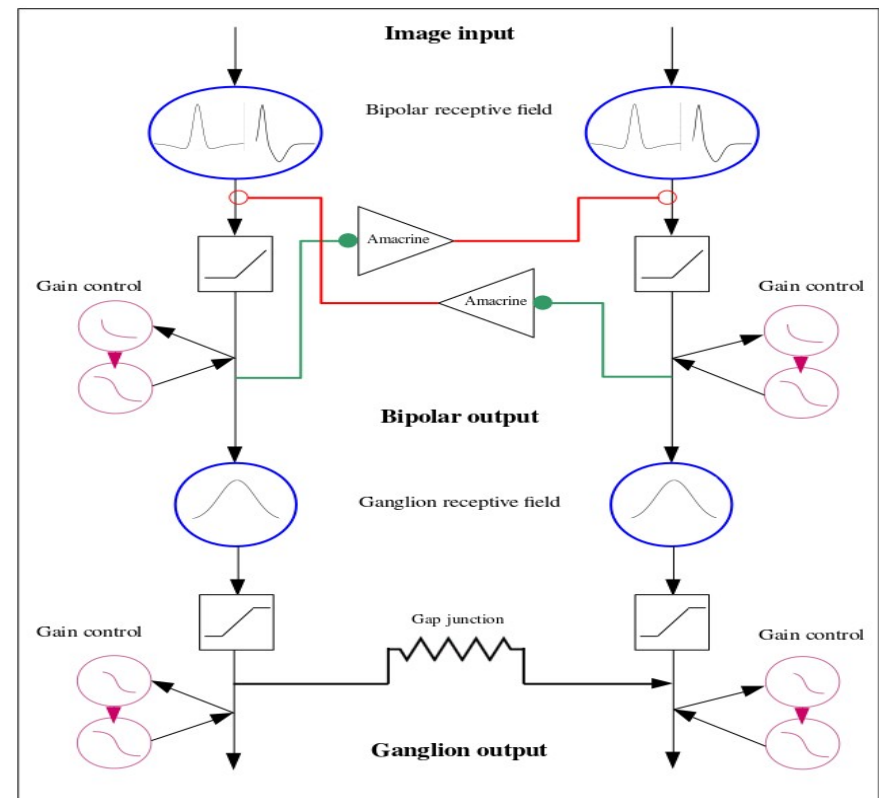
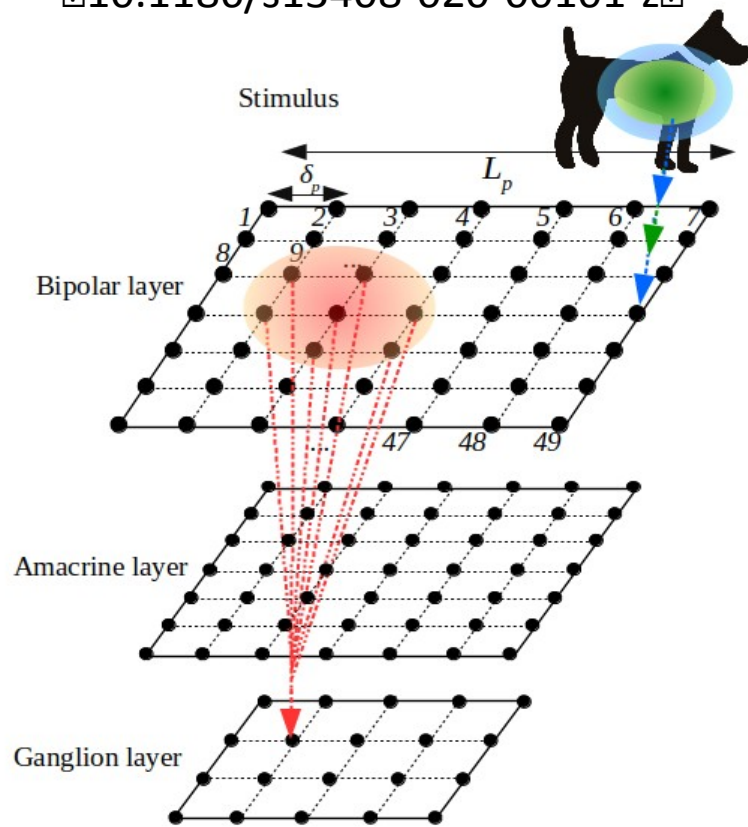

Building a 2D retina model for motion anticipation

Souihel S., Cessac B., “On the potential role of lateral connectivity in retinal anticipation”, Journal of Mathematical Neuroscience, BioMed Central, 2021, 11, [10.1186/s13408-020-00101-z](https://doi.org/10.1186/s13408-020-00101-z)

$$\begin{cases} \frac{dV_{B_i}}{dt} = -\frac{1}{\tau_B}V_{B_i} + \sum_{j=1}^{N_A} W_{B_i}^{A_j} V_{A_j} + F_{B_i}(t), \\ \frac{dV_{A_j}}{dt} = -\frac{1}{\tau_A}V_{A_j} + \sum_{i=1}^{N_B} W_{A_j}^{B_i} R_{B_i}, \\ \frac{dA_{B_i}}{dt} = -\frac{A_{B_i}}{\tau_a} + h_B \mathcal{N}(V_{B_i}). \end{cases}$$

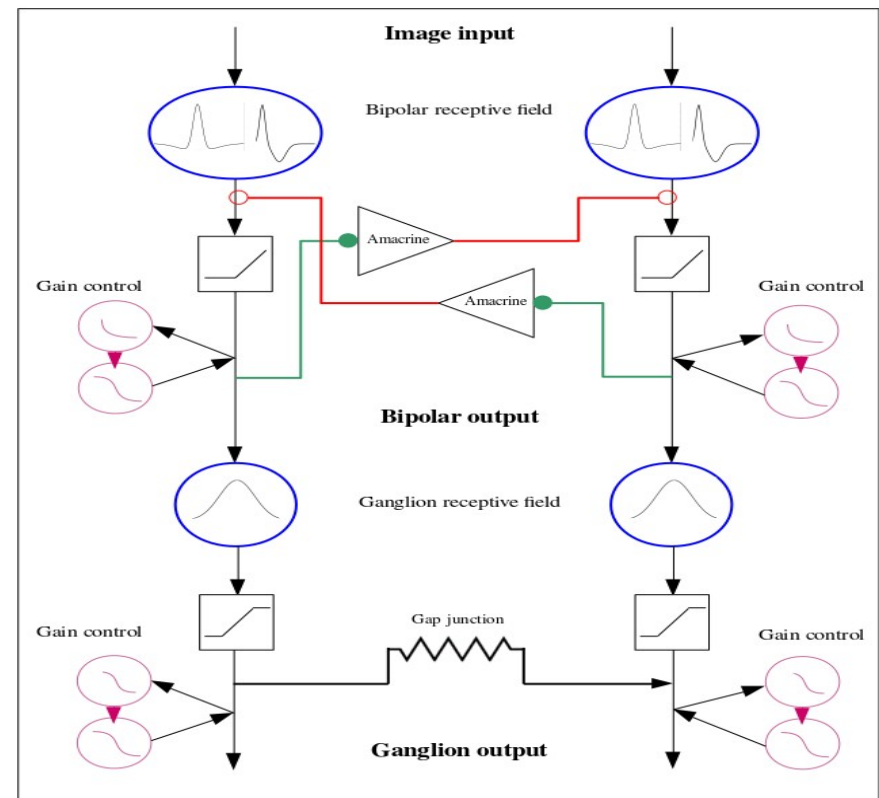

Building a 2D retina model for motion anticipation

Souihel S., Cessac B., "On the potential role of lateral connectivity in retinal anticipation", Journal of Mathematical Neuroscience, BioMed Central, 2021, 11, [10.1186/s13408-020-00101-z](https://doi.org/10.1186/s13408-020-00101-z)

Stimulus dependent drive

$$\left\{ \begin{aligned} \frac{dV_{B_i}}{dt} &= -\frac{1}{\tau_B} V_{B_i} + \sum_{j=1}^{N_A} W_{B_i}^{A_j} V_{A_j} + F_{B_i}(t), \\ \frac{dV_{A_j}}{dt} &= -\frac{1}{\tau_A} V_{A_j} + \sum_{i=1}^{N_B} W_{A_j}^{B_i} R_{B_i}, \\ \frac{dA_{B_i}}{dt} &= -\frac{A_{B_i}}{\tau_a} + h_B \mathcal{N}(V_{B_i}). \end{aligned} \right.$$

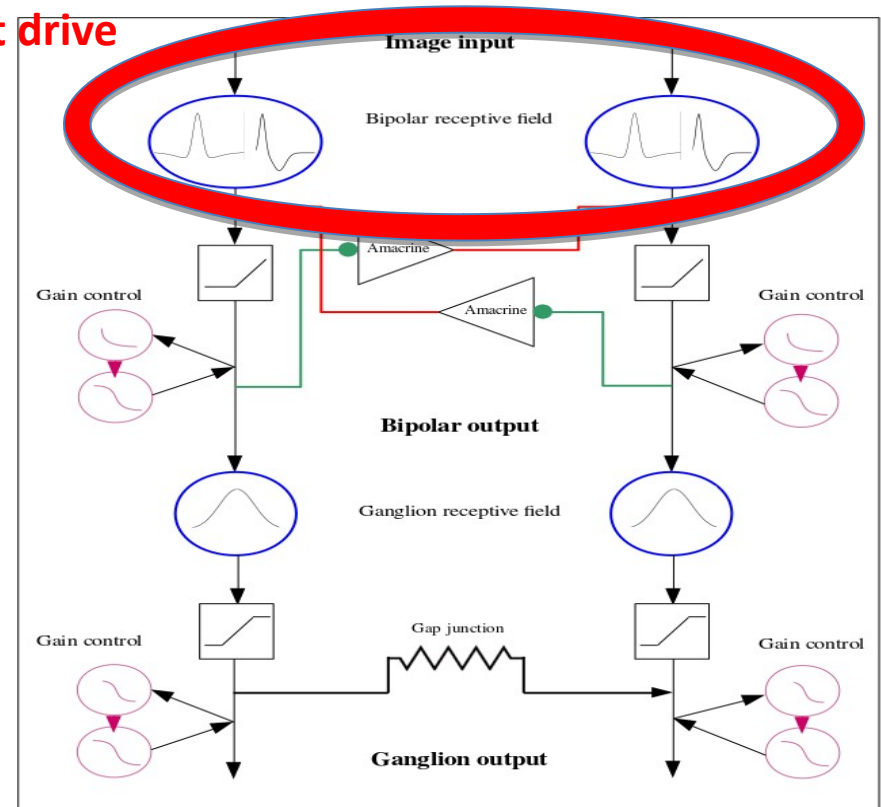

Building a 2D retina model for motion anticipation

Souihel S., Cessac B., "On the potential role of lateral connectivity in retinal anticipation", Journal of Mathematical Neuroscience, BioMed Central, 2021, 11, [10.1186/s13408-020-00101-z](https://doi.org/10.1186/s13408-020-00101-z)

$$\left\{ \begin{aligned} \frac{dV_{B_i}}{dt} &= -\frac{1}{\tau_B} V_{B_i} + \sum_{j=1}^{N_A} W_{B_i}^{A_j} V_{A_j} + F_{B_i}(t), \\ \frac{dV_{A_j}}{dt} &= -\frac{1}{\tau_A} V_{A_j} + \sum_{i=1}^{N_B} W_{A_j}^{B_i} R_{B_i}, \\ \frac{dA_{B_i}}{dt} &= -\frac{A_{B_i}}{\tau_a} + h_B \mathcal{N}(V_{B_i}). \end{aligned} \right.$$

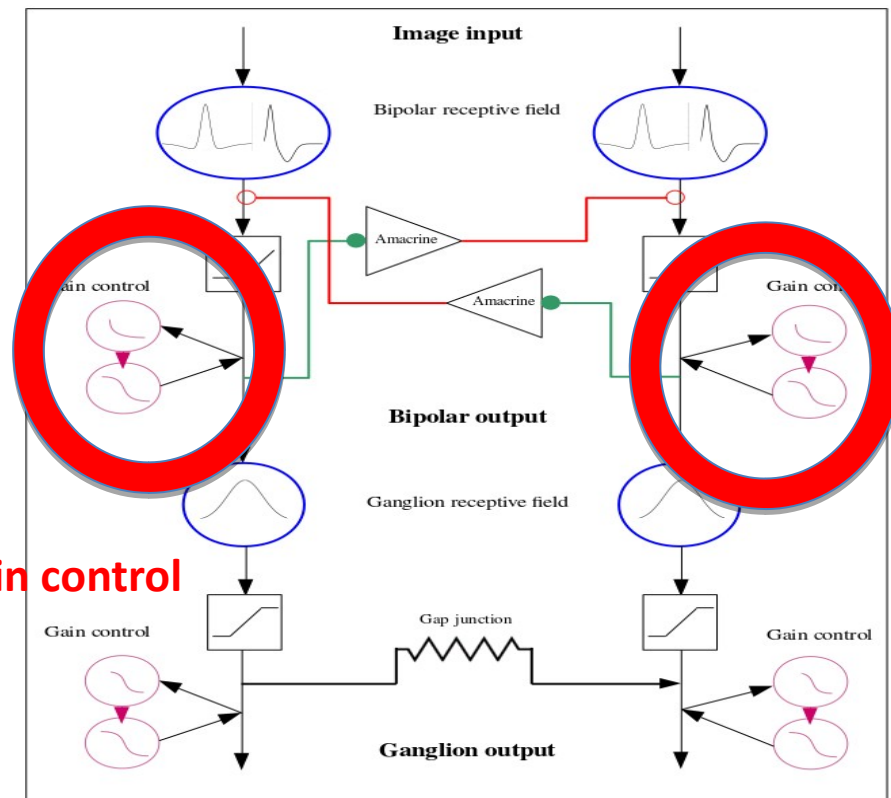

Building a 2D retina model for motion anticipation

Souihel S., Cessac B., "On the potential role of lateral connectivity in retinal anticipation", Journal of Mathematical Neuroscience, BioMed Central, 2021, 11, [10.1186/s13408-020-00101-z](https://doi.org/10.1186/s13408-020-00101-z)

$$\begin{cases} \frac{dV_{B_i}}{dt} = -\frac{1}{\tau_B} V_{B_i} + \sum_{j=1}^{N_A} W_{B_i}^{A_j} V_{A_j} + F_{B_i}(t), \\ \frac{dV_{A_j}}{dt} = -\frac{1}{\tau_A} V_{A_j} + \sum_{i=1}^{N_B} W_{A_j}^{B_i} R_{B_i}, \\ \frac{dA_{B_i}}{dt} = -\frac{A_{B_i}}{\tau_a} + h_B \mathcal{N}(V_{B_i}). \end{cases}$$



Non linear gain control

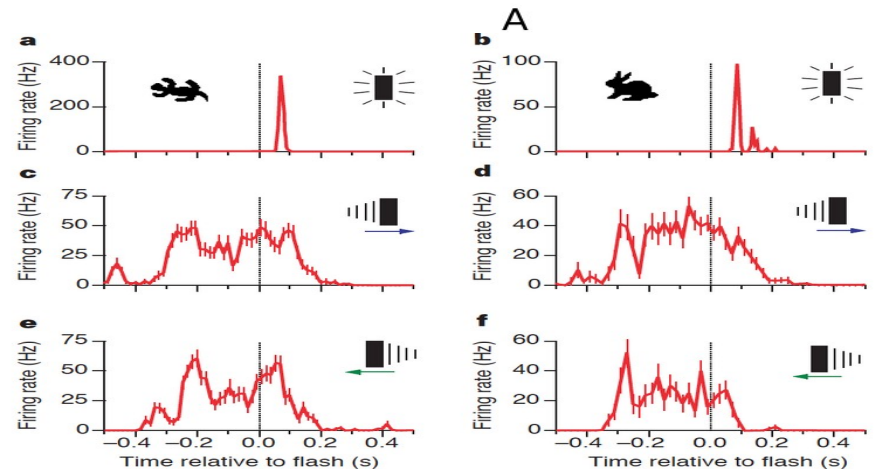
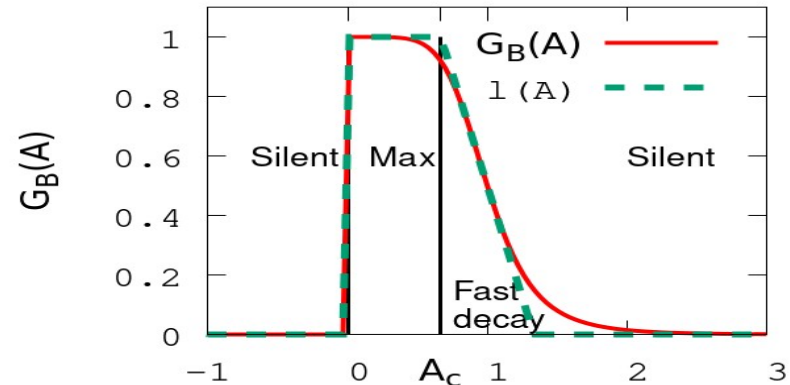

Building a 2D retina model for motion anticipation

Souihel S., Cessac B., "On the potential role of lateral connectivity in retinal anticipation", Journal of Mathematical Neuroscience, BioMed Central, 2021, 11, [10.1186/s13408-020-00101-z](https://doi.org/10.1186/s13408-020-00101-z)

Inhibition

$$\begin{cases} \frac{dV_{B_i}}{dt} = -\frac{1}{\tau_B}V_{B_i} + \sum_{j=1}^N W_{B_i}^{A_j} V_{A_j} + F_{B_i}(t), \\ \frac{dV_{A_j}}{dt} = -\frac{1}{\tau_A}V_{A_j} + \sum_{i=1}^{N_B} W_{A_j}^{B_i} R_{B_i}, \\ \frac{dA_{B_i}}{dt} = -\frac{A_{B_i}}{\tau_a} + h_B \mathcal{N}(V_{B_i}). \end{cases}$$

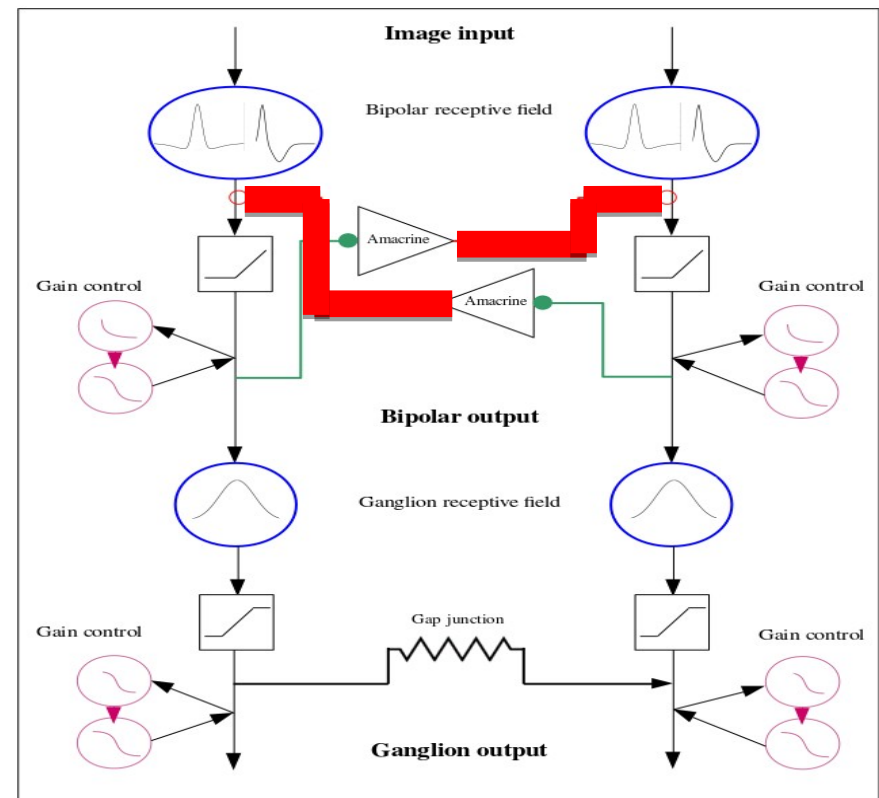

Building a 2D retina model for motion anticipation

Souihel S., Cessac B., "On the potential role of lateral connectivity in retinal anticipation", Journal of Mathematical Neuroscience, BioMed Central, 2021, 11, [10.1186/s13408-020-00101-z](https://doi.org/10.1186/s13408-020-00101-z)

$$\left\{ \begin{aligned} \frac{dV_{B_i}}{dt} &= -\frac{1}{\tau_B} V_{B_i} + \sum_{j=1}^{N_A} W_{B_i}^{A_j} V_{A_j} + F_{B_i}(t), \\ \frac{dV_{A_j}}{dt} &= -\frac{1}{\tau_A} V_{A_j} + \sum_{i=1}^B W_{A_j}^{B_i} R_{B_i}, \\ \frac{dA_{B_i}}{dt} &= -\frac{A_{B_i}}{\tau_a} + h_B \mathcal{N}(V_{B_i}). \end{aligned} \right.$$

Excitation

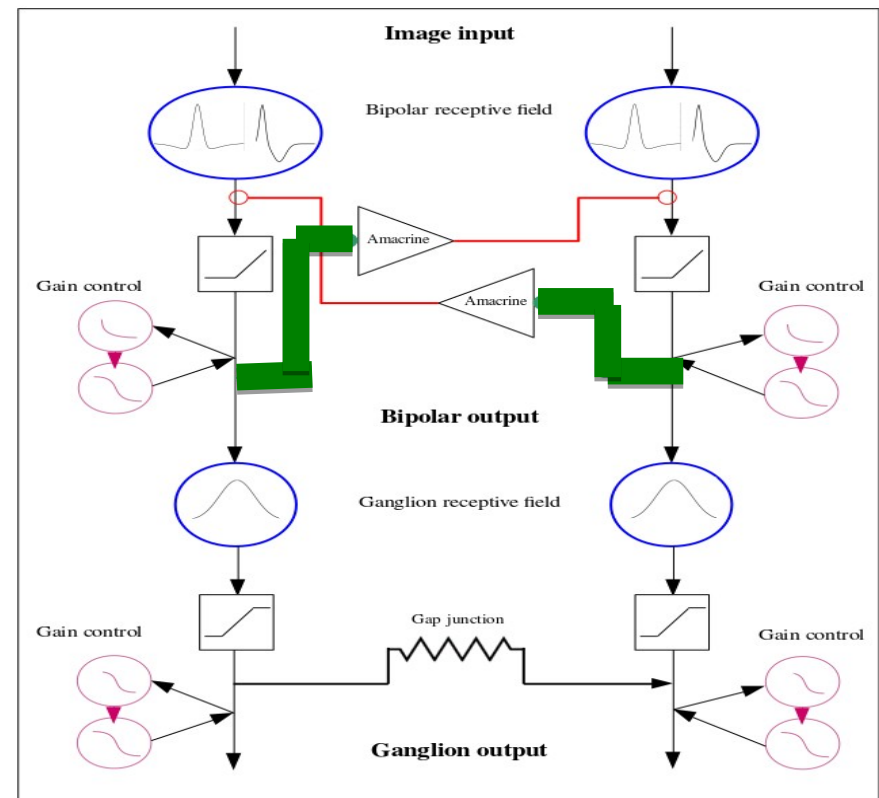

Building a 2D retina model for motion anticipation

Souihel S., Cessac B., "On the potential role of lateral connectivity in retinal anticipation", Journal of Mathematical Neuroscience, BioMed Central, 2021, 11, [10.1186/s13408-020-00101-z](https://doi.org/10.1186/s13408-020-00101-z)

Linear regime

$$\frac{d\vec{\chi}}{dt} = \mathcal{L} \cdot \vec{\chi} + \vec{F}(t).$$

$$\mathcal{L} = \begin{pmatrix} -\frac{I_{N,N}}{\tau_B} & W_B^A & 0_{N,N} \\ W_A^B & -\frac{I_{N,N}}{\tau_A} & 0_{N,N} \\ h_B I_{N,N} & 0_{N,N} & -\frac{I_{N,N}}{\tau_a} \end{pmatrix}$$

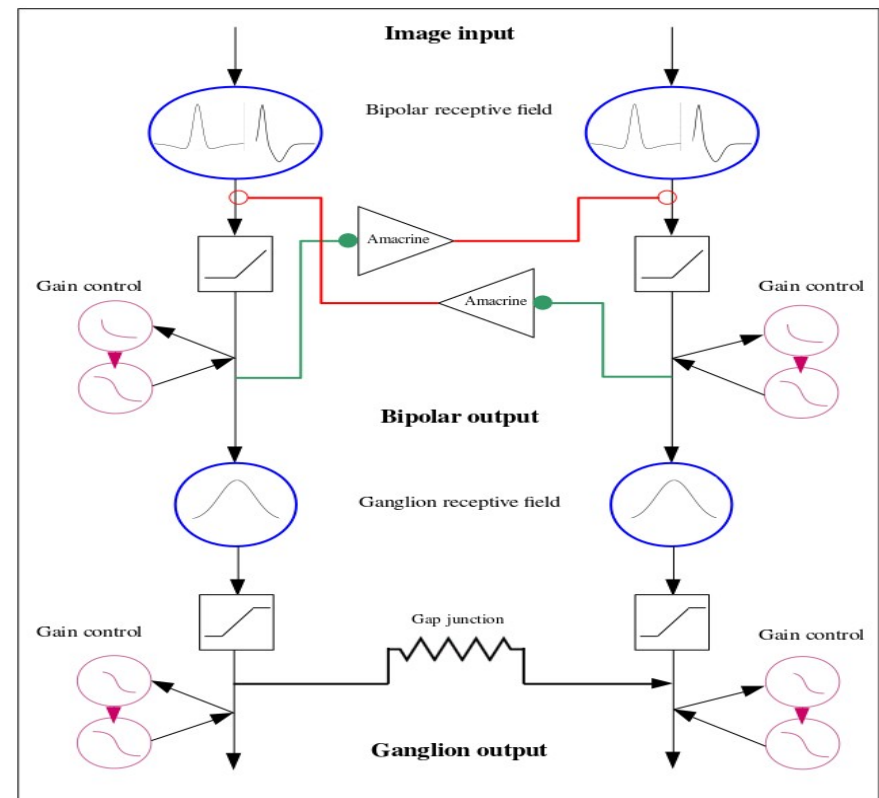

Building a 2D retina model for motion anticipation

Souihel S., Cessac B., “On the potential role of lateral connectivity in retinal anticipation”, Journal of Mathematical Neuroscience, BioMed Central, 2021, 11, [10.1186/s13408-020-00101-z](https://doi.org/10.1186/s13408-020-00101-z)

Linear regime

$$\frac{d\vec{\chi}}{dt} = \mathcal{L} \cdot \vec{\chi} + \vec{F}(t).$$

$$\mathcal{L} = \begin{pmatrix} -\frac{I_{N,N}}{\tau_B} & W_B^A & 0_{N,N} \\ W_A^B & -\frac{I_{N,N}}{\tau_A} & 0_{N,N} \\ h_B I_{N,N} & 0_{N,N} & -\frac{I_{N,N}}{\tau_a} \end{pmatrix}$$

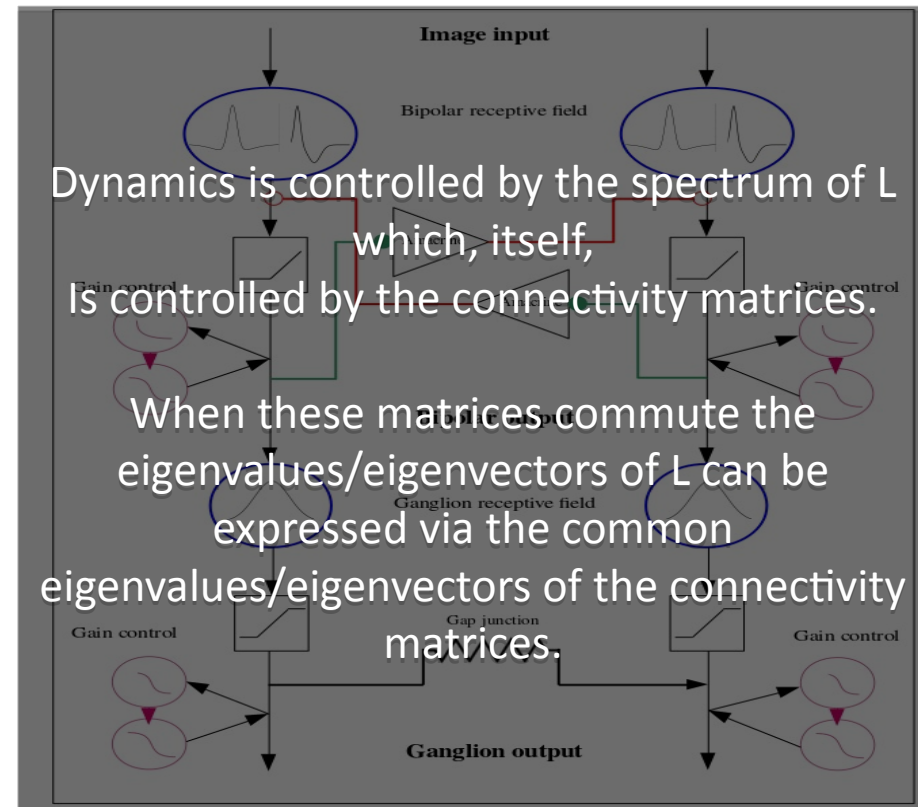

Building a 2D retina model for motion anticipation

Souihel S., Cessac B., “On the potential role of lateral connectivity in retinal anticipation”, Journal of Mathematical Neuroscience, BioMed Central, 2021, 11, [10.1186/s13408-020-00101-z](https://doi.org/10.1186/s13408-020-00101-z)

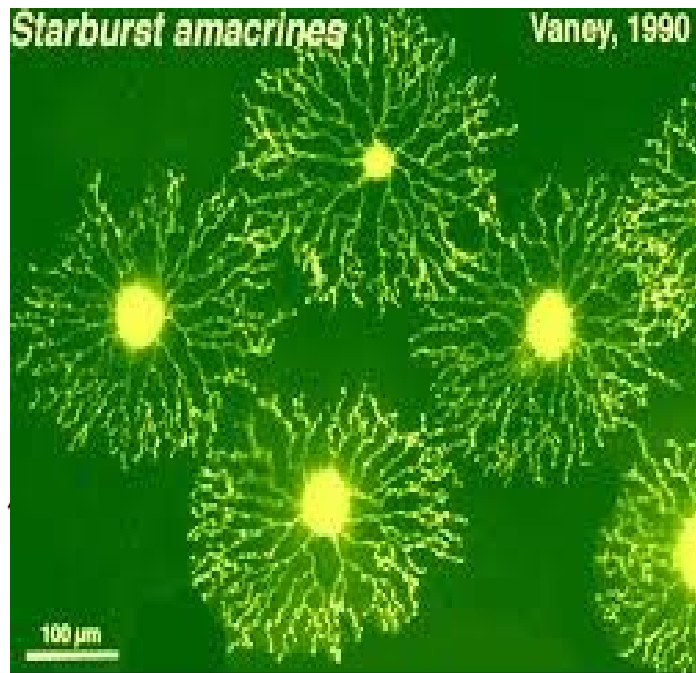
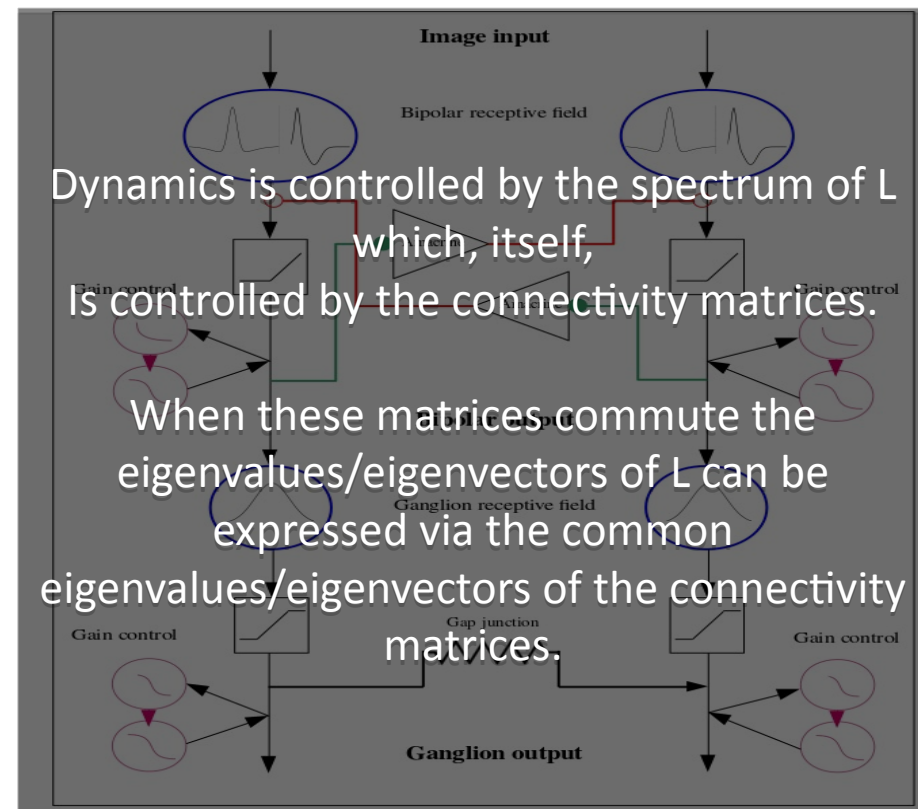
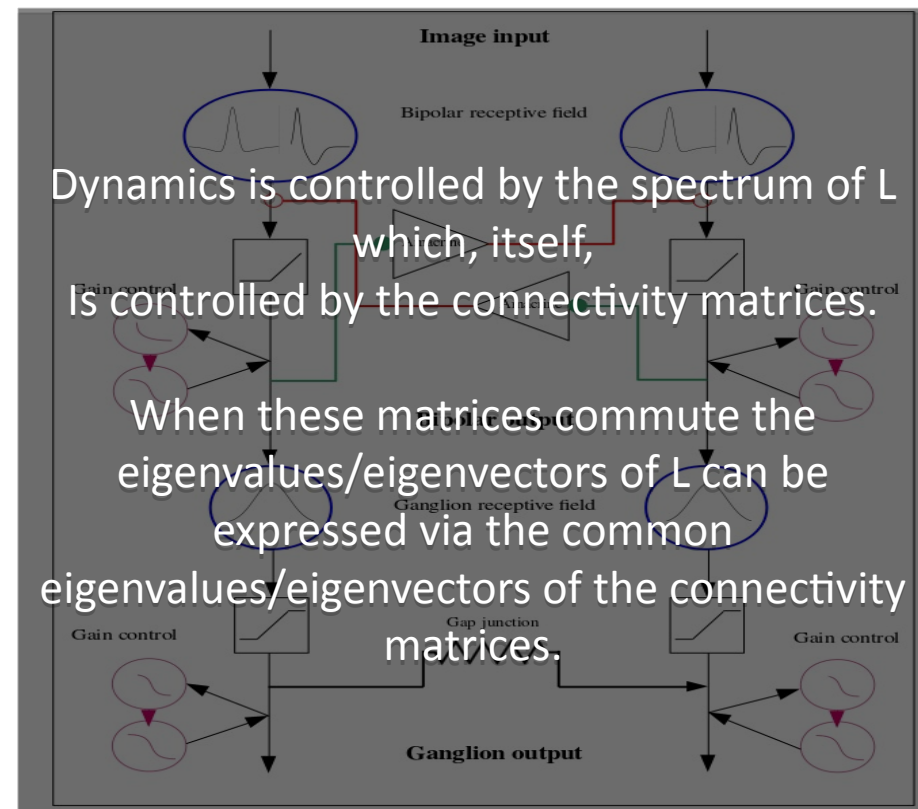
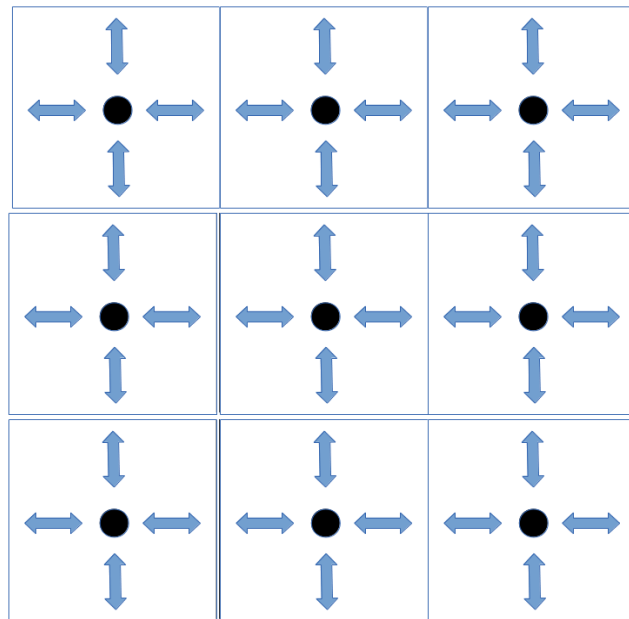

Fig. 7. Starburst amacrine cells are stained with Lucifer yellow in whole-mount rabbit retina.



Building a 2D retina model for motion anticipation

Souihel S., Cessac B., "On the potential role of lateral connectivity in retinal anticipation", Journal of Mathematical Neuroscience, BioMed Central, 2021, 11, [10.1186/s13408-020-00101-z](https://doi.org/10.1186/s13408-020-00101-z)



Building a 2D retina model for motion anticipation

Souihel S., Cessac B., "On the potential role of lateral connectivity in retinal anticipation", Journal of Mathematical Neuroscience, BioMed Central, 2021, 11, [10.1186/s13408-020-00101-z](https://doi.org/10.1186/s13408-020-00101-z)

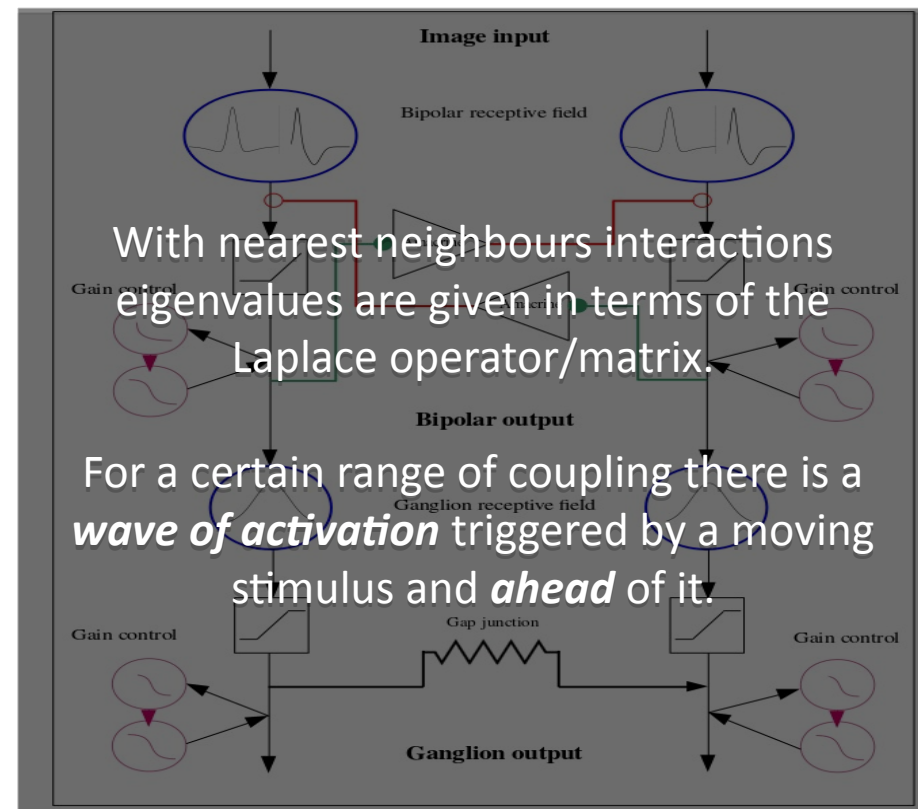
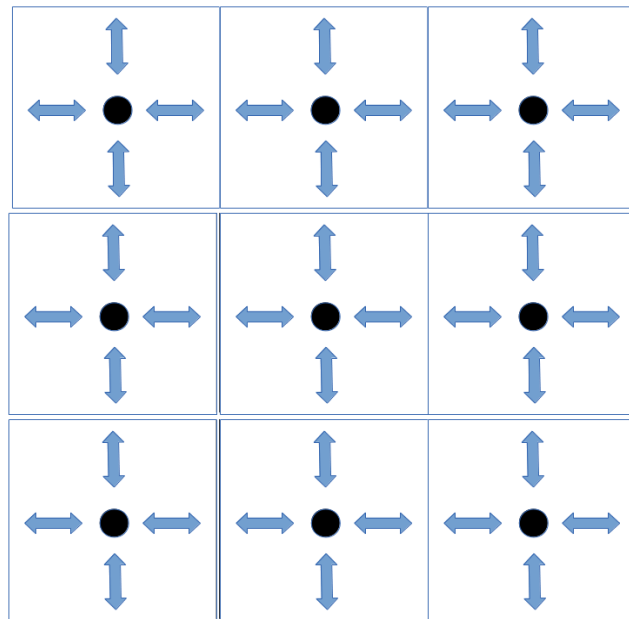

Building a 2D retina model for motion anticipation

Souihel S., Cessac B., "On the potential role of lateral connectivity in retinal anticipation", Journal of Mathematical Neuroscience, BioMed Central, 2021, 11, [10.1186/s13408-020-00101-z](https://doi.org/10.1186/s13408-020-00101-z)

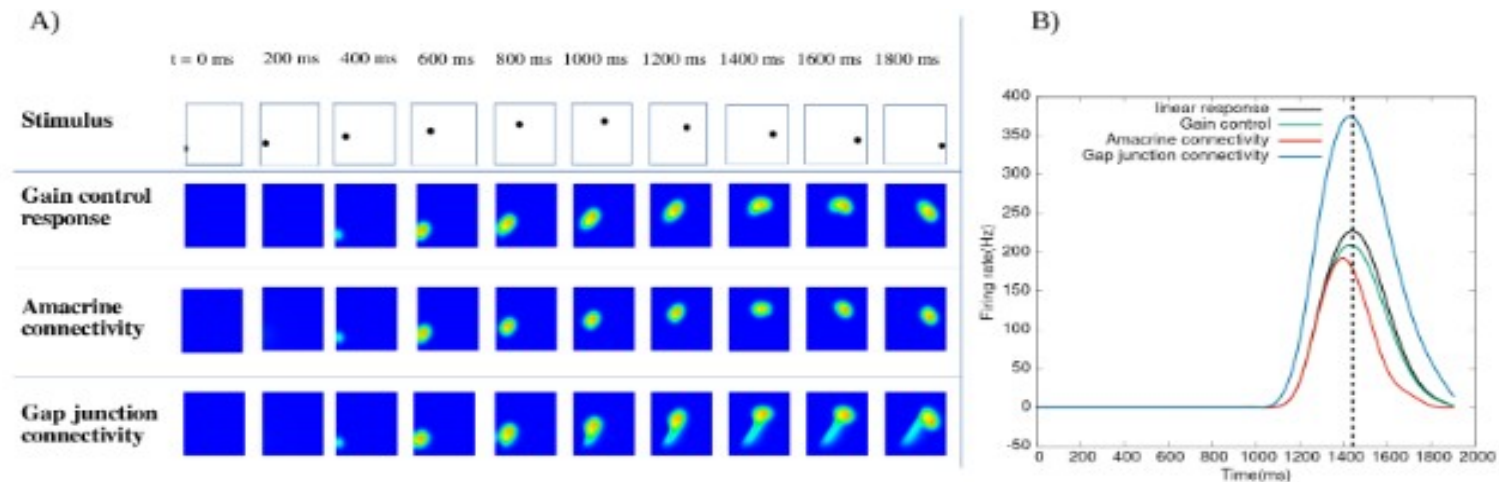
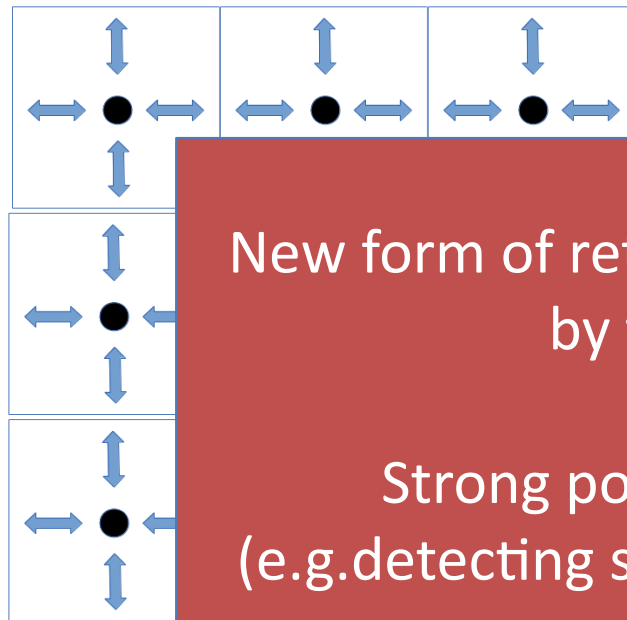

Figure 15: **Effect of anticipatory mechanisms on a parabolic trajectory.** A) Response to a dot moving along a parabolic trajectory. The first line shows the stimulus, the second line shows the GCells response with gain control, the third line presents the effect of lateral ACells connectivity with $w = 0.3 \text{ ms}^{-1}$, and the last line shows the effect of asymmetric gap junctions with $v_{gap} = 9 \text{ mm/s}$. B) Time course response of a cell responding to the dot near the trajectory turning point. Linear response corresponds to the response to the stimulus without gain control.



Building a 2D retina model for motion anticipation

Souihel S., Cessac B., "On the potential role of lateral connectivity in retinal anticipation", Journal of Mathematical Neuroscience, BioMed Central, 2021, 11, [10.1186/s13408-020-00101-z](https://doi.org/10.1186/s13408-020-00101-z)



New form of retinal anticipation induced by the network.

Strong potential implications (e.g. detecting surprise in a visual scene)

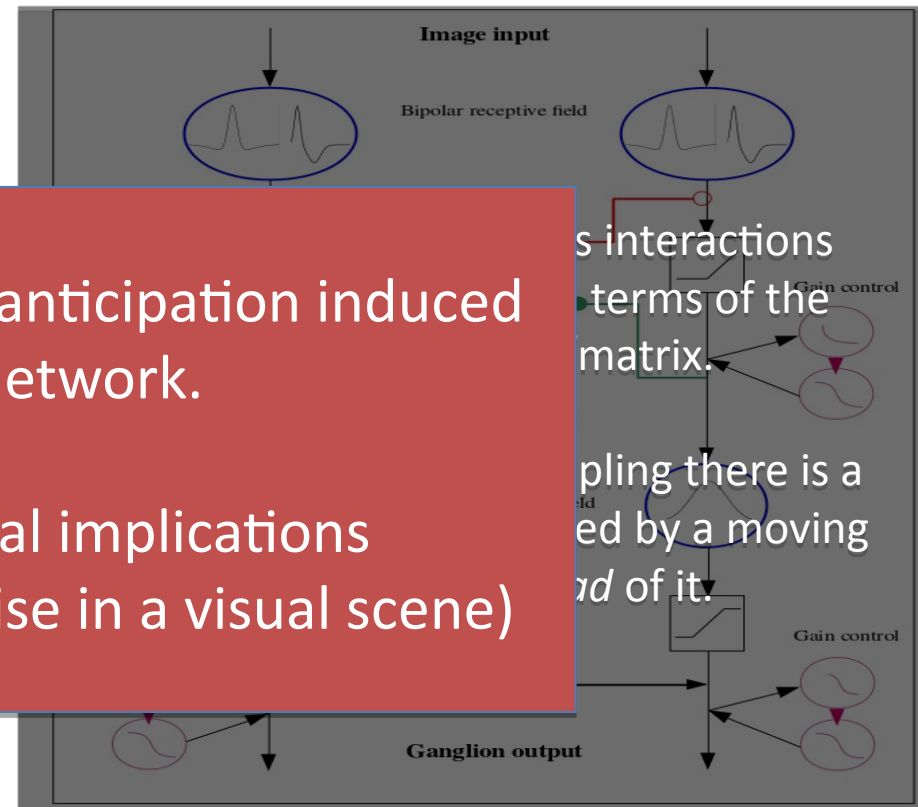

Building a 2D retina model for motion anticipation

Souihel S., Cessac B., "On the potential role of lateral connectivity in retinal anticipation", Journal of Mathematical Neuroscience, BioMed Central, 2021, 11, [10.1186/s13408-020-00101-z](https://doi.org/10.1186/s13408-020-00101-z)

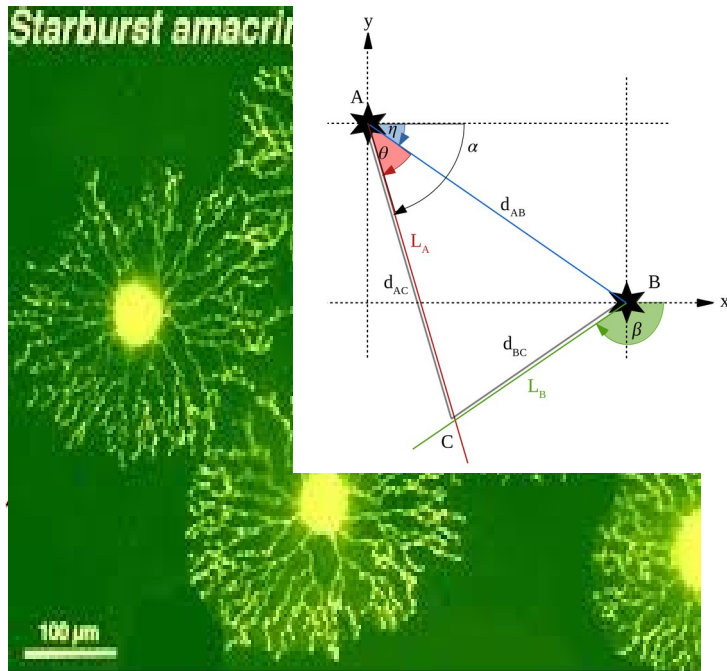
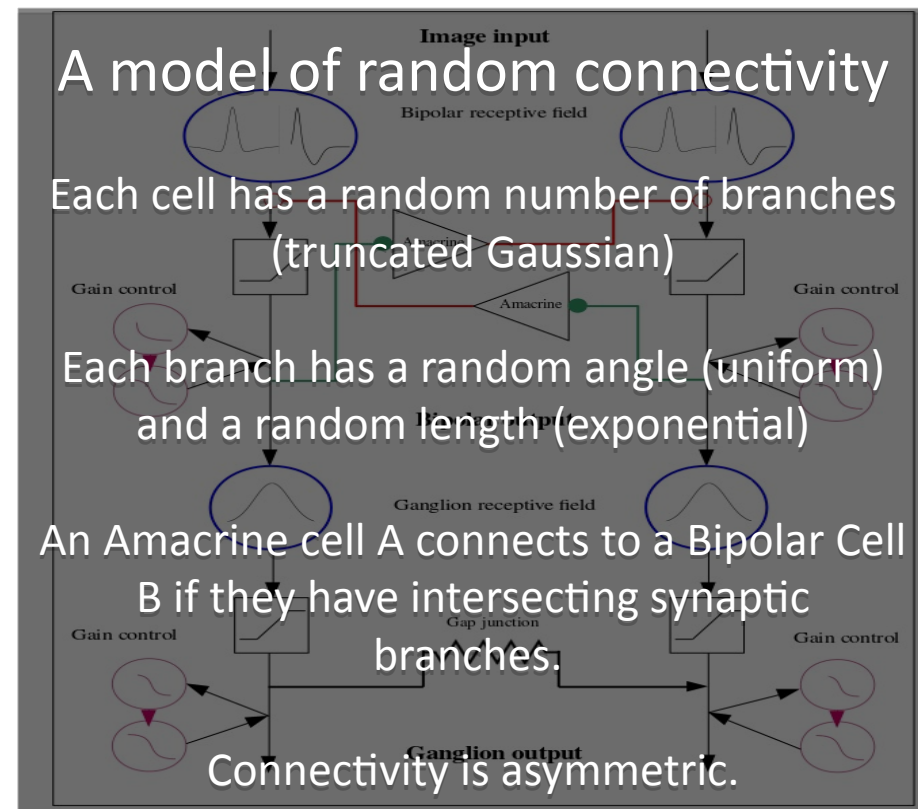
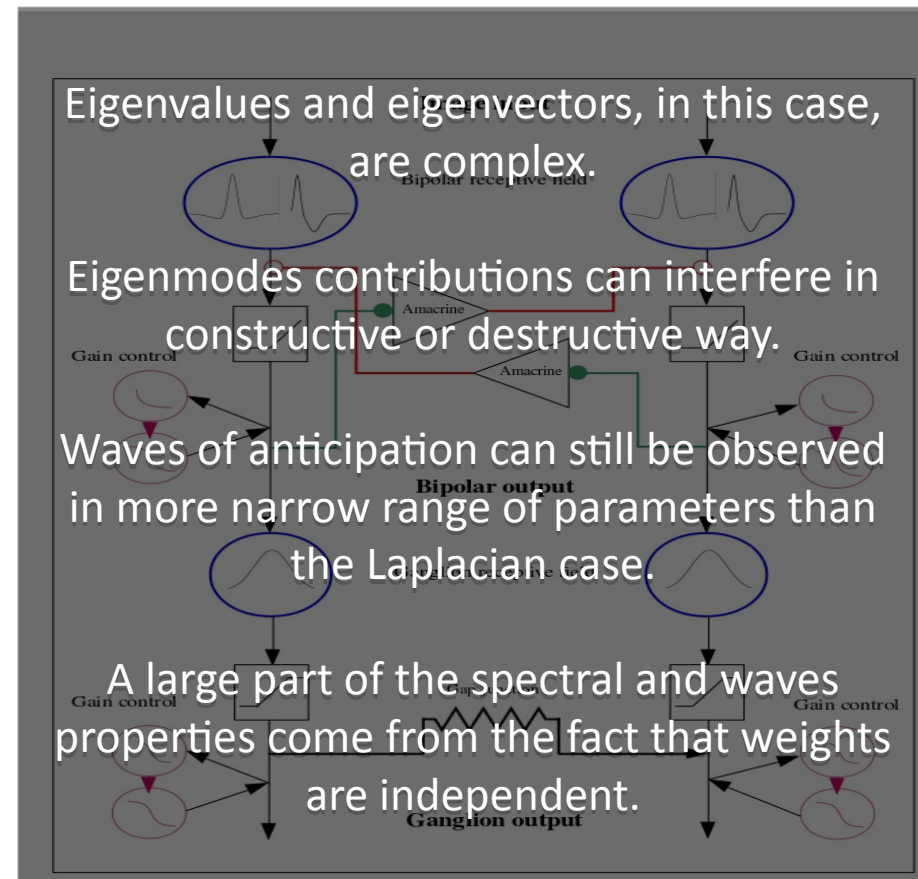
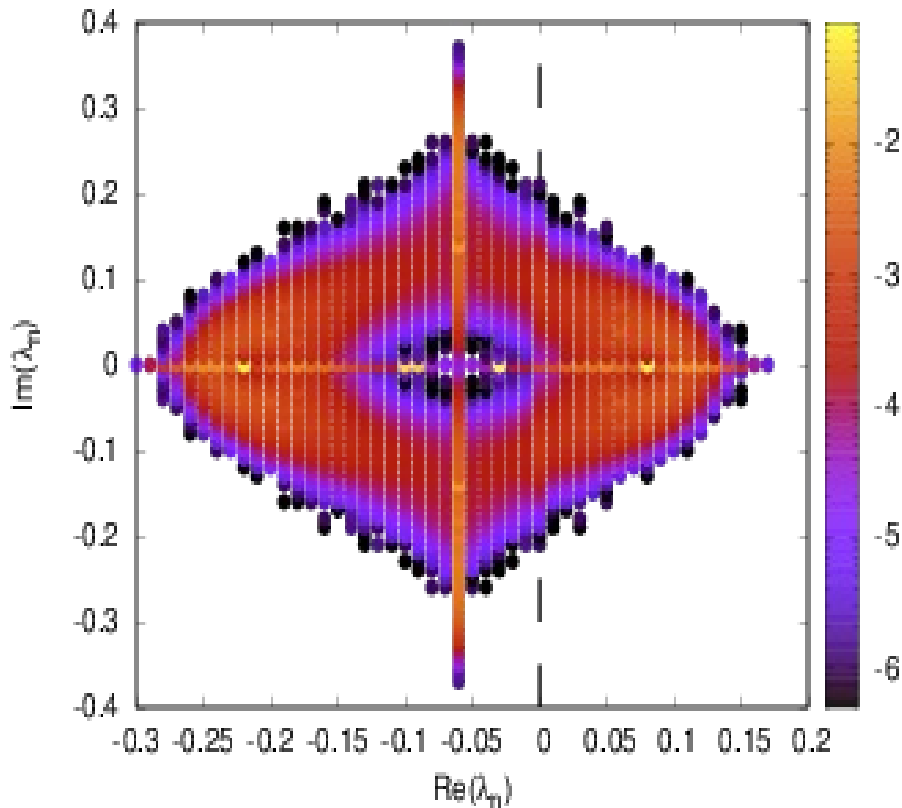

Fig. 7. Starburst amacrine cells are stained with lucifer yellow in whole-mount rabbit retina.



Building a 2D retina model for motion anticipation

Souihel S., Cessac B., "On the potential role of lateral connectivity in retinal anticipation", Journal of Mathematical Neuroscience, BioMed Central, 2021, 11, [10.1186/s13408-020-00101-z](https://doi.org/10.1186/s13408-020-00101-z)



Mathematical extensions

- Non linear effects (gain control, rectification) maintain the dynamics in a compact set even when some eigenvalues of L are unstable ;
- This non linear dynamical system can be approximated by a piecewise linear one where dynamics is linear in convex domains spanning the phase space;
- The evolution under the influence of a time-dependent stimulus can be computed as a composition of (non commuting) linear operators labelled by their domains of continuity ;

Perspectives

- A retino-cortical (V1) model of anticipation (with F. Chavane, S. Chemla, A. Destexhe, S. Souihel, M. Di Volo).

Perspectives

- A retino-cortical (V1) model of anticipation (with F. Chavane, S. Chemla, A. Destexhe, S. Souihel, M. Di Volo).

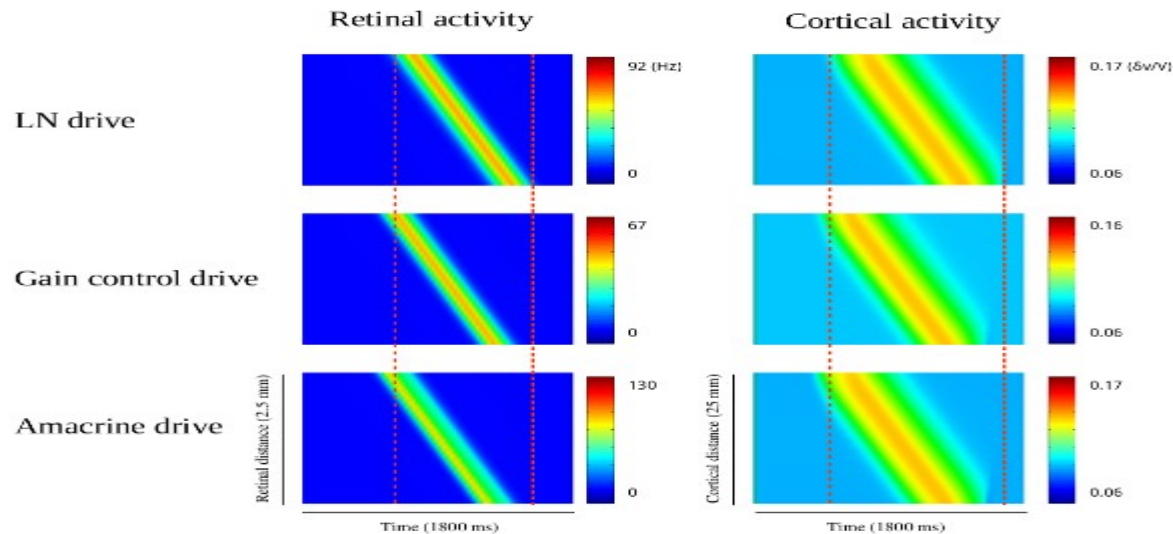
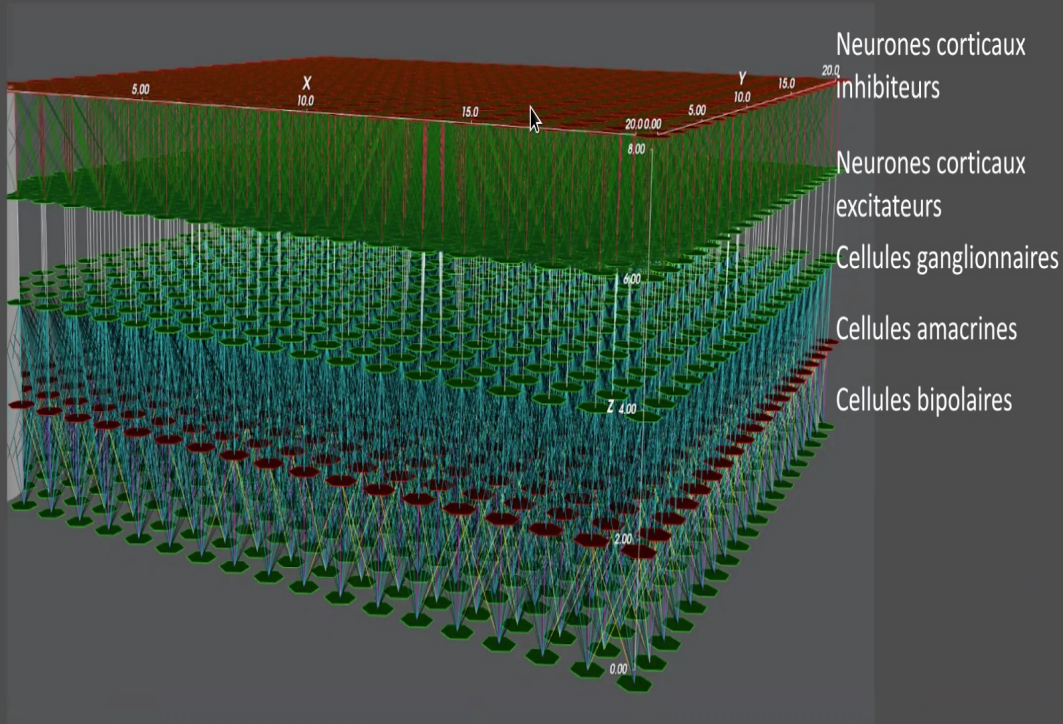

Figure 11: Comparing the spatio-temporal activity with the different drives. Left column figures display the spatio-temporal retinal activity with different anticipatory mechanisms, and the right column displays the corresponding spatio-temporal cortical activity. The red dashed lines denote the start and the end times of the LN retinal and cortical activities, as a reference base.

Logiciel Macular

Modèle rétinocortical de Macular



Simulation du modèle de Macular

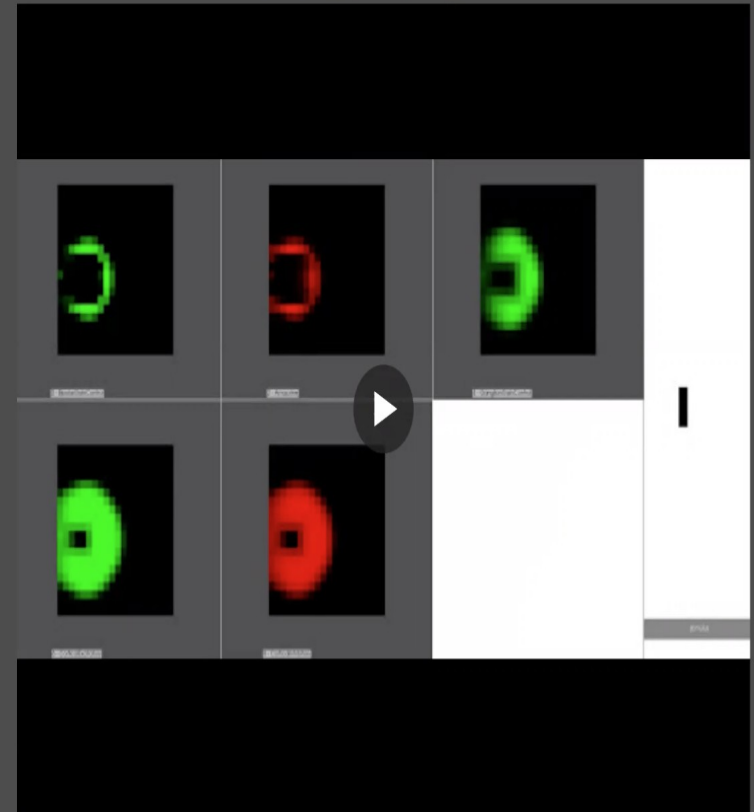

Perspectives

- A retino-cortical (V1) model of anticipation (with F. Chavane, S. Chemla, A. Destexhe, S. Souihel, M. Di Volo).
- Is our model able to anticipate more complex trajectories, with accelerations for instance ?
- How to better define connectivity using biology ?
- Would it be possible to design psycho-physical tests clearly showing the role of the retina in visual anticipation ?
- **How do a moving object + lateral connectivity shape the spatio-temporal correlations in ganglion cells spike trains emitted toward the brain ?**

Linear response for spiking neuronal networks with unbounded memory

R. Cofré, CIMFAV, Facultad de Ingenieria,
Universidad de Valparaiso, Valparaiso, Chile

Ignacio Ampuero, Departamento de Informatica,
Universidad Tecnica Federico Santa Maria,
Valparaiso, Chile

Spontaneous spiking activity

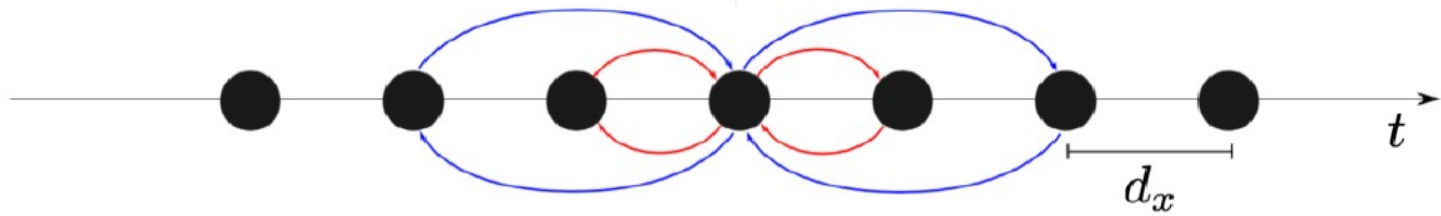

Spontaneous spiking activity

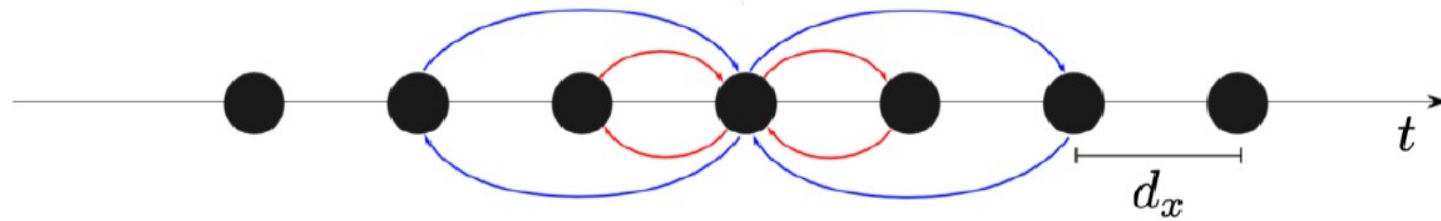

Spontaneous spiking activity

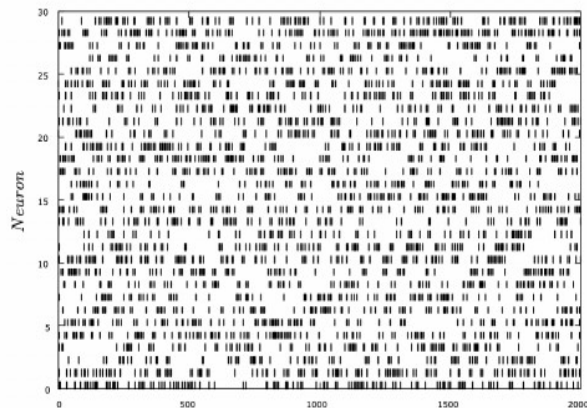
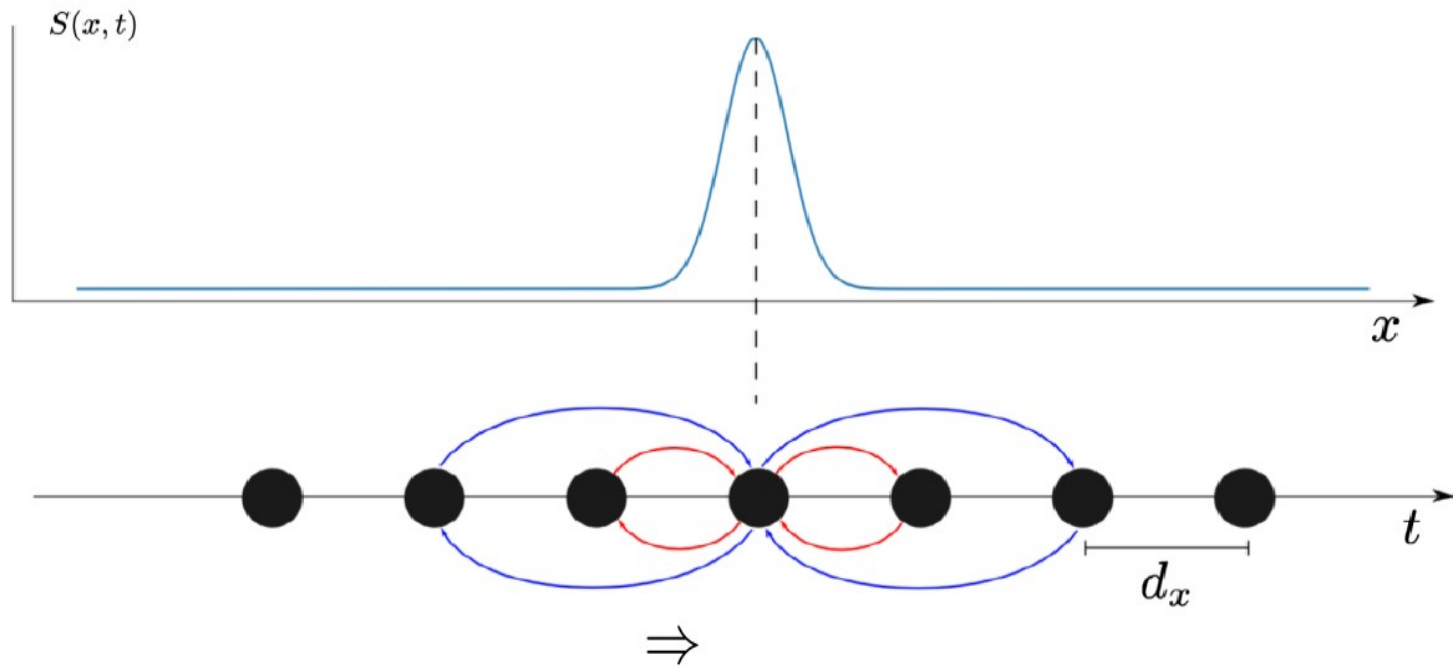

Spontaneous spiking activity

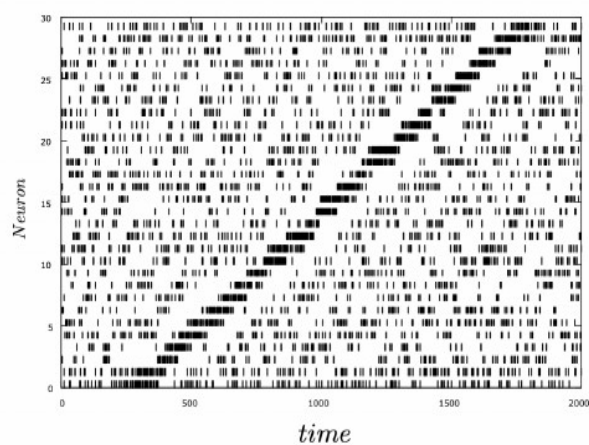
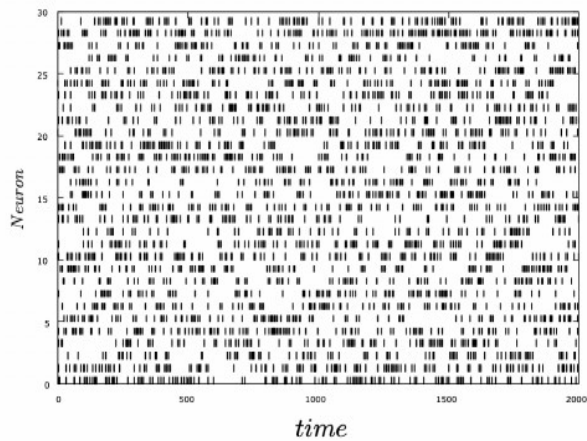
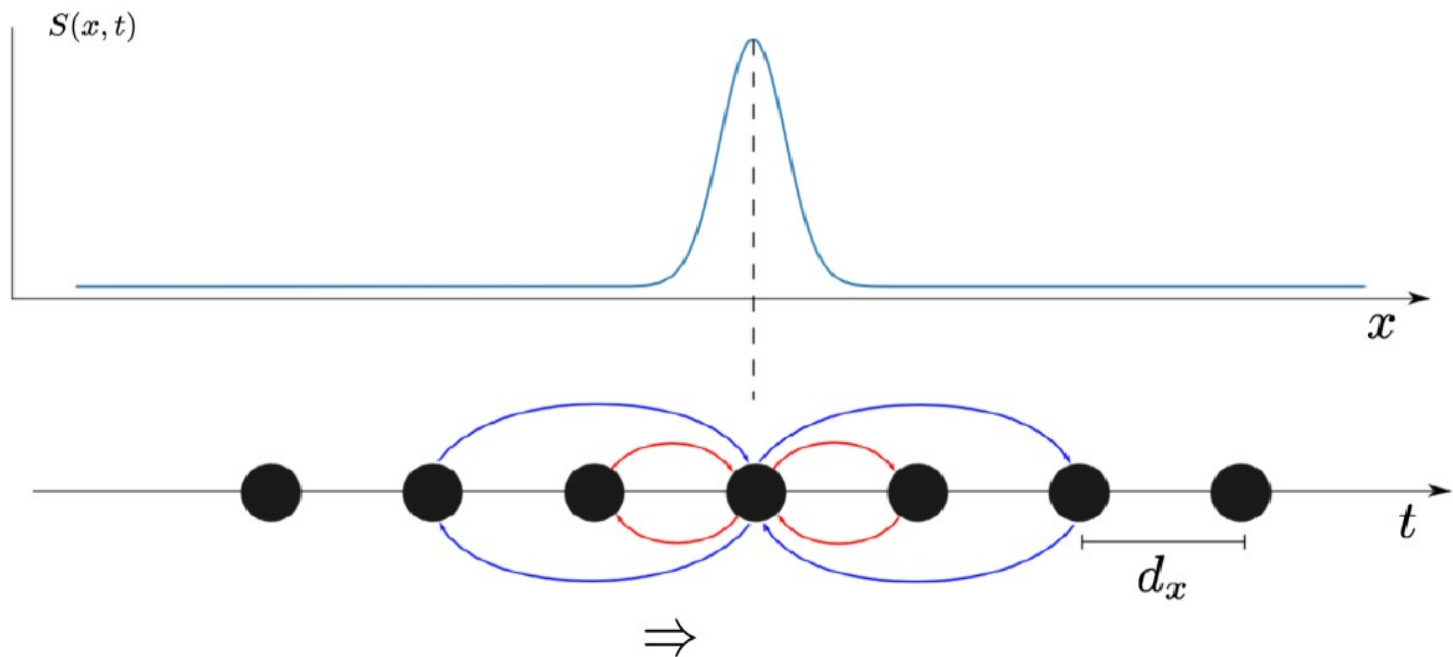

Spontaneous spiking activity

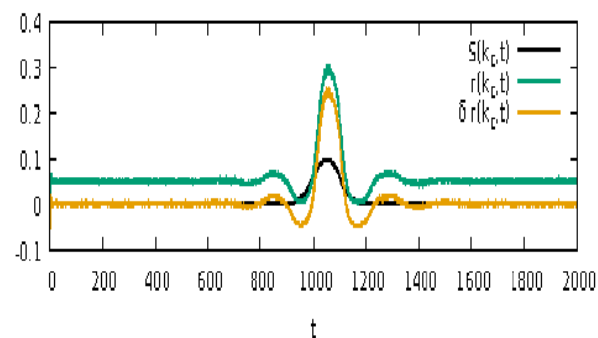
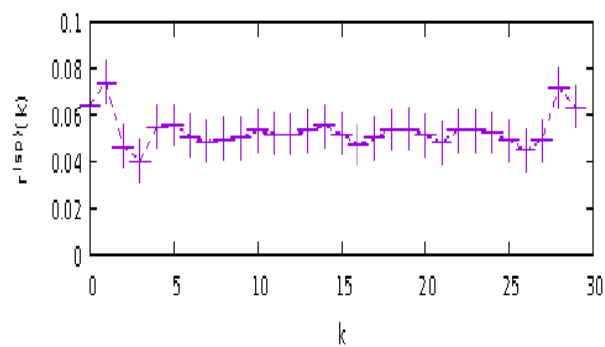
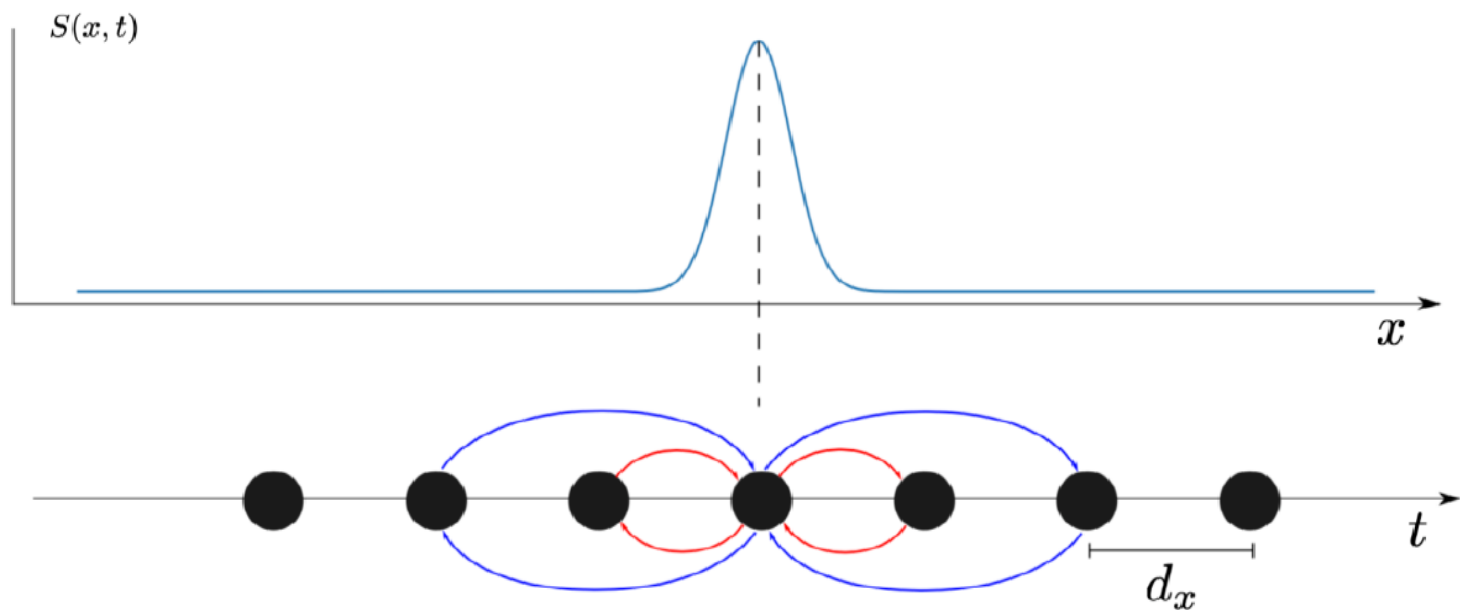

Sample averaging (non stationary)

Spontaneous spiking activity

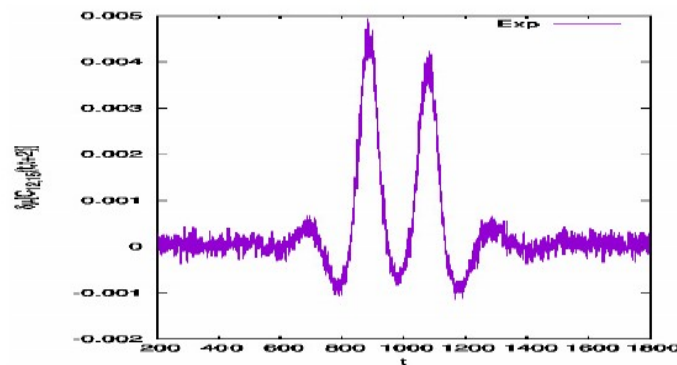
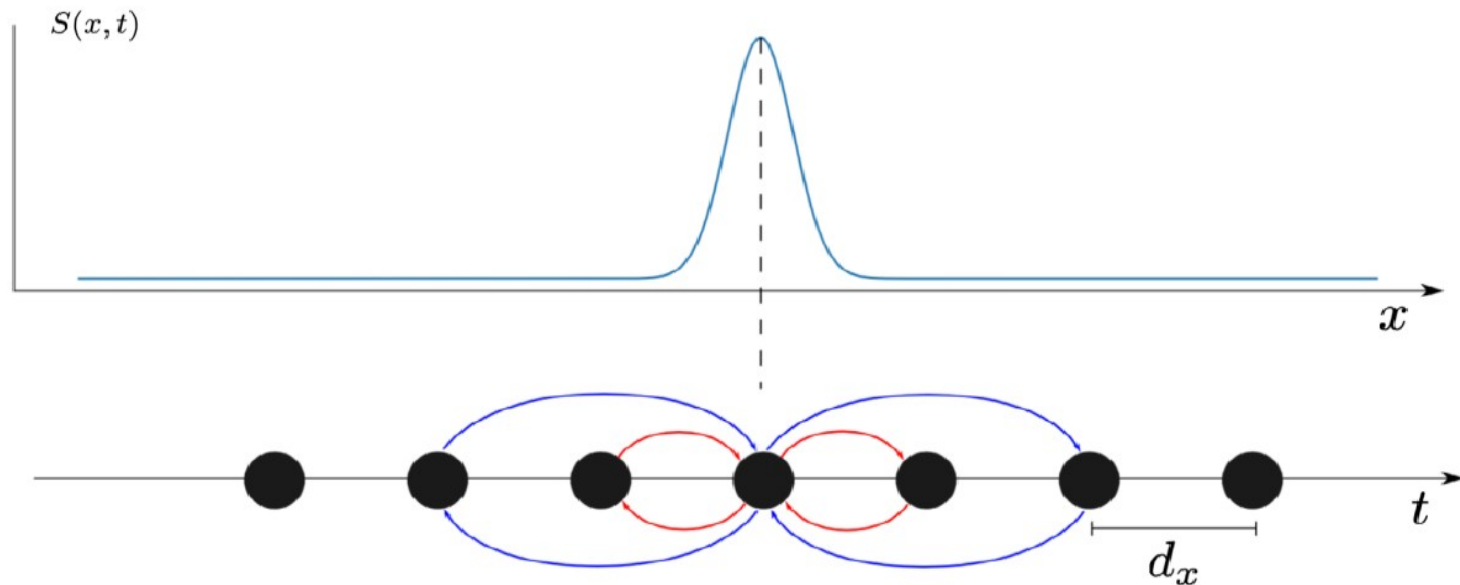

Variation in the correlation $C_{12,15}(t, t+2)$

Correlation variations are triggered by the stimulus, but they are constrained by the network dynamics.

How to compute the spatio-temporal response of a neuronal network to a time dependent stimulus ?

Can we compute the time variation of spike-observables as a function of the stimulus and spontaneous dynamics ?

B. Cessac, I. Ampuero, R. Cofre, Linear response for spiking neuronal networks with unbounded memory. Entropy, MDPI, 2021, 23 (2), pp.155.

A conductance-based Integrate and Fire model

Sub-threshold dynamics:

$$C_k \frac{dV_k}{dt} + g_k(t, \omega) V_k = i_k(t, \omega).$$

- Linear in V .
- Spike history-dependent.

Dynamics integration

$$\Gamma_k(t_1, t, \omega) = e^{-\frac{1}{C_k} \int_{t_1}^t V \tau_k(t, \omega)} g_k(u, \omega) du$$

$$V_k(t, \omega) = \underbrace{V_k^{(sp)}(t, \omega) + V_k^{(S)}(t, \omega)}_{V_k^{(det)}(t, \omega)} + V_k^{(noise)}(t, \omega)$$

$$V_k^{(sp)}(t, \omega) = V_k^{(syn)}(t, \omega) + V_k^{(L)}(t, \omega),$$

$$V_k^{(syn)}(t, \omega) = \frac{1}{C_k} \sum_{j=1}^N W_{kj} \int_{\tau_k(t, \omega)}^t \Gamma_k(t_1, t, \omega) \alpha_{kj}(t_1, \omega) dt_1$$

A conductance-based Integrate and Fire model

Variable length Markov chain with unbounded memory

$$P_n [\omega(n) \mid \omega_{-\infty}^{n-1}] \equiv \Pi \left(\omega(n), \frac{\theta - V_k^{(det)}(n-1, \omega)}{\sigma_k(n-1, \omega)} \right)$$

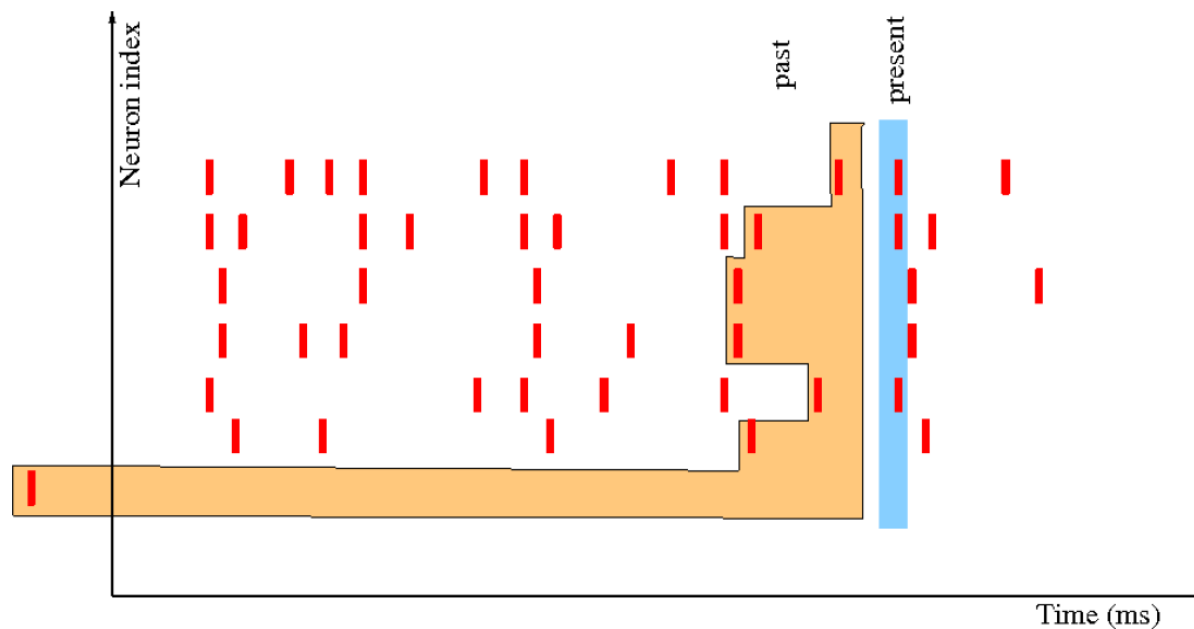

Response to stimuli

B. Cessac, I. Ampuero, R. Cofre, Linear response for spiking neuronal networks with unbounded memory. Entropy, MDPI, 2021, 23 (2), pp.155.

GIF model without stimulus \Rightarrow *stationary Gibbs distribution*.

time-dependent stimulus $S(t) \Rightarrow$ *non stationary Gibbs distribution*.

How is the average of an observable $f(\omega, t)$ affected by the stimulus ?

If S is weak enough: $\delta\mu[f(t)] = [\kappa_f * S](t)$, (linear response).

$$\kappa_{k,f}(t - t_1) = \frac{1}{C_k} \sum_{r=-\infty}^{n=[t]} C^{(sp)} \left[f(t, \cdot), \frac{\mathcal{H}_k^{(1)}(r, \cdot)}{\sigma_k(r-1, \cdot)} \int_{\tau_k(r-1, \cdot)}^{r-1} S_k(t_1) \Gamma_k(t_1, r-1, \cdot) dt_1 \right]$$

Firing rates

Computations have been done using the INRIA Pranas software, B. Cessac et al, *Frontiers in Neuroinformatics*, Vol 11, page 49, (2017).

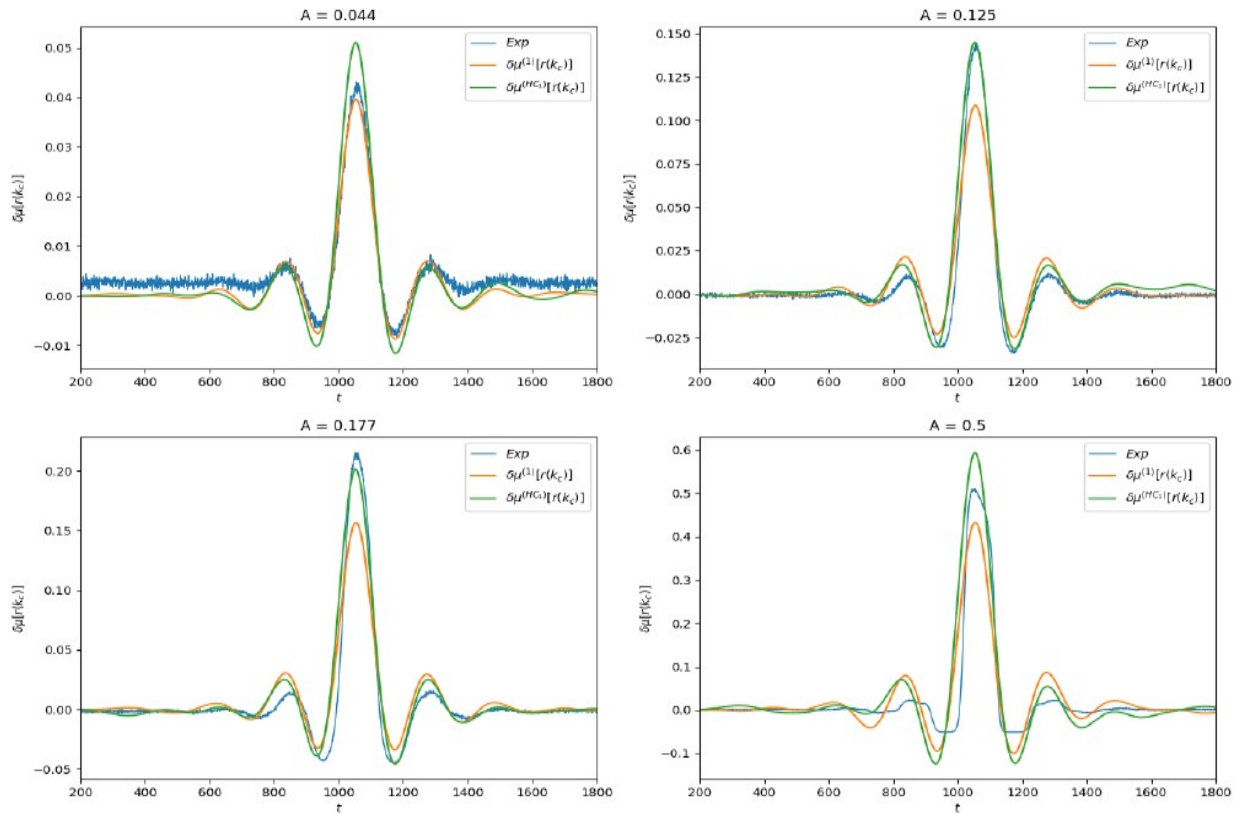

Figure: Linear response of $f(\omega, n) = \omega_{k_c}(n)$ for different values of stimulus amplitude A .

Higher order observable

Computations have been done using the INRIA Pranas software, B. Cessac et al, *Frontiers in Neuroinformatics*, Vol 11, page 49, (2017).

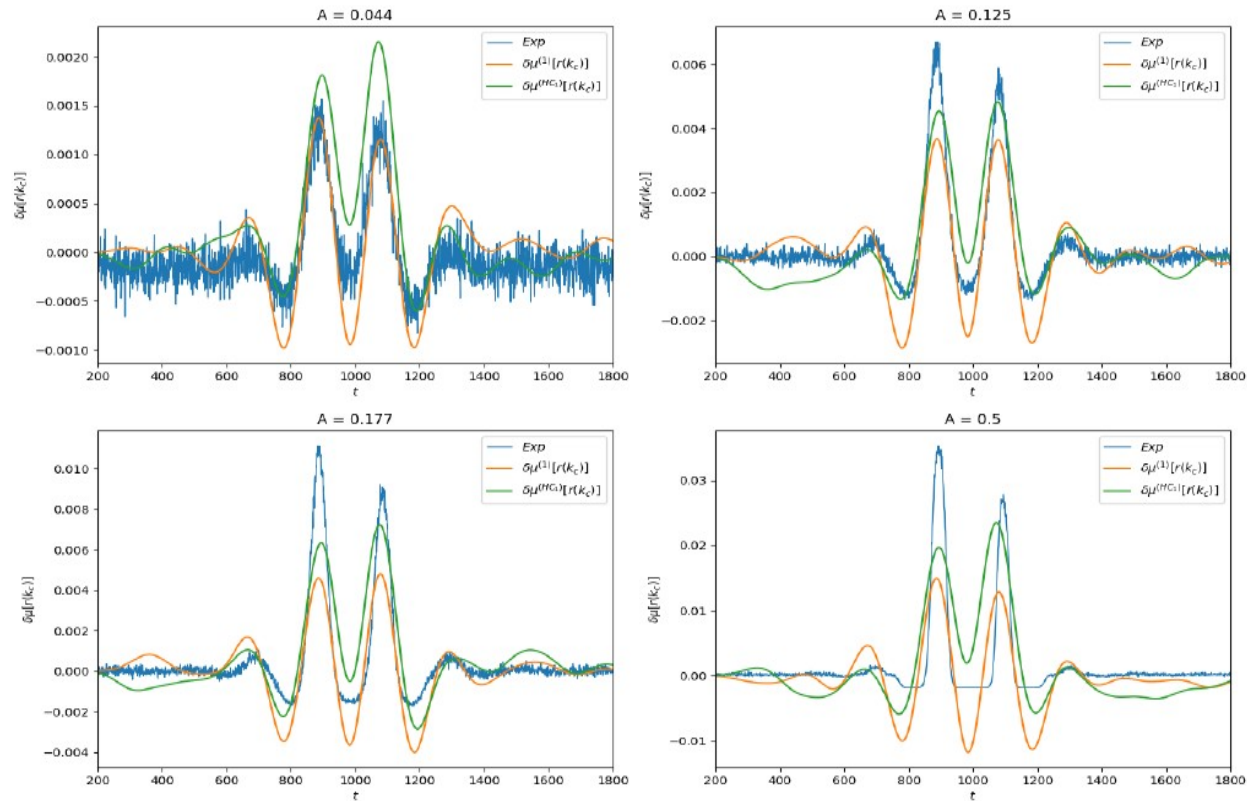

Figure: Linear response of the observable $f(n, \omega) = \omega_{k_c - 2}(n - 3)\omega_{k_c}(n)$.

Conclusions

- Visual entries are **neither stationary**, nor **spatially regular**.

Conclusions

- Visual entries are **neither stationary**, nor **spatially regular**.
- The « **longitudinal** » pathways PhotoReceptors => Bipolar cells => Ganglion cells efficiently encode the visual information into **parallel flows**.

Conclusions

- Visual entries are **neither stationary**, nor **spatially regular**.
- The « **longitudinal** » pathways PhotoReceptors => Bipolar cells => Ganglion cells efficiently encode the visual information into **parallel flows**.
- On the basis of biophysical modelling + mathematical analysis we found that Amacrine cells may generate, from a **moving stimulus**, **spatio-temporal correlations (waves)** contributing to better encoding a visual scene (e.g. **anticipation**).

Conclusions

- Visual entries are **neither stationary**, nor **spatially regular**.
- The « **longitudinal** » pathways PhotoReceptors => Bipolar cells => Ganglion cells efficiently encode the visual information into **parallel flows**.
- On the basis of biophysical modelling + mathematical analysis we found that Amacrine cells may generate, from a **moving stimulus**, **spatio-temporal correlations (waves)** contributing to better encoding a visual scene (e.g. **anticipation**).
- We also showed theoretically that an object moving in the receptive field of laterally connected Ganglion Cells may dramatically imprint **spike statistics**, not only firing rates, but also **higher order correlations**, living, in the **raster plots**, a trace that could be deciphered.

Conclusions

- Visual entries are **neither stationary**, nor **spatially regular**.
- The « **longitudinal** » pathways PhotoReceptors => Bipolar cells => Ganglion cells efficiently encode the visual information into **parallel flows**.
- On the basis of biophysical modelling + mathematical analysis we found that Amacrine cells may generate, from a **moving stimulus**, **spatio-temporal correlations (waves)** contributing to better encoding a visual scene (e.g. **anticipation**).
- We also showed theoretically that an object moving in the receptive field of laterally connected Ganglion Cells may dramatically imprint **spike statistics**, not only firing rates, but also **higher order correlations**, living, in the **raster plots**, a trace that could be deciphered.
- This leads to a paradigm very different from the « **efficient coding** » paradigm where longitudinal pathways are assumed to be independent. We switch from a paradigm of « rate » decoding to « **correlations** » **decoding**.

Conclusions

- Visual entries are **neither stationary**, nor **spatially regular**.
- The « **longitudinal** » pathways PhotoReceptors => Bipolar cells => Ganglion cells efficiently encode the visual information into **parallel flows**.
- On the basis of biophysical modelling + mathematical analysis we found that Amacrine cells may generate **tempo-temporal correlations (waves)** contributing to better encoding a visual scene (e.g. **anticipation**).
How could the visual cortex « decode » such signals ?
- We also show theoretically that an object moving in the receptive field of laterally connected Ganglion Cells dramatically imprints **spike statistics**, not only firing rates, but also **higher order correlations**, living, in the **raster plots**, a trace that could be deciphered.
- This leads to a paradigm very different from the « **efficient coding** » paradigm where longitudinal pathways are assumed to be independent. We switch from a paradigm of « rate » decoding to « **correlations** » decoding.

Thanks 😊