



**HAL**  
open science

# From Proof Nets to Combinatorial Proofs - A New Approach to Hilbert's 24th Problem

Willem Heijltjes, Lutz Strassburger

► **To cite this version:**

Willem Heijltjes, Lutz Strassburger. From Proof Nets to Combinatorial Proofs - A New Approach to Hilbert's 24th Problem. École thématique. From Proof Nets to Combinatorial Proofs - A New Approach to Hilbert's 24th Problem, Utrecht / Virtual, Netherlands. 2021. hal-03316571

**HAL Id: hal-03316571**

**<https://inria.hal.science/hal-03316571>**

Submitted on 6 Aug 2021

**HAL** is a multi-disciplinary open access archive for the deposit and dissemination of scientific research documents, whether they are published or not. The documents may come from teaching and research institutions in France or abroad, or from public or private research centers.

L'archive ouverte pluridisciplinaire **HAL**, est destinée au dépôt et à la diffusion de documents scientifiques de niveau recherche, publiés ou non, émanant des établissements d'enseignement et de recherche français ou étrangers, des laboratoires publics ou privés.

# From Proof Nets to Combinatorial Proofs

## A New Approach to Hilbert's 24th Problem

Willem Heijltjes and Lutz Straßburger

ESLLI 2021 – Zoom – August 2-6, 2021



1/21

These are the slides and notes for the course “From Proof Nets to Combinatorial Proofs — A New Approach to Hilbert's 24th Problem” given at ESLLI 2021. The summer school was planned to be held in Utrecht, but due to the Covid-19 crisis it is being held online via Zoom.

### Overview

1. The problem of proof identity
2. MLL: sequent proofs and proof nets
3. Cographs and handsome proof nets
4. Deep inference
5. ALL: sequent proofs, proof nets, and deep inference
6. Fibrations and skew fibrations
7. Classical propositional combinatorial proofs
8. First-order combinatorial proofs
9. Intuitionistic combinatorial proofs
10. Normalization

2/21

5 x 90 min  $\implies$  10 x 45 min

MLL = multiplicative linear logic  
ALL = additive linear logic

# From Proof Nets to Combinatorial Proofs

## A New Approach to Hilbert's 24th Problem



### 1. Lecture

## The Problem of Proof Identity



Willem Heijltjes and Lutz Straßburger

3/21

## What is Proof Theory?

- Group theory = theory of groups
  - well-established definition of group
  - two groups are the same if they are isomorphic
- Graph theory = theory of graphs
  - well-established definition of graph
  - two graphs are the same if they are isomorphic
- Proof theory = theory of (formal) proofs ???
  - no well-established definition of formal proof
  - no idea when two proofs are the same

4/21

## What is Proof Theory?



*At the current state of the art,  
Proof theory is not the theory of proofs but  
the theory of proof systems.*

All important results in proof theory are about proof systems:

- soundness
- completeness
- cut elimination
- focusing
- p-equivalence
- ⋮

Can we make  
proof theory a  
theory of proofs?



5/21

## Can we make proof theory a theory of proofs?

1. What is a proof?
  - ⇒ define proofs independently from the proof systems
2. When are two proofs the same?
  - ⇒ define a notion of proof identity

6/21

# Hilbert's 24th problem

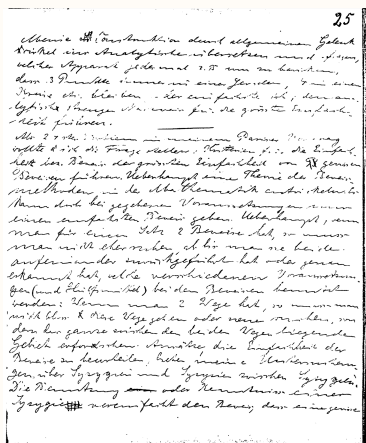

As 24th problem in my Paris lecture, I wanted to ask the question: Find criteria of simplicity or rather prove the greatest simplicity of given proofs. More generally develop a theory of proof methods in mathematics. Under given conditions there can be only one simplest proof. And if one has 2 proofs for a given theorem, then one must not rest before one has reduced one to the other or discovered which different premises (and auxiliary means) have been used in the proofs: When one has two routes then one must not just go these routes or find new routes, but the whole area lying between these two routes must be investigated...

Hilbert was thinking about adding the problem of proof identity as 24th problem to his famous lecture with the famous 23 problems that was held in 1900. But proof theory as a field was only established in 1928 with the appearance of the Book "Grundzüge der theoretischen Logik" by Hilbert and Ackermann. So, the problem of proof identity is older than proof theory itself.

Sources:

- picture of Hilbert: [https://de.wikisource.org/wiki/David\\_Hilbert?uselang=de#/media/Datei:Hilbert.jpg](https://de.wikisource.org/wiki/David_Hilbert?uselang=de#/media/Datei:Hilbert.jpg)
- Notebook of Hilbert: *David Hilbert, Mathematische Notizbücher, Niedersächsische Staats- und Universitätsbibliothek, Cod. Ms. D. Hilbert 600:3, S.25* (Scan from a hardcopy made by Rüdiger Thiele)
- Translation: Lutz Straßburger

See also:

- Rüdiger Thiele: "Hilbert's Twenty-Fourth Problem". *American Mathematical Monthly* 110, pp 1-24, 2003

# When are two proofs the same?



Normalization?

## Curry-Howard-Correspondence

- formulas = types
- proofs = programs
- normalization = computation

foundations of functional programming languages

Two proofs are the same iff they have the same normal form.

- propositional logic: exponential blow-up
- predicate logic: elementary blow-up
- Identify a proof on an A4-page with a proof of the size of the universe
- corresponds to removing lemmas from a proof. But lemmas are important in mathematical proofs.
- Example: Normalizing Fürstenberg's proof of the infinity of primes yields Euklid's proof

# When are two proofs (in normal form) the same?



Rule permutation?

$$\begin{array}{c} \wedge \\ \frac{\frac{\Gamma, A, B, C \quad \Gamma, D, \Delta}{\Gamma, A, B, C \wedge D, \Delta}}{\Gamma, A \vee B, C \wedge D, \Delta} \end{array} \stackrel{?}{=} \begin{array}{c} \vee \\ \frac{\frac{\Gamma, A, B, C \quad \Gamma, D, \Delta}{\Gamma, A \vee B, C \quad \Gamma, D, \Delta}}{\Gamma, A \vee B, C \wedge D, \Delta} \end{array} \quad (1)$$

$$\begin{array}{c} \wedge \\ \frac{\frac{\Gamma, C \quad \Gamma, D, \Delta}{\Gamma, C \wedge D, \Delta}}{\Gamma, A, C \wedge D, \Delta} \end{array} \stackrel{?}{=} \begin{array}{c} \text{weak} \\ \frac{\frac{\Gamma, C}{\Gamma, A, C} \quad \Gamma, D, \Delta}{\Gamma, A \vee B, C \wedge D, \Delta} \end{array} \quad (2)$$

$$\begin{array}{c} \wedge \\ \frac{\frac{\Gamma, A, B, C \quad \Gamma, A, B, D}{\Gamma, A, B, C \wedge D}}{\Gamma, A \vee B, C \wedge D} \end{array} \stackrel{?}{=} \begin{array}{c} \vee \\ \frac{\frac{\Gamma, A, B, C \quad \Gamma, A, B, D}{\Gamma, A \vee B, C} \quad \frac{\Gamma, A, B, D}{\Gamma, A \vee B, D}}{\Gamma, A \vee B, C \wedge D} \end{array} \quad (3)$$

Two proofs are the same iff they can be transformed into each other via a sequence of rule permutation steps.

- works only for sequent calculus like formalisms
- PSPACE-hard if (2) is present
- exponential blow-up of the size of the proof if (3) is present

# When are two proofs (in normal form) the same?



Rule permutation?

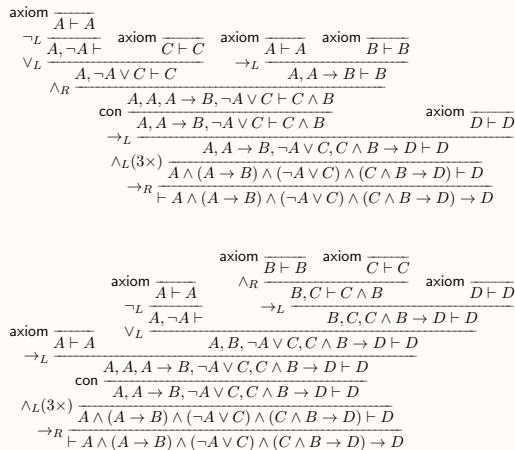

Example.

These two are equivalent modulo rule permutations.

# When are two proofs (in normal form) the same?



???

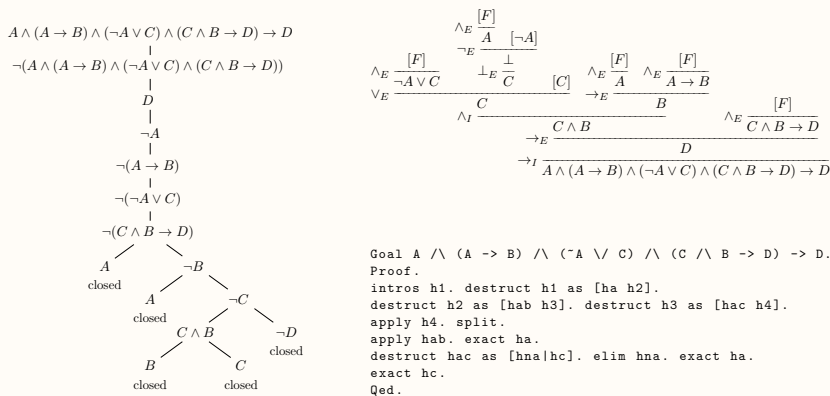

This is a semantic tableau, a natural deduction proof, and a Coq script, all proving the same formula.

Are these proofs “the same”?

# Combinatorial Proof Identity

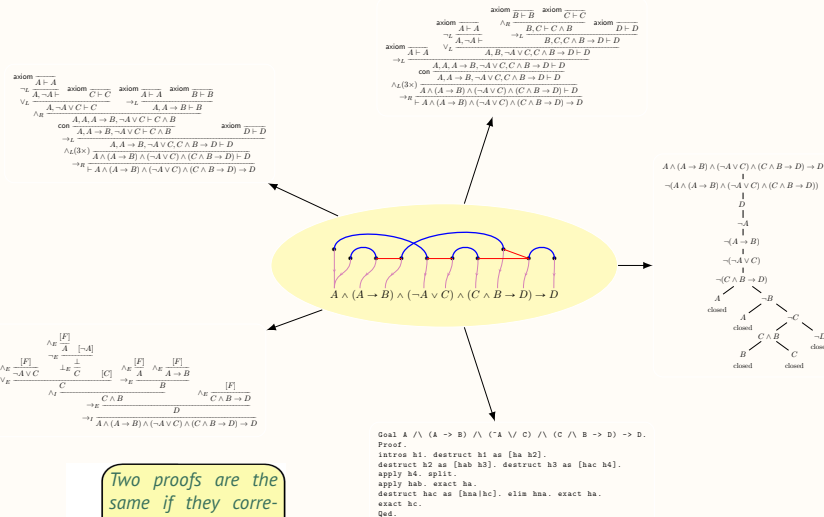

Two proofs are the same if they correspond to the same combinatorial proof.



- The term “combinatorial proof identity” does not yet occur in the literature. We invented it for this course.
- This course is about the stuff that goes into the yellow blob in the middle.
- The technical details about “the yellow blob in the middle” depend on the logic. In every logic behaves differently when it comes to the structure of its proofs. This means that the answer to the question of when two proofs are the same might be different for every logic. In this course we look into the following five logics:
  - classical propositional logic
  - classical first-order logic
  - intuitionistic propositional logic
  - multiplicative linear logic
  - additive linear logic

## Classical Propositional Logic (CPL)

• **Formulas:**  $A ::= a \mid \bar{a} \mid A \wedge B \mid A \vee B$

• **Negation:**  $\bar{\bar{a}} = a \quad \overline{A \wedge B} = \bar{A} \vee \bar{B} \quad \overline{A \vee B} = \bar{A} \wedge \bar{B}$

• **Implication:**  $A \supset B = \bar{A} \vee B$

• **Sequents:**  $\Gamma ::= A_1, A_2, \dots, A_k$

• **Inference rules (sequent calculus):**

$$\begin{array}{c} \text{ax} \frac{}{\vdash a, \bar{a}} \quad \vee \frac{\vdash \Gamma, A, B}{\vdash \Gamma, A \vee B} \quad \wedge \frac{\vdash \Gamma, A \quad \vdash \Delta, B}{\vdash \Gamma, \Delta, A \wedge B} \\ \text{cont} \frac{\vdash \Gamma, A, A}{\vdash \Gamma, A} \quad \text{weak} \frac{\vdash \Gamma}{\vdash \Gamma, A} \end{array}$$

13/21

- We are using formulas in *negation normal form* (NNF) because we need only half as many inference rules.
- We don't have the constants **truth** and **falsum** in the language to avoid unnecessary complications in later parts of the course. Note that in classical logic we can pick a fresh propositional variable  $a_0$  and define **truth** as  $a_0 \vee \bar{a}_0$  and **falsum** as  $a_0 \wedge \bar{a}_0$ .
- *Sequents* are multisets of formulas. The meaning is the disjunction of the formulas.
- In this course, we *always* consider the comma in the sequent notation to be associative and commutative.
- *Sequent derivations* are formally trees whose nodes are the instances of the inference rules, and whose edges are the sequents. (*Sequent proofs* are derivations where all leaves are axioms.)
- **Exercise 1.1:** Prove Pierce's law  $((a \supset b) \supset a) \supset a$  in this sequent calculus.

## First-Order Classical Logic (FOL) – Formulas

**Terms:**  $t ::= x \mid f(t_1, \dots, t_n)$

**Atoms:**  $a ::= p(t_1, \dots, t_m) \mid \bar{p}(t_1, \dots, t_m)$

**Formulas:**  $A ::= a \mid A \wedge A \mid A \vee A \mid \exists x.A \mid \forall x.A$

**Sequents:**  $\Gamma ::= A_1, A_2, \dots, A_k$

$$\begin{array}{c} \text{Negation:} \quad \bar{\bar{a}} = a \quad \overline{p(t_1, \dots, t_m)} = \bar{p}(t_1, \dots, t_m) \\ \quad \quad \quad \overline{\bar{p}(t_1, \dots, t_m)} = p(t_1, \dots, t_m) \\ \overline{A \wedge B} = \bar{A} \vee \bar{B} \quad \overline{\exists x.A} = \forall x.\bar{A} \\ \overline{A \vee B} = \bar{A} \wedge \bar{B} \quad \overline{\forall x.A} = \exists x.\bar{A} \end{array}$$

14/21

- As in the propositional case, we consider formulas in NNF.
- We do not discuss semantics in this course.

## First-Order Classical Logic (FOL) – Sequent Calculus

$$\begin{array}{c} \text{ax} \frac{}{\vdash a, \bar{a}} \quad \vee \frac{\vdash \Gamma, A, B}{\vdash \Gamma, A \vee B} \quad \wedge \frac{\vdash \Gamma, A \quad \vdash \Delta, B}{\vdash \Gamma, A \wedge B, \Delta} \\ \exists \frac{\vdash \Gamma, A[x/t]}{\vdash \Gamma, \exists x.A} \quad \forall \frac{\vdash \Gamma, A}{\vdash \Gamma, \forall x.A} \quad (x \text{ not free in } \Gamma) \\ \text{cont} \frac{\vdash \Gamma, A, A}{\vdash \Gamma, A} \quad \text{weak} \frac{\vdash \Gamma}{\vdash \Gamma, A} \end{array}$$

15/21

- We only need to add the rules for the quantifiers to the propositional system.
- We also do not discuss the cut rule

$$\text{cut} \frac{\vdash \Gamma, A \quad \vdash \Delta, \bar{A}}{\vdash \Gamma, \Delta}$$

All sequent systems we discuss in this course admit cut elimination.

- **Exercise 1.2:** Prove the drinker's formula  $\exists x.(px \supset \forall y.py)$  in the sequent calculus. ‘

## Additive vs. Multiplicative

	multiplicative	additive
disjunction	$\frac{\vdash \Gamma, A, B}{\vdash \Gamma, A \vee B}$ $\Downarrow$ $\wp \frac{\vdash \Gamma, A, B}{\vdash \Gamma, A \wp B}$	$\frac{\vdash \Gamma, A}{\vdash \Gamma, A \vee B} \quad \frac{\vdash \Gamma, B}{\vdash \Gamma, A \vee B}$ $\Downarrow$ $\oplus \frac{\vdash \Gamma, A}{\vdash \Gamma, A \oplus B} \quad \oplus \frac{\vdash \Gamma, B}{\vdash \Gamma, A \oplus B}$
conjunction	$\frac{\vdash \Gamma, A \quad \vdash \Delta, B}{\vdash \Gamma, \Delta, A \wedge B}$ $\Downarrow$ $\otimes \frac{\vdash \Gamma, A \quad \vdash \Delta, B}{\vdash \Gamma, \Delta, A \otimes B}$	$\frac{\vdash \Gamma, A \quad \vdash \Gamma, B}{\vdash \Gamma, A \wedge B}$ $\Downarrow$ $\& \frac{\vdash \Gamma, A \quad \vdash \Gamma, B}{\vdash \Gamma, A \& B}$

16/21

- When contraction and weakening are in the system, additive and multiplicative formulations of the and-rule (resp. or-rule) are equivalent. But when contraction and weakening are absent, they define different connectives.

• **Exercise 1.3:** Show that with contraction and weakening  $A \wp B$  and  $A \oplus B$  imply each other, and similarly for  $A \otimes B$  and  $A \& B$ . Which implications hold when only weakening is present, and which when only contraction is present?

• The terminology “additive/multiplicative” is due to Girard. Same for the choice of symbols.

- Jean-Yves Girard: **“Linear logic”**. *Theoret. Comput. Sci.* 50 (1), pp.1–102, 1987

## Multiplicative Linear Logic (MLL)

- Formulas:**  $A ::= a \mid a^\perp \mid A \otimes B \mid A \wp B$
- Negation:**  $a^{\perp\perp} = a$ ,  $(A \otimes B)^\perp = A^\perp \wp B^\perp$ ,  $(A \wp B)^\perp = A^\perp \otimes B^\perp$
- Implication:**  $A \multimap B = A^\perp \wp B$
- Sequents:**  $\Gamma ::= A_1, A_2, \dots, A_k$
- Inference rules (sequent calculus):**

$$\text{ax} \frac{}{\vdash a, a^\perp} \quad \wp \frac{\vdash \Gamma, A, B}{\vdash \Gamma, A \wp B} \quad \otimes \frac{\vdash \Gamma, A \quad \vdash \Delta, B}{\vdash \Gamma, \Delta, A \otimes B}$$

17/21

- Exercise 1.4:** Find a formula that is provable in classical logic but not in MLL. What about the other way around?

## Multiplicative Additive Linear Logic (MALL)

- Formulas:**  $A ::= a \mid a^\perp \mid A \otimes B \mid A \wp B \mid A \& B \mid A \oplus B$
- Negation:**  $a^{\perp\perp} = a$ ,  $(A \otimes B)^\perp = A^\perp \wp B^\perp$ ,  $(A \wp B)^\perp = A^\perp \otimes B^\perp$ ,  $(A \& B)^\perp = A^\perp \oplus B^\perp$ ,  $(A \oplus B)^\perp = A^\perp \& B^\perp$
- Implication:**  $A \multimap B = A^\perp \wp B$
- Sequents:**  $\Gamma ::= A_1, A_2, \dots, A_k$
- Inference rules (sequent calculus):**

$$\text{ax} \frac{}{\vdash a, a^\perp} \quad \wp \frac{\vdash \Gamma, A, B}{\vdash \Gamma, A \wp B} \quad \otimes \frac{\vdash \Gamma, A \quad \vdash \Delta, B}{\vdash \Gamma, \Delta, A \otimes B}$$

$$\& \frac{\vdash \Gamma, A \quad \vdash \Gamma, B}{\vdash \Gamma, A \& B} \quad \oplus \frac{\vdash \Gamma, A}{\vdash \Gamma, A \oplus B} \quad \oplus \frac{\vdash \Gamma, B}{\vdash \Gamma, A \oplus B}$$

18/21

## Additive Linear Logic (ALL)

- **Formulas:**  $A ::= a \mid a^\perp \mid A \& B \mid A \oplus B$
- **Negation:**  $a^{\perp\perp} = a \quad (A \& B)^\perp = A^\perp \oplus B^\perp, \quad (A \oplus B)^\perp = A^\perp \& B^\perp$
- **Sequents:**  $\Gamma ::= A_1, A_2, \dots, A_k$
- **Inference rules (sequent calculus):**

$$\text{ax} \frac{}{\vdash a, a^\perp}$$

$$\& \frac{\vdash \Gamma, A \quad \vdash \Gamma, B}{\vdash \Gamma, A \& B} \quad \oplus \frac{\vdash \Gamma, A}{\vdash \Gamma, A \oplus B} \quad \oplus \frac{\vdash \Gamma, B}{\vdash \Gamma, A \oplus B}$$

19/21

## Intuitionistic Propositional Logic (IPL)

- **Formulas:**  $A ::= a \mid A \wedge B \mid A \supset B$
- **Sequents:**  $A_1, A_2, \dots, A_k \vdash B$
- **Inference rules (sequent calculus):**

$$\text{ax} \frac{}{a \vdash a} \quad \text{cont} \frac{\Gamma, A, A \vdash B}{\Gamma, A \vdash B} \quad \text{weak} \frac{\Gamma \vdash B}{\Gamma, A \vdash B}$$

$$\wedge_L \frac{\Gamma, A, B \vdash C}{\Gamma, A \wedge B \vdash C} \quad \wedge_R \frac{\Gamma \vdash A \quad \Delta \vdash B}{\Gamma, \Delta \vdash A \wedge B}$$

$$\supset_L \frac{\Gamma \vdash A \quad B, \Delta \vdash C}{\Gamma, A \supset B, \Delta \vdash C} \quad \supset_R \frac{\Gamma, A \vdash B}{\Gamma \vdash A \supset B}$$

20/21

## Intuitionistic Multiplicative Linear Logic (IMLL)

- **Formulas:**  $A ::= a \mid A \otimes B \mid A \multimap B$
- **Sequents:**  $A_1, A_2, \dots, A_k \vdash B$
- **Inference rules (sequent calculus):**

$$\text{ax} \frac{}{a \vdash a}$$

$$\otimes_L \frac{\Gamma, A, B \vdash C}{\Gamma, A \otimes B \vdash C} \quad \otimes_R \frac{\Gamma \vdash A \quad \Delta \vdash B}{\Gamma, \Delta \vdash A \otimes B}$$

$$\multimap_L \frac{\Gamma \vdash A \quad B, \Delta \vdash C}{\Gamma, A \multimap B, \Delta \vdash C} \quad \multimap_R \frac{\Gamma, A \vdash B}{\Gamma \vdash A \multimap B}$$

21/21

- Observe that every provable sequent in ALL has exactly two formulas.
- **Exercise 1.5:** Find a two-formula sequent that is provable in classical logic but not in ALL. What about the other way around?
- **Exercise 1.6:** Find a two-formula sequent that is provable in MLL but not in ALL. What about the other way around?

- In this course we only consider the disjunction-free fragment of intuitionistic logic ( $\vee$  and  $\perp$  are absent).
- Note that implication is now a primitive.
- Negation can be recovered by fixing a fresh propositional variable  $a_0$  and define  $\neg A = A \supset a_0$ .
- We need two-sided sequents, and there is exactly one formula on the right.
- Each logical connective has a left-rule and a right-rule.
- **Exercise 1.7:** Can you prove Pierce's law  $((a \supset b) \supset a) \supset a$  in intuitionistic logic?

- Recall that in classical logic we can encode  $A \supset B$  as  $\bar{A} \vee B$ . So, every formula in IPL can be seen as a formula in CPL.
- In the same way we have in linear logic that  $A \multimap B$  is the same as  $A^\perp \wp B$ . Hence, every formula of IMLL is also a formula of MLL.
- **Exercise 1.8:** Find an IPL formula that is provable in CPL but not in IPL (or prove that such a formula does not exist).
- **Exercise 1.9:** Find an IMLL formula that is provable in MLL but not in IMLL (or prove that such a formula does not exist).





## 2. Lecture

# Multiplicative Linear Logic: Sequent proofs and Proof Nets



Willem Heijltjes and Lutz Straßburger

## The Curry–Howard Isomorphism

- Typed  $\lambda$ -terms are (isomorphic to) intuitionistic natural-deduction proofs

$$\frac{\begin{array}{c} [x : A]^x \\ \vdots \\ M : B \end{array}}{\lambda x. M : A \supset B} \supset I, x \quad \frac{M : A \supset B \quad N : A}{MN : B} \supset E$$

- This includes pairs/products/conjunction

$$\frac{M : A \quad N : B}{\langle M, N \rangle : A \wedge B} \wedge I \quad \frac{M : A \wedge B}{\pi_1(M) : A} \wedge E, 1 \quad \frac{M : A \wedge B}{\pi_2(M) : B} \wedge E, 2$$

The *Curry–Howard isomorphism* (or *correspondence* where it is less strong) connects proof theory and computation. It makes proof-theoretical constructions relevant to typed functional programming, where they may convey guarantees of termination, safety, or other good properties.

- **Exercise 2.1:** One case of the definition of (typed)  $\lambda$ -terms is missing: the *variable* case. What should it look like?
- **Exercise 2.2:** The isomorphism also includes *sums* (or *coproduct*, or *disjunction*). What are the term constructors and typing rules for it?

## Beta-reduction

- For implication:

$$\frac{\frac{\begin{array}{c} [x : A]^x \\ \vdots \\ M : B \end{array}}{\lambda x. M : A \supset B} \supset I, x \quad N : A}{(\lambda x. M) N : B} \supset E \quad \rightarrow \quad \frac{\begin{array}{c} \vdots \\ N : A \end{array}}{M[N/x] : B}$$

- For conjunction:

$$\frac{M : A \quad N : B}{\langle M, N \rangle : A \wedge B} \wedge I \rightarrow M : A \quad \frac{M : A \quad N : B}{\langle M, N \rangle : A \wedge B} \wedge I \rightarrow N : B$$

$$\frac{\langle M, N \rangle : A \wedge B}{\pi_1 \langle M, N \rangle : A} \wedge E, 1 \quad \frac{\langle M, N \rangle : A \wedge B}{\pi_2 \langle M, N \rangle : B} \wedge E, 2$$

- $(\supset/\wedge)$ -Intuitionistic natural deduction is ideal:
  - Reduction is *confluent* and *strongly normalizing*
  - *Normal forms* represent the *meaning* of a term

The correspondence relates *formulae* to *types*, *proofs* to *programs*, and here, *normalization* to *computation* ( $\beta$ -reduction).

- **Exercise 2.3:** Give also the reductions for disjunction.
- **Exercise 2.4:** The rules for disjunction give permutations, and do not give unique normal forms. Construct an example of this, or find one in the literature.

## Sequent calculus

$$\frac{}{x: A \vdash x: A}^{Ax} \quad \frac{\Gamma \vdash M: B}{\Gamma, x: A \vdash M: B}^W \quad \frac{\Gamma, x: A, y: A \vdash M: B}{\Gamma, x: A \vdash M[x/y]: B}^C$$

$$\frac{\Gamma, x: A \vdash M: B}{\Gamma \vdash \lambda x. M: A \supset B}^{\supset R} \quad \frac{\Gamma \vdash M: A \quad x: B, \Delta \vdash N: C}{\Gamma, f: A \supset B, \Delta \vdash N[f M/x]: C}^{\supset L}$$

$$\frac{\Gamma, x: A \vdash M: C}{\Gamma, y: A \wedge B \vdash M[\pi_1(y)/x]: C}^{\wedge L,1} \quad \frac{\Gamma, x: B \vdash M: C}{\Gamma, y: A \wedge B \vdash M[\pi_2(y)/x]: C}^{\wedge L,2}$$

$$\frac{\Gamma \vdash M: A \quad \Delta \vdash N: B}{\Gamma, \Delta \vdash \langle M, N \rangle: A \wedge B}^{\wedge R} \quad \frac{\Gamma \vdash M: A \quad x: A, \Delta \vdash N: B}{\Gamma, \Delta \vdash N[M/x]: B}^{Cut}$$

- Not an isomorphism between terms and proofs
- Builds terms in *normal form* (except the cut-rule)

4/24

- Sequent calculus is a *meta-calculus*: it describes the *construction* of natural-deduction proofs

$$\frac{\Gamma, x: A \vdash M: B}{\Gamma \vdash \lambda x. M: A \supset B}^{\supset R}$$

$$\begin{array}{c} [x: A] \\ \vdots \\ M: B \end{array} \mapsto \frac{\begin{array}{c} [x: A]^x \\ \vdots \\ M: B \end{array}}{\lambda x. M: A \supset B}^{\supset L, x}$$

5/24

$$\frac{\Gamma \vdash M: A \quad x: B, \Delta \vdash N: C}{\Gamma, f: A \supset B, \Delta \vdash N[f M/x]: C}^{\supset L}$$

$$\begin{array}{c} \vdots \\ M: A \end{array} + \begin{array}{c} [x: B] \\ \vdots \\ N: C \end{array} \mapsto \left[ \frac{f: A \supset B \quad \begin{array}{c} \vdots \\ M: A \end{array}}{f M: B} \supset E \right] \\ \vdots \\ N[f M/x]: C$$

- Note: this may duplicate or delete  $M$ .
- Possible *exponential* growth from sequent proof to  $\lambda$ -term

6/24

This is a standard annotation of sequent proofs with  $\lambda$ -terms. The implication and conjunctions are formulated with *multiplicative* contexts, and weakening and contraction are explicit.

- **Exercise 2.5:** Try to give an additive (context-sharing) formulation of intuitionistic sequent calculus. The annoying rule is the implication-left one ( $\supset L$ ). Test it by typing the Church numeral three,  $\lambda f. \lambda x. f(f(f x))$ . Conclude that the multiplicative formulation is nicer.

For the axiom and right-rules ( $Ax$ ,  $\supset R$ ,  $\wedge R$ ) terms and proofs are constructed correspondingly, as they are in natural deduction. But for the left-rules ( $\supset L$ ,  $\wedge L$ ), the structural rules ( $w$ ,  $c$ ), and the cut-rule, term construction and proof construction are dissimilar.

- **Exercise 2.6:** Prove that cut-free proofs construct  $\lambda$ -terms in normal form.

The sequent rule above expresses that a natural deduction proof of  $B$  with open assumptions  $A$ , as below left, can be transformed into one of  $A \supset B$  where the assumptions  $A$  are closed.

All sequent rules can be interpreted as constructing natural deduction proofs, in this way, and in fact Gentzen explicitly introduced sequent calculus from this perspective in his 1934/1935 papers.

Sequent-calculus right-rules build up a natural deduction proof at its conclusion, as  $\supset R$  on the previous slide. Left-rules build up a proof at its assumptions, as  $\supset L$  here.

- **Exercise 2.7:** Complete the demonstration of how sequent rules construct natural deduction proofs for the other rules. Include also disjunction if you have given these rules previously. This makes the translation from sequent calculus to natural deduction explicit (it was implicit already in the annotation with  $\lambda$ -terms).
- **Exercise 2.8:** Give also a reverse translation, from natural deduction to sequent calculus.

## Permutations

- The same  $\lambda$ -term can be constructed in multiple ways.
- This gives rise to *permutations* in sequent proofs.

$$\frac{\Gamma \vdash M : A \quad \frac{x : B, \Delta, y : C \vdash N : D}{x : B, \Delta \vdash \lambda y. N : C \supset D} \supset R}{\Gamma, f : A \supset B, \Delta \vdash \lambda y. N[f M/x] : C \supset D} \supset L \sim \frac{\Gamma \vdash M : A \quad x : B, \Delta \vdash N : D}{\Gamma, f : A \supset B, \Delta, y : C \vdash N[f M/x] : D} \supset L}{\Gamma, f : A \supset B, \Delta \vdash \lambda y. N[f M/x] : C \supset D} \supset R$$

$$\begin{array}{c} \vdots \\ M : A \end{array} + \begin{array}{c} [x : B] [y : C] \\ \vdots \\ N : D \end{array} \mapsto \left[ \frac{f : A \supset B \quad \begin{array}{c} \vdots \\ M : A \end{array}}{f M : B} \supset E \right] [y : C]^y \\ \frac{N[f M/x] : D}{\lambda y. N[f M/x] : C \supset D} \supset L, y$$

7/24

- **Exercise 2.9:** Show three more permutations.
- **Exercise 2.10:** Find a way to count, list, or organize all permutations without having to actually write them out fully.

## Intuitionistic logic summary

Natural deduction:

- Object-level calculus
- Isomorphic with simply-typed  $\lambda$ -calculus
- Does not need permutations (for  $\wedge$  and  $\supset$ )

Sequent calculus:

- Meta-level calculus
- Describes construction of natural-deduction proofs
- Needs permutations
- Direct characterization of normal forms as cut-free

*Natural deduction factors out the permutations of sequent calculus*

8/24

## Linear logic: the idea

In classical logic:

$$A \supset B = \bar{A} \vee B$$

But this breaks computational interpretations.

Enter linear logic:

$$A \supset B = ?\bar{A} \wp B$$

- $A \wp B$  is a *linear* disjunction
- $?A$  *non-linearizes*  $A$
- $\bar{A}$  is an *involution* (i.e. classical) negation

This is computational! (Or at least, not un-computational.)

9/24

The origins of linear logic are in its semantics of *coherence spaces*, which are an alternative by Girard to Scott's *domains* as a semantics of (untyped)  $\lambda$ -calculus. However, what makes linear logic convincing is its simple and natural sequent calculus, the intuitive idea of linearly-used resources, and its intriguing decomposition of intuitionistic implication.

With the *linear* implication  $\multimap$ , the encoding is

$$A \supset B = !A \multimap B$$

where  $!$  is the dual to  $?$ .

## Linear logic

$$\frac{}{\vdash A, \bar{A}}^{Ax} \quad \frac{\vdash \Gamma, A \quad \vdash \bar{A}, \Delta}{\vdash \Gamma, \Delta}^{Cut}$$

Multiplicatives:

$$\frac{\vdash \Gamma, A, B}{\vdash \Gamma, A \wp B}^{\wp} \quad \frac{\vdash \Gamma, A \quad \vdash B, \Delta}{\vdash \Gamma, A \otimes B, \Delta}^{\otimes}$$

Additives:

$$\frac{\vdash \Gamma, A}{\vdash \Gamma, A \oplus B}^{\oplus,1} \quad \frac{\vdash \Gamma, B}{\vdash \Gamma, A \oplus B}^{\oplus,2} \quad \frac{\vdash \Gamma, A \quad \vdash \Gamma, B}{\vdash \Gamma, A \& B}^{\&}$$

Exponentials:

$$\frac{\vdash ?\Gamma, A}{\vdash ?\Gamma, !A}^! \quad \frac{\vdash \Gamma, A}{\vdash \Gamma, ?A}^? \quad \frac{\vdash \Gamma}{\vdash \Gamma, ?A}^w \quad \frac{\vdash \Gamma, ?A, ?A}{\vdash \Gamma, ?A}^c$$

10/24

The connectives are called: *par*  $\wp$ , *tensor*  $\otimes$ , *plus*  $\oplus$ , *with*  $\&$ , *bang*  $!$ , and *why not*  $?$ .

The *modality*  $?$  governs whether formulas can be weakened and contracted or not. The rule  $!$  for the *bang* requires that the context  $?\Gamma = ?A_1, \dots, ?A_n$  contains only formulae that can be contracted. This is necessary for cut-elimination to work.

- **Exercise 2.11:** Investigate this by giving a cut-reduction step for:

$$\frac{\vdash ?\Gamma, !A \quad \frac{\vdash ?\bar{A}, ?\bar{A}, \Delta}{\vdash ?\bar{A}, \Delta}^c}{\vdash ?\Gamma, \Delta}^{Cut}$$

Is the  $?$  on the context  $?\Gamma$  necessary here?

## The dream of the 90s

New grounds in typed functional programming:

- Linearity gives *destructive updates* (i.e. mutable state)
- Multiplicatives  $\otimes$  and  $\wp$  give *deadlock-free concurrency*

But:

- The proof system is a *sequent calculus*!
- What about *natural deduction*?

11/24

Linear logic led to a great diversification of research in the areas around proof theory and computation in the 1990s, going into the 2000s and 2010s. Early new entrants were *game semantics*, *interaction nets*, and *geometry of interaction*.

From the start, the hope was that linear logic could give a proof-theoretic (and thus *typed*, and thus *safe*) account of various computational phenomena, such as destructive updates and concurrency. The programming language *Clean*, developed independently and simultaneously with linear logic, implements the former idea. Work towards the latter continues in the area of *session types*.

## Proof nets

Idea: remove the contexts  $\Gamma, \Delta$  from the rules.

$$\begin{aligned} \frac{}{\vdash A, \bar{A}}^{Ax} &\mapsto \frac{}{A \bar{A}} \\ \frac{\vdash \Gamma, A \quad \vdash B, \Delta}{\vdash \Gamma, A \otimes B, \Delta}^{\otimes} &\mapsto \frac{A \quad B}{A \otimes B} \\ \frac{\vdash \Gamma, A, B}{\vdash \Gamma, A \wp B}^{\wp} &\mapsto \frac{A \quad B}{A \wp B} \\ \frac{\vdash \Gamma, A \quad \vdash \bar{A}, \Delta}{\vdash \Gamma, \Delta}^{Cut} &\mapsto \frac{A \quad \bar{A}}{} \end{aligned}$$

- inferences become *nodes*, called *links*,
- in a *graph* called a *proof structure*

12/24

## Example

$$\begin{array}{c}
 \frac{\frac{\frac{\overline{\vdash a, \bar{a}}^{Ax}}{\vdash a, \bar{a} \otimes b, \bar{b} \otimes c, \bar{c}}{\otimes} \quad \frac{\frac{\overline{\vdash b, \bar{b}}^{Ax} \quad \overline{\vdash c, \bar{c}}^{Ax}}{\vdash b, \bar{b} \otimes c, \bar{c}}{\otimes}}{\vdash a, \bar{a} \otimes b, \bar{b} \otimes c, \bar{c}}{\otimes}}{\vdash a, \bar{a} \otimes b, \bar{b} \otimes c, \bar{c}}{\otimes}} \\
 \Downarrow \\
 \frac{\overline{a \quad \bar{a}} \quad \overline{b \quad \bar{b}} \quad \overline{c \quad \bar{c}}}{\overline{\bar{a} \otimes b} \quad \overline{\bar{b} \otimes c}} \\
 \Downarrow \\
 \frac{\frac{\overline{\vdash a, \bar{a}}^{Ax} \quad \overline{\vdash b, \bar{b}}^{Ax}}{\vdash a, \bar{a} \otimes b, \bar{b}}{\otimes} \quad \overline{\vdash c, \bar{c}}^{Ax}}{\vdash a, \bar{a} \otimes b, \bar{b} \otimes c, \bar{c}}{\otimes}}
 \end{array}$$

13/24

## Two perspectives

Graph-of-rules:

- Nodes/links represent inferences
- Natural deduction-like
- Focus: computation

$$\frac{\overline{a \quad \bar{a}} \quad \overline{b \quad \bar{b}} \quad \overline{c \quad \bar{c}}}{\overline{\bar{a} \otimes b} \quad \overline{\bar{b} \otimes c}}$$

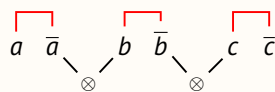

Sequent + axioms:

- Nodes represent connectives
- String diagram-like
- Focus: canonicity

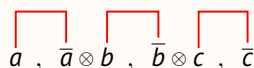

14/24

## Correctness

Which proof structures come from proofs?



All rules except  $\wp$  create *connected acyclic graphs*

$$\frac{\overline{\vdash A, \bar{A}}^{Ax}}{\vdash A, \bar{A}} \quad \frac{\overline{A \quad \bar{A}}}{A \quad \bar{A}} \quad \frac{\overline{A \quad \bar{A}}}{A \quad \bar{A}} \quad \frac{\overline{\vdash \Gamma, A} \quad \overline{\vdash \bar{A}, \Delta}}{\vdash \Gamma, \Delta}^{Cut}$$

$$\frac{\overline{\vdash \Gamma, A} \quad \overline{\vdash B, \Delta}}{\vdash \Gamma, A \otimes B, \Delta} \otimes \quad \frac{\overline{A \quad B}}{A \quad B} \quad \frac{\overline{A \quad B}}{A \quad B} \quad \frac{\overline{\vdash \Gamma, A, B}}{\vdash \Gamma, A \wp B} \wp$$

The premises of  $\wp$  must already be connected

15/24

## MLL proof nets

### Definition

A *proof net* is a sequent  $\Gamma$  with a correct linking, where:

- A *linking* on a sequent  $\Gamma$  is a partitioning of its atoms into dual, unordered pairs
- A *switching* of  $\Gamma$  is a choice of left/right for each  $\wp$
- A *switching graph* for a linking and a switching on  $\Gamma$  is the undirected graph where nodes are connectives and atoms of  $\Gamma$  and edges connect:
  - each  $\otimes$  to both children
  - each  $\wp$  to the child indicated by the switching
  - each pair of atoms in the linking
- A linking for  $\Gamma$  is *correct* if each switching graph is acyclic and connected

16/24

This is the *sequent + axioms* definition.

- **Exercise 2.12:** Give also the *graph-of-rules* definition.
- **Exercise 2.13:** Prove that the two definitions are isomorphic.

## Example

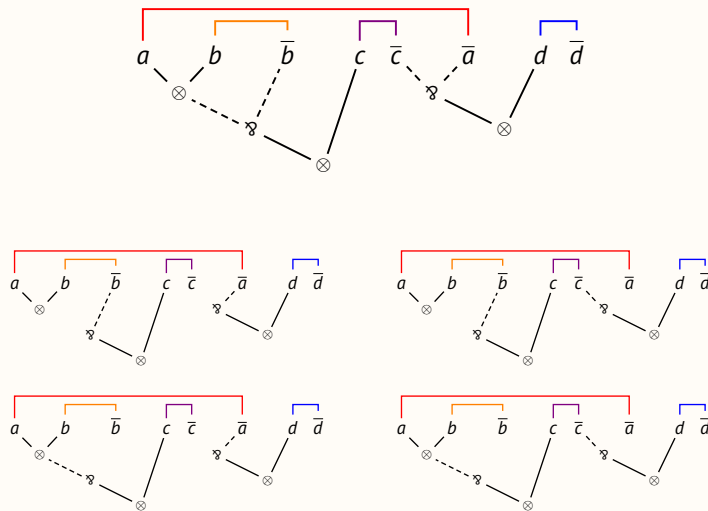

17/24

## Contractibility

1. Start from an unlabelled graph with paired  $\wp$ -edges
2. Contract by:

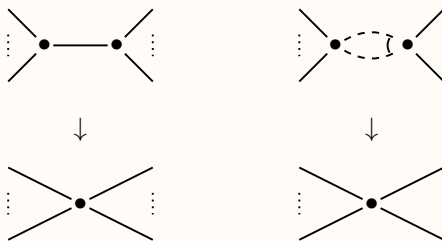

3. **Correct**  $\Leftrightarrow$  contracts to a single point

Implemented in **linear time** via **union-find**

18/24

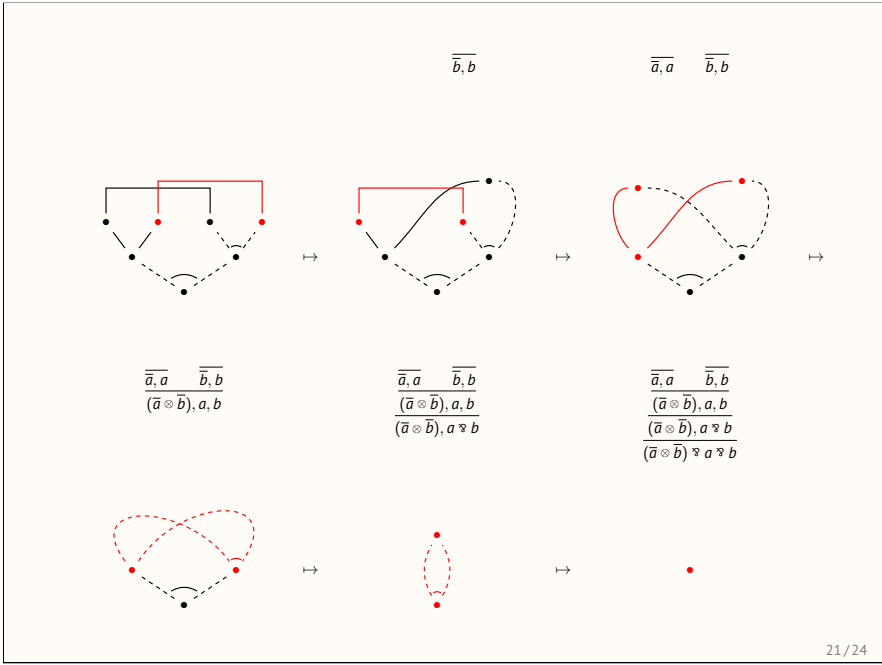
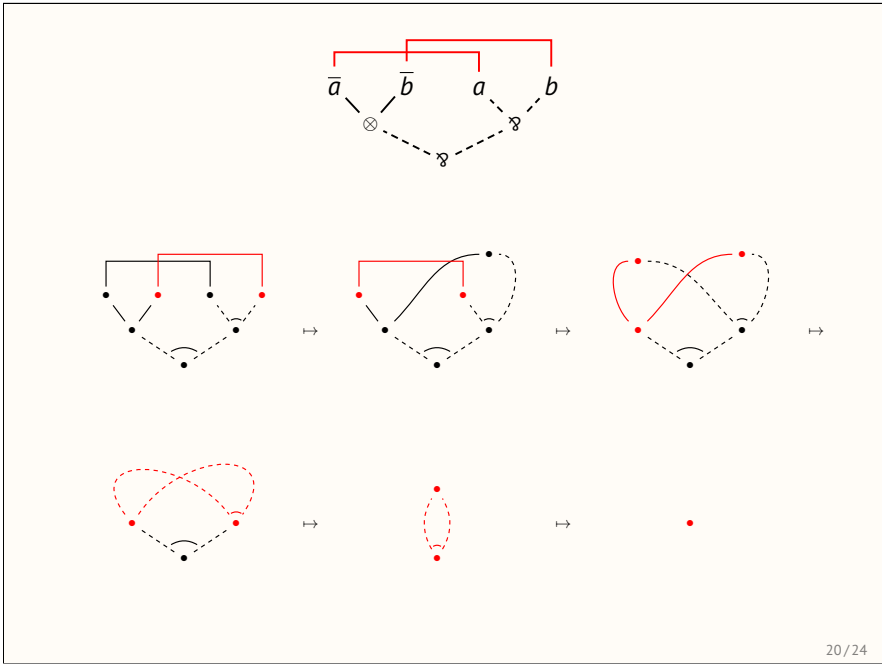

*Sequentialization:* proof nets  $\mapsto$  sequent proofs

*De-sequentialization:* sequent proofs  $\mapsto$  proof nets

**Theorem**

Sequentialization and de-sequentialization are inverses (up to permutations).

**Theorem**

A linking is correct if and only if it contracts, if and only if it sequentializes.

**Theorem**

Two sequent proofs are equivalent under permutations if and only if they translate to the same proof net.

The proofs of these theorems are a little tricky, but not infeasible. You can attempt them yourself.

## Bibliography

G. Gentzen, *Untersuchungen über das logische Schließen I, II*.  
Mathematische Zeitschrift 39, 1934, 1935

W. A. Howard, *The formulae-as-types notion of construction*. In: To  
H. B. Curry: Essays on Combinatory Logic, Lambda Calculus and  
Formalism, Eds. J. P. Seldin and J. R. Hindley, Academic Press, 1980

J.-Y. Girard, *Linear Logic*. Theoretical Computer Science 50(1), pp.  
1–102, 1987

V. Danos & L. Regnier, *The structure of multiplicatives*. Archive for  
Mathematical Logic 28(3), pp. 181–203, 1989

J.-Y. Girard, Y. Lafont & P. Taylor, *Proofs and Types*. Cambridge  
University Press, 1989

V. Danos, *La Logique Linéaire appliquée à l'étude de divers processus  
de normalisation (principalement du Lambda-calcul)*, PhD Thesis,  
Université Paris 7, 1990





### 3. Lecture

## Cographs and Handsome Proof Nets



Willem Heijltjes and Lutz Straßburger

### Graphs (directed and undirected)

- An *(undirected) graph* is a pair  $\mathcal{G} = \langle V_{\mathcal{G}}, E_{\mathcal{G}} \rangle$  of a (finite) set  $V_{\mathcal{G}}$  of *vertices* and a set  $E_{\mathcal{G}}$  of *edges* which are two-element subsets of  $V_{\mathcal{G}}$ .

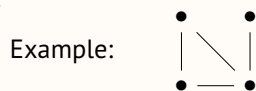

For  $x, y \in V_{\mathcal{G}}$ , we write  $xy \in E_{\mathcal{G}}$  for  $\{x, y\} \in E_{\mathcal{G}}$ .

- A *directed graph* is a pair  $\mathcal{G} = \langle V_{\mathcal{G}}, E_{\mathcal{G}} \rangle$  of a (finite) set  $V_{\mathcal{G}}$  of *vertices* and a set  $E_{\mathcal{G}} \subseteq V_{\mathcal{G}} \times V_{\mathcal{G}}$  of *edges* which are two-element subsets of  $V_{\mathcal{G}}$ .

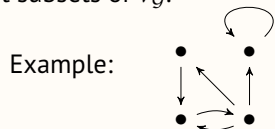

For  $x, y \in V_{\mathcal{G}}$ , we write  $x \rightarrow_{\mathcal{G}} y$  for  $(x, y) \in E_{\mathcal{G}}$ .

- In this course, all directed and undirected graphs are finite.
- When we say *graph*, we always mean *undirected graph*.
- When we want to speak about directed graphs, we say *directed graph*.
- Observe the notation:  $\{x, y\}$  is the same as  $\{y, x\}$ . But  $(x, y)$  is not the same as  $(y, x)$ .
- We often omit the index  $\mathcal{G}$ , when it is clear from context.

### Examples

undirected graph

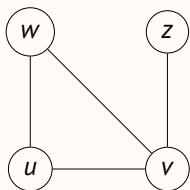

$$V = \{u, v, w, z\}$$

$$E = \{uw, uv, vw, zv\}$$

directed graph

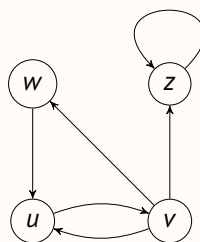

$$V = \{u, v, w, z\}$$

$$w \rightarrow u, u \rightarrow v, v \rightarrow u, v \rightarrow w, v \rightarrow z, z \rightarrow z$$

## Graph Homomorphisms and Isomorphisms

- A *graph homomorphism*  $h: \mathcal{G} \rightarrow \mathcal{H}$  is a map  $h: V_{\mathcal{G}} \rightarrow V_{\mathcal{H}}$  such that for all  $x, y \in V_{\mathcal{G}}$  we have that  $xy \in E_{\mathcal{G}}$  implies  $h(x)h(y) \in E_{\mathcal{H}}$ .
- A *graph isomorphism*  $h: \mathcal{G} \rightarrow \mathcal{H}$  is a bijection  $h: V_{\mathcal{G}} \rightarrow V_{\mathcal{H}}$  such that  $h$  and  $h^{-1}$  are both homomorphisms.
- A *directed graph homomorphism*  $h: \mathcal{G} \rightarrow \mathcal{H}$  is a map  $h: V_{\mathcal{G}} \rightarrow V_{\mathcal{H}}$  such that for all  $x, y \in V_{\mathcal{G}}$  we have that  $x \rightarrow_{\mathcal{G}} y$  implies  $h(x) \rightarrow_{\mathcal{H}} h(y)$ .
- A *directed graph isomorphism*  $h: \mathcal{G} \rightarrow \mathcal{H}$  is a bijection  $h: V_{\mathcal{G}} \rightarrow V_{\mathcal{H}}$  such that  $h$  and  $h^{-1}$  are both homomorphisms.

4/18

- *Homomorphisms* are structure preserving maps. In the case of graphs, they are maps that preserve the graph structure.
- An *isomorphism* makes the two structures “indistinguishable”.

## Paths and Cycles



- A *path*  $p$  in a graph  $\mathcal{G}$  is a sequence of vertices  $x_0, x_1, \dots, x_n \in V_{\mathcal{G}}$  such that  $x_0x_1, x_1x_2, \dots, x_{n-1}x_n \in E_{\mathcal{G}}$ . In this the *length* of  $p$  is  $n$ . The path is *elementary* if all  $x_0, \dots, x_n$  are pairwise distinct. A path is a *cycle* if  $x_0 = x_n$ . The cycle is *elementary* if all  $x_1, \dots, x_n$  are pairwise distinct (i.e., all vertices, except for  $x_0 = x_n$ ).
- Similarly for directed graphs.

5/18

- The length of the path is its number of edges.
- The shortest possible cycle is an undirected graph has length 3. In a directed graph, the shortest possible cycle has length 1.
- In the rest of the course, all paths and cycles are elementary, but we won't say it explicitly all the time.
- **Exercise 3.1:** Give the definition of (elementary) path and cycle in directed graphs.

## Subgraphs and Induced Subgraphs

- Let  $\mathcal{H} = \langle V_{\mathcal{H}}, E_{\mathcal{H}} \rangle$  and  $\mathcal{G} = \langle V_{\mathcal{G}}, E_{\mathcal{G}} \rangle$  be graphs. We say that  $\mathcal{H}$  is a *subgraph* of  $\mathcal{G}$  if  $V_{\mathcal{H}} \subseteq V_{\mathcal{G}}$  and  $E_{\mathcal{H}} \subseteq E_{\mathcal{G}}$ .
- We say that  $\mathcal{H}$  is an *induced subgraph* of  $\mathcal{G}$  if additionally
 
$$\forall u, v \in V_{\mathcal{H}}. uv \in E_{\mathcal{G}} \supset uv \in E_{\mathcal{H}}$$
- We say that  $\mathcal{G}$  *contains*  $\mathcal{H}$  as *induced subgraph* if there is an injective homomorphism  $f: \mathcal{H} \rightarrow \mathcal{G}$  such that  $f(\mathcal{H})$  is an induced subgraph of  $\mathcal{G}$ . If this is not the case, we say that  $\mathcal{G}$  is  *$\mathcal{H}$ -free*.

- Example:  is a subgraph of  (but not an induced subgraph).

6/18

- **Exercise 3.2:** Give the definition of subgraph and induced subgraph for directed graphs.
- For the moment, we only consider undirected graphs. Directed graphs return in Lectures 8,9, and 10.

- **Exercise 3.3:** We call  $\mathbf{P}_4$  the graph . Which of the following 9 graphs is  $\mathbf{P}_4$ -free?

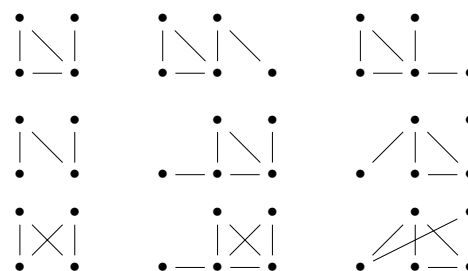

## Operations on Graphs

- **Complement:**

$$\bar{G} = \langle V_G, \{xy \mid x \neq y \text{ and } xy \notin E_G\} \rangle$$

- **Disjoint Union:**

$$G + H = \langle V_G \uplus V_H, E_G \uplus E_H \rangle$$

- **Join:**

$$G \times H = \langle V_G \uplus V_H, E_G \uplus E_H \uplus \{xy \mid x \in V_G \text{ and } y \in V_H\} \rangle$$

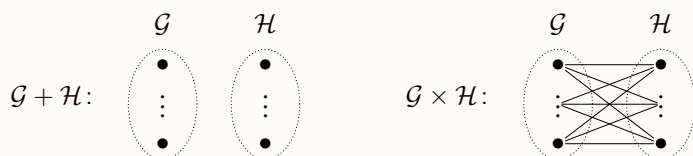

7/18

## Cographs

- A **cograph** is a graph that can be constructed from single vertex graphs using the operations  $+$  and  $\times$ .
- A **cotree** is the term tree constructing the cograph.

Example: cograph

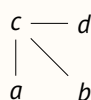

cotree

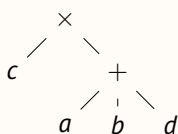

**Theorem:** A graph is a cograph if and only if it is  $P_4$ -free.

(where  $P_4$  is the graph  $\bullet - \bullet - \bullet - \bullet$ )

8/18

## Graphs of Formulas

Mapping  $[[\cdot]]$  from MLL formulas to (labelled) graphs:

$$[[a]] = \bullet a \quad (\text{single vertex labelled } a)$$

$$[[a^\perp]] = \bullet a^\perp \quad (\text{single vertex labelled } a^\perp)$$

$$[[A \wp B]] = [[A]] + [[B]]$$

$$[[A \otimes B]] = [[A]] \times [[B]]$$

Example:  $[[c \otimes ((a \wp b) \wp d)]] =$

Equivalence of formulas:

$$A \wp B \equiv B \wp A \quad (A \wp B) \wp C \equiv A \wp (B \wp C)$$

$$A \otimes B \equiv B \otimes A \quad (A \otimes B) \otimes C \equiv A \otimes (B \otimes C)$$

**Theorem:**  $[[A]] = [[B]]$  iff  $A \equiv B$

9/18

- **Exercise 3.4:** Show that

$$G \times H = \overline{\bar{G} + \bar{H}} \quad \text{and} \quad \bar{\bar{G}} = G$$

- The cographs is the smallest class of graph containing the the singletons, and being closed under complement and disjoint union.
- **Exercise 3.5:** Which of these graphs are cographs? Give the corresponding cotrees.

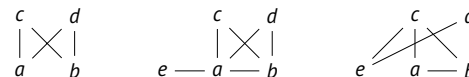
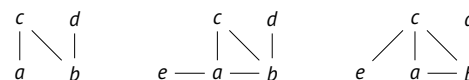
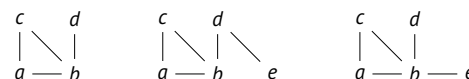

- **Exercise 3.6:** Draw the graphs of the following formulas:

- $(a \wp a^\perp) \otimes (b \wp b^\perp)$
- $(a \otimes b) \wp (a^\perp \otimes b^\perp)$
- $(a \wp (a^\perp \otimes (b \wp b^\perp)))$
- $(a \otimes a^\perp) \wp ((a \wp a^\perp) \otimes (a \wp a^\perp)) \wp (a \otimes a^\perp)$

- **Exercise 3.7:** Prove the theorem.

## Perfect Matchings

- A *matching*  $M$  in a graph  $\mathcal{G} = \langle V_{\mathcal{G}}, E_{\mathcal{G}} \rangle$  is subset  $M \subset E_{\mathcal{G}}$  of pairwise disjoint edges, i.e., no two edges in  $M$  are adjacent (share a common vertex).
- A matching  $M$  is *perfect* if for all  $v \in V_{\mathcal{G}}$  there is a  $w \in V_{\mathcal{G}}$  such that  $vw \in E_{\mathcal{G}}$  (i.e., every vertex is incident to a matching edge).

Example:

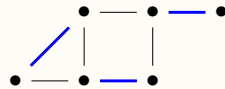

10/18

- **Attention:** In the textbook definition of matching (the one we give here), the matching is part of the graph, i.e., every matching edge is also an edge in the graph. But in this course, we often consider cases where the matching not part of a certain graph, i.e., formally, we have two graphs with the same vertex set: one is a graph with a certain property, very often a cograph, and the other is a perfect matching, i.e., a graph in which every edge participates in the matching.

## RB-graphs and RB-cographs

- An *RB-graph* is a triple  $\mathcal{G} = \langle V_{\mathcal{G}}, R_{\mathcal{G}}, B_{\mathcal{G}} \rangle$ , where  $\langle V_{\mathcal{G}}, R_{\mathcal{G}} \rangle$  is a graph and  $B_{\mathcal{G}}$  is a perfect matching in the graph  $\langle V_{\mathcal{G}}, B_{\mathcal{G}} \rangle$ .
- An *RB-cograph* is an RB-graph  $\mathcal{G} = \langle V_{\mathcal{G}}, R_{\mathcal{G}}, B_{\mathcal{G}} \rangle$ , where  $\langle V_{\mathcal{G}}, R_{\mathcal{G}} \rangle$  is a cograph.

Examples:



11/18

- An RB-graph can also be seen as a *multigraph*  $\mathcal{G} = \langle V_{\mathcal{G}}, R_{\mathcal{G}} \uplus B_{\mathcal{G}} \rangle$  (i.e., a graph which can have more than one edge between two vertices), in which  $B_{\mathcal{G}}$  is a perfect matching.
- Following the work of Christian Retoré, we draw the  $R$ -edges of RB-graphs in **red/regular** and the  $B$ -edges in **blue/bold**.
  - Christian Retoré: **“Handsome proof-nets: perfect matchings and cographs”**. *Theoretical Computer Science* 294 (2003) 473–488
  - Christian Retoré: **“Handsome proof-nets: R&B-graphs, perfect matchings and series-parallel graphs”**. *Rapport de Recherche RR-3652, INRIA*

## $\mathcal{A}$ -Paths and $\mathcal{A}$ -Cycles

- An *alternating elementary path* (or  *$\mathcal{A}$ -path*) in an RB-graph  $\mathcal{G} = \langle V_{\mathcal{G}}, R_{\mathcal{G}}, B_{\mathcal{G}} \rangle$  is an elementary path in  $\langle V_{\mathcal{G}}, R_{\mathcal{G}} \uplus B_{\mathcal{G}} \rangle$ , such that the edges of the path are alternating in  $R_{\mathcal{G}}$  and  $B_{\mathcal{G}}$ .
- An *alternating elementary cycle* (or  *$\mathcal{A}$ -cycle*) in an RB-graph  $\mathcal{G} = \langle V_{\mathcal{G}}, R_{\mathcal{G}}, B_{\mathcal{G}} \rangle$  is an elementary cycle in  $\langle V_{\mathcal{G}}, R_{\mathcal{G}} \uplus B_{\mathcal{G}} \rangle$ , such that the edges of the cycle are alternating in  $R_{\mathcal{G}}$  and  $B_{\mathcal{G}}$ .
- A *chord* in an  $\mathcal{A}$ -path  $v_0v_1, \dots, v_n$  (or in an  $\mathcal{A}$ -cycle  $v_0v_1, \dots, v_n$  with  $v_0 = v_n$ ) is an edge  $v_iv_j \in R_{\mathcal{G}}$  (with  $0 \leq i \neq j \leq n$ ) that is not part of the  $\mathcal{A}$ -path (or  $\mathcal{A}$ -cycle). An  $\mathcal{A}$ -path ( $\mathcal{A}$ -cycle) in an RB-graph is *chordless* if it has no chord.
- An RB-graph is  *$\mathcal{A}$ -connected* if any two vertices are connected by a chordless  $\mathcal{A}$ -path.
- An RB-graph is  *$\mathcal{A}$ -acyclic* if it has no chordless  $\mathcal{A}$ -cycle.

- These definitions come from Christian Retoré’s work.
- Observe that an  $\mathcal{A}$ -cycle always has even length.

12/18

## What does all this have to do with proof nets?

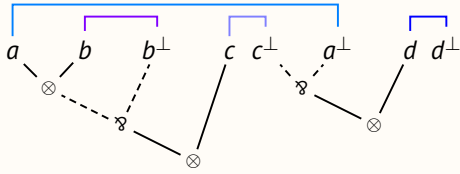

### Terminology:

- *prenet* = graph constructed from the sequent forest  $\Gamma$  and axiom edges  $\ell$ ; denoted as  $\pi(\Gamma, \ell)$
- *proof net* = a prenet that is correct, i.e., every switching is acyclic and connected

13/18

## Translating MLL-Prenets into RB-graphs (Method 1)

Let a sequent  $\Gamma$  and an axiom linking  $\ell$  be given.

1. Translate every formula  $A$  in  $\Gamma$  into an RB-tree  $\mathcal{T}_{RB}(A)$ :

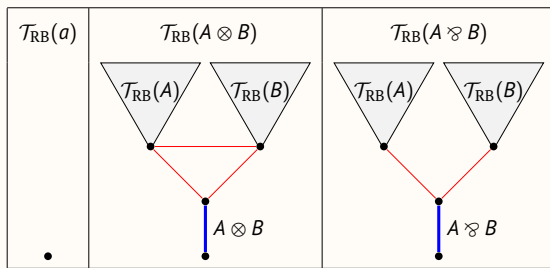

2. For each linking edge in  $\ell$  add a matching edge between the corresponding atoms

The result is an RB-cograph and called the (*tree-like*) *RB-prenet*  $\tau(\Gamma, \ell)$

14/18

## Example

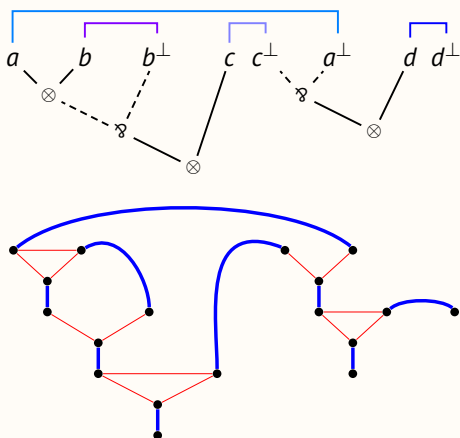

**Theorem:**  $\pi(\Gamma, \ell)$  is correct iff  $\tau(\Gamma, \ell)$  is  $\mathfrak{a}$ -acyclic and  $\mathfrak{a}$ -connected.  
In that case  $\tau(\Gamma, \ell)$  is called a (*tree-like*) *RB-proof net*.

15/18

- Recall: MLL-proof net is a formula tree with a linking on the atoms, such that a correctness criterion is obeyed
- Today we see two ways to translate an MLL-proof net into an RB-graph
- In both cases we obtain an RB-cograph
- In both cases we get the same correctness criterion:  
*An RB-cograph  $\mathcal{G}$  is the translation of a proof net if and only if it is  $\mathfrak{a}$ -connected and  $\mathfrak{a}$ -acyclic.*

- Graph theoretically,  $\mathcal{T}_{RB}(A)$  is not a tree, but it carries the structure of the formula tree.
- **Exercise 3.8:** Show that if  $\pi(\Gamma, \ell)$  is a MLL-prenet, then  $\tau(\Gamma, \ell)$  is indeed an RB-cograph.
- **Exercise 3.9:** Show that in  $\tau(\Gamma, \ell)$ , no  $\mathfrak{a}$ -path or  $\mathfrak{a}$ -cycle has a chord.

- Observe that in a tree-like RB-prenet, every  $\mathfrak{a}$ -path and every  $\mathfrak{a}$ -cycle is chordless. Therefore, checking for  $\mathfrak{a}$ -acyclicity amounts to checking that there is no  $\mathfrak{a}$ -cycle.
- **Exercise 3.10:** Prove the theorem. More precisely, show the following:
  1.  $\tau(\Gamma, \ell)$  is  $\mathfrak{a}$ -acyclic iff every switching of  $\pi(\Gamma, \ell)$  is acyclic.
  2.  $\tau(\Gamma, \ell)$  is  $\mathfrak{a}$ -connected iff every switching of  $\pi(\Gamma, \ell)$  is connected.

## Translating MLL-Prenets into RB-graphs (Method 2)

Let a sequent  $\Gamma = A_1, A_2, \dots, A_n$  and an axiom linking  $\ell$  be given.

1. Mapping  $\llbracket \cdot \rrbracket$  from MLL formulas to (labelled) graphs:

$$\llbracket a \rrbracket = \bullet a \quad (\text{single vertex labelled } a)$$

$$\llbracket a^\perp \rrbracket = \bullet a^\perp \quad (\text{single vertex labelled } a^\perp)$$

$$\llbracket A \wp B \rrbracket = \llbracket A \rrbracket + \llbracket B \rrbracket$$

$$\llbracket A \otimes B \rrbracket = \llbracket A \rrbracket \times \llbracket B \rrbracket$$

$$\text{Let } \llbracket \Gamma \rrbracket = \llbracket A_1 \rrbracket + \llbracket A_2 \rrbracket + \dots + \llbracket A_n \rrbracket$$

2. For each linking edge in  $\ell$  add a matching edge between the corresponding atoms

The result is an RB-cograph and called the *handsome RB-prenet*  $\rho(\Gamma, \ell)$

Every RB-cograph can be obtained in this way from a sequent  $\Gamma$  and an axiom linking  $\ell$ .

16/18

## Example

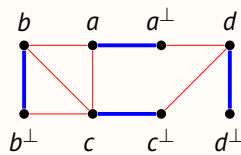
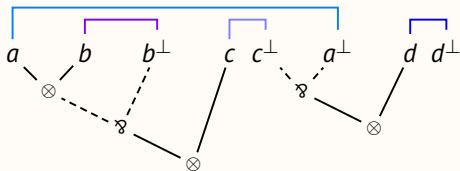

### Theorem:

$\pi(\Gamma, \ell)$  is correct iff  $\rho(\Gamma, \ell)$  is  $\mathfrak{a}$ -acyclic and  $\mathfrak{a}$ -connected.

In that case,  $\rho(\Gamma, \ell)$  is called a *handsome proof net*.

17/18

## Folding and Unfolding

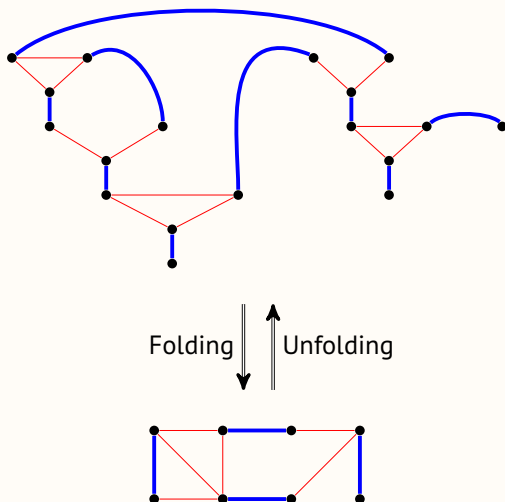

18/18

- **Exercise 3.11:** Show that if  $\pi(\Gamma, \ell)$  is a MLL-prenet, then  $\rho(\Gamma, \ell)$  is indeed an RB-cograph.
- **Exercise 3.12:** Prove the converse, i.e., prove that every RB-cograph can be labelled such that it is a handsome prenet  $\rho(\Gamma, \ell)$  for some sequent  $\Gamma$  and some linking  $\ell$ .

- Observe that in handsome RB-prenets,  $\mathfrak{a}$ -paths and  $\mathfrak{a}$ -cycles do have chords.
- **Exercise 3.13:** Convince yourself of the need of the “chordless” condition. For this, consider the following two sequents:

$$\vdash a \otimes b, (a^\perp \wp b^\perp) \otimes (c^\perp \wp d^\perp), c \otimes d$$

$$\vdash a \otimes b, (a^\perp \otimes c^\perp) \wp (b^\perp \otimes d^\perp), c \otimes d$$

Note that for both sequents there is a unique axiom linking. Try to prove both in the sequent calculus for MLL, and draw the handsome RB-prenet for both. Both contain an  $\mathfrak{a}$ -cycle, but in only one it is chordless.

- **Exercise 3.14:** (Difficult) Show the following:
  1.  $\rho(\Gamma, \ell)$  is  $\mathfrak{a}$ -acyclic iff  $\tau(\Gamma, \ell)$  is  $\mathfrak{a}$ -acyclic.
  2.  $\rho(\Gamma, \ell)$  is  $\mathfrak{a}$ -connected iff  $\tau(\Gamma, \ell)$  is  $\mathfrak{a}$ -connected.
- The term RB-proof net is used for both, the tree-like and the handsome proof nets.
- Retoré also uses the term *critically chorded* for a RB-cograph that is  $\mathfrak{a}$ -acyclic and  $\mathfrak{a}$ -connected. In other words, a handsome proof net is a critically chorded RB-cograph. And every RB-cograph is a handsome prenet.

- The folding and unfolding are performed by small steps that preserve chordless  $\mathfrak{a}$ -paths and chordless  $\mathfrak{a}$ -cycles. Details can be found here:
  - Christian Retoré: “**Handsomeness proof-nets: R&B-graphs, perfect matchings and series-parallel graphs**”. *Rapport de Recherche RR-3652, INRIA*



## 4. Lecture Deep Inference



Willem Heijltjes and Lutz Straßburger

### Deep inference

A method for structuring proofs

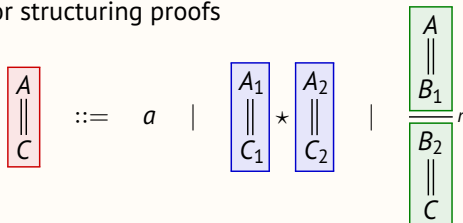

A *derivation* from  $A$  to  $C$ :

- Atom  $a$
- *Horizontal construction* with connective  $\star$
- *Vertical construction* with rule  $r$  from  $B_1$  to  $B_2$

A deep inference *proof system* is given by:

- A set of *connectives*
- A set of *rules*

### Classical logic

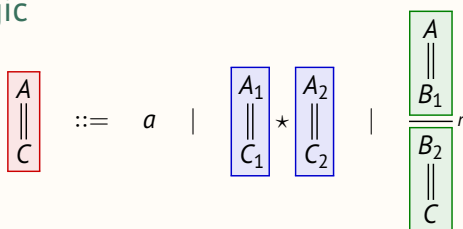

- **Connectives:**  $\wedge, \vee, \top, \perp$
- **Invertible rules:**

$$\frac{A \vee (B \vee C)}{(A \vee B) \vee C} \alpha \quad \frac{A \vee B}{B \vee A} \sigma \quad \frac{A}{\perp \vee A} \lambda \quad \frac{A \wedge (B \wedge C)}{(A \wedge B) \wedge C} \alpha \quad \frac{A \wedge B}{B \wedge A} \sigma \quad \frac{A}{\top \wedge A} \lambda$$

- **Non-invertible rules:**

$$\frac{\top}{A \vee \bar{A}} \top \quad \frac{(A \vee B) \wedge C}{A \vee (B \wedge C)} s \quad \frac{A \wedge \bar{A}}{\perp} \perp \quad \frac{\perp}{A} ? \quad \frac{A \vee A}{A} \vee \quad \frac{A}{A \wedge A} \wedge \quad \frac{A}{\top} !$$

## Example: Peirce's law

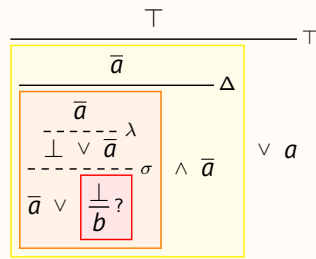

$$((\bar{a} \vee b) \wedge \bar{a}) \vee a$$

4/22

## Intuitionistic logic

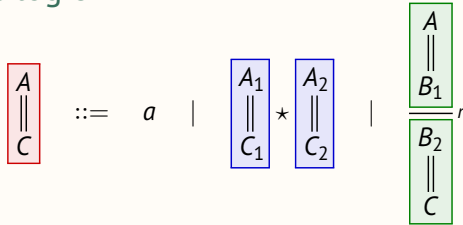

- Connectives:  $\supset, \wedge, \top$
- Invertible rules:

$$\frac{A \wedge (B \wedge C)}{(A \wedge B) \wedge C} \alpha \quad \frac{A \wedge B}{B \wedge A} \sigma \quad \frac{A}{\top \wedge A} \lambda$$

- Non-invertible rules:

$$\frac{B}{A \supset (B \wedge A)} \eta \quad \frac{(A \supset B) \wedge A}{B} \epsilon \quad \frac{A}{A \wedge A} \Delta \quad \frac{A}{\top} !$$

5/22

## Example: switch

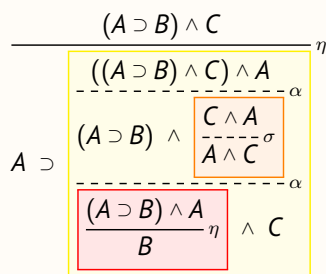

$$\frac{(A \supset B) \wedge C}{A \supset (B \wedge C)}$$

6/22



## Multiplicative Linear Logic

$$\boxed{\begin{array}{c} A \\ \parallel \\ C \end{array}} ::= a \mid \boxed{\begin{array}{c} A_1 \\ \parallel \\ C_1 \end{array}} \star \boxed{\begin{array}{c} A_2 \\ \parallel \\ C_2 \end{array}} \mid \frac{\boxed{\begin{array}{c} A \\ \parallel \\ B_1 \end{array}}}{\boxed{\begin{array}{c} B_2 \\ \parallel \\ C \end{array}}} r$$

- Connectives:  $\otimes, \wp, /, \perp$
- Invertible rules:

$$\frac{A \wp (B \wp C)}{(A \wp B) \wp C} \alpha \quad \frac{A \wp B}{B \wp A} \sigma \quad \frac{A}{\perp \wp A} \lambda \quad \frac{A \otimes (B \otimes C)}{(A \otimes B) \otimes C} \alpha \quad \frac{A \otimes B}{B \otimes A} \sigma \quad \frac{A}{/ \otimes A} \lambda$$

- Non-invertible rules:

$$\frac{/}{A \wp \bar{A}} / \quad \frac{(A \wp B) \otimes C}{A \wp (B \otimes C)} s \quad \frac{A \otimes \bar{A}}{\perp} \perp$$

7/22

## Example

$$\frac{\frac{\frac{(\bar{a} \wp \bar{b}) \otimes b}{(\bar{a} \wp \bar{b}) \otimes b} s \quad \bar{a} \wp \frac{\frac{\bar{b} \otimes b}{\perp} \perp}{\bar{a}} \wp \bar{c}}{((\bar{a} \wp \bar{b}) \otimes b) \wp \bar{c}} \otimes \frac{/}{d \wp \bar{d}} /}{((\bar{c} \wp \bar{a}) \otimes d) \wp \bar{d}} s$$

8/22

## From deep inference to proof nets

A derivation from  $A$  to  $B$  becomes a **two-sided proof net**:

$$\boxed{\begin{array}{c} A \\ \parallel \\ B \end{array}} \mapsto \begin{array}{c} A \\ \parallel \\ B \end{array}$$

- **Informally**: by tracing atoms through a derivation
- **Formally**: by defining horizontal and vertical construction on proof nets

9/22

## Tracing atoms

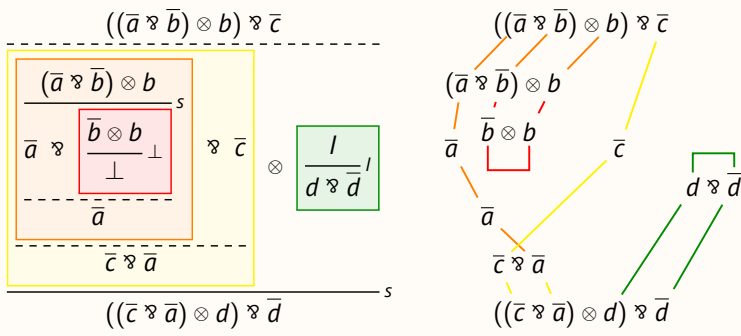

10/22

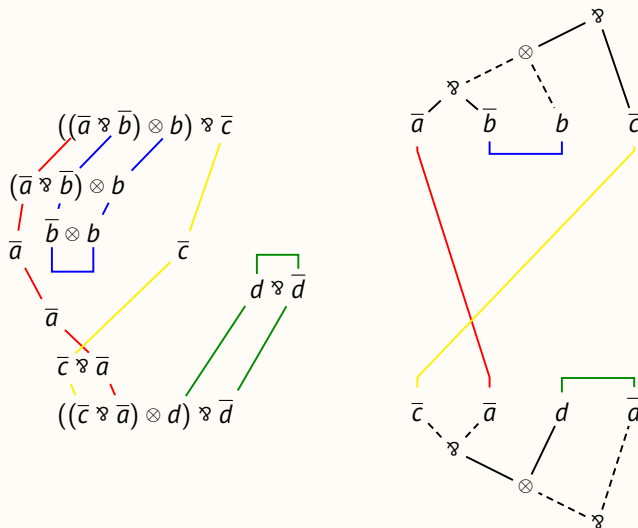

11/22

## Inductive translation

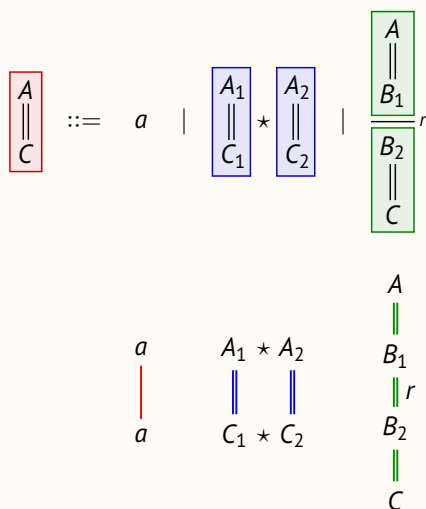

12/22

## Composition

- Composition is **path composition** across the common formula

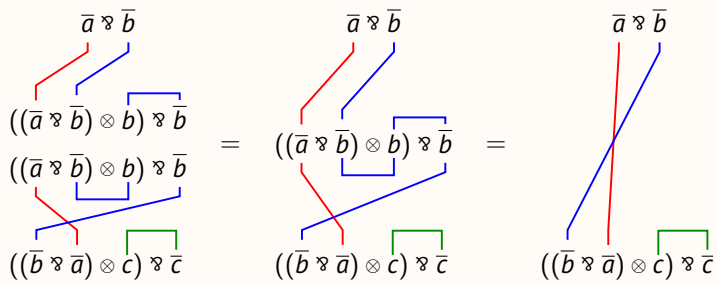

13/22

## Rules

$$\frac{I}{A \otimes \bar{A}} \quad \frac{(A \otimes B) \otimes C}{A \otimes (B \otimes C)}_s \quad \frac{A \otimes \bar{A}}{\perp}$$

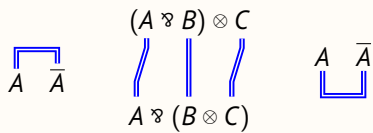

$$\frac{A \otimes (B \otimes C)}{(A \otimes B) \otimes C}_\alpha \quad \frac{A \otimes B}{B \otimes A}_\sigma \quad \frac{A}{\perp \otimes A}_\lambda \quad \frac{A \otimes (B \otimes C)}{(A \otimes B) \otimes C}_\alpha \quad \frac{A \otimes B}{B \otimes A}_\sigma \quad \frac{A}{I \otimes A}_\lambda$$

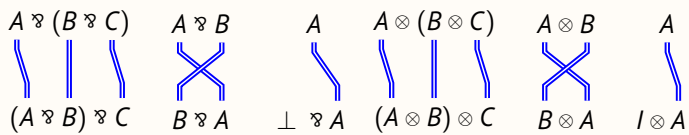

14/22

## Switch

$$\frac{(B \otimes C) \otimes D}{B \otimes (C \otimes D)}_s$$

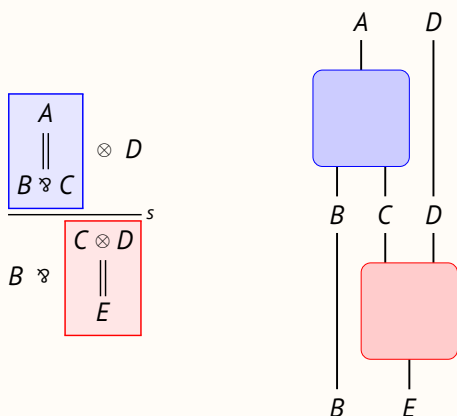

15/22

MLL is the logic of undirected, connected, acyclic networks.

- We can add the mix rule to allow disconnected networks

$$\frac{A \otimes B}{A \wp B}^{mix}$$

- We can drop the axiom and cut to get directed networks (this is called weakly or linearly distributive logic)
- We can add primitives (with inputs and outputs)

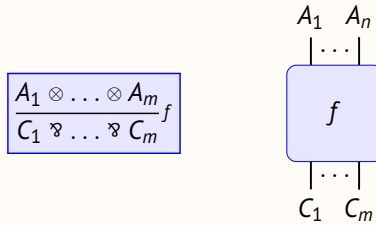

16/22

### From sequent calculus

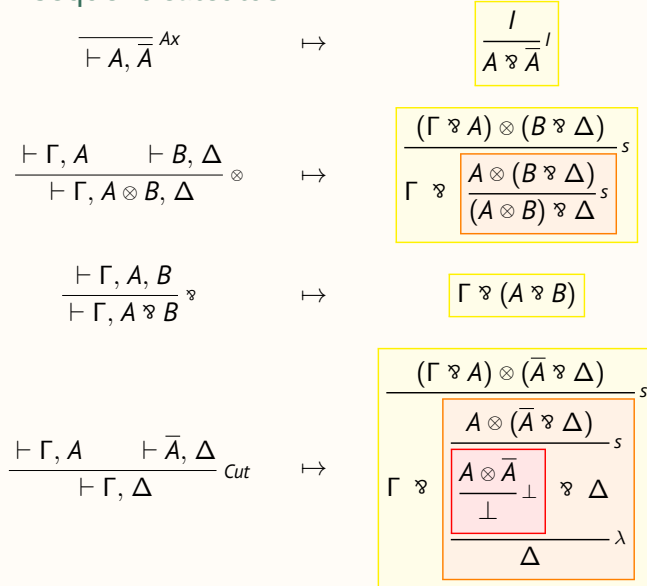

17/22

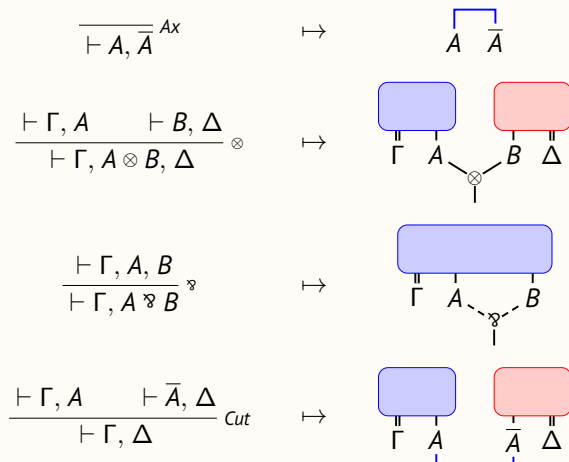

18/22

## Eta-expansion

$$\frac{}{\vdash \bar{A} \otimes \bar{B}, A \wp B}^{Ax} \quad \mapsto \quad \frac{\frac{}{\vdash \bar{A}, A}^{Ax} \quad \frac{}{\vdash \bar{B}, B}^{Ax}}{\vdash \bar{A} \otimes \bar{B}, A, B}^{\otimes}}{\vdash \bar{A} \otimes \bar{B}, A \wp B}^{\wp}$$

19/22

## Cut-elimination

$$\frac{\frac{\frac{\vdash \Gamma, \bar{A} \quad \vdash \Delta, \bar{B}}{\vdash \Gamma, \Delta, \bar{A} \otimes \bar{B}}^{\otimes} \quad \frac{\vdash \Theta, A, B}{\vdash \Theta, A \wp B}^{\wp}}{\vdash \Gamma, \Delta, \Theta}^{Cut}}{\vdash \Gamma, \bar{A} \quad \frac{\vdash \Delta, \bar{B} \quad \vdash \Theta, A, B}{\vdash \Delta, \Theta, A}^{Cut}}^{Cut} \quad \mapsto \quad \frac{\vdash \Gamma, \bar{A} \quad \frac{\vdash \Delta, \bar{B} \quad \vdash \Theta, A, B}{\vdash \Delta, \Theta, A}^{Cut}}{\vdash \Gamma, \Delta, \Theta}^{Cut}$$

20/22

## Big picture

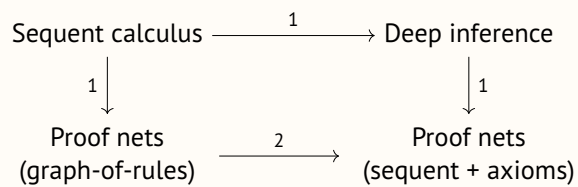

1. Translations
2. Cut-elimination and eta-expansion

21/22

## Bibliography

Guglielmi, *Deep Inference webpages*,  
<http://alessio.guglielmi.name/res/cos/>

Blute, Cockett, Seely & Trimble, *Natural deduction and coherence for weakly distributive categories*, *Journal of Pure and Applied Algebra* 113, pp. 229–296, 1996

Lamarche & Straßburger, *From Proof Nets to the Free \*-Autonomous Category*, *Logical Methods in Computer Science* 2(4:3), pp. 1–44, 2006

Brünnler & McKinley, *An Algorithmic Interpretation of a Deep Inference System*, LPAR 2008

Guglielmi, Gundersen & Parigot, *A proof calculus which reduces syntactic bureaucracy*, RTA 2010

Hughes, *Simple free star-autonomous categories and full coherence*, *Journal of Pure and Applied Algebra* 216(11), pp. 2386–2410, 2012



## 5. Lecture

# Proof Nets for Additive Linear Logic



Willem Heijltjes and Lutz Straßburger

1/23

## Additive linear logic

Formulae:

$$A, B, C ::= a \mid A \oplus B \mid A \& B$$

Sequents:

$$A \vdash C \quad \text{or} \quad \vdash \bar{A}, C$$

Sequent calculus:

$$\frac{}{A \vdash A} Ax \qquad \frac{A \vdash C \quad B \vdash C}{A \oplus B \vdash C} \oplus L \qquad \frac{A \vdash C_i}{A \vdash C_1 \oplus C_2} \oplus R$$

$$\frac{A \vdash B \quad B \vdash C}{A \vdash C} Cut \qquad \frac{A_i \vdash C}{A_1 \& A_2 \vdash C} \& L \qquad \frac{A \vdash B \quad A \vdash C}{A \vdash B \& C} \& R$$

2/23

## Sum and product

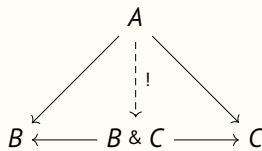

$$\frac{B \vdash D}{B \& C \vdash D} \& L \qquad \frac{C \vdash D}{B \& C \vdash D} \& L$$

$$\frac{A \vdash B \quad A \vdash C}{A \vdash B \& C} \& R$$

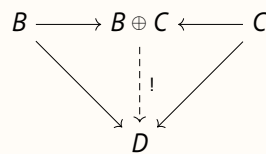

$$\frac{B \vdash D \quad C \vdash D}{B \oplus C \vdash D} \oplus L$$

$$\frac{A \vdash B}{A \vdash B \oplus C} \oplus R \qquad \frac{A \vdash C}{A \vdash B \oplus C} \oplus R$$

3/23

### Proof nets: graph-of-rules

$$\frac{\frac{\overline{\vdash \bar{A}, A}^{Ax}}{\vdash \bar{A}, A+B}^{+R,1} \quad \frac{\overline{\vdash \bar{A}, A}^{Ax}}{\vdash \bar{A}, A+B}^{+R,1}}{\vdash \bar{A} \times \bar{A}, A+B}^{\times R} \quad \sim \quad \frac{\frac{\overline{\vdash \bar{A}, A}^{Ax}}{\vdash \bar{A} \times \bar{A}, A}^{\times R} \quad \frac{\overline{\vdash \bar{A}, A}^{Ax}}{\vdash \bar{A}, A}^{+R,1}}{\vdash \bar{A} \times \bar{A}, A+B}^{+R,1}}$$

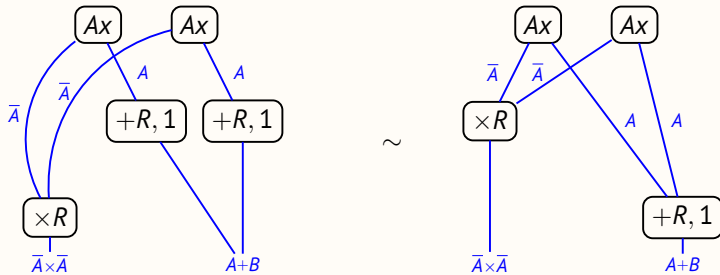

### Proof nets: (two-sided) sequent + axioms

$$\frac{\frac{\overline{A \vdash A}^{Ax}}{A \vdash A+B}^{+R,1} \quad \frac{\overline{A \vdash A}^{Ax}}{A \vdash A+B}^{+R,1}}{A+A \vdash A+B}^{\times R} \quad \sim \quad \frac{\frac{\overline{A \vdash A}^{Ax}}{A+A \vdash A}^{\times R} \quad \frac{\overline{A \vdash A}^{Ax}}{A \vdash A}^{+R,1}}{A+A \vdash A+B}^{+R,1}}$$

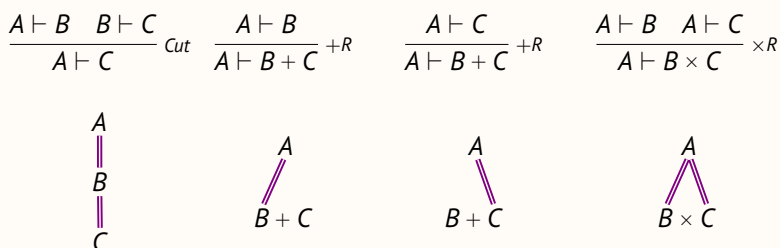
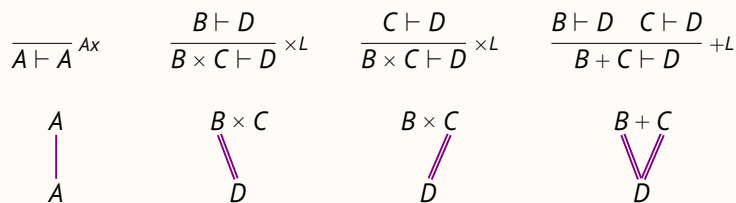



## Eta-expansion

$$\frac{}{A + B \vdash A + B}^{Ax} \mapsto \frac{\frac{}{A \vdash A}^{Ax} \quad \frac{}{B \vdash B}^{Ax}}{A \vdash A + B}^{+R,1} \quad \frac{}{B \vdash A + B}^{+R,2}}{A + B \vdash A + B}^{+L}$$

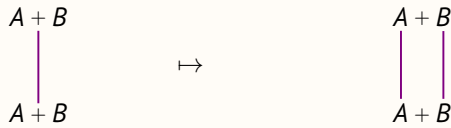

- Links may be restricted to atoms

7/23

## Composition

- Composition is *relational composition*
- Requires *eta-expansion*

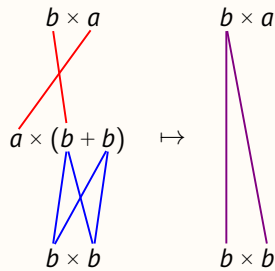

8/23

- Give a simple example to show that relational composition requires eta-expanded proof nets.

## Correctness

- A product  $\times$  (and a sum  $+$  on the left) is *switched*
- A switching deletes one entire subtree (not only the edge)

$$\frac{A \vdash B \quad A \vdash C}{A \vdash B \times C}^{\times R}$$

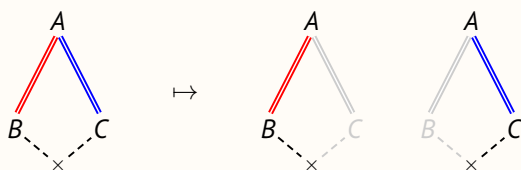

9/23

## De-sequentialization and switching

$$\frac{B \vdash D}{B \times C \vdash D} \times^L$$

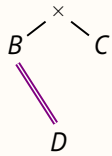

$$\frac{C \vdash D}{B \times C \vdash D} \times^L$$

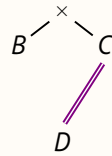

$$\frac{B \vdash D \quad C \vdash D}{B + C \vdash D} +^L$$

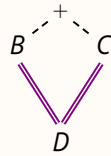

$$\frac{A \vdash C}{A \vdash B + C} +^R$$

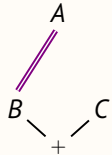

$$\frac{A \vdash C}{A \vdash B + C} +^R$$

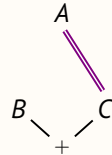

$$\frac{A \vdash B \quad A \vdash C}{A \vdash B \times C} \times^R$$

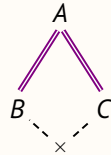

10/23

## Example

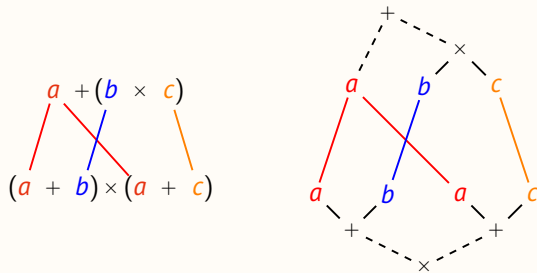

11/23

### Definition

- A *linking* for an additive sequent  $A \vdash B$  is a relation  $L \subseteq \text{sub}(A) \times \text{sub}(B)$  where  $\text{sub}(A)$  are the subformula occurrences of  $A$ . An *axiom linking* is one where every link relates two occurrences of the same formula.
- A *switching*  $s$  of  $A$  is a choice of  $B$  or  $C$  for every product  $B \times C$  in  $\text{sub}(A)$ . A *co-switching* chooses on sums  $B + C$ .
- The *resolution*  $s(A) \subseteq \text{sub}(A)$  given by a switching  $s$  consists of those subformula occurrences  $C$  where for every  $B_1 \times B_2$  in  $A$ , if  $C$  is in  $B_i$  then  $s$  chooses  $B_i$ . A *co-resolution* is defined analogously for a *co-switching*.
- A *resolution* of a linking  $L$  for  $A \vdash B$  is the restriction of  $L$  to  $r(A) \times s(B)$  for some co-switching  $r$  of  $A$  and switching  $s$  of  $B$ .
- An *additive proof net* is a sequent  $A \vdash B$  with an axiom linking  $L$  such that every resolution is a singleton.

12/23

## Coalescence: correctness by rewriting

$$\frac{B \vdash D}{B \times C \vdash D} \times L \quad \frac{C \vdash D}{B \times C \vdash D} \times L \quad \frac{B \vdash D \quad C \vdash D}{B + C \vdash D} +L$$

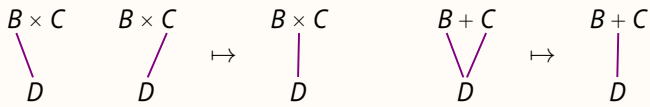

$$\frac{A \vdash B}{A \vdash B + C} +R \quad \frac{A \vdash C}{A \vdash B + C} +R \quad \frac{A \vdash B \quad A \vdash C}{A \vdash B \times C} \times R$$

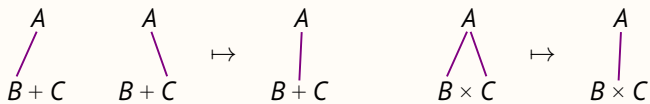

13/23

## Example again

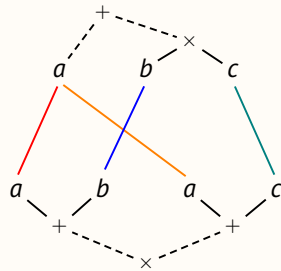

14/23

- Apply coalescence steps to show correctness of this example.

**Theorem**  
A linking is a proof net if and only if it coalesces, if and only if it sequentializes.

**Theorem**  
Coalescence for a linking over  $A \vdash B$  is decidable in  $\mathcal{O}(|A| \times |B|)$ .

15/23

## Deep inference: classical logic

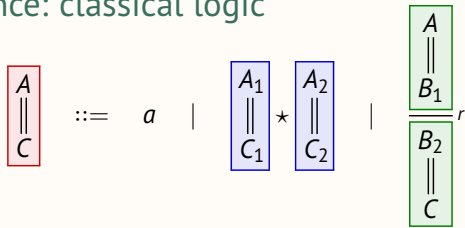

- Connectives:  $\wedge, \vee, \top, \perp$
- Invertible rules:

$$\frac{A \vee (B \vee C)}{(A \vee B) \vee C} \alpha \quad \frac{A \vee B}{B \vee A} \sigma \quad \frac{A}{\perp \vee A} \lambda \quad \frac{A \wedge (B \wedge C)}{(A \wedge B) \wedge C} \alpha \quad \frac{A \wedge B}{B \wedge A} \sigma \quad \frac{A}{\top \wedge A} \lambda$$

- Non-invertible rules:

$$\frac{\top}{A \vee \bar{A}} \top \quad \frac{(A \vee B) \wedge C}{A \vee (B \wedge C)} s \quad \frac{A \wedge \bar{A}}{\perp} \perp \quad \frac{\perp}{A} ? \quad \frac{A \vee A}{A} \nabla \quad \frac{A}{A \wedge A} \Delta \quad \frac{A}{\top} !$$

16/23

## Deep inference: additive linear logic

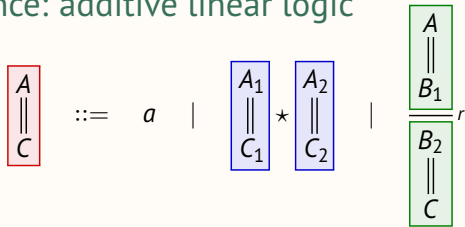

- Connectives:  $\times, +, \mathbf{1}, \mathbf{0}$
- Invertible rules:

$$\frac{A + (B + C)}{(A + B) + C} \alpha \quad \frac{A + B}{B + A} \sigma \quad \frac{A}{\mathbf{0} + A} \lambda \quad \frac{A \times (B \times C)}{(A \times B) \times C} \alpha \quad \frac{A \times B}{B \times A} \sigma \quad \frac{A}{\mathbf{1} \times A} \lambda$$

- Non-invertible rules:

$$\frac{\mathbf{0}}{A} ? \quad \frac{A + A}{A} \nabla \quad \frac{A}{A \times A} \Delta \quad \frac{A}{\mathbf{1}} !$$

17/23

## Inductive translation

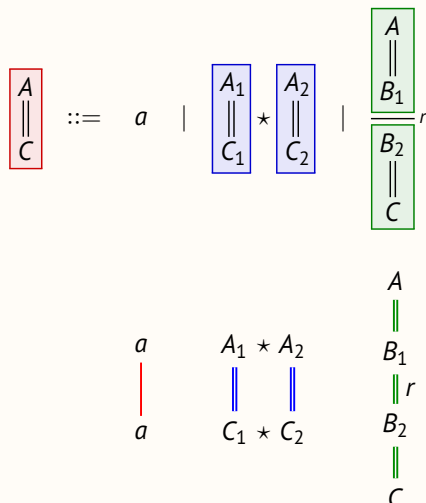

18/23

$$\frac{0}{A} \text{?} \quad \frac{A+A}{A} \nabla \quad \frac{A}{A \times A} \Delta \quad \frac{A}{1} !$$

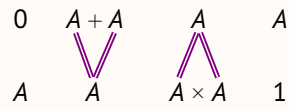

$$\frac{A+(B+C)}{(A+B)+C} \alpha \quad \frac{A+B}{B+A} \sigma \quad \frac{A}{0+A} \lambda \quad \frac{A \times (B \times C)}{(A \times B) \times C} \alpha \quad \frac{A \times B}{B \times A} \sigma \quad \frac{A}{1 \times A} \lambda$$

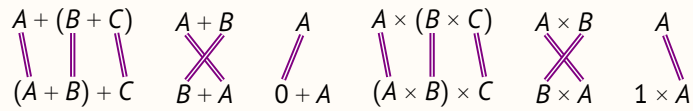

### Example again again

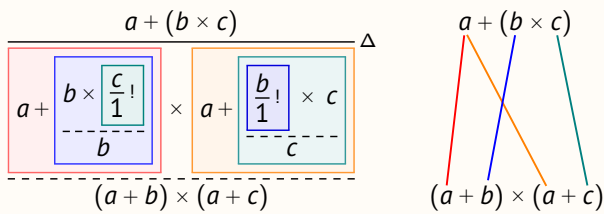

$$\frac{}{A \vdash A} Ax \quad \frac{B \vdash D}{B \times C \vdash D} \times L \quad \frac{C \vdash D}{B \times C \vdash D} \times L \quad \frac{B \vdash D \quad C \vdash D}{B + C \vdash D} +L$$

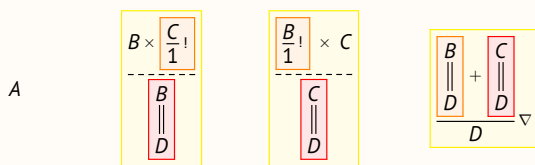

$$\frac{A \vdash B \quad B \vdash C}{A \vdash C} Cut \quad \frac{A \vdash B}{A \vdash B + C} +R \quad \frac{A \vdash C}{A \vdash B + C} +R \quad \frac{A \vdash B \quad A \vdash C}{A \vdash B \times C} \times R$$

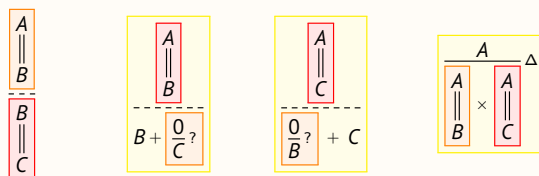

## Big picture

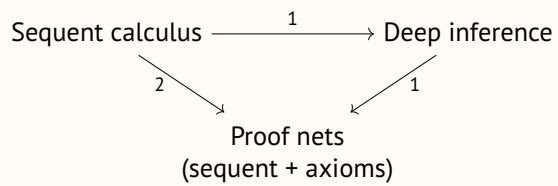

1. Translation
2. Translation with eta-expansion and cut-elimination

22/23

## Bibliography

P.M. Whitman, *Free lattices*, Annals of Mathematics 42(1), pp. 325–330, 1941

J.-Y. Girard, *Linear Logic*, Theoretical Computer Science 50(1), pp. 1–102, 1987

A. Joyal, *Free Lattices, Communication and Money Games*, Proc. 10th Int. Cong. of Logic, Methodology and Philosophy of Science, 1995

H. Hu, *Contractible Coherence Spaces and Maximal Maps*, ENTCS 20, pp. 309–319, 1999

D. Hughes & R. v. Glabbeek, *Proof nets for unit-free multiplicative-additive linear logic*, TOCL 6(4), pp. 784–842, 2005

W. Heijltjes & D. Hughes, *Complexity bounds for sum-product logic via additive proof nets and Petri nets*, LICS, pp. 80–91, 2015

23/23

From Proof Nets to Combinatorial Proofs  
—  
A New Approach to Hilbert's 24th Problem



## 6. Lecture

# Fibrations and Skew Fibrations



Willem Heijltjes and Lutz Straßburger

1/17

## What are Fibrations?

- originate in topology as a generalization of fiber bundles:

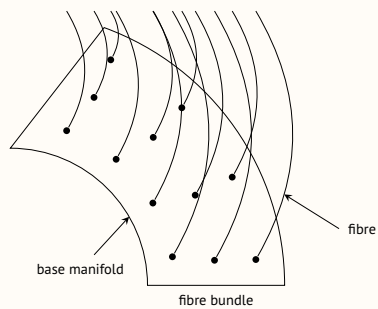

2/17

## What are Fibrations?

- fibrations in topology:

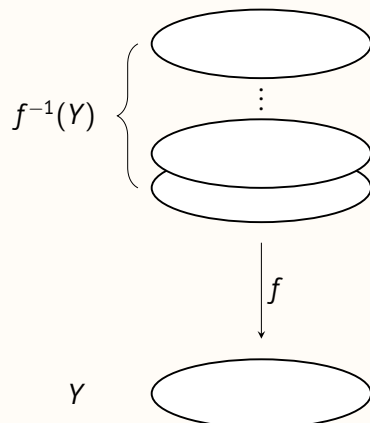

3/17

## Fibrations in Directed Graphs

### Definition:

A *fibration* is a graph homomorphism  $f: \mathcal{G} \rightarrow \mathcal{H}$  such that for all  $v \in V_{\mathcal{G}}$  and  $w' \in V_{\mathcal{H}}$ , if  $w' \rightarrow_{\mathcal{H}} f(v)$  then there is a unique  $w \in V_{\mathcal{G}}$  with  $w \rightarrow_{\mathcal{G}} v$  and  $f(w) = w'$ .

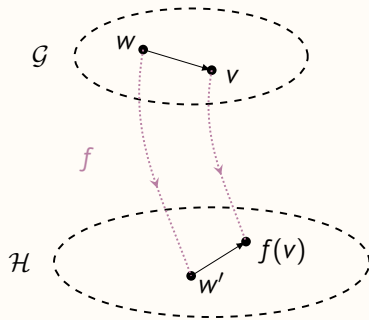

4/17

## Fibrations in Undirected Graphs

### Definition:

A *fibration* is a graph homomorphism  $f: \mathcal{G} \rightarrow \mathcal{H}$  such that for all  $v \in V_{\mathcal{G}}$  and  $w' \in V_{\mathcal{H}}$ , if  $\{w', f(v)\} \in E_{\mathcal{H}}$  then there is a unique  $w \in V_{\mathcal{G}}$  with  $\{w, v\} \in E_{\mathcal{G}}$  and  $f(w) = w'$ .

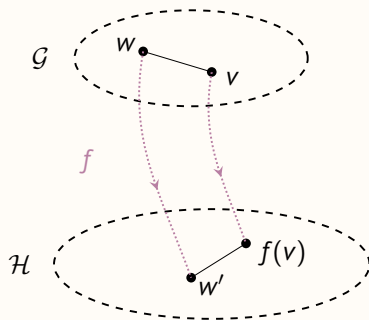

5/17

## Skew Fibrations in Undirected Graphs

### Definition:

A *skew fibration* is a graph homomorphism  $f: \mathcal{G} \rightarrow \mathcal{H}$  such that for all  $v \in V_{\mathcal{G}}$  and  $w' \in V_{\mathcal{H}}$ , if  $\{w', f(v)\} \in E_{\mathcal{H}}$  then there is a  $w$  with  $\{w, v\} \in E_{\mathcal{G}}$  and  $\{w', f(w)\} \notin E_{\mathcal{H}}$ .

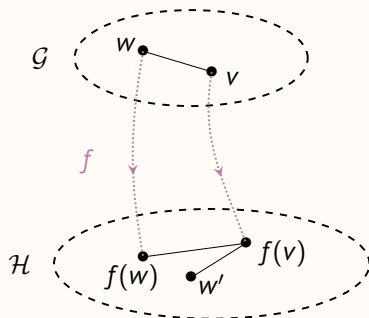

6/17

- In skew fibrations, two conditions that hold in fibrations are dropped:
  1. uniqueness of  $w$  is not demanded anymore, only existence
  2. we no longer demand that  $f(w) = w'$  but only that there is no edge between the two.
- Note that in an undirected graph there are no reflexive edges. That means that  $f(w) = w'$  is allowed, and a fibration is indeed a special case of a skew fibration.
- The term *skew fibration* is due to Hughes:
  - Dominic Hughes: **"Proofs Without Syntax"**. *Annals of Mathematics*, vol. 164, no. 3, pp. 1065–1076, 2006



## Skew Fibrations in Undirected Graphs

A *skew fibration* is a graph homomorphism  $f: \mathcal{G} \rightarrow \mathcal{H}$  such that for all  $v \in V_{\mathcal{G}}$  and  $w' \in V_{\mathcal{H}}$ , if  $\{w', f(v)\} \in E_{\mathcal{H}}$  then there is a  $w$  with  $\{w, v\} \in E_{\mathcal{G}}$  and  $\{w', f(w)\} \notin E_{\mathcal{H}}$ .

### Examples:

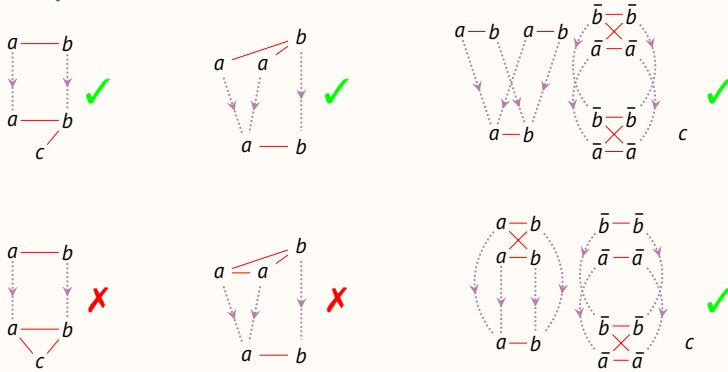

7/17

## SKSg: A Deep Inference System for Classical Logic

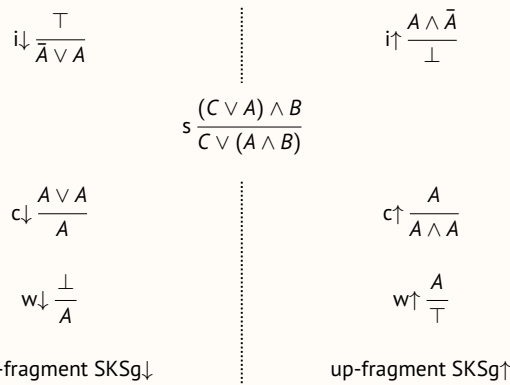

### rewriting modulo

$A \wedge B = B \wedge A$	$A \wedge (B \wedge C) = (A \wedge B) \wedge C$	$A \wedge \top = A$
$A \vee B = B \vee A$	$A \vee (B \wedge C) = (A \vee B) \vee C$	$A \vee \perp = A$

8/17

• For details on SKS consult:

- Kai Brännler and Alwen Tiu: **"A Local System for Classical Logic"**. *LPAR 2001*, pp. 347–361
- Kai Brännler: **"Deep Inference and Symmetry for Classical Proofs"**. *Ph.D. thesis, Technische Universität Dresden, 2003*

## SKSg: A Deep Inference System for Classical Logic

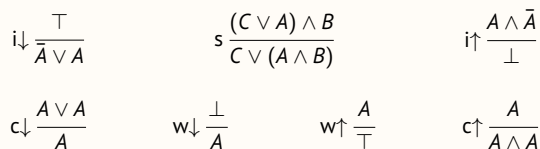

### Theorem: (Decomposition and Interpolation)

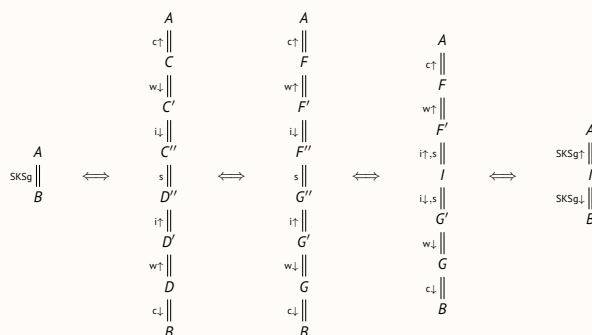

9/17

## Decomposition for the Down-Fragment

$$\text{SKSg}\downarrow: \quad \begin{array}{l} i\downarrow \frac{\top}{\bar{A} \vee A} \\ w\downarrow \frac{\perp}{A} \end{array} \quad \begin{array}{l} s \frac{(C \vee A) \wedge B}{C \vee (A \wedge B)} \\ c\downarrow \frac{A \vee A}{A} \end{array}$$

**Theorem:** (Decomposition)

$$\text{SKSg}\downarrow \parallel \frac{\top}{A} \iff \begin{array}{l} \{i\downarrow, s\} \parallel \frac{\top}{A'} \\ \{c\downarrow, w\downarrow\} \parallel \frac{}{A} \end{array} \leftarrow \text{this is MLL}$$

10/17

## Decomposition for the Down-Fragment (without units)

$$\text{SKSg}'\downarrow: \quad \begin{array}{l} i\downarrow \frac{}{\bar{A} \vee A} \\ w\downarrow \frac{B}{B \vee A} \end{array} \quad \begin{array}{l} i\downarrow \frac{B}{B \wedge (\bar{A} \vee A)} \\ c\downarrow \frac{A \vee A}{A} \end{array} \quad s \frac{(C \vee A) \wedge B}{C \vee (A \wedge B)}$$

**Theorem:** (Decomposition)

$$\text{SKSg}'\downarrow \parallel \frac{}{A} \iff \begin{array}{l} \{i\downarrow, s\} \parallel \frac{}{A'} \\ \{c\downarrow, w\downarrow\} \parallel \frac{}{A} \end{array} \leftarrow \text{this is unit-free MLL}$$

11/17

- Recall from earlier this week, that proofs in unit-free MLL can be described by proof nets and critically chorded RB-cographs.

## First Skew Fibration Theorem

**Theorem:** Let  $A$  and  $B$  be (classical logic) formulas.

Then there is a skew fibration  $f: \llbracket A \rrbracket \rightarrow \llbracket B \rrbracket$  iff  $\{c\downarrow, w\downarrow\} \parallel \frac{A}{B}$

**Examples:**

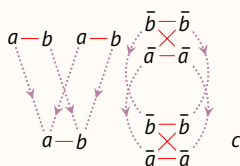

$$\begin{array}{l} w\downarrow \frac{(a \wedge b) \vee (a \wedge b) \vee ((\bar{a} \vee \bar{b}) \wedge (\bar{a} \vee \bar{b}))}{(a \wedge b) \vee (a \wedge b) \vee ((\bar{a} \vee \bar{b}) \wedge (\bar{a} \vee \bar{b})) \vee c} \\ c\downarrow \frac{}{(a \wedge b) \vee ((\bar{a} \vee \bar{b}) \wedge (\bar{a} \vee \bar{b})) \vee c} \end{array}$$

12/17

- This theorem has first been observed by Hughes:
  - Dominic Hughes: "Towards Hilbert's 24th Problem: Combinatorial Proof Invariants:(preliminary version)". *Electronic Notes in Theoretical Computer Science*, vol. 165, pp. 37-63, 2006
- An alternative proof using deep inference can be found here:
  - Lutz Straßburger: "A Characterization of Medial as Rewriting Rule". in *International Conference on Rewriting Techniques and Applications (RTA 2007)*, pp. 344-358, 2007

## ALL Proof Nets and Skew Fibrations

$$(a \times b) + (a \times c)$$

$$a \times (b + c)$$

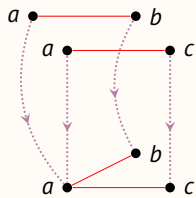
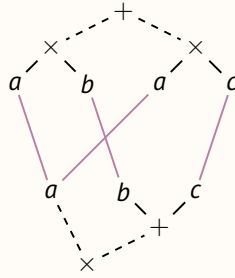

This is a skew fibration!



13/17

- **Exercise 6.1:** Show that every skew fibration defines an ALL proof net.

## Another ALL Proof Net

$$a + (b \times c)$$

$$(a + b) \times (a + c)$$

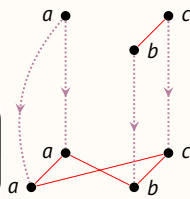
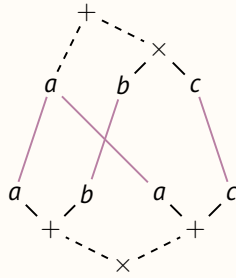

Not even a map!

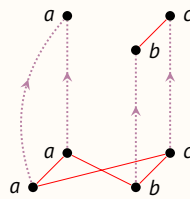

Not a skew fibration!



14/17

- Obviously not every ALL proof net is a skew fibration.

## Second Skew Fibration Theorem

**Theorem:** Let  $A$  and  $B$  be formulas. Then the following are equivalent:

1. There is an ALL proof net for  $A \vdash B$ .
2. There is a formula  $C$  such that there are skew fibrations  $f: \llbracket C \rrbracket \rightarrow \llbracket B \rrbracket$  and  $g: \llbracket \bar{C} \rrbracket \rightarrow \llbracket \bar{A} \rrbracket$ .

- **Exercise 6.2:** (Difficult) Prove the theorem.

15/17

## Summary (Multiplicative Part)

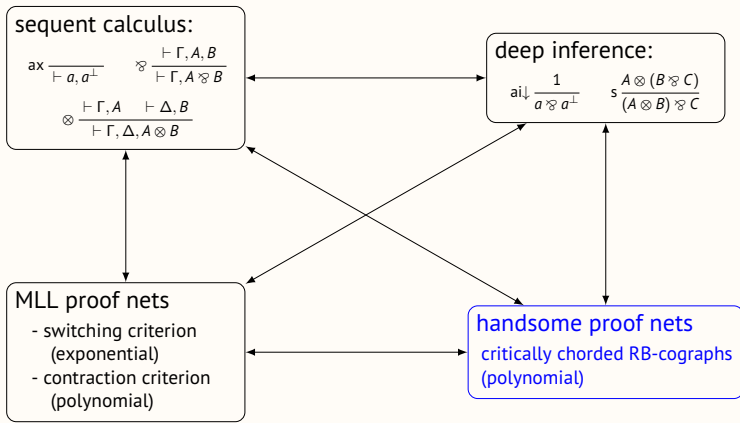

16/17

## Summary (Additive Part)

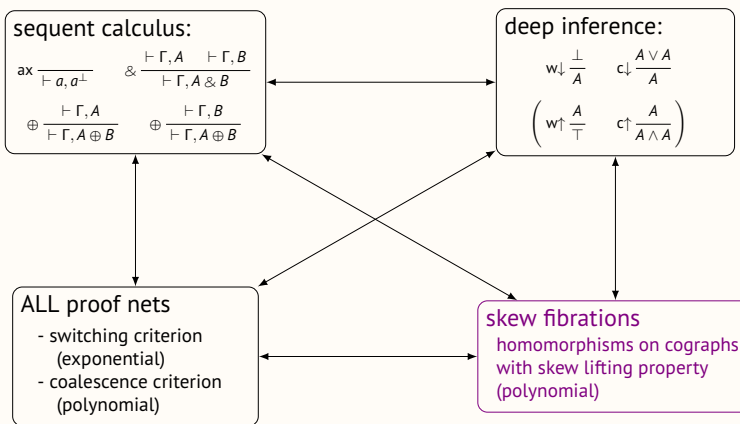

17/17

From Proof Nets to Combinatorial Proofs  
—  
A New Approach to Hilbert's 24th Problem



## 7. Lecture

# Classical Propositional Combinatorial Proofs



Willem Heijltjes and Lutz Straßburger

1/18

## Combinatorial proofs

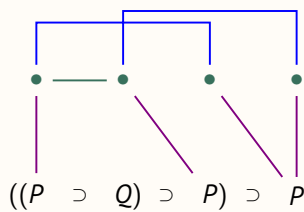

Handsome proof net

Cograph

Skew fibration

Conclusion

2/18

## Aim

What is a good semantics of classical logic?

- Reduction is non-confluent  $\implies$  no canonical normal forms
- Cartesian closed categories with duality  $\implies$  collapse
- Embeddings in intuitionistic logic  $\implies$  break duality  $A \not\sim \bar{\bar{A}}$
- Distributivity gives canonical normal forms  $\implies$  collapse

$$A \wedge (B \vee C) \sim (A \wedge B) \vee (A \wedge C)$$

3/18

## Naive cut-reduction

$$\frac{\frac{\frac{\vdash \Gamma}{\vdash \Gamma, A} w \quad \vdash \bar{A}, \Delta}{\vdash \Gamma, \Delta} \text{Cut}}{\vdash \Gamma, \Delta} \mapsto \frac{\vdash \Gamma}{\vdash \Gamma, \Delta} w$$

$$\frac{\frac{\frac{\vdash \Gamma, A, A}{\vdash \Gamma, A} c \quad \vdash \bar{A}, \Delta}{\vdash \Gamma, \Delta} \text{Cut}}{\vdash \Gamma, \Delta} \mapsto \frac{\frac{\frac{\vdash \Gamma, A, A \quad \vdash \bar{A}, \Delta}{\vdash \Gamma, A, \Delta} \text{Cut} \quad \vdash \bar{A}, \Delta}{\vdash \Gamma, \Delta, \Delta} \text{Cut}}{\vdash \Gamma, \Delta} c$$

4/18

## Lafont's examples: non-confluence

$$\frac{\vdash \Gamma}{\vdash \Gamma, \Delta} w \leftarrow \frac{\frac{\frac{\vdash \Gamma}{\vdash \Gamma, A} w \quad \frac{\vdash \Delta}{\vdash \bar{A}, \Delta} w}{\vdash \Gamma, \Delta} \text{Cut}}{\vdash \Gamma, \Delta} \mapsto \frac{\vdash \Delta}{\vdash \Gamma, \Delta} w$$

5/18

## Lafont's examples: non-termination

$$\frac{\frac{\frac{\frac{\vdash \Gamma, A, A}{\vdash \Gamma, A} c \quad \frac{\frac{\vdash \bar{A}, \bar{A}, \Delta}{\vdash \bar{A}, \Delta} c}{\vdash \Gamma, \Delta} \text{Cut}}{\vdash \Gamma, \Delta} \text{Cut}}{\vdash \Gamma, \Delta} \mapsto \frac{\frac{\frac{\frac{\frac{\vdash \Gamma, A, A}{\vdash \Gamma, A} c \quad \frac{\frac{\frac{\vdash \Gamma, A, A}{\vdash \Gamma, A} c \quad \vdash \bar{A}, \bar{A}, \Delta}{\vdash \Gamma, \bar{A}, \Delta} \text{Cut}}{\vdash \Gamma, \Gamma, \Delta} c}{\vdash \Gamma, \Delta} c}{\vdash \Gamma, \bar{A}, \bar{A}, \Delta} \text{Cut} \quad \vdash \bar{A}, \bar{A}, \Delta}{\vdash \Gamma, \bar{A}, \bar{A}, \Delta} \text{Cut}}{\vdash \Gamma, \bar{A}, \bar{A}, \Delta, \Delta} c}{\vdash \Gamma, \bar{A}, \bar{A}, \Delta} c}{\vdash \Gamma, \bar{A}, \bar{A}, \Delta} c}{\vdash \Gamma, \bar{A}, \bar{A}, \Delta} \text{Cut}}{\vdash \Gamma, \Gamma, \Delta} c$$

6/18

- This is a cut on two contracted formulae.
- First, the cut interacts with the blue (right) contraction. This duplicates the left branch (the red cut) and creates a new series of contractions below the two new cuts.
- Second, the top cut interacts with its red (left) contraction. This duplicates the right branch and creates a new series of contractions below the two new cuts.
- The cut at the bottom is now in the original situation, with a cut on two contracted formulae.
- It follows that naive cut-reduction is not strongly normalizing.

We cannot have a non-trivial semantics of classical proof and:

- involutive negation  $\overline{\overline{A}} \cong A$
- conjunction and disjunction are products and coproducts
- disjunction acts as implication  $A \supset B = \overline{A} \vee B$

- Intuitionistic natural deduction proves  $A \vdash (A \supset \perp) \supset \perp$ , and extends to classical natural deduction by including a rule  $\perp E$ ,

$$\frac{[\overline{A}]^\alpha \dots \perp}{A} \perp E, \alpha$$

which proves  $(A \supset \perp) \supset \perp \vdash A$  (double-negation elimination). However, the two proofs do not form an isomorphism: composing them does not necessarily give an identity. Classical natural deduction is computational, and double-negation elimination relates to the *call/cc* construct (call-with-current-continuation); see Parigot's  $\lambda\mu$ -calculus and subsequent work.

- Omitting some of the equations for products and coproducts (while keeping the necessary contraction and weakening rules) can be sufficient to prevent the semantics from becoming trivial. However, equating proofs under cut-elimination automatically gives products and coproducts, so this is no longer possible.
- Additive linear logic has involutive negation, products, and coproducts, but its disjunction does not have an axiom (only the separate meta-connective  $\vdash$  does), and so cannot take the role of an implication. While it is possible to build a classical model this way, again equating proofs under cut-elimination is ruled out.

### Combinatorial proofs

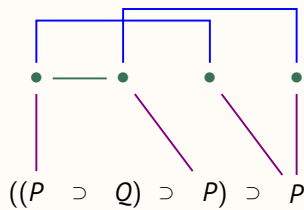

Handsome proof net

Cograph

Skew fibration

Conclusion

### Example: distributivity

$$a \wedge (b \vee c) \implies (a \wedge b) \vee (a \wedge c)$$

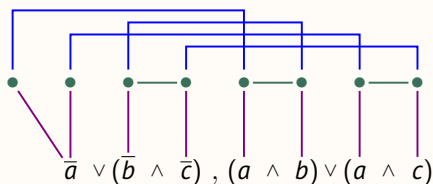

$$\frac{}{\vdash a, \bar{a}}^{Ax}$$



$$\frac{\vdash \Gamma, A, B}{\vdash \Gamma, A \vee B}^{\vee R}$$

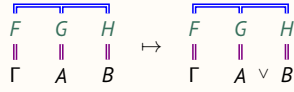

$$\frac{\vdash \Gamma, A \quad \vdash B, \Delta}{\vdash \Gamma, A \wedge B, \Delta}^{\wedge R}$$

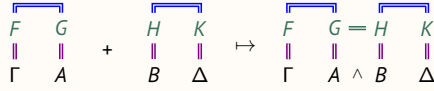

$$\frac{\vdash \Gamma}{\vdash \Gamma, A}^w$$

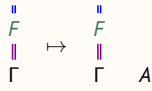

$$\frac{\vdash \Gamma, A, A}{\vdash \Gamma, A}^c$$

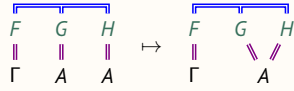

Special case:

$$\frac{\frac{\frac{\vdash \Gamma}{\vdash \Gamma, A}^w \quad \vdash B, \Delta}{\vdash \Gamma, A \wedge B, \Delta}^{\wedge R}}{\vdash \Gamma, A \wedge B, \Delta}^w \sim \frac{\vdash \Gamma}{\vdash \Gamma, A \wedge B, \Delta}^w$$

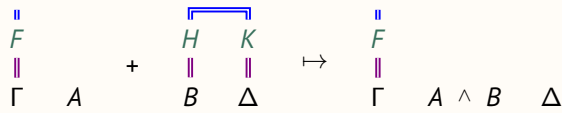

Special special case:

$$\frac{\vdash \Gamma}{\vdash \Gamma, A \wedge B, \Delta}^w \leftarrow \frac{\frac{\frac{\vdash \Gamma}{\vdash \Gamma, A}^w \quad \frac{\vdash \Delta}{\vdash B, \Delta}^w}{\vdash \Gamma, A \wedge B, \Delta}^{\wedge R}}{\vdash \Gamma, A \wedge B, \Delta}^w \rightarrow \frac{\vdash \Delta}{\vdash \Gamma, A \wedge B, \Delta}^w$$

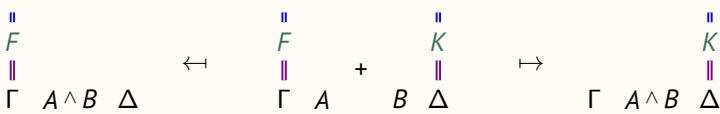

The translation from sequent proofs is **non-deterministic** (unless we allow **mix** in our handsome proof nets)



The case conjunction-contraction:

$$\frac{\frac{\frac{\Gamma, A, A}{\Gamma, A}^c \quad \Gamma, \Delta}{\Gamma, A \wedge B, \Delta}^{\wedge R}}{\Gamma, A \wedge B, \Delta} \quad \sim \quad \frac{\frac{\frac{\Gamma, A, A \quad \Gamma, B, \Delta}{\Gamma, A, A \wedge B, \Delta}^{\wedge R} \quad \Gamma, \Delta}{\Gamma, A \wedge B, A \wedge B, \Delta, \Delta}^{\wedge R}}{\Gamma, A \wedge B, \Delta}^c$$

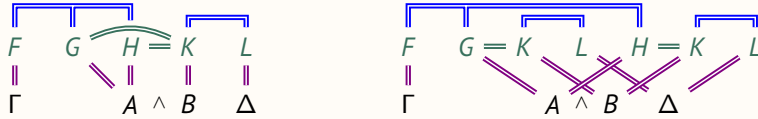

Combinatorial proofs are *complexity-sensitive*

13/18

### Example: distributivity, the other direction (1)

$$a \wedge (b \vee c) \iff (a \wedge b) \vee (a \wedge c)$$

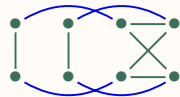
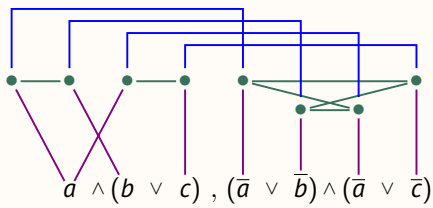

14/18

### Example: distributivity, the other direction (2)

$$a \wedge (b \vee c) \iff (a \wedge b) \vee (a \wedge c)$$

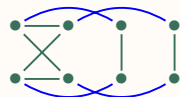
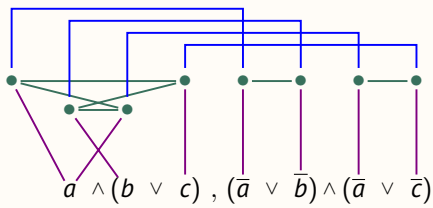

15/18

## Example: distributivity?

$$a \wedge (b \vee c) \iff (a \wedge b) \vee (a \wedge c)$$

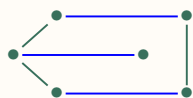
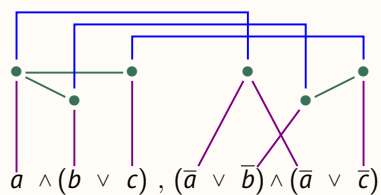

Not a combinatorial proof: the lower part is an additive proof net but **not** a skew fibration

16/18

## Big question

Are combinatorial proofs a good semantics of classical logic?

17/18

## Bibliography

J.-Y. Girard, Y. Lafont & P. Taylor, *Proofs and Types*. Cambridge University Press, 1989

D. Hughes, *Proofs Without Syntax*, *Annals of Mathematics* 164(3), pp. 1065–1076, 2006

L. Straßburger, *Towards a Theory of Proofs of Classical Logic*, Habilitation à diriger des recherches, École Polytechnique, Palaiseau, France

18/18



## 8. Lecture

# First-Order Combinatorial Proofs



Willem Heijltjes and Lutz Straßburger

1/1

## First-Order Combinatorial Proofs

Definition:

A *first-order combinatorial proof* of a formula  $A$  is a skew bifibration  $\phi: \mathcal{C} \rightarrow \mathcal{G}$  where  $\mathcal{C}$  is a fonet and  $\mathcal{G}$  is the graph of the formula  $A$ .

2/1

## First-Order Formulas

*Terms:*  $t ::= x \mid f(t_1, \dots, t_n)$

*Atoms:*  $a ::= 1 \mid 0 \mid p(t_1, \dots, t_n) \mid \bar{p}(t_1, \dots, t_n)$

*Formulas:*  $A ::= a \mid A \wedge A \mid A \vee A \mid \exists x.A \mid \forall x.A$

*Sequents:*  $\Gamma ::= A_1, A_2, \dots, A_m$

<i>Negation:</i>	$\bar{1} = 0$	$\overline{p(t_1, \dots, t_n)} = \bar{p}(t_1, \dots, t_n)$
	$\bar{0} = 1$	$\overline{\bar{p}(t_1, \dots, t_n)} = p(t_1, \dots, t_n)$
	$\overline{\exists x.A} = \forall x.\bar{A}$	$\overline{A \wedge B} = \bar{A} \vee \bar{B}$
	$\overline{\forall x.A} = \exists x.\bar{A}$	$\overline{A \vee B} = \bar{A} \wedge \bar{B}$

*Rectified Formulas:* all bound variables are distinct from one another and from all free variables

3/1

## Graphs of Formulas

Operations on (undirected) graphs:

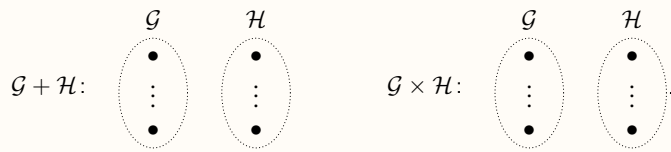

Mapping  $\llbracket \cdot \rrbracket$  from formulas to (labelled) graphs:

$$\begin{aligned} \llbracket a \rrbracket &= \bullet a \quad (\text{for any atom } a) \\ \llbracket A \vee B \rrbracket &= \llbracket A \rrbracket + \llbracket B \rrbracket & \llbracket \exists x.A \rrbracket &= \bullet x \times \llbracket A \rrbracket \\ \llbracket A \wedge B \rrbracket &= \llbracket A \rrbracket \times \llbracket B \rrbracket & \llbracket \forall x.A \rrbracket &= \bullet x + \llbracket A \rrbracket \end{aligned}$$

Example:  $\llbracket \exists x.(\bar{p}x \vee (\forall y.py)) \rrbracket =$

Definition: A *fograph* (first-order graph) is the graph  $\llbracket A \rrbracket$  of a formula  $A$ .

4/1

## Graphs of Formulas

Congruence Relation  $\equiv$  on Formulas:

$$\begin{aligned} A \wedge B &\equiv B \wedge A & (A \wedge B) \wedge C &\equiv A \wedge (B \wedge C) \\ A \vee B &\equiv B \vee A & (A \vee B) \vee C &\equiv A \vee (B \vee C) \\ \forall x.\forall y.A &\equiv \forall y.\forall x.A & \forall x.(A \vee B) &\equiv (\forall x.A) \vee B \\ \exists x.\exists y.A &\equiv \exists y.\exists x.A & \exists x.(A \wedge B) &\equiv (\exists x.A) \wedge B \end{aligned} \quad (x \text{ not free in } B)$$

Theorem: For rectified formulas  $A$  and  $B$  we have

$$A \equiv B \iff \llbracket A \rrbracket = \llbracket B \rrbracket$$

Example:  $\exists x.(\bar{p}x \vee (\forall y.py)) \equiv \exists x \forall y (py \vee \bar{p}x)$

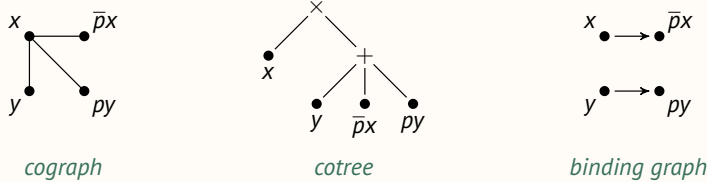

5/1

## First-Order Combinatorial Proofs

Definition:

A *first-order combinatorial proof* of a formula  $A$  is a skew bifibration  $\phi: \mathcal{C} \rightarrow \mathcal{G}$  where  $\mathcal{C}$  is a fonet and  $\mathcal{G}$  is the graph of the formula  $A$ .

6/1

## Fonets

*Linked Fograph*: partially colored fograph, where

- each color consists of two literals with dual predicate symbols
- every literal is either 1-labelled or in a link

*Dualizer*: substitution unifying all the links

*Dependency*: pair  $\{\bullet x, \bullet y\}$  such that most general dualizer assigns to the existential  $x$  a term containing the universal  $y$

*Leap Graph*: vertices: as in the fograph  
edges: links and dependencies

*Example*:

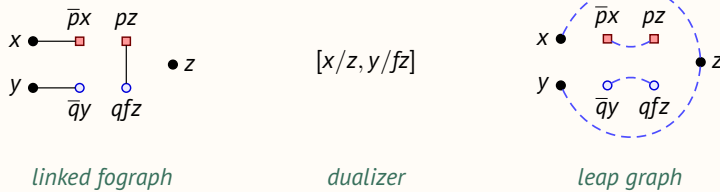

7/1

## Fonets

*Definition*: A set of vertices *induces a bimatching* if it induces a matching in the fograph and a matching in the leap graph.

*Definition*: A *fonet* (or *first-order net*) is a linked fograph which has a dualizer but no induced bimatching.

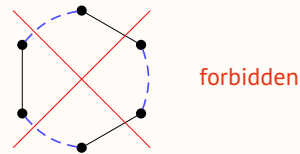

*Example*:

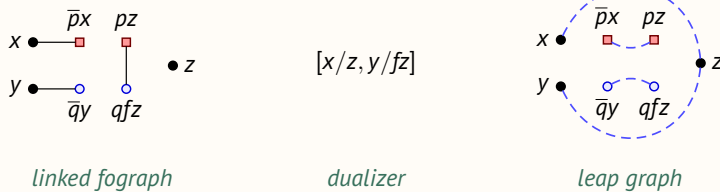

8/1

- Observe that “no bimatching” is the same condition as “critically chorded” for RB-cograph. The difference is that here the “blue” edges (the edges of the leap graph) do not form a perfect matching for the vertex set.
- **Exercise 8.1:** Show that Retoré’s “handsome proof nets” are a special case of fonets.

## First-Order Combinatorial Proofs

*Definition*:

A *first-order combinatorial proof* of a formula  $A$  is a skew bifibration  $\phi: \mathcal{C} \rightarrow \mathcal{G}$  where  $\mathcal{C}$  is a fonet and  $\mathcal{G}$  is the graph of the formula  $A$ .

9/1



# First-Order Deep Inference System

$\forall \frac{1}{\forall x.1}$	$ai \frac{1}{a \vee \bar{a}}$	$1 \frac{A}{A \wedge 1}$	$w \frac{A}{A \vee B}$	$m \frac{(A \wedge C) \vee (B \wedge D)}{(A \vee B) \wedge (C \vee D)}$	$ac \frac{a \vee a}{a}$
$s \frac{A \wedge (B \vee C)}{(A \wedge B) \vee C}$	$mix \frac{A \wedge B}{A \vee B}$	$m_{\forall} \frac{(\forall x.A) \vee (\forall x.B)}{\forall x.(A \vee B)}$	$m_{\exists} \frac{(\exists x.A) \vee (\exists x.B)}{\exists x.(A \vee B)}$		
$\exists \frac{A[x/t]}{\exists x.A}$	$\equiv \frac{B}{A} \text{ (where } A \equiv B)$	$w_{\forall} \frac{A}{\forall x.A} \text{ (x not free in A)}$	$c_{\forall} \frac{\forall x.\forall x.A}{\forall x.A}$		

KS1: deep inference system for first-order logic (all rules)  
 MLS1: linear fragment (dashed box)

- Relation between KS1 and focp:
- MLS1 proof  $\rightarrow$  fonet ✓
  - KS1 proof  $\rightarrow$  focp ✓
  - fonet  $\rightarrow$  MLS1 proof ✓
  - focp  $\rightarrow$  KS1 proof ✓

# First-Order Deep Inference System

$\forall \frac{1}{\forall x.1}$	$ai \frac{1}{a \vee \bar{a}}$	$1 \frac{A}{A \wedge 1}$
$s \frac{A \wedge (B \vee C)}{(A \wedge B) \vee C}$	$mix \frac{A \wedge B}{A \vee B}$	
$\exists \frac{A[x/t]}{\exists x.A}$	$\equiv \frac{B}{A} \text{ (where } A \equiv B)$	

$w \frac{A}{A \vee B}$	$m \frac{(A \wedge C) \vee (B \wedge D)}{(A \vee B) \wedge (C \vee D)}$	$ac \frac{a \vee a}{a}$
$m_{\forall} \frac{(\forall x.A) \vee (\forall x.B)}{\forall x.(A \vee B)}$	$m_{\exists} \frac{(\exists x.A) \vee (\exists x.B)}{\exists x.(A \vee B)}$	
$w_{\forall} \frac{A}{\forall x.A} \text{ (x not free in A)}$	$c_{\forall} \frac{\forall x.\forall x.A}{\forall x.A}$	

Theorem:

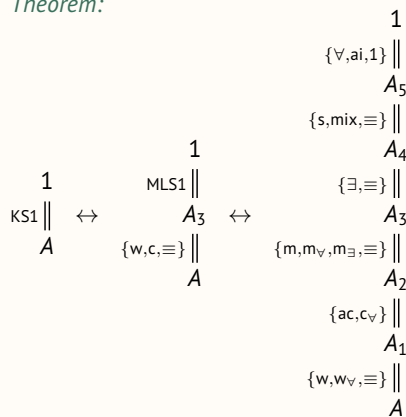

$$c \frac{A \vee A}{A}$$

# First-Order Linear Proofs

Theorems:

$$\begin{array}{l} ax \frac{}{\vdash pz, \bar{p}z} \quad ax \frac{}{\vdash qfz, \bar{q}fz} \\ \wedge \frac{}{\vdash pz \wedge qfz, \bar{p}z, \bar{q}fz} \\ \exists \frac{}{\vdash pz \wedge qfz, \bar{p}z, \exists \bar{q}y} \\ \exists \frac{}{\vdash pz \wedge qfz, \exists x.\bar{p}x, \exists \bar{q}y} \\ \forall \frac{}{\vdash \forall z.pz \wedge qfz, \exists x.\bar{p}x, \exists \bar{q}y} \end{array}$$

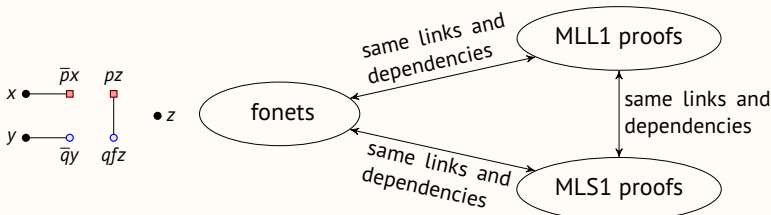

$$\begin{array}{l} 1, \forall \frac{1}{\forall z.(1 \wedge 1)} \\ ai \downarrow, ai \downarrow \frac{}{\forall z.((pz \vee \bar{p}z) \wedge (qfz \vee \bar{q}fz))} \\ s \frac{}{\forall z.(((pz \vee \bar{p}z) \wedge qfz) \vee \bar{q}fz)} \\ s, \equiv \frac{}{(\forall z.pz \wedge qfz) \vee \bar{p}z \vee \bar{q}fz} \\ \exists, \exists \frac{}{(\forall z.pz \wedge qfz) \vee (\exists x.\bar{p}x) \vee (\exists \bar{q}y)} \end{array}$$

Exercise 8.4: Give the deep inference derivations for the four compinatorial proofs above.

# Resource Management in First-Order Proofs

Theorem:

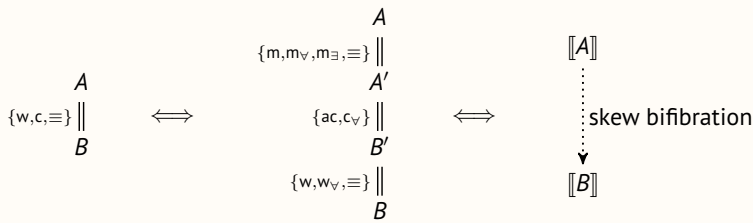

$\frac{m}{c} \frac{(A \wedge C) \vee (B \wedge D)}{(A \vee B) \wedge (C \vee D)}$	$\frac{m_{\forall}}{c_{\forall}} \frac{(\forall x.A) \vee (\forall x.B)}{\forall x.(A \vee B)}$	$\frac{m_{\exists}}{c_{\exists}} \frac{(\exists x.A) \vee (\exists x.B)}{\exists x.(A \vee B)}$
$\frac{c}{w} \frac{A \vee A}{A}$	$\frac{ac}{a} \frac{a \vee a}{a}$	$\frac{c_{\forall}}{w_{\forall}} \frac{\forall x.\forall x.A}{\forall x.A}$
$\frac{w}{w_{\forall}} \frac{A}{A \vee B}$	$\frac{w_{\forall}}{w_{\exists}} \frac{A}{\forall x.A}$ (x not free in A)	

## Example

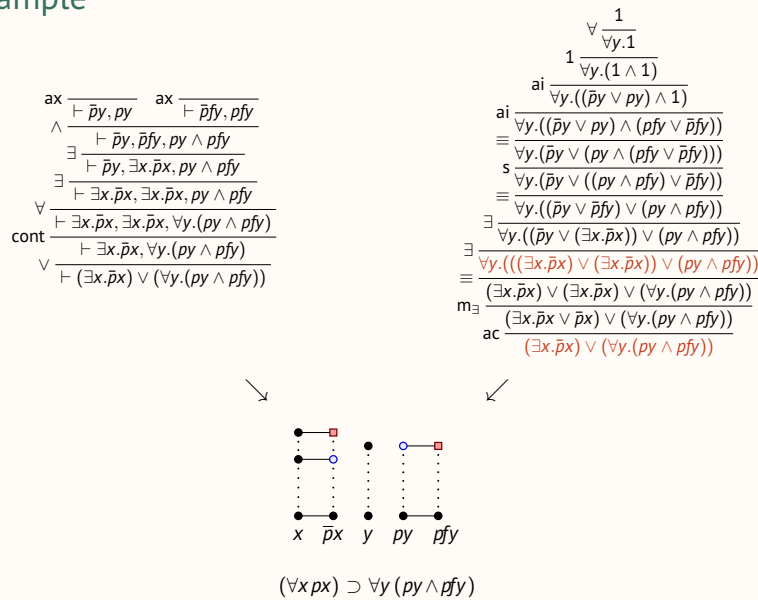

## Example

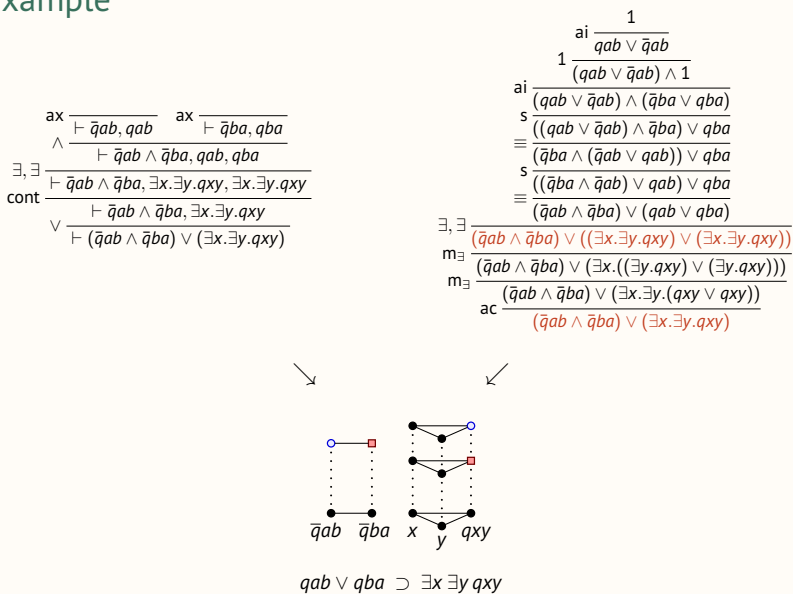



## Example (Drinker's Formula)

$$\begin{array}{c}
 \text{ax} \frac{}{\vdash pz, \bar{p}z} \\
 \text{weak} \frac{}{\vdash \bar{p}w, pz, \bar{p}z} \\
 \text{weak} \frac{}{\vdash \bar{p}w, pz, \bar{p}z, \forall y.py} \\
 \vee \frac{}{\vdash \bar{p}w, pz, \bar{p}z \vee (\forall y.py)} \\
 \vee \frac{}{\vdash \bar{p}w, pz, \exists x.(\bar{p}x \vee (\forall y.py))} \\
 \vee \frac{}{\vdash \bar{p}w, \forall y.py, \exists x.(\bar{p}x \vee (\forall y.py))} \\
 \vee \frac{}{\vdash \bar{p}w \vee (\forall y.py), \exists x.(\bar{p}x \vee (\forall y.py))} \\
 \exists \frac{}{\vdash \exists x.(\bar{p}x \vee (\forall y.py)), \exists x.(\bar{p}x \vee (\forall y.py))} \\
 \text{cont} \frac{}{\vdash \exists x.(\bar{p}x \vee (\forall y.py))}
 \end{array}$$

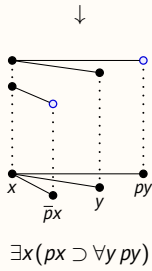

$$\begin{array}{c}
 \frac{\vee 1}{\forall y.1} \\
 \text{ai} \frac{}{\forall y.(py \vee \bar{p}y)} \\
 \text{w} \frac{}{\forall y.((py \vee \bar{p}y) \vee (\bar{p}w \vee (\forall y.py)))} \\
 \equiv \frac{}{\forall y.((\bar{p}w \vee py) \vee (\bar{p}y \vee (\forall y.py)))} \\
 \equiv \frac{}{(\bar{p}w \vee (\forall y.py)) \vee (\exists x.(\bar{p}x \vee (\forall y.py)))} \\
 \exists \frac{}{(\exists x.(\bar{p}x \vee (\forall y.py))) \vee (\exists x.(\bar{p}x \vee (\forall y.py)))} \\
 \text{m}\exists \frac{}{\exists x.((\bar{p}x \vee (\forall y.py)) \vee (\bar{p}x \vee (\forall y.py)))} \\
 \equiv \frac{}{\exists x.((\bar{p}x \vee \bar{p}x) \vee ((\forall y.py) \vee (\forall y.py)))} \\
 \text{ac} \frac{}{\exists x.(\bar{p}x \vee ((\forall y.py) \vee (\forall y.py)))} \\
 \text{m}\vee \frac{}{\exists x.(\bar{p}x \vee (\forall y.py \vee py))} \\
 \text{ac} \frac{}{\exists x.(\bar{p}x \vee (\forall y.py))}
 \end{array}$$

$$\begin{array}{c}
 \frac{\vee 1}{\forall y.1} \\
 \text{ai} \frac{}{\forall y.(\bar{p}y \vee py)} \\
 \exists \frac{}{\forall y.((\exists x.\bar{p}x) \vee py)} \\
 \equiv \frac{}{(\exists x.\bar{p}x) \vee (\forall y.py)} \\
 \exists \frac{}{(\exists x.\bar{p}x) \vee (\exists x.(\forall y.py))} \\
 \text{m}\exists \frac{}{\exists x.(\bar{p}x \vee (\forall y.py))}
 \end{array}$$

19/1

- This formula is called the *drinker's formula* because it can be read as "In every bar there is a person  $x$ , such that whenever that person is drinking then everyone else is also drinking":  $\exists x(\bar{p}x \supset \forall y.py)$ .
- That formula is interesting for several reasons:
  - It is not valid intuitionistically.
  - In the sequent calculus the whole formula needs to be duplicated first. This can be simulated in deep inference. However, in deep inference and in combinatorial proofs, this duplication is not necessary.

From Proof Nets to Combinatorial Proofs  
 —  
 A New Approach to Hilbert's 24th Problem



9. Lecture

Intuitionistic Combinatorial Proofs



Willem Heijltjes and Lutz Straßburger

A Last Word on Classical Combinatorial Proofs

**Definition:**

A *combinatorial proof* of a formula  $A$  is a skew fibration  $f: \mathcal{C} \rightarrow \llbracket A \rrbracket$  from a critically chorded RB-cograph (aka nicely colored cograph)  $\mathcal{C}$  to the cograph of  $A$ , such that two vertices that paired in  $\mathcal{C}$  are mapped to dual atoms in  $\llbracket A \rrbracket$ .

**Example:**

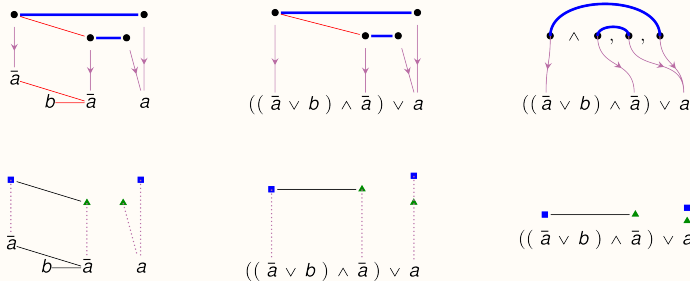

Another Last Word on Classical Combinatorial Proofs

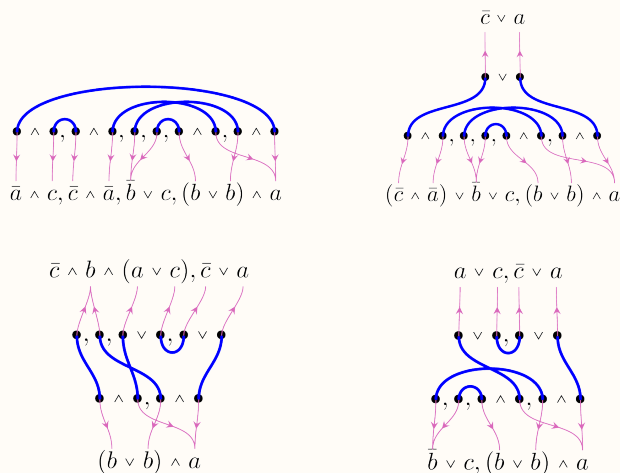

- In different publications and also in different lectures in this course, different notations are used. But it should be clear that these are indeed only different notations for the same thing.
  - The last one on the first second row has the advantage of using the least amount of ink. It has been introduced in:
    - *Dominic Hughes: "Proofs Without Syntax". Annals of Mathematics, vol. 164, no. 3, pp. 1065–1076, 2006*
  - The last one on the first row has been introduced in:
    - *Lutz Straßburger: "Combinatorial Flows and Their Normalisation". in 2nd International Conference on Formal Structures for Computation and Deduction (FSCD 2017). Schloss Dagstuhl-Leibniz-Zentrum fuer Informatik, 2017*
- It has the advantage that one can easily see the correspondence to the *flow graph* of the atoms in a derivation, as indicated on the following two slides.

These are all the same combinatorial proofs, just drawn in different ways with some formulas in the conclusion flipped upside-down.

# A Final Last Word on Classical Combinatorial Proofs (and Deep Inference)

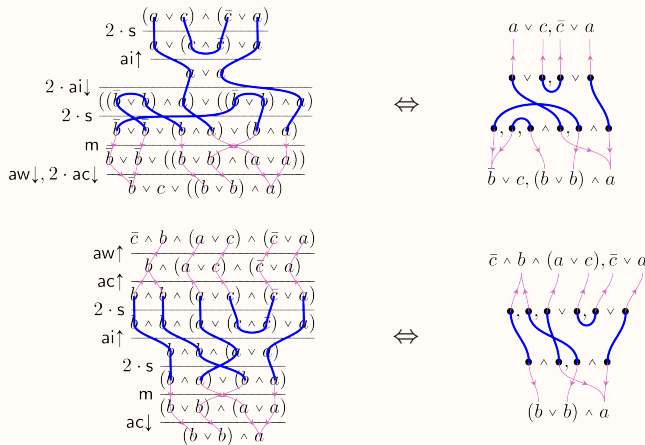

## From Classical to Intuitionistic Combinatorial Proofs

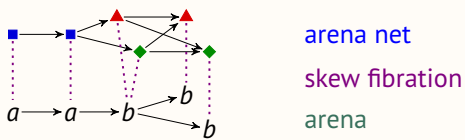

$$((a \supset a) \supset b) \supset (b \wedge b)$$

cograph = classical logic formula  
up to associativity and commutativity

arena = intuitionistic logic formula  
up to associativity and commutativity

- ingredients to a combinatorial proof:

classical	intuitionistic
cograph	arena
RB-cograph	linked arena
critically chorded RB-cograph nicely colored cograph	arena net
skew fibration	skew fibration

## Arenas

**Definition:** An *arena* is a directed acyclic graph (dag) that is

- L-free*: if  $v \leftarrow u \rightarrow x \rightarrow w$  then  $v \rightarrow w$

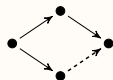

- Σ-free*: if  $u \leftarrow x \rightarrow v \leftarrow y \rightarrow w$  then  $x \rightarrow w$  or  $y \rightarrow u$

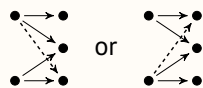

- and has a *partition* (equivalence relation  $\sim$  on vertices)

**Example:**



The details for the material in this lecture can be found in

- Willem Heijltjes and Dominic Hughes and Lutz Straßburger: "Intuitionistic Proofs without Syntax". LICS 2019

## From Formulas to Arenas

- Operations on dags:

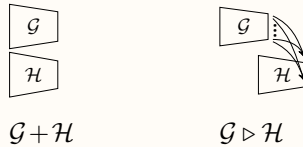

- Formulas:  $A, B ::= P \mid A \wedge B \mid A \supset B$

- Translating formulas to dags:

$$\llbracket P \rrbracket = \bullet \quad \llbracket A \wedge B \rrbracket = \llbracket A \rrbracket + \llbracket B \rrbracket \quad \llbracket A \supset B \rrbracket = \llbracket A \rrbracket \triangleright \llbracket B \rrbracket$$

Example:  $((P \supset P) \supset Q) \wedge Q \supset R \wedge ((S \supset S) \supset S)$

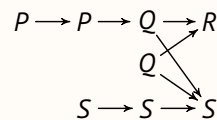

7/20

## From Formulas to Arenas

Example:  $((P \supset P) \supset Q) \wedge Q \supset R \wedge ((S \supset S) \supset S)$



**Theorem:** A dag is an arena iff it is the translation of a formula.

**Theorem:**  $\llbracket A \rrbracket = \llbracket B \rrbracket$  iff  $A \equiv B$ .

where  $\equiv$  is generated from

$$(A \wedge B) \supset C \equiv A \supset (B \supset C) \quad A \wedge (B \wedge C) \equiv (A \wedge B) \wedge C \quad A \wedge B \equiv B \wedge A$$

and  $A \equiv B$  if  $A$  and  $B$  are the same up to a renaming of atoms.

8/20

## Arena Nets

- linked arena: every partition (link) consists of exactly two vertices: one even and one odd

Example:  $P^\bullet \rightarrow P^\circ \rightarrow Q^\bullet \rightarrow Q^\circ$

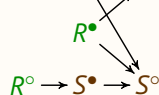

odd vertex ( $\bullet$ ) = odd depth  
even vertex ( $\circ$ ) = even depth

- link graph (of a linked arena): remove all edges into even vertices  
add a link edge for each link  
(from odd to even)

Example:  $P^\bullet \rightarrow P^\circ \rightarrow Q^\bullet \rightarrow Q^\circ$

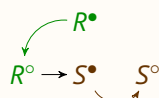

9/20

- The term *arena* comes from games semantics, e.g.:
  - Martin Hyland and Luke Ong: "On Full Abstraction for PCF: I. Models, observables and the full abstraction problem, II. Dialogue games and innocent strategies, III. A fully abstract and universal game model". *Information and Computation* 163, pp.285-408, 2000
- However, the definition we present here originates from:
  - Willem Heijltjes and Dominic Hughes and Lutz Straßburger: "Intuitionistic Proofs without Syntax". *LICS 2019*
- The purpose of our definition definition is to cover exactly the notion of IPL formula modulo  $\equiv$ .

## Arena Nets

### Example:

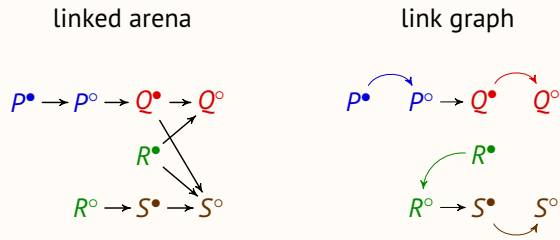

**Definition:** An *arena net* is a linked arena satisfying:

- *Acyclicity:* The link graph is acyclic.
- *Functionality:* In the link graph, every path from an odd vertex  $v$  to a root visits a consequent of  $v$  (in the arena).

10/20

## Arena Nets

**Theorem:** Let  $\llbracket A \rrbracket$  be a linked arena. TFAE:

1.  $\llbracket A \rrbracket$  is an arena net;
2. the corresponding linking on  $A$  forms an IMLL proof net for  $A$ ;
3.  $\llbracket A \rrbracket$  can be constructed via IMLL sequent calculus.

**Example:**  $((P \supset P) \supset Q) \wedge R \supset Q \wedge ((R \supset S) \supset S)$

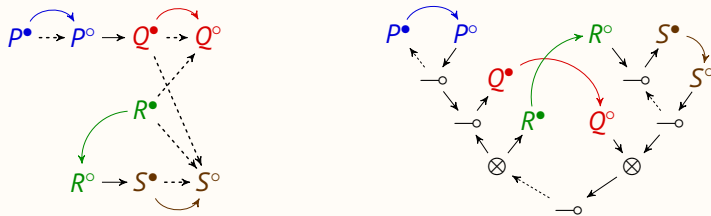

11/20

## Intuitionistic Combinatorial Proofs

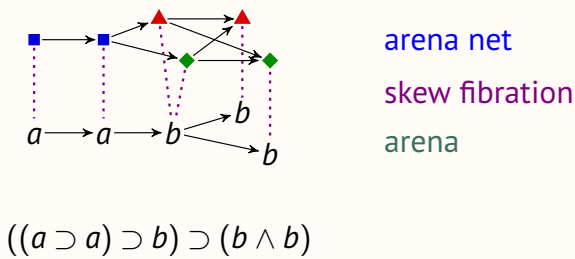

12/20

- An *arena net* is a linked arena that obeys a correctness criterion, i.e., that is a linked arena that comes from a proof.

- Recall: IMLL stands for *intuitionistic multiplicative linear logic*.
- This theorem is due to
  - Willem Heijltjes, Dominic Hughes and Lutz Straßburger: “**Intuitionistic Proofs without Syntax**”. *LICS 2019*
- Its proof shows the equivalence between the arena correctness criterion and the *essential net criterion* due to François Lamarche:
  - François Lamarche: “**Proof nets for intuitionistic linear logic I: Essential nets**”. *Technical Report, Imperial College, London, 2004*

## Skew fibrations

$v \wedge w$  iff  $v$  and  $w$  are distinct and meet at odd depth or do not meet at all  
 $v \not\wedge w$  otherwise

**Example:**

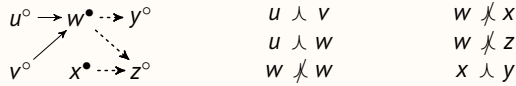

**Definition:** A *skew fibration*  $f: \mathcal{G} \rightarrow \mathcal{H}$ , of an arena  $\mathcal{G}$  over an arena  $\mathcal{H}$ , is a function  $f: V_{\mathcal{G}} \rightarrow V_{\mathcal{H}}$  which preserves

edges:  $v \rightarrow_{\mathcal{G}} w$  implies  $f(v) \rightarrow_{\mathcal{H}} f(w)$   
 equivalence:  $v \sim_{\mathcal{G}} w$  implies  $f(v) \sim_{\mathcal{H}} f(w)$   
 roots:  $r \not\rightarrow_{\mathcal{G}}$  implies  $f(r) \not\rightarrow_{\mathcal{H}}$   
 conjuncts:  $v \wedge_{\mathcal{G}} w$  implies  $f(v) \wedge_{\mathcal{H}} f(w)$

and satisfies the following *skew lifting* condition:

- if  $f(v) \wedge_{\mathcal{H}} w$  then there exists  $u$  with  $v \wedge_{\mathcal{G}} u$  and  $f(u) \not\wedge_{\mathcal{H}} w$ .

13/20

## Intuitionistic combinatorial proofs

**Definition:** An *intuitionistic combinatorial proof* or *ICP* of a formula  $A$  is a skew fibration  $f: \mathcal{G} \rightarrow \llbracket A \rrbracket$  of an arena net  $\mathcal{G}$  over the arena  $\llbracket A \rrbracket$ .

**Examples:**

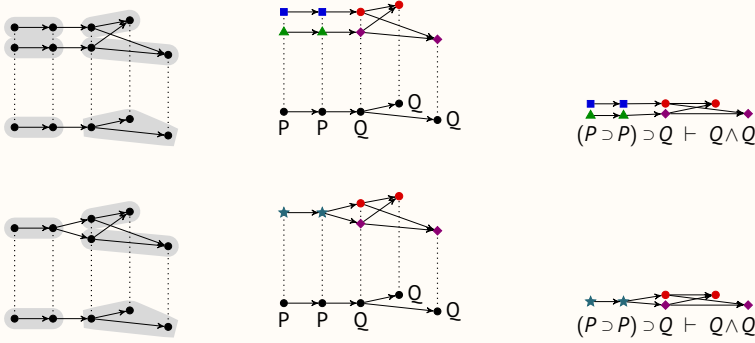

14/20

## From Sequent Calculus to ICP

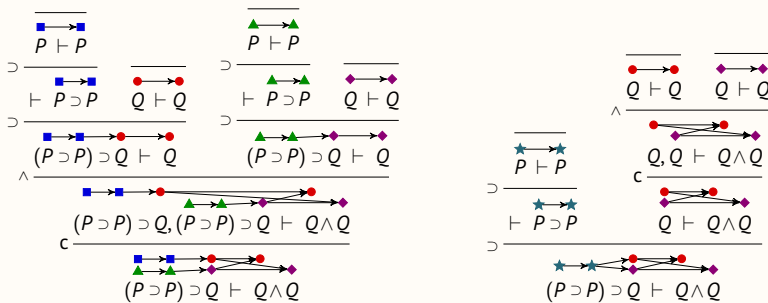

**Theorem:** The translation  $\llbracket \pi \rrbracket$  of a sequent proof  $\pi$  is an ICP.

**Theorem:** This translation is surjective.

**Theorem:** This translation is polynomial (in both directions).

**Theorem:**  $\llbracket \pi_1 \rrbracket = \llbracket \pi_2 \rrbracket$  iff  $\pi_1 \equiv \pi_2$  (modulo non-duplicating rule permutations).

15/20

- The  $\wedge$ -relation simply recovers the cograph structure: If we translate  $A \supset B$  to  $\bar{A} \vee B$ , and then translate the resulting formula into a cograph as discussed earlier this week, then we have  $v \wedge w$  iff there is an edge between the corresponding vertices in the cograph.

• **Exercise 9.1:** Prove that.

- As in all cases before, a skew fibration is a structure preserving map that additionally obeys *skew lifting*. The first two conditions in the definition demand that  $f$  is an arena homomorphism, and the last one that it is a graph homomorphism on the cographs. The third condition is there since in intuitionistic logic,  $A \neq \neg\neg A$ .

- In the examples, the actual ICPs are shown on the left. In the middle are the same objects in a more human-readable notation. On the right is a more compact notation, carrying the same information.

- Note that, different from the classical case, here we do not need the extra condition about the dual atoms in a link upstairs and the preservation of the labeling by the skew fibration. The reason is that in the intuitionistic case there are no negated atoms, and therefore the preservation of the partitioning by the skew fibration is enough.

- The statement of the third theorem is also called *polynomial full completeness* (and the term has been invented for ICP, following the *full completeness* known from game semantics).

## Comparison to $\lambda$ -Calculus

$$\frac{\frac{x:P \vdash x:P}{\vdash \lambda x.x : P \supset P} \quad \frac{w:Q \vdash w:Q}{\vdash \lambda y.y : P \supset P}}{f_1 : (P \supset P) \supset Q \vdash f_1(\lambda x.x) : Q} \quad \frac{\frac{y:P \vdash y:P}{\vdash \lambda y.y : P \supset P} \quad \frac{v:Q \vdash v:Q}{\vdash \lambda y.y : P \supset P}}{f_2 : (P \supset P) \supset Q \vdash f_2(\lambda y.y) : Q}$$

$$\frac{f_1 : (P \supset P) \supset Q, f_2 : (P \supset P) \supset Q \vdash (f_1(\lambda x.x), f_2(\lambda y.y)) : Q \wedge Q}{f : (P \supset P) \supset Q \vdash (f(\lambda x.x), f(\lambda y.y)) : Q \wedge Q}$$

$$\frac{\frac{z:P \vdash z:P}{\vdash \lambda z.z : P \supset P}}{f : (P \supset P) \supset Q \vdash (f(\lambda z.z), f(\lambda z.z)) : Q \wedge Q} \quad \frac{\frac{v_1:Q \vdash v_1:Q \quad v_2:Q \vdash v_2:Q}{v_1:Q, v_2:Q \vdash (v_1, v_2) : Q \wedge Q}}{v:Q \vdash (v, v) : Q \wedge Q}}$$

Translating sequent proofs to  $\lambda$ -terms can cause exponential blow-up!



ICPs form a semantics of proofs that respects complexity.

16/20

## Sequent Calculus Rule Permutations

$$\frac{\frac{\Gamma \vdash A \quad B, \Delta, C \vdash D}{\Gamma \vdash A \quad B, \Delta \vdash C \supset D} \supset_R \quad \frac{\Gamma \vdash A \quad B, \Delta, C \vdash D}{\Gamma, A \supset B, \Delta \vdash C \supset D} \supset_L}{\Gamma, A \supset B, \Delta \vdash C \supset D} \supset_L \equiv \frac{\frac{\Gamma \vdash A \quad B, \Delta, C \vdash D}{\Gamma, A \supset B, \Delta, C \vdash D} \supset_L \quad \frac{\Gamma \vdash A \quad B, \Delta, C \vdash D}{\Gamma, A \supset B, \Delta \vdash C \supset D} \supset_R}{\Gamma, A \supset B, \Delta \vdash C \supset D} \supset_L \quad \checkmark$$

$$\frac{\frac{\Gamma \vdash A \quad \Delta \vdash C}{\Gamma, A \supset B, \Delta \vdash C} \text{weak} \quad \frac{\Delta \vdash C}{\Gamma, A \supset B, \Delta \vdash C} \text{weak}}{\Gamma, A \supset B, \Delta \vdash C} \supset_L \equiv \frac{\Delta \vdash C}{\Gamma, A \supset B, \Delta \vdash C} \text{weak} \quad \checkmark$$

$$\frac{\frac{\Gamma \vdash A \quad B, B, \Delta \vdash C}{\Gamma, A \supset B, \Delta \vdash C} \text{cont} \quad \frac{B, B, \Delta \vdash C}{\Gamma, A \supset B, \Delta \vdash C} \text{cont}}{\Gamma, A \supset B, \Delta \vdash C} \supset_L \not\equiv \frac{\frac{\Gamma \vdash A \quad B, B, \Delta \vdash C}{\Gamma, A \supset B, \Gamma, A \supset B, \Delta \vdash C} \supset_L \quad \frac{\Gamma \vdash A \quad B, B, \Delta \vdash C}{\Gamma, A \supset B, \Gamma, A \supset B, \Delta \vdash C} \supset_L}{\Gamma, A \supset B, \Delta \vdash C} \text{cont} \quad \times$$

17/20

- **Exercise 9.2:** How many possible rule permutations are there?

## Comonoid Transformations

$$\frac{\frac{\frac{\Gamma, A, A, B, B \vdash C}{\Gamma, A, B, B \vdash C} \text{cont} \quad \frac{\Gamma, A, A, B, B \vdash C}{\Gamma, A, B, B \vdash C} \text{cont}}{\Gamma, A, B \vdash C} \wedge_L \quad \frac{\Gamma, A, A, B, B \vdash C}{\Gamma, A \wedge B, A, B \vdash C} \wedge_L}{\Gamma, A \wedge B \vdash C} \wedge_L \equiv \frac{\frac{\Gamma, A, B, A, B \vdash C}{\Gamma, A \wedge B, A, B \vdash C} \wedge_L \quad \frac{\Gamma, A, B, A, B \vdash C}{\Gamma, A \wedge B, A \wedge B \vdash C} \wedge_L}{\Gamma, A \wedge B \vdash C} \text{cont}$$

$$\frac{\frac{\Gamma \vdash C}{\Gamma, A \vdash C} \text{weak} \quad \frac{\Gamma \vdash C}{\Gamma, A, B \vdash C} \text{weak}}{\Gamma, A \wedge B \vdash C} \wedge_L \equiv \frac{\Gamma \vdash C}{\Gamma, A \wedge B \vdash C} \text{weak}$$

$$\frac{\frac{\Gamma, A \vdash B}{\Gamma, A, A \vdash B} \text{weak} \quad \frac{\Gamma, A \vdash B}{\Gamma, A \vdash B} \text{cont}}{\Gamma, A \vdash B} \text{cont} \equiv \Gamma, A \vdash B$$

18/20

## Formula-isomorphism transformations

$$\frac{\Gamma, A, B \vdash C}{\Gamma, A \wedge B \vdash C} \wedge_L \quad \equiv \quad \frac{\Gamma, A, B \vdash C}{\Gamma, B \wedge A \vdash C} \wedge_L$$

$$\frac{\Gamma \vdash A \quad \Delta \vdash B}{\Gamma, \Delta \vdash A \wedge B} \wedge_R \quad \equiv \quad \frac{\Delta \vdash B \quad \Gamma \vdash A}{\Gamma, \Delta \vdash B \wedge A} \wedge_R$$

$$\frac{\Gamma, A, B, C \vdash D}{\Gamma, A \wedge B, C \vdash D} \wedge_L \quad \equiv \quad \frac{\Gamma, A, B, C \vdash D}{\Gamma, A, B \wedge C \vdash D} \wedge_L$$

$$\frac{\Gamma, (A \wedge B) \wedge C \vdash D}{\Gamma, A \wedge (B \wedge C) \vdash D} \wedge_L$$

$$\frac{\frac{\Gamma \vdash A \quad \Delta \vdash B}{\Gamma, \Delta \vdash A \wedge B} \wedge_R \quad \Lambda \vdash C}{\Gamma, \Delta, \Lambda \vdash (A \wedge B) \wedge C} \wedge_R \quad \equiv \quad \frac{\frac{\Delta \vdash B \quad \Lambda \vdash C}{\Delta, \Lambda \vdash B \wedge C} \wedge_R \quad \Gamma \vdash A}{\Gamma, \Delta, \Lambda \vdash A \wedge (B \wedge C)} \wedge_R$$

$$\frac{\Gamma, A, B \vdash C}{\Gamma, A \wedge B \vdash C} \wedge_L \quad \equiv \quad \frac{\Gamma, A, B \vdash C}{\Gamma, A \supset B \supset C} \supset_R$$

$$\frac{\Gamma \vdash A \wedge B \supset C}{\Gamma \vdash A \supset B \supset C} \supset_R$$

$$\frac{\frac{\Gamma \vdash A \quad \Delta \vdash B}{\Gamma, \Delta \vdash A \wedge B} \wedge_R \quad C, \Lambda \vdash D}{\Gamma, \Delta, A \wedge B \supset C, \Lambda \vdash D} \supset_L \quad \equiv \quad \frac{\frac{\Delta \vdash B \quad C, \Lambda \vdash D}{\Delta, B \supset C, \Lambda \vdash D} \supset_L \quad \Gamma \vdash A}{\Gamma, \Delta, A \supset B \supset C, \Lambda \vdash D} \supset_L$$



From Proof Nets to Combinatorial Proofs  
—  
A New Approach to Hilbert's 24th Problem



## 10. Lecture

### Normalization



Willem Heijltjes and Lutz Straßburger

1/13

### Intuitionistic composition

$$\Gamma \vdash A \quad + \quad A, \Delta \vdash B \quad \mapsto \quad \Gamma, \Delta \vdash B$$

2/13

### For intuitionistic combinatorial proofs

Option 1: use a special left-implication connective  $\blacktriangleright$

$$\Gamma \vdash A \quad + \quad A, \Delta \vdash B \quad \mapsto \quad \Gamma, A \blacktriangleright A, \Delta \vdash B$$

- The conclusion is still  $\Gamma, \Delta \vdash B$  and  $A \blacktriangleright A$  is *hidden*
- $\blacktriangleright$  is a *meta-connective* and may only occur at top level
- Cut-elimination is standard (local rewriting with *kingdoms*)

Option 2: compute the result directly

$$\Gamma \vdash A \quad + \quad A, \Delta \vdash B \quad \mapsto \quad \Gamma, \Delta \vdash B$$

- Fixes the reduction strategy
- Game semantics and Geometry of Interaction do this

3/13

Option 1 is a standard way to add explicit cuts to proof nets in the sequent + axioms paradigm.

- **Exercise 10.1:** Add an explicit cut-connective to MLL proof nets in this way, and give the cut-elimination steps.

Option 3 (new!): build a tree

$$\Gamma \vdash A \quad + \quad A, \Delta \vdash B \quad \mapsto \quad \Gamma, \Delta \vdash B$$

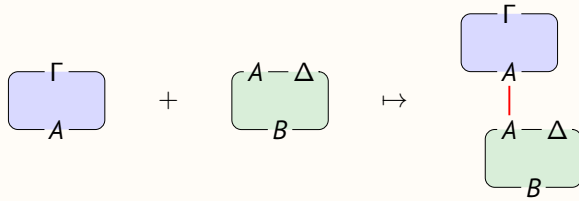

4/13

### ICPs as nodes

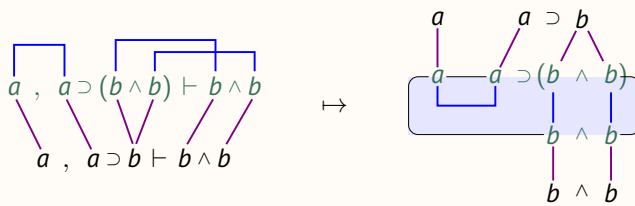

An ICP over a sequent  $A_1, \dots, A_n \vdash B$  becomes a node with premises/inputs  $A_1$  through  $A_n$  and conclusion/output  $B$ .

5/13

$$\frac{}{x : a \vdash x : a} \text{Ax}$$



$$\frac{\Gamma, x : A \vdash M : B}{\Gamma \vdash \lambda x. M : A \supset B} \supset R$$

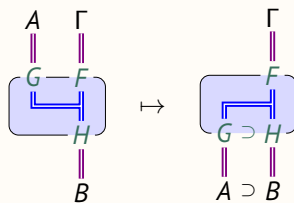

6/13

$$\frac{\Gamma \vdash M : A \quad x : B, \Delta \vdash N : C}{\Gamma, f : A \supset B, \Delta \vdash N[f M/x] : C} \supset^L$$

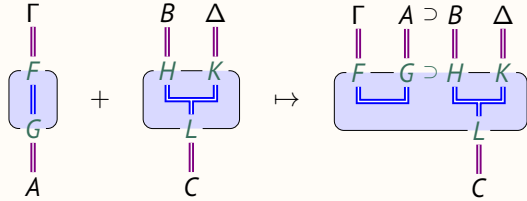

7/13

$$\frac{\Gamma \vdash M : B}{\Gamma, x : A \vdash M : B} W$$

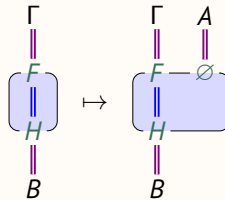

$$\frac{\Gamma, x : A, y : A \vdash M : B}{\Gamma, x : A \vdash M[x/y] : B} C$$

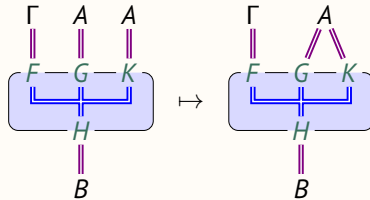

8/13

## Building trees

$$\frac{\Gamma \vdash M : A \quad x : A, \Delta \vdash N : B}{\Gamma, \Delta \vdash N[M/x] : B} Cut$$

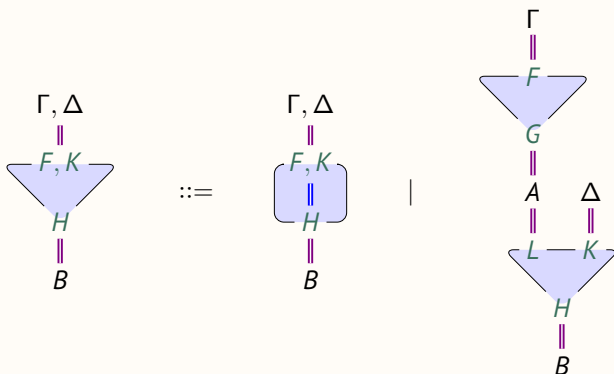

9/13

# Reduction

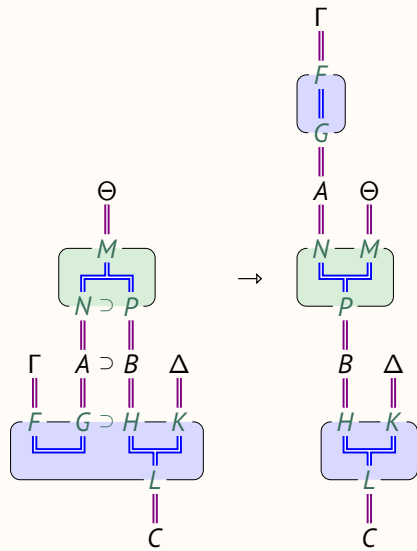

10/13

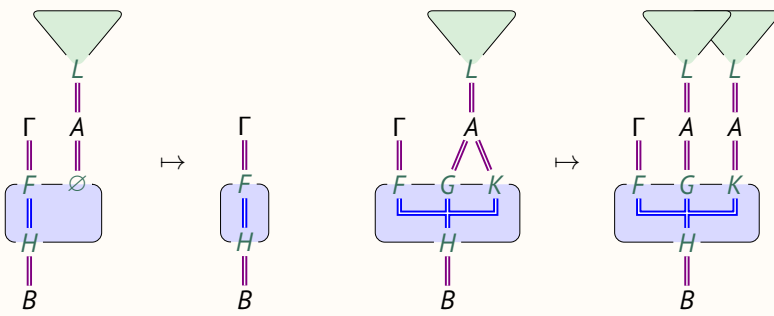

11/13

**Theorem**  
 ICP reduction is **confluent** and **strongly normalizing**.

12/13

## Observations

- ICP reduction is sequent calculus cut-elimination, but
  - without permutations
  - with all cuts at top level
- Contraction on ICP trees requires graphs
- Abstraction on ICP trees is lambda-lifting
- ICP reduction is closed reduction (in  $\lambda$ -calculus: a redex  $(\lambda x.M)N$  may only be reduced if it has no free variables)
- Reduction uses only sub-ICPs of those in the original tree