



**HAL**  
open science

# Dissipative dynamical systems with set-valued feedback loops Well-posed set-valued Lur'e dynamical systems

Bernard Brogliato

► **To cite this version:**

Bernard Brogliato. Dissipative dynamical systems with set-valued feedback loops Well-posed set-valued Lur'e dynamical systems. IEEE Control Systems Magazine, 2022, 42 (3), pp.93-114. <10.1109/mcs.2022.3157160>. <hal-03293492v2>

**HAL Id: hal-03293492**

**<https://inria.hal.science/hal-03293492v2>**

Submitted on 29 Jul 2021

HAL is a multi-disciplinary open access archive for the deposit and dissemination of scientific research documents, whether they are published or not. The documents may come from teaching and research institutions in France or abroad, or from public or private research centers.

L'archive ouverte pluridisciplinaire HAL, est destinée au dépôt et à la diffusion de documents scientifiques de niveau recherche, publiés ou non, émanant des établissements d'enseignement et de recherche français ou étrangers, des laboratoires publics ou privés.



HAL Authorization

# Dissipative dynamical systems with set-valued feedback loops

Well-posed set-valued Lur'e dynamical systems

Bernard Brogliato

Univ. Grenoble Alpes, INRIA, CNRS, LJK, Grenoble INP,  
38000 Grenoble, France.

July 29, 2021

This introductory article deals with the well-posedness analysis (*i.e.*, existence and uniqueness of solutions) of a class of finite-dimensional, continuous-time dynamical systems in feedback form as shown in Figure 1. These feedback systems are made of a dynamical system, that may be linear or nonlinear, connected to a static nonlinearity  $\mathcal{M}(\cdot)$ . In most of the Automatic Control literature, the static feedback nonlinearity is assumed to be continuous *single-valued*, and to verify a sector constraint, while the dynamical system possesses some passivity property: this is known as Lur'e systems. Hence the closed-loop's well-posedness is guaranteed by general theorems for ordinary differential equations, and the main issue is about the stability: this has been called the absolute stability problem. The systems we are interested in in this article, extend classical Lur'e systems, since they consist of the negative feedback interconnection of a single-valued passive system with a *set-valued* mapping  $\mathcal{M}(\cdot)$ , *i.e.*, a mapping which associates sets to points. Then the mere existence and uniqueness of solutions to the dynamical system has to be examined, because the set-valuedness introduced in the loop *via* the static nonlinearity may create some additional difficulties: the system is a *differential inclusion* of a certain type. It is shown how the dissipativity (more exactly, the passivity) of the single-valued dynamical subsystem, as introduced by J.C. Willems in his two seminal articles [S1], [S2] may help to secure the existence and the uniqueness of solutions to the closed-loop system, when the static nonlinearity satisfies itself a specific passivity-like property. Such a conclusion on the closed-loop well-posedness is not as trivial as it may appear at first sight, since passivity is usually known to guarantee stability properties. In this article, the most important property of the considered static mappings  $\mathcal{M}(\cdot)$  is the so-called *maximal monotonicity*, which is widely used in Mathematical Analysis [1], [2], [S15], [S20], [S27]. Roughly speaking, maximal monotone set-valued mappings are incrementally passive operators which verify additionally a semicontinuity condition. Also, maximal monotonicity is closely related to convexity through the subdifferentiation of convex

lower semicontinuous single-valued functions, see “Maximal Monotone Mappings”. Therefore  
2 the feedback systems analysed in the sequel consist of two passive subsystems in negative  
feedback interconnection, and thus can be named *set-valued Lur’e systems*. They form a subclass  
4 of differential inclusions with specific interesting features, see [3] for a complete survey about  
the various mathematical formalisms, models, applications, well-posedness proofs, and stability.  
6 The analysis of such set-valued Lur’e systems started in the former USSR *circa* 1960, with  
several contributions by authors like Yakubovich, Leonov, Gelig, Andronov, Barabanov, see  
8 [4] for a complete exposition of their results. These authors considered feedback nonlinearities  
represented by discontinuous functions, where discontinuities are “filled-in” *via* a Filippov’s  
10 convexification. Hence they become set-valued nonlinearities which are required to satisfy  
monotonicity properties (some kind of extended signum functions), while the “filling-in-the-  
12 gaps” operation secures the maximality, hence the graph closedness and the outer semicontinuity  
of set-valued functions. These authors mainly focussed on stability criteria involving frequency  
14 domain conditions. Let us notice in passing that considering something more than single-valued  
functions in the feedback loop was advocated also by G. Zames in his seminal articles [5], [6],  
16 in which the word “relations” is used to mean set-valued, or multivalued functions.

In the Automatic Control literature, the most popular example of Lur’e systems with a set-valued  
18 nonlinearity in the feedback loop, is that of systems connected with a so-called relay function.  
In this article the name “set-valued signum function” is used instead of “relay function”. It is  
20 defined as  $\text{sgn}: \mathbb{R} \rightarrow [-1, 1]$  with  $\text{sgn}(x) = 1$  if  $x > 0$ ,  $\text{sgn}(x) = -1$  if  $x < 0$ ,  $\text{sgn}(0) = [-1, 1]$ .  
As recalled in “The Set-Valued Signum Function”, the signum multifunction has many important  
22 properties which make it occupy a very specific place in the set of set-valued functions, one of  
these being the maximal monotonicity. It is also noteworthy that the set-valued signum function  
24 lies in the sector  $[0, +\infty]$ , due to its vertical branch at 0. However it is just one example in a much  
bigger family of maximal monotone set-valued static characteristics. Another important class of  
26 set-valued static feedbacks that we shall encounter are normal cones to convex (or non-convex  
but with specific properties) sets. Roughly speaking, normal cones extend the classical notion of  
28 normal subspace, to sets whose boundary is not smooth but possesses “angles”. A very interesting  
property of normal cones to closed convex sets, is that they define a maximal monotone mapping,  
30 hence they can be interpreted as a kind of incrementally passive nonlinearity. As is demonstrated  
on several examples, normal cones occur in a rather natural way in many instances of set-valued  
32 Lur’e systems, because they can be written with complementarity conditions, when the set is  
finitely represented or convex polyhedral. In turn complementarity between two slack variables  
34 is an ubiquitous notion which occurs in many models of physical systems, or through the use  
of Karush-Kuhn-Tucker conditions of Optimization. Examples are given in this article. A major

difference between the sign multifunction and normal cones to sets, is that the latter possess  
 2 a domain that is not the whole state space: it is restricted to the considered (closed, but not  
 necessarily bounded) sets. This may in general introduce additional phenomena like state jumps,  
 4 and variation of the state-space dimension along the system's trajectories, in a manner similar to  
 what occurs in sliding-mode systems, which are well-known in the Automatic Control scientific  
 6 community, or in mechanical systems with unilateral constraints, Coulomb's friction and impacts,  
 when one or more contact points are in a tangential and/or normal sticking mode.

8 In order to help readers who are unfamiliar with the necessary mathematical background, precise  
 definitions of fundamental notions and tools (complementarity conditions, maximal monotonicity,  
 10 convexity, conjugacy, normal and tangent cones, subdifferentiability, semicontinuity of set-  
 valued maps), as well as some useful equivalences which allow one to understand how various  
 12 formalisms are related one to each other, are given in this article, see "Convex Analysis, Maximal  
 Monotone Mappings, Complementarity Theory and Some Useful Tools".

### 14 Preliminary Facts on Set-valued Lur'e Systems

To start with, let us consider the following feedback system, see Figure 1:

$$\begin{cases} (a) & \dot{x}(t) \stackrel{\text{a.e.}}{=} Ax(t) + B\lambda(t) + \bar{B}u(t) \\ (b) & w(t) = Cx(t) + D\lambda(t) + \bar{D}v(t) \\ (c) & \lambda(t) \in -\mathcal{M}(w(t)), \end{cases} \quad (1)$$

16 where all matrices  $A$ ,  $B$ ,  $\bar{B}$ ,  $C$ ,  $D$ ,  $\bar{D}$  are constant of appropriate dimensions,  $\mathcal{M}(\cdot)$  is a  
 maximal monotone mapping (see "Maximal Monotone Mappings" for definitions),  $u(\cdot)$  and  
 18  $v(\cdot)$  are exogenous signals with suitable regularity properties. The signal  $w(\cdot)$  is an output, not  
 necessarily the usual measured output to which Control Scientists and Engineers are used to. In  
 20 the same way, the variable  $\lambda(\cdot)$  is an input, but not the control input (here the control inputs  
 are  $u(\cdot)$  and  $v(\cdot)$ ). At this stage, both  $\lambda$  and  $w$  are to be interpreted as internal variables of  
 22 the system. The a.e. in (1) (a) means almost everywhere, because solutions will usually not be  
 differentiable everywhere (think of absolutely continuous -AC- solutions). In the sequel we shall  
 24 avoid this to lighten the notation.

The feedthrough matrix  $D$  plays a particular role in the dynamics, since it may introduce an  
 26 algebraic loop for  $\lambda(t)$ . Quite formally, using the material in "Useful Equivalences", (1) (b) and

(c) can be rewritten equivalently as:

$$\begin{aligned}
-\lambda(t) \in \mathcal{M}(Cx(t) + D\lambda(t) + \bar{D}v(t)) &\Leftrightarrow \mathcal{M}^{-1}(-\lambda(t)) \ni Cx(t) + D\lambda(t) + \bar{D}v(t) \\
&\Leftrightarrow D(-\lambda(t)) + \mathcal{M}^{-1}(-\lambda(t)) \ni Cx(t) + \bar{D}v(t) \Leftrightarrow (D + \mathcal{M}^{-1})(-\lambda(t)) \ni Cx(t) + \bar{D}v(t) \\
&\Leftrightarrow \lambda(t) \in -(D + \mathcal{M}^{-1})^{-1}(Cx(t) + \bar{D}v(t)).
\end{aligned} \tag{2}$$

2 Inserting the last inclusion into (1) (a), one obtains the differential inclusion:

$$\dot{x}(t) \in Ax(t) - B(D + \mathcal{M}^{-1})^{-1}(Cx(t) + \bar{D}v(t)) + \bar{B}u(t). \tag{3}$$

The term  $v(t)$  plays a particular role in the dynamics. To see this let us notice from (2) that  
4 it can be put in the set-valued mapping as  $-\lambda \in \mathcal{M}(Cx + D\lambda + \bar{D}v(t)) = \mathcal{M}_t(Cx + D\lambda)$ .  
This time-dependency creates additional difficulty for analysis since the new mapping  $\mathcal{M}_t(\cdot)$  is  
6 monotone only for each fixed  $t$ .

Let us clarify the meaning of the operator  $\mathcal{F}(\cdot) \triangleq (D + \mathcal{M}^{-1})^{-1}(\cdot)$  in simple cases. Let us  
8 consider for instance scalar examples,  $D = 1$  and  $\mathcal{M}^{-1}(z) = \text{sgn}(z)$ . Then  $\mathcal{F}^{-1}(z) = (1 + \text{sgn})(z) = z + \text{sgn}(z)$ , and  $\mathcal{F}(x) = (1 + \text{sgn})^{-1}(x)$  is equal to  $x + 1$  if  $x < -1$ ,  $x - 1$  if  $x > 1$ ,  
10 and 0 if  $x \in [-1, 1]$  (inside the brackets, 1 has the meaning of the identity function). Take now  
 $\mathcal{M}^{-1}(\cdot) = \mathcal{N}_{[-1,1]}(\cdot)$ , then  $\mathcal{F}(z) = (1 + \mathcal{N})(z) = z + \mathcal{N}(z)$ , and  $\mathcal{F}^{-1}(x) = (1 + \mathcal{N})^{-1}(x) = -1$   
12 if  $x < -1$ , 1 if  $x > 1$ , and  $x$  if  $x \in [-1, 1]$  (a saturation function). It is clear that in all cases  
both  $\mathcal{F}$  and  $\mathcal{F}^{-1}$  are monotone (and maximal) mappings, but one can be single-valued while the  
14 other one is set-valued, see Figure 2. Actually, and for interested readers, these examples are  
very similar to calculating so-called resolvents of maximal monotone operators [S27].

## 16 Complementarity Dynamical Systems

The class of complementarity dynamical systems is a very important subclass of (1), because  
18 complementarity is itself a widely spread modelling ingredient in various fields: contact  
mechanics, electrical and hydraulical circuits, Nash equilibria, constrained optimisation and KKT  
20 conditions, to name a few. Let us introduce it now. Here  $K \subset \mathbb{R}^m$  denotes a closed convex  
nonempty cone. A linear cone complementarity system (LCCS, or simply LCS when  $K = \mathbb{R}_+^m$ ,  
22 a term coined in [7], [8]) is defined as:

$$\begin{cases}
(a) & \dot{x}(t) = Ax(t) + B\lambda(t) + \bar{B}u(t) \\
(b) & w(t) = Cx(t) + D\lambda(t) + \bar{D}v(t) \\
(c) & K \ni \lambda(t) \perp w(t) \in K^*.
\end{cases} \tag{4}$$

This is of course a strongly nonlinear and nonsmooth system, the term ‘‘linear’’ comes from the  
24 linearity of the ODE part in (4) (a) and (b). One way to interpret LCS is that they are ODEs

subject to a class of nonsmooth nonconvex constraints. Using (29) in “Useful Equivalences”, it is inferred that (4) is equivalently rewritten as:

$$\begin{aligned}
(a) \quad & \dot{x}(t) \in Ax(t) + \bar{B}u(t) - B \mathcal{N}_{K^*}(w(t)) \\
(b) \quad & w(t) = Cx(t) + D\lambda(t) + \bar{D}v(t) \\
(c) \quad & K \ni \lambda(t) \quad (\perp w(t) \in K^*),
\end{aligned} \tag{5}$$

(hence  $\mathcal{M}(w) = \mathcal{N}_{K^*}(w)$ ) which is, in general, a differential inclusion (notice: in all rigor, single-valued terms should be written as singletons  $\{Ax(t)\}$ , etc, however such notation is avoided to lighten the writing). We say “in general”, because depending on  $D$ , it may happen that the right-hand side of (4) (a) is single-valued and Lipschitz continuous. Indeed, let  $D = D^\top \succ 0$ , then using (30) in “Useful Equivalences”, it is inferred that  $\lambda(t) = \text{proj}_D[K; -D^{-1}(Cx(t) + \bar{D}v(t))] = (D + \mathcal{N}_K)^{-1}(-Cx(t) - \bar{D}v(t))$ . Another path when  $K = \mathbb{R}_+^m$  is to use the fundamental result of Complementarity Theory (see Theorem 6 in “Complementarity Problems”), which applies here since positive definite matrices are P-matrices. Inserting this in (5) (a) yields an ODE with Lipschitz continuous right-hand side. Hence, from the point of view of well-posedness, this particular case is solved. Also, initial conditions are not constrained and one may set  $x(0) = x_0 \in \mathbb{R}^n$ . Let us now take  $D = 0$ . Then we obtain

$$\dot{x}(t) \in Ax(t) + \bar{B}u(t) - B \mathcal{N}_{K^*}(Cx(t) + \bar{D}v(t)), \tag{6}$$

where it is remarked in passing that  $\mathcal{N}_{K^*}(\cdot) = \mathcal{N}_K^{-1}(\cdot)$  (this holds because  $K$  is a closed convex cone, see “Normal and tangent cones” in “Some Definitions from Convex Analysis”). The analogy between the general right-hand side in (3), and these particular cases can be made already. Consider now the term  $\mathcal{N}_{K^*}(Cx + \bar{D}v(t)) = \partial\psi_{K^*}(Cx + \bar{D}v(t))$ . The equality  $\psi_{K^*}(Cx + \bar{D}v(t)) = \psi_{\Phi(t)}(Cx)$  with  $\Phi(t) = K^* - \bar{D}v(t)$  holds true. Therefore  $\mathcal{N}_{K^*}(Cx + \bar{D}v(t)) = \mathcal{N}_{\Phi(t)}(Cx)$ , and the differential inclusion in (6) is equivalent to (here equivalence is purely formal until well-posedness has not been stated):

$$\begin{aligned}
& \dot{x}(t) \in Ax(t) + \bar{B}u(t) - B \mathcal{N}_{\Phi(t)}(Cx(t)) \\
& \quad \quad \quad \Downarrow \\
& -\dot{x}(t) + Ax(t) + \bar{B}u(t) = B\lambda(t) \text{ and: } Cx(t) \in \Phi(t), \langle \lambda(t), v - Cx(t) \rangle \geq 0 \text{ for all } v \in \Phi(t),
\end{aligned} \tag{7}$$

where the second formalism is an *evolution variational inequality* (see (30) in “Useful Equivalences”). This differential inclusion has the main feature that its right-hand side involves the normal cone to a convex, time-varying set  $\Phi(t)$ . Classical well-posedness results for differential inclusions [1], [S7], do not apply to (7). Here are the difficulties associated with (7): even if the operator  $z \mapsto \mathcal{N}_{\Phi(t)}(z)$  is maximal monotone for each fixed  $t$ , there is no guarantee that  $z \mapsto \mathcal{N}_{\Phi(t)}(z)$  is a monotone operator when  $t$  varies, and there is no guarantee that  $x \mapsto B \mathcal{N}_{\Phi(t)}(Cx)$  is monotone for each fixed  $t$ . Also boundedness and growth conditions

[S7, section 4.3] [S8, sections 5, 6] do not apply to normal cones, whose domain is equal to  $\Phi(t)$ . A crucial notion for (5) is the *relative degree* between  $w(\cdot)$  (the output) and  $\lambda(\cdot)$  (the input). As is known, passivity constrains the relative degree (or the index for matrix transfer functions [S3, Definition 2.70, Proposition 2.71]) to be -1, 0 or 1. The influence of the relative degree on the system's dynamics, in particular the nature of solutions, is better understood from the zero-dynamics canonical form [S11].

A big step from  $D \succ 0$  to  $D = 0$  is that in (7), initial data are constrained. Indeed what happens if  $Cx(t) \notin \Phi(t)$  at some  $t \geq 0$  (whatever the reason may be) ? This is not tolerated since the normal cone is defined as the empty set for such states. One solution is to impose (to add) a state jump in the dynamics at  $t$ , in order to send back the state into the admissible domain, in a way quite similar to what is commonly done in Impact Mechanics [9]. Without adding further assumptions on  $B$  and  $C$  it is difficult to settle a clear state jump rule. A general solution to this issue may yield quite complex developments which are outside the scope of this article [S11].

*What is to be remembered from this subsection, is that LCCS are an important case of the studied class of set-valued systems, they possess a complex structure, and they are closely related to other formalisms. As seen later, passivity allows to prove their well-posedness in a general setting.*

### Academic examples of ill-posedness

Few academic examples are presented now, which illustrate some specific features of the above nonsmooth systems, and provide motivations for analysing closely conditions which guarantee their well-posedness.

*Example 1:* Let us consider the LCS:

$$\begin{aligned}
 (a) \quad & \begin{pmatrix} \dot{x}_1(t) \\ \dot{x}_2(t) \end{pmatrix} = A \begin{pmatrix} x_1(t) \\ x_2(t) \end{pmatrix} + \begin{pmatrix} b_1(t)\lambda_1(t) + b_2(t)\lambda_2(t) \\ b_3(t)\lambda_1(t) + b_4(t)\lambda_2(t) \end{pmatrix} \\
 (b) \quad & 0 \leq \begin{pmatrix} \lambda_1(t) \\ \lambda_2(t) \end{pmatrix} \perp \begin{pmatrix} -1 & 0 \\ d_{21} & 1 \end{pmatrix} \begin{pmatrix} \lambda_1(t) \\ \lambda_2(t) \end{pmatrix} + \begin{pmatrix} a_1(t) \\ a_2(t) \end{pmatrix} \geq 0.
 \end{aligned} \tag{8}$$

It is assumed that  $a_i(\cdot)$ ,  $b_i(\cdot)$  are continuous functions of time,  $d_{21}$  is a constant,  $A$  is a constant matrix. There always exists a multiplier  $\lambda_2(t)$  which solves  $0 \leq \lambda_2(t) \perp d_{21}\lambda_1(t) + \lambda_2(t) + a_2(t) \geq 0$ , whatever  $a_2(t)$  and  $\lambda_1(t)$ . If  $a_1(t) \geq 0$ , then  $\lambda_1(t) = 0$  is a solution, but if  $a_1(t) < 0$ , there is no  $\lambda_1(t)$  which solves  $0 \leq \lambda_1(t) \perp -\lambda_1(t) + a_1(t) \geq 0$ : the set of solutions to the LCP in (8) (b) is void. Now, assume that  $a_1(t) \geq 0$  for all  $t \in [0, T]$ , and  $a_1(t) < 0$  for all  $t > T$ ,  $T > 0$  (hence  $a_1(T) = 0$ ). On  $[0, T]$  the LCS (8) has a unique solution with  $\lambda_1(t) = 0$  and  $\lambda_2(t)$  solution of  $0 \leq \lambda_2(t) \perp \lambda_2(t) + a_2(t) \geq 0 \Leftrightarrow \lambda_2(t) = \max(0, -a_2(t))$ . If  $d_{21} \neq 0$ , the LCP and consequently the LCS, have no solution on the right of  $t = T$  whatever  $b_i(t)$ . Assume

that  $d_{21} = 0$ ,  $b_1(t) = b_3(t) = 0$  for all  $t > T$ : then the system in (8) (a) can be integrated on  
 2  $(T, +\infty)$ .

*If the LCP matrix is not a P-matrix, the mere existence of solutions to LCS, may depend on  
 4 the exogenous signals acting at both the differential and the nonsmooth constraint parts of the system.*

6 *Example 2:* Let us consider the LCS:

$$\begin{cases} \dot{x}(t) = -x(t) + \lambda(t) \\ 0 \leq \lambda(t) \perp w(t) = x(t) - \lambda(t) \geq 0. \end{cases} \quad (9)$$

Let  $x(0) = -1$ . Then initially  $0 \leq \lambda(0) \perp w(0) = -1 - \lambda(0) \geq 0$ , which has no solution  $\lambda(0)$ :  
 8 this LCS has no continuous-time solution. Let  $x(0) = 1$ . Then initially  $0 \leq \lambda(0) \perp w(0) = 1 - \lambda(0) \geq 0$ , then  $\lambda(0) = 0$  is a solution. The couple  $(x(t), \lambda(t)) = (e^{-t}, 0)$  solves the LCS on  
 10  $[0, +\infty)$ . But  $\lambda(0) = 1$  is also a solution. In this case the couple  $(x(t), \lambda(t)) = (1, 1)$  solves the LCS.

12 *If the LCP matrix is not a P-matrix, the existence and the uniqueness of solutions may depend on the initial conditions.*

14 *Example 3:* It is interesting to note that if an initial state discontinuity is allowed in (9) that makes the state jump from  $x(0^-) = -1$  to  $x(0^+) = 1$ , then one part of the issues (the  
 16 existence) is solved, since the system can be integrated on  $(0, \infty)$ . Therefore state jumps *may* help for the well-posedness (it is noteworthy that in Example 1 state jumps are not of any help).  
 18 Let us consider the LCS:

$$\begin{cases} (a) \quad \dot{x}(t) = -x(t) + \lambda(t) \\ (b) \quad 0 \leq \lambda(t) \perp x(t) \geq 0. \end{cases} \quad (10)$$

Assume that  $x(0) = x_0 \geq 0$ , then the unique global solution to the LCS is the couple  
 20  $(x(t), \lambda(t)) = (x_0 e^{-t}, 0)$ . But if  $x_0 < 0$  the initial state is not admissible and the system cannot be integrated. Allowing for an initial discontinuity that brings  $x(0)$  back into  $\mathbb{R}_+$  on the right  
 22 of  $t = 0$  solves this issue. That sort of extension, however, implies that initially the dynamics cannot be written as in (10). Indeed at  $t = 0$  the state is not differentiable in the usual sense:  
 24 it is the *Dirac measure*  $(x(0^+) - x(0^-))\delta_0$ , and (10) (a) is an equality of measures (*i.e.*,  $\lambda$  also has to be a measure [9, section 1.1]). Let us consider now  $0 \leq \lambda(t) \perp x(t) + a(t) \geq 0$  in  
 26 (10). Suppose that at some time  $t$  the signal  $a(t)$  is discontinuous and jumps to  $a(t^+)$  such that  $x(t) + a(t^+) < 0$ : clearly if  $x(\cdot)$  is continuous at  $t$ , the system cannot be integrated further. But  
 28 if a state jump is allowed which guarantees that  $x(t^+) + a(t^+) \geq 0$ , then the integration may be continued to the right of  $t$  if  $a(\cdot)$  is continuous in a sufficiently large right-neighborhood of  
 30  $t$ . Again at  $t$  the system is no longer a usual differential system but an equality of measures.

Notice that (10) is a particular case of (7) since (10) (b) rewrites equivalently in the latter case:  
2  $\lambda(t) \in -\partial\psi_{\Phi(t)}(x(t))$  with  $\Phi(t) = \mathbb{R}_+ - a(t)$ . The above discussion means that the set  $\Phi(t)$   
may jump so that  $x(t)$  has to “catch-up” with it on the right of  $t$ .

4 *The complementarity constraints and the exogenous signals can prevent solutions to be time-*  
*continuous. State jumps may have to be introduced to keep the existence of solutions. However,*  
6 *the dynamics has then to be interpreted differently because of the presence of measures.*

It is noteworthy also that state jumps are not the cure to any disease. In Example 3, state  
8 jumps allow for unique solutions on the whole of  $\mathbb{R}^+$  (global unique solutions), providing some  
regularity on the data is imposed. Moreove as is seen later, there is a natural way to define  
10 them using right-continuous solutions, from the equivalences (30) in “Useful Equivalences”. In  
Example 2, things are quite different: state reinitializations cannot guarantee the uniqueness of  
12 solutions.

Other cases of ill-posed systems (1) exist, mainly due to the existence of reverse accumulations  
14 of times of non-differentiability: in Mechanics with unilateral constraints, Aldo Bressan’s  
counterexamples of uniqueness due to nonanalycity of data [10]–[12], and in relay systems due  
16 to high relative degree [13] where infinity of solutions may occur. Discontinuity with respect to  
initial data is also a common phenomenon in unilaterally constrained mechanical systems [9]. The  
18 so-called *Painlevé paradoxes* which are singularities occurring in frictional contact mechanics  
[9, section 5.6], are another typical example of ill-posedness (which can nevertheless be solved  
20 by adding some ingredients in the dynamics, and can be justified *via* compliant approximations  
and limits). It belongs to the same family of ill-posed systems as the one in Example 2, with a  
22 state-dependent contact LCP’s matrix that may lose its P-property at certain configurations and  
velocities. The LCP’s well-posedness is then retrieved after so-called *tangential impacts* which  
24 are a specific velocity reinitialization.

**Other Mathematical Formalisms** A detailed presentation of several mathematical formalisms  
26 (maximal monotone differential inclusions, projected dynamical systems, evolution variational  
inequalities, Moreau’s sweeping processes, relay systems, some switching systems) which can  
28 all be interpreted as (1), as well as the relationships between them, is made in [3, sections 2  
and 3] [14], [15].

### 30 **Examples of Applications**

Nonsmooth dynamics as in (1) have been used to model a great diversity of systems, see [3,

section 4] [9], [16] and references therein: electrical circuits with ideal diodes and piecewise-  
 2 linear components (the complementarity approach for such circuits originates from the Dutch  
 school with D.M.W. Leenaerts and W.M.G. van Bokhoven in the 1980s), hydraulic circuits with  
 4 check valves, mechanical systems with unilateral compliant contacts, mechanical systems with  
 unilateral constraints with or without Coulomb’s friction (both originate from the results by J.J.  
 6 Moreau in the 1960s and 1970s), Nash equilibrium seeking algorithms, steepest descent and  
 constrained optimisation through dynamics algorithms, processes with phase changes (mineral  
 8 precipitation-dissolution reactions, thermodynamical systems, chemistry), energy systems, eco-  
 nomical and finance systems and resource allocation (this originates from C. Henry in 1972/1973,  
 10 then A. Nagurney in the 1990s), sparse recovery, cybersecurity investment, microscopic crowd  
 dynamics, plasticity and elastoplasticity (original motivations for Moreau’s sweeping process),  
 12 neural networks, gene regulatory networks, traffic flow networks and transportation systems,  
 set-valued state observers for set-valued systems (apparently initiated in [17], then followed by  
 14 several extensions for Moreau’s sweeping processes of first and second order [18], [19], for  
 passive LCS [20]–[22], or for more general set-valued Lur’e systems [23], [S18], [S21]), robust  
 16 set-valued controllers (extension of first-order sliding-mode control), set-valued homogeneous  
 differentiators, hysteresis models like the play operator and the Duhem model [3, section 3.15],  
 18 piecewise-linear characteristics, systems with set-valued output quantization mappings (filled-in  
 graph approach). Few examples are presented in this section to illustrate the diversity of these  
 20 nonsmooth dynamics. The dynamics of the circuits are obtained applying Kirchhoff voltage and  
 current laws, see [16], [S24] for more examples and details. Let us remind the analogy between  
 22 electric circuits and hydraulic circuits, where check valves are the equivalent of diodes: thus  
 hydraulic circuits with check valves or similar components, belong to the realm of nonsmooth  
 24 mechanical systems. An ideal diode as in Figure 3 (a) is modeled as:  $i_1 \geq 0, u_D \geq 0, u_D i_1 = 0$ ,  
 more compactly  $0 \leq i_1 \perp u_D \geq 0 \Leftrightarrow i_1 \in -\mathcal{N}_{\mathbb{R}_+}(u_D) \Leftrightarrow u_D \in -\mathcal{N}_{\mathbb{R}_+}(i_1)$  (hence the  
 26 mappings  $i_1 \mapsto -u_D$  and  $u_D \mapsto -i_1$  are maximal monotone). Leakages can be introduced as  
 $0 \leq i_1 + a \perp u_D + b \geq 0$ : this is a piecewise-linear approximation of the exponential Shockley  
 28 law [16], and it is a particular case of the complementarity representation of piecewise-linear  
 laws [24], [S23] (similarly to the signum multifunction, see “The Set-Valued Signum Function”,  
 30 and to the force/indentation law in Example 8).

*Example 4:* Let us start with the circuit in Figure 3(a). Its dynamics is given by:

$$\begin{cases} \dot{x}_1(t) = -\frac{3R}{2L}x_1(t) - \frac{1}{2LC}x_2(t) + \frac{1}{2L}\lambda(t) + \frac{1}{L}u_1(t) - \frac{1}{2L}u_2(t) \\ \dot{x}_2(t) = \frac{1}{2}x_1(t) - \frac{1}{2RC}x_2(t) - \frac{1}{2R}\lambda(t) - \frac{1}{2R}u_2(t) \\ 0 \leq \lambda(t) \perp w(t) = \frac{1}{2R}\lambda(t) + \frac{1}{2}x_1(t) + \frac{1}{2RC}x_2(t) + \frac{1}{2R}u_2(t) \geq 0, \end{cases} \quad (11)$$

32 where  $x_1 = i_2$ ,  $x_2(t) = \int_0^t i_3(s)ds$ ,  $\lambda = u_D$  (the voltage across the diode). The analogy with (4)  
 yields  $D = \frac{1}{2R} > 0$ . Therefore the dynamics of this circuit is an ODE with Lipschitz continuous

and single-valued right-hand side (see the developments in the subsection dedicated to LCS),  
 2 despite there is an ideal diode with set-valued voltage/current law inside the circuit.

*Example 5:* Consider the four-diode bridge in Figure 3(b). Its dynamics is given by:

$$\begin{cases} \dot{x}_1(t) = -\frac{1}{C}x_2(t) - \frac{1}{C}\lambda_3(t) + \frac{1}{C}\lambda_4(t) \\ \dot{x}_2(t) = \frac{1}{L}x_1(t) \\ 0 \leq \lambda(t) \perp w(t) = \begin{pmatrix} \frac{1}{R}\lambda_1(t) + \frac{1}{R}\lambda_2(t) - \lambda_3(t) \\ \frac{1}{R}\lambda_1(t) + \frac{1}{R}\lambda_2(t) - \lambda_4(t) \\ \lambda_1(t) \\ \lambda_2(t) \end{pmatrix} + \begin{pmatrix} 0 \\ 0 \\ -x_1(t) \\ x_1(t) \end{pmatrix} \geq 0, \end{cases} \quad (12)$$

4 where  $x_1 = v_L$ ,  $x_2 = i_6$ ,  $\lambda = (-u_{D4}, -u_{D3}, i_1, i_2)^\top$ ,  $w = (i_4, i_3, -u_{D1}, -u_{D2})^\top$ . Other four-  
 diode bridges and other forms of the dynamics may be found in [16], [25], [26]. In (12),

6  $D = \begin{pmatrix} \frac{1}{R} & \frac{1}{R} & -1 & 0 \\ \frac{1}{R} & \frac{1}{R} & 0 & -1 \\ 1 & 0 & 0 & 0 \\ 0 & 1 & 0 & 0 \end{pmatrix} \succeq 0$  possesses a skew-symmetric part (this is also the case for the

different bridges in [16], [26]),  $B = \begin{pmatrix} 0 & 0 & -\frac{1}{C} & \frac{1}{C} \\ 0 & 0 & 0 & 0 \end{pmatrix}$ ,  $C = \begin{pmatrix} 0 & 0 & -1 & 1 \\ 0 & 0 & 0 & 0 \end{pmatrix}^\top$ . Due to the  
 8 structure of  $D$ , this circuit cannot be recast directly into (7) nor into an ODE with Lipschitz  
 right-hand side.

10 *Example 6:* Let us now consider the circuit in Figure 3(c). Its dynamics is given by:

$$\begin{cases} \dot{x}_1(t) = -\frac{R_1}{L_1} \frac{R_1+2R_2}{R_1+R_2} x_1(t) + \frac{1}{L_1} \lambda_1(t) \\ \dot{x}_2(t) = -\frac{R_1+R_3}{L_2} x_2(t) + \frac{R_3}{L_2} x_3(t) \\ \dot{x}_3(t) = \frac{R_3}{L_3} x_2(t) - \frac{R_1+R_3}{L_2} x_3(t) + \frac{1}{L_3} \lambda_2(t) \\ 0 \leq \lambda(t) \perp w(t) = \begin{pmatrix} x_1(t) \\ x_3(t) \end{pmatrix} + \begin{pmatrix} u(t) \\ 0 \end{pmatrix} \geq 0, \end{cases} \quad (13)$$

where  $x_1, x_2, x_3$  are currents through the resistances,  $u(t)$  is a current source,  $\lambda_1$  and  $\lambda_2$  are

12 voltages across the diodes. This time the analogy with (4) yields  $D = 0$ ,  $B = \begin{pmatrix} \frac{1}{L_1} & 0 \\ 0 & 0 \\ 0 & \frac{1}{L_3} \end{pmatrix}$ ,

$C = \begin{pmatrix} 1 & 0 & 0 \\ 0 & 0 & 1 \end{pmatrix}$ . Clearly there exists  $P = P^\top \succ 0$  such that  $PB = C^\top$  (from the Schur

14 complement Theorem, when  $D + D^\top = 0$ , this is implied by the passivity LMI in (28)). The

dynamics can therefore be recast into (6) or (7), with  $K = \mathbb{R}_+^2 = K^*$  and  $\Phi(t) = \mathbb{R}_+^2 - \begin{pmatrix} u(t) \\ 0 \end{pmatrix}$ .

16

Though these circuits may be academic examples, far from complex circuits dynamics, they show that the circuits' topology drastically modifies the type of dynamical system.

*Example 7:* Let us now consider the dynamics of a Levant's arbitrary order exact differentiator with order  $n \geq 1$  [27]:

$$\begin{cases} \dot{x}_0(t) = z_1(t) - \alpha_0 L^{\frac{1}{n+1}} \varphi_0(x_0(t) - v(t)) \\ \dot{x}_1(t) = z_2(t) - \alpha_1 L^{\frac{2}{n+1}} \varphi_1(x_0(t) - v(t)) \\ \dots \\ \dot{x}_{n-1}(t) = z_n(t) - \alpha_{n-1} L^{\frac{n}{n+1}} \varphi_{n-1}(x_0(t) - v(t)) \\ \dot{x}_n(t) \in -\alpha_n L \varphi_n(x_0(t) - v(t)), \end{cases} \quad (14)$$

which aims at calculating the derivatives of  $v : \mathbb{R}_+ \rightarrow \mathbb{R}$ . The constants  $\alpha_i$  and  $L$  are gains, and  $\varphi_i(w) = |w|^{\frac{n-i}{n+1}} \text{sgn}(w)$ . Hence  $\varphi_n(\cdot) = \text{sgn}(\cdot)$  is set-valued while the  $\varphi_i(\cdot)$ ,  $1 \leq i \leq n-1$ , are single-valued (but nonsmooth). More compactly (14) is rewritten as (1) with  $\bar{B} = 0$ ,  $D = 0$ ,

$$x = (x_0, x_1, \dots, x_n)^\top, A = \begin{pmatrix} 0 & 1 & 0 & \dots & 0 \\ 0 & 0 & 1 & 0 & \vdots \\ \vdots & & & & \\ 0 & 0 & \dots & 0 & 1 \\ 0 & 0 & \dots & 0 & 0 \end{pmatrix}, B = \text{diag}(\alpha_i L^{\frac{i+1}{n+1}}) \succ 0, \alpha_i > 0, 0 \leq i \leq n,$$

$L > 0$ ,  $C = \mathbf{e}(1, 0, \dots, 0)$ ,  $\bar{D} = -\mathbf{e}$ ,  $\mathbf{e} = (1, 1, \dots, 1)^\top \in \mathbb{R}^{n+1}$ ,  $\mathcal{M}(w) = (\varphi_0(x_0 - v), \varphi_1(x_0 - v), \dots, \varphi_n(x_0 - v))^\top \in \mathbb{R}^{n+1}$ ,  $\lambda(t) \in \mathbb{R}^{n+1}$ ,  $w(t) \in \mathbb{R}^{n+1}$ . Each mapping  $\varphi_i(\cdot)$  is maximal monotone. Then for each  $w_1 = Cx_1 + \bar{D}v_1 = \mathbf{e}(x_{0,1} - v_1)$ ,  $w_2 = Cx_2 + \bar{D}v_2 = \mathbf{e}(x_{0,2} - v_2)$ ,  $\xi_1 \in \mathcal{M}(w_1)$ ,  $\xi_2 \in \mathcal{M}(w_2)$ , it follows that  $\langle w_1 - w_2, \xi_1 - \xi_2 \rangle = \langle \mathbf{e}(x_{0,1} - v_1 - x_{0,2} + v_2), \xi_1 - \xi_2 \rangle = \langle (x_{0,1} - v_1 - x_{0,2} + v_2), \mathbf{e}^\top(\xi_1 - \xi_2) \rangle = \sum_{i=0}^n (x_{0,1} - v_1 - x_{0,2} + v_2)(\xi_{1,i} - \xi_{2,i})$ , where  $\xi_{j,i} \in \varphi_i(x_{0,j} - v_j)$ ,  $j = 1, 2$ ,  $0 \leq i \leq n$ . Thus for each  $i$ :  $(x_{0,1} - v_1 - x_{0,2} + v_2)(\xi_{1,i} - \xi_{2,i}) \geq 0$  and it is inferred that  $\langle w_1 - w_2, \xi_1 - \xi_2 \rangle \geq 0$ : the mapping  $\mathcal{M} : \mathbb{R}^{n+1} \rightrightarrows \mathbb{R}^{n+1}$  is monotone.

*Example 8: (Contact Mechanics)* (i) Mechanical systems with unilateral springs at contact points  $i$ : the force/indentation characteristic of each spring is locally at the contact point  $i$  given by  $\lambda_i = \max(0, k_i x_i) \Leftrightarrow 0 \leq \lambda_i \perp \lambda_i - k_i x_i \geq 0$ , where  $x_i$  is the local indentation (the spring deformation),  $k_i$  is the contact stiffness. This formulation extends to unilateral spring-dashpot contacts [9], [S24]. It shows that complementarity is not restricted to rigid bodies, but just models a contact force/signed distance constraint. (ii) Planar Coulomb's friction in multibody Lagrangian systems lends itself well to an interpretation as Lur'e set-valued systems [9, sections 5.5.1, 5.5.2] [28], using the virtual displacements principle and the chain rule. (iii) Moreau's second order sweeping process (which models frictionless Lagrangian complementarity systems with measure differential inclusions, see below) has a natural interpretation as a Lur'e set-valued system [9, Fig. 7.6] [29] [S3, section 6.8.2].

*Example 9:* As a last example let us briefly introduce *projected dynamical systems* with the dynamics in (13) (PDS is a formalism used in Nash equilibria seeking [56], more generally in mathematical economy for which it was introduced). Let  $u(t) = 0$  for all  $t \geq 0$ . Using [14], [15] (see also [3, sections 2.5 and 3.8]) it follows that (13) is equivalent to:

$$\dot{x}(t) = \text{proj}[\mathcal{T}_K(x(t)); Ax(t)] = Ax(t) - \mathcal{N}_{\mathcal{T}_K(x(t))}(\dot{x}(t)), \quad (15)$$

where  $x = (x_1, x_2, x_3)^\top$ ,  $K = \{x \in \mathbb{R}^3 \mid \frac{1}{L_1}x_1 \geq 0, \frac{1}{L_3}x_3 \geq 0\}$ ,  $A \in \mathbb{R}^{3 \times 3}$  is the transition matrix. Tangent and normal cones are defined in “Normal and tangent cones”. It is noteworthy that the right-hand side in (15) is, in general, set-valued. There are other, equivalent forms of the dynamics which not recalled here. The implicit form in (15) is a direct consequence of (30). It is noteworthy that equivalency means here it means equality of the right-hand sides.

**State Jumps and Measure Differential Inclusions** As alluded to above, it may be necessary in some instances to introduce state discontinuities, and this modifies the way the dynamics has to be interpreted. This has been long well-known in nonsmooth mechanics [9] where velocity jumps correspond to impacts, and this is also true in nonsmooth circuits where state jumps can be physically explained [30]. The state discontinuity phenomenon is closely related to *measures*, functions of *bounded variation*, and *measure differential inclusions* (MDI), see “Functions of Bounded Variation” for an introduction. According to J.J. Moreau who introduced it in [S12], an MDI is an inclusion of measures stemming from BV functions, *i.e.*, given an RCLBV function  $x(\cdot)$ , its associated differential measure  $dx$ , a vector field  $f(\cdot, \cdot)$ , and the normal cone to a closed nonempty set  $K(t)$  (convex for each  $t$ ), the *first-order sweeping process* is given by:

$$dx - f(t, x(t))dt \in -\mathcal{N}_{K(t)}(x(t)), \quad x(t) \in K(t) \text{ for all } t \geq 0. \quad (16)$$

Without going into deep details on MDIs, which contain some subtleties due to the mere notion of the differential measure of an RCLBV function, let us just state that the meaning of the MDI in (16) is that solutions evolve along the ODE  $\dot{x}(t) = f(t, x(t))$  between jump times and when  $x(t)$  is in the interior of  $K(t)$ ,  $\dot{x}(t) = f(t, x(t) + \lambda(t))$  for some  $\lambda(t) \in -\mathcal{N}_{K(t)}(x(t))$  when  $x(t)$  is on the boundary of  $K(t)$ , and  $x(t^+) - x(t^-) \in -\mathcal{N}_{K(t^+)}(x(t^+))$  at jump times: this is called a *generalized equation*, and it defines the jumps automatically when this is necessary; it can be solved following the equivalences in (30) in “Useful Equivalences”, resulting in  $x(t^+) = \text{proj}[K(t^+); x(t^-)]$ . An alternative, equivalent formulation, uses densities with respect to a nonnegative base measure (densities are functions of time, a kind of extension of the usual derivative) [S9], and is more amenable for stability analysis [23], [29], [S18]. The set of jump times is countable, right accumulations of jumps may exist (Zeno phenomenon), trajectories may evolve inside and on the boundary of  $K(t)$ , the elements of  $\mathcal{N}_{K(t)}(x(t))$  are measures  $\lambda$  (denoted also  $d\lambda$ ). One usual difficulty in the understanding of (16) is the calculation of  $\lambda$  on

the boundary of  $K(t)$ , see [3, sections 2.4.1 and 3.4] for details in the case of LCCS, with the use of lexicographical inequalities (which are ubiquitous in unilaterally constrained systems [9]). For deeper mathematical introductions and extensive bibliography, see [3], [S9], [S11], [S12].

*It is noteworthy that an MDI is not a mere ODE with state jumps. First, its state is unilaterally constrained. Second it may evolve on reduced-dimension state-space along the solutions. Third its dynamics may have jumps (which are defined intrinsically by the MDI). Fourth the multiplier  $\lambda$  acts in the dynamics to modify the vector field when the boundary  $\text{bd}(K(t))$  is attained. Fifth the continuation of the solutions to the right of jump-times left-accumulations, is incorporated in it (thanks to the multiplier that can be viewed as a sort of “contact force”). Thus, this is a powerful compact formalism that encapsulates all modes of motion, and paves the way for numerical simulation, stability analysis and control.*

Clearly the DI in (7) could be embedded into an MDI as (16), if BV solutions are sought, and provided some transformations are done. This is the object of Proposition 1 and Theorem 3 below. A generalized supply rate using densities associated with MDIs is introduced in [S3, p.500] [9], [29], [31].

## Well-posedness Analysis

**Maximal monotonicity and Passivity** Actually one major conclusion from [29] is that a passive system as defined in “Dissipative (Passive) Systems” (an SPR system with no feedthrough matrix is studied in [29]) in negative feedback interconnection with a maximal monotone operator, defines another maximal monotone operator. In terms of (1), this means: let  $u(t) = 0$ ,  $v(t) = 0$ ,  $D = 0$ ,  $C(sI_n - A)^{-1}B$  is an SPR transfer matrix and  $(A, B, C)$  is minimal, and  $\mathcal{M}(\cdot) = \partial\varphi(\cdot)$ , where  $\varphi(\cdot)$  is a proper convex lsc function. Then the operator  $x \mapsto -Ax + B\partial\varphi(Cx)$  is maximal monotone (provided some basic conditions are verified so that the chain rule of Convex Analysis applies, see Theorem 5 in “Chain Rules”). Actually SPRness is not necessary (it was assumed in [29] for stability purpose) as shown now. Let the LMI in (28) hold with  $P = P^\top \succ 0$ ,  $D = 0 \Rightarrow PB = C^\top$ , and  $-PA - A^\top P = Q$  with  $Q \succeq 0$  (minimal realisations  $(A, B, C)$  with PR transfer matrix verify this by the standard Kalman-Yakubovich-Popov Lemma). Let us consider  $R = R^\top \succ 0$ ,  $R^2 = P$ , and  $z = Rx$ . The dynamics in (1) is rewritten equivalently as  $\dot{z}(t) \in RAR^{-1}z(t) - RB\partial\varphi(CR^{-1}z(t))$ . Now  $RB = R^{-1}PB = R^{-1}C^\top$ , thus  $\dot{z}(t) \in RAR^{-1}z(t) - R^{-1}C^\top\partial\varphi(CR^{-1}z(t))$ . Assume now that  $\text{Im}(C)$  ( $= \text{Im}(B^\top P) = B^\top \text{Im}(P) = B^\top \mathbb{R}^n = \text{Im}(B^\top)$ )  $= \mathbb{R}^m \Leftrightarrow \text{Ker}(C^\top) = \{0\} = \text{Ker}(PB) = \text{Ker}(B)$ . The chain rule applies (see Theorem 5 in “Chain Rules”) and  $\dot{z}(t) \in RAR^{-1}z(t) - \partial f(z(t))$ , with  $f = \varphi \circ CR^{-1}$ . The function  $f(\cdot)$  is proper convex lsc so  $z \mapsto \partial f(z)$  defines a maximal

monotone operator. Using  $-RAR^{-1} - R^{-1}A^\top R = R^{-1}QR^{-1} \succeq 0 \Rightarrow -RAR^{-1} \succeq 0$ , the operator  $z \mapsto -RAR^{-1}z + \partial f(z)$  is maximal monotone by [S27, Corollary 24.4], and so is  $x \mapsto -Ax + B\partial\varphi(Cx)$  (using symmetry of  $R$  and monotonicity preserving of the sum). It is noteworthy that if the triple  $(A, B, C)$  is minimal SPR with  $\text{Ker}(B) = \{0\}$ , then the operator is *strongly* monotone. Indeed in that case,  $Q = 2\mu P$  for some  $\mu > 0$  [S3, Lemma 3.16] [32], so that  $-RAR^{-1} \succ 0$ . In the above reasoning the subdifferential  $\partial\varphi(\cdot)$  can be replaced by any maximal monotone operator  $\mathcal{M}(\cdot)$ , provided that the transformation preserves the maximality (it does preserve the monotonicity). Thus the following is proved.

*Proposition 1:* Assume that the triple  $(A, B, C)$  is minimal and  $C(sI_n - A)^{-1}B$  is a PR (resp. SPR) transfer matrix, with  $\text{Im}(C) = \mathbb{R}^m$ . Let  $\varphi : \mathbb{R}^n \rightarrow \mathbb{R} \cup \{+\infty\}$  be convex proper lsc. Then the negative-feedback operator  $x \mapsto -Ax + B \partial\varphi(Cx)$  is maximal monotone (resp. strongly maximal monotone).  $\square$

*Remark 1:* It is noteworthy that despite of the fact that  $D + D^\top = 0$  implies from (28) that  $PB = C^\top$ , the above manipulations do not hold straightforwardly in case  $D \neq 0$ . Feedthrough matrices with a nonzero skew-symmetric part play an important role in these systems, just as they do in LCPs.

The extension of Proposition 1 is nontrivial and is as follows:

*Theorem 1:* [26, Theorems 2 and 3] Suppose that:

- 1)  $(A, B, C, D)$  is a passive quadruple with  $P \succ 0$ ,
- 2)  $\mathcal{M}(\cdot)$  is maximal monotone,
- 3)  $\text{Im}(C) \cap \text{rint}(\text{Im}(\mathcal{M}^{-1} + D)) \neq \emptyset$ .

Then the negative-feedback operator  $H : x \mapsto -Ax + B(D + \mathcal{M}^{-1})^{-1}(Cx)$  is maximal monotone.  $\square$

*Proof (sketch)* The proof is based on a characterization of maximal monotone operators provided in [33]. Monotonicity follows from the passivity, using the LMI (28) in “Dissipative (Passive) Systems”. Maximality is the hardest part. First the maximal monotonicity of  $(D + \mathcal{M}^{-1})(\cdot)$  holds due to  $D \succeq 0$  from passivity (item 3 in “Dissipative (Passive) Systems”). This together with property in item 2 in “Dissipative (Passive) Systems”, are used to prove the convexity of some sets (like the sets  $H(\xi)$  for all  $\xi \in \text{dom}(H)$ ) as well as inclusions. Finally using passivity and maximal monotonicity of  $(D + \mathcal{M}^{-1})(\cdot)$ , the closedness of the graph of  $H(\cdot)$  is shown.  $\square$

This was proved in [26] in a finite-dimensional setting, extended in Hilbert and Banach spaces

infinite-dimensional setting in [34], [35]. These results add to the few operations which preserve  
 2 the maximal monotonicity.

**Lack and Excess of Passivity and of Monotonicity, loop transformations** Each one of the  
 4 two subsystems in Figure 1 may have a lack or an excess of passivity and of monotonicity,  
 respectively. In case of SPRness in Proposition 1, can the excess of passivity of  $(A, B, C)$  be  
 6 used to cope with hypomonotone mappings, for which  $\mathcal{M} + \alpha I_n$  is maximal monotone for  
 some  $\alpha > 0$ ? The results in [18, Lemma 4.1, Corollary 4.1] (see also [S3, Lemma 3.166,  
 8 Corollary 3.167]) bring an answer when  $\mathcal{M}(\cdot) = \mathcal{N}_K(\cdot)$  with  $K$  an  $r$ -prox-regular set, in terms  
 of existence of an AC solution. Instead [S18, Theorem 3.2] deals with Lyapunov stability. In  
 10 both cases the parameter  $r$  is used to play with the lack/excess of passivity. Reversedly, strong  
 monotonicity can compensate for a lack of passivity: take  $(A, B, C, D) = (0, B, B^\top, -I_n)$ , which  
 12 is not passive, and  $\mathcal{M}^{-1}(w) = \mathcal{N}_K(w) + 2w$ ,  $K$  closed convex nonempty. Then the operator  
 $-A + B(\mathcal{M}^{-1} + D)^{-1}C = B(\mathcal{N}_K + I_n)^{-1}B^\top$  is maximal monotone. Basic loop transformations  
 14 may be applied to (1) to interpret these lack/excess of passivity and monotonicity, see [S3,  
 section 3.14.2.4, Figure 3.16].

16 *Example 10:* An interesting example of hypomonotonicity for Control Engineers and  
 Scientists, is Coulomb's friction and Stribeck effect (which can be approximated with a  
 18 piecewise-linear curve [3, Figure 4.4 (b)] and Figure 5 (d)). The tangential contact force  $F_t$   
 writes as:

$$F_t(\dot{x}(t)) = - \underbrace{F_n(\mu_s - \mu_c) \left( \exp\left(-\frac{\dot{x}^2(t)}{v_s^2}\right) - 1 \right) \text{sgn}(\dot{x}(t))}_{F_{diff}(\dot{x})} - \underbrace{\mu_s F_n \text{sgn}(\dot{x}(t))}_{F_{sv}(\dot{x}(t))}, \quad (17)$$

20 where  $\mu_s > \mu_c > 0$ ,  $v_s$  are parameters,  $F_n > 0$  is the constant normal contact force. The  
 total force is therefore the sum of a continuously differentiable, Lipschitz continuous, monotone  
 22 decreasing term  $F_{diff}(\dot{x})$ , and a set-valued maximal monotone term  $F_{sv}(\dot{x})$ . Thus the mapping  
 $v \mapsto F_{diff}(v) + F_{sv}(v)$  is hypomonotone. In Electronics, common models of DIAC, silicon  
 24 controller rectifiers, tunnel diodes, Chua's diodes, also possess hypomonotone voltage/current  
 laws.

26 Prox-regularity can be interpreted as some kind of local convexity, or local sectoricity [S18,  
 section 3.1.3], and as a lack of monotonicity (see "Prox-regularity" in "Maximal Monotone  
 28 Mappings"). The input/output constraint  $PB = C^\top$  (implied by passivity, see "Dissipative  
 (Passive) Systems") is used in [S18, Theorems 2 and 5] to show the well-posedness when  
 30 the set-valued mapping is prox-regular. Many more combinations and loop transformations may  
 certainly be applied to Lur'e systems (1), and this remains a largely open field. For instance  
 32 it is known that a saturation function (Lipschitz continuous) can be realised from a set-valued

signum in negative feedback with a constant gain [9, Remark 2.8] (this is a particular case of a mapping  $u \mapsto (D + \mathcal{M}^{-1})^{-1}(u)$  which is single-valued well-defined Lipschitz continuous when  $D \succ 0$  and  $\mathcal{M}(\cdot)$  is maximal monotone). Does this mean that loop transformations can transform a set-valued system into a single-valued one ? To end this short section let us also mention the application of dynamic Zames-Falb multipliers approach in [36] to relax conservativeness of [29], as well as extensions of the circle criterion to set-valued Lur'e systems [37].

**Existence and Uniqueness of Solutions** This section is dedicated to show how passivity may be used to prove the well-posedness of set-valued systems which belongs to the class in (1). If the conditions of Proposition 1 are verified, and provided that  $z(0) \in \text{dom}(f) \Leftrightarrow Cx(0) \in \text{dom}(\varphi)$ , the set-valued system has a unique absolutely continuous solution from [2, Theorem 3.1]. The same holds as a consequence of Theorem 1. Let us now present two results which rely on passivity to prove the well-posedness of LCS as in (4), with  $K = \mathbb{R}_+^m$ , and with time-varying terms. It is indeed not obvious in general to consider time-varying set-valued functions  $\mathcal{M}_t(\cdot)$ , even if they are maximal monotone for each fixed  $t$  (like normal cones to varying convex sets as in (7)) [3, section 2.2]. In particular the term  $v(t)$  plays a specific role in (1) since it intervenes inside the set-valued function. One major conclusion of the next two theorems, is that passivity of  $(A, B, C, D)$  prevents from higher degree distributions to occur in such systems. Only Dirac measures can occur as a consequence of state jumps.

*Theorem 2:* [38, Theorem 7.5] Consider the LCS (4) with  $K = \mathbb{R}_+^m$ . Assume that  $(A, B, C, D)$  is minimal and passive with storage function matrix  $P = P^\top \succ 0$ , and that  $\begin{pmatrix} B \\ D + D^\top \end{pmatrix}$  has full column rank. Then for any functions  $u(\cdot)$  and  $v(\cdot)$  which are piecewisely continuous with rational Laplace transform, and any initial state  $x(0) = x_0$ , there exists a unique global solution with  $(\lambda, x, w) \in \mathcal{L}_{2,\delta}(\mathbb{R}_+; \mathbb{R}^{m \times n \times m})$ , where  $\mathcal{L}_{2,\delta}$  is the set of Schwartz' distributions with  $\mathcal{L}_2^{loc}$  locally square integrable regular parts and whose measure atomic part (sum of Dirac measures) has isolated atoms, whose set is included in the set of discontinuity times of  $v(\cdot)$ .  $\square$

*Proof (sketch of):* So-called rational complementarity problems (RCP), which are a tool to study the LCS dynamics in the Laplace transform space, hence getting an algebraic LCP representation of the LCS [39], [40], are proved to be well-posed using passivity: the RCP matrix is the transfer matrix  $D + C(\sigma I_n - A)^{-1}B$  which is positive definite for large enough  $\sigma$ , thanks to passivity (see structural property 5 in ‘‘Dissipative (Passive) Systems’’). They are used to show the local existence to LCS. The global existence is proved by using a ‘‘hybrid’’, or ‘‘event-driven’’ approach: using a careful characterisation of state jumps and of the integration of the LCS without jumps in  $v(t)$ , the trajectories are integrated between two state jumps, and then concatenated. The

uniqueness hinges on the positive definiteness of  $P$  and semi definiteness of  $D$ , guaranteed by passivity. It holds for  $x(\cdot)$ ,  $\lambda(\cdot)$  and  $w(\cdot)$ . It is noteworthy that the dynamics is understood as an equality of measures, though the framework of measure differential inclusions is not used.  $\square$

Theorem 2 has its roots in [41] where passivity and RCPs were used for the first time. It was extended in [25] where the main assumptions (minimality and the rank condition) are relaxed, as well as in [42, Theorem 20]. Passivity is relaxed to passifiability by pole shifting in [38, Theorem 10.3], hence extending the scope of Theorem 2. The main limitation of the approach in [25], [38] is that RCPs are restricted to linear ingredients in (1) (a) and (b). The next result treats the problem with  $D = 0$  but with AC and BV functions. It differs significantly from [38, Theorem 7.5]. As such it admits an extension to the nonlinear case [31, Theorems 4.3 and 4.4].

*Theorem 3:* [31, Proposition 3.2, Theorem 3.5] Let us consider the LCCS in (4), with  $D = 0$ ,  $K = \{\lambda \in \mathbb{R}^m \mid M\lambda \geq 0\}$ ,  $M \in \mathbb{R}^{m \times m}$ ,  $u(\cdot) \in \mathcal{L}_1^{loc}(\mathbb{R}_+; \mathbb{R}^q)$  and  $v(\cdot) \in \mathcal{L}_1^{loc}(\mathbb{R}_+; \mathbb{R}^p)$ . Assume that  $\text{Im}(C) - \mathbb{R}_+^m = \mathbb{R}^m$ , and there exists  $P = P^\top \succ 0$  such that  $PB = C^\top$ . Let us define  $R = R^\top \succ 0$ ,  $R^2 = P$ , and the sets  $\Phi(t) = \{x \in \mathbb{R}^n \mid Cx + \bar{D}v(t) \in K\} = \{x \in \mathbb{R}^n \mid M(Cx + \bar{D}v(t)) \geq 0\}$ , and  $S(t) = \{Rx \mid x \in \Phi(t)\}$ , both supposed to be nonempty for all  $t \geq 0$ . Then: 1) the closed convex set-valued mapping  $S(\cdot)$  is right-continuous (resp. locally AC, resp. LBV), whenever the function of time  $v(\cdot)$  is right-continuous (resp. locally AC, resp. LBV). 2) The set-valued system with initial condition  $x(0) \in \Phi(0)$  possesses a unique locally AC (resp. RCLBV) solution whenever  $S(\cdot)$  is locally AC (resp. RCLBV).  $\square$

*Proof (sketch of):* the proof consists of three main ingredients: 1) use a state-space transformation  $z = Rx$  that recasts the LCS into Moreau's sweeping process, starting from (7), proceeding similarly to the proof of Proposition 1, 2) use a result by Robinson on the Hausdorff distance between convex cones, 3) use existence and uniqueness of solutions to the first-order sweeping process with AC and with BV solutions. In case of BV solutions it is necessary to interpret the dynamics as a measure differential inclusion in a similar way to (16).  $\square$

Clearly the major property that is used in Theorem 3, is the passivity input/output constraint  $PB = C^\top$  (which is verified by (13), see further circuit examples in [9], [16], [S3], [S15]). After the publication of [29] this property was used in several studies, see, e.g., [17], [20], [21], [23], [28], [43]–[48], [S18], [S21] for various applications of interest in Automatic Control (fixed points calculation, stability, observers design, tracking control, see also [3, section 3.4]). Obviously the passivity as stated above, is sufficient but not necessary for the well-posedness, as shown in the next proposition (see also Example 15).

*Proposition 2:* Consider (1). Assume that  $D \succ 0$  and  $\mathcal{M}(\cdot)$  is maximal monotone. Then

the right-hand side of (1) (a) is well defined, single-valued and Lipschitz continuous in  $x$ ,  $v(\cdot)$  and  $u(\cdot)$ .  $\boxtimes$

*Proof:* Hence  $\mathcal{M}^{-1}(\cdot)$  is maximal monotone. It follows from [S21, Proposition 1] that the operator  $(D + \mathcal{M}^{-1})^{-1}(\cdot)$  is well defined, single-valued and Lipschitz continuous with constant  $\frac{2}{\lambda_{\min}(D+D^\top)}$ .  $\boxtimes$

Strict passivity implies  $D \succ 0$  but not the reverse. Several extensions of Theorems 2 and 3 have been studied, which all use passivity or one of its structural properties (see “Dissipative (Passive) Systems”):

- When  $D = \text{blockdiag}(\bar{D}, 0)$  with  $\bar{D} \succ 0$  and the mapping  $\mathcal{M}(\cdot) = \partial\varphi(\cdot)$  for some convex, proper lsc function  $\varphi(\cdot)$  [S21] (two typical examples being  $\varphi(w) = \psi_K(w)$  –LCCS– and  $\varphi(w) = \sum_{i=1}^m |w_i|$  –relay systems [13], [63]–).

*Remark 2:* Let us deal with relay systems, with  $\mathcal{M}(w) = \text{Sgn}(w)$  (see “The Set-Valued Signum Function”) in (1). Can this always be analysed *via* Filippov’s convexification of a discontinuous function (see item 3 in “The Set-Valued Signum Function”), a tool largely used in the Automatic Control scientific community ? The presence of nonzero matrix  $D$  prevents such interpretation in general relay systems.

- When  $D \succeq 0$  and  $\text{Ker}(D + D^\top) \subseteq \text{Ker}(PB - C^\top)$  [23], [26], [42], [64], [65], that is a structural property verified by passive systems, see “Dissipative (Passive) Systems”. Let us present the main result in [23], which is presented here for the case of LCCS but holds for a more general class in [23, Theorem 1].

*Theorem 4:* [23, Corollary 2] Consider (4) with  $K$  a closed convex nonempty polyhedral cone. Assume that  $v : \mathbb{R}_+ \rightarrow \mathbb{R}^p$  is Lebesgue-measurable. Define  $S(t) = \{z \in \mathbb{R}^p \mid z + v(t) \in K^*\}$ . Assume that: **a)**  $D \succeq 0$  and there exists  $P = P^\top \succ 0$  such that  $\text{Ker}(D + D^\top) \subseteq \text{Ker}(PB - C^\top)$ , **b)**  $u(\cdot)$  is locally essentially bounded, **c)** the cone  $K$  and the matrix  $D$  satisfy  $\text{rint}(K^* - \bar{D}v(t)) \subseteq \text{rint}(\text{Im}(\partial\sigma_{K^* - \bar{D}v(t)} + D))$  and  $DK \subseteq \text{Im}(C)$ , **d)**  $\text{Im}(C) - K^* = \mathbb{R}^m$ , **e)** For each  $x \in \mathbb{R}^n$  and  $t \geq 0$ , if the set  $\Gamma_x = \{\lambda \in K \mid w = Cx + D\lambda + \bar{D}v(t) \in K^*, \langle \lambda, w \rangle = 0\}$  has a nonzero element, then  $\Gamma_x \cap \text{Im}(D + D^\top) \neq \emptyset$ .

Then, if  $v(\cdot)$  is locally AC (resp. RCBV), there exists a unique weak solution to (4) which is continuous (resp. RCBV).  $\boxtimes$

Weak solutions are limits of strong solutions of a sequence of approximated systems (there is a typo in the second part of [23, Definition 1], where “(1)” has to be replaced by the unnumbered DI:  $\dot{z}_{i+1}(t) \in -\Psi(t, z_{i+1}) + g(t, z_i(t))$  [23, p. 765]). For the sake of brevity the sketch of the proof of Theorem 4 is not provided here. The meaning of assumptions **c)** **e)** is explained in [23]. The rank condition **d)** is similar to those in Proposition 1, Theorems

2 and 3. It is worth noting that the main progress of Theorem 4 over Theorem 2, is taking into account the nonzero term  $v(t)$  inside the set-valued feedback function.

- When one of the two subsystems lacks of passivity (hypomonotone set-valued mapping [49] [S3, section 3.14.2.4], subdifferential of a prox-regular function [S18, Theorems 2 and 5]).
- When nonlinearities are present: nonlinear operator  $A(x)$  [49], nonlinear  $w(x, v(t))$  and nonlinear smooth dynamics linear in  $\lambda$  [31], Lagrangian systems with set-valued robust controllers [50], [51] or with Coulomb's friction, Moreau's second order sweeping process [52] [9, Chapter 5]. For Lagrange systems the generic dynamics is as follows:

$$\begin{cases} M(q)\dot{\sigma} + C(q, \dot{q})\sigma + G(t, q, \sigma) = H(t, q, \sigma)\lambda \\ \lambda \in -\mathcal{M}(t, q, \sigma), \end{cases} \quad (18)$$

where the set-valued term  $\mathcal{M}(q, \sigma)$ , the ‘‘Jacobian’’ matrix  $H(t, q, \sigma)$ , the conservative forces and the uncertainties  $G(t, q, \sigma)$ , the signals  $\sigma$  and  $\lambda$ , can take various forms and possess different meanings, depending on the analysed problem (second order sweeping process with BV velocities [3], [9], [52], [S9], robust sliding-mode control [50], [51], state observers [19]). The common feature between all cases is that the operator  $\tau \triangleq H(t, q, \sigma)\lambda \mapsto \sigma$  is passive, and  $-\lambda \mapsto \mathcal{M}(t, q, \sigma)$  is maximal monotone.

- Robust control with matched and unmatched uncertainties [53], [S16].
- When the mapping  $\mathcal{M}(\cdot)$  is a general maximal monotone operator as in Theorem 1 [26],
- When (1) (a) is  $E\dot{x}(t) = Ax(t) + B\lambda(t) + \bar{B}u(t)$  with  $E$  singular (descriptor variable system, which are common in circuits and mechanics), and the quintuple  $(E, A, B, C, D)$  is passive [54].
- In the infinite-dimensional setting of Hilbert and Banach spaces [34], [35].
- For LCS with higher relative degree between  $w$  and  $\lambda$ , where solutions are Schwartz' distributions of higher degree (derivatives of the Dirac measure) [S11].
- In the discrete-time setting: preservation of passivity after discretisation of LCS [57] (the difficulty is to treat both ODE dynamics and state jumps), boundedness and convergence of discrete-time solutions for discretised uncertain Lagrangian systems and set-valued control [50], [51], and for linear systems with unmatched nonlinear bounded uncertainties [53], boundedness and convergence of discrete solutions of state observers for Lagrangian complementarity systems [19]. The difficulty encountered in [50], [51] (and also in [53]) is that the mapping  $M^{-1}(q)H(t, q, \sigma)\mathcal{M}(t, q, \sigma)$  stemming from (18) is not necessarily maximal monotone. Specific analysis for well-posedness and for discretisation study have to be done.

**Monotonicity, Passivity and Incremental Passivity** As reminded in ‘‘Maximal Monotone Mappings’’, a monotone mapping  $\mathcal{M}(\cdot)$  is an incrementally passive static nonlinearity, and

it is also equilibrium independent passive. Also if  $(0,0)$  belongs to the graph of  $\mathcal{M}(\cdot)$  (i.e.,  $0 \in \mathcal{M}(0)$ ), then  $\mathcal{M}(\cdot)$  defines a passive mapping which verifies a sectoricity condition. It is inferred that in this case Proposition 1 and Theorem 1 analyse the interconnection of two passive (a dynamical and a static) mappings [S3, Proposition 5.17]. Furthermore, passive linear systems are incrementally passive [55]. Hence Proposition 1 and Theorem 1 analyse the interconnection of two incrementally passive systems. It is noteworthy that the *maximality* is not needed for passivity interpretations of the closed-loop system, but it is a fundamental property for the existence of solutions since it guarantees the outer semicontinuity. Monotonicity and passivity play a crucial role for stability purpose. A nice study that mixes monotonicity, incremental passivity and equilibrium independent passivity, can be found in [56] for Nash equilibrium seeking issues. Popov-like criterion for Lur'e set-valued systems are derived in [20, Theorem 4.1] (using dynamic Popov multipliers with transfer function  $I + \Gamma s$ ,  $s \in \mathbb{C}$  and a time-domain analysis) and in [4] (using a frequency-domain analysis). Both works mainly deal with “relay-like” set-valued nonlinearities which verify property 11 in “The Set-Valued Signum Function”. See also [29], [36], [37].

*Under the stated sufficient conditions for their well-posedness, the set-valued Lur'e systems analysed in this article are incrementally passive, or even passive if the origin belongs to their graph. Consequently all stability results and criteria that apply to passive feedback interconnections with a static nonlinearity in the sector  $[0, +\infty]$ , apply to them.*

**Well-Posed Time-stepping Event-capturing Numerical Schemes** Let us provide in this section a brief overview of the usefulness of passivity for the numerical analysis of set-valued systems (1). In a discrete-time setting, the Lur'e set-valued systems boil down to a generalized equation to be solved for each step  $k \geq 1$ . Indeed let us consider the implicit Euler version of (1), where  $h > 0$  is the timestep, the integration interval is  $[0, T]$ ,  $T > 0$ ,  $h = \frac{T}{n}$ ,  $n \in \mathbb{N} \setminus \{0\}$ ,  $k \in \{0, \dots, n\}$ :

$$\begin{cases} (a) & 0 = x_k + (hA - I_n)x_{k+1} + hB\lambda_{k+1} + h\bar{B}u_k \\ (b) & w_{k+1} = Cx_{k+1} + D\lambda_{k+1} + \bar{D}v_k \\ (c) & \lambda_{k+1} \in -\mathcal{M}(w_{k+1}), \end{cases} \quad (19)$$

which has to be satisfied for all  $k \geq 0$ , with unknowns  $x_{k+1}$ ,  $\lambda_{k+1}$ ,  $k \geq 0$ . It implies:

$$\lambda_{k+1} \in -[hC(I_n - hA)^{-1}B + D + \mathcal{M}^{-1}]^{-1}(C(I_n - hA)^{-1}x_k + hC(I_n - hA)^{-1}\bar{B}u_k + \bar{D}v_k), \quad (20)$$

which is the discrete-time counterpart of the last inclusion in (2), which is recovered letting  $h \rightarrow 0$ . Passivity preservation after discretization with same storage functions, supply rate and dissipation function holds only under quite stringent conditions [57]. Another, perhaps more interesting objective, is to analyse consequences of passivity on the well-posedness of the

discrete-time scheme, and on the convergence of the approximate piecewise-linear solutions.

2 The fundamental operator in (20) is:  $\mathcal{M}_d : z \mapsto (hC(I_n - hA)^{-1}B + D)z + \mathcal{M}^{-1}(z)$ . Assume that  $h > 0$  is small enough so that the spectral radius and the norm of  $hA$  are both  $< 1$ , then  $(I_n - hA)^{-1} = I_n + hA + \mathcal{O}(h^2)$  [58, Proposition 9.4.3]. Therefore

4  $hC(I_n - hA)^{-1}B + D = hC(I_n + hA + \mathcal{O}(h^2))B + D = hCB + D + \mathcal{O}(h^2)$ . Using the property 5) in “Dissipative (Passive) Systems” with the required rank assumptions, it follows that  $hC(I_n - hA)^{-1}B + D = C(\frac{1}{h}I_n - A)^{-1}B + D \succ 0$  for  $h > 0$  small enough. Therefore

6 if  $\mathcal{M}(\cdot)$  is maximal monotone,  $\mathcal{M}_d(\cdot)$  is the sum of two maximal monotone operators, which by [S27, Corollary 24.4] is itself maximal monotone. The first step consists in checking the existence of a solution to the inclusion (20). Let us characterize the range of  $\mathcal{M}_d$ , which is the domain of  $\mathcal{M}_d^{-1}(\cdot)$ . There are several ways to proceed, which are outlined now, the first two

10 which consist of “unwinding” the operator  $\mathcal{M}_d(\cdot)$ .

1) Assume for instance that  $\mathcal{M}(\cdot) = \mathcal{N}_K(\cdot)$  for some closed convex nonempty cone  $K \subseteq \mathbb{R}^m$ .

14 Using (30) in “Useful Equivalences”, the inclusion in (20) can be shown to be equivalent to the variational inequality (VI): Find  $\lambda_{k+1} \in K^*$  such that:

$$\langle (hC(I_n - hA)^{-1}B + D)\lambda_{k+1} + C(I_n - hA)^{-1}x_k + hC(I_n - hA)^{-1}\bar{B}u_k + \bar{D}v_k, \lambda - \lambda_{k+1} \rangle \geq 0 \quad (21)$$

16 for all  $\lambda \in K^*$ . The tools presented in [48], [59] can be used to analyse the existence and uniqueness of solutions to this VI. A basic assumption in [48] is that  $hC(I_n - hA)^{-1}B + D \succeq 0$  (not necessarily symmetric). In case  $hC(I_n - hA)^{-1}B + D \succ 0$ , there exists a unique solution for any  $x_k, u_k, v_k$ , and it can be computed as the solution of a constrained quadratic problem see [48, Theorem 2, Corollaries 3 and 4].

18 2) Assume now that  $K = \mathbb{R}_+^m$  (the positive orthant). Then the inclusion in (20) is equivalent to the LCP:

$$0 \leq \lambda_{k+1} \perp (hC(I_n - hA)^{-1}B + D)\lambda_{k+1} + C(I_n - hA)^{-1}x_k + hC(I_n - hA)^{-1}\bar{B}u_k + \bar{D}v_k \geq 0. \quad (22)$$

20 Then using Theorem 6 in “Complementarity Problems”, it is inferred that this LCP has a solution for any  $x_k, u_k, v_k$ , if and only if  $hC(I_n - hA)^{-1}B + D$  is a P-matrix.

24 3) In a more general setting, we may rely on [60] to characterize the range of  $\mathcal{M}_d$ . This is not done here for the sake of brevity.

26 The second step is to show that the obtained approximated piecewise-linear and step-functions sequences, converge to limits which are solutions of the continuous-time system. This has been achieved in several articles for LCS [61], [62], relay systems where  $\mathcal{M}(\cdot) = \text{Sgn}(\cdot)$  [63], Lur’e systems (1) with time-varying state-dependent set  $\mathcal{M}_{(t,x)}(\cdot) = \mathcal{N}_{K(t,x)}(\cdot)$  with  $K(t,x)$  closed convex for each  $t$  and  $x$  [64, Theorems 1, 2], or with time-varying state-dependent set  $\mathcal{M}_{(t,x)}(\cdot)$

[65, Theorems 5.3, 5.4] [42, Theorems 11, 18]. They all use passivity as a central property. For the sake of brevity the reader is referred to [3, section 5] where detailed sketches of proofs are provided. A last, crucial point concerns the *calculation* of solutions to (20), with efficient iterative algorithms. The reader is referred to [66] for a complete exposition of the main methods and algorithms.

*Positive-realness and the Kalman-Yakubovich-Popov Lemma have been proved to be powerful tools for designing A-stable Runge-Kutta methods applied to ordinary differential equations [67], [68]. The above shows that passivity has further implications in the Numerical Analysis of differential inclusions.*

**Open Problems** As seen above, the existence of solutions has been investigated in details in many cases of set-valued Lur'e systems with passivity. However some open issues still largely remain open. Let us present few simple examples to illustrate this fact.

*Example 11:* (circuits with switches, DC-DC converters) Let us consider the circuit in Figure 4(a), with Zener diodes mounted in series and a switch. Usually switches are implemented with transistors, and may be modeled as in [16, section 4.7.3, 4.7.4]:  $u_s = R_{off}i_1$  if  $v_s < 0$ ,  $u_s = R_{on}i_1$  if  $v_s \geq 0$ ,  $R_{on} \lll 1$ ,  $R_{off} \ggg 1$ . This is formulated equivalently in a complementarity framework as:  $u_s = (\lambda_2 + R_{on})i_1$ ,  $0 \leq \begin{pmatrix} R_{off} - \lambda_2 - R_{on} \\ v_s(t) + \lambda_1 \end{pmatrix} \perp \begin{pmatrix} \lambda_1 \\ \lambda_2 \end{pmatrix} \geq 0$ . The dynamics is:

$$\begin{cases} \dot{x}_1(t) = -\frac{R+R_{on}}{L_1}x_1(t) + \frac{R}{L_1}x_2(t) + \frac{1}{L_1}u(t) - \frac{1}{L_1}\lambda_2(t)x_1(t) \\ \dot{x}_2(t) = \frac{R}{L_2}x_1(t) - \frac{R}{L_2}x_2(t) + \frac{1}{L_2}\lambda_3(t) \\ \begin{pmatrix} \lambda_1(t) \\ \lambda_2(t) \end{pmatrix} \in -\partial\psi_{\mathbb{R}_+^2} \left( \begin{pmatrix} 0 & -1 \\ 1 & 0 \end{pmatrix} \begin{pmatrix} \lambda_1(t) \\ \lambda_2(t) \end{pmatrix} + \begin{pmatrix} R_{off} - R_{on} \\ v_s(t) \end{pmatrix} \right) \\ \lambda_3(t) \in -v_z \text{sgn}((0, 1)x(t)) = -\partial U_z(w_3(t)), \end{cases} \quad (23)$$

where:  $x_1 = i_1$ ,  $x_2 = i_2$ ,  $\lambda_3 = u_z$ ,  $U_z(w_3) = v_z|x_2|$ ,  $v_z > 0$ . Identifying (23) with (1)

yields  $\mathcal{M}(w) = \begin{pmatrix} \partial\psi_{\mathbb{R}_+}(w_1) \\ \partial\psi_{\mathbb{R}_+}(w_2) \\ \partial U_z(w_3) \end{pmatrix}$ ,  $w_1 = -\lambda_2 + R_{off} - R_{on}$ ,  $w_2 = \lambda_1 + v_s(t)$ ,  $w_3 = (0, 1)x$ ,

$\mathcal{M}(w) = \partial(\psi_{\mathbb{R}_+}(w_1) + \psi_{\mathbb{R}_+}(w_2) + U_z(w_3))$ ,  $w = (w_1, w_2, w_3)^\top$ .

The control inputs  $u(t)$  and  $v_s(t)$  act in both the ODE and the complementarity (set-valued) parts. Their respective influences on the dynamics certainly differ. It is noteworthy that if  $\lambda$  is seen as an input and  $w$  as an output, then (23) is a bilinear system due to the term  $\lambda_2 x_1$ , and the nonlinearity is in (1) (a). More generally the nonlinearity could also occur in (1) (b) with  $w(x, \lambda, v)$ . Using the fact that the signum multifunction can be written with complementarity

relations, the system (23) can be interpreted as a nonlinear complementarity system. Boost, buck, buck-boost and Ćuk converters are similar circuits which all possess a switch. Consider the boost converter in Figure 4(b). With the same switch model, its dynamics are given by:

$$\left\{ \begin{array}{l} L_1 \dot{x}_1(t) = -(\lambda_2(t) + R_{on})(x_1(t) + \lambda_3(t)) + u(t) \\ \dot{x}_2(t) = \frac{1}{RC}x_3(t) - \frac{1}{RC}x_2(t) \\ \dot{x}_3(t) = \lambda_3(t) \\ 0 \leq \lambda(t) \perp w(t) = \left( \begin{pmatrix} 0 & -1 & 0 \\ 1 & 0 & 0 \\ 0 & 0 & R_{on} \end{pmatrix} + \begin{pmatrix} 0 & 0 & 0 \\ 0 & 0 & 0 \\ 0 & -x_1(t) & \lambda_2(t) \end{pmatrix} \right) \lambda(t) \\ \quad + \begin{pmatrix} R_{off} - R_{on} \\ v_s(t) \\ -R_{on}x_1 + \frac{1}{C}(x_3(t) - x_2(t)) \end{pmatrix} \geq 0, \end{array} \right. \quad (24)$$

with:  $\lambda = (\lambda_1, \lambda_2, \lambda_3)^\top$ ,  $x_1 = i_1$ ,  $x_2(t) = \int_0^t i_3(s)ds$ ,  $x_3(t) = \int_0^t i_2(s)ds$ ,  $u_s = (\lambda_2 + R_{on})(x_1 - \lambda_3)$ . The multipliers can be calculated explicitly depending on  $v_s(t) \geq 0 \Leftrightarrow \lambda_1(t) = \lambda_2(t) = 0$ ,  $0 \leq \lambda_3(t) \perp R_{on}\lambda_3(t) - R_{on}x_1(t) + \frac{1}{C}(x_3(t) - x_2(t)) \Leftrightarrow \lambda_3(t) = \text{proj}[\mathbb{R}_+; x_1(t) - \frac{1}{R_{on}C}(x_3(t) - x_2(t))]$ , or  $v_s(t) < 0 \Leftrightarrow \lambda_1(t) = -v_s(t)$ ,  $\lambda_2(t) = R_{off} - R_{on}$ ,  $0 \leq \lambda_3(t) \perp \lambda_3(t) - x_1(t) \geq 0 \Leftrightarrow \lambda_3(t) = \text{proj}[\mathbb{R}_+; x_1(t)]$ . This time the nonlinearities occur in (1) (a) and (b). Both systems in (23) and (24) are nonlinear complementarity systems (NLCS) which switch between two passive LCS as  $v_s(t)$  switches between positive and negative values. Each LCS is a nonlinear nonsmooth ODE with Lipschitz continuous right-hand side. *This switch model allows to treat the dynamics in one shot as a single NLCS without resorting to two separate circuits for each mode of both the switch and the diode. This may be useful for circuits with several switches and diodes since the number of modes increases exponentially fast.*

*Example 12:* (descriptor-variable complementarity systems) Circuits, mechanical and chemical systems often include equality constraints which cannot be eliminated (or should preferably be kept for some reason). When nonsmooth constraints are present, the dynamics couples an ODE with nonsmooth and equality constraints (like MLCPs, see ‘‘Complementarity Problems’’). The analysis of such systems using properties of passive descriptor variable systems [54], [69], [70] remains largely open. The passive control (*i.e.*, without actuators) of nonsmooth mechanical systems fits within this framework [71].

*Example 13:* (nonlinear resistances, capacitors and inductances, implicit system) This time the circuit in Figure 4(c) is studied, where it is assumed that the resistance, the capacitance and

the inductance are varying as  $R(i)$ ,  $C(i)$  and  $L(i)$ <sup>1</sup>. This gives rise to the following dynamics  
 2 (the time argument is dropped inside  $R(i)$ ,  $C(i)$  and  $L(i)$ ):

$$\begin{pmatrix} L_1(x_1)\dot{x}_1(t) + \dot{x}_2(t) + u_1(t) + u_2(t) \\ L_2(x_1 - f(\dot{x}_2)) \frac{df}{d\dot{x}_2} \dot{x}_3(t) + R(x_1 - f(\dot{x}_2)) (x_1(t) - f(\dot{x}_2(t)) + L_1(x_1)\dot{x}_1(t) - u_1(t) \\ \dot{x}_2(t) = x_3(t) \end{pmatrix} \in \begin{pmatrix} -1 \\ 0 \\ 0 \end{pmatrix} \mathcal{N}_\Phi(\dot{x}_2(t)), \quad (25)$$

where  $x_1 = i_2$ ,  $x_2 = u_c$ ,  $\dot{u}_c(t) = \frac{i_1(t)}{C(i_1(t))} \Rightarrow i_1 = f(\dot{u}_c)$  for some function  $f(\cdot)$ ,  $u_c$  is the voltage  
 4 across the capacitance,  $\Phi = \{z \mid f(z) \leq 0\}$ . The system in (25) is nonlinear, nonsmooth and  
 implicit since the state derivative enters the normal cone. In [3] implicit sweeping processes  
 6 have been named of relative degree zero (ZOSwP). The relationships between ZOSwP and  
 complementarity systems are shown in [3, section 3.5].

8 *These examples show that a general model should incorporate all the above features. Despite  
 of their discrepancies, these circuits all share one important physical property: passivity  
 10 (autonomous circuits dissipate energy). Fairly general model of circuits are shown in [16,  
 Chapter 5, equations (5.1), (5.7), (5.12), (5.14), (5.18), (5.19)]. One objective may be to use  
 12 passivity as a unifying tool for their well-posedness analysis.*

*Example 14:* (time-delayed systems) Consider the delayed version of (1):

$$\begin{cases} (a) & \dot{x}(t - \tau_1) \stackrel{a.e.}{=} Ax(t - \tau_2) + B\lambda(t - \tau_3) + \bar{B}u(t) \\ (b) & w(t) = Cx(t - \tau_4) + D\lambda(t - \tau_5) + \bar{D}v(t) \\ (c) & \lambda(t - \tau_6) \in -\mathcal{M}(w(t - \tau_7)), \end{cases} \quad (26)$$

14 where  $\tau_i \geq 0$  are delays (due to feedback, or modeling). Certainly these various delays do  
 not have the same influence on the system's dynamics (and well-posedness). Until now only  
 16 Moreau's first order sweeping process with delays in the vector field has been analysed, see  
 references in [3, Section 2.1.1]. Passive systems with delays have been studied in the Automatic  
 18 Control literature [S3, section 5.9].

*Example 15:* (relay system) The following planar relay system [63], [72]:

$$\begin{pmatrix} \dot{x}_1(t) \\ \dot{x}_2(t) \end{pmatrix} \in \underbrace{- \begin{pmatrix} 1 & -2 \\ 2 & 1 \end{pmatrix}}_{=B} \underbrace{\begin{pmatrix} \operatorname{sgn}(x_1(t)) \\ \operatorname{sgn}(x_2(t)) \end{pmatrix}}_{=\operatorname{Sgn}(Cx(t))} \quad (27)$$

<sup>1</sup>Actually current-dependent capacities seem not to have been invented yet, hence considering  
 $C(i)$  is a pure exercise or mathematical fuss, for the moment.

where  $\text{Sgn}(z) = \partial(|z_1| + \dots + |z_n|)$ , and  $C = I_2$ . This relay system fits with (1), with  
 2  $(A, B, C, D) = (0, B, I_2, 0)$ ,  $\bar{B} = 0$ ,  $\bar{D} = 0$ , and  $\mathcal{M}(\cdot) = \text{Sgn}(\cdot)$ . In (27)  $B \succ 0$ , but  $B \neq B^\top$   
 since  $B$  has a skew-symmetric part. This skew-symmetric part makes trajectories spiral around  
 4 the origin, and converge to it in finite-time after an infinite number of crossings with both axis,  
 each crossing corresponding to a switch in a signum multifunction [72]: this is a Zeno behaviour.  
 6 Is the linear time-invariant system defined by the quadruple  $(0, B, I_2, 0)$  a passive one? If it were,  
 then from the Schur complement Theorem [58], [S3], Lur'e LMIs in (28) would be verified with  
 8  $PB = I_2 \Rightarrow P = B^{-1} \neq P^\top$ : symmetry fails and this quadruple is not passive. This however  
 does not mean that the relay system in (27) is not passive with respect to different storage  
 10 functions and supply rate. In particular, nonsmooth Lyapunov functions [73] could be storage  
 functions candidate, if an appropriate output can be defined (in this case passive outputs [S3,  
 12 p.310] could be set-valued). For instance  $V(x) = |x_1| + |x_2|$  yields  $\dot{x}(t) \in (J - R)\partial V(x)$  for  
 (27),  $J = \frac{1}{2}(B^\top - B)$ ,  $R = \frac{1}{2}(B + B^\top)$ , that is a nonsmooth set-valued Hamiltonian system  
 14 with dissipation [S3, Definition 6.38]. Is an extension of [S3, Proposition 6.41] possible in the  
 context of set-valued nonsmooth passive systems ? How is this related to well-posedness issues  
 16 ?

## Conclusions

18 The class of set-valued Lur'e nonsmooth and nonlinear systems that is dealt with in this  
 article, can benefit a lot from passivity for their well-posedness and for their numerical analyses.  
 20 In fact, in many application examples, passivity is a strong physical property and it is a pity  
 not to take advantage of it. In Automatic Control, it is also customary to passify systems by  
 22 feedback, hence considering to create well-posed closed-loop systems is an option. This article  
 reviews the main peculiar well-posedness issues associated with these systems, and the main  
 24 available results which are based on passivity. Many problems of interest to Automatic Control  
 remain open, few of them being pointed out in this introductory article. Issues like time-delayed  
 26 systems, time-varying systems (both can be handled *via* passivity), or stochastic systems, remain  
 largely open.

## Sidebar:Article Summary

2 Passivity and dissipativity, in Jan Willem's sense, are known to be powerful tools for  
stability analysis and feedback control design. For instance, passive systems in negative feedback  
4 interconnection with slope-restricted static single-valued smooth nonlinearities, known as Lur'e  
systems, have thoroughly been studied in the Automatic Control literature, yielding the so-called  
6 absolute stability problem (with the famous Popov and circle criteria). On the other hand, large  
classes of nonsmooth systems (complementarity dynamical systems, relay systems, projected dy-  
8 namical systems, evolution and differential variational inequalities, Moreau's sweeping processes,  
maximal monotone differential inclusions), with applications in Circuits, Mechanics, Economics,  
10 *etc.*, can be interpreted as set-valued Lur'e systems, in which the feedback nonlinearity is a  
multivalued mapping. Therefore the closed-loop system is a differential inclusion of a certain  
12 type, the well-posedness of which needs to be analysed as a prerequisite to stability and control.  
This introductory article focuses on the well-posedness of such set-valued feedback systems. It  
14 is shown how the existence and uniqueness of solutions to these specific differential inclusions,  
can benefit a lot from the passivity of the system and from the maximal monotonicity (which  
16 is a form of incremental passivity) of the feedback set-valued mapping. Available results are  
reviewed, many illustrative examples are given, and some open issues are pointed out.

## Sidebar:Dissipative (Passive) Systems

2 A quadruple  $(A, B, C, D)$  is passive in Jan Willems' sense [S1], [S2], if and only if the following LMI (also called the Lur'e equations) is satisfied:

$$\begin{pmatrix} -PA - A^\top P & -PB + C^\top \\ -B^\top P + C & D + D^\top \end{pmatrix} \succeq 0, \quad P = P^\top \succeq 0. \quad (28)$$

4 Indeed this LMI is equivalent to the dissipation equality: for all  $t \geq 0$ ,  $V(x(t)) - V(x(0)) \leq \int_0^t w(u(s), y(s)) ds - \int_0^t u^\top(s)(D + D^\top)u(s) ds + \int_0^t x^\top(s)(PA + A^\top P)x(s) ds$ , with storage  
6 functions  $V(x) \geq 0$ , along the trajectories of the corresponding system with state  $x$ , input  $u(\cdot)$  and output  $y = Cx + Du$ , and supply rate  $w(u, y) = u^\top y$ . In fact one speaks of *passivity*  
8 when  $w(u, y) = u^\top y$ . When the pair  $(C, A)$  is observable,  $P$  is full rank (as shown by Kalman in 1963 [S3, p.116] [25]). When both inequalities are strict, the system is said to be *strictly*  
10 *passive*. In fact, it should better be called in this case a *strongly passive* system. Indeed it is in this case equivalent to the *strong strict positive realness* (SSPR) of the associated transfer  
12 matrix  $H(s) = D + C(sI_n - A)^{-1}B$ ,  $s \in \mathbb{C}$  [S4, S4] [S3, section 3.12.2]. *Strict state* passivity [S3, Definition 4.54] is satisfied by SPR transfer matrices with minimal realisations [S5] [S3,  
14 Theorem 4.73], which do not necessarily verify  $D + D^\top \succ 0$  (think of  $H(s) = \frac{1}{s+1}$ ), hence the first matrix inequality may be nonstrict (this follows from the Schur complement theorem,  
16 see *e.g.*, [S3, Theorem A.65]). However for SPR transfer matrices with minimal realisation  $(A, B, C, D)$ , it holds that  $-PA - A^\top P \succ 0$  and  $P = P^\top \succ 0$  in (28). Passive systems possess  
18 structural properties, few of which are as follows (see [25], [38] for more properties):

- 1) Let  $D + D^\top = 0$ , then  $PB = C^\top$ ,
- 20 2)  $\text{Ker}(D + D^\top) \subseteq \text{Ker}(PB - C^\top)$ ,
- 3)  $D + D^\top \succeq 0$  ( $\succ 0$  for strict passivity and SSPR transfer functions),
- 22 4)  $-PA - A^\top P \succeq 0$  ( $\succ 0$  for strict passivity and SPR minimal realizations).
- 5) Let  $P \succ 0$ , and  $\begin{pmatrix} B \\ D + D^\top \end{pmatrix}$  have full column rank, then  $\lambda_{\min}(D + D^\top + \frac{1}{\sigma}(CB + B^\top C^\top)) \geq$   
24  $\frac{\alpha}{\sigma}$  for  $\sigma$  large enough and some  $\alpha > 0$ , where  $\lambda_{\min}(\cdot)$  is the smallest eigenvalue.

This extends to descriptor variable systems represented by quintuples  $(E, A, B, C, D)$  [69], [70].

## Sidebar: Set-valued Mappings

2 A set-valued (or multivalued) mapping  $\mathcal{M} : \mathbb{R}^n \rightrightarrows \mathbb{R}^m$  associates with each  $x \in \mathbb{R}^n$  a  
subset  $\mathcal{M}(x) \subseteq \mathbb{R}^m$ . If the sets  $\mathcal{M}(x)$  are closed, then  $\mathcal{M}(\cdot)$  is said to be closed. Let  $\mathcal{M}(\cdot)$  be  
4 closed, then it is *outer semicontinuous* at  $x_0$  if for all  $\epsilon > 0$ , there is a neighborhood  $N(x_0)$  such  
that  $x \in N(x_0)$  implies  $\mathcal{M}(x) \subset \mathcal{M}(x_0) + \mathcal{B}_\epsilon$  (the ball centered at the origin with radius  $\epsilon$ ).  
6 It is *inner semicontinuous* if for all  $\epsilon > 0$ , there is a neighborhood  $N(x_0)$  such that  $x \in N(x_0)$   
implies  $\mathcal{M}(x_0) \subset \mathcal{M}(x) + \mathcal{B}_\epsilon$  [S6]. These notions are sometimes called *upper semicontinuity*  
8 and *lower semicontinuity* for set-valued functions [S7], [S8]. They are not to be confused with  
upper semicontinuous and lower semicontinuous single-valued functions. A set-valued  $\mathcal{M}(\cdot)$  that  
10 is both outer and inner semicontinuous, is said to be *continuous*.

The set-valued function is *Lipschitz continuous* if there exists a constant  $l \geq 0$  such that for all  
12  $x_1$  and  $x_2$ ,  $\mathcal{M}(x_1) \subset \mathcal{M}(x_2) + l\|x_1 - x_2\|\mathcal{B}_1$ . It is met mainly in Control applications [S7].

## Sidebar: Functions of Bounded Variation

2 The material which follows is taken from [S9], [S10] and is useful for the definition of  
 MDIs as in (16). A function  $f : I \rightarrow \mathbb{R}^n$ ,  $I \subseteq \mathbb{R}$  an interval, is of *bounded variation* (BV) on  
 4  $I$  if the variation  $\text{var}(f, I)$  of  $f(\cdot)$  over  $I$ , which is the supremum of  $\sum_{i=0}^{k-1} \|f(t_{i+1}) - f(t_i)\|$   
 over all the finite partitions  $t_0 < t_1, \dots < t_k$  of  $I$ ,  $k$  arbitrary, is bounded. It is of *locally*  
 6 *bounded variation* (LBV) if it is BV on any compact subinterval of  $I$ . A BV function has  
 right and left limits everywhere (this allows to fill-in their gaps, see Figure 5 (a) and (b)), if  
 8 it is right-continuous it is denoted RCBV. Notable features of BV functions, are that the set of  
 their discontinuity points is countable (hence it has zero Lebesgue measure), and there may exist  
 10 accumulations of discontinuity points (*i.e.*, some kind of Zeno phenomenon, think of the velocity  
 of the bouncing ball system). Hence BV functions are differentiable Lebesgue almost everywhere,  
 12 and they are also Riemann integrable. Absolutely continuous and Lipschitz continuous functions  
 are LBV. BV set-valued mappings can also be defined, where the Hausdorff distance between  
 14 sets is used instead of the usual vector norm in the variation definition. This often occurs in  
 sweeping processes.

16 A BV function is the sum of two functions: a continuous BV function  $g(\cdot)$  and a step (piecewise-  
 constant) function  $s(\cdot)$ . The continuous part  $g(\cdot)$  is itself composed of two functions: an absolutely  
 18 continuous BV function  $g_{ac}(\cdot)$  and a singular BV function  $g_{sing}(\cdot)$ . Thus, the measure derivative  
 of a BV function consists of the sum  $\dot{g}_{ac}(\cdot)dt + \mu_{sing} + \mu_a$ , where the measure derivative of  $s(\cdot)$ ,  
 20 *i.e.*,  $\mu_a$ , is a sum of Dirac measures  $\delta_{t_k}$ , thus it is an atomic measure whose support is equal  
 to the set of discontinuity points  $\{t_k\}$ , while  $\mu_{sing}$  is a singular (with respect to the Lebesgue  
 22 measure) nonatomic measure, *i.e.*,  $\dot{g}_{sing} = 0$  almost everywhere on  $I$ . So-called SBV (special  
 BV) functions have  $g_{sing} = 0$ : this is certainly what occurs in most of cases of interest in  
 24 Automatic Control, however mathematical results are often stated for BV functions due to some  
 particular features of BV spaces that SBV spaces do not share. The stability results in [23],  
 26 [S18] incorporate nonzero  $g_{sing}(\cdot)$ .

With each BV function  $f(\cdot)$  it can be associated its *differential* or *Stieltjes measure*, denoted  $df$ ,  
 28 and which allows to define the integral  $\int h(t)df$  for a measurable function  $h(\cdot)$ . Without going  
 deeply into the rigorous definition of this notion of a derivative, let us mention its main properties:  
 30 for any  $a \leq b$ ,  $df([a, b]) = \int_{[a, b]} df = f(b^+) - f(a^-)$ ,  $df((a, b]) = f(b^+) - f(a^+)$ ,  $df([a, b)) =$   
 $f(b^-) - f(a^-)$ ,  $df((a, b)) = f(b^-) - f(a^+)$ ,  $df(\{a\}) = f(a^+) - f(a^-)$ . For instance, if  $t_k$  are the  
 32 discontinuity points of the step function  $s(\cdot)$ , then  $ds = \sum_k ds(t_k)\delta_k = \sum_k (s(t_k^+) - s(t_k^-))\delta_k$ .  
 The rigorous mathematical meaning of MDIs as in (16) is outside the scope of this article, see  
 34 [S11, section 2] [S9], [S12].

## Sidebar:Convex Analysis, Maximal Monotonicity, Complementarity Theory

2 The material in this section is taken from classical references [S6], [S13]–[S15], [S27].

### Sidebar:Some Definitions from Convex Analysis

4 A convex function  $f : \mathbb{R}^n \rightarrow \mathbb{R} \cup \{+\infty\}$  is proper if  $f(x) < +\infty$  for at least one  $x$ , and  
5  $f(x) > -\infty$  for all  $x$ . It is lower semicontinuous (lsc) at  $x_0$  if  $f(x_0) \leq \liminf_{x \rightarrow x_0} f(x)$ . The  
6 function in Figure 5 (a) is not lsc at  $x_0$  as long as  $f(x_0) > a$ . If  $f(x_0) \leq a$  then it is lsc at  $x_0$ .  
7 An important function of Convex Analysis is the *indicator* function of a set  $K$ :  $\psi_K(x) = 0$  if  
8  $x \in K$ ,  $\psi_K(x) = +\infty$  if  $x \notin K$ . If  $K$  is nonempty closed convex,  $\psi_K(\cdot)$  is a convex lsc function.  
9 Remind that convex functions which are bounded on  $\mathbb{R}^n$  (i.e.,  $\text{dom}(f) = \mathbb{R}^n$ ) are continuous.  
10 The indicator function is an interesting and useful case of a discontinuous convex function (which  
11 thus necessarily takes infinite values at some points). It was introduced by J.J. Moreau as a  
12 potential associated with unilateral constraints, which he named *superpotential*, see [16, section  
13 2.5.4, figure 2.21]. Obviously not all convex functions are differentiable in the usual sense (the  
14 indicator function even has discontinuities of infinite magnitude, the absolute value function is  
15 not differentiable at zero), however all convex lsc proper functions are *subdifferentiable*, and their  
16 subdifferential is defined as follows. The *subgradients*  $\gamma \in \mathbb{R}^n$  of  $f(\cdot)$  at  $x_0$  are vectors which  
17 verify  $f(x) - f(x_0) \geq \gamma^\top(x - x_0)$  for all  $x \in \mathbb{R}^n$ . The subdifferential of  $f(\cdot)$  at  $x_0$ , denoted  
18 as  $\partial f(x_0)$ , is the set of all subgradients of  $f(\cdot)$  at  $x_0$ :  $\partial f(x_0) = \{\gamma \in \mathbb{R}^n \mid f(x) - f(x_0) \geq$   
19  $\gamma^\top(x - x_0) \text{ for all } x \in \mathbb{R}^n\}$ . Let  $f(x) = |x|$ , then it can be calculated that  $\partial f(x) = -1$  if  $x < 0$ ,  
20  $1$  if  $x > 0$ , and  $\partial f(0) = [-1, 1]$ . Thus  $\partial|x|$  is the set-valued signum function.

### Sidebar:Normal and Tangent Cones

22 Let  $K \subseteq \mathbb{R}^n$  be a nonempty closed convex set. The *normal cone* to  $K$  at  $x$ , denoted  
23  $\mathcal{N}_K(x)$ , can be defined as  $\mathcal{N}_K(x) = \{\xi \in \mathbb{R}^n \mid \langle \xi, v - x \rangle \leq 0 \text{ for all } v \in K\}$  (this is a  
24 variational definition), and it is admitted that  $\mathcal{N}_K(x) = \emptyset$  if  $x \notin K$ . Though this may not  
25 be obvious at first sight, the following is true:  $\partial\psi_K(x) = \mathcal{N}_K(x)$ . There are more convenient  
26 expressions for normal cones, which allow to make calculations (most importantly, calculation  
27 of the multiplier that is an element of the normal cone in DIs, similarly to the fact that it is  
28 not always trivial to compute the selection of a Filippov set in case of codimension  $\geq 2$  sliding  
29 surface). There are two practically important cases: when  $K$  is convex polyhedral, and when  $K$   
30 is convex and finitely represented, i.e.,  $K = \{x \in \mathbb{R}^n \mid h_i(x) \geq 0, 1 \leq i \leq m\}$ . Assume that  
31 the functions  $h_i : \mathbb{R}^n \rightarrow \mathbb{R}$  are continuously differentiable. Moreover, assume that there exists  
32  $v \in \mathbb{R}^n$  such that  $\nabla h_i^\top(x)v > 0$  for all  $i \in \mathcal{I}(x) = \{i \in \{1, m\} \mid h_i(x) = 0\}$  (this is the set of

active constraints). Such a condition is called the **Magasarian-Fromovitz Constraint Qualification** (MFCQ). This one of several CQs in Optimisation. Another one is linear independency. Then,  $\mathcal{N}_K(x) = \{\xi \in \mathbb{R}^n \mid \xi = -\sum_{i \in \mathcal{I}(x)} \lambda_i \nabla h_i(x), \lambda_i \geq 0\} = \{\xi \in \mathbb{R}^n \mid \xi = -\sum_{i=1}^m \lambda_i \nabla h_i(x) = -\nabla h(x)\lambda, 0 \leq \lambda_i \perp h_i(x) \geq 0\}$ : the normal cone is generated by outwards gradients to  $K$  at the contact point. The fact that complementarity conditions are present in the last expression, allows us to make a direct link between differential inclusions into normal cones, and complementarity systems [3, section 3]. Normal cones as expressed in this second form, are named *linearisation cones*. The normal cones to nonempty convex polyhedral sets (where  $h(x) = Hx + g$ ) can always be expressed as their linearisation cone [S6, examples 5.2.6, p.67]. The *tangent cone* to  $K$  at  $x$  is  $\mathcal{T}_K(x) = \text{cl}(\{z \in \mathbb{R}^n \mid z = \alpha(y - x), \alpha \geq 0, y \in K\})$ . The normal and tangent cones are related through *polarity*, i.e.,  $\mathcal{N}_K(x) = (\mathcal{T}_K(x))^\circ = \{w \in \mathbb{R}^n \mid \langle w, z \rangle \leq 0 \text{ for all } z \in \mathcal{T}_K(x)\}$ . Polarity extends orthogonality to convex sets. Similarly to normal cones, linearization tangent cones simplify their expressions. If the set  $K$  is finitely represented and the MFCQ holds, then  $\mathcal{T}_K(x) = \{z \in \mathbb{R}^n \mid z^\top \nabla h_i(x) \geq 0, \text{ for all } i \in \mathcal{I}(x)\}$ . While normal cones are “outwards” sets, tangent cones are “inwards” sets.

#### 16 *Sidebar: Conjugacy*

An important notion is that of the *conjugate* function  $f^*(\cdot)$  of a proper, convex lsc function  $f : \mathbb{R}^n \rightarrow \mathbb{R} \cup \{+\infty\}$ . By definition,  $f^*(y) = \sup_{x \in \text{dom}(f) \subseteq \mathbb{R}^n} \{\langle x, y \rangle - f(x)\}$ , and it is another proper, convex lsc function. This operation is called the *Legendre-Fenchel* transform. Their subdifferentials verify:  $x^* \in \partial f(x) \Leftrightarrow x \in \partial f^*(x^*)$ : this is an inversion operation, and we may write  $\partial f^*(\cdot) = (\partial f)^{-1}(\cdot)$ . For instance:  $f_1(x) = |x|$  and  $f_1^*(y) = \psi_{[-1,1]}(y)$  (the indicator function of  $[-1, 1]$ ), and  $\partial f_1(x) = \text{sgn}(x)$ , while  $\partial f_1^*(x^*) = \mathcal{N}_{[-1,1]}(x^*)$ . Hence  $\text{sgn}^{-1}(\cdot) = \mathcal{N}_{[-1,1]}(\cdot)$ . Let  $K \subseteq \mathbb{R}^n$  be a nonempty closed convex cone and  $K^*$  be its dual cone (the dual cone of a convex set  $K$  is  $K^* = -K^\circ$ ): if  $f_2(x) = \psi_K(x)$ , then  $f_2^*(x^*) = \psi_{K^*}(x^*)$ , and  $x^* \in \mathcal{N}_K(x) \Leftrightarrow x \in \mathcal{N}_{K^*}(x^*)$ .

#### 26 **Sidebar: Maximal Monotone Mappings**

A mapping  $\mathcal{M} : \text{dom}(\mathcal{M}) \subseteq \mathbb{R}^n \rightrightarrows \mathbb{R}^n$  is *monotone* if  $\langle y_1 - y_2, x_1 - x_2 \rangle \geq 0$  for all  $x_1 \in \text{dom}(\mathcal{M}), x_2 \in \text{dom}(\mathcal{M}), y_1 \in \mathcal{M}(x_1), y_2 \in \mathcal{M}(x_2)$ . It is *maximal* monotone if its graph cannot be enlarged without destroying the monotonicity, then  $\mathcal{M}(x)$  is closed convex for any  $x \in \text{dom}(\mathcal{M})$ . In finite-dimensional spaces, maximal set-valued mappings have closed graphs [S27, Proposition 20.33] and thus they are outer semicontinuous. The mapping is *strongly* monotone if there exists  $\alpha > 0$  such that  $\langle y_1 - y_2, x_1 - x_2 \rangle \geq \alpha \|x_1 - x_2\|^2$  for all  $x_1 \in \text{dom}(\mathcal{M}), x_2 \in \text{dom}(\mathcal{M}), y_1 \in \mathcal{M}(x_1), y_2 \in \mathcal{M}(x_2)$  (hence  $\mathcal{M} - \alpha I_n$  is monotone). It is *hypomonotone* if

there exists  $\alpha > 0$  such that  $\langle y_1 - y_2, x_1 - x_2 \rangle \geq -\alpha \|x_1 - x_2\|^2$  (hence  $\mathcal{M} + \alpha I_n$  is monotone).  
 2 Simple planar examples are depicted in Figure 5. A maximal monotone mapping  $\mathcal{M}(\cdot)$  has an  
 inverse mapping denoted  $\mathcal{M}^{-1}(\cdot)$  which is also maximal monotone, with  $\text{dom}(\mathcal{M}) = \text{Im}(\mathcal{M}^{-1})$   
 4 and  $\text{Im}(\mathcal{M}) = \text{dom}(\mathcal{M}^{-1})$ . Let  $R \in \mathbb{R}^{n \times m}$ ,  $r \in \mathbb{R}^n$ , then  $x \mapsto R^\top \mathcal{M}(Rx + r)$  is monotone if  
 $\mathcal{M}(\cdot)$  is monotone. As noted in [S3, pp.295-297] [S16, Remark 2] [56], monotone mappings are  
 6 incrementally passive input/output mappings and equilibrium independent passive input/output  
 mappings (*i.e.*, static nonlinearities). Thus maximal monotone mappings are incrementally passive  
 8 operators which are outer semicontinuous, see “Set-valued Mappings” for the definition of osc.

Assume that  $(0, 0)$  is in the graph of the monotone mapping  $\mathcal{M}(\cdot)$  (*i.e.*,  $0 \in \mathcal{M}(0)$ ). Then for all  
 10  $x \in \text{dom}(\mathcal{M})$  and all  $y \in \mathcal{M}(x)$ , one has  $\langle x, y \rangle \geq 0$ : the mapping belongs to the sector  $[0, +\infty]$   
 (a nonlinearity  $\varphi : \mathbb{R}^n \rightarrow \mathbb{R}^n$  belongs to the sector  $[a, b]$  if  $(\varphi(x) - ax)^\top (bx - \varphi(x)) \geq 0$  for  
 12 all  $x \in \mathbb{R}^n$ ). In this case the *positivity* defined in [S17] is recovered.

The normal cone to a closed nonempty convex set, defines a maximal monotone mapping. In  
 14 fact, the subdifferential of a convex lsc proper function defines a maximal monotone mapping.  
 But not all maximal monotone mappings are the subdifferential of such a function. The simplest  
 16 example is  $x \mapsto Mx$  with  $M \succeq 0$  but nonsymmetric. Let us emphasize here that positive (semi)  
 definite matrices need not be symmetric in general, they satisfy  $x^\top Mx > 0$  ( $\geq 0$ ) for all  $x \neq 0$ .  
 18 For instance  $M = \begin{pmatrix} 0 & -1 \\ 1 & 0 \end{pmatrix}$  is skew symmetric positive semidefinite,  $M = \begin{pmatrix} 2 & 1 \\ 0 & 2 \end{pmatrix}$  is positive  
 definite. Taking into account nonsymmetric matrices is quite important in LCPs.

20 The sum of two maximal monotone mappings  $\mathcal{M}(\cdot)$  and  $\mathcal{P}(\cdot)$  is maximal monotone if  $\text{dom}(\mathcal{M}) \cap$   
 $\text{int}(\text{dom}(\mathcal{P})) \neq \emptyset$ . Let  $D \succeq 0$ . The mapping  $(D + \mathcal{M}^{-1})(\cdot)$  in (1) is maximal monotone provided  
 22 that  $\text{int}(\text{dom}(\mathcal{M}^{-1})) = \text{int}(\text{Im}(\mathcal{M})) \neq \emptyset$ . Let  $\mathcal{M}^{-1}(x) = \mathcal{N}_K(x)$ ,  $K$  a nonempty closed convex  
 cone. The condition reads as  $\text{int}(K) \neq \emptyset$ .

#### 24 *Sidebar: Prox-regularity*

Prox-regularity is an extension of convexity. It needs the definition of Fréchet normals and  
 26 normal cones, which is outside the scope of this article. Let us just mention that an  $r$ -prox-  
 regular set  $K$  is such that its normal cone mapping is hypomonotone with constant  $\alpha = \frac{1}{r}$  and  
 28 for  $y_1, y_2$  small enough. Roughly speaking, the larger is  $r$ , the more convex is  $K$  (convexity  
 is recovered as  $r = +\infty$ ). If  $x$  is close enough to  $K$ , then its projection on  $K$  is unique, the  
 30 maximum distance above which this no longer holds depends on  $r$ . This parameter  $r$  is used in  
 [S18] to adjust lack/excess of passivity in Lur’e systems.

## Sidebar:Chain Rules

2 These are a very useful tool for manipulating systems with set-valued right-hand sides.  
 There are several versions of the chain rule, *e.g.*, [S13, Theorem 23.9] [S19, Theorems 7.2, 9.2]  
 4 [S20, Theorems 10.6, 10.49] [S18, Lemma 1] [S6, Theorem 4.2.1]. They all concern calculation  
 of the differential of  $f(\cdot) = g \circ h(\cdot)$ , where  $g(\cdot)$  is just subdifferentiable (proper lsc, convex or  
 6 nonconvex) and  $h(\cdot)$  has more regularity (it may be linear, affine, continuously differentiable,  
 or smooth). Nonlinear functions  $h(\cdot)$  often occur in Contact Mechanics as the signed distance  
 8 (or gap function)  $h(q) \geq 0$ , where the complementarity condition yields  $\lambda \in -\partial\psi_{\mathbb{R}_+^m}(h(q))$ , and  
 the generalized contact force has the form  $\nabla h(q)\lambda$  (due to the virtual displacement principle).  
 10 Let us state for instance [S19, Theorem 7.2].

*Theorem 5:* Let  $g : \mathbb{R}^p \rightarrow (\infty, +\infty]$  be a convex function, and let  $h : \mathbb{R}^n \rightarrow \mathbb{R}^p$ ,  
 12  $x \mapsto Ax + b$ ,  $A \in \mathbb{R}^{p \times n}$ ,  $b \in \mathbb{R}^p$ , with  $h(\bar{x}) \in \text{dom}(g)$  for some  $\bar{x} \in \mathbb{R}^n$ . Denote  $\bar{y} = h(\bar{x})$  and  
 assume that  $\text{Im}(h)$  contains a point of  $\text{ri}(\text{dom}(g))$ . Then we have the subdifferential chain rule:  
 14  $\partial(g \circ h)(\bar{x}) = A^\top(\partial g(\bar{y})) = \{A^\top v \mid v \in \partial g(\bar{y})\}$ .

Here  $\text{ri}$  denotes the relative interior of a set. The case when  $h(\cdot)$  has convex components and  
 16  $g(\cdot)$  is convex and nondecreasing componentwise is treated in [S19, Theorem 9.2]. If  $g(\cdot)$  is a  
 polyhedral function, then the condition on  $\text{Im}(h)$  can be replaced by  $\text{Im}(h)$  contains a point of  
 18  $\text{dom}(g)$  [S13, Theorem 23.9] (*e.g.*,  $\psi_K(\cdot)$  is polyhedral if  $K$  is polyhedral).

## Sidebar:Some Useful Equivalences

20 Let  $K$  be a convex, closed nonempty cone,  $K^\star$  its dual cone,  $K^\circ = -K^\star$  is its polar cone.  
 Then

$$\begin{aligned} K \ni \lambda \perp w \in K^\star &\iff \lambda \in -\mathcal{N}_{K^\star}(w) \iff w \in -\mathcal{N}_K(\lambda) \\ &\iff \lambda \in \mathcal{N}_{K^\circ}(-w). \end{aligned} \tag{29}$$

22 Let  $S \subseteq \mathbb{R}^n$  be a nonempty convex set,  $M = M^\top \succ 0$ ,  $q \in \mathbb{R}^n$ , then

$$\begin{aligned} Mx + q \in -\mathcal{N}_S(x) &\iff x = \text{proj}_M[S; -M^{-1}q] \\ &\iff x = \underset{z \in S}{\text{argmin}} \frac{1}{2}(z + M^{-1}q)^\top M(z + M^{-1}q) \iff x = (M + \mathcal{N}_S)^{-1}(-q) \\ &\iff \text{Find } x \in S \text{ such that: } \langle Mx + q, v - x \rangle \geq 0 \text{ for all } v \in S. \end{aligned} \tag{30}$$

The first equivalence is [S27, Proposition 6.46]. Therefore, the inclusion into a normal cone  
 24 is an orthogonal projection or a quadratic problem or a variational inequality. This shows in  
 passing that for symmetric positive definite  $M$ , the mapping  $(M + \mathcal{N}_S)^{-1}(\cdot)$  is single-valued and

well defined (with domain equal to  $\mathbb{R}^n$ ), it is also Lipschitz continuous with Lipschitz constant  $\frac{2}{\lambda_{\min}(M+M^\top)}$  [S21, Proposition 1].

### Sidebar: Complementarity Problems

In the next statement inequalities are understood componentwise. A P-matrix is a square matrix with positive principal minors.

*Theorem 6 (Fundamental Theorem of Complementarity Theory [S14]):* Let  $x \in \mathbb{R}^n$ ,  $M \in \mathbb{R}^{n \times n}$ ,  $q \in \mathbb{R}^n$ . The linear complementarity problem (LCP) with unknown  $x$ :  $x \geq 0$ ,  $Mx + q \geq 0$ ,  $x^\top(Mx + q) = 0$ , more compactly  $0 \leq x \perp Mx + q \geq 0$ , and denoted as  $\text{LCP}(q, M)$ , has a unique solution for any  $q$ , if and only if  $M$  is a P-matrix. Moreover, this solution is a piecewise-linear, Lipschitz continuous function of  $q$ .

There are LCPs, however, which possess solutions for *some* vectors  $q$ , and without  $M$  being a P-matrix. Theorem 6 is coherent with the characterisation of the operator  $(D + \mathcal{N}_K)^{-1}(\cdot)$  when  $K = \mathbb{R}_+^n$ . Many extensions of LCPs exists, see e.g. [66], [S14]. One of them is the mixed LCP (MLCP): find  $x \in \mathbb{R}^n$  and  $y \in \mathbb{R}^m$  such that  $Ax + By + c = 0$ ,  $0 \leq x \perp Mx + Ny + q \geq 0$  for constant matrices  $A, B, M, N$ , and vectors  $c, q$ . Obviously if  $A$  or  $B$  are square invertible, then the MLCP can be recast into an LCP. However such a manipulation is not always optimal [S22].

## Sidebar: Set-valued Signum Function

- 2 The widely used set-valued signum function  $\text{sgn} : \mathbb{R} \rightarrow [-1, 1]$  possesses the following properties, and therefore can be considered as a very specific case of a set-valued mapping:
- 4 1) It defines a maximal monotone mapping  $\mathbb{R} \rightarrow \mathbb{R}$ .
  - 2) It is the subdifferential of a convex, lower semicontinuous proper function:  $\text{sgn}(x) = \partial|x|$ .
  - 6 3) It is the Filippov's set of the discontinuous function  $f(x) = -1$  if  $x < 0$ ,  $f(x) = 1$  if  $x > 0$  (see, however, Remark 2).
  - 8 4) Its graph is the filled-in graph of the same discontinuous function seen as a BV function [S9], [S10].
  - 10 5) It is homogeneous of degree 0 ( $\text{sgn}(x) = \text{sgn}(\lambda x)$  for all  $\lambda > 0$ ).
  - 6) It is outer semicontinuous at  $x = 0$  (and obviously at all  $x \neq 0$ ).
  - 12 7) It takes compact, convex values.
  - 8) Its extension  $x \mapsto ax + \text{sgn}(x)$  is set-valued strongly monotone for any  $a > 0$ .
  - 14 9) Its inverse mapping is the normal cone  $z \mapsto \mathcal{N}_{[-1,1]}(z) = \{0\}$  if  $x \in (-1, 1)$ ,  $[0, +\infty)$  if  $x = 1$ , and  $(-\infty, 0]$  if  $x = -1$ .
  - 16 10) Both  $\text{sgn}(\cdot)$  and its inverse  $\mathcal{N}_{[-1,1]}(\cdot)$  belong to the sector  $[0, +\infty]$ .
  - 11) It satisfies a growth condition  $|\text{sgn}(x)| \leq 1 + b|x|$  for any  $b \geq 0$ .
  - 18 12) It can be formulated as a variational inequality of second kind:  $y \in \text{sgn}(x)$  is equivalent to: find  $y \in [-1, 1]$  such that  $\langle y, v - x \rangle - |v| + |x| \leq 0$  for all  $v \in \mathbb{R}$ .
  - 20 13) It can be formulated as a complementarity problem:  $y \in \text{sgn}(x) \Leftrightarrow [x = \lambda_1 - \lambda_2, 0 \leq \lambda_1 \perp 1 - y \geq 0, 0 \leq \lambda_2 \perp 1 + y \geq 0] \Leftrightarrow [y = \frac{1}{2}(-\lambda_1 + \lambda_2), \lambda_1 + \lambda_2 = 2, 0 \leq \lambda_1 \perp x + |x| \geq 0, 0 \leq \lambda_2 \perp |x| - x \geq 0]$ .
  - 22 14) In fact this is just a very particular case of a piecewise-linear multifunction  $\mathbb{R} \rightarrow \mathbb{R}$  which can be written under a complementarity framework [S23], [S24]. In addition if such function is non-decreasing then it corresponds to a maximal monotone mapping, equivalently this is the subdifferential of a convex proper lsc function [S13, Theorem 24.9, p.240].
  - 28 15) It can be formulated as the inclusion into a normal cone:  $y \in \text{sgn}(x) \Leftrightarrow x \in \mathcal{N}_{[-1,1]}(y)$ .
  - 16) The Moreau-Yosida approximation (or Moreau envelope)  $|x|_\lambda(x) = \inf_{z \in \mathbb{R}} \{ |z| + \frac{1}{2\lambda} |z - x|^2 \}$ , is  $|x|_\lambda(x) = \frac{x^2}{2\lambda}$  for  $|x| \leq \lambda$ ,  $|x|_\lambda(x) = |x| - \frac{\lambda}{2}$  for  $|x| > \lambda$ ,  $\lambda > 0$ . The derivative of  $|\cdot|_\lambda(\cdot)$  is Lipschitz continuous with constant  $\frac{1}{\lambda}$ , and is the saturation function  $\text{sat}_\lambda(\cdot)$ : this is called the Yosida approximation of the subdifferential of  $|\cdot|$  (it is single-valued and maximal monotone).
  - 30 17) The saturation  $\text{sat}_\lambda(\cdot)$  converges in the sense of filled-in graph (Hausdorff distance between both graphs [S25] [S9, section 0.3]) to the set-valued signum function as  $\lambda \rightarrow 0$ .
  - 34

- 18) However,  $\text{sgn}(\cdot)$  is neither Lipschitz continuous (in the sense of set-valued operators), nor  
2 inner semicontinuous at  $x = 0$  (hence it is not a continuous set-valued mapping at  $x = 0$   
since a continuous set-valued mapping is both inner and outer semicontinuous; but its  
4 graph is closed—  $\text{sgn}(\cdot)$  is outer semicontinuous with closed values [S7, Proposition 2.1]).
- 19) Anecdotically, it is Hausdorff upper continuous but it is not Hausdorff lower continuous  
6 [S26, Definition 3.1].

All these properties are generalised to the multivariable case of the function  $\text{Sgn} : \mathbb{R}^n \rightarrow \mathbb{R}^n$ ,  
8  $x \mapsto (\text{sgn}(x_1), \text{sgn}(x_2), \dots, \text{sgn}(x_n))^\top$ . One has  $\text{Sgn}(x) = \partial(|x_1| + |x_2| + \dots + |x_n|)$ .

## References

- [S1] J.C. Willems, “Dissipative dynamical systems part I: General theory”, *Archive for Rational Mechanics and Analysis*, vol. 45, pp. 321-351, 1972.
- [S2] J.C. Willems, “Dissipative dynamical systems Part II: Linear systems with quadratic supply rates”, *Archive for Rational Mechanics and Analysis*, vol. 45, pp. 352-393, 1972.
- [S3] B. Brogliato, R. Lozano, B. Maschke, O. Egeland, *Dissipative Systems Analysis and Control. Theory and Applications*. 3rd Ed., Springer Nature Switzerland AG, Comm. and Control Eng., 2020.
- [S4] W. Sun and P.P. Khargonekar and D. Shim, “Solution to the positive real control problem for linear time-invariant systems”, *IEEE Transactions on Automatic Control*, vol. 39, no 10, pp. 2034-2046, 1994.
- [S5] D.S. Madeira, J. Adamy, “On the equivalence between strict positive realness and strict passivity of linear systems”, *IEEE Transactions on Automatic Control*, vol. 61, no 10, pp. 3091-3095, 2016.
- [S6] J.B. Hiriart-Urruty, C. Lemaréchal, *Fundamentals of Convex Analysis*. Springer-Verlag Berlin Heidelberg, Grundlehren Text Editions, 2000.
- [S7] G.V. Smirnov, *Introduction to the Theory of Differential Inclusions*. American Mathematical Society, Graduate Studies in Mathematics, vol. 41, 2002.
- [S8] K. Deimling, *Multivalued Differential Equations*. De Gruyter Series in Nonlinear Analysis and Applications, Berlin, 1992.
- [S9] M.D.P. Monteiro-Marques, *Differential Inclusions in Nonsmooth Mechanical Problems: Shocks and Dry Friction*. Progr. Nonlinear Differential Equations Appl. 9, Birkhäuser, Basel, 1993.
- [S10] J.J. Moreau, “Bounded variation in time”, in *Topics in Nonsmooth Mechanics* (J.J. Moreau, P.D. Panagiotopoulos, G. Strang, Eds.), Basel-Boston-Stuttgart: Birkhäuser Verlag, pp. 174, 1987.
- [S11] V. Acary, B. Brogliato, D. Goeleven, “Higher-order Moreau’s sweeping process. Mathematical formulation and numerical simulation”, *Mathematical Programming ser. A*, vol. 113, pp. 133-217, 2008.
- [S12] J.J. Moreau, “Evolution problem associated with a moving convex set in a Hilbert space”, *Journal of Differential Equations*, vol. 26, pp. 347-374, 1977.
- [S13] R.T. Rockafellar, *Convex Analysis*. Princeton Landmarks in Mathematics, Princeton University Press, 1970.
- [S14] R.W. Cottle, J.S. Pang, R.E. Stone, *The Linear Complementarity Problem*. Academic Press Inc., Computer Science and Scientific Computing, 1992.
- [S15] D. Goeleven, *Complementarity and Variational Inequalities in Electronics*. Academic

Press, Mathematical Analysis and its Applications, 2017.

- 2 [S16] F. Miranda-Villatoro, F. Castanos, “Robust output regulation of strongly passive linear  
systems with multivalued maximally monotone operators”, *IEEE Transactions on Automatic*  
4 *Control*, vol. 62, no 1, pp. 238-249, 2017.
- [S17] C.A. Desoer, M. Vidyasagar. Feedback Systems: Input-Output Properties. Academic Press,  
6 1975.
- [S18] A. Tanwani, B. Brogliato, C. Prieur, “Stability and observer design for Lure systems with  
8 multivalued, non-monotone, time-varying nonlinearities and state jumps”, *SIAM Journal on*  
*Control and Optimisation*, vol. 52, no 6, pp. 3639-3672, 2014.
- 10 [S19] B.S. Mordukhovich, N.M. Nam, “Geometric approach to convex subdifferential calculus”,  
*Optimization*, vol. 66., no 6, pp. 839-873, 2017.
- 12 [S20] R.T. Rockafellar, R.J.B. Wets, Variational Analysis. Springer-Verlag Berlin, Grundlehren  
der mathematischen Wissenschaften, vol. 317, 1998.
- 14 [S21] B. Brogliato, D. Goeleven, “Well-posedness, stability and invariance results for a class of  
multivalued Lure dynamical systems”, *Nonlinear Analysis. Theory, Method, and Applica-*  
16 *tions*, vol. 74, no 1, pp. 195-212, 2011.
- [S22] S.L. Wu, T. Zhou, X. Chen, “A Gauss-Seidel type method for dynamic nonlinear  
18 complementarity problems’, *SIAM Journal on Control and Optimization*, vol. 58, no 6,  
pp. 3389-3412, 2020.
- 20 [S23] T.A.M. Kevenaar, D.M.W. Leenaerts, “A comparison of piecewise-linear model descrip-  
tion”, *IEEE Transactions on Circuits and Systems–I: Fundamental Theory and Applications*,  
22 vol. 39, no 12, pp.996-1004, 1992.
- [S24] B. Brogliato, “Some perspectives on the analysis and control of complementarity systems”,  
24 *IEEE Transactions on Automatic Control*, vol. 48, no 6, pp. 918-935, 2003.
- [S25] J.J. Moreau. “Approximation en graphe d’une évolution discontinue”, *RAIRO–Analyse*  
26 *Numérique*, vol. 12, no 1, pp. 75-84, 1978.
- [S26] F. Heyde, C. Shrage, “Continuity concepts for set-valued functions and a fundamental  
28 duality formula for set-valued optimization”, *Journal of Mathematical Analysis and*  
*Applications*, vol. 397, no 2, pp. 772-784, 2013.
- 30 [S27] H.H. Bauschke, P.L. Combettes, Convex Analysis and Monotone Operator Theory in  
Hilbert Spaces. Springer Science+Business Media, Canadian Mathematical Soc., Soc.  
32 mathématique du Canada, 2011.
- [1] J.P. Aubin, A. Cellina, Differential Inclusions. Springer Verlag, 1984.
- 34 [2] H. Brezis, Opérateurs Maximaux Monotones. North Holland Mathematics Studies, 1973.
- [3] B. Brogliato, A. Tanwani, “Dynamical systems coupled with monotone set-valued operators:  
36 Formalisms, applications, well-posedness, and stability”, *SIAM Review*, vol. 62, no 1, pp.  
3-129, 2020.

- [4] V.A. Yakubovich, G.A. Leonov, A.K. Gelig, *Stability of Stationary Sets in Control Systems*. World Scientific, Series Stability, Vibration and Control Systems, series A, vol. 14, 2004.
- [5] G. Zames, “On the input-output stability of nonlinear time-varying feedback systems Part one: Conditions derived using concepts of loop gain, conicity, and positivity”, *IEEE Transactions on Automatic Control*, vol. 11, no 2, pp. 228-238, 1966.
- [6] G. Zames, “On the input-output stability of nonlinear time-varying feedback systems–Part II: Conditions involving circles in the frequency plane and sector nonlinearities”, *IEEE Transactions on Automatic Control*, vol. 11, no 3, pp. 465-476, 1966.
- [7] A.J. van der Schaft, J.M. Schumacher, “The complementary-slackness class of hybrid systems”, *Mathematics of Control, Signals and Systems*, vol. 9, pp.266-301, 1996.
- [8] A.J. van der Schaft, J.M. Schumacher, “Complementarity modeling of hybrid systems”, *IEEE Transactions on Automatic Control*, vol. 43, no 4, pp.483-490, 1998.
- [9] B. Brogliato, *Nonsmooth Mechanics. Models, Dynamic and Control*. 3rd Ed., Springer Int. Publ. Switzerland, Comm. and Control Eng., 2016. Erratum at <https://hal.inria.fr/hal-01331565v6>.
- [10] A. Bressan, “Incompatibilità dei teoremi di esistenza e di unicità del moto per un tipo molto comune e regolare di sistemi meccanici”, *Annali della Scuola Normale Superiore di Pisa, Classe di Scienze*, 3e série, tome 14, no 4, pp.333-348, 1960.
- [11] M. Schatzman, “A class of nonlinear differential equations of second order in time”, *Nonlinear Analysis. Theory, Methods, and Applications*, vol. 2, no 3, pp. 355-373, 1978.
- [12] P. Ballard, “The dynamics of discrete mechanical systems with perfect unilateral constraints”, *Archive for Rational Mechanics and Analysis*, vol. 154, no 3, pp. 199-274, 2000.
- [13] A. Yu. Pogromsky, W.P.M.H. Heemels, H. Nijmeijer, “On solution concepts and well-posedness of linear relay systems”, *Automatica*, vol. 39, no 12, pp. 2139-2147, 2003.
- [14] B. Brogliato, A. Danilidis, C. Lemaréchal, V. Acary, “On the equivalence between complementarity systems, projected systems and differential inclusions”, *Systems and Control Letters*, vol. 55, no 1, pp. 45-51, 2006.
- [15] W.P.M.H. Heemels, J.M. Schumacher, S.Weiland, “Projected dynamical systems in a complementarity formalism”, *Operations Research Letters*, vol. 27, no 2, pp. 83-91, 2000.
- [16] V. Acary, O. Bonnefon, B. Brogliato, *Nonsmooth Modeling and Simulations for Switched Circuits*. Springer Science+Business Media, Lecture Notes in Electrical Engineering, vol. 69, 2011. Erratum at <https://hal.inria.fr/hal-01311078/document>.
- [17] B. Brogliato, W.P.M.H. Heemels, “Observer design for Lur’e systems with multivalued mappings: A passivity approach”, *IEEE Transactions on Automatic Control*, vol. 54, no 8, pp. 1996-2001, 1999.
- [18] S. Adly, A. Hantoute, B.T. Nguyen, “Lyapunov stability of differential inclusions involving

- prox-regular sets via maximal monotone operators”, *Journal of Optimisation Theory and Applications*, vol. 182, pp.906-934, 2019.
- [19] A. Tanwani, B. Brogliato, C. Prieur, “Observer design for unilaterally constrained mechanical systems: A passivity-based approach”, *IEEE Transactions on Automatic Control*, vol. 61, no 9, pp.2386-2401, 2016.
- [20] J.C.A. de Bruin, A. Doris, N. van de Wouw, W.P.M.H. Heemels, H. Nijmeijer, “Control of mechanical motion systems with non-collocation of actuation and friction: A Popov criterion approach for input-to-state stability and set-valued nonlinearities”, *Automatica*, vol. 45, pp. 405-415, 2009.
- [21] A. Doris, A.L. Juloski, N. Mihajlovic, W.P.M.H. Heemels, N. van de Wouw, “Observer designs for experimental non-smooth and discontinuous systems”, *IEEE Transactions on Control Systems Technology*, vol. 16, no 6, pp.1323-1332, 2008.
- [22] W.P.M.H. Heemels, M.K. Camlibel, J.M. Schumacher, and B. Brogliato, “Observer-based control of linear complementarity systems”, *International Journal of Robust and Nonlinear Control*, vol. 21, no 10, pp.1193-1218, 2011.
- [23] A. Tanwani, B. Brogliato, C. Prieur, “Well-posedness and output regulation for implicit time-varying evolution variational inequalities”, *SIAM Journal on Control and Optimisation*, vol. 56, no 2, pp. 751-781, 2018.
- [24] L. Vandenberghe, B.L. de Moor, J. Vandewalle, “The generalized linear complementarity problem applied to the complete analysis of resistive piecewise-linear circuits”, *IEEE Transactions on Circuits and Systems*, vol. 36, pp. 1382-1391, 1992.
- [25] M.K. Camlibel, L. Iannelli, F. Vasca, “Passivity and complementarity”, *Mathematical Programming ser. A*, vol. 145, pp. 531-563, 2014.
- [26] M.K. Camlibel, J.M. Schumacher, “Linear passive systems and maximal monotone mappings”, *Mathematical Programming ser. B*, vol. 157, pp.397-420, 2016.
- [27] A. Levant, “Higher-order sliding modes, differentiation and output-feedback control”, *International Journal of Control*, vol. 76, no. 9-10, pp. 924941, 2003.
- [28] S. Adly, D. Goeleven, “A stability theory for second-order nonsmooth dynamical systems with application to friction problems”, *Journal de Mathématiques Pures et Appliquées*, vol. 83, pp. 17-51, 2004.
- [29] B. Brogliato, “Absolute stability and the Lagrange-Dirichlet theorem with monotone multivalued mappings”, *Systems and Control Letters*, vol. 51, no 5, pp. 343-353, 2004.
- [30] R. Frasca, M.K. Camlibel, I.C. Goknar, L. Iannelli, and F. Vasca, “Linear passive networks with ideal switches: consistent initial conditions and state discontinuities”, *IEEE Transactions on Circuits and Systems I*, vol. 57, no 12, pp.3138-3151, 2010.
- [31] B. Brogliato, L. Thibault, “Existence and uniqueness of solutions for non-autonomous

- complementarity dynamical systems”, *Journal of Convex Analysis*, vol. 17, no. 3-4, pp.961-990, 2010.
- [32] J.T. Chen, “Time domain and frequency domain conditions for strict positive realness”, *IEEE Transactions on Automatic Control*, vol. 33, pp. 988-992, 1988.
- [33] A. Löhne, “A characterisation of maximal monotone operators”, *Set-Valued Anal.*, vol. 16, pp. 693-700, 2008.
- [34] S. Adly, A. Hantoute, B.K. Le, “Nonsmooth Lur’e dynamical systems in Hilbert spaces”, *Set-Valued and Variational Analysis*, vol. 24, pp.13-35, 2016.
- [35] S. Adly, A. Hantoute, B.K. Le, “Maximal monotonicity and cyclic monotonicity arising in nonsmooth Lur’e dynamical systems”, *Journal of Mathematical Analysis and Applications*, vol. 448, pp.691-706, 2017.
- [36] C.W. Scherer, T. Holicki, “An IQC theorem for relations: Towards stability analysis of data-integrated systems”, *IFAC-PapersOnLine*, vol. 51, no 25, pp. 390-395, 2018.
- [37] B. Jayawardhana, H. Logeman, E.P. Ryan, “The circle criterion and input-to-state stability”, *IEEE Control Systems Magazine*, pp.32-67, August 2011.
- [38] M.K. Camlibel, W.P.M.H. Heemels, J.M. Schumacher, “On linear passive complementarity systems”, *European Journal of Control*, vol. 8, no 3, pp.220-237, 2002.
- [39] W.P.M.H. Heemels, J.M. Schumacher, S. Weiland, “The rational complementarity problem”, *Linear Algebra and its Applications*, vol.294, no 1-3, pp.93-135, 1999.
- [40] W.P.M.H. Heemels, J.M. Schumacher, S. Weiland, “Linear complementarity systems”, *SIAM Journal Applied Mathematics*, vol.60, no 4, pp.1234-1269, 2000.
- [41] W.P.M.H. Heemels, M.K. Camlibel, J.M. Schumacher, “On the dynamic analysis of piecewise-linear networks”, *IEEE Transactions on Circuits and Systems I: Fundamental Theory and Applications*, vol. 49, no 3, pp.315-327, 2002.
- [42] K. Camlibel, L. Iannelli, A. Tanwani, “Convergence of proximal solutions for evolution inclusions with time-dependent maximal monotone operators”, *Mathematical Programming*, DoI: <https://doi.org/10.1007/s10107-021-01666-7>, 2021.
- [43] D. Goeleven, B. Brogliato, “Stability and instability matrices for linear evolution variational inequalities”, *IEEE Transactions on Automatic Control*, vol. 49, no 4, pp. 521-534, 2004.
- [44] B. Brogliato, D. Goeleven, “The Krakovskii-LaSalle invariance principle for a class of unilateral dynamical systems”, *Mathematics of Control, Signal and Systems*, vol. 17, no 1, pp. 57-76, 2005.
- [45] R.I. Leine, N. van de Wouw, “Uniform convergence of monotone measure differential inclusions: with application to the control of mechanical systems with unilateral constraints”, *Int. Journal of Bifurcation and Chaos*, vol. 18, no 5, pp.1435-1457, 2008.
- [46] S. Adly, B.K. Le, “Stability and invariance results for a class of non-monotone set-valued Lur’e dynamical systems”, *Applicable Analysis*, vol. 93, no 5, pp. 1087-1105, 2014.

- [47] B.K. Le, “Existence of solutions for sweeping processes with local conditions”, *Journal of Convex Analysis*, vol. 27, n0 3, pp. 833-844, 2020.
- [48] K. Addi, B. Brogliato, D. Goeleven, “A qualitative mathematical analysis of a class of linear variational inequalities via semi-complementarity problems: applications in electronics”, *Mathematical Programming Ser. A*, vol. 126, pp. 31-67, 2011.
- [49] B. Brogliato, D. Goeleven, “Existence, uniqueness of solutions and stability of nonsmooth multivalued Lur’e dynamical systems”, *Journal of Convex Analysis*, vol. 20, no 3, pp. 881-900, 2013.
- [50] F. Miranda-Villatoro, B. Brogliato, F. Castanos, “Multivalued robust tracking control of Lagrange systems: Continuous and discrete-time algorithms”, *IEEE Transactions on Automatic Control*, vol. 62, no 9, pp. 4436-4450, 2017.
- [51] S. Adly, B. Brogliato, B.K. Le, “Well-posedness, robustness, and stability analysis of a set-valued controller for Lagrangian systems”, *SIAM Journal on Control and Optimization*, vol. 51, no 2, pp.1592-1614, 2013.
- [52] J.J. Moreau, “Unilateral contact and dry friction in finite freedom dynamics”, in *Nonsmooth Mechanics and Applications* (J.J. Moreau, P.D. Panagiotopoulos, Eds.), CISM Courses and Lectures, vol. 302, pp.1-82, Springer-Verlag, Int. Center for Mechanical Sciences, Udine, Italy, 1982.
- [53] F. Miranda-Villatoro, B. Brogliato, F. Castanos, “Set-valued sliding-mode control of uncertain linear systems: Continuous and discrete-time analysis”, *SIAM Journal on Control and Optimisation*, vol. 56, no 3, pp. 1756-1793, 2018.
- [54] M.K. Camlibel, L. Iannelli, A. Tanwani, S. Trenn, “Differential-algebraic inclusions with maximal monotone operators”, 55th IEEE Conf. on Decision and Control, Las Vegas, USA, 12-14 December 2016, pp.610-615.
- [55] G.B. Stan, R. Sepulchre, “Analysis of interconnected oscillators by dissipativity theory”, *IEEE Transactions on Automatic Control*, vol. 52, no 2, pp. 256-270, 2007.
- [56] D. Gadjov, L. Pavel, “A passivity-based approach to Nash equilibrium seeking over networks”, *IEEE Transactions on Automatic Control*, vol. 64, no 3, pp. 1077-1092, 2019.
- [57] S. Greenhalgh, V. Acary, B. Brogliato, “On preserving dissipativity properties of linear complementarity dynamical systems with the  $\theta$ -method”, *Numerische Mathematik*, vol. 125, pp. 601-637, 2013.
- [58] D.S. Bernstein, *Matrix Mathematics. Theory, Facts and Formulas*. Princeton University Press, 2nd Edition, 2009.
- [59] F. Facchinei and J.S. Pang, *Finite-Dimensional Variational Inequalities and Complementarity Problems, Volume I*. Springer-Verlag, Series in Operations Research, New York, Berlin, Heidelberg, 2003.

- [60] H. Brezis, A. Haraux, “Image d’une somme d’opérateurs monotone et applications”, *Israel Journal of Mathematics*, vol. 23, n0 2, pp.165-186, 1976.
- [61] L. Han, A. Tiwari, M.K. Camlibel, and J.-S. Pang, “Convergence of time-stepping schemes for passive and extended linear complementarity systems”, *SIAM Journal on Numerical Analysis*, vol. 47, no 5, pp.3768-3796, 2009.
- [62] M.K. Camlibel, W.P.M.H. Heemels, and J.M. Schumacher, “Consistency of a time-stepping method for a class of piecewise linear networks”, *IEEE Transactions on Circuits and Systems I*, vol. 49, no 3, pp.349-357, 2002.
- [63] M.K. Camlibel, *Complementarity Methods in the Analysis of Piecewise Linear Dynamical Systems*. Ph.D. Thesis, Katholieke Universiteit Brabant, NL, 2001.
- [64] B.K. Le, “On a class of Lur’e dynamical systems with state-dependent set-valued feedback”, *Set-Valued and Variational Analysis*, vol. 28, pp. 537-557, 2020.
- [65] B.K. Le, “Well-posedness and nonsmooth Lyapunov pairs for state-dependent maximal monotone differential inclusions”, *Optimization*, vol. 69, no 6, pp. 1187-1217, 2020.
- [66] V. Acary, B. Brogliato, *Numerical Methods for Nonsmooth Dynamical Systems. Applications in Mechanics and Electronics*. Springer-Verlag Berlin Heidelberg, Lecture Notes in Applied and Computational Mechanics, vol. 35, 2008.
- [67] R. Scherer, “Algebraic characterization of  $A$ -stable Runge-Kutta methods”, *Applied Numerical Mathematics*, vol. 5, pp.133-144, 1989.
- [68] R. Scherer, W. Wendler, “Complete algebraic characterization of  $A$ -stable Runge-Kutta methods”, *SIAM Journal on Numerical Analysis*, vol. 31, no 2, pp.540-551, 1994.
- [69] M.K. Camlibel, R. Frasca, “Extension of Kalman-Yakubovich-Popov lemma to descriptor systems”, *Systems and Control Letters*, vol. 58, no 12, pp. 795-803, 2009.
- [70] R.W. Freund, F. Jarre, “An extension of the positive real lemma to descriptor systems”, *Optimization Methods and Software*, vol. 19, n0 1, pp. 69-87, 2004.
- [71] C.H. Lamarque, A. Ture Savadkoohi, “Passive control of differential algebraic inclusions - General method and a simple example”, in *Advanced Topics in Nonsmooth Dynamics*, R.I. Leine, V. Acary, O. Brüls (Eds.), Springer International Publishing AG, part of Springer Nature, pp.269-289, 2018.
- [72] A.J. van der Schaft, H. Schumacher, *An Introduction to Hybrid Dynamical Systems*, Springer-Verlag London, Lecture Notes in Control and Information Sciences, vol. 251, 2000.
- [73] A. Bacciotti, F. Ceragioli, “Stability and stabilization of discontinuous systems and nonsmooth Lyapunov functions”, *ESAIM Control, Optimisation and Calculus of Variations*, vol.4, pp.361-376, 1999.

## **Author Biography**

2        Bernard Brogliato was born in Saint-Symphorien-de-Lay in 1963. He graduated from Ecole  
Normale Supérieure de Cachan (Mechanical Engineering) in 1987. He obtained his Ph.D. from  
4 Grenoble INP in January 1991, and his Habilitation à Diriger des Recherches in November  
1995. He worked at CNRS from 1991 to 2001, and at INRIA since 2001. His main research  
6 interests are in nonsmooth dynamical systems analysis, control and modeling, and in dissipative  
dynamical systems.

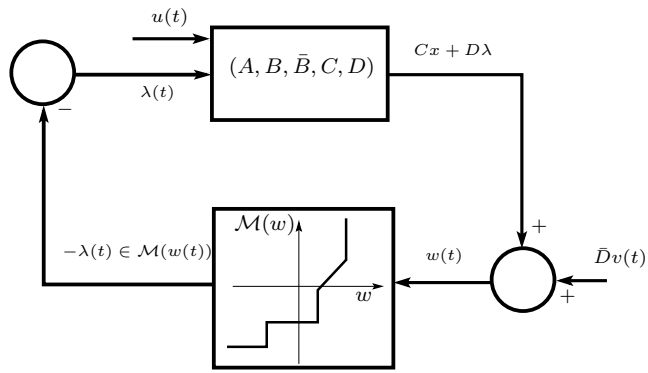

Figure 1: The class of set-valued systems in (1).

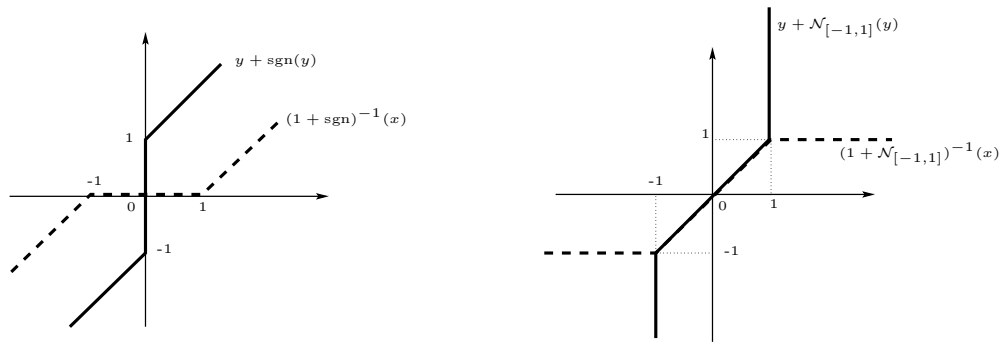

Figure 2: Examples of operators  $\mathcal{F}(\cdot) = (D + \mathcal{M}^{-1})^{-1}(\cdot)$  and  $\mathcal{F}^{-1}(\cdot) = (D + \mathcal{M}^{-1})(\cdot)$ .

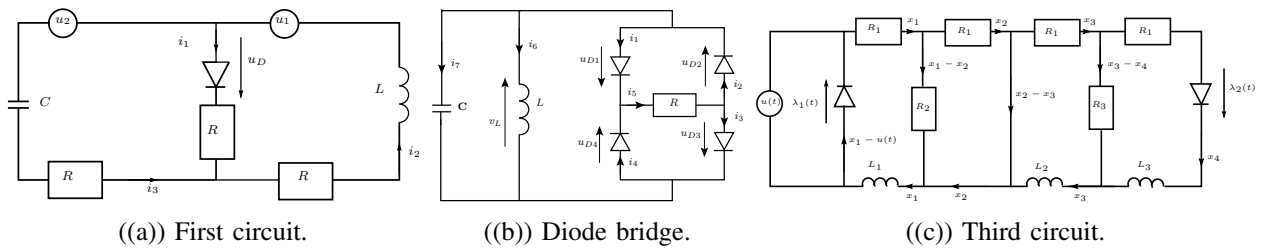
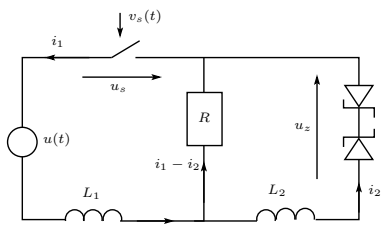
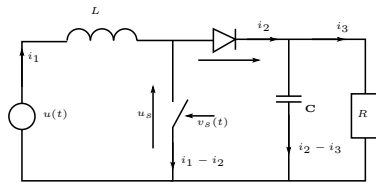

Figure 3: Electrical or hydraulic circuits.



((a)) Switch and Zener diodes.



((b)) Boost converter.

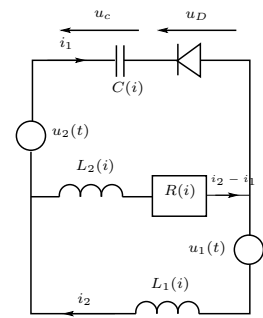

((c)) *RLCD* circuit.

Figure 4: Three simple circuits.

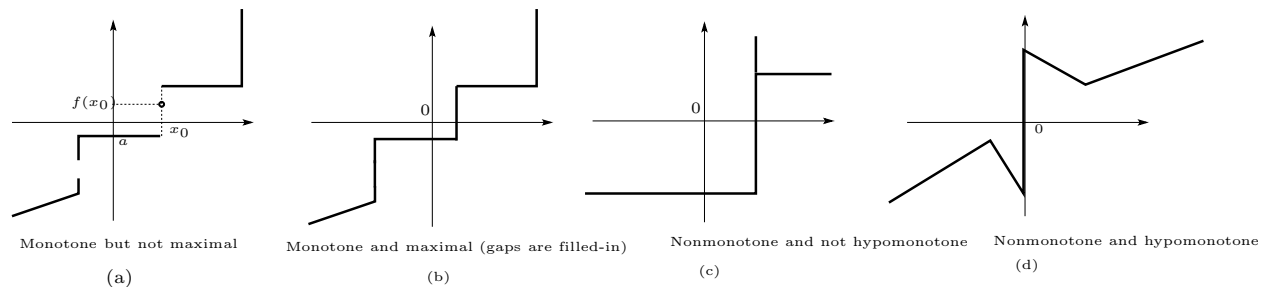

Figure 5: Examples of monotone and nonmonotone mappings.