



HAL
open science

Analog IFoF/mmWave 5G Optical Fronthaul Architecture for Hot-Spots Using Multi-channel OFDM-Based WDM Signals

Charoula Mitsolidou, Christos Vagionas, Agapi Mesodiakaki, Pavlos Maniotis,
George Kalfas, Chris Roeloffzen, Paulus Dijk, Ruud M. Oldenbeuving, Amalia
Miliou, Nikos Pleros

► To cite this version:

Charoula Mitsolidou, Christos Vagionas, Agapi Mesodiakaki, Pavlos Maniotis, George Kalfas, et al.. Analog IFoF/mmWave 5G Optical Fronthaul Architecture for Hot-Spots Using Multi-channel OFDM-Based WDM Signals. 23th International IFIP Conference on Optical Network Design and Modeling (ONDM), May 2019, Athens, Greece. pp.504-515, 10.1007/978-3-030-38085-4_43 . hal-03200670

HAL Id: hal-03200670

<https://inria.hal.science/hal-03200670>

Submitted on 16 Apr 2021

HAL is a multi-disciplinary open access archive for the deposit and dissemination of scientific research documents, whether they are published or not. The documents may come from teaching and research institutions in France or abroad, or from public or private research centers.

L'archive ouverte pluridisciplinaire **HAL**, est destinée au dépôt et à la diffusion de documents scientifiques de niveau recherche, publiés ou non, émanant des établissements d'enseignement et de recherche français ou étrangers, des laboratoires publics ou privés.



Distributed under a Creative Commons Attribution 4.0 International License

Analog IFoF/mmWave 5G Optical Fronthaul Architecture for Hot-Spots using Multi-Channel OFDM-based WDM signals

Charoula Mitsolidou^{1[0000-0003-2237-9157]}, Christos Vagionas¹, Agapi Mesodiakaki¹, Pavlos Maniotis¹, George Kalfas¹, Chris G. H. Roeloffzen², Paulus W. L. van Dijk², Ruud M. Oldenbeuving², Amalia Miliou¹ and Nikos Pleros¹

¹ Dept. of Informatics, Aristotle University of Thessaloniki, Thessaloniki, Greece

² LIONIX International B.V., Enschede, The Netherlands

cvmitsol@csd.auth.gr

Abstract. An analog Intermediate-Frequency-over-Fiber (IFoF) – based fronthaul 5G architecture for high traffic hot-spot environments is presented. The proposed optical fronthaul link utilizes Photonic Integrated Circuit (PIC) Wavelength Division Multiplexing (WDM) Externally Modulated Laser (EML) - based optical transmitters at a centralized Base Band Unit (BBU) and Reconfigurable Optical Add-Drop Multiplexers (ROADMs) at the Remote Radio Head (RRH) side located in the hot-spot area. By employing two WDM links, where each wavelength carries six 0.5 Gbaud IF bands of Orthogonal Frequency Division Multiplexing (OFDM) with 16 – QAM Sub-Carrier (SC) modulation, a total data rate of 96 Gb/s was achieved. Error Vector Magnitude (EVM) measurements were carried out, exhibiting acceptable performance below the EVM FEC limit of 12.5 %. A power budget study was also performed, suggesting up to 9.5 km fiber lengths between the BBU and the hot-spot network. The proposed architecture complies with the high capacity and low latency requirements of the 5G vision, thus may be an efficient solution for 5G fronthauling of heavy traffic hot-spot areas.

Keywords: 5G networks, analog fronthaul, Intermediate Frequency over Fiber, OFDM, Photonic Integrated Circuit, ROADM.

1 Introduction

The insatiable mobile data traffic growth in combination with the exponential proliferation of smart mobile devices [1], have created a new set of bandwidth and latency requirements beyond the capabilities of the legacy 4G mobile networks. To this end, Fifth Generation (5G) networks have already stepped in as the next generation technology for broadband mobile connectivity [2]. Towards satisfying user's experience, 5G broadband access has been defined by expert alliances through Key Performance Indicators (KPIs) that foresee user rates of 1 Gb/s and peak rates up to 10 Gb/s at latencies less than 10 ms, resulting in high area connection densities up to 10^6 devices

per km² [3]. To address the 5G goals, intense research efforts have directed on the development of New Radio (NR) systems [4] and the introduction of millimeter Wave (mm-Wave) spectral bands of 28 GHz and 60 GHz in the access networks [5].

The initial 5G trials are expected to be deployed at densely populated areas and overcrowded hotspots, such as stadiums, airports etc., where the density of the users may result on financially viable installations [6]. However, moving to the New Radio systems comes with the need for densification of the Access Points (APs), in order to cope with the high propagation losses of the mm-Wave band [7], bringing at the same time increased deployment costs. To alleviate the densification costs, operators gradually focus on the Centralized RAN (C-RAN) technology [8] that shifts the demanding operations at the Central Office (CO), while simplifying the hardware of the APs.

However, the cost-reduction due centralization does not alleviate on its own the upcoming fronthaul explosion [9], which necessitates the transmission of ultra-broadband mm-Wave channels at a small latency and energy envelope. Towards developing 5G NR systems capable to follow this explosion, research and industry efforts have been directed on the adoption and optimization of specific key technologies.

One of the directions is to employ the technology that can seamlessly combine the wireless access networks with the optical transport. Since optical fiber has chosen as the means to transport data to the centralized Base-Band Units (BBUs), analog Intermediate Frequency over Fiber (IFoF) technology [10] is currently investigated as an efficient fronthaul technique for distributing data from the BBU to a large number of Remote Radio Heads (RRHs) in a bandwidth- and cost-efficient manner. The advantage of IFoF is that it utilizes aggregation of mobile signals in intermediate frequencies and modulation with cost-efficient and low bandwidth devices [11], without adding any extra delay due to digital procedures as in the equivalent Common Public Radio Interface (CPRI)-based schemes [12]. Up to now, most of the analog IFoF-based demonstrations have been mainly evaluated for single carrier data signals with bandwidth up to 1Gb/s [11], or for OFDM signals with channel bandwidth less than 200 MHz [10, 13-14].

Another physical-layer key technology for cost efficient fronthauling, is the Photonic Integrated Circuit (PIC) technology that has already proved beneficial for optical communications [15]. Based on already developed PIC technologies which mainly include linear analog transceivers with high peak data rates beyond the 10 Gb/s [16] and low-loss integrated Reconfigurable Add/Drop Optical Multiplexer (ROADMs), 5G networks can be evolved into larger-scale and denser topologies utilizing the cost, energy and size benefits of PICs. So far, the advantages of using PIC - based transceivers and wavelength multiplexing devices have been investigated only for metro-rings and PON networks [17].

Finally, another key direction for achieving efficient fronthauling is the development of Medium Access Control (MAC) protocols capable to allocate all available optical, wireless and time-domain resources of a converged Fiber-Wireless (FiWi) network, while simultaneously satisfying the low latency KPI constraints [18]. Recently, we investigated the employment of a Medium-Transparent resource allocation scheme in a hotspot FiWi 5G network, achieving adequate throughput and latency

values [19]. However, this analysis was based on certain physical - layer assumptions since the hardware specifications were not available at that time.

Although significant research advances have been reported for each of the above key technologies individually, yet it remains a research gap on defining the physical – layer specifications of a fronthaul architecture that will incorporate all distinct technological aspects in the same scheme, while simultaneously meet the 5G KPI requirements. Towards addressing this research gap, we extend our previous MAC-layer related work [19], by providing a detailed physical – layer study of the proposed analog IFoF 5G fronthaul architecture for hot-spot areas. The architecture employs photonic integrated Indium Phosphide (InP) transmitters at the BBU and optical buses of WDM-ROADMs at the hot-spot area. Our analysis relies on experimentally verified simulation models of the optical transceivers as well as the signal degradation induced by the fiber-propagation, while WDM functionalities are leveraged by a low-loss photonic integrated $\text{Si}_3\text{N}_4/\text{SiO}_2$ ROADM design. The transmission of 6-IF band OFDM 16-QAM signals was successfully confirmed by Error Vector Magnitude (EVM) measurements, revealing performance above the commonly acceptable limits.

This paper is organized as follows: Section II presents the concept of the proposed 5G hot-spot architecture, while Section III shows the simulation modeling of the employed building blocks. The physical - layer evaluation of optical fronthaul link is presented in Section IV. Section V provides the conclusion of the work.

2 5G Fronthaul architecture for stadiums

The concept of the proposed 5G fronthaul architecture, serving a typical sport-stadium is depicted in Fig. 1. In this architecture, the BBU is located in a centralized location outside the hot-spot area of the stadium and is interconnected with the RRH units which are dispersed around the stadium, through fiber links.

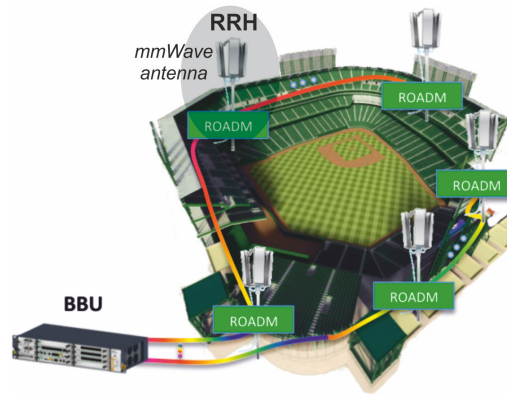

Fig. 1. Conceptual representation of the 5G IFoF/mmWave fronthaul architecture for hot-spot stadiums.

WDM optical transmitters based on photonic integrated Externally Modulated Laser (EML) modulators are employed at the BBU side, in order to generate and transmit the IFoF signals to the hot-spot area where the RRHs are placed at different regions of the stadium in an optical bus topology. Each RRH consists of an optical ROADM that either drops any of the wavelengths at the connected RRH or sends it to the next RRH of the bus. Moreover, each RRH incorporates a number of antennas that are responsible for optical - to - IF and subsequently IF - to - mmWave conversion before the wireless transmission to the clients. It should be noted that multi - IF bands transmission per wavelength is supported, allowing in this way each wavelength to carry different user channels on different IF bands.

Based on this concept, our goal is to design a fronthaul architecture according to the requirements of the 5G vision by identifying what is the optimum set of resources in terms of fiber-lengths, optical losses, number of wavelengths, modulation etc., while simultaneously complying with the physical layer performance metrics of the available hardware and providing a low cost and power consumption solution.

3 Simulation Modeling

In order to ensure that the simulation results used for the physical layer performance evaluation of the proposed fronthaul are reliable, we created experimentally-verified simulation models of the main building blocks employed in the simulation setup. Particularly, the response of the employed optical modulator was matched with the respective experimental characterized behavior of a high -power linear InP - based EML [16], while the signal impairments (losses, chromatic dispersion) caused by the fiber transmission, were matched with the respective response of a Standard Single Mode Fiber (SMF) [20]. The simulation model of the ROADM was also matched with the estimated spectral response of a MZI - based ROADM design being currently fabricated on the TriPleX platform [21]. Fig. 2 depicts the simulation model results of the EML, perfectly matched with the experimentally-verified response of a fabricated InP - based linear EML operating in the C - band and comprising a laser source co-integrated with an Electro Absorption Modulator (EAM) [16].

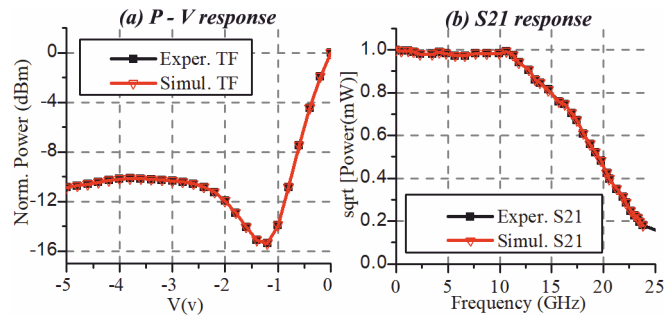

Fig. 2. EML modeling: a) Power versus Volts experimental and simulated transfer functions, b) experimental and simulated S21 curves.

More specifically, Fig. 2 (a) shows the experimentally - measured and the simulated curve of the normalized output optical power versus the input voltage, revealing identical responses for both curves with a linear regime between -1 V and -0.2 V and an Extinction Ratio (ER) of 12 dB. The experimentally – measured and the simulated electro - optic S21 curves of the EML are illustrated in Fig 2 (b) exhibiting identical characteristics with a flat - top spectral response up to 11 GHz.

Fig. 3 (a) presents the cascaded MZI-based ROADM design [22] that is currently fabricated on the Si₃N₄/SiO₂ TriPleX platform [21] and its estimated spectra response was used for the matching procedure of the ROADM simulation model. The employed ROADM that was designed by Lionix International [23] for operation in the C – band, is capable to add or drop four wavelengths spaced with 100 GHz channel spacing. The four wavelengths ($\lambda_1, \lambda_2, \lambda_3, \lambda_4$) are inserted into the first cascaded block of MZIs depicted in Fig. 3 (a) with the green color, having a Free Spectral Range (FSR) of 200 GHz. Wavelengths λ_1 and λ_3 separated with 200 GHz channel spacing are exiting output port 1 of the MZI cascade, while wavelengths λ_2 and λ_4 again spaced with 200 GHz are exiting output port 2. The WDM signal carrying λ_1 and λ_3 is fed into the brown block of MZIs of the ROADM upper arm that has a FSR of 400 GHz. As it is shown in Fig. 3 (a) the first cascade of 400 GHz FSR drops λ_1 , while the second block of MZIs with 400 GHz FSR drops λ_3 . In a similar manner, the WDM signal carrying λ_2 and λ_4 is directed at the lower arm of the ROADM, where the first brown cascade of MZIs having a FSR of 400 GHz drops λ_4 at its output port 1 and the second cascade drops λ_2 at its respective output port 1.

Fig. 3 (b) shows the configuration of the cascaded MZIs used as a building block in the ROADMs. This configuration consists of two MZIs connected with Tunable Couplers (TCs) whose coupling coefficients can be properly adjusted in order to obtain the proper spectral response at the output of the cascade. The first MZI has an arm length difference of $2dL$, while the arm length difference of the second MZI is equal to dL . The longer arms of $2dL$ and dL of the respective MZIs are placed on the opposite sides of the waveguides in order to minimize the dispersion effect. Phase Shifters (PSs) are employed in the longest arm of each MZI to control the spectral position of the MZI's filter, allowing in this way to drop each time the proper wavelength.

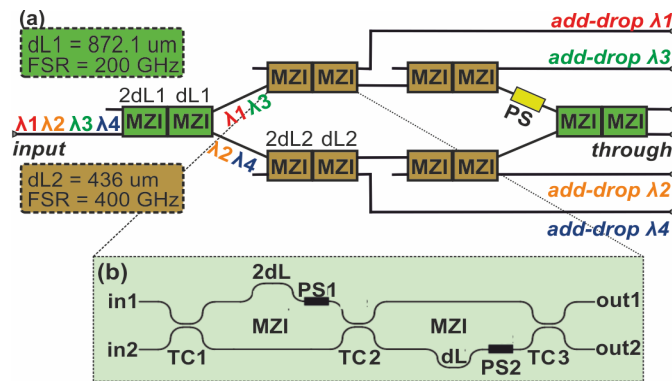

Fig. 3. a) ROADM design based on cascaded MZIs, b) building block of the cascaded MZIs.

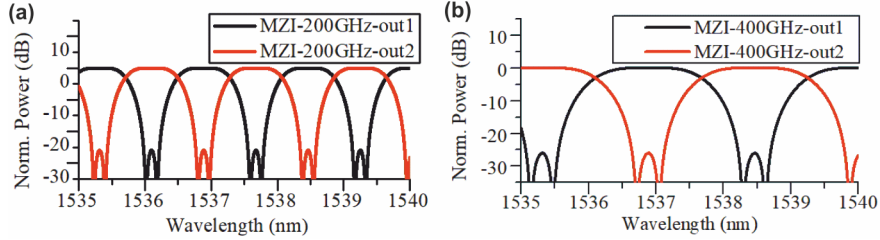

Fig. 4. ROADM modeling: Simulated spectral response of the cascaded MZIs' filters with: a) FSR = 200 GHz (green MZIs), b) FSR = 400 GHz (brown MZIs).

The arm difference $dL1$ for the cascade of MZIs with FSR equal to 200 GHz, was chosen to be 872.1 μm , while the arm difference $dL2$ for the cascaded MZIs of 400 GHz FSR, was chosen to be equal to 436 μm . The total losses of the ROADM were calculated to be up to 3.1 dB, taking into account the fiber in/out interfaces and the propagation losses of the waveguides.

Fig. 4 (a) depicts the spectral response for the output ports of the cascaded MZIs with the FSR of 200 GHz, which is responsible for splitting λ_1 (1536.9 nm), λ_3 (1538.46 nm) from λ_2 (1537.67 nm), λ_4 (1539.25 nm) at its output ports 1 and 2, respectively. Fig. 4 (b) illustrates the spectral response for both outputs of the cascade of MZIs that has a FSR equal to 400 GHz and is depicted with the brown color in Fig. 3 (a). The filtering response of the cascade shown in Fig. 4 (b) allows for separating λ_1 from λ_3 and λ_2 from λ_4 . It is worth mentioning that both spectral responses, shown in Fig. 4, exhibit flat-top filter shape by properly setting the values of the coupling coefficients TC1, TC2, TC3 equal to 0.9248, 0.28 and 0.5, respectively.

4 Optical Fronthaul Performance Evaluation

In this section, we present the physical - layer simulations performed with the aid of VPI photonics software [24], in order to evaluate the performance of the proposed analog optical fronthaul link when a multi-IF band WDM signal with OFDM - based format and SC modulation of 16 - QAM is transmitted. The employed setup of the WDM hot-spot link as well as the physical layer results will be presented. It should be mentioned that the matched simulation models, described in the previous section were employed in order to provide a reliable performance evaluation study.

4.1 Simulated Setup

Fig. 5 illustrates the setup employed for the performance evaluation of the optical WDM downlink transmission from the BBU to the RRH side comprising four ROADMs interleaved in an optical bus for serving half of hot-spot area (e.g. sports stadium). The other half of the stadium is served by another independent and identical transmission link, thus without loss of generality we focus only on one of the two transmission links. As shown in Fig. 5, the BBU consists of a WDM transmitter that

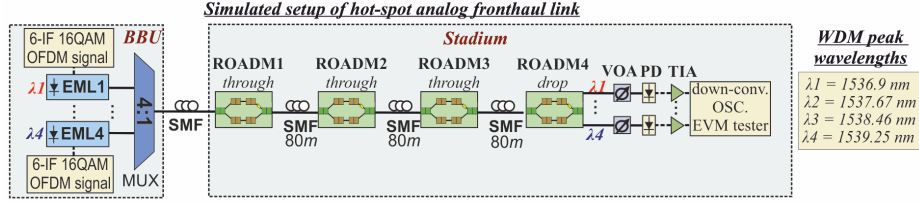

Fig. 5. Simulated setup of the analog multi - IFoF optical fronthaul, comprising the WDM EML-based transmitter at the BBU side and the ROADM bus at the stadium side.

employs four EML modules, modulating the respective Continuous Waves (CWs) at the peak wavelengths of 1536.9 nm, 1537.67 nm, 1538.46 nm and 1539.25 nm. Each EML is driven by a different multi - IF band electrical signal consisting of six OFDM waveforms that are generated and up-converted to six different IF frequencies.

Table 1 summarizes the waveform parameters of the aggregated multi – IF band OFDM signal. Particularly, six IF bands with peak frequencies at 3.8 GHz, 4.4 GHz, 5 GHz, 5.6 GHz, 6.2 GHz and 6.8 GHz were employed, with each of them occupying a bandwidth of 0.5 GHz and consisting of 256 SCs. Each SC has a baud rate of 1.953 Mbd and a modulation format of 16 - QAM, resulting on a data rate of 2 Gb/s per IF channel. The six IF bands are separated by a guard band of 100 MHz. Thus, the aggregated data rate of all IF bands fed into the EML is equal to 12 Gb/s for a total occupied bandwidth of 3.5 GHz.

Table 1. Waveform Parameters

Parameter	Value	Parameter	Value
Modulation	OFDM 16-QAM	SC baud-rate	1.953 MBaud
IF bands	6	Data rate per IF	2 Gb/s
IF center frequencies	3.8, 4.4, 5, 5.6, 6.2, 6.8 (GHz)	Channel guard band	100 MHz
BW per IF band	0.5 GHz	BW per λ	3.5 GHz
SC per IF band	256	Data rate per λ	12 Gb/s

The voltage swing of the electrical signal entering the EAM section of the respective EML is adjusted to the value of 0.7 Vpp and the bias voltage is set to -0.4 V achieving in this way operation in the linear region of the EAM. The laser section of each EML was set to its maximum optical power, resulting on an optical signal with an average modulated power of 2.8 dB [16] for each of the WDM channels exiting the respective EML. The outputs of the four EMLs are multiplexed by a 4:1 optical Multiplexer (MUX) and the resultant WDM stream is transmitted through a SMF to the ROADM bus located in the stadium hot-spot area (half part of the stadium). The data rate of the transmitted WDM signal is equal to 48 Gb/s (12 Gb/s per λ), resulting in a total data rate of 96 Gb/s when two identical optical links are used, as it is proposed in our fronthaul network. At the stadium side, the employed four ROADMs are capable to add or drop any of the four WDM channels originated by the BBU. The four ROADMs are placed around the stadium's periphery in a bus topology with the

neighboring ROADMs equally spaced at 80 m. The distance between the ROADMs was chosen based on the actual diameter of a typical football - stadium [25]. In this setup, we focused on the worst case scenario, where all the WDM channels crossed through the first three ROADMs of the bus and dropped by the longest reach forth ROADM. The dropped demultiplexed optical signals are fed into an array of four photo-receivers for optical-to-electrical conversion by the Photo-Diode (PD) and amplification by the Transimpedance Amplifier (TIA). The outputs of the TIAs are down-converted and captured by the EVM tester. VOAs were used for controlling the received optical power entering the PD.

4.2 Results

In this sub-section, we present the physical-layer performance evaluation study of the optical fronthaul link, considering that the WDM multi-IF data signal crosses through the three first ROADMs and is received by the last 4th ROADM of the optical bus. The length of the SMF connecting the BBU with the 1st ROADM was set equal to 500 m and the minimum Received Optical Power (ROP) corresponding to the first IF band was equal to -13 dBm, calculated by taking into account the maximum losses of all building blocks of the evaluated link. Fig. 6 (a) presents the EVM value per SC index of all IF bands for the first WDM channel at the $\lambda_1 = 1536.9$ nm. As it can be observed, the first IF band at 3.8 GHz exhibited the worst performance with the EVM values of the SCs ranging from 7.3 % to 9.4 %, while the last IF of 6.8 GHz showed the best performance with EVMs between 4.6 % - 5.9 %. Fig. 6 (b) and (c) depicts the constellation diagrams for the worst performing SCs of the outermost IF bands of 3.8 GHz and 6.8 GHz, exhibiting EVMs equal to 9.4 % and 5.9 %, respectively. This non-equal performance of the 6 IF channels, is attributed to the filtering effect that the signal experiences as it crosses through the hot-spot link, resulting to partially uneven losses and not ideally flat channel response. Similar performance was obtained for all the other WDM channels with EVM values below the 3GPP threshold of 12.5 % [26].

Fig. 7 depicts the EVM measurements for the worst performing 16-QAM modulated SC of each WDM channel versus the ROP of the data signal inserted into the array

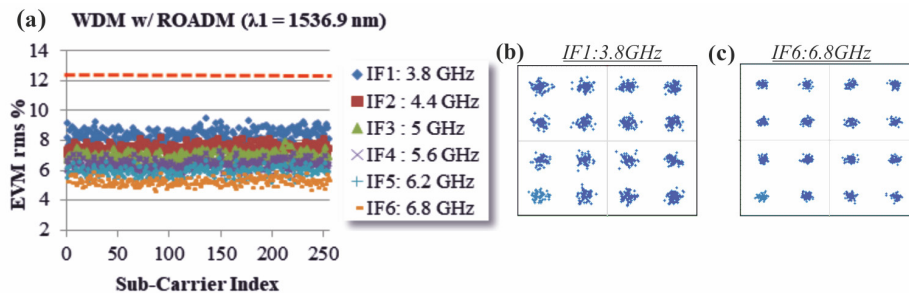

Fig. 6. a) EVM per sub-carrier for all IF bands for $\lambda_1 = 1536.9$ nm at a minimum received optical power of -13 dBm, b) constellation diagram for the first IF band at 3.8 GHz and c) the last IF band at 6.8 GHz.

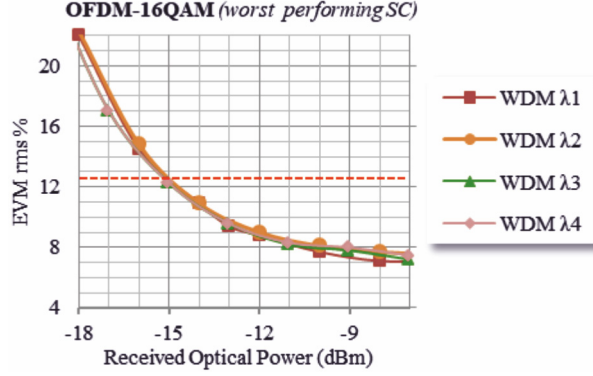

Fig. 7. EVM versus ROP (dBm) for the worst performing SC of each WDM channel.

of PDs connected with the drop ports of the fourth ROADM. The WDM signal was transmitted from the BBU to the hot-spot stadium area through a 500 m SMF, crossed the first three ROADMs and dropped by the 4th ROADM. As it is shown, all wavelengths ($\lambda_1, \lambda_2, \lambda_3, \lambda_4$) exhibit similar performance, achieving an EVM below the 12.5 % threshold for a ROP value of -15 dBm. This measurement indicates that the dropped data signals reaching the PDs of the longest-reach ROADM should have an optical power higher than -15 dB for exhibiting adequate performance.

Thus, in order to investigate the feasibility of the proposed fronthaul link with the employed hardware, we performed a power budget study for calculating the actual optical power entering the PDs of the fourth ROADM, based on the losses of the individual devices. Table 2 presents the power budget parameters of all building blocks incorporated in the link, with the EML exhibiting a modulated average output optical power (P_{OUT}) of 2.8 dBm [16], the MUX (L_{MUX}) and the ROADM (L_{ROADM}) adding 1.5 dB and 3.1 dB losses, while the SMF (L_{SMF}) inserting propagation losses of 0.25 dB/km [20]. The actual ROP is calculated as by subtracting the sum of the losses from the output power of the signal exiting the EML, as shown in (1):

$$\text{actual ROP} = P_{OUT} - L_{MUX} - N * L_{ROADM} - \text{length} * L_{SMF} \quad (1)$$

, where N is the number of the ROADMs in the optical bus and length the total SMF length including both the fiber connecting the BBU with the first ROADM and the fiber links connecting the neighboring ROADMs.

Table 2. Power Budget Parameters

Building Block	Value
EML modulated average output power (P_{OUT})	2.8 dBm
MUX losses (L_{MUX})	1.5 dB
SMF propagation losses (L_{SMF})	0.25 dB/km
ROADM losses (L_{ROADM})	3.1 dB (max.)

By considering a number of 4 ROADMs, a fiber link of 500 m between the BBU-first ROADM and fiber links of 80 m between the adjacent ROADMs and utilizing the parameter values shown in Table 2, the actual ROP was calculated equal to -11.3 dBm. Since this value is higher than the required ROP of -15 dBm derived by the EVM measurements in Fig. 7, the applicability of the proposed 5G fronthaul link was successfully confirmed for WDM signals with OFDM waveform and 16-QAM SC modulation.

Towards investigating the longest distance between the BBU and the hot-spot area, we performed a fiber length study with the main criteria being the actual ROP calculated from the power budget analysis of the system (Eq. 1) to be higher than the ROP required in order to achieve an EVM value less than 12.5 %. In this study we employed the setup shown in Fig. 5, using different values for the length of the SMF interconnecting the BBU with the first ROADM.

Fig. 8 illustrates the *ROP* versus the SMF *length* connecting the BBU and the first ROADM, where the red line corresponds to the actual *ROP* in dBm reaching the PDs of the 4th ROADM, calculated by Eq. 1. By substituting the values of Table 2 and varying the length parameter from 0 km to 12 km, the actual *ROP* was linearly decreased from -11.1 dB at 0 km to -14.1 dB at 12 km. The other four curves show the ROP required at the input of the PDs connecting with the fourth ROADM, in order to achieve an EVM value below the acceptable limit of 12.5 %. Each of these curves corresponds to the worst performing SC of a different WDM channel. As it can be observed, the EVM degrades for all channels as the fiber length increases due to the signal impairing effect of the chromatic dispersion. By comparing the actual and the required *ROP*, it can be seen that these curves cross at a length of 9.5 km. Before this crossing point the actual *ROP* stemming from Eq. 1 is higher than the required *ROP*, revealing that the longest reach to place the BBU from the hot-spot area is equal to 9.5 km. Considering that the proposed fronthaul architecture targets on hot-spot networks where all the clients are gathered to a specific geographical area, the BBU box is expected to be placed not more than a few km from the hot-spot, with the fiber length of 9.5 km satisfying the above requirement.

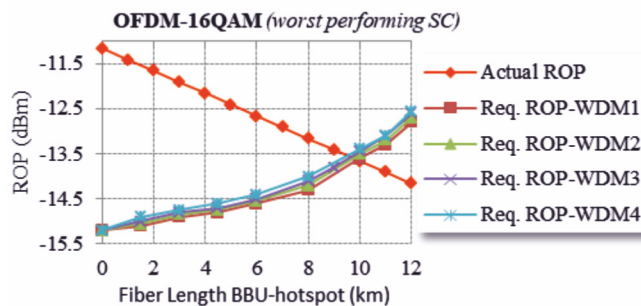

Fig. 8. *ROP* versus the length of the SMF fiber connecting the BBU with the first ROADM. Curve of the actual *ROP* deriving from the power budget of the hot-spot link and curves of the *ROP* required to achieve an EVM = 12.5 % (3GPP threshold) for all WDM channels.

5 Conclusion

We designed and evaluated an analog optical 5G fronthaul architecture for serving the bandwidth - demanding needs of hot-spot areas, such as sport-stadiums. The proposed cost-effective fronthaul scheme comprises a centralized Baseband Unit (BBU) with low cost WDM PIC-based optical transmitters and Remote Radio Heads (RRHs) on bus topology equipped with wavelength selective PIC-based ROADMs. By exploiting the WDM technology and using 6-band OFDM with 0.5 Gbaud 16-QAM modulation format, an aggregate capacity up to 96 Gb/s was achieved when two WDM links were employed. We also carried out a power budget study, showing the feasibility to locate the BBU equipment in a distance up to 9.5 km from the hot-spot area.

Acknowledgment: This work is supported by H2020-5G PPP 5G-PHOS (grant agreement 761989) and MSCA ITN 5G STEP-FWD (grant agreement 722429).

References

1. Ericsson. Ericsson Mobility Report, <https://www.ericsson.com/en/mobility-report/reports/november-2018>, last accessed 2019/04/12.
2. L. Andrews et al.: What will 5G be?. *IEEE Journal on Selected Areas in Communications* 32(6), 1065-1082 (2014).
3. NGMN, NGMN 5G White paper, https://www.ngmn.org/fileadmin/ngmn/content/downloads/Technical/2015/NGMN_5G_White_Paper_V1_0.pdf, last accessed 2019/04/12.
4. S. Lien, et al.: 5G New Radio: Waveform, Frame Structure, Multiple Access, and Initial Access. *IEEE Comm. Mag.* 55(6), 64-71 (2017).
5. T. S. Rappaport, et al.: Millimeter wave mobile communications for 5G cellular: It will work!. *IEEE Access* 1, 335-349 (2013).
6. 5G Infrastructur Association, 5G Trials Roadmap, <https://5g-ppp.eu/5g-trials-roadmap/>, last accessed 2019/04/12.
7. X. Ge, S. Tu, G. Mao, C. Wang and T. Han: 5G Ultra-Dense Cellular Networks. *IEEE Wireless Comm.* 23(1), 72-79 (2016).
8. A. Checko et al.: Cloud RAN for mobile networks—A technology overview. *IEEE Commun. Surveys Tut.* 17(1), 405-426 (2014).
9. J. Kani, et. al.: Solutions for Future Mobile Fronthaul and Access-Network Convergence. *J. Lightw. Technol.* 35(3), 527-534 (2017).
10. M. Sung, et al.: Demonstration of IFoF based 5G mobile fronthaul in 28 GHz millimeter wave testbed supporting giga-bit mobile services. In: *Optical Fiber Communications Conference and Exhibition (OFC)*, Los Angeles, CA, USA, 2017.
11. C. Vagionas, et. al.: A 6-band 12Gb/s IFoF/V-band Fiber-Wireless Fronthaul link using an InP Externally Modulated Laser. In: *European Conference on Optical Communication (ECOC)*, Tu4B.6, Rome, Italy, 2018.
12. Common Public Radio Interface. Interface Specification v7.0., Oct. 2015.
13. E. Martin et. al.: 28 GHz 5G radio over fibre using UF-OFDM with optical heterodyning. In: *International Topical Meeting on Microwave Photonics (MWP)*, Beijing, China, 2017.

14. N. Shibata et al.: 256-QAM 8 Wireless Signal Transmission with DSP-Assisted Analog RoF for Mobile Front-Haul in LTE-B. In OECC/ACOFT, Melbourne, Australia, July 6-10, 2014.
15. P. J. Winzer, D. Neilson, and A. Chraplyvy: Fiber-optic transmission and networking: the previous 20 and the next 20 years. *Op. Ex.* 26 (18), 24190-24239 (2018).
16. H. Debregeas, et. al.: Record 6dBm electroabsorption modulated laser for 10Gb/s and 25Gb/s high power budget access networks. In: Optical Fiber Communications Conference and Exhibition (OFC), Los Angeles, CA, USA, 2017.
17. D. Marom, et. al.: Survey of Photonic Switching Architectures and Technologies in Support of Spatially and Spectrally Flexible Optical Networking. *IEEE/OSA Journal of Optical Commun. and Network.* 9(1), 1-26 (2017).
18. H. Shokri-Ghadikolaei, C. Fischione, G. Fodor, P. Popovski and M. Zorzi: Millimeter Wave Cellular Networks: A MAC Layer Perspective. *IEEE Trans. on Commun.* 63(10), 3437-3458 (2015).
19. G. Kalfas, et al.: Medium-transparent Packet-based Fronthauling for 5G Hot-spot Networks. In: International Conference on Transparent Optical Networks (ICTON), Bucharest, Romania. 2018.
20. Corning, LEAF Optical Fiber, <https://www.corning.com/au/en/products/communication-networks/products/fiber/leaf-fiber.html>, last accessed 2019/04/12.
21. C. G. Roeloffzen, et. al.: Low-Loss Si₃N₄ TriPleX Optical Waveguides: Technology and Applications Overview. *Journal of Sel.Top. in Quant. Electron.* 24(4), 2018.
22. F.Horst, et al: Cascaded Mach-Zehnder wavelength filters in silicon photonics for low loss and flat pass-band WDM (de-) multiplexing. *Op. Ex.* 21(10), 11652-11658 (2013).
23. LioniX International, <https://www.lionix-international.com/>, last accessed 2019/04/12.
24. VPIphotonics, <http://viphotonics.com/index.php>, last accessed 2019/04/12.
25. Toumba stadium, <https://www.stadiumguide.com/toumba/>, last accessed 2019/04/12.
26. 3GPP, TS 38.104 V15.0.0, Table 9.6.2.3-1, Dec. 2017.