



BIOFUELS FROM ALGAE

EDITORS
A. PANDEY
D.-J. LEE
Y. CHISTI
C.R. SOCCOL

BIOFUELS FROM ALGAE

Intentionally left as blank

BIOFUELS FROM ALGAE

Edited By

ASHOK PANDEY

*Council of Scientific and Industrial Research–National Institute for Interdisciplinary Science and Technology,
Trivandrum-695 019, India*

DUU-JONG LEE

Department of Chemical Engineering, National Taiwan University, Taipei, Taiwan 106

YUSUF CHISTI

*Institute of Technology and Engineering, Massey University, Private Bag 11 222,
Palmerston North, New Zealand*

CARLOS R SOCCOL

Biotechnology Division, Federal University of Parana, CEP 81531-970 Curitiba-PR, Brazil



ELSEVIER

AMSTERDAM • BOSTON • HEIDELBERG • LONDON • NEW YORK • OXFORD
PARIS • SAN DIEGO • SAN FRANCISCO • SINGAPORE • SYDNEY • TOKYO

Elsevier
30 Corporate Drive, Suite 400, Burlington, MA 01803, USA
525 B Street, Suite 1800, San Diego, CA 92101-4495, USA

First edition **2014**

Copyright © 2014 Elsevier B.V. All rights reserved.

No part of this publication may be reproduced, stored in a retrieval system or transmitted in any form or by any means electronic, mechanical, photocopying, recording or otherwise without the prior written permission of the publisher.

Permissions may be sought directly from Elsevier's Science & Technology Rights Department in Oxford, UK: phone (+44) (0) 1865 843830; fax (+44) (0) 1865 853333; email: permissions@elsevier.com. Alternatively you can submit your request online by visiting the Elsevier web site at <http://elsevier.com/locate/permissions>, and selecting Obtaining permission to use Elsevier material

Notice

No responsibility is assumed by the publisher for any injury and/or damage to persons or property as a matter of products liability, negligence or otherwise, or from any use or operation of any methods, products, instructions or ideas contained in the material herein. Because of rapid advances in the medical sciences, in particular, independent verification of diagnoses and drug dosages should be made.

British Library Cataloguing in Publication Data

A catalogue record for this book is available from the British Library

Library of Congress Cataloging-in-Publication Data

A catalog record for this book is available from the Library of Congress

For information on all **Elsevier** publications
visit our web site at store.elsevier.com

Printed and bound in Great Britain

13 14 15 16 17 10 9 8 7 6 5 4 3 2 1

ISBN: 978-0-444-59558-4



Contents

Contributors ix

Preface xi

1. An Open Pond System for Microalgal Cultivation

JORGE ALBERTO VIEIRA COSTA AND MICHELE GREQUE DE MORAIS

- 1.1 Introduction 1
- 1.2 Biotechnology and Microalgae 2
- 1.3 Open Pond Systems 3
- 1.4 Main Microalgae Cultivated in Open Pond Systems 6
- 1.5 Reactor Design 9
- 1.6 Light Regime 9
- 1.7 Hydrodynamics of the Reactor 10
- 1.8 Fixation of Carbon Dioxide (CO₂) 11
- 1.9 Temperature 11
- 1.10 pH 12
- 1.11 Sterility of Cultivation 13
- 1.12 Biomass Harvest 13
- 1.13 Drying of Biomass 15
- 1.14 Other Microalgal Culture Systems 16
- 1.15 Applications of Biomass 17
- 1.16 Conclusion 20

2. Design of Photobioreactors for Algal Cultivation

HONG-WEI YEN, I-CHEN HU, CHUN-YEN CHEN, AND JO-SHU CHANG

- 2.1 Introduction 23
- 2.2 Factors Affecting Microalgae Growth and Biofuels Production 24
- 2.3 Photobioreactor Design Principles 27
- 2.4 Microalgae Cultivation in Closed and Open PBRs for Biofuel Production 28
- 2.5 Commercial Microalgae Cultivation Systems for Biofuel Production 36
- 2.6 Conclusions 43

3. Metabolic Engineering and Molecular Biotechnology of Microalgae for Fuel Production

SU-CHIUNG FANG

- 3.1 Introduction 47
- 3.2 Biodiesel 48
- 3.3 Biohydrogen 52
- 3.4 Other Strategies 58
- 3.5 Challenges and Perspectives 59

4. Respirometric Balance and Carbon Fixation of Industrially Important Algae

EDUARDO BITTENCOURT SYDNEY, ALESSANDRA CRISTINE NOVAK, JULIO CESAR DE CARVALHO, AND CARLOS RICARDO SOCCOL

- 4.1 Introduction 67
- 4.2 Carbon Dioxide Fixation by Microalgae 73
- 4.3 Practical Aspects of Mass Cultivation for CO₂ Fixation 79
- 4.4 Carbon Market for Microalgal Technologies 81

5. Algal Biomass Harvesting

KUAN-YEOW SHOW AND DUU-JONG LEE

- 5.1 Introduction 85
- 5.2 Stability and Separability of Microalgae 86
- 5.3 Methods of Algae Harvesting 89
- 5.4 Challenges and Prospects 104
- 5.5 Conclusions 106

6. Heterotrophic Production of Algal Oils

JIN LIU, ZHENG SUN, AND FENG CHEN

- 6.1 Introduction 111
- 6.2 Heterotrophy of Microalgae 112
- 6.3 Potential of Heterotrophic Algal Oils 113

- 6.4 Factors Affecting Heterotrophic Production of Algal Oils 119
- 6.5 High Cell Density of Heterotrophic Algae 124
- 6.6 *Chlorella* as the Cell Factory for Heterotrophic Oils 129
- 6.7 Possible Improvements of Economics in Heterotrophic Algal Oils 133
- 6.8 Conclusions 135
- 7. Production of Biofuels from Algal Biomass by Fast Pyrolysis**
- CARLOS JOSÉ DALMASNETO, EDUARDO BITTENCOURT SYDNEY, RICARDO ASSMANN, DOLIVARCORAUCI NETO, AND CARLOS RICARDO SOCCOL
- 7.1 Introduction 143
- 7.2 Fast Pyrolysis 147
- 7.3 Yields and Characteristics of Pyrolysis of Algal Biomass 150
- 7.4 Conclusions 152
- 8. Algae Oils as Fuels**
- S. VENKATA MOHAN, M. PRATHIMA DEVI, G. VENKATA SUBHASH, AND RASHMI CHANDRA
- 8.1 Introduction 155
- 8.2 Cellular Biochemistry Toward Lipid Synthesis 157
- 8.3 Nutritional Mode of Microalgae 161
- 8.4 Substrates for Microalgae Growth and Lipid Production 166
- 8.5 Microalgae Cultivation 168
- 8.6 Preparation of Algal Fuel/Biodiesel 171
- 8.7 Transesterification 175
- 8.8 Algal Fuel Properties 177
- 8.9 Concluding Remarks 180
- 9. Production of Biohydrogen from Microalgae**
- KUAN-YEOW SHOW AND DUU-JONG LEE
- 9.1 Introduction 189
- 9.2 Pathways of Hydrogen Production 190
- 9.3 Bioreactor Design and Operation 195
- 9.4 Economic Evaluation 198
- 9.5 Prospects and Challenges 199
- 9.6 Conclusions 201
- 10. Applications of Spent Biomass**
- A. CATARINA GUEDES, HELENA M. AMARO, ISABEL SOUSA-PINTO, AND F. XAVIER MALCATA
- 10.1 Introduction 205
- 10.2 Spent Biomass for Biofuel Production 207
- 10.3 Spent Biomass for Fine Chemical Production 212
- 10.4 Bioremediation 224
- 10.5 Feed 225
- 10.6 Final Considerations 226
- 11. Hydrothermal Upgradation of Algae into Value-added Hydrocarbons**
- RAWEL SINGH, THALLADA BHASKAR, AND BHAVYA BALAGURUMURTHY
- 11.1 Introduction 235
- 11.2 Algal Biomass 237
- 11.3 Macroalgae 239
- 11.4 Thermochemical Conversion 240
- 11.5 Hydrothermal Upgradation 241
- 11.6 Hydrothermal Processes for Upgradation of Algae 247
- 11.7 Opportunities and Challenges 255
- 12. Scale-Up and Commercialization of Algal Cultivation and Biofuel Production**
- MAN KEE LAM AND KEAT TEONG LEE
- 12.1 Introduction 261
- 12.2 Life-Cycle Energy Balance of Algal Biofuels 262
- 12.3 Potential Biofuel Production from Algae 272
- 12.4 Techno-Economic Evaluation of Algal Biofuels 278
- 12.5 Conclusion 282

13. Life-Cycle Assessment of Microalgal-Based Biofuels

PIERRE COLLET, DANIELE SPINELLI, LAURENT LARDON,
ARNAUD HÉLIAS, JEAN-PHILIPPE STEYER, AND OLIVIER
BERNARD

- 13.1 Introduction 287
- 13.2 Assessed Functions, Associated Functional
Units, and Perimeters of Microalgae Production
LCAs 289
- 13.3 Modeling the Inventory Data 290
- 13.4 Microalgal Biomass Transformation into
Energy 300
- 13.5 Environmental Impact Assessment 303

- 13.6 Discussion and Guidelines 307
- 13.7 Conclusion 310

14. Economics of Microalgae Biomass Production

F.G. ACIÉN, J.M. FERNÁNDEZ, AND E. MOLINA-GRIMA

- 14.1 Introduction 313
- 14.2 Methodology for Cost Analysis of Microalgae
Production 314
- 14.3 Case Study 316

Index 327

Intentionally left as blank

Contributors

- F.G. Ación** Department of Chemical Engineering, University of Almería, Cañada San Urbano, E-04120-Almería, Spain
- Helena M. Amaro** CIIMAR/CIMAR - Interdisciplinary Centre of Marine and Environmental Research, University of Porto, Rua dos Bragas, P-4050-123 Porto, Portugal; ICBAS - Institute of Biomedical Sciences Abel Salazar, Rua de Jorge Viterbo Ferreira no. 228, P-4050-313 Porto, Portugal
- Ricardo Assmann** Ourofino Agronegócio, Rodovia Anhanguera SP 330, Km 298 Distrito Industrial, CEP 14140-000 Cravinhos, SP, Brazil
- Bhavya Balagurumurthy** Biofuels Division, Council of Scientific and Industrial Research-Indian Institute of Petroleum, Dehradun-248 005, India
- Olivier Bernard** INRIA BIOCORE, BP 93, 06902 Sophia Antipolis Cedex, France
- Thallada Bhaskar** Biofuels Division, Council of Scientific and Industrial Research-Indian Institute of Petroleum, Dehradun-248 005, India
- Rashmi Chandra** Bioengineering and Environmental Center, Council of Scientific and Industrial Research-Indian Institute of Chemical Technology, Hyderabad, 500 607, India
- Jo-Shu Chang** Department of Chemical Engineering, National Cheng Kung University, Tainan, Taiwan
- Chun-Yen Chen** Center for Bioscience and Biotechnology, National Cheng Kung University, Tainan, Taiwan
- Feng Chen** Institute for Food & Bioresource Engineering, College of Engineering, Peking University, Beijing, China
- Pierre Collet** INRA UR0050, Laboratoire de Biotechnologie de l'Environnement, Avenue des Etangs, 11000 Narbonne, France
- Jorge Alberto Vieira Costa** Laboratory of Biochemical Engineering, College of Chemistry and Food Engineering, Federal University of Rio Grande, P.O. Box 474, Rio Grande, RS, 96200-970, Brazil
- Carlos José DalmasNeto** Ourofino Agronegócio, Rodovia Anhanguera SP 330, Km 298 Distrito Industrial, CEP 14140-000 Cravinhos, SP, Brazil
- Julio Cesar de Carvalho** Biotechnology Division, Federal University of Parana, CEP 81531-970 Curitiba-PR, Brazil
- Michele Greque de Morais** Laboratory of Biochemical Engineering, College of Chemistry and Food Engineering, Federal University of Rio Grande, P.O. Box 474, Rio Grande, RS, 96200-970, Brazil
- M. Prathima Devi** Bioengineering and Environmental Center, Council of Scientific and Industrial Research-Indian Institute of Chemical Technology, Hyderabad, 500 607, India
- Su-Chiung Fang** Biotechnology Center in Southern Taiwan, Academia Sinica Agricultural Biotechnology Research Center, Academia Sinica No. 59, Siraya Blvd. Xinshi Dist. Tainan 74145, Taiwan R.O.C.
- J.M. Fernández** Department of Chemical Engineering, University of Almería, Cañada San Urbano, E-04120-Almería, Spain
- A. Catarina Guedes** CIIMAR/CIMAR - Interdisciplinary Centre of Marine and Environmental Research, University of Porto, Rua dos Bragas, P-4050-123 Porto, Portugal
- Arnaud Hélias** INRA UR0050, Laboratoire de Biotechnologie de l'Environnement, Avenue des Etangs, 11000 Narbonne, France; Montpellier SupAgro, 2 place Pierre Viala 34060 Montpellier, France

- I-Chen Hu** Far East Bio-Tec Co. Ltd., Taipei, Taiwan, Far East Microalgae Ind Co. Ltd., Ping-Tung, Taiwan
- Man Kee Lam** School of Chemical Engineering, Universiti Sains Malaysia, Engineering Campus, Seri Ampangan, 14300 Nibong Tebal, Pulau Pinang, Malaysia
- Laurent Lardon** INRA UR0050, Laboratoire de Biotechnologie de l'Environnement, Avenue des Etangs, 11000 Narbonne, France
- Duu-Jong Lee** Department of Chemical Engineering, National Taiwan University, Taipei, Taiwan 106
- Keat Teong Lee** School of Chemical Engineering, Universiti Sains Malaysia, Engineering Campus, Seri Ampangan, 14300 Nibong Tebal, Pulau Pinang, Malaysia
- Jin Liu** Institute of Marine and Environmental Technology, University of Maryland Center for Environmental Science, Baltimore, MD, USA
- F. Xavier Malcata** CIIMAR/CIMAR - Interdisciplinary Centre of Marine and Environmental Research, University of Porto, Rua dos Bragas, P-4050-123 Porto, Portugal; Department of Chemical Engineering, University of Porto, Rua Dr. Roberto Frias, s/n P-4200-465 Porto, Portugal
- S. Venkata Mohan** Bioengineering and Environmental Center, Council of Scientific and Industrial Research-Indian Institute of Chemical Technology, Hyderabad, 500 607, India
- E. Molina-Grima** Department of Chemical Engineering, University of Almería, Cañada San Urbano, E-04120-Almería, Spain
- DolivarCoraucci Neto** Ourofino Agronegócio, Rodovia Anhanguera SP 330, Km 298 Distrito Industrial, CEP 14140-000 Cravinhos, SP, Brazil
- Alessandra Cristine Novak** Biotechnology Division, Federal University of Parana, CEP 81531-970 Curitiba-PR, Brazil
- Kuan-Yeow Show** Department of Environmental Science and Engineering, Fudan University, Shanghai, China
- Rawel Singh** Biofuels Division, Council of Scientific and Industrial Research-Indian Institute of Petroleum, Dehradun-248 005, India
- Carlos Ricardo Soccol** Department of Bioprocess Engineering and Biotechnology, Federal University of Paraná, 81531-990 Curitiba-Pr, Brazil; Biotechnology Division, Federal University of Parana, CEP 81531-970 Curitiba-PR, Brazil
- Isabel Sousa-Pinto** CIIMAR/CIMAR - Interdisciplinary Centre of Marine and Environmental Research, University of Porto, Rua dos Bragas, P-4050-123 Porto, Portugal; Department of Biology, Faculty of Sciences, University of Porto, Rua do Campo Alegre, s/n, 4050 Porto, Portugal
- Daniele Spinelli** Department of Chemistry and Center for Complex System Investigation, University of Siena, Via Alcide de Gasperi 2, 53100 Siena, Italy
- Jean-Philippe Steyer** INRA UR0050, Laboratoire de Biotechnologie de l'Environnement, Avenue des Etangs, 11000 Narbonne, France
- G. Venkata Subhash** Bioengineering and Environmental Center, Council of Scientific and Industrial Research-Indian Institute of Chemical Technology, Hyderabad, 500 607, India
- Zheng Sun** School of Energy and Environment, City University of Hong Kong, China
- Eduardo Bittencourt Sydney** Department of Bioprocess Engineering and Biotechnology, Federal University of Paraná, 81531-990 Curitiba-Pr, Brazil; Biotechnology Division, Federal University of Parana, CEP 81531-970 Curitiba-PR, Brazil
- Hong-Wei Yen** Department of Chemical and Materials Engineering, Tunghai University, Taichung, Taiwan

Preface

This book is about biofuels from microalgae. Microalgae have been used commercially for decades, but not for producing biofuels. Interest in algal fuels has seen a spectacular reawakening within the last 10-years. Several factors are driving the renewed quest for algal fuels: Concern about depletion of petroleum; the desire for energy independence; the need for carbon neutral renewable fuels that can be produced without compromising the supply of food and freshwater; and the need to prevent further deforestation. Algal fuels are not yet commercial and may not reach the market for long time or near-future. Nevertheless, they represent a strategic opportunity that must be persistently developed into a renewable and environmentally sustainable source of high-energy density liquid fuels.

The present book, which is the third book in the series on BIOMASS being published by us, presents up-to-date state-of-art information and knowledge by the internationally recognized experts and subject peers in various areas of algal biofuels. The 14 chapters of the book attempt to address many of the key issues relating to algal biofuels. Algal culture systems – open ponds as well as the closed photobioreactors – are discussed. Genetic and metabolic engineering of algae for enhanced capabilities in production of fuels are examined. Aspects of carbon fixation in industrially important microalgae are discussed. Technologies for recovering the biomass from the culture broth are assessed.

A chapter is devoted to heterotrophic production of algal oils as potential fuels. Production of fuels via fast pyrolysis of algal biomass is treated in some detail. An overview is provided of algal oils as fuels in one chapter. A chapter considers production of biohydrogen from microalgae. Any production of algal fuels must consider the fate of the spent biomass. This is discussed in one chapter. A chapter is focused on the hydrothermal treatment of algal biomass to produce hydrocarbon fuels. Scale-up of production and commercialization aspects of algal fuels are examined in one chapter. A chapter discusses the life-cycle assessment of algal fuels. Changes in technology in this rapidly developing field are bound to greatly diminish the environmental impact of future algal fuel production. Finally, a chapter assesses in some depth the economics of microalgal biomass production. Continuing developments will surely reduce the cost of producing algal fuels in the future.

The book would be of special interest to the post-graduate students and researchers of applied biology, biotechnology, microbiology, biochemical and chemical engineers working on algal biofuels. It is expected that the current discourse on biofuels R&D would go a long way in bringing out the exciting technological possibilities and ushering the readers towards the frontiers of knowledge in the area of biofuels and this book will be helpful in achieving this discourse for algal biofuels.

We thank authors of all the articles for their cooperation and also for their preparedness in revising the manuscripts in a time-framed manner. We also acknowledge the help from the reviewers, who in spite of their busy professional activities, helped us by evaluating the manuscripts and gave their critical inputs to refine and improve the articles. We warmly thank Dr Marinakis Kostas

and Dr Anita Koch and the team of Elsevier for their cooperation and efforts in producing this book.

Ashok Pandey
Duu-Jong Lee
Yusuf Chisti
Carlos Ricardo Soccol
Editors

An Open Pond System for Microalgal Cultivation

Jorge Alberto Vieira Costa* and Michele Greque de Morais

*Laboratory of Biochemical Engineering, College of Chemistry and Food Engineering,
Federal University of Rio Grande, Rio Grande, RS, Brazil

1.1 INTRODUCTION

Microalgal biotechnology has emerged due to the great diversity of products that can be developed from biomass. Microalgal biomass has been industrially applied in areas such as dietary supplements, lipids, biomasses, biopolymers, pigments, biofertilizers, and biofuels. To produce these compounds, microalgae can be grown using carbon dioxide and industrial wastes, which reduces the cost of culture medium nutrients and alleviates the environmental problems caused by these effluents. However, the high cost of production of microalgal biomass (compared to agricultural and forestry biomasses) is one of the major barriers that must be overcome in order for their industrial production to be viable.

Although efforts have been directed at the optimization of the medium and processes, the development of cultivation systems that are cost-effective and highly efficient must be significantly improved for large-scale production to be viable (Wang et al., 2012; Wang and Lan, 2011). Microalgal cultivation on a large scale has been studied for decades (Lee, 2001).

The first unialgal cultivation was carried out with the microalga *Chlorella vulgaris* by Beijerinck in 1890, who wanted to study the physiology of the plants (Borowitzka, 1999). During World War II, Germany, using open ponds, increased algal cultivation for use as a food supplement. With the onset of industrialization, some study groups at the Carnegie Institute in Washington, D.C., implemented algae cultures for carbon dioxide biofixation. In 1970 Eastern Europe, Israel, and Japan began commercial production of algae in open ponds to produce healthy foods (Ugwu et al., 2008).

Open pond cultivation systems are the most industrially applied because of their low cost of investment and operational capital. This system's major difficulties are the control of

operating conditions, which can cause low biomass productivity, and the control of contaminants, which can be excluded by using highly selective species (Shu and Lee, 2003).

Compared to open ponds, closed photobioreactors may have increased photosynthetic efficiency and higher production of biomass (Wang et al., 2012). However, closed photobioreactors have a high initial cost, and only microalgal strains with specific physiologies may be used (Harun et al., 2010), which is why different types of closed photobioreactors have been developed in recent decades (Wang et al., 2012).

The objective of this study was to present the advantages and disadvantages of open ponds compared to other photobioreactors as well as to examine factors that affect the cultures and the bioproducts obtained.

1.2 BIOTECHNOLOGY AND MICROALGAE

Biotechnology is a major interdisciplinary science, combining biology, chemistry, and engineering and incorporating and integrating knowledge from the areas of microbiology, genetics, chemistry, biochemistry, and biochemical engineering. The key word in this context is *biotransformation*.

The application of biotechnology to marine organisms and processes is an area of significant industrial importance with ramifications in many areas, including human health, the environment, energy, food, chemicals, materials, and bioindicators. Some areas of interest related to marine biotechnology include the understanding of genetic, nutritional, and environmental factors that control the production of primary and secondary metabolites, based on new or optimized products. Furthermore, there has been an emphasis on the identification of bioactive compounds and their mechanisms of action for application in the medical and chemical industry; there are also bioremediation strategies for application in damaged areas and the development of bioprocesses for sustainable industrial technologies (Zaborsky, 1999).

The cultivation of microalgae as part of biotechnology has received researcher attention. The growth conditions and the bioreactors for cultivation have been thoroughly studied (Borowitzka, 1999). The principle behind cultivation of microalgae for the production of biomass is the use of photosynthesis (Vonshak, 1997), which involves using solar energy and converting it into chemical energy.

Microalgae are photosynthetic prokaryotic or eukaryotic microorganisms that grow rapidly and have the ability to live in different environments due to their unicellular or simple multicellular structure. Examples of prokaryotic microalgae are the cyanobacteria; green algae and diatoms are examples of eukaryotics (Mata et al., 2010).

Cyanobacteria differentiate into vegetative, akinete, and heterocyst cells. The functions of vegetative, akinete, and heterocyst cells are their ability to carry oxygen in photosynthesis, resistance to climactic conditions, and potential for nitrogen fixation, respectively. Green algae have a defined nucleus, cell wall, chloroplasts containing chlorophyll and other pigments, pirenoid, and a dense region containing starch granules, stigma, and scourge.

Microalgae exist in various ecosystems, both aquatic and terrestrial. More than 50,000 species are known and about 30,000 are studied (Mata et al., 2010). The main advantages of microalgae cultivation as a biomass source are (Vonshak, 1997):

- They are biological systems with high capacity to capture sunlight to produce organic compounds via photosynthesis.

- When subjected to physical and chemical stress, they are induced to produce high concentrations of specific compounds, such as proteins, lipids, carbohydrates, polymers, and pigments.
- They have a simple cellular division cycle without a sexual type stage, enabling them to complete their development cycle in a few hours. This enables more rapid development in production processes compared with other organisms.
- They develop in various environmental conditions of water, temperature, salinity, and light.

1.3 OPEN POND SYSTEMS

Under phototrophic growth conditions, microalgae absorb solar energy and assimilate carbon dioxide from the air and nutrients from aquatic habitats. However, commercial production must replicate and optimize the ideal conditions of natural growth. The choice of the reactor is one of the main factors that influence the productivity of microalgal biomass.

Open tanks come in different forms, such as raceway, shallow big, or circular (Masojidek and Torzillo, 2008). Circular ponds with a centrally pivoted rotating agitator are the oldest large-scale algal culture systems and are based on similar ponds used in wastewater treatment. The design of these systems limits pond size to about 10,000 m² because relatively even mixing by the rotating arm is no longer possible in larger ponds. Raceway tanks are the most widely used artificial systems of microalgal cultivation. They are typically constructed of a closed loop and have oval-shaped recirculation channels. They are usually between 0.2 and 0.5 m deep, and they are stirred with a paddlewheel to ensure the homogenization of culture in order to stabilize the algal growth and productivity. Raceways may be constructed of concrete, glass fiber, or membrane (Brennan and Owende, 2010).

Compared to closed tanks, the raceway is the cheapest method of large-scale microalgal production (Chisti, 2008). These tanks require only low power and are easy to maintain and clean (Ugwu et al., 2008).

The construction of open tanks is low cost and they are easy to operate; however, it is difficult to control contamination, and only highly selective species are not contaminated by other microalgae and microorganisms. Environmental variations have a direct influence, and the maintenance of cell density is low due to shadowing of the cells (Amaro et al., 2011). Light intensity, temperature, pH, and dissolved oxygen concentration may limit the growth parameters of open tanks (Harun et al., 2010).

Open photobioreactors have lower yields than closed systems due to loss by evaporation, temperature fluctuations, nutrient limitation, light limitation, and inefficient homogenization (Brennan and Owende, 2010). The amount of evaporated water can be periodically or continuously added to the raceway. The amount of evaporated water in raceways depends on the temperature, wind velocity, solar radiation, and pressure of water vapor. Water can also be lost during harvesting; however, recycling of the medium reduces this problem, and nutrients from the culture medium can be reutilized (Handler et al., 2012).

Open ponds are the microalgal cultivation systems that have been studied for the longest time. These reactors are used on an industrial scale by companies such as Sosa Texcoco, Cyanotech, Earthrise Farm, Parry Nutraceuticals, Japan *Spirulina*, Far East Microalga, Taiwan *Chlorella*, Microbio Resource, Betatene, and Western Biotechnology (Spalore et al., 2006). Earthrise Farm began cultivation on a large scale in 1976 with *Spirulina*. Currently the

company produces *Spirulina* and *Spirulina*-based products. The cultures are grown in 30 open ponds that are 5,000 square meters in size, each one mixed by a 50-foot paddlewheel (Eartrise, 2012).

Since 1981 Parry nutraceuticals has produced *Spirulina* in powder form, capsules, pills and tablets, and extracts astaxanthin from *Haematococcus pluvialis*. The company is located in South India (Oonaiyur), and the crops are grown in open ponds, covering an area of 130 acres (Parry Nutraceuticals, 2012). Cyanotech, located in Kailua Kona, Hawaii, on the Pacific Ocean, develops and markets astaxanthin from *Haematococcus* in gel capsules and *Spirulina* in tablet form in an area of 90 acres. Since 1984, *Spirulina* has been cultivated in open ponds, with the medium supplemented with water from the Pacific Ocean and agitation by paddlewheels (Cyanotech, 2012).

In Brazil, since 1998 the Laboratory of Biochemical Engineering (LEB) at the Federal University of Rio Grande (FURG) has been developing a project that studies the cultivation of *Spirulina* on a pilot scale in an open pond (Figure 1.1) on the edge of Mangueira Lagoon (Morais et al., 2009), for addition to meals for children. Products that are easy to prepare, conserve, and distribute have been developed. These products include instant noodles, flan, powdered mixture for cakes, cookies, chocolate powder, instant soup, isotonic sports drinks, gelatin powder, and cereal bars (Costa and Morais, 2011).

The LEB, along with the President Medici Power Plant (UTPM), operated by the Society of Thermal Electricity Generation (CGTEE) since January 2005, has carried out the cultivation of microalgae for the biofixation of CO₂ that is emitted in the combustion of coal at UTPM in an open pond (Figure 1.2) (Morais and Costa, 2007).

In southern Brazil, the company Olson Microalgae began commercial production of *Spirulina* capsules as a nutritional supplement in 2012, with an annual target of 6,000 kg in open ponds (Figure 1.3).



FIGURE 1.1 Cultivation of *Spirulina* on a pilot scale in open ponds for addition to children's meals.



FIGURE 1.2 Cultivation of *Spirulina* for the CO₂ biofixation that is emitted in the combustion of coal in a thermoelectric power plant (UTPM, Brazil).



FIGURE 1.3 The company Olson Microalgae with commercial production of *Spirulina* capsules.



FIGURE 1.4 Pilot plant for microalga cultivation using vinasse and carbon dioxide in the medium.

The Company Ouro Fino produces biomass and protein from microalgae for human and animal feed using the culture medium vinasse, cane husks, and carbon dioxide generated from the alcohol industry (Figure 1.4).

Several studies of open systems have taken place. According to Lee (2001), only species with high resistance are grown in open systems, such as *Dunaliella* (resistant to high salinity), *Spirulina* (grown in high alkalinity), and *Chlorella* (grown with high nutrient concentrations).

1.4 MAIN MICROALGAE CULTIVATED IN OPEN POND SYSTEMS

The type and design of photobioreactors for large-scale cultivation of microalgae represent a compromise between the cost of investment and establishment of optimal conditions for obtaining maximum productivity. The cultivation of microalgae can be carried out in various types of bioreactors (Vonshak, 1997). The microalgae *Spirulina* and *Chlorella* are the most commonly cultivated in open ponds around the world.

When choosing the appropriate cultivation system, many parameters must be observed:

- Biology of the microalga
- The cost of land, energy, water, and nutrients
- Local climactic conditions
- Final product

1.4.1 *Spirulina*

Spirulina is a filamentous cyanobacterium recognized mainly by its multicellular cylindrical arrangement of trichomes in an open helix along the entire length (Vonshak, 1997). Under the microscope, it appears as blue-green filaments of unbranched cylindrical cells, in helical trichomes. The filaments are movable and move freely around its axis, and they are not heterocystic. They are up to 1 mm in length; the cell diameter ranges from 1–3 μm in small species and 3–12 μm in the larger species (Richmond, 1990).

This microalga inhabits various media such as soil, sand, swamps, alkaline lakes and brackish, marine, and fresh water. Through photosynthesis, it converts nutrients into cellular matter and releases oxygen. The components needed for cell growth are water, a carbon source, nitrogen, phosphorus, potassium, magnesium, iron, and other micronutrients.

In natural lakes, the limited supply of nutrients may regulate the growth cycles, and the cell density increases rapidly, reaches a maximum concentration, and retreats when nutrients are depleted. The release of nutrients from dead cells or the supply of nutrients initiates a new cycle (Henrikson, 1994).

There are many controversies in the morphology and taxonomy of cyanobacteria of the genera *Spirulina* and *Arthrospira*. Many studies have described the properties of *Spirulina maxima* and *Spirulina platensis*, and both species are considered to be of the genus *Arthrospira* and not *Spirulina*. The differences between the genera have been based on the G+C content of DNA and lipid profile (Romano et al., 2000).

The helical shape is only maintained in liquid medium; in solid medium the filaments take a spiral shape, and the transition from the helical shape to the spiral shape is slow, whereas the opposite takes place instantaneously. Most species of *Spirulina* present a granular cytoplasm containing gas vacuoles and septa that are easily visible. Electron microscopy reveals that the cell wall of *Spirulina platensis* is probably composed of four layers.

The life cycle of *Spirulina* begins when a trichome (filament consisting of cells) elongates, and this is followed by an increase in the number of cells as a result of repeated interspersed cell divisions. The microalga cell fragmented into several parts by the formation of specialized, lysis-promoting necridic cells, which give rise to small chains (two or four cells) called *hormogonia*, which develop into new trichomes. The number of cells in the hormogonium increases by cellular fission, while the cytoplasm becomes granulated and the cells take on a bright bluish-green color. Due to this process, trichomes increase in length and take their typical helical shape (Richmond, 1990).

1.4.2 *Chlorella*

Chlorella spp. are simple, nonmotile, unicellular, aquatic green microalgae. They were one of the first algae to be isolated as a pure culture. The *Chlorella* microalga measures between 5 and 10 micrometers and, under an optical microscope one, can observe its green color and spherical shape.

Compared to higher plants, *Chlorella* has a high concentration of chlorophyll and photosynthetic capacity. The microalga *Chlorella* is classified as a species according to the shape of the cells, characteristics of chlorophyll, and other variables. There are 20–30 species, some of which are *Chlorella vulgaris*, *Chlorella pyrenoidosa*, and *Chlorella ellipsoidea*. The species are differentiated within the group, known as *strains* (Illman et al., 2000).

The first pure culture of microalga to be scientifically proven was *Chlorella vulgaris* in 1890 by the microbiologist M. W. Beijerinck. In 1919, Otto Warburg published articles on the use of this microalga in culture to study its physiology. After years of research with *Chlorella* and other microalgae, he found that these microorganisms grow under specific conditions and can be used to produce compounds with nutritional benefits to human health.

One of the most important characteristics of *Chlorella* is its protein content. Depending on the culture conditions, this microalga can provide 60% of protein with essential amino acids for human consumption. *Chlorella* has approximately three times more protein than the same amount of red meat, which is one of the most concentrated sources of protein. Due to its high protein concentration, *Chlorella* is used as a food supplement. This microalga has 23% carbohydrates, 9% fat, and 5% minerals (Henrikson, 1994).

Chlorella is also rich in B vitamins, especially B12, which is vital in the formation and regeneration of blood cells. Because it also has a high iron content, this microalga is a product indicated for the treatment and prevention of anemia. In order for its nutrients to be fully utilized by the body, cells of *Chlorella*, which are protected by a cell wall, must be disintegrated during the drying process to enable its nutrients to be fully absorbed by the metabolism (Henrikson, 1994).

1.4.3 *Dunaliella*

The green halophilic alga *Dunaliella* is the best natural source of β -carotene. This microalga is marketed in several countries, such as the United States, Australia, and Israel. The biopigment β -carotene is extracted from microalgal biomass and used as a food supplement or a natural pigment added to foods, or the dry biomass is marketed in tablets (Wood, 1998).

The biomass of the microalga *Dunaliella* has demonstrated several biological activities, such as being antihypertensive, bronchodilator, analgesic, muscle relaxant, and anti-edema. The natural β -carotene contains many essential nutrients that are not present in the same pigment produced synthetically (Yousry, 2002). The human body converts β -carotene to vitamin A without forming toxins in the liver. β -carotene has antioxidant activity while avoiding the effects of free radicals.

This microalga is grown in high salinity, with optimal growth in 22% of NaCl. Under these cultivation conditions the microalga culture is axenic and thus poses no problems of contamination when kept in open ponds (Wood, 1998).

The concentration of β -carotene accumulated in the cells of *Dunaliella* overcomes the traditional source of this pigment, and about 14% of the compound may be extracted.

Dunaliella is a eukaryotic green algae that grows in saline sites. Halophilic representatives of microalga have an osmotic mechanism that is different from halophilic bacteria. *Dunaliella*, which has no cell wall, can be developed with high salt concentration in the cytoplasm by the synthesis of glycerol. This microalga also responds to osmotic stress with the synthesis of glycerol if the high salinity is caused artificially by polyols.

The amount of glycerol produced by the microalga when exposed to saline stress is proportional to the concentration of NaCl in the culture.

1.5 REACTOR DESIGN

The efficiency of a photobioreactor depends on the integration of capture, transport, distribution, and use of light by the microalga through photosynthesis (Zijffers et al., 2008). The main feature of the photobioreactor that influences the exposure of microalgae to light is the surface/volume ratio. Some materials used for construction of reactors are glass, fiber-glass, Plexiglas, polyvinyl chloride (PVC), acrylic-PVC, and polyethylene (Wang et al., 2012).

The particularity of each of these materials should be individually evaluated prior to their application in the construction of photobioreactors. Glass is hard, transparent, and suitable for the construction of small-scale photobioreactors. However, this material requires many connections for the construction of large-scale photobioreactors, which increases the production cost. Fiberglass and PVC can be used in open ponds, where the light reaches the surface of the culture that is open, but cannot be used for tubular photobioreactors because they are nontransparent materials.

Another important feature of the photobioreactor's building material is the ability to prevent the formation of biofilms. Biofilms are not difficult to clean, but they can dramatically reduce the transmission of light, even to the microalgae in open photobioreactors. In open ponds, biofilms may promote the contamination of crops. The photobioreactor should also be constructed to facilitate the control of operating parameters, not have a high cost of construction and operation, facilitate the harvesting of the biomass, and minimize power consumption during the process (Wang et al., 2012). The photobioreactor must allow the cultivation of several microalgal species.

1.6 LIGHT REGIME

The light spectrum and intensity are factors that directly affect the performance of phototrophic microalgal growth, both indoors and outdoors. In outdoor cultures, sunlight is the major energy source, whereas innovations in artificial lighting, such as light-emitting diodes (LED) and optical fiber, are interesting for indoor cultivation systems. In indoor cultures, the biggest challenge is the high cost of artificial lighting (Chen et al., 2011).

Regardless of the light source, its usage by microalgae occurs in the same way. In a photosynthetic system, 8 photons of radiation are required to fix one CO₂ molecule in the form of carbohydrate; this results in the maximum photosynthetic efficiency (Chini-Zittelli et al., 2006).

Multiproteic complexes, also called *photosystems*, catalyze the conversion reaction of light energy captured by excited molecules of chlorophyll into the form of usable energy. A photosystem consists of a center of photochemical reaction consisting of a protein complex, and molecules of chlorophyll that enable the conversion of light energy into chemical energy. This photosystem also has an antenna complex consisting of pigment molecules that capture light energy and feed the reaction center. The antenna complex is important for the capture of light. In chloroplasts, it consists of a cluster of hundreds of chlorophyll molecules held together by proteins that keep them firmly together on the thylakoid membrane (Alberts et al., 2008).

When a chlorophyll molecule from the antenna complex is excited, the energy is rapidly transmitted from one molecule to another through a resonance energy transfer process until it reaches a special pair of chlorophyll molecules from the center of the photochemical reaction. Each antenna complex acts like a funnel collecting light energy and directing it to a specific site where it can be used effectively (Alberts et al., 2008). One strategy to optimize the utilization of light is to reduce the size of the antenna, which makes the cells less opaque and facilitates the transmission of light (Chen et al., 2011).

Several studies have been developed to improve the efficiency of light utilization and reduce the costs of systems with artificial lighting. The advantage of cultivation in a laboratory is that it uses fluorescent tubes. Although they consume high amounts of energy, that usage can be reduced by more than 50% with the use of LEDs. Many cultures use only solar energy as a light source, which has no cost. However, the performance of outdoor systems is lower than indoor ones, and they require large areas of land (Chen et al., 2011).

1.7 HYDRODYNAMICS OF THE REACTOR

An adequate mixture should provide a high concentration of biomass, enable the circulation of liquid, keep the cells in suspension, eliminate thermal stratification, optimize the distribution of nutrients, improve gas exchange, and reduce the shading and photoinhibition of microalgae. Turbulent flow is essential for maximum production of microalgae in open ponds. In raceway cultures, velocities of $5.0 \text{ cm}\cdot\text{s}^{-1}$ are sufficient to eliminate thermal stratification and maintain most species of algae in suspension.

Several mixing systems are used in microalgal cultures, depending on the type of reactor. In open pond systems, paddlewheels are used to induce turbulent flow. In stirred-tank photobioreactors, impellers are used to mix the algal cultures. In tubular photobioreactors, mixing can be carried out directly or indirectly through airlift systems (Ugwu et al., 2008).

The main costs of growing microalgae arise from the mixing and mass transfer in cultures (using paddlewheels, impellers, and airlifts) because of the energy consumed. For the raceway pond, the mixing cost is €0.08 per kg DW (dry weight), for the tubular reactor it is €1.27, and for the flat panel reactor it is €3.10 per kg DW (Norsker et al., 2011).

The mechanical stirrers (paddlewheel) provide optimal efficiency of mixing and gas transfer, but they cause significant hydrodynamic stress. Gas injection (bubbling) by airlift or impellers causes low hydrodynamic stress, good transfer of gas, and a reasonable mixing efficiency (Richmond and Cheng-Wu, 2001).

In closed photobioreactors, where the mixing is carried out by impellers or airlift, the increase of the speed of the gas bubbles enlarges the diameter of the bubbles (Ugwu et al., 2008). The bigger the bubbles, the lower the exchanges of gases with the liquid.

A high concentration of oxygen produced by photosynthesis inhibits microalgal growth. The supply of gas with the turbulent labor regime in closed photobioreactors is one solution to reduce this negative effect. However, depending on the microalgal species, high turbulence can cause damage to cells due to stress and high energy consumption (Pires et al., 2012). Low mixing results in an accumulation of toxic compounds in stagnant areas. In open ponds, oxygen has low solubility and rapid outflow since the photobioreactors are low in height.

1.8 FIXATION OF CARBON DIOXIDE (CO₂)

The biological fixation of CO₂ can be carried out by higher plants or microalgae. The sources of CO₂ for microalgal cultivation are atmospheric CO₂; CO₂ from industrial flue gas; and chemically fixed CO₂ in the form of soluble carbonates (Kumar et al., 2010). One kilogram of algal dry cell weight utilizes around 1.83 kg of CO₂. Annually, around 54.9–67.7 tonnes of CO₂ can be sequestered from raceway ponds, corresponding to an annual dry weight biomass production rate of 30–37 tonnes per hectare (Brennan and Owende, 2010).

The CO₂ can be the limiting nutrient in microalgal cultivation if it is available in low concentration in the feed gas (when air is used as a source of CO₂) or when mixing is not sufficient. However, the high CO₂ concentration causes a reduction in pH, which can inhibit the growth of some microalgae (Wang et al., 2012).

Open tanks may have a limited carbon source due to the low transfer of mass. The simple bubbling of CO₂ in the cultures may not be sufficiently effective, because the residence time of the bubble can be very short and is lost to the atmosphere. In these cases a high concentration of the free CO₂ must be maintained through direct injection of the flue gas from power plants, cement, and petrochemical factories during cultivation.

The biofixation of CO₂ can be increased while maintaining an alkaline pH, because this will accelerate the absorption of gas through two reactions: CO₂ hydration and subsequent acid-base reaction to form HCO₃⁻ and direct reaction of CO₂ with OH⁻ to form HCO₃⁻ (Amaro et al. 2011). The most common system employed for pH control is the on-off type system in which CO₂ is injected into culture when the pH exceeds a predefined set point (Kumar et al., 2010).

The engineering of a photobioreactor must also be designed to add gas transfer equipment, which will increase the gas distribution and the contact of the gas with the liquid. Some of these items include mechanical systems (propellers, blades, and brushes), coarse and fine bubble diffusers (perforated piping, slotted tubes, discs, or domes), jet aerators, aspirators, U-tubes, and hollow fiber membrane modules (Kumar et al., 2010).

In vertical tubular, horizontal, or airlift photobioreactors, the biofixation of the CO₂ is increased by the route of the gas along the tube as well as by the use of sprinklers that release small bubbles, increasing the contact surface between the gas and the liquid.

The fixation of CO₂ by microalgae has received attention due to the production of biomass with potential application in the production of biofuels, reducing the emission of greenhouse gases and participating in the treatment of effluents (Kumar et al., 2010).

1.9 TEMPERATURE

Temperature is one of the major factors that regulate cell morphology and physiology as well as the byproducts of the microalgal biomass. A high temperature generally accelerates the metabolism of microalgae and a low temperature can inhibit growth (Munoz and Guieysse, 2006).

The optimum temperature for growth varies among species of microalgae (Ono and Cuello, 2003). High temperatures during the day have a favorable effect on growth rates due to photosynthesis. High temperatures at night are not desired in microalgal cultivation

due to the increased respiration rate; they result in a high expenditure of cellular energy and consequent reduction of cellular concentration.

The temperature also influences other factors that are important for cultivation, such as the ionic balance of water, pH, and solubility of O₂ and CO₂. Different species of microalgae are affected by temperature at different levels (Park et al., 2011). In the case of combustion gases emitted in power plants, the gas temperatures reach 120 °C. In this case, the rate of CO₂ biofixation may depend on the installation of a heat exchange system or the use of thermophilic species. The solubility of O₂ and CO₂ increases the temperature and results in the fixation of high concentrations of O₂ by oxygenase of RuBisCO. Thus the affinity for RuBisCo by CO₂ decreases with increasing temperature (Kumar et al., 2011).

The temperature of cultivation in the photobioreactor is determined by the air temperature, the duration of solar radiation, and the relative humidity of air. The depth and the surface of the culture and the material of construction of the photobioreactor are factors that stabilize the temperature of the culture. Mechanisms of temperature control cause significant changes in the design of a photobioreactor. With no temperature control, a closed photobioreactor can reach values of 10–30 °C above ambient temperature. Some mechanisms of temperature control in closed photobioreactors include immersion of the culture in water, spraying with water, shading, or incorporating a heat exchanger with the photobioreactor (Wang et al., 2012). In raceway-type photobioreactors, the temperature is generally greenhouse controlled. At low temperatures the greenhouse is kept closed, maintaining the temperature. On hot days the sides of the greenhouse can be erected, thus reducing the temperature in the inner area where the raceways are located.

1.10 pH

The pH values of cultures affect the biochemical processes associated with microalgae, including the bioavailability of CO₂ for photosynthesis and use of the medium nutrients.

The optimum pH is determined according to the type of microorganism. Some species have an optimum pH of around 7.0; however, some microalgae are tolerant to high pH (*Spirulina*, pH 11.0) or low pH (*Chlorococcum*, pH 4.0) (Kumar et al., 2010).

The optimum growth of the microorganism in an acidic or basic environment can be maintained if the intracellular pH is 7.5, regardless of the external pH. Living cells have the ability, within certain limits, to maintain internal pH by expelling hydrogen ions. The external pH generally has a drastic change before it affects the cell. The optimum pH of the cultures should be maintained, thereby preventing the collapse of cell cultures by the cellular process of rupture due to high pH. The control of pH must be integrated with the aeration system by the addition of alkaline solution to the culture (Wang et al., 2012).

Some microalgae have high productivity when maintained at an alkaline pH between 10 and 11. The high pH may be beneficial for outdoor cultivation because it inactivates pathogenic microorganisms and other microalgae (Kumar et al., 2010).

In the case of cultivation with addition of CO₂, the concentration of this gas may be the dominant factor that will determine the pH of the culture. In this case, the CO₂ demand results from the balance between the transfer of CO₂ to the liquid and CO₂ consumption by the cells (Wang et al., 2012). SO_x and NO_x, present in flue gas from burning coal, can also

cause changes in pH, damaging microalgal cultivation. With high concentrations of CO₂ the pH drops to 5.0, and when exposed to SO_x and NO_x this value is 2.6 (Westerhoff et al., 2010).

The pH also influences the removal of ammonia and phosphorus. The high pH may increase the removal of ammonia through its volatilization and phosphorus through its precipitation (Craggs, 2005).

1.11 STERILITY OF CULTIVATION

Microalgal cultures are susceptible to contamination by different species of microalgae, bacteria, viruses, fungi, protozoa, and rotifers. The contamination by other microorganisms can cause changes in the cell structure and reduce the concentration and microalgal yield in just a few days (Park et al., 2011). These are controlled in open ponds by effectively operating the system as a batch culture and restarting the culture at regular intervals with fresh water and unialgal inoculum. Other contaminants include insects, leaves, and airborne material. It is essential to control this contaminants within acceptable limits. In open ponds, large contaminants can be removed regularly by placing a suitably sized screen in the water flow. This can be done manually or it can be automated.

Some characteristics can make cultures more susceptible to contamination, such as cultures in continuous mode. According to the characteristics of the microalgal species used, one can apply techniques to maintain an axenic culture. Some of these techniques are maintaining the process of cultivation at an alkaline pH (9.0 to 11.0), using high concentrations of nutrients or salinity, and using antibiotics. The photobioreactor must be periodically cleaned to minimize the chances of contamination (Wang et al., 2012).

If the microalgal biomass is applied to products such as biofuels, waste treatment, biofertilizers, or biofixation of CO₂, impurities are acceptable in the microalgal cultivation. However, for bioproducts such as drugs and food, crops must be kept in axenic cultures (Wang et al., 2012).

1.12 BIOMASS HARVEST

The harvesting of biomass is the removal of biomass from the culture medium. This process can involve one or more steps, including chemical, physical, or biological methods. The techniques of recovering microalgal biomass from the culture medium can contribute to 20–30% of the total cost of the biomass (Mata et al., 2010). Some techniques for harvesting the biomass include sedimentation, flocculation, centrifugation, filtration, flotation, and electrophoresis. The costs of these operations are relatively high due to the low initial concentration of biomass and the fact that the cells are negatively charged and due to an excess of organic material, which contributes to its stability in a dispersed state (Brennan and Owende, 2010).

The selection of an appropriate harvesting method depends on the properties of the microalga, the cell density, size, and the desired specifications of the final product. The harvesting of the biomass has two steps: separation of the microalgal biomass from the culture medium and the concentration of biomass with removal of excess medium (Amaro et al., 2011).

1.12.1 Sedimentation Using Gravity

Sedimentation through gravity is the most usual method of harvesting microalgal biomass from wastewater treatment plants. This is because of the large volumes handled and the low commercial value of the biomass formed (Muñoz and Guieysse, 2006). The density and diameter of the cells influence the speed of sedimentation. The collection of microalgae by sedimentation can be carried out in sedimentation tanks (Uduman et al., 2010). However, this method can only be applied to large-cell microalgae ($>70\ \mu\text{m}$) such as *Spirulina*. Flocculation is usually used to increase the efficiency of sedimentation (Chen et al., 2011).

1.12.2 Flocculation

To increase the recovery of cells via sedimentation, a flocculant is added to the system. Flocculation is the first step of the harvesting; this process aims to aggregate the microalgal cells and thereby increase the particle size (Grima et al., 2003). The microalgae have a negative charge on the surface to prevent cell aggregation. The loads on the surface of algae can be altered by the addition of flocculant (Harun et al., 2010).

Flocculation may be accomplished by three methods: chemical flocculation, bioflocculation, and electroflocculation. The most common flocculants are aluminum sulphate, aluminum chloride, and ferric chloride. The addition of sodium hydroxide raises the pH of the culture to 8–11, coagulating the cells in just a few minutes. However, the flocculants are toxic in high concentration. Flocculants should be inexpensive, nontoxic, and effective at low concentrations. Chitosan is an organic cationic polymer, a nontoxic flocculating agent that is used in wastewater treatment and in the food industry (Pires et al., 2012).

1.12.3 Centrifugation

Centrifugation involves the application of centripetal acceleration to separate the microalgae from the culture medium (Harun et al., 2010) and is perhaps the fastest cell-recovery method based on density gradient. The centrifuge disks are easy to clean and sterilize, and centrifugation can be applied to any kind of microalga (Christenson and Sims, 2011).

Heasman et al. (2000) reported that 88–100% of centrifuged cells were viable and the collection efficiency was 95–100% at 13,000xg. However, the centrifuge has some disadvantages: The cells are exposed to a high gravitational force, which can alter the cell structure; the recovery of fragile microalgae biomass requires low-speed centrifugation; the salt contained in the microalgal culture medium can cause rapid corrosion of equipment; and large-scale processes require costly equipment, such as continuous centrifuges (Pires et al., 2012).

1.12.4 Filtration

Filtration is a physical separation process in which the particles in suspension are retained using a filter. The filters are highly efficient and safe in the solid-liquid separation process (Pires et al., 2012). The filtration is a separation method that is suitable for large microalgae

such as *Spirulina* but unsatisfactory for smaller cells such as *Chlorella* and *Scenedesmus* (Ho et al., 2011).

Filtration provides easy operation and construction, low investment, and insignificant abrasion. The filters can be operated under pressure or vacuum (Harun et al., 2010). The main limitation of filtration is the reduction of the permeation flow during the process; this is due to adsorption and concentration of the compounds on the membrane surface (Rossi et al., 2008).

1.12.5 Flotation

Flotation is a separation process in which air or gas bubbles are directed at the solid particles and then drive these particles to the liquid surface. Flotation is more beneficial and efficient for removing cells than sedimentation. Flotation can capture particles smaller than 500 μm in diameter (Chen et al., 2011).

According to the bubble size used in the process, the application can be divided into dissolved air flotation and dispersed flotation. In dissolved air flotation, the application of reduced pressure produces bubbles of 10–100 μm . This process is influenced by the tank pressure, rate of recycling, hydraulic retention time, and particle flotation rate (Uduman et al., 2010). In dispersed air flotation, bubbles of 700–1,500 μm are formed by the high-speed mechanical stirrer with an air injection system (Rubio et al., 2002).

1.12.6 Electrophoresis

Electrophoresis is another potential method for separating the microalgae without the need for chemicals. In this method an electric field directs the microalgae to the external part of the solution. Electrolysis of water produces hydrogen, which adheres to the flakes of microalgae and carries them to the surface. There are several benefits to using this technique, including environmental compatibility, versatility, energy efficiency, safety, and selectivity (Mollah et al., 2004), but the high cost means that this method is rarely used on a large scale (Uduman et al., 2010).

According to Richmond (2004), one of the main criteria for selecting an appropriate procedure to harvest the microalgal biomass depends on the type of bioproduct desired. In products of low commercial value, sedimentation through gravity with the aid of flocculants can be applied. However, for high-value products such as human food, aquaculture, or drugs, the use of continuous operation centrifuges is recommended because they can process large volumes of biomass. Another criterion for selecting the method of harvesting is the humidity for the biomass (Grima et al., 2003). Gravity sedimentation is usually more diluted than the centrifugation method, influencing the downstream process (Mata et al., 2010).

1.13 DRYING OF BIOMASS

The drying process is one of the major limitations in the production of low-cost commodities (fuel, food, feed) and high-value products (β -carotene, polysaccharides). The process to

be selected depends on the final product desired. The use of dehydration increases the shelf life of the biomass as well as the final product.

Several methods have been used to dry *Chlorella*, *Scenedesmus*, and *Spirulina*. Some of the most widely used methods include spray drying, drum drying, freeze drying, and sun drying (Richmond, 2004). Due to the high water content, the sun-drying method is not efficient to transform humid biomass into powder. The spray-drying method is not economically feasible for low-value products such as biofuels and protein (Mata et al., 2010).

1.14 OTHER MICROALGAL CULTURE SYSTEMS

One of the decisions to be taken in the cultivation of microalgae is regarding the use of open or closed photobioreactors. Closed photobioreactors of the vertical tubular, helical tubular, and flat panel type are considered to have high photosynthetic efficiency and degree of control. Closed reactors have some advantages and disadvantages over open ones.

1.14.1 Closed Photobioreactors

Due to the high productivity achieved in cultures carried out in closed photobioreactors, much attention has been paid to these systems. The configurations tested on a laboratory or pilot scale include vertical reactors, flat plate, annular, plastic bags, green wall panel (GWP), and various forms of tubular reactors, stirred mechanically or by airlifting.

Closed photobioreactors are highly efficient at biofixation of CO₂, mainly due to better homogeneity of the medium and mass transfer. However, these reactors are limited by the excess O₂ produced (Ho et al., 2011). The costs of these reactors are generally high (Table 1.1). Contamination can be controlled in sterile systems; however, this causes an increase in production costs (Amaro et al., 2011). The scale-up of open photobioreactors generally occurs by increasing the diameter of the tube, but the cells do not receive sufficient light for growth (Ugwu et al., 2008).

TABLE 1.1 Comparison between the Production of Microalgae in Open and Closed Bioreactors

Characteristic	Open Systems	Closed Systems
Evaporation	High	No evaporation
CO ₂ loss	High	Low
Weather dependence	High	Low
Cleaning	None	Required
Capital investments	Low	High

(adapted from Pires et al., 2012).

1.14.2 Hybrid Photobioreactors

Hybrid cultivation is a method that combines different growth stages in two types of photobioreactors, closed and open (Brennan and Owende, 2010). The hybrid culture system is designed to utilize the good qualities of both types of reactors. In the case of open and closed reactors, the first stage of the cultivation occurs in the closed photobioreactor, where the conditions are controlled to minimize contamination of other microorganisms and to promote continuous cell division.

In the second stage of production the cells are exposed to a nutritional stress, increasing the synthesis of a specific metabolite, such as lipids, proteins or polymers. The second stage is ideal for open ponds (Brennan and Owende, 2010). The α -shaped reactor is another type of hybrid system, developed by Lee et al. (1995). In this reactor, the culture is lifted 5 meters by air to a receiver tank, and culture flows down an inclined PVC tube (at an angle of 25° to the horizontal) to reach another set of air-riser tubes, and the process is repeated for the next set of tubes.

1.15 APPLICATIONS OF BIOMASS

Microalgae grow in soil unfit for agriculture and livestock and in lakes or ponds located in inhospitable lands, such as deserts, which are usually unsuitable for generating any kind of food. Microalgae can double their biomass in a period of 3.5 days, achieving high yields (Chisti, 2007). After harvesting and drying of the biomass, the final state of the product is a powder. According to the chemical composition of microalgae, the biomass may have several applications.

1.15.1 Food

In the 1950s, the increase in world population and the prediction of insufficient protein supplement for humans led to the search for alternative and unconventional sources of nutrients. Microalgae emerged as candidates for this purpose. Research has been directed toward the development of functional products—food additives such as vitamins, antioxidants, highly digestible proteins, and essential fatty acids. Microalgae can supply several of these nutrients, and they have potential health benefits (Cavani et al., 2009; Petracci et al., 2009).

Microalgae are currently used in the form of tablets, capsules, or liquids. These microorganisms can be incorporated into pastas, cookies, food, candy, gum, and beverages (Liang et al., 2004). Due to their varying chemical properties, microalgae can be applied as a nutritional supplement or as a source of natural proteins, dyes, antioxidants and polyunsaturated fatty acids (Spolaore et al., 2006; Soletto et al., 2005).

The Laboratory of Biochemical Engineering (LEB) at the Federal University of Rio Grande (FURG) in southern Brazil has developed research projects since 1998 that study the cultivation of *Spirulina* on a pilot scale on the banks of the Mangueira Lagoon, as additives to meals for children of the region. Products that are easy to prepare, store, and distribute and that are highly nutritious and accepted by the consumer have been developed here.

These products include instant noodles, pudding, powdered mixture for cake, cookies, chocolate milk powder, instant soup, isotonic drinks, powdered gelatin, and cereal bars.

These products will be prepared at the Center for Enrichment of Foods with *Spirulina* (CEAS) located at the university. In Camaquã (Brazil), the company Olson produces organic *Spirulina* capsules for importation.

1.15.2 Drugs

Many algae produce antibiotics such as acrylic acid found in *Phaeocystis poucht.* This antibiotic inhibits the growth of gram-positive organisms. The phenols found in macro- and microalgae have antimicrobial activity.

The microalga *Scenedesmus obliquus* has been used in postoperative recovery, assisting in coagulation of the skin surface. The extracts of the diatom *Asterionella notata* have an antifungal and antiviral activity. Toxic algae have been used as a depressant vessel, similar to tetrodotoxin found in fish (Richmond, 1990).

Another drug obtained from microalgae is phycocyanin, a natural antioxidant that, when combined with caloric restriction, can contribute to mitigating the aging process. Free radicals are partly responsible for the human aging process (Finkel, 2003). The oxidative damage caused by free radicals has been linked to several diseases such as heart disease, atherosclerosis, lung problems, Alzheimer's, and Parkinson's. The DNA damage caused by free radicals plays an important role in the processes of mutagenesis and carcinogenesis.

1.15.3 Biopigments

Microalgae have three main pigments: chlorophyll that absorbs blue light; red carotenoids that absorb blue and green light; and phycobilins that absorb green, yellow, and orange light. These pigments have been used as natural colorants in food products. In many countries biodyes have replaced artificial dyes, which are currently prohibited.

β -carotene is a carotenoid found in all higher plants and algae. β -carotene acts as provitamin A and may be used as a natural food color. Phycobilins are water-soluble pigments and are found only in red algae or cyanobacterias. Most members of cyanophyceae contain blue pigment (phycocyanin), although several species may also contain erythrin. Phycoerythrin and phycocyanin can be used as natural pigments in food, medicine, and cosmetics, avoiding the use of artificial pigments that are carcinogenic (Richmond, 1990).

1.15.4 Biopolymers

Since 1940, the most widely used plastics have been polyethylene (PE), polypropylene (PP), polystyrene (PS), poly(ethylene terephthalate) (PET), and poly(vinyl chloride) (PVC). Despite advances, plastics processing and manufacturing generate two major problems: the use of nonrenewable resources to obtain their raw materials and large quantities of waste generated for disposal.

Biodegradable plastics degrade completely within three to six months when attacked by microorganisms, depending on the environmental conditions. The polyhydroxyalkanoates (PHAs) are natural polyesters consisting of units of hydroxyalkanoic acids with similar properties to petrochemical plastics (Jau et al., 2005).

The polyhydroxyalkanoates are produced as a reserve of carbon and energy accumulated within the cells of various microorganisms such as microalgae. Among the PHAs, polyhydroxybutyrate (PHB) and its copolymer polyhydroxybutyrate-co-valerate (PHB-HV) are synthesized by cyanobacteria when exposed to specific conditions of cultivation (Sharma et al., 2007).

The degradation rate of PHB and PHB-HV depends on many factors, some related to the environment, such as temperature, moisture, pH, and nutrient supply, and others related to the biopolymer itself, such as composition, crystallinity, additives, and surface area. Due to its physical and chemical properties, PHB is easily processed in equipment commonly used for polyolefins and synthetic plastics (Khanna and Srivastava, 2005).

1.15.5 Biofuels

Microalgae are a potential source of fermentable substrate. According to the conditions of cultivation, microalgal biomass can provide high levels of carbon compounds. These compounds are available directly for fermentation or after pre-treatment and may be used for ethanol production.

Biogas is the product of the anaerobic digestion of organic matter and can be obtained from domestic sewage, animal waste, solid waste, or aquatic biomass, such as macro- and microalgae (Omer and Fadalla, 2003; Gunaseelan, 1997). The type of digestion using microalgal biomass processes can eliminate the biomass harvesting and drying and the associated costs (Vonshak, 1997).

The fatty acids that microalgae produce can be converted into biodiesel, which is a renewable, biodegradable, nontoxic, and environmentally friendly fuel. Biodiesel has the advantage that it emits 78% less carbon dioxide when burned, 98% less sulfur, and 50% of particulate matter emissions (Brown and Zeiler, 1993).

Another promising biofuel is hydrogen. Photobiological hydrogen production can be increased according to the carbon content in the biomass. The microalgae are candidates for such a process because they produce hydrogen under certain conditions and can be grown in closed systems, allowing the capture of hydrogen gas (Benemann, 1997). This biomass can be burned to produce energy because the calorific value of these microorganisms is greater than that of some charcoals.

1.15.6 Biofertilizers

The greatest issue in agriculture nowadays is the availability of chemical fertilizers at affordable costs. Nitrogen fixation has been acknowledged as the limiting factor in food production. The concept of using cyanobacteria to fix nitrogen is based on the ability of these microalgae to grow in soil.

The microalgae *Nostoc*, *Anabaena*, *Oscillatoria*, *Cylindrospermum*, and *Mastigocladus Tolypothrix* form heterocysts and can fix nitrogen aerobically. Nonheterocyst-forming filamentous microalgae, such as *Oscillatoria* and *Phormidium*, can fix nitrogen in the absence of oxygen and in the presence of nitrogen and carbon dioxide. Filamentous forms without heterocysts, such as *Trichodesmium*, may fix nitrogen aerobically (Richmond, 1990).

The heterocysts, which are specialized in aerobic nitrogen fixation, are the site of the enzyme nitrogenase, which catalyzes the conversion of nitrogen into ammonia. Nitrogen-fixing cyanobacteria were isolated in soils from various cities in South Asia, India, and Africa. In that study, 33% of 2,213 soil samples collected in India contained cyanobacteria. Microalgae such as *Nostoc*, *Anabaena*, *Calothrix*, *Aulosira*, and *Plectonema* were found in soils in India, while *Halosiphon*, *Scytonema* and *Cylindrospermum* were observed in the other regions (Richmond, 1990).

1.16 CONCLUSION

Open ponds are the most widely used reactors in the world for large-scale microalgal cultures. This is due to the low construction cost, low power demand, appropriate scale-up, and their easy cleaning process compared to closed photobioreactors. The cultures that are grown in open ponds can be protected from adverse environmental conditions (rainfall, temperature, and luminosity) through the use of a greenhouse. Microalgae that grow in extreme conditions, such as an alkaline medium and high salinity, should be adopted in order to achieve axenic cultures. The obtained microalgal biomass can be used in the production of food, drugs, biopigments, biopolymers, biofuels, and biofertilizers.

References

- Alberts, B., Johnson, A., Lewis, J., Raff, M., Roberts, K., Walter, P., 2008. *Molecular Biology of the Cell*, fifth ed. Taylor and Francis, New York, NY, USA.
- Amaro, H.M., Guedes, A.C., Malcata, F.X., 2011. Advances and perspectives in using microalgae to produce biodiesel. *Appl. Energy* 88, 3402–3410.
- Benemann, J.R., 1997. Feasibility analysis of photobiological hydrogen production. *Int. J. Hydrogen Energy* 22, 979–987.
- Borowitzka, M.A., 1999. Commercial production of microalgae: ponds, tanks, tubes and fermenters. *J. Biotechnol.* 70, 313–321.
- Brennan, L., Owende, P., 2010. Biofuels from microalgae: a review of technologies for production, processing, and extractions of biofuels and co-products. *Ren. Sustain. Energy Rev.* 14, 557–577.
- Brown, M.L., Zeiler, K.G., 1993. Aquatic biomass and carbon dioxide trapping. *Energy Convers. Manage.* 34, 1005–1013.
- Cavani, C., Petracci, M., Trocino, A., Xiccato, G., 2009. Advances in research on poultry and rabbit meat quality. *Ital. J. Anim. Sci.* 8, 741–750.
- Chen, C., Yeh, K., Aisyah, R., Lee, D., Chang, J., 2011. Cultivation, photobioreactor design and harvesting of microalgae for biodiesel production: A critical review. *Bioresour. Technol.* 102, 71–81.
- Chini-Zittelli, G., Rodolfi, I., Biondi, N., Tredici, M., 2006. Productivity and photosynthetic efficiency of outdoor cultures of *Tetraselmis suecica* in annular columns. *Aquaculture* 19, 153–159.
- Chisti, Y., 2007. Biodiesel from microalgae. *Biotechnol. Adv.* 25, 294–306.
- Chisti, Y., 2008. Biodiesel from microalgae beats ethanol. *Trends Biotechnol.* 26, 126–131.
- Christenson, L., Sims, R., 2011. Production and harvesting of microalgae for wastewater treatment, biofuels, and bioproducts. *Biotechnol. Adv.* 29, 686–702.
- Costa, J.A., Morais, M.G., 2011. The Role of Biochemical engineering in the production of biofuels from microalgae. *Bioresour. Technol.* 102, 2–9.
- Craggs, R., 2005. Advanced integrated wastewater ponds. In: Shilton, A. (Ed.), *Pond Treatment Technology*. IWA Scientific and Technical Report Series, IWA, London, U.K., pp. 282–310.
- Cyanotech, www.cyanotech.com (accessed 14.07.12.).

- Earthrise, www.earthrise.com (accessed 14.07.12.).
- Finkel, T., 2003. A toast to long life. *Nature* 39, 425–430.
- Grima, M.E., Belarbi, E.H., Fernandez, F.G.A., Medina, A.R., Chisti, Y., 2003. Recovery of microalgal biomass and metabolites: process options and economics. *Biotechnol. Adv.* 20, 491–515.
- Gunaseelan, V.N., 1997. Anaerobic digestion of biomass form methane production: a review. *Biomass Bioenergy*. 13 (1/2), 83–114.
- Handler, R., Canter, C., Kalnes, T., Lupton, F., Kholiqov, O., 2012. Evaluation of environmental impacts from microalgae cultivation in open air raceway ponds: Analysis of the prior literature and investigation of wide variance in predicted impacts. *Algal Research* 1, 83–92.
- Harun, R., Singh, M., Forde, G., Danquah, M., 2010. Bioprocess engineering of microalgae to produce a variety of consumer products. *Ren. Sustain. Energy Rev.* 14, 1037–1047.
- Heasman, M., Diemar, J., O'Connor, W., Sushames, T., Foulkes, I., 2000. Development of extended shelf-life microalgae concentrate diets harvested by centrifugation for bivalve molluscs: a summary. *Aquac Res.* 31, 637–659.
- Henrikson, R., 1994. *Microalga Spirulina: Superalimento del futuro*. Ediciones S.A. Urano, Barcelona, Spain. ISBN: 84-7953-047-2.
- Ho, S., Chen, C., Lee, D., Chang, J., 2011. Perspectives on microalgal CO₂-emission mitigation systems: A review. *Biotechnol. Adv.* 29, 189–198.
- Illman, A.M., Scragg, A.H., Shales, S.W., 2000. Increase in *Chlorella* strains calorific values when in low nitrogen medium. *Enzyme Microb. Tech.* 27, 631–635.
- Jau, M., Yew, S., Toh, P.S.Y., Chong, A.S.C., Chu, W., Phang, S., et al., 2005. Biosynthesis and mobilization of poly (3-hydroxybutyrate) [P(3HB)] by *Spirulina platensis*. *Int. J. Biol. Macromol.* 36, 144–151.
- Khanna, S., Srivastava, A.K., 2005. Recent advances in microbial polyhydroxyalkanoates. *Process Biochem.* 40, 607–619.
- Kumar, A., Ergas, S., Yuan, X., Sahu, A., Zhang, Q., Dewulf, J., et al., 2010. Enhanced CO₂ fixation and biofuel production via microalgae: recent developments and future directions. *Trends Biotechnol.* 28, 371–380.
- Kumar, K., Dasgupta, N., Nayak, B., Lindblad, P., Das, D., 2011. Development of suitable photobioreactors for CO₂ sequestration addressing global warming using green algae and cyanobacteria. *Bioresour. Technol.* 102, 4945–4953.
- Lee, Y., 2001. Microalgal mass culture systems and methods: their limitation and potential. *J. Appl. Phycol.* 13, 307–315.
- Lee, Y.K., Ding, S.Y., Low, C.S., Chang, Y.C., Forday, W.L., Chew, P.C., 1995. Design and performance of an α -type tubular photobioreactor for mass cultivation of microalgae. *J. Appl. Phycol.* 7, 47–51.
- Liang, S., Xueming, L., Chen, F., Chen, Z., 2004. Current microalgal health food R&D activities in China. *Hydrobiol.* 512, 45–48.
- Masojidek, J., Torzillo, G., 2008. Mass cultivation of fresh water microalgae. In: *Encyclopedia of ecology*, Oxford, UK, pp. 2226–2235.
- Mata, T.M., Martins, A.A., Caetano, N.S., 2010. Microalgae for biodiesel production and other applications: A review. *Ren. Sustain. Energy Rev.* 14, 217–232.
- Mollah, M., Morkovsky, P., Gomes, J., Kesmez, M., Parga, J., Cocke, D., 2004. Fundamentals, present and future perspectives of electrocoagulation. *J. Hazard. Mater.* 114, 199–210.
- Morais, M.G., Costa, J.A.V., 2007. Biofixation of carbon dioxide by *Spirulina* sp. and *Scenedesmus obliquus* cultured in a three-stage serial tubular photobioreactor. *J. Biotechnol.* 129, 439–445.
- Morais, M.G., Radmann, E.M., Andrade, M.R., Teixeira, G.G., Brusch, L.R.F., Costa, J.A.V., 2009. Pilot scale semicontinuous production of *Spirulina* biomass in southern Brazil. *Aquaculture* 294, 60–64.
- Muñoz, R., Guieysse, B., 2006. Algal bacterial processes for the treatment of hazardous contaminants: a review. *Water Res.* 40, 2799–2815.
- Norsker, N., Barbosa, M., Vermue, M., Wijffels, R., 2011. Microalgal production – A close look at the economics. *Biotechnol. Adv.* 29, 24–27.
- Omer, A.M., Fadalla, Y., 2003. Biogas technology in Sudan. *Ren. Energy* 28, 499–507.
- Ono, E., Cuello, J.L., 2003. Selection of optimal microalgae species for CO₂ sequestration. In: *Proceedings of Second Annual Conference on Carbon Sequestration*. Alexandria, VA, USA.
- Park, J., Graggs, R., Shilton, A., 2011. Wastewater treatment high rate algal ponds for biofuel production. *Bioresour. Technol.* 102, 35–42.
- Parry nutraceuticals, www.parrynutraceuticals.com (accessed 15.07.12.).

- Petracci, M., Bianchi, M., Cavani, C., 2009. Development of rabbit meat products fortified with n-3 polyunsaturated fatty acids. *Nutrients* 1, 111–118.
- Pires, J., Alvin-Ferraz, M., Martins, F., Simões, M., 2012. Carbon dioxide capture from flue gases using microalgae: engineering aspects and biorefinery concept. *Ren. Sustain. Energy Rev.* 16, 3043–3053.
- Richmond, A., 1990. *Handbook of microalgal mass culture*. CRC Press, Boston, MA, USA.
- Richmond, A., 2004. *Handbook of microalgal culture: biotechnology and applied phycology*. Blackwell Science Ltd. Pondicherry, Tamil Nadu, India.
- Richmond, A., Cheng-Wu, Z., 2001. Optimization of a flat plate glass reactor for mass production of *Nannochloropsis* sp. *Outdoors. J. Biotechnol.* 85, 259–269.
- Romano, L., Bellitti, M.R., Nicolaus, B., Lama, L., Manca, M.C., Pagnotta, E., et al., 2000. Lipid profile: a chemotaxonomic marker for classification of a new cyanobacterium in *Spirulina* genus. *Phytochemistry* 54, 289–294.
- Rossi, N., Derouiniot-Chaplain, M., Jaouen, P., Legentilhomme, P., Petit, I., 2008. *Arthrospira platensis* harvesting with membrane: goulting phenomenon with limiting and critical flux. *Bioresour. Technol.* 99, 6162–6167.
- Rubio, J., Souza, M., Smith, R., 2002. Overview of flotation as a wastewater treatment technique. *Miner. Eng.* 15, 139–155.
- Sharma, L., Singh, A.K., Panda, B., Mallick, N., 2007. Process optimization for poly- β -hydroxybutyrate production in a nitrogen fixing cyanobacterium, *Nostoc muscorum* using response surface methodology. *Bioresour. Technol.* 98, 987–993.
- Shu, I., Lee, C., 2003. Photobioreactor engineering: design and performance. *Biotechnol. Bioprocess Eng.* 8, 313–321.
- Soletto, D., Binaghi, L., Lodi, A., Carvalho, J., Converti, A., 2005. Batch and fed-batch cultivations of *Spirulina platensis* using ammonium sulphate and urea as nitrogen sources. *Aquaculture* 243, 217–224.
- Spoalore, P., Joannis-Cassn, C., Duran, E., Isambert, A., 2006. Commercial applications of microalgae. *J. Biosci. Bioeng.* 101, 87–96.
- Uduman, N., Qi, Y., Danquah, M., Dorde, G., Hoadley, A., 2010. Dewatering of microalgal cultures: a major bottleneck to algae-based fuels. *J. Renew. Sust. Energ.* 2, 012701.
- Ugwu, C., Aoyagi, H., Uchiyama, H., 2008. Photobioreactors for mass cultivation of algae. *Bioresour. Technol.* 99, 4021–4028.
- Vonshak, A., 1997. *Spirulina platensis (Arthrospira) physiology, cell-biology and biotechnology*. Taylor & Francis, London, U.K. ISBN: 0-7484-0674-3.
- Wang, B., Lan, C., 2011. Optimizing the lipid production of the green alga *Neochloris oleoabundans* using Box-Behnken experimental design. *Can. J. Chem. Eng.* 89, 932–939.
- Wang, B., Lan, C., Horsman, M., 2012. Closed photobioreactors for production of microalgal biomasses. *Biotechnol. Adv.* 30, 904–912.
- Westerhoff, P., Hu, Q., Wsparza-Soto, M., Vermaas, W., 2010. Growth parameters of microalgae tolerant to high levels of carbon dioxide in batch and continuous-flow photobioreactors. *Environ. Technol.* 31, 523–532.
- Wood, B., 1998. *Microbiology of fermented food*, vol. 2, second ed. Blackie Academic and Professional, London, U.K. ISBN: 0751402168.
- Yousry, N., 2002. Color your customer health with carotenoids. www.hnherbs.com/carotenoids.pdf.
- Zaborsky, O., 1999. Marine bioprocess engineering: the missing link to commercialization. *J. Biotechnol.* 70, 403–408.
- Zijffers, J., Janssen, M., Tramper, J., Wiffels, R., 2008. Design process of an area-efficient photobioreactor. *Marine Biotechnol.* 10, 404–415.

Design of Photobioreactors for Algal Cultivation

*Hong-Wei Yen*¹, *I-Chen Hu*², *Chun-Yen Chen*³, and
*Jo-Shu Chang*⁴

¹Department of Chemical and Materials Engineering, Tunghai University,
Taichung, Taiwan

²Far East Bio-Tec Co. Ltd., Taipei, Taiwan, Far East Microalgae Ind Co. Ltd.,
Ping-Tung, Taiwan

³Center for Bioscience and Biotechnology, National Cheng Kung University
Tainan, Taiwan

⁴Department of Chemical Engineering, National Cheng Kung University,
Tainan, Taiwan

2.1 INTRODUCTION

Recently, microalgae have been recognized as a promising platform for biofuels production and biorefineries. Microalgae have very high growth rates compared with those of terrestrial plants, thereby demonstrating high CO₂ fixation efficiency and high biomass productivity. In addition, a wide range of applications of microalgae also addresses the high potential of commercialization of microalgae-based products, such as biofuels, nutraceuticals, cosmetics, pharmaceuticals, animal and aquacultural feeds, and so on. One of the key technologies that support the development of the microalgae industry is the cultivation of microalgae on a large scale and at low cost. This microalgae cultivation technology is associated with the design of the type and configuration of open or closed cultivation systems and photobioreactors, as well as the identification of the operating conditions leading to the optimal growth performance of the target microalgae. In particular, producing biofuels from microalgae requires a massive amount of microalgae biomass. This demand makes the microalgae cultivation technology even more important. In this chapter, the principles and basic knowledge of microalgae growth and mass production are introduced. Commonly used cultivation systems and photobioreactors are described. Their advantages and weaknesses are compared. In addition, some examples of the commercial

microalgae cultivation process for biofuels production are given to provide updates on the commercial development of microalgae-based biofuels. The limitations and challenges that large-scale microalgae cultivation may face are addressed and discussed.

2.2 FACTORS AFFECTING MICROALGAE GROWTH AND BIOFUELS PRODUCTION

2.2.1 Carbon Sources

Carbon sources are usually the most critical factors for the growth of microalgae. In general, microalgae can be grown under photoautotrophic, heterotrophic, and mixotrophic conditions using diversified carbon sources, such as carbon dioxide, methanol, acetate, glucose, or other organic compounds (Xu et al., 2006). *Photoautotrophic* cultivation means that microalgae use inorganic carbon (e.g., carbon dioxide or bicarbonates) as the carbon source to form chemical energy through photosynthesis (Ren et al., 2010). Some microalgae species can directly use organic carbon as the carbon source in the presence or absence of a light supply. This is called *heterotrophic* cultivation (Chojnacka and Noworyta, 2004). However, the most commonly used carbon source for microalgae growth and biofuels production is still carbon dioxide or bicarbonates, since using organic carbon sources would be too expensive for producing low-price products such as biofuels.

In addition, from the aspect of CO₂ emissions reduction, a net-zero CO₂ emission could be achieved when the biofuels are directly converted from using CO₂ as the substrate. In particular, photoautotrophic growth of microalgae represents an ideal model of reutilization of CO₂ coming from flue gas of power plants and industrial activities (Packer, 2009), as microalgae biomass can be further utilized to produce biofuels or other value-added products (Hsueh et al., 2007; Raoof et al., 2006). In addition, most microalgae have much higher cell growth and CO₂ fixation rates than terrestrial plants (around 10–50 times higher), which demonstrates another advantage of direct conversion of photoautotrophic growth of microalgae.

Therefore, it seems more reasonable from the perspectives of economic feasibility and environmental protection that microalgae-based biofuels should be produced via photoautotrophic growth of microalgae. However, another thought is to produce biofuels from microalgae grown under heterotrophic conditions using organic carbon sources (e.g., sugars) derived from biomass. In this way, biofuel productivity could be markedly enhanced, since heterotrophic growth of microalgae is usually faster than autotrophic growth (Chen, 1996). Nevertheless, again, the high cost of obtaining the organic carbon sources from raw biomass is still a great concern.

2.2.2 Nitrogen Source

Lipid accumulation in microalgae usually occurred when microalgae are cultivated under stress conditions (e.g., nitrogen starvation, nutrient deficiency, pH variations, etc.). Among those stress conditions, nitrogen limitation is the most effective and commonly used strategy for stimulating lipid accumulation in microalgae. Recent reports demonstrated that cultivation under nitrogen starvation conditions leads to a marked increase in the oil/lipid content (Mandal and Mallick, 2009). Hu et al. (2008) collected the data of lipid contents of various microalgae and cyanobacteria species under normal growth and stress conditions in a literature

survey, indicating that under stress conditions, the lipid contents of green microalgae, diatoms, and some other microalgae species are 10–20% higher than under normal conditions. However, the lipid contents of cyanobacteria were usually very low (10%) (Hu et al., 2008).

It is thought that when microalgae are cultivated under nitrogen-starvation conditions, the proteins in microalgae will be decomposed and converted to energy-rich products, such as lipids. Siaux et al. (2011) also concluded that during microalgae growth, starch would first be synthesized to reserve energy, then lipid would be produced as a long-term storage mechanism in case of prolonged environmental stress (such as nitrogen deficiency). Although a nitrogen-starvation strategy is very effective in increasing lipid content of microalgae, the nitrogen deficiency conditions often lead to a significant decrease in the microalgae growth rate, thereby causing negative effects on lipid productivity. Therefore, engineering approaches should be conducted to optimize the cultivation time for the microalgae growth period (nitrogen-sufficient condition) and lipid accumulation period (nitrogen-deficient condition) to ensure high overall oil/lipid productivity.

2.2.3 Light Supply

The type of light source is known to be a critical factor affecting the growth of microalgae due mainly to the difference in the coverage of wavelength range (Terry, 1986). In addition to the type of light source, the light intensity is also very important for microalgae growth (Grobbelaar et al., 1996; Sánchez et al., 2008; Ugwu et al., 2008; Yoon et al., 2008). In general, the effect of light intensity on the photoautotrophic growth of microalgae could be classified into several phases, such as the light-limitation phase, the light-saturation phase, and the light-inhibition phase (Ogbonna and Tanaka, 2000). To maximize biomass productivity, the saturation light intensity needs to be distributed throughout the entire microalgae cultivation system. However, this is impossible in practical cultivation systems, since the light distribution inside the photobioreactor normally decreases significantly along with the distance due to the light shading effects (see Figure 2.1), especially when the cell concentration gets very high or when

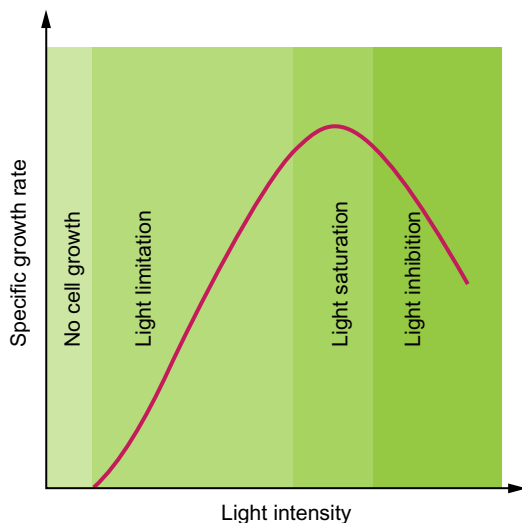

FIGURE 2.1 Effect of light intensity on specific growth rate of microalgae under phototrophic cultivation (Ogbonna and Tanaka, 2000).

significant biofilm formation on the surface of the reactor vessel occurs (Chen et al., 2008). Improving the mixing of the cells can reduce the effects of light shading or photoinhibition at different zones of the photobioreactor. Some literature describes the effect of light intensity on the lipid content of microalgae. Lv et al. (2010) demonstrated that in comparing low and high light intensity (i.e., light-limitation and light-saturation conditions), using a light intensity of $60 \mu\text{mol}/\text{m}^2/\text{s}$ led to an increase in biomass concentration and lipid content of *Chlorella vulgaris*, along with changes in pH, NADPH, and Mg^{2+} concentration (Lv et al., 2010).

2.2.4 Temperature

In commercial microalgae cultivation systems, temperature is also an important environmental factor for microalgae growth and target-product production. For outdoor microalgae cultivation, variations in temperature greatly depend on the light exposure (i.e., day/night cycle) and seasonal changes. In Taiwan, for example, the temperature variation range is between 25°C and 45°C . Appropriate cultivation temperature could promote microalgae growth, whereas at a high temperature, microalgae biomass production would decrease, primarily due to denature of essential proteins/enzymes as well as inhibitory effects on cellular physiology.

The effect of temperature on the growth rate of microalgae has been reported for a variety of microalgae species. For instance, the growth rate of *Chaetoceros pseudocurvisetus* reached a maximum level when it was grown at 25°C (Yoshihiro and Takahashi, 1995). Renaud et al. (2002) also reported that when the operation temperature was controlled at $25\text{--}30^\circ\text{C}$, the *Chaetoceros* sp. had a higher growth rate. Thus, the operation temperature has a significant effect on biomass production. In addition, Hu et al. (2008) also indicated that the environmental temperature can affect the degree of saturation of the microalgae lipid, since an increase in saturated fatty acids has been observed when the culture temperature was increased. In addition, for some microalgae (e.g., *Nannochloropsis Salina* and *Ochromonas danica*), increasing the cultivation temperature may also lead to an increase in the lipid content (Aaronson, 1973; Boussiba et al., 1987).

2.2.5 pH

The pH is also an important environmental parameter for microalgae growth and target-product formation. The optimal pH for most cultured microalgae species is between 7 and 9 (Ho et al., 2011). The pH of the culture medium normally affects the biochemical reaction characteristics of microalgae. It is crucial to maintain culture pH in the optimal range because complete culture collapse may occur due to the disruption of cellular processes by extreme pH. Meanwhile, the feeding of CO_2 obviously affects the culture pH as well as microalgae growth. When the CO_2 from the gas phase (molecular CO_2) is transferred into the culture medium, some of the CO_2 gas will dissolve and become soluble phase (HCO_3^-), and the conversion of CO_2 to HCO_3^- is greatly dependent on the pH value in the culture. The HCO_3^- is then utilized by microalgae via Ci-concentrating mechanisms (CCMs) (Miller et al., 1990).

Liu et al. (2007) reported that growth of *C. marina* remained unchanged in the normal range of pH (pH 7.5 to 8.5), whereas a significant reduction in microalgae growth was observed when pH was increased beyond 9.0 (Liu et al., 2007). Belkin and Boussiba found that a

cyanobacterium *Spirulina platensis* exhibited optimal growth at pH 9.0 to 10.0 (Belkin and Boussiba, 1991). Apparently the suitable pH range for the growth of microalgae and cyanobacteria is greatly species-dependent.

2.2.6 Salinity

The ability of microalgae to survive in marine environments has received considerable attention. It was found that microalgae can produce some metabolites to protect salt injury and to balance the influence of osmotic stresses of the surroundings. The microalgae, bacteria, and cyanobacteria can tolerate up to 1.7 M of salt concentration in marine medium. The salinity condition may stimulate the production of specific components in microalgae. For instance, Fazeli and his colleagues reported that the highest carotenoid contents (11.72 mg/L) of *Dunaliella tertiolecta* DCCBC26 occurred when the culture medium contained 0.5 M NaCl (Fazeli et al., 2006). However, salinity conditions may cause negative effects on the microalgal growth. It was reported that a salinity of 35% (standard seawater) or higher led to a reduction in the growth rate and the efficiency of photosynthesis and dark respiration (Jacob et al., 1991).

2.3 PHOTOBIOREACTOR DESIGN PRINCIPLES

In both lab-scale and pilot-scale microalgae cultivation systems, the key factors that need to be considered for the design and operation of microalgae cultivation systems are as follows: (1) how to use appropriate light sources (intensity and wavelength), (2) how to enhance light conversion efficiency, and (3) how to maintain an appropriate microalgae biomass concentration during prolonged operation. In addition, the stability of continuous culture of microalgae is usually poor, because the cell growth and target-product production are sensitive to changes in the environment and the medium composition.

Maintaining a sufficient cell concentration in the continuous microalgae cultivation system is also a challenge. Therefore, many large-scale outdoor microalgae cultivation systems are operated in a semibatch mode, in which a portion of microalgae culture is harvested within a specific cultivation time period and an equal amount of fresh medium is refilled into the cultivation system. In addition, most commercial-scale microalgae cultivation is carried out in open ponds, since solar light energy is directly utilized. Therefore, there are challenges such as contamination by other microorganisms or alien microalgae species, direct exposure to ultraviolet (UV) irradiation, low light intensity or uneven light energy distribution (Kim et al., 1997), day-night cycles, diurnal variation, and requirements for large areas of land (Laws et al., 1986). Moreover, since the intensity of sunlight varies greatly with the seasons, solar spectrum, and operating time, it is very difficult to maintain steady microalgae culture performance in outdoor cultivation.

The limitation of light energy is also one of the most commonly encountered problems in large-scale cultivation when the size of the microalgae cultivation system is increased. In this case, the illumination area per unit volume is often considered as a design criterion. The factors mentioned here greatly limit the light conversion efficiency and productivities of outdoor microalgae cultivation systems. Other factors that may also lower the biomass productivity

are consumption of biomass by respiration in the dark zones of the reactor, insufficient mixing of CO₂ and nutrients, and the mechanical damage due to the shear stress on the algal cells. Variation in biomass concentration and composition (e.g., carbohydrate or lipid content) may occur when different culture media and operation modes are used.

Despite the fact that good production performances of target products can be achieved using lab-scale microalgae cultivation systems, there are still very few successful commercial-scale processes. This is mainly because of the higher operating costs, unstable light intensity, and lower mixing efficiency when the microalgae are grown outdoors on a large scale. Consequently, appropriate operating configurations with innovative design of microalgae cultivation system are required to achieve commercially viable production of microalgae biomass and target products.

Therefore, highly efficient light sources and good circulation devices are the key to promote microalgae cell growth in the design of commercially feasible microalgae cultivation systems. If the light source has a narrow spectral output that overlaps the photosynthetic absorption spectrum of microalgae, the emission of light at unusable wavelengths would be eliminated, thereby improving the overall energy conversion. Among the available light sources, light-emitting diode (LED) is the only one that meets the foregoing criteria. LEDs are an economic external light source that is energy-saving and small enough to fit into any microalgae cultivation system. They also have a very long life expectancy, and their electrical efficiency is so high that heat generation is minimized. LEDs have a half-power bandwidth of 20–30 nm, which can match photosynthetic needs. On the other hand, circulation is also very important in the outdoor microalgae cultivation system. The benefits include keeping microalgae in suspension, decreasing heat generation within the microalgae cultivation system, uniform distribution of the cells and the liquid broth, improving CO₂ mass-transfer efficiency, and degassing the O₂ produced during photosynthesis. Therefore, the development of economically successful production of microalgae biomass requires the improvement of both light efficiency and mixing efficiency for microalgae growth at low cost.

2.4 MICROALGAE CULTIVATION IN CLOSED AND OPEN PBRs FOR BIOFUEL PRODUCTION

Production of sustainable biofuels from microalgae is a high-potential option for developing renewable energy. Unfortunately, the production cost of microalgae-based biofuels is still too high, which prevents them from becoming commercially feasible. One of the major obstacles that impedes the commercialization of microalgal biofuels is the high cost of photobioreactors and the high demand of auxiliary systems or intensive energy input required during the cultivation of microalgae. Basic conceptual designs for a photobioreactor for the autotrophic cultivation of microalgae are to provide efficient mixing, appropriate light intensity, and rapid gas transport (Singh and Sharma, 2012).

In light of these demands, photobioreactor designs can be generally classified as *open systems* and *closed systems* (Table 2.1). Open systems can be divided into natural waters (lakes, lagoons, ponds) and artificial ponds or containers, which are presented in very different ways. Apparently, open systems are potentially subject to contamination resulting from the free gas exchange from the environment to the cultivation system. The cultivation

TABLE 2.1 Advantages and Disadvantages of Open and Closed Algal Cultivation Plants (Pulz, 2001).

Parameter	Open Ponds (Raceway Ponds)	Closed Systems (PBR Systems)
Contamination risk	Extremely high	Low
Space required	High	Low
Water losses	Extremely high	Almost none
CO ₂ losses	High	Almost none
Biomass quality	Not susceptible	Susceptible
Variability as to cultivatable species	Not given; cultivation possibilities are restricted to a few algal varieties	High; nearly all microalgal varieties
Flexibility of production	Change of production between the possible varieties nearly impossible	Change of production without any problems
Reproducibility of production parameters	Not given; dependent on exterior conditions	Possible within certain tolerances
Process control	Not given	Given
Standardization	Not possible	Possible
Weather dependence	Absolute; production impossible during rain	Insignificant because closed configurations allow production during bad weather
Period until net production is reached after start or interruption	Long; approx. 6–8 weeks	Relatively short; approx. 2–4 weeks
Biomass concentration during production	Low, approx. 0.1–0.2 g/L	High; approx. 2–8 g/L
Efficiency of treatment process	Low; time-consuming, large-volume flows due to low concentrations	High; short-term, relatively small-volume flows

conditions of open systems are usually poorly controlled, and the estimated growth rate of microalgae will be mostly lower than that in closed systems.

In terms of technical complexity, open systems are more widespread than closed systems. From the aspect of operation, closed systems are more suitable for the cultivation of algae for the production of high-value products. In closed systems, the productivity of desired products can be enhanced by controlling the microalgae cultivation under optimal operating conditions. The design of closed photobioreactors must be carefully optimized for each individual algal species according to its unique physiological and growth characteristics. Providing appropriate light intensity and efficient hydrodynamic mixing are key issues in the success of a productive autotrophic cultivation system (Kumar et al., 2011).

Given the advantages of closed systems over open systems, several different photobioreactor designs with closed systems have also been proposed, ranging from lab scale to industry scale. More detailed descriptions of microalgae cultivation in open and closed systems are presented in the following sections.

2.4.1 Open Systems

Open systems can be simply categorized into natural waters (lakes, lagoons, ponds) and artificial ponds or containers. The most commonly used systems include shallow big ponds, tanks, circular ponds, and raceway ponds (Suh and Lee, 2003). Open ponds are much easier to construct and operate than most closed systems. However, major limitations in open ponds include poor light utilization by the cells, evaporative water losses, diffusion of CO₂ to the atmosphere, and the requirement of large areas of land. The ponds are usually kept shallow to ensure sufficient light exposure for the microalgae because sunlight can penetrate the pond water to only a very limited depth. Furthermore, contamination by predators, alien microalgae species, and other fast-growing microorganisms restrict the commercial production of algae in open culture systems. In addition, due to inefficient stirring mechanisms in open cultivation systems, their gas transfer rates are relatively poorer than those of closed systems. All these limitations lead to lower biomass productivities for open systems compared with those of closed systems. Nevertheless, the simple operation and easy scale-up for mass cultivation make open systems the first-choice option for microalgae cultivation in industrial applications.

2.4.1.1 Simple Ponds

The marked advantage of these open ponds is their simplicity, resulting in low production costs and low operating costs. Operation is very simple for this system, which only has a giant rotating mixer at the center of the pond to avoid the precipitation of algal biomass. Although this is indeed the simplest among all the microalgae cultivation techniques, it has a major drawback: The environment in and around the ponds is not completely under control. Bad weather conditions can stunt algae growth due to the lack of environment control. For example, high temperatures as well as insufficient or excessive sunlight intensities are critical factors affecting the efficiency of microalgae growth (Norsker et al., 2011). In addition, contamination from bacteria or other foreign microorganisms often results in the predominance of undesirable species over the desired algae growing in the pond. Rainy conditions are also a common contamination source, since the rain may flush down enormous microorganisms into the ponds from the air. Therefore, finding an appropriate cultivation location is crucial to the success of such open systems. Even though there could be many disadvantages with the simple pond system, the simple operation and the high scale-up availability of simple ponds are still very attractive factors and these ponds are often utilized for industrial production of microalgae (Borowitzk, 1999).

2.4.1.2 Raceway Ponds

Raceway ponds are a modified version of the open pond system that has a different flow pattern compared to that of the simple pond. In raceways, the water flow direction is controlled by the rotation speed of paddlewheels, in contrast to only coaxial mixing in conventional open ponds. Therefore, in the raceway systems, the microalgae, water, and nutrients are continuously circulated around a racetrack, following the same direction as a paddlewheel. In this way, the circulation rate around the racetrack can be adjusted by the paddle speed. With paddlewheels providing the driving force for liquid flow, the microalgae are kept suspended in the water and are circulated back to the surface on a regular frequency.

Despite their diversified appearance, the most common raceway cultivators are driven by paddlewheels and are usually operated at a water depth of 15–20 cm. The raceways are usually operated in a continuous mode with constant feeding of CO₂ and nutrients into the system while the microalgae culture is removed at the end of the racetrack. This operation is quite similar to that of plug-flow reactors (PFRs) used in the chemical industry.

The same drawbacks observed in the operation of open ponds are also found in raceways. Furthermore, the requirement of large areas for microalgae cultivation is considered the barrier for commercialization of microalgae processes. Nevertheless, control of environmental factors (such as mixing) in raceways is easier than in conventional open ponds, making the use of raceways for the cultivation of microalgae more attractive.

2.4.2 Closed Systems

Open systems are currently still the preferable choice for microalgal production on a large scale, especially when they are designed to produce low-priced products, such as biofuels. However, due to the requirements of good manufacturing practice (GMP) guidelines, production of high-value products from microalgae for application in pharmaceuticals and cosmetics seems feasible only in well-controlled photobioreactors with closed system operations. Therefore, several closed systems (photobioreactors) for microalgae cultivation are discussed here.

The term *closed systems* refers to photobioreactors that have no direct exchange of gases and contaminants between the cultivation systems and the outside environment. The necessary gas exchange is performed through a sterilized gas filter, to avoid contamination inside the culture system. Therefore, closed systems are characterized by the minimization of contamination over open systems. Besides the typical drawback of high equipment cost, closed-system photobioreactors do have several major advantages over open systems (Singh and Sharma, 2012): (1) Photobioreactors could minimize contamination and allow axenic algal cultivation of monocultures; (2) photobioreactors offer better control over conditions such as pH, temperature, light, CO₂ concentration, and so on; (3) using photobioreactors leads to less CO₂ loss and prevents water evaporation; (4) photobioreactors permit higher cell concentrations; and (5) photobioreactors permit the production of complex biopharmaceuticals.

There are several types of closed systems designed and developed for the cultivation of microalgae, including vertical (tubular) columns, flat plate photobioreactors, and horizontal tubular photobioreactors. The detailed descriptions of those cultivation systems are provided here. In addition, their advantages and weaknesses are summarized and compared in Table 2.2.

2.4.2.1 Vertical Column Photobioreactors

A *vertical column photobioreactor* is made up of vertical tubing (glass or acrylic) that is transparent to allow the penetration of light for the autotrophic cultivation of microalgae. A gas sparger system is installed at the bottom of the reactor; it converts the inlet gas into tiny bubbles, which provide the driving force for mixing, mass transfer of CO₂, and removing O₂ produced during photosynthesis (Figure 2.2). Normally, no physical agitation system is implemented in the design of a vertical column photobioreactor. Vertical tubular

TABLE 2.2 Prospects and Limitations of Various Culture Systems for Algae (Ugwu et al., 2008).

	Culture System	Prospects	Limitations
Open	Ponds	Relatively economical, easy to clean up after cultivation, good for mass cultivation of algae	Little control of culture conditions, difficulty in growing algae cultures for long periods, poor productivity, occupy large land mass, limited to few strains of algae, cultures are easily contaminated
	Raceway	Can be operated in a continuous mode.	High ratio of area/volume required, required high power of paddle to avoid algae precipitation
Closed	Vertical column photobioreactors	High mass transfer, good mixing with low shear stress, low energy consumption, high potentials for scalability, easy to sterilize, readily tempered, good for immobilization of algae, reduced photoinhibition and photo-oxidation	Small illumination surface area, their construction requires sophisticated materials, stress to algal cultures, decrease of illumination surface area upon scale-up
	Flat plate photobioreactors	Large illumination surface area, suitable for outdoor cultures, good for immobilization of algae, good light path, good biomass productivities, relatively cheap, easy to clean up, readily tempered, low oxygen buildup	Scale-up requires many compartments and support materials, difficulty in controlling culture temperature, some degree of wall growth, possibility of hydrodynamic stress to some algal strains
	Horizontal tubular photobioreactors	Large illumination surface area, suitable for outdoor cultures, fairly good biomass productivities, relatively cheap	Gradients of pH, dissolved oxygen and CO ₂ along the tubes, fouling, some degree of wall growth, requires large land space

photobioreactors can be categorized as bubble column or airlift reactors based on their liquid flow patterns inside the photobioreactor.

Bubble column reactors are cylindrical vessels with height greater than twice their diameter. They are characterized by low capital cost, high surface-area-to-volume ratio, lack of moving parts, satisfactory heat and mass transfer, relatively homogenous culture environment, and efficient release of O₂ and residual gas mixture (Loubière et al., 2009). The gas bubbling upward from the sparger provides the required mixing and gas transfer. Therefore, the sparger's design is critical to the performance of a bubble column. In scale-up of the photobioreactor, perforated plates are adopted as the sparger used in tall bubble columns to break up and redistribute coalesced bubbles (Janssen et al., 2000). Light supply for autotrophic cultivation often comes from outside the column. Nevertheless, an inner-illumination design is gradually becoming acceptable due to higher light-penetration efficiency and more uniform light distribution (Loubière et al., 2009). Photosynthetic efficiency greatly depends on gas flow rate as well as the light and dark cycle created when the liquid is circulated regularly from central dark zone to external zone at a higher gas flow rate.

Airlift reactors, common in traditional bioreactor designs, are made of a vessel with two interconnecting zones. One of the tubes, called a *gas riser*, is where the gas mixture flows

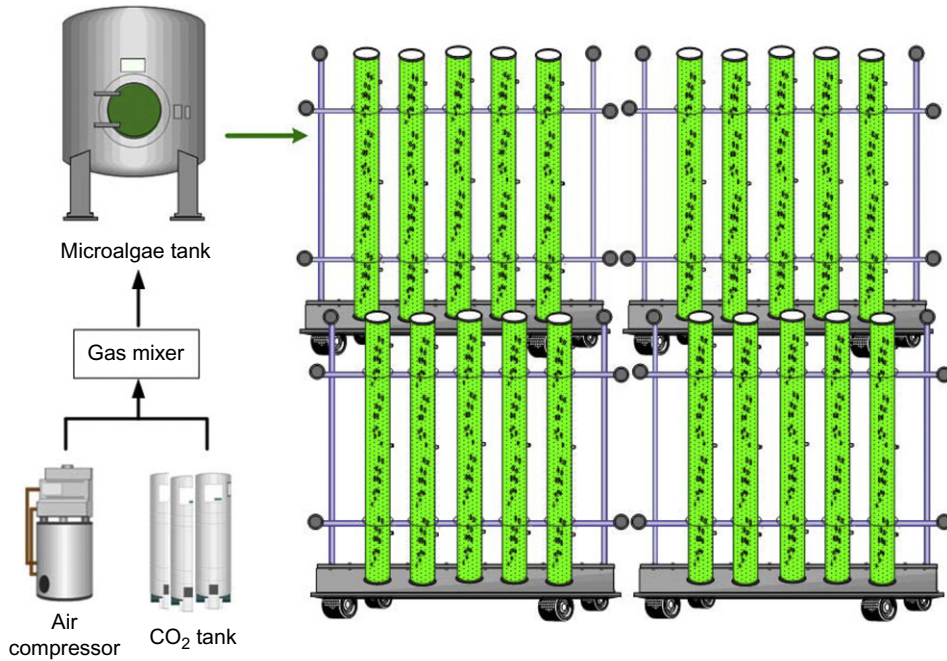

FIGURE 2.2 Vertical-column photobioreactors for microalgae cultivation.

upward to the surface from the sparger. The other region, called the *downcomer*, does not receive the gas, but the medium flows down toward the bottom and circulates within the riser and the downcomer. Based on the circulation mode, the design of an airlift reactor can be further classified into one of two forms: internal loop or external loop (Loubière et al., 2009). The riser is similar to that designed for a bubble column, where the gas moves upward randomly and haphazardly. An airlift reactor has the advantage of creating flow circulation where liquid culture passes continuously through dark and light phases, giving a flashing-light effect to the microalgal cells. Residence time of gas in various zones controls performance, affecting parameters such as gas–liquid mass transfer, heat transfer, mixing, and turbulence. A rectangular airlift photobioreactor is also suggested to have better mixing characteristics and high photosynthetic efficiency, but the design complexity and difficulty in scale-up both are disadvantages.

2.4.2.2 Flat Plate Photobioreactors

Flat panel photobioreactors feature important advantages for mass production of photoautotrophic microorganisms. The simple flat plate photobioreactor consists of vertically translucent flat plates, which are illuminated on both sides and stirred by aeration (Figure 2.3). This simple building methodology for glass flat plate reactors provides the opportunity to easily construct reactors with any desired light path. Light is evenly emitted from a flat transparent surface screen or from lamps above the culture. The plate surface is usually made of glass or optical light film, and the circulation is achieved by the same means of rising air bubbles, as

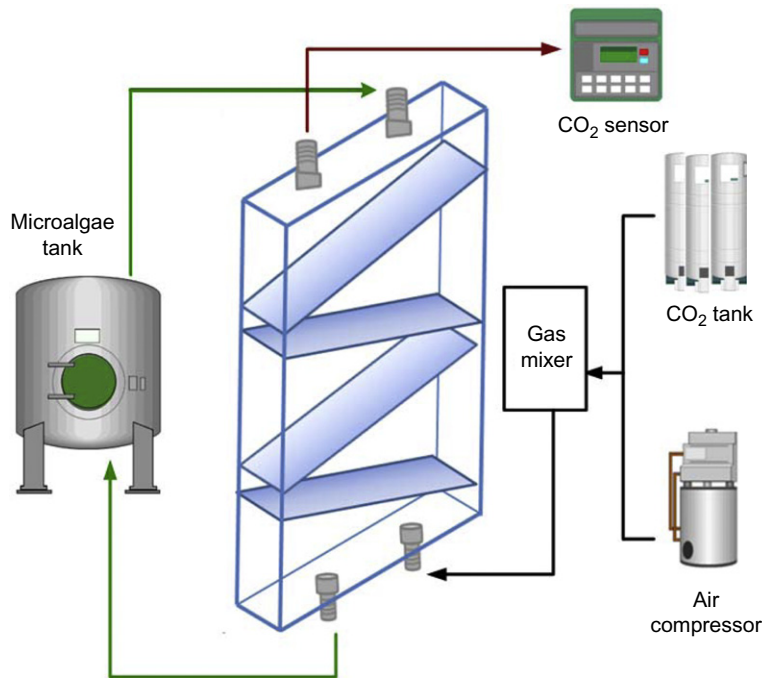

FIGURE 2.3 Plate-type photobioreactors for microalgae cultivation.

with the tubular systems. However, flat plate systems may also experience problems with relatively high space requirements, high light energy requirements, difficulties in cleaning, and possible low efficiency in terms of mass production per unit of space (Slegers et al., 2011). The productivity of flat-plate photobioreactors is highly dependent on the space requirements between the panels and the areal productivity constraint for outdoor application. On the other hand, if the flat plate systems are to be operated indoors, then some crucial factors would be involved, including distance of light sources from panels, temperature effects, illumination of one or both panel sides, light path, and so on. Scale-up of the flat plate system is potentially difficult due to the increase of hydrostatic pressure with the increase of volume. In general, the structure of flat plate systems cannot tolerate very high pressure. Moreover, the hydrodynamic stress on microalgae cells may affect the microalgae growth. In addition, the biomass productivity in parallel flat panels is strongly influenced by shading and light penetration between the panels (Posada et al., 2012). To further reduce the equipment cost, a novel design of a vertical flat panel photobioreactor, consisting of a transparent bag (i.e., plastic) located on a rigid frame, has been proposed and could greatly enhance the economic feasibility (Tredici and Rodolf, 2004).

2.4.2.3 Horizontal Tubular Photobioreactors

Tubular systems are widely used as close systems in commercial production. Usually tubular photobioreactors are made of transparent polypropylene acrylic or polyvinylchloride

pipes with small internal diameters to increase the penetration of light. Mixing and agitation of the culture are maintained by an air pump to provide circulation (see [Figure 2.4](#)).

The most significant characteristic of this tubular system that is different from the vertical column bioreactor is the improvement of air-residence time inside the tubular bioreactor, which can provide more dissolved CO_2 . These systems could use artificial light, but they are also designed based on natural light (sunlight) provided from outside of the tube. The hydrodynamic stress on the algae may vary, depending on the flow characteristics of each system (e.g., turbulent flow, pump type). Likewise, the gas transfer to the culture may vary from low to high, depending on the flow characteristics and the air-supply technique adopted. The operational difficulties are similar to other systems, including growth of microalgae on the wall of the tubes, thus blocking the light penetration; high oxygen concentration that can inhibit photosynthesis; and limits on the length of the tube in a single run ([Briassoulis et al., 2010](#)).

Coil-type systems are often adopted to enhance the efficiency of space utilization compared to the other categories. Among the most important advantages of the system and common to most coil-type systems are the larger ratio of surface area to culture volume to receive illumination effectively, as well as the easy control of temperature and contaminants ([Briassoulis et al., 2010](#)). The cleaning problems of tubular systems are not easy to overcome due to the small internal tube size, which has no ready mechanical way to conduct the inside cleaning for a long tube. The scale-up of these systems is relatively easy compared with other photobioreactor designs. The increase of tubular photobioreactor working volume can easily be achieved by simply extending the tube length to the designed volume if the air pump can affordably provide enough power to pump in air bubbles.

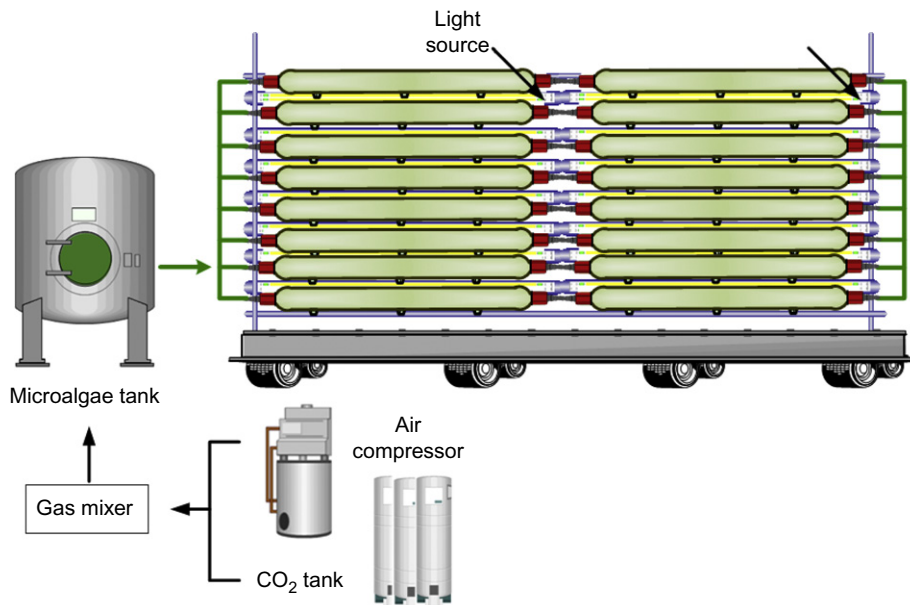

FIGURE 2.4 Horizontal tubular photobioreactors for microalgae cultivation.

2.4.3 General Discussion of Microalgae Cultivation Systems

Despite the fact that great progress has been made in developing photobioreactors for mass production of microalgal cells, more efforts are still required for further improvement, especially regarding the cost reduction of bioreactor design. For large-scale outdoor microalgae cultivation, large amounts of required land space are still the critical issue. In addition, since outdoor photobioreactors usually utilize natural solar light and without additional temperature control, the growth of biomass would greatly depend on weather conditions and ambient temperature. Due to these limitations, in most regions of the world it is not feasible to have stable microalgal biomass production through outdoor mass cultivation. In addition, the potential contamination is also a serious threat to the operational success of outdoor open ponds or raceways. In contrast, closed system photobioreactors have the advantages of better operational stability and condition control. However, the high equipment cost and process cost of closed photobioreactors are still barriers impeding the mass cultivation of microalgae. Finding more rigid, reliable, and transparent materials with lower costs for the design of closed photobioreactors is crucial to enhance cultivation efficiency and to reduce the cost of photobioreactors for the development of closed systems for the autotrophic cultivation of microalgae.

2.5 COMMERCIAL MICROALGAE CULTIVATION SYSTEMS FOR BIOFUEL PRODUCTION

Many companies are currently engaged in algae-based biofuel research, but players with large-scale production abilities are still few. According to a recent article (Jacquot, 2009), the leading companies in this field are Algenol Biofuels, Sapphire Energy, Seambiotic, Solazyme, and Solix BioSystems (ordered alphabetically). Mass cultivation to offer algae biomass as starting materials is critical to these algae-based biofuel companies. Based on the information on the Websites of these five leading companies, they all developed their proprietary and specialized cultivation methods (see Table 2.3), including photobioreactor systems, open pond systems, and fermentation systems.

Algenol developed a technology, known as Direct to Ethanol[®], to produce ethanol from cyanobacteria. Two central components in this technology are gene-modified cyanobacteria and a flexible plastic-film photobioreactor. The genetically modified cyanobacteria can overexpress fermentation pathway enzymes and enhance the ethanol production (see Figure 2.5). The photobioreactors Algenol uses are constructed of flexible plastic film. Each photobioreactor consists of ports for ethanol collection and the introduction of CO₂ and nutrients, a mixing system, and ethanol collection rails (see Figure 2.6). Therefore, Algenol claims that they produce biofuel directly from the algae without killing or harvesting the creatures.

Solix also uses photobioreactors to cultivate algae, and they have named their system the Lumian[™] Algae Growth System (AGS[™]). The AGS system comprises a network of thin panels held in a shallow water bath. The commercialized AGS system is the Lumian AGS4000, which is a 4,000-liter cultivation system with 20 200-liter Lumian panels held in a 12 × 60-foot water-filled system (see Figure 2.7). Furthermore, this system is integrated with a support system for

TABLE 2.3 The Comparison of Five Leading Microalgae-Based Biofuel Companies.

Company Name	Founded Time	Location	Biofuel Type	Technology	Cultivation Equipments	Market
Algenol Biofuels	2006	Florida, USA	Ethanol	<p>Algenol’s patented technology (known as Direct to Ethanol® Technology) enables the production of ethanol for less than \$1.00 per gallon and targets commercial production of 6,000 gallons of ethanol per acre per year.</p> <p>Algenol selects cyanobacteria strains and enhances their ability to produce ethanol by overexpressing fermentation pathway enzymes, allowing each cell to channel carbon into ethanol production.</p> <p>Algenol uses a proprietary photobioreactor system to cultivate cyanobacteria and collect ethanol. The method involves a marine strain of algae and therefore can use seawater. It also has the added benefits of consuming carbon dioxide from industrial sources and not using farmland.</p>	<p>Algenol’s proprietary flexible plastic film photobioreactor (PBR). Capital costs to construct its patented facility will range between \$4.00 and \$6.00 per annual gallon of capacity.</p> <p>A pilot-scale integrated biorefinery in Florida on 36 acres was broken ground in 2011.</p>	<p>Algenol intends to produce 1 billion gallons annually by 2012. The company says its production costs will be less than \$1.00 per gallon (sale for \$3.00 per gallon). Algenol’s goal is 20 billion gallons per year of low-cost ethanol by 2030.</p>
Sapphire Energy	2007	Headquarters in San Diego, USA; green crude farm in New Mexico, USA	A liquid that has the same composition as crude oil	<p>Sapphire produces “green crude,” a liquid that has the same composition as crude oil.</p> <p>The company has shown that its fuel can be used in</p>	<p>The company uses open ponds, raceway.</p> <p>The test site in Las Cruces, NM, at 22 acres, has more than 70 active ponds, varying in size from</p>	<p>The first phase of Sapphire’s Green Crude Farm was operational in August 2012. When completed, the facility will produce 1.5 million</p>

Continued

TABLE 2.3 The Comparison of Five Leading Microalgae-Based Biofuel Companies—Cont'd

Company Name	Founded Time	Location	Biofuel Type	Technology	Cultivation Equipments	Market
				two commercial flights (Continental and JAL airlines) and a cross-country road trip (Algaeus).	14-foot test ponds to 300-foot, 1-million-liter production ponds. The green crude farm located in Columbus, NM, will have 300 cultivated acres.	gallons per year of crude oil and consist of approximately 300 acres of algae cultivation ponds and processing facilities. The plan is to make 1 million gallons of diesel and jet fuel per year by 2011, 100 million gallons by 2018, and 1 billion gallons per year by 2025.
Seambiotic	2003	Israel	Biodiesel and bioethanol	Seambiotic grows microalgal cultures in open ponds using flue gases such as carbon dioxide and nitrogen from a nearby coal plant as feedstocks. The 1,000-square-meter facility produces roughly 23,000 grams of algae per day. Three tons of algal biomass would yield around 100 to 200 gallons of biofuel.	Open ponds, raceway.	Seambiotic's Algae Plant in China was finished in late 2011 with raceway ponds on approximately 10 hectares. Seambiotic believes that this plant is able to produce enough algae biomass to convert into fuel at prices competitive with traditional fuel by 2012.
Solazyme	2003	South San Francisco, USA	Biodiesel	Solazyme's proprietary microalgae are heterotrophic, grow in the dark in fermenters, and are fed plant sugars.	Standard industrial fermentation equipment.	In 2010, Solazyme delivered over 80,000 liters of algal-derived biodiesel and jet fuel to the U.S. Navy. Subsequently, Solazyme was awarded another contract with the U.S. Department of Defense for production of up to 550,000 additional

Continued

TABLE 2.3 The Comparison of Five Leading Microalgae-Based Biofuel Companies—Cont'd

Company Name	Founded Time	Location	Biofuel Type	Technology	Cultivation Equipments	Market
Solix BioSystems	2006	Colorado, USA	Biodiesel	<p>Solix uses a proprietary closed photobioreactor system and claims that the system can produce up to seven times as much biomass as open-pond systems.</p> <p>The algal oil is extracted through the use of chemical solvents such as benzene or ether.</p> <p>Solix is also collaborating with the Los Alamos National Laboratory to use its acoustic-focusing technology to concentrate algal cells into a dense mixture by blasting them with sound waves. Oil can then be extracted from the mixture by squeezing it out; this makes the extraction process much easier and cheaper, obviating the need for chemical solvents.</p>	<p>Photobioreactor system includes Solix's proprietary Lumian™ panels, Solix Lumian™ Algae Growth System (AGS™).</p> <p>Solix's demonstration plant has three algae cultivation basins totaling 3/4 of an acre (0.3 hectares). The plant has over 150,000 liters of algae under cultivation.</p>	<p>liters of naval distillate fuel.</p> <p>Solazyme went public (IPO) in 2011 at \$18 per share and raised \$198 million in the process. In 2012, Solazyme expected to archive a 2-million-liter annual capacity.</p> <p>Solix's demonstration facility performed at over 3,000 gallons of algae oil per acre per year in 2010.</p>

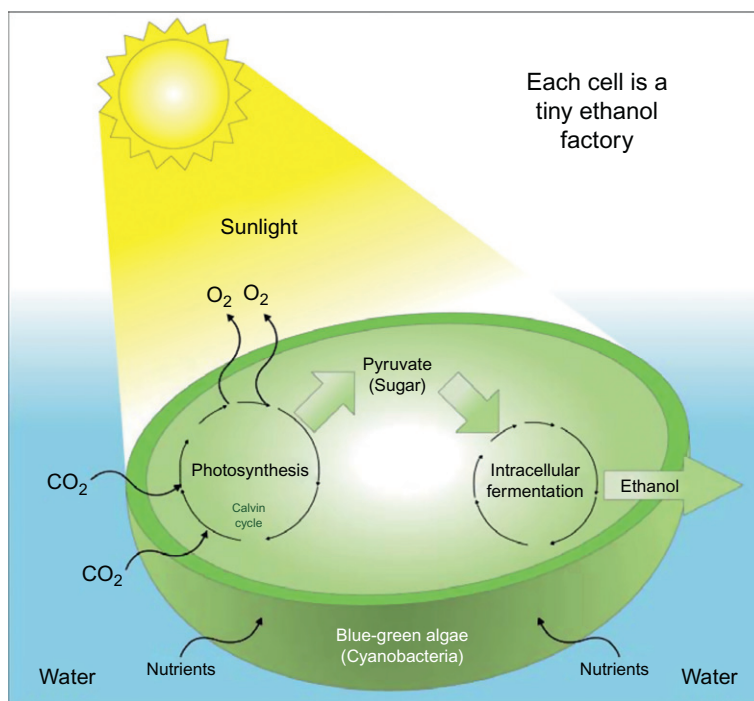

FIGURE 2.5 The process of Algenol's Direct to Ethanol[®] technology (www.algenolbiofuels.com/media/media-gallery).

media preparation, harvesting, reinjection, and system cleaning. Before 2009, the introduction of the Lumian AGS system especially mentioned the vertical orientation of panels that can provide "extended surface area." However, according to the pictures on Solix's Website, the panels now are horizontally arranged. The AGS panels contain tubes that deliver CO₂ as a carbon source and deliver air to remove oxygen (a byproduct of photosynthesis). According to an article of the IOP Conference Series in 2009 (Willson, 2009), the marginal cost of large-scale production using the AGS system was approximately \$1/liter (\$150/barrel), with a defined path of reducing the production cost by half over the next two to three years.

Sapphire and Seambiotic both choose raceway open ponds to cultivate their algae. Sapphire releases very little technology information about its process: "We grow the algae in open ponds with only sunlight, CO₂, and nonpotable saltwater in deserts" (see Figure 2.8a). Seambiotic also grows microalgal cultures in raceway open ponds using flue gases carbon dioxide and nitrogen from a nearby coal plant as the feedstock (see Figure 2.8b). Seambiotic has carried out an R&D pilot study comprising about a 1,000-meter square of ponds in an Israel power plant to use the flue gas to cultivate algae. Both companies emphasize the low cost of using open ponds and choose marine algae strains to reduce biotic contamination.

Solazyme's algal cultivation method is much different from those of the previously mentioned companies. Solazyme uses large fermentation tanks to incubate algae in the dark and feed them plant sugars. This platform makes the feedstock more flexible, and it is able to use

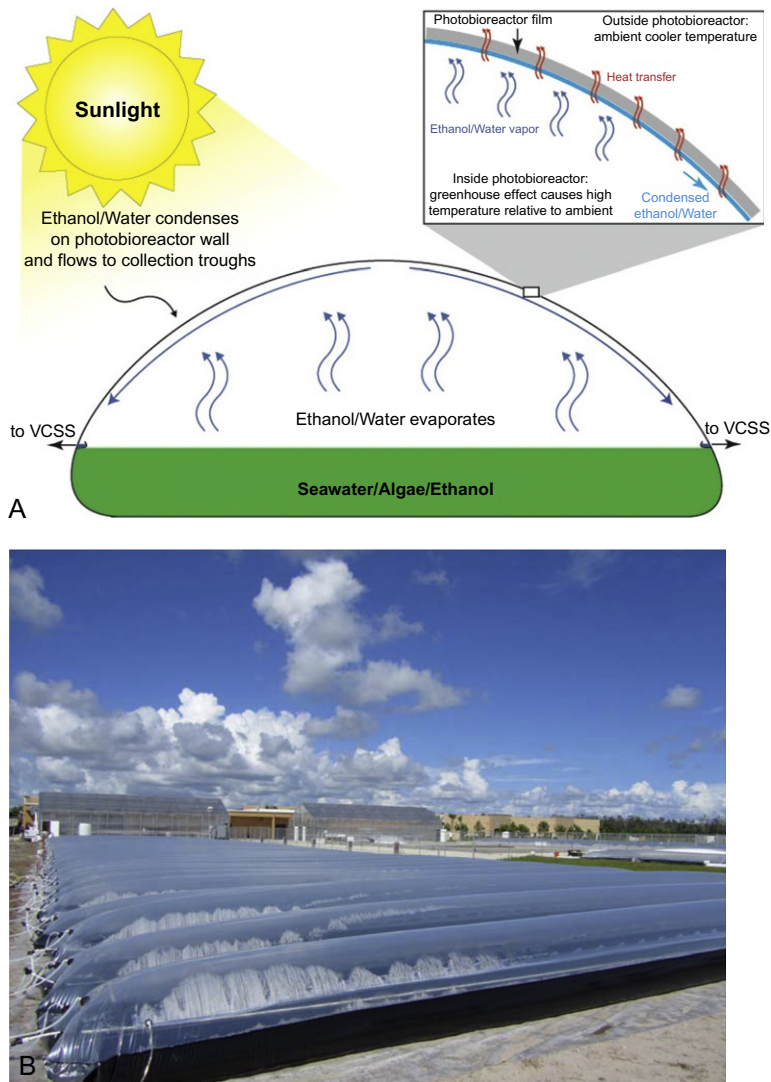

FIGURE 2.6 The flexible plastic film photobioreactors used by Algenol; A) the structural diagram, B) the appearance (www.algenolbiofuels.com/media/media-gallery).

low-cost sugars, varying from sugarcane to corn stover, woody biomass, switchgrass, and other cellulosic materials. By this heterotrophic incubation, algae can accumulate more oil in cells. According to data shown on Solazyme's Website, the oil content in the company's algae cells is in excess of 80% (see Figure 2.9). Considering that the average wild alga yields only 5–10% oil content, this enhanced yield is very critical to lowering the production cost of biofuels.



FIGURE 2.7 The Solix Lumian™ AGS4000 system (www.solixbiofuels.com/content/products/lumian-ags4000).



FIGURE 2.8 (a) Sapphire's green crude farm with raceway open ponds (www.sapphireenergy.com/rendition.medium/images/multimedia/green%20crude%20farm%20ponds.jpg). (b) Seambiotic's pilot plant (www.seambiotic.com/uploads/Seambiotic%20Ltd.%20-%20Algae%20Pilot%20Plant%20white%20paper.pdf).

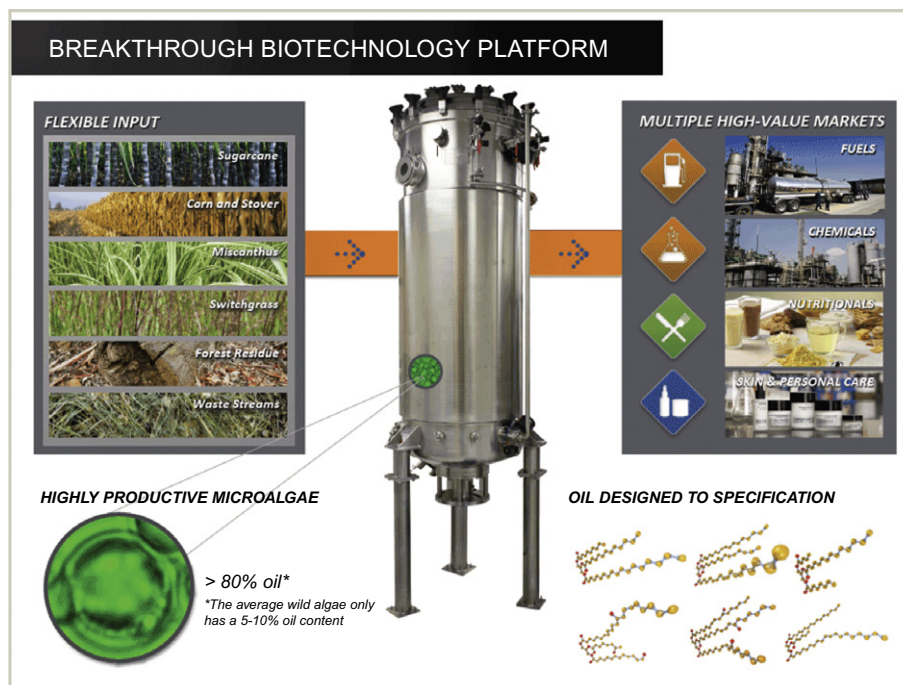

FIGURE 2.9 Solazyme's heterotrophic algae cultivation platform (<http://solazyme.com/technology>).

2.6 CONCLUSIONS

Production of biofuels and other products from microalgae requires a massive amount of microalgae biomass. Effective cultivation technology for large-scale microalgae biomass production is of great importance in the commercialization of the microalgae-based industry. The growth of microalgae is greatly influenced by environmental conditions, such as light supply, temperature, CO₂ supply, and so on. Therefore, an appropriate operating condition to create optimal conditions should be applied for microalgae cultivation. Moreover, the design and configuration of cultivation systems and photobioreactors also play a pivotal role in the mass production of microalgae biomass.

Toward that end, various open and closed cultivation systems have their own pros and cons. In general, closed systems provide better stability and cultivation efficiency, whereas open systems are much cheaper and easier to scale up. As a result, selection of a suitable cultivation system is highly dependent on the characteristics of the target microalgae species as well as the climate and environmental conditions of the cultivation site. In addition, since outdoor cultivation of microalgae is inevitable for commercial applications, people need to cope with the challenges and limitations arising from the natural environment, such as the availability of sunlight, the limitation of CO₂ and nutrient sources, and variations in ambient temperatures. Furthermore, a cost and life-cycle analysis should be performed on the developed process to assess economic feasibility as well as environmental impacts.

References

- Aaronson, S., 1973. Effect of incubation temperature on the macromolecular and lipid content of the phytoflagellate *Ochromonas danica*. J. Phycol. 9, 111–113.
- Belkin, S., Boussiba, S., 1991. Resistance of *Spirulina Platensis* to ammonia at high pH values. PCPhy 32, 953–958.
- Borowitzk, M.A., 1999. Commercial production of microalgae: ponds, tanks, tubes and fermenters. J. Biotechnol. 70, 313–321.
- Boussiba, S., Vonshak, A., Cohen, Z., Avissar, Y., Richmond, A., 1987. Lipid and Biomass Production by the Halotolerant Microalga *Nannochloropsis-Salina*. Biomass 12, 37–47.
- Brissoulis, D., Panagakis, P., Chionidis, M., Tzenos, D., Lalos, A., Tsinos, C., et al., 2010. An experimental helical-tubular photobioreactor for continuous production of *Nannochloropsis sp.* Bioresour. Technol. 101, 6768–6777.
- Chen, F., 1996. High cell density culture of microalgae in heterotrophic growth. Trends Biotechnol. 14, 421–426.
- Chen, C.Y., Saratale, G.D., Lee, C.M., Chen, P.C., Chang, J.S., 2008. Phototrophic hydrogen production in photobioreactors coupled with solar-energy-excited optical fibers. Int. J. Hydrogen Energy 33, 6878–6885.
- Chojnacka, K., Noworyta, A., 2004. Evaluation of *Spirulina sp.* growth in photoautotrophic, heterotrophic and mixotrophic cultures. Enzyme Microb. Technol 34, 461–465.
- Fazeli, M.R., Tofighi, H., Samadi, N., Jamalifar, H., 2006. Effects of salinity on beta-carotene production by *Dunaliella tertiolecta* DCCBC26 isolated from the Urmia salt lake, north of Iran. Bioresour. Technol. 97, 2453–2456.
- Grobbelaar, J.U., Nedbal, L., Tichy, V., 1996. Influence of high frequency light/dark fluctuations on photosynthetic characteristics of microalgae photoacclimated to different light intensities and implications for mass algal cultivation. J. Appl. Phycol. 8, 335–343.
- Ho, S.H., Chen, C.Y., Lee, D.J., Chang, J.S., 2011. Perspectives on microalgal CO₂-emission mitigation systems — A review. Biotechnol. Adv. 29, 189–198.
- Hsueh, H.T., Chu, H., Yu, S.T., 2007. A batch study on the bio-fixation of carbon dioxide in the absorbed solution from a chemical wet scrubber by hot spring and marine algae. Chemosphere 66, 878–886.
- Hu, Q., Sommerfeld, M., Jarvis, E., Ghirardi, M., Posewitz, M., Seibert, M., et al., 2008. Microalgal triacylglycerols as feedstocks for biofuel production: perspectives and advances. Plant J. 54, 621–639.
- Jacob, A., Kirst, G.O., Wiencke, C., Lehmann, H., 1991. Physiological-Responses of the Antarctic Green-Alga *Prasiola-Crispa Ssp Antarctica* to Salinity Stress. J. Plant Physiol. 139, 57–62.
- Jacquot, J., 2009. 5 Companies Making Fuel From Algae Now. Popular Mechanics. <http://www.popularmechanics.com/science/energy/biofuel/4333722>.
- Janssen, M., Bresser, L.d., Baijens, T., Tramper, J., Mur, L.R., Snel, J.F.H., et al., 2000. Scale-up aspects of photobioreactors: effects of mixing-induced light/dark cycles. J. Appl. Phycol 12, 225–237.
- Kim, B.W., Chang, K.P., Chang, H.N., 1997. Effect of light source on the microbiological desulfurization in a photobioreactor. Bioprocess Engineering 17, 343–348.
- Kumar, K., Dasgupta, C.N., Nayak, B., Lindblad, P., Das, D., 2011. Development of suitable photobioreactors for CO₂ sequestration addressing global warming using green algae and cyanobacteria. Bioresour. Technol. 102, 4945–4953.
- Laws, E.A., Taguchi, S., Hirata, J., Pang, L., 1986. High algal production rates achieved in a shallow outdoor fume. Biotechnol. Bioeng 28 (2), 191–197.
- Liu, W., Au, D.W.T., Anderson, D.M., Lam, P.K.S., Wu, R.S.S., 2007. Effects of nutrients, salinity, pH and light:dark cycle on the production of reactive oxygen species in the alga *Chattonella marina*. J. Exp. Mar. Biol. Ecol. 346, 76–86.
- Loubière, K., Olivo, E., Bougaran, G., Pruvost, J.r.m, Robert, R., Legrand, J., 2009. A New Photobioreactor for Continuous Microalgal Production in Hatcheries Based on External-Loop Airlift and Swirling Flow. Biotechnol. Bioeng 102, 132–147.
- Lv, J.M., Cheng, L.H., Xu, X.H., Zhang, L., Chen, H.L., 2010. Enhanced lipid production of *Chlorella vulgaris* by adjustment of cultivation conditions. Bioresour. Technol. 101, 6797–6804.
- Mandal, S., Mallick, N., 2009. Microalga *Scenedesmus obliquus* as a potential source for biodiesel production. Appl. Microbiol. Biotechnol. 84, 281–291.
- Miller, A.G., Espie, G.S., Canvin, D.T., 1990. Physiological-Aspects of Co₂ and Hco₃- Transport by Cyanobacteria - a Review. Canadian Journal of Botany-Revue Canadienne De Botanique 68, 1291–1302.
- Norsker, N.H., Barbosa, M.J., Vermuë, M.H., Wijffels, R.H., 2011. Microalgal production — A close look at the economics. Biotechnol. Adv. 29, 24–27.
- Ogbonna, J.C., Tanaka, H., 2000. Light requirement and photosynthetic cell cultivation-Development of processes for efficient light utilization in photobioreactors. J. Appl. Phycol. 12, 207–218.

- Packer, M., 2009. Algal capture of carbon dioxide; biomass generation as a tool for greenhouse gas mitigation with reference to New Zealand energy strategy and policy. *Energy Policy* 37, 3428–3437.
- Posada, J.A., Rincón, L.E., Cardona, C.A., 2012. Design and analysis of biorefineries based on raw glycerol: Addressing the glycerol problem. *Bioresour. Technol.* 111, 282–293.
- Pulz, O., 2001. Photobioreactors: production systems for phototrophic microorganisms. *Appl. Microbiol. Biotechnol.* 57, 287–293.
- Raof, B., Kaushik, B.D., Prasanna, R., 2006. Formulation of a low-cost medium for mass production of *Spirulina*. *Biomass and Bioenergy* 30, 537–542.
- Ren, L.J., Ji, X.J., Huang, H., Qu, L., Feng, Y., Tong, Q.Q., et al., 2010. Development of a stepwise aeration control strategy for efficient docosahexaenoic acid production by *Schizochytrium* sp. *Appl. Microbiol. Biotechnol.* 87, 1649–1656.
- Renaud, S.M., Thinh, L.V., Lambrinidis, G., Parry, D.L., 2002. Effect of temperature on growth, chemical composition and fatty acid composition of tropical Australian microalgae grown in batch cultures. *Aquaculture* 211, 195–214.
- Sánchez, J.F., Fernández-Sevilla, J.M., Ación, F.G., Cerón, M.C., Pérez-Parra, J., Molina-Grima, E., 2008. Biomass and lutein productivity of *Scenedesmus almeriensis*: influence of irradiance, dilution rate and temperature. *Appl. Microbiol. Biotechnol.* 79, 719–729.
- Siaut, M., Cuine, S., Cagnon, C., Fessler, B., Nguyen, M., Carrier, P., et al., 2011. Oil accumulation in the model green alga *Chlamydomonas reinhardtii*: characterization, variability between common laboratory strains and relationship with starch reserves. *BMC Biotechnol.* 11.
- Singh, R.N., Sharma, S., 2012. Development of suitable photobioreactor for algae production – A review. *Renewable and Sustainable Energy Reviews* 16, 2347–2353.
- Slegers, P.M., Wijffels, R.H., van Straten, G., van Boxtel, A.J.B., 2011. Design scenarios for flat panel photobioreactors. *Appl. Energy* 88 (10), 3342–3353.
- Suh, I.S., Lee, C.G., 2003. Photobioreactor engineering: Design and performance. *Biotechnology and Bioprocess Engineering* 8, 313–321.
- Terry, K.L., 1986. Photosynthesis in Modulated Light - Quantitative Dependence of Photosynthetic Enhancement on Flashing Rate. *Biotechnol. Bioeng.* 28, 988–995.
- Tredici, M.R., Rodolf, L., 2004. Reactor for industrial culture of photosynthetic microorganisms. *World Patent WO 2004/074423 A2*.
- Ugwu, C.U., Aoyagi, H., Uchiyama, H., 2008. Photobioreactors for mass cultivation of algae. *Bioresour. Technol.* 99, 4021–4028.
- Willson, B., 2009. The Solix AGS system: a low-cost photobioreactor system for production of biofuels from microalgae. *IOP Conf. Series: Earth and Environmental Science* 6.
- Xu, H., Miao, X., Wu, Q., 2006. High quality biodiesel production from a microalga *Chlorella protothecoides* by heterotrophic growth in fermenters. *J. Biotechnol.* 126, 499–507.
- Yoon, J.H., Shin, J.H., Ahn, E.K., Park, T.H., 2008. High cell density culture of *Anabaena variabilis* with controlled light intensity and nutrient supply. *J. Microbiol. Biotechnol.* 18, 918–925.
- Yoshihiro, S., Takahashi, M., 1995. Growth responses of several diatom species isolated from various environments to temperature. *J. Phycol.* 31, 880–888.

Intentionally left as blank

Metabolic Engineering and Molecular Biotechnology of Microalgae for Fuel Production

Su-Chiung Fang

Biotechnology Center in Southern Taiwan, Academia Sinica
Agricultural Biotechnology Research Center, Academia Sinica
Tainan, Taiwan R.O.C.

3.1 INTRODUCTION

Compared to other biofuel feedstocks, microalgae are the preferred option for many reasons:

1. They grow extremely fast and hence produce high biomass yield quickly.
2. Microalgae-based fuels do not compete with the food supply and hence present no food security concerns.
3. Biofuels generated from microalgae are renewable and can be carbon-reducing [generation of 100 tons of algal biomass is equivalent to removing roughly 183 tons of carbon dioxide from the atmosphere (Chisti, 2008)].
4. Microalgal farming does not require arable land and can utilize industrial flue gas as a carbon source.
5. Selected oleaginous microalgae do not require fresh water and can grow in seawater, brackish water, or waste water.
6. Biodiesel fuels derived from microalgae can be integrated into the current transportation infrastructure.

During the past few years, there have been significant advances in uncovering molecular components required for production of fuel molecules in microalgae. The availability of genomic sequences in the model green alga *Chlamydomonas reinhardtii* has accelerated forward

genetic analysis and allowed for the use of reverse genetic approaches to uncover molecular mechanisms associated with fuel production (Merchant et al., 2007). Moreover, transcriptomics, proteomics, and metabolomics studies have provided new insights into gene regulation networks and coordinated cellular activities governing physiological flexibility and metabolic adaptation of microalgae. Understanding the basis of microalgal biology is important in laying the foundation for innovative strategies and for ultimate development of fuel surrogates. This review summarizes recent progress in elucidating molecular and cellular mechanisms of cellular physiology that are relevant to fuel production in microalgal systems, with an emphasis on developing metabolic engineering strategies to increase fuel production.

3.2 BIODIESEL

Among the various fuel categories derived from microalgae, biodiesel receives the most attention because it shares similar chemical characteristics with petrol diesel and can be directly channeled into the current transportation infrastructure without major alterations of existing technology and fuel pipelines. Oleaginous green microalgae species that have the capacity to accumulate oil in the form of triacylglycerols, or TAGs (Chisti, 2007; Sheehan et al., 1998), have been isolated and possess great potential as a feedstock for biodiesel fuels (Converti et al., 2009; Liu et al., 2008; Xu et al., 2006). However, microalgae-based biodiesel is far from being commercially feasible, because it is not economically practical at present. From a biological point of view, one of the obvious solutions is to increase oil content. Most microalgae do not accumulate large amounts of lipid during a normal growth period. Cells begin to accumulate significant amounts of storage lipids after encountering stress conditions such as light and nutrient starvation (Hu et al., 2008; Sheehan et al., 1998). Nutrient starvation, however, slows cell proliferation and therefore limits biomass and overall lipid productivity. Despite the continuous interest in and enthusiasm about microalgal oil-to-biodiesel potential, the molecular mechanisms underlying the cellular, physiological, and metabolic networks connecting to lipid and TAG biosynthesis remain largely unknown. Recent progress in transcriptomics, proteomics, metabolomics, and lipidomics studies have started to unravel the complex molecular mechanisms and regulatory networks involved in lipid and TAG biosynthesis in microalgae.

Current efforts to isolate and characterize the repertoire of genes required for lipid and TAG biosynthesis and accumulation in microalgae have focused on a model microalga: *Chlamydomonas reinhardtii* (Li et al., 2008; Miller et al., 2010; Msanne et al., 2012). With complete genome information, many enzymes required for lipid and TAG biosynthesis and metabolism have been identified based on *in silico* predictions of orthologous genes from other organisms (Riekhof et al., 2005). Similar to oilseed crops, the most common fatty acids in microalgae are 16- and 18-carbon fatty acids (Hu et al., 2008). Genome comparison and gene prediction analyses have shown that the pathways of fatty acid and lipid biosynthesis are largely conserved between plants and green algae (Riekhof et al., 2005). In plants, *de novo* synthesis of fatty acids occurs in the plastid (Ohlrogge and Browse, 1995). The synthesized fatty acids are used as building blocks for synthesis of membrane lipids and storage lipids. Acetyl CoA serves as the basic unit for fatty acid biosynthesis. It is converted to malonyl CoA by acetyl

CoA carboxylase in the rate-limiting step for fatty acid biosynthesis. In green alga, acetyl CoA pools are probably derived mainly from glycolysis (Hu et al., 2008). The malonyl moiety in malonyl CoA is transferred to a small acyl carrier protein (ACP) by malonyl-CoA:ACP transacylase (MCT). The putative ortholog of MCT has been identified in *Chlamydomonas* (Lemaire et al., 2004). Following the synthesis of malonyl-ACP by MCT, fatty acid synthesis continues by the action of a type II fatty acid synthase composed of multiple proteins (White et al., 2005). The first condensation of malonyl-ACP and acyl-ACP is catalyzed by 3-ketoacyl-ACP synthase. The step is followed by reduction catalyzed by 3-ketoacyl-ACP reductase and dehydration catalyzed by 3-hydroxyacyl-ACP dehydratase. Another round of reduction is catalyzed by enoyl-ACP reductase. These serial reactions result in the addition of two methylene carbons to the growing acyl chain, and the cycle is repeated so that the acyl chain reaches 16 or 18 carbons. Finally, chain elongation is terminated by fatty acyl-ACP thioesterases. Free fatty acids then leave the plastids and are converted into acyl-CoA by acyl-CoA synthetase, as shown in Figure 3.1 (Riekhof et al., 2005; Stern and Harris, 2009).

Because TAGs are derived from either acylation of diacylglycerol (DAG) via a *de novo* pathway (acyl CoA-dependent pathway) or recycling of membrane lipids (acyl CoA-independent pathway), most of the metabolic engineering strategies have been designed to manipulate the rate-limiting steps of these two pathways in the hope of increasing the metabolic flux for TAG production. For the *de novo* pathway, fatty acids produced in the chloroplast are transferred in the form of acyl-CoA to positions 1 and 2 of glycerol-3-phosphate by glycerol-3-phosphate acyltransferase (GPAT) and lysophosphatidic acid acyltransferase (LPAAT), respectively. The enzymatic reactions result in the formation of phosphatidic acid (PA) (Ohlrogge and Browse, 1995). Dephosphorylation of PA by phosphatidic acid phosphatase generates DAG. In plants, DAG is a common precursor to both membrane lipid and storage TAG (Ohlrogge and Browse, 1995). Diacylglycerol acyltransferases (DGAT) utilizes acyl-CoA as an acyl donor and catalyzes acylation of DAG for TAG production. Isolation and identification of the DGATs that are able to enhance metabolic flux TAG production will be important for increasing oil content in algal cells.

In addition to the *de novo* pathway, TAG is likely to be synthesized from an acyl CoA-independent pathway in microalgae. In plants and budding yeast, phospholipids can be used as acyl donors for the synthesis of TAG from DAG catalyzed by phospholipid: diacylglycerol acyltransferases, or PDATs (Dahlqvist et al., 2000). It is already known that storage lipids are accumulated under nutrient stress conditions concomitant with reorganization of membrane lipids in microalgae (Fan et al., 2011). It is therefore reasonable to hypothesize that membrane lipids can be used as acyl donors for TAG biosynthesis under these stress conditions (Figure 3.1).

Nitrogen deficiency is by far the predominant way to induce lipid body formation in various microalgae (Hu et al., 2008). Detailed analyses have shown that nitrogen deprivation leads to a major redirection of carbon metabolism, decreased photosynthetic carbon fixation, and increased fatty acid biosynthesis (Miller et al., 2010). To explore the molecular events that link nitrogen deprivation to TAG synthesis, RNA transcriptome analysis has been employed to examine genome-wide transcript abundance and identify potential regulatory components regulating TAG metabolism in *C. reinhardtii* (Boyle et al., 2012; Miller et al., 2010). As expected, mRNAs of some of the genes involved in lipid and TAGs metabolism are increased under N-deprived conditions. Among them are mRNAs of two DGATs, diacylglycerol

pathways in plants often results in moderate effects on seed oil content (Durrett et al., 2008; Thelen and Ohlrogge, 2002). It is likely that expression of a single gene is not sufficient to drive metabolic flux toward TAG accumulation.

In agreement with increased *de novo* biosynthesis of TAG during nitrogen deprivation, acyl-ACP thioesterase (also referred to as *FAT1*), a protein that takes part in fatty acid export from the chloroplast to the ER, where TAG assembly occurs, is up-regulated (Miller et al., 2010). Moreover, mRNAs of phosphatidic acid phosphatases (PAPs) and phospholipid: diacylglycerolacyltransferase 1 (PDAT1), proteins that participate in biosynthesis of TAG, are also increased after nitrogen deprivation (Boyle et al., 2012; Miller et al., 2010). To characterize cellular functions of these isolated genes during lipid biosynthesis, reverse genetics has been employed. Consistent with the functional role of PDAT1 during TAG biosynthesis from other organisms, *Chlamydomonas pdat1* mutants accumulate less TAG than the parental strain (Boyle et al., 2012).

Nitrogen starvation has been shown to result in reorganization of the structure and breakdown of the intracellular membrane systems (Fan et al., 2011; Martin et al., 1976; Moellering and Benning, 2010). It is therefore reasonable to hypothesize that membrane lipids serve as building blocks for TAG biosynthesis under nitrogen-deprived conditions. It will be important to understand how membrane lipids are recycled for TAG biosynthesis when intracellular nitrogen is limited. In fact, PDAT1 (an acyl-CoA independent enzyme) may contribute to TAG synthesis by transferring an acyl group from phospholipid membranes to DAG during nitrogen deprivation (Oelkers et al., 2002). A greater understanding of the interplay of membrane catabolism and its interaction with physiological adaptations will be essential to devise a better strategy for metabolic engineering.

Recent studies have shown that fatty acid assembly in microalgae probably occurs in both the ER and the chloroplast (Fan et al., 2011; Goodson et al., 2011). This indicates that two sets of acyltransferases are required to facilitate TAG synthesis in the ER or chloroplast. How these different sets of acyltransferases are coordinated and regulated during TAG biosynthesis and where they are located remain to be clarified.

In addition to enzymes known to take part in fatty acid and lipid biosynthesis, much attention has been paid to identifying and isolating essential regulatory components that act in the early signaling cascade to control lipid biosynthesis (Work et al., 2012). Transcriptional factors such as APETALA2 and Ethylene-Responsive Element Binding Protein (AP2-EREBP) and those belonging to the basic/Helix-Loop-Helix (bHLH) families have been found to be up-regulated under nitrogen-deficient conditions (Miller et al., 2010). Additionally, a SQUAMOSA promoter-binding protein domain transcriptional factor has been implicated in lipid biosynthesis under nitrogen-deficient conditions (Boyle et al., 2012). It will be of great interest to test whether these transcriptional factors serve as molecular switches for biosynthesis of fatty acid and storage lipids. Following the same logic, one of the AP2 domain transcriptional regulators, WRINKLED 1 (WRI1), has been discovered to play an important role in the control of biosynthesis of storage lipids in plants (Bourgis et al., 2011; Cernac and Benning, 2004; Shen et al., 2010). Ectopic expression of WRI1 results in accumulation of TAG in developing seeds in Arabidopsis and maize (Cernac and Benning, 2004; Shen et al., 2010). In an important finding, comparative transcriptome analysis of *C. reinhardtii*, *Phaeodactylum tricornutum*, and *Thalassiosira pseudonana* has identified common regulatory genes whose expression is up-regulated under nitrogen-depleted conditions. Overexpressing one of the

genes has been shown to trigger lipid production in *Chlamydomonas* (Yohn et al., 2011). Ectopic expression or inducible expression of identified positive regulators of lipid biosynthesis and TAG assembly proteins will be preferable approaches to increase oil production in microalgae.

As microalgae undergo metabolic changes under stress conditions, neutral lipids are concentrated in a specialized structure called *lipid droplets* or *lipid bodies*. The globular lipid bodies are filled with neutral lipids and enclosed by a single-layer lipid membrane (Goodson et al., 2011; Moellering and Benning, 2010). To decipher biochemical and cellular mechanisms underlying the biogenesis, maintenance, and degradation of microalgal oil bodies, proteomic analyses have been carried out to isolate and identify novel and conserved proteins directly associated with lipid bodies (Moellering and Benning, 2010; Nguyen et al., 2011). Consistent with what was expected, proteins involved in lipid metabolism and catabolism were associated with lipid bodies (Moellering and Benning, 2010; Nguyen et al., 2011). These included acyl-coA synthetases, lipoxygenase, BTA1 (the enzyme required for the synthesis of membrane lipid diacylglycerol-N-trimethylhomoserine), GPAT, LPAAT, PDAT, lysophosphatidyl lipid acyltransferases, and lipases. Other proteins potentially involved in lipid trafficking such as small Rab-related GTPase, RAS GTPase, and subunits of the coat protein complex and its putative regulator, ARF1a, were also isolated (Moellering and Benning, 2010). It is important to note that orthologs of these proteins have also been identified in the lipid droplet proteome in animal species (Bartz et al., 2007; Cermelli et al., 2006). Isolation of these proteins in lipid bodies from different organisms suggests that mechanisms responsible for lipid biogenesis, assembly, and organization are evolutionally conserved. In addition to the proteins commonly found in the lipid body proteome, most of the isolated proteins are novel. One of these proteins is named the *major lipid droplet protein* (MLDP). MLDP is specific to the green algal lineage. Functional study of MLDP indicates that it is required to modulate lipid droplet size (Moellering and Benning, 2010). Further understanding of the biochemical and molecular functions of these proteins will be important in devising an innovative plan to increase oil body accumulation.

3.3 BIOHYDROGEN

The ability of microalgae to produce hydrogen was first reported by Gaffron and Rubin in 1942 (Gaffron and Rubin, 1942). However, the observed emission of hydrogen was transient and the amount was very minimal. In the late 1990s, Melis and co-workers demonstrated that sulfur deprivation changes cellular metabolism and allows algal culture to switch from aerobic photosynthetic growth to an anaerobic physiology state. Switching to anaerobic condition allows microalgal cultures to generate significant amounts of hydrogen for an extended period of time (Melis et al., 2000). This major breakthrough makes sustainable hydrogen production in a microalgal system a possibility. Over the years, extensive studies have been done to understand the physiology and metabolic adaptation resulting from sulfur depletion for better manipulation of biohydrogen production. Here our current understanding of hydrogen production in microalgae is highlighted and possible metabolic engineering/biotechnology strategies for improving hydrogen production are discussed.

In green microalgae, production of hydrogen is catalyzed by [FeFe]-hydrogenases. [FeFe]-hydrogenases catalyze the reversible reduction of protons to H₂ (Equation 3.1). Electrons used for the reduction reaction are derived from photosynthetic reductants. [FeFe]-hydrogenases have been isolated and identified from microalgae such as *C. reinhardtii* (Forestier et al., 2001; Happe and Kaminski, 2002), *Scenedesmus obliquus* (Florin et al., 2001), and *Chlorella fusca* (Winkler et al., 2002). Biochemical evidence supports the presence of hydrogenase activity in a variety of Chlorophycophyta (Brand et al., 1989). Because the molecular and physiological mechanisms of hydrogen production are better studied in the model organism *C. reinhardtii*, the prospects and implications of hydrogen production in microalgae will be based on the recent genetic and biochemical studies in *C. reinhardtii*.



Two highly similar [FeFe]-hydrogenases are present in the genome of *C. reinhardtii* and are named HydA1 and HydA2. Both [FeFe]-hydrogenases are activated by anaerobic conditions induced by purging with neutral gas or by sulfur deprivation of the cultures (Forestier et al., 2003). Gene expression and mRNA stability as well as the enzymatic activities of *HydA1* and *HydA2* are extremely sensitive to oxygen. For this reason, hydrogen production rapidly stops as soon as cells begin oxygenic photosynthesis. Therefore, establishing anoxic culture conditions is crucial for induction of hydrogen in algal cultures. In addition to creating anaerobic conditions, electrons required to reduce H⁺ ions are derived from photosystem II (PSII)-dependent activity (Antal et al., 2003; Antal et al., 2009) and PSII-independent plastoquinone (PQ) reduction pathways, as shown in Figure 3.2 (Chochois et al., 2009; Hemschemeier et al., 2008).

Through the PSII-dependent pathway, electrons required for hydrogen production are generated from light-dependent water-splitting reactions (photolysis). The electrons are passed through the photosynthetic electron transport chain to reduce ferredoxin (FDX). Reduced FDX then serves as an electron donor in the reduction of two H⁺ ions to H₂ by hydrogenases. A chloroplast-located pyruvate:ferredoxin oxidoreductase has been proposed to regenerate reduced FDX, which is subsequently used for H₂ production under anaerobic conditions (Atteia et al., 2006; Mus et al., 2007).

In addition to the light-dependent PSII pathway, electrons required for H₂ production can be derived from oxidation of endogenous reserves. It has been inferred that starch metabolism is important for H₂ evolution. Studies from Chochois et al. (2009) suggest that starch catabolism provides reductants to the PQ pool and the derived electrons are then passed to hydrogenases via a PSI-dependent electron transport chain. The reductants derived from starch catabolism are most likely to be NAD(P)H, which is further oxidized by a thylakoid-associated type II NADH dehydrogenase (Desplats et al., 2009; Jans et al., 2008). The contribution of starch catabolism to H₂ production has been verified by studies of mutants that failed to degrade starch (Chochois et al., 2010). These mutants have shown either slow or low hydrogen production by the PSII-independent pathway.

As mentioned earlier, sulfur limitation is by far the most common way to achieve extended H₂ production. Sulfur deprivation enhances H₂ production by adjusting photosynthetic capacity. The major effect of sulfur starvation is rapid inactivation of the PSII reaction center (Melis et al., 2000; Zhang and Melis, 2002) due to down-regulation of the *de novo* biosynthesis of the D1 protein (Wykoff et al., 1998). The decline in PSII activity reduces the amount of

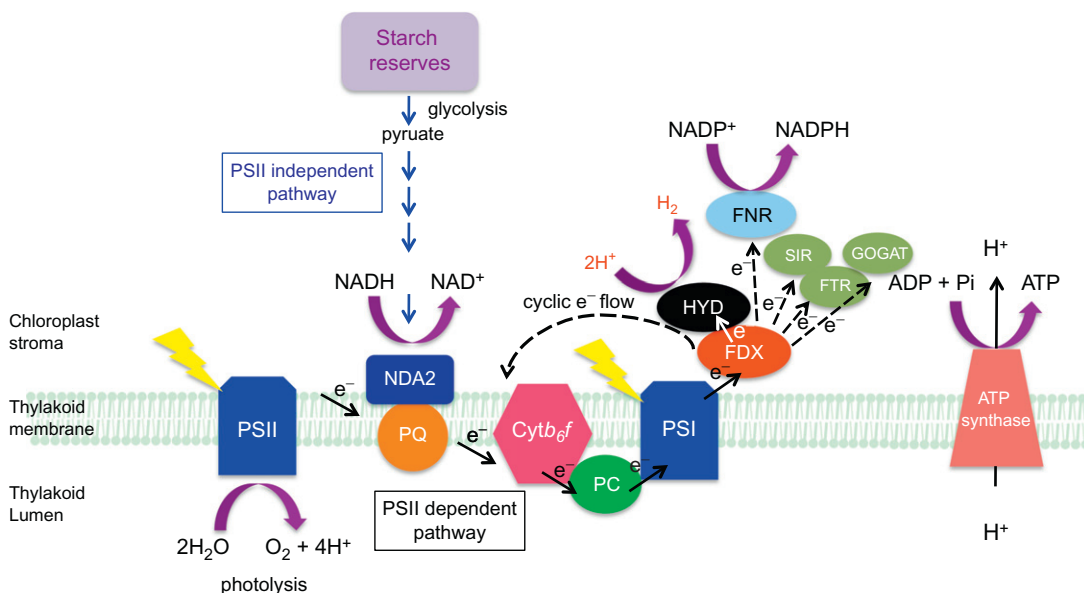

FIGURE 3.2 Electron transport pathways contributing to or competing with hydrogen production. The pathways that contribute to hydrogen production are denoted as solid arrows. The pathways that potentially compete with the hydrogenase for electrons are marked as arrows with dashed lines. PQ, plastoquinone; HYD, [FeFe]-hydrogenase; *Cytb₆f*, cytochrome *b₆f* complex; FDX, ferredoxin; NDA2, type II NAD(P)H dehydrogenase; FNR, ferredoxin-NADP⁺ reductase; SIR, sulfite reductase; FTR, ferredoxin-thioredoxin reductase; GOGAT, ferredoxin-dependent glutamate synthase.

photosynthetic oxygen evolution. As a result, the rate of photosynthetic oxygen production falls below the rate of respiration and results in anaerobic conditions that enable the induction of hydrogenase activity and H₂ production.

In addition to establishing anaerobic culture conditions, removing sulfur stimulates accumulation of starch at an early stage (Tsygankov et al., 2002; Zhang and Melis, 2002). The mechanism of how sulfur deprivation transiently boosts starch accumulation remains unclear. The accumulated starch reserves are subsequently catabolized via glycolysis to produce reducing equivalents and to feed electrons into the PSII-independent hydrogen photoproduction pathway (Hemschemeier et al., 2008; Kosourov et al., 2003). In addition, NAD(P)H produced from starch breakdown is oxidized via the mitochondrial respiratory chain, which in turn keeps oxygen levels sufficiently low to maintain the expression and activity of hydrogenases (Melis et al., 2007). Therefore, sulfur starvation not only induces and maintains anaerobic culture conditions under light, it also helps accumulate stored energy from photosynthesis to drive PSII-independent hydrogen photoproduction. In essence, metabolic and physiological adaptation of microalgae by sulfur deprivation provides ideal conditions for production of H₂.

Although sulfur deprivation improves H₂ production yield, it is still far from being economically practical. In the batch system, sulfur deprivation results in production of 1.2 mmol H₂ per mol of chlorophyll per second for up to about 120 hours (Melis et al., 2000).

The absence of sulfur eventually leads to lethal damage of cellular functions (Melis et al., 2000; Zhang et al., 2002). Various genetic and metabolic engineering approaches have been utilized to optimize hydrogen production under S-deprivation conditions. These strategies are aimed at (Antal et al., 2003) reducing the rate of oxygen evolution by decreasing PSII efficiency, (Antal et al., 2009) enhancing auxiliary electron transport pathways directing toward [FeFe]-hydrogenases, and (Atteia et al., 2006) improving [FeFe]-hydrogenases by decreasing oxygen sensitivity.

One of the major consequences of sulfur starvation is a decline of photosynthesis activity that eventually leads to anaerobic culture conditions. Decreasing O₂-evolution rates by reducing photosynthesis ability can in theory achieve anaerobiosis. Indeed, mutants defective in D1 protein (the major component of the PSII reaction center) display reduced PSII activity and substantially increased H₂ production (Faraloni and Torzillo, 2010; Torzillo et al., 2009). In addition, knocking down a chloroplast sulfate permease using genetic engineering triggers a sulfur starvation response in sulfur-replete media. The resulting cells display reduced rates of light-dependent oxygen evolution, low steady-state levels of the photosystem II D1 protein, establishment of anaerobiosis, and activation of [FeFe]-hydrogenases (Chen et al., 2005). Such microalgal strains with low rates of photosynthesis/respiration are potentially useful for an integrated and sustainable biohydrogen system (Melis and Melnicki, 2006). Following the same logic, mutants mimicking similar metabolic responses that lead to anoxic conditions will be good candidates to improve H₂ production yield without losing cell viability from prolonged S starvation.

Molecular engineering to redirect electrons to [FeFe]-hydrogenases offers another way to increase hydrogen production. FDXs are important electron donors for [FeFe]-hydrogenases. However, FDXs also function to distribute high-energy electrons for CO₂ fixation, nitrite and sulfite reduction, glutamate biosynthesis, cyclic electron flow, and reduction of thioredoxins (Figure 2). There are six [Fe₂S₂] ferredoxins present in *Chlamydomonas* (Winkler et al., 2010). Among them, PetF is thought to be the major ferredoxin involved in delivering electrons to HydA1 for H₂ production *in vivo* (Jacobs et al., 2009). Recently, amino acid residues involved in the direct interaction between FDX and hydrogenase have been identified (Chang et al., 2007; Long et al., 2008; Winkler et al., 2009). Enhancing electron transfer by manipulating binding affinity and kinetics between FDX and hydrogenase may provide a novel way to improve hydrogen production efficiency.

Another way to direct electron flow toward [FeFe]-hydrogenases is to reduce the competitive electron sink (Figure 3.2). Cyclic electron flow (CEF) is important for optimal photosynthetic activity. Instead of passing electrons from reduced FDX to generate NADPH following the photosynthetic linear electron transport chain, CEF generates cyclic electron flow around PSI by passing electrons from reduced FDX to PQ through NADPH or directly to the *Cytb6f* complex to generate ATP (Rochaix, 2011). The balance between the linear photosynthesis electron transport chain and CEF is required to modulate the ratio of ATP/NADPH to meet the cellular energy demands. Disrupting electron flow to CEF can in principle divert electron flow toward hydrogenase. Indeed, blocking CEF by antimycin A has demonstrated a twofold improvement in H₂ production (Antal et al., 2009). A search for mutants with defective CEF has been carried out to isolate enhancers of H₂ production. Through fluorescence video imaging, mutants unable to switch between linear and cyclic electron transport have been isolated (Kruse et al., 1999). As expected, the *proton gradient regulation like 1* (*pgrl1*) mutant

with impaired CEF shows improved H₂ production under both sulfur-repleted and -depleted conditions (Tolleteer et al., 2011). To further channel electrons to hydrogenases via the light-independent PQ pathway, Baltz et al. overexpressed NDA2, a PQ-reducing type II NAD(P)H dehydrogenase (Jans et al., 2008), in a *pgr1* mutant background to enhance electron flow from the PQ pool (Desplats et al., 2009; Jans et al., 2008). This approach allows the *pgr1* mutant to increase H₂ by twofold (Baltz et al., Chlamydomonas meeting 2012). Similarly, the *moc1* mutant that is defective in CEF and shows modified respiratory metabolism displays ~5.4 times increased H₂ production over the WT (Kruse et al., 2005; Schonfeld et al., 2004). Introduction of a hexose uptake protein from *Chlorella kessleri* allows *Chlamydomonas* to utilize external glucose and leads to a further increase in hydrogen production (Doebbe et al., 2007). These experiments provide proof-of-principle evidence that molecular and metabolic engineering is potentially useful in improving H₂ production in microalgae.

To develop a culture system for continuous H₂ production, an inducible chloroplast gene expression system has been proposed (Surzycki et al., 2007). In this case, the PSII reaction center D2 protein (encoded by *psbD*) was engineered to be controlled in a copper-sensitive and hypoxia-inductive post-transcriptional manner. *Nac2*, a gene required for D2 protein expression, has been engineered to be controlled by a cytochrome C6 (*Cyc6*) promoter. The promoter activity of *Cyc6* is inhibited by copper and activated by hypoxia. Adding the copper leads to loss of PSII activity and subsequently anaerobic conditions and H₂ production in light. As cell cultures go anaerobic, repression of *psbD* is gradually relieved because the *Cyc6* promoter is activated by a low concentration of oxygen. Resumed expression of *Nac2* allows accumulation of D2 protein and subsequent photosynthetic growth of cell culture. As a result, manipulation of copper and subsequent creation of anaerobic conditions allow periodic and reversible H₂ production. This continuous culture system is potentially advantageous because it could operate without the penalty of nutrient starvation and reduce the cost associated with changes of growth media (Surzycki et al., 2007). However, the design of a bioreactor supporting this concept remains to be developed.

Despite the current progress, we are far from understanding the full picture of cellular and metabolic changes and fermentative adaptations during anoxia. Optimization of H₂ production requires an understanding of the combinatorial interplay between cellular physiology and metabolic pathways. The advantages of *Chlamydomonas* genetics allow large-scale genetic screening for mutants that potentially affect or enhance H₂ production (Ruhle et al., 2008; Schonfeld et al., 2004; Tolleteer et al., 2011). Despite the differences in screening strategies, mutants with elevated hydrogen production have been isolated (Kruse et al., 2005; Tolleteer et al., 2011). Because the mutants were tagged, disrupted genes could be readily isolated and identified and their biological relevance to biohydrogen production could be easily confirmed. It is expected that a saturated mutant screen will yield more insights into molecular mechanisms underlying metabolic adaptation for hydrogen emission and pave an inroad for future metabolic engineering.

Because [FeFe]-hydrogenases are irreversibly inactivated by O₂ and their expression is also negatively regulated by O₂, developing oxygen-tolerant [FeFe]-hydrogenases whose regulation is O₂ independent would in theory circumvent limitations imposed by O₂ sensitivity. Even though sequential mutagenesis followed by selection has been used to isolate oxygen-tolerant [FeFe]-hydrogenases (Flynn et al., 2002), the introduction of random mutations into the genome may result in reduced fitness that complicates further analysis. Other approaches,

such as DNA shuffling, may be useful to generate oxygen-tolerant [FeFe]-hydrogenases (Nagy et al., 2007). Molecular designs of a [FeFe]-hydrogenases based on simulations of potential gas diffusion pathways have also been proposed (Ghirardi et al., 2007). Based on electron paramagnetic resonance spectroscopy (Kamp et al., 2008) and X-ray absorption spectroscopy analyses (Stripp et al., 2009a; Stripp et al., 2009b), the structural characterization of the active site of the H-cluster explains the mechanism of oxygen sensitivity of [FeFe]-hydrogenases. The accumulated knowledge will be very useful for molecular engineering of O₂-tolerant [FeFe]-hydrogenases. Modification of [FeFe]-hydrogenases may not be sufficient to drive H₂ production. It is known that the maturation of [FeFe]-hydrogenases requires HydEF and HydG proteins whose regulation is also negatively regulated by O₂. Without the help from HydEF and HydG proteins during the maturation process, the engineered oxygen-tolerant [FeFe]-hydrogenases may not suffice to produce hydrogen in the presence of O₂. A well-rounded strategy, such as increasing the half-life of the activity of the [FeFe]-hydrogenases under aerobic conditions, could provide an alternative option (Ghirardi et al., 2007).

In addition to metabolic engineering, other strategies have been tested to optimize hydrogen photoproduction. Unfortunately, manipulation of culture conditions such as adding low levels of sulfate (Kosourov et al., 2002), altering extracellular pH (Kosourov et al., 2003), adjusting light intensity (Laurinavichene et al., 2004), optimizing medium composition (Jo et al., 2006; Ma et al., 2011), or altering growth conditions (Kosourov et al., 2007) produces only marginal improvements on H₂ yield. Immobilization of cells on a solid surface has been demonstrated to achieve better oxygen tolerance, light energy conversion efficiency, and duration of H₂ photoproduction, and to therefore maximize H₂ yield under sulfur-limited conditions (Burgess et al., 2011; Hahn et al., 2007; Kosourov and Seibert, 2009; Laurinavichene et al., 2006). To scale up production and extend the duration of H₂ photoproduction, a two-stage chemostat bioreactor system that physically separates the photosynthetic growth phase (limited-sulfate conditions) and anaerobic H₂ production phase (sulfur-deprived conditions) was designed (Fedorov et al., 2005). Based on the pilot experiment, H₂ production can last for up to 4,000 hours (more than five months). It will be of great interest to assess H₂ yield of genetically optimized H₂ producers (described previously) grown in such a two-stage chemostat bioreactor.

Recently, an integrated culture system combining photo-fermentation-based (carried out by photosynthetic green algae or cyanobacteria) and dark-fermentation-based (carried out by anaerobic purple bacteria) H₂ production units has been proposed (Melis and Melnicki, 2006). Co-cultivation of photosynthetic green algae and cyanobacteria allows utilization of a wide-range spectrum of solar irradiance and therefore improves solar energy utilization. In addition, the organic carbon and nitrogen generated from photo-fermentation can be utilized to grow anaerobic bacteria for H₂ production in a separate anaerobic bioreactor. In return, the effluents from dark fermentation of an anaerobic bioreactor can be recycled to provide nutrients for photosynthetic algae and cyanobacteria in a photobioreactor for H₂ production. The idea is to create a self-sustainable system that integrates metabolic systems of different microorganisms to optimize energy efficiency during H₂ production processes (Eroglu and Melis, 2011; Ghirardi et al., 2009; Melis and Melnicki, 2006). In addition to combining different biological systems, integration of biology and engineering in such a proposal will be very important to further advance the economics of microalgae-based energy.

3.4 OTHER STRATEGIES

3.4.1 Optimization of Light Conversion Efficiency (LHCB)

Optimization of *light conversion efficiency* (LCE) is another way to make microalgae-based biofuels cost-effective. LCE is defined by Ghirardi et al. (2009) as the “fraction of the energy content of the incident solar spectrum that is converted into chemical energy by the organism.” It has been known that sunlight intensities are much higher than those required to saturate photosynthesis. To avoid overexcitation of the photosystem, plants and green microorganisms deal with excess light by dissipating heat and emitting fluorescence. As a consequence, the realistic LCE converts solar energy to biomass is much lower than the theoretical calculation (Dismukes et al., 2008; Melis, 2009; Wijffels and Barbosa, 2010).

Another energy issue dealing with light efficiency is uneven distribution of light in a high-density cultivation system. For cells directly exposed to sunlight, up to 80% of the absorbed photons could be wasted due to dissipation of excitation by nonphotochemical quenching and photoinhibition of photosynthesis (Melis, 1999; Melis et al., 1999). On the other hand, cells underneath the culture are shaded from sunlight and have reduced photosynthesis rates.

To improve solar illumination distribution of the microalgal culture, mutants with reduced light-harvesting chlorophyll antenna sizes that would allow for efficient utilization of light energy, and therefore would increase productivity, have been proposed. The rationale of this approach is to minimize light absorption by cells on the surface and to permit greater sunlight penetrance into the deeper layers of the culture. This concept was experimentally validated by isolation and characterization of truncated light-harvesting chlorophyll antenna size (*lta*) mutants (Lee et al., 2002; Polle et al., 2000; Polle et al., 2003). Reduction of photosystem chlorophyll antenna size in *lta* mutants has been demonstrated to improve solar energy conversion efficiency and productivity. The notion has also been verified independently by an RNAi approach. Reduction of the light harvest complex I(LHCI) and LHCII antenna complex system by knocking down light harvest complex B major proteins results in improved photon capture efficiency, enhanced growth rate, and reduced photoinhibition (Mussgnug et al., 2007).

In summary, accumulated experimental evidence indicates optimization of light-capture efficiency by genetic engineering can be very useful to improve culture productivity. Designs integrating growth optimization and fuel production will be important to making microalgae-based fuel cost effective.

3.4.2 Recycling and Recovery of Co-products

To enhance the economics of microalgae-based biofuels, utilization of every ingredient of the raw biomass is important (Georgianna and Mayfield, 2012; Sheehan et al., 1998). Whereas the majority of fuels derived from microalgae have been focused on storage oils, the extracted oil accounts for only 37.9% of the energy and 27.4% of the initial fixed carbon (Lardon et al., 2009). The remaining carbon is stored in the leftover oil cakes composed of abundant proteins and carbohydrates. Hence, recycling these nutrient elements may help increase biomass margins of microalgae-based fuels (Lardon et al., 2009). Recycling algal waste by anaerobic digestion has been proposed to support the microalgae production process (Ras et al., 2011; Zamalloa et al., 2012).

Several innovative metabolic engineering strategies have been proposed recently to reduce the energy debt and increase the margins of microalgae-based fuels. One of the approaches is to establish an integrated system that takes advantage of the amenable genetic modification capability of the *Escherichia coli* (*E. coli*) system. Although microalgae can grow photosynthetically to accumulate biomass for biodiesel purposes, the leftover paste can be utilized for alcohol-fuel production by feeding it into an engineered bacterial system. Huo et al. accomplished this by genetically engineering an *E. coli* strain that is capable of converting the backbone and side chains of amino acids in pretreated biomass into two-, four- and five-carbon alcohol fuels, ammonia, and other chemicals (Huo et al., 2011). In a small-scale experiment, the authors successfully converted hydrolyzed microalgal protein biomass into alcohol fuels. This demonstration supports the potential of using microalgal biomass as a feedstock for protein-based biorefineries.

3.5 CHALLENGES AND PERSPECTIVES

Even though the optimistic outlook on microalgae-based biofuels has driven microalgal research forward, we are still far from understanding the molecular networks underlying the complex metabolic flexibility and physiological adaptations to environmental cues of photosynthetic microalgae. Elucidation of molecular mechanisms of favorable traits such as stress-induced oil accumulation and anaerobic fermentation capability is of fundamental importance to the basic biology and of practical importance to algal biotechnology. The recent efforts in sequencing algal genome sequences have facilitated isolation of genes involved in lipid biosynthesis, photosynthesis, anaerobic adaptation, and stress regulation. The utilization of reverse genetics techniques has allowed functional characterization of some of the isolated genes. Furthermore, integrated omics approaches have started to reveal novel insights into the gene regulatory networks and cellular responses associated with metabolic features for fuel production. The accumulated knowledge has generated testable hypotheses and provided strategies to increase biomass and improve fuel production. However, the molecular toolbox required for reliable genetic manipulation of microalgae remains limited to only a few species (e.g., *C. reinhardtii*, *Volvox carteri*, *Nannochloropsis sp.*, and the diatom *Phaeodactylum tricorutum*) (Kilian et al., 2011; Leon and Fernandez, 2007; Schiedlmeier et al., 1994; Schroda, 2006; Siaux et al., 2007). For other species, genetic transformations have been documented sporadically but have not been robustly applied to routine genetic modifications. Lack of a reliable toolkit makes hypothesis-driven functional studies and practical manipulation in oleaginous species impossible. Development of custom-made molecular toolkits for the chosen oleaginous algal species will be essential for metabolic engineering. Because genomic sequencing projects of various microalgae are in progress, the development of toolkits will accelerate in the coming years and shape the future of microalgal biotechnology.

The recent advances in developing innovative technologies are aimed at improving the economics of microalgae-based biofuels. However, the practical application of the current technology is still in its infancy, and most of the work has only been demonstrated at the laboratory scale level. For instance, the proposed metabolic engineering strategies to improve biodiesel production are designed to increase oil content at the per-cell level. Crucial to

overall yield relies on oil content at the per-culture basis. It is not clear whether small-scale experimental concepts can be directly translated into large-scale industrial setups. If not, what factors need to be considered and modified to allow laboratory oil producers to scale up to industrial-level production? Until now, accurate assessment of energy balance and carbon reduction potential based on industrial-scale data spanning continuous seasons remains limited. It is therefore difficult to assess the overall yield, energy balance, carbon mitigation, and environmental impacts of the yet-to-be-refined technology. Moreover, other interference factors such as parasite contamination, temperature fluctuation, weather influence, and light penetration that can potentially affect the productivity of the energy crop also need to be considered during such an assessment. To make microalgae-based fuels a realistic industrial commodity, multidisciplinary principles need to be integrated into current research strategies to establish production platforms. In particular, integration of engineering and biology, followed by life-cycle-based long-term feedback evaluation/adjustment analyses of production pipelines, will be crucial to establishing solutions and optimizing protocols for energy production from microalgae.

Currently, the algal products (mostly food supplements and cosmetics products) on the market cost approximately two orders of magnitude more than the current cost for biodiesel production derived from oleaginous crops (Wijffels and Barbosa, 2010; Wijffels et al., 2010). Therefore, the practicality of producing microalgae-based fuels using the current technology is still questionable (Chisti, 2008; Reijnders, 2008). Before the microalgae-to-fuels technology is in place, incorporating the existing high-valued commodities into fuel production pipelines may provide a sustainable business model for microalgal biotechnology.

Acknowledgment

I am grateful to Dr. Lu-Shiun Her for his valuable comments on and suggestions regarding this chapter.

References

- Antal, T.K., Krendeleva, T.E., Laurinavichene, T.V., Makarova, V.V., Ghirardi, M.L., et al., 2003. The dependence of algal H₂ production on Photosystem II and O₂ consumption activities in sulfur-deprived *Chlamydomonas reinhardtii* cells. *Biochim. Biophys. Acta* 1607, 153–160.
- Antal, T.K., Volgusheva, A.A., Kukarskih, G.P., Krendeleva, T.E., Rubin, A.B., 2009. Relationships between H₂ photoproduction and different electron transport pathways in sulfur-deprived *Chlamydomonas reinhardtii*. *International Journal of Hydrogen Energy* 34, 9087–9094.
- Atteia, A., van Lis, R., Gelius-Dietrich, G., Adrait, A., Garin, J., et al., 2006. Pyruvate formate-lyase and a novel route of eukaryotic ATP synthesis in *Chlamydomonas* mitochondria. *J. Biol. Chem.* 281, 9909–9918.
- Bartz, R., Zehmer, J.K., Zhu, M., Chen, Y., Serrero, G., et al., 2007. Dynamic activity of lipid droplets: protein phosphorylation and GTP-mediated protein translocation. *J. Proteome. Res.* 6, 3256–3265.
- Bourgis, F., Kilaru, A., Cao, X., Ngando-Ebongue, G.F., Drira, N., et al., 2011. Comparative transcriptome and metabolite analysis of oil palm and date palm mesocarp that differ dramatically in carbon partitioning. *Proc. Natl. Acad. Sci. U. S. A.* 108, 12527–12532.
- Boyle, N.R., Page, M.D., Liu, B., Blaby, I.K., Casero, D., et al., 2012. Three acyltransferases and nitrogen-responsive regulator are implicated in nitrogen starvation-induced triacylglycerol accumulation in *Chlamydomonas*. *J. Biol. Chem.* 287, 15811–15825.
- Brand, J.J., Wright, J.N., Lien, S., 1989. Hydrogen production by eukaryotic algae. *Biotechnol. Bioeng.* 33, 1482–1488.
- Burgess, S.J., Tamburic, B., Zemichael, F., Hellgardt, K., Nixon, P.J., 2011. Solar-driven hydrogen production in green algae. *Adv. Appl. Microbiol.* 75, 71–110.

- Cermelli, S., Guo, Y., Gross, S.P., Welte, M.A., 2006. The lipid-droplet proteome reveals that droplets are a protein-storage depot. *Curr. Biol.* 16, 1783–1795.
- Cernac, A., Benning, C., 2004. WRINKLED1 encodes an AP2/EREB domain protein involved in the control of storage compound biosynthesis in *Arabidopsis*. *Plant J.* 40, 575–585.
- Chang, C.H., King, P.W., Ghirardi, M.L., Kim, K., 2007. Atomic resolution modeling of the ferredoxin:[FeFe] hydrogenase complex from *Chlamydomonas reinhardtii*. *Biophys. J.* 93, 3034–3045.
- Chen, H.C., Newton, A.J., Melis, A., 2005. Role of SulP, a nuclear-encoded chloroplast sulfate permease, in sulfate transport and H₂ evolution in *Chlamydomonas reinhardtii*. *Photosynth. Res.* 84, 289–296.
- Chisti, Y., 2007. Biodiesel from microalgae. *Biotechnol. Adv.* 25, 294–306.
- Chisti, Y., 2008. Biodiesel from microalgae beats bioethanol. *Trends Biotechnol.* 26, 126–131.
- Chochois, V., Dauvillee, D., Beyly, A., Tolleter, D., Cuine, S., et al., 2009. Hydrogen production in *Chlamydomonas*: photosystem II-dependent and -independent pathways differ in their requirement for starch metabolism. *Plant Physiol.* 151, 631–640.
- Chochois, V., Constans, L., Dauvillee, D., Beyly, A., Soliveres, M., et al., 2010. Relationships between PSII-independent hydrogen bioproduction and starch metabolism as evidenced from isolation of starch catabolism mutants in the green alga *Chlamydomonas reinhardtii*. *Int. J. Hydrogen Energy.* 35, 10731–10740.
- Converti, A., Casazza, A.A., Ortiz, E.Y., Perego, P., Del Borghi, M., 2009. Effect of temperature and nitrogen concentration on the growth and lipid content of *Nannochloropsis oculata* and *Chlorella vulgaris* for biodiesel production. *Chemical Engineering and Processing* 48, 1146–1151.
- Dahlqvist, A., Stahl, U., Lenman, M., Banas, A., Lee, M., et al., 2000. Phospholipid:diacylglycerol acyltransferase: an enzyme that catalyzes the acyl-CoA-independent formation of triacylglycerol in yeast and plants. *Proc. Natl. Acad. Sci. U. S. A.* 97, 6487–6492.
- Desplats, C., Mus, F., Cuine, S., Billon, E., Cournac, L., Peltier, G., 2009. Characterization of Nda2, a plastoquinone-reducing type II NAD(P)H dehydrogenase in *chlamydomonas* chloroplasts. *J. Biol. Chem.* 284, 4148–4157.
- Dismukes, G.C., Carrieri, D., Bennette, N., Ananyev, G.M., Posewitz, M.C., 2008. Aquatic phototrophs: efficient alternatives to land-based crops for biofuels. *Curr. Opin. Biotechnol.* 19, 235–240.
- Doebbe, A., Rupprecht, J., Beckmann, J., Mussgnug, J.H., Hallmann, A., et al., 2007. Functional integration of the HUP1 hexose symporter gene into the genome of *C. reinhardtii*: Impacts on biological H₂ production. *J. Biotechnol.* 131, 27–33.
- Durrett, T.P., Benning, C., Ohlrogge, J., 2008. Plant triacylglycerols as feedstocks for the production of biofuels. *Plant J.* 54, 593–607.
- Eroglu, E., Melis, A., 2011. Photobiological hydrogen production: Recent advances and state of the art. *Bioresour. Technol.* 102, 8403–8413.
- Fan, J., Andre, C., Xu, C., 2011. A chloroplast pathway for the de novo biosynthesis of triacylglycerol in *Chlamydomonas reinhardtii*. *FEBS Lett.* 585, 1985–1991.
- Faraloni, C., Torzillo, G., 2010. Phenotypic characterization and hydrogen production in *Chlamydomonas reinhardtii* Qb-binding D1-protein mutants under sulfur starvation: changes in Chl fluorescence and pigment composition. *J. Phycol.* 46, 788–799.
- Fedorov, A.S., Kosourov, S., Ghirardi, M.L., Seibert, M., 2005. Continuous hydrogen photoproduction by *Chlamydomonas reinhardtii*: using a novel two-stage, sulfate-limited chemostat system. *Appl. Biochem. Biotechnol.* 121–124, 403–412.
- Florin, L., Tsokoglou, A., Happe, T., 2001. A novel type of iron hydrogenase in the green alga *Scenedesmus obliquus* is linked to the photosynthetic electron transport chain. *J. Biol. Chem.* 276, 6125–6132.
- Flynn, T., Ghirardi, M.L., Seibert, M., 2002. Accumulation of O₂-tolerant phenotypes in H₂-producing strains of *Chlamydomonas reinhardtii* by sequential applications of chemical mutagenesis and selection. *International Journal of Hydrogen Energy* 27, 1421–1430.
- Forestier, M., Zhang, L., King, P., Plummer, S., Ahmann, D., et al., 2001. The cloning of two hydrogenase genes from the green alga *Chlamydomonas reinhardtii*. In *Proceedings of the 12th International Congress on Photosynthesis* (Melbourne, Australia: CSIRO Publishing).
- Forestier, M., King, P., Zhang, L., Posewitz, M., Schwarzer, S., et al., 2003. Expression of two [Fe]-hydrogenases in *Chlamydomonas reinhardtii* under anaerobic conditions. *Eur. J. Biochem.* 270, 2750–2758.
- Gaffron, H., Rubin, J., 1942. Fermentative and Photochemical Production of Hydrogen in Algae. *J. Gen. Physiol.* 26, 219–240.
- Georgianna, D.R., Mayfield, S.P., 2012. Exploiting diversity and synthetic biology for the production of algal biofuels. *Nature* 488, 329–335.

- Ghirardi, M.L., Posewitz, M.C., Maness, P.C., Dubini, A., Yu, J., Seibert, M., 2007. Hydrogenases and hydrogen photoproduction in oxygenic photosynthetic organisms. *Annu. Rev. Plant Biol.* 58, 71–91.
- Ghirardi, M.L., Dubini, A., Yu, J., Maness, P.C., 2009. Photobiological hydrogen-producing systems. *Chem. Soc. Rev.* 38, 52–61.
- Goodson, C., Roth, R., Wang, Z.T., Goodenough, U., 2011. Structural Correlates of Cytoplasmic and Chloroplast Lipid Body Synthesis in *Chlamydomonas reinhardtii* and Stimulation of Lipid Body Production with Acetate Boost. *Eukaryot. Cell* 10, 1592–1606.
- Hahn, J.J., Ghirardi, M.L., Jacoby, W.A., 2007. Immobilized algal cells used for hydrogen production. *Biochemical Engineering Journal* 37, 75–79.
- Happe, T., Kaminski, A., 2002. Differential regulation of the Fe-hydrogenase during anaerobic adaptation in the green alga *Chlamydomonas reinhardtii*. *Eur. J. Biochem.* 269, 1022–1032.
- Hemschemeier, A., Fouchard, S., Courmac, L., Peltier, G., Happe, T., 2008. Hydrogen production by *Chlamydomonas reinhardtii*: an elaborate interplay of electron sources and sinks. *Planta* 227, 397–407.
- Hu, Q., Sommerfeld, M., Jarvis, E., Ghirardi, M., Posewitz, M., et al., 2008. Microalgal triacylglycerols as feedstocks for biofuel production: perspectives and advances. *Plant J.* 54, 621–639.
- Huo, Y.X., Cho, K.M., Rivera, J.G., Monte, E., Shen, C.R., et al., 2011. Conversion of proteins into biofuels by engineering nitrogen flux. *Nat. Biotechnol.* 29, 346–351.
- Jacobs, J., Pudollek, S., Hemschemeier, A., Happe, T., 2009. A novel, anaerobically induced ferredoxin in *Chlamydomonas reinhardtii*. *FEBS Lett.* 583, 325–329.
- Jans, F., Mignolet, E., Houyoux, P.A., Cardol, P., Ghysels, B., et al., 2008. A type II NAD(P)H dehydrogenase mediates light-independent plastoquinone reduction in the chloroplast of *Chlamydomonas*. *Proc. Natl. Acad. Sci. U. S. A.* 105, 20546–20551.
- Jo, J.H., Lee, D.S., Park, J.M., 2006. Modeling and optimization of photosynthetic hydrogen gas production by green alga *Chlamydomonas reinhardtii* in sulfur-deprived circumstance. *Biotechnol. Prog.* 22, 431–437.
- Kamp, C., Silakov, A., Winkler, M., Reijerse, E.J., Lubitz, W., Happe, T., 2008. Isolation and first EPR characterization of the [FeFe]-hydrogenases from green algae. *Biochim. Biophys. Acta* 1777, 410–416.
- Kilian, O., Benemann, C.S., Niyogi, K.K., Vick, B., 2011. High-efficiency homologous recombination in the oil-producing alga *Nannochloropsis* sp. *Proc. Natl. Acad. Sci. U. S. A.*
- Kosourov, S.N., Seibert, M., 2009. Hydrogen photoproduction by nutrient-deprived *Chlamydomonas reinhardtii* cells immobilized within thin alginate films under aerobic and anaerobic conditions. *Biotechnol. Bioeng.* 102, 50–58.
- Kosourov, S., Tsygankov, A., Seibert, M., Ghirardi, M.L., 2002. Sustained hydrogen photoproduction by *Chlamydomonas reinhardtii*: Effects of culture parameters. *Biotechnol. Bioeng.* 78, 731–740.
- Kosourov, S., Seibert, M., Ghirardi, M.L., 2003. Effects of extracellular pH on the metabolic pathways in sulfur-deprived, H₂-producing *Chlamydomonas reinhardtii* cultures. *Plant Cell Physiol.* 44, 146–155.
- Kosourov, S., Patrusheva, E., Ghirardi, M.L., Seibert, M., Tsygankov, A., 2007. A comparison of hydrogen photoproduction by sulfur-deprived *Chlamydomonas reinhardtii* under different growth conditions. *J. Biotechnol.* 128, 776–787.
- Kruse, O., Nixon, P.J., Schmid, G.H., Mullineux, C.W., 1999. Isolation of state transition mutants of *Chlamydomonas reinhardtii* by fluorescence video imaging. *Photosynth. Res.* 61, 43–51.
- Kruse, O., Rupprecht, J., Bader, K.P., Thomas-Hall, S., Schenk, P.M., et al., 2005. Improved photobiological H₂ production in engineered green algal cells. *J. Biol. Chem.* 280, 34170–34177.
- La Russa, M., Bogen, C., Uhmeyer, A., Doebbe, A., Filippone, E., et al., 2012. Functional analysis of three type-2 DGAT homologue genes for triacylglycerol production in the green microalga *Chlamydomonas reinhardtii*. *J. Biotechnol.*
- Lardon, L., Helias, A., Sialve, B., Steyer, J.P., Bernard, O., 2009. Life-cycle assessment of biodiesel production from microalgae. *Environ. Sci. Technol.* 43, 6475–6481.
- Laurinavichene, T., Tolstygina, I., Tsygankov, A., 2004. The effect of light intensity on hydrogen production by sulfur-deprived *Chlamydomonas reinhardtii*. *J. Biotechnol.* 114, 143–151.
- Laurinavichene, T.V., Fedorov, A.S., Ghirardi, M.L., Seibert, M., Tsygankov, A.A., 2006. Demonstration of sustained hydrogen photoproduction by immobilized, sulfur-deprived *Chlamydomonas reinhardtii* cells. *International Journal of Hydrogen Energy* 31, 659–667.
- Lee, J.W., Mets, L., Greenbau, E., 2002. Improvement of photosynthetic CO₂ fixation at high light intensity through reduction of chlorophyll antenna size. *Appl. Biochem. Biotechnol.* 98–100, 37–48.
- Lemaire, S.D., Guillon, B., Le Marechal, P., Keryer, E., Miginiac-Maslow, M., Decottignies, P., 2004. New thioredoxin targets in the unicellular photosynthetic eukaryote *Chlamydomonas reinhardtii*. *Proc. Natl. Acad. Sci. U. S. A.* 101, 7475–7480.

- Leon, R., Fernandez, E., 2007. Nuclear transformation of eukaryotic microalgae: historical overview, achievements and problems. *Adv. Exp. Med. Biol.* 616, 1–11.
- Li, Y., Horsman, M., Wang, B., Wu, N., Lan, C.Q., 2008. Effects of nitrogen sources on cell growth and lipid accumulation of green alga *Neochloris oleoabundans*. *Appl. Microbiol. Biotechnol.* 81, 629–636.
- Liu, Z.Y., Wang, G.C., Zhou, B.C., 2008. Effect of iron on growth and lipid accumulation in *Chlorella vulgaris*. *Bioresour. Technol.* 99, 4717–4722.
- Long, H., Chang, C.H., King, P.W., Ghirardi, M.L., Kim, K., 2008. Brownian dynamics and molecular dynamics study of the association between hydrogenase and ferredoxin from *Chlamydomonas reinhardtii*. *Biophys. J.* 95, 3753–3766.
- Ma, W., Chen, M., Wang, L., Wei, L., Wang, Q., 2011. Treatment with NaHSO₃ greatly enhances photobiological H₂ production in the green alga *Chlamydomonas reinhardtii*. *Bioresour. Technol.* 102, 8635–8638.
- Martin, N.C., Chiang, K.S., Goodenough, U.W., 1976. Turnover of chloroplast and cytoplasmic ribosomes during gametogenesis in *Chlamydomonas reinhardtii*. *Dev. Biol.* 51, 190–201.
- Melis, A., 1999. Photosystem-II damage and repair cycle in chloroplasts: what modulates the rate of photodamage? *Trends Plant Sci.* 4, 130–135.
- Melis, A., 2009. Solar energy conversion efficiencies in photosynthesis: Minimizing the chlorophyll antennae to maximize efficiency. *Plant Sci.* 177, 272–280.
- Melis, A., Melnicki, M.R., 2006. Integrated biological hydrogen production. *International Journal of Hydrogen Energy* 31, 1563–1573.
- Melis, A., Neidhardt, J., Benemann, J., 1999. *Dunaliella salina* (Chlorophyta) with small chlorophyll antenna sizes exhibit higher photosynthetic productivities and photon use efficiencies than normally pigmented cells. *J. Appl. Phycol.* 10, 515–525.
- Melis, A., Zhang, L., Forestier, M., Ghirardi, M.L., Seibert, M., 2000. Sustained photobiological hydrogen gas production upon reversible inactivation of oxygen evolution in the green alga *Chlamydomonas reinhardtii*. *Plant Physiol.* 122, 127–136.
- Melis, A., Seibert, M., Ghirardi, M.L., 2007. Hydrogen fuel production by transgenic microalgae. *Adv. Exp. Med. Biol.* 616, 110–121.
- Merchant, S.S., Prochnik, S.E., Vallon, O., Harris, E.H., Karpowicz, S.J., et al., 2007. The *Chlamydomonas* genome reveals the evolution of key animal and plant functions. *Science* 318, 245–250.
- Miller, R., Wu, G., Deshpande, R.R., Vieler, A., Gartner, K., et al., 2010. Changes in transcript abundance in *Chlamydomonas reinhardtii* following nitrogen deprivation predict diversion of metabolism. *Plant Physiol.* 154, 1737–1752.
- Moellering, E.R., Benning, C., 2010. RNA interference silencing of a major lipid droplet protein affects lipid droplet size in *Chlamydomonas reinhardtii*. *Eukaryot. Cell* 9, 97–106.
- Msanne, J., Xu, D., Konda, A.R., Casas-Mollano, J.A., Awada, T., et al., 2012. Metabolic and gene expression changes triggered by nitrogen deprivation in the photoautotrophically grown microalgae *Chlamydomonas reinhardtii* and *Coccomyxa* sp. C-169. *Phytochemistry*.
- Mus, F., Dubini, A., Seibert, M., Posewitz, M.C., Grossman, A.R., 2007. Anaerobic acclimation in *Chlamydomonas reinhardtii*: anoxic gene expression, hydrogenase induction, and metabolic pathways. *J. Biol. Chem.* 282, 25475–25486.
- Mussgnug, J.H., Thomas-Hall, S., Rupprecht, J., Foo, A., Klassen, V., et al., 2007. Engineering photosynthetic light capture: impacts on improved solar energy to biomass conversion. *Plant Biotechnol. J.* 5, 802–814.
- Nagy, L.E., Meuser, J.E., Plummer, S., Seibert, M., Ghirardi, M.L., et al., 2007. Application of gene-shuffling for the rapid generation of novel [FeFe]-hydrogenase libraries. *Biotechnol. Lett.* 29, 421–430.
- Nguyen, H.M., Baudet, M., Cuine, S., Adriano, J.M., Barthe, D., et al., 2011. Proteomic profiling of oil bodies isolated from the unicellular green microalga *Chlamydomonas reinhardtii*: with focus on proteins involved in lipid metabolism. *Proteomics* 11, 4266–4273.
- Oelkers, P., Cromley, D., Padamsee, M., Billheimer, J.T., Sturley, S.L., 2002. The DGA1 gene determines a second triglyceride synthetic pathway in yeast. *J. Biol. Chem.* 277, 8877–8881.
- Ohlrogge, J., Browse, J., 1995. Lipid biosynthesis. *Plant Cell* 7, 957–970.
- Polle, J.E., Benemann, J.R., Tanaka, A., Melis, A., 2000. Photosynthetic apparatus organization and function in the wild type and a chlorophyll b-less mutant of *Chlamydomonas reinhardtii*. Dependence on carbon source. *Planta* 211, 335–344.
- Polle, J.E., Kanakagiri, S.D., Melis, A., 2003. *tla1*, a DNA insertional transformant of the green alga *Chlamydomonas reinhardtii* with a truncated light-harvesting chlorophyll antenna size. *Planta* 217, 49–59.

- Post-Beittenmiller, D., Roughan, G., Ohlrogge, J.B., 1992. Regulation of plant Fatty Acid biosynthesis: analysis of acyl-coenzyme a and acyl-acyl carrier protein substrate pools in spinach and pea chloroplasts. *Plant Physiol.* 100, 923–930.
- Ras, M., Lardon, L., Bruno, S., Bernet, N., Steyer, J.P., 2011. Experimental study on a coupled process of production and anaerobic digestion of *Chlorella vulgaris*. *Bioresour. Technol.* 102, 200–206.
- Reijnders, L., 2008. Do biofuels from microalgae beat biofuels from terrestrial plants? *Trends Biotechnol.* 26, 349–350; author reply 51–2.
- Riekhof, W.R., Sears, B.B., Benning, C., 2005. Annotation of genes involved in glycerolipid biosynthesis in *Chlamydomonas reinhardtii*: discovery of the betaine lipid synthase BTA1Cr. *Eukaryot. Cell* 4, 242–252.
- Rochaix, J.D., 2011. Regulation of photosynthetic electron transport. *Biochim. Biophys. Acta* 1807, 375–383.
- Ruhle, T., Hemschemeier, A., Melis, A., Happe, T., 2008. A novel screening protocol for the isolation of hydrogen producing *Chlamydomonas reinhardtii* strains. *BMC Plant Biol.* 8, 107.
- Schiedlmeier, B., Schmitt, R., Muller, W., Kirk, M.M., Gruber, H., et al., 1994. Nuclear transformation of *Volvox carteri*. *Proc. Natl. Acad. Sci. U. S. A.* 91, 5080–5084.
- Schonfeld, C., Wobbe, L., Borgstadt, R., Kienast, A., Nixon, P.J., Kruse, O., 2004. The nucleus-encoded protein MOC1 is essential for mitochondrial light acclimation in *Chlamydomonas reinhardtii*. *J. Biol. Chem.* 279, 50366–50374.
- Schroda, M., 2006. RNA silencing in *Chlamydomonas*: mechanisms and tools. *Curr. Genet.* 49, 69–84.
- Sheehan, J., Dunahay, T., Benemann, J., Roessler, P., 1998. A Look Back at the U.S. Department of Energy's Aquatic Species Program—Biodiesel from Algae, Close Out Report TP-580–24190. US Department of Energy's Office of Fuels Development, Golden, CO.
- Shen, B., Allen, W.B., Zheng, P., Li, C., Glassman, K., et al., 2010. Expression of ZmLEC1 and ZmWRI1 increases seed oil production in maize. *Plant Physiol.* 153, 980–987.
- Siaut, M., Heijde, M., Mangogna, M., Montsant, A., Coesel, S., et al., 2007. Molecular toolbox for studying diatom biology in *Phaeodactylum tricornutum*. *Gene* 406, 23–35.
- Stern, D.B., Harris, E.H. (Eds.), 2009. *The Chlamydomonas Sourcebook*, second ed. Organellar and Metabolic Processes, vol. 2. Elsevier Ltd, p. 1071.
- Stripp, S., Sanganas, O., Happe, T., Haumann, M., 2009a. The structure of the active site H-cluster of [FeFe] hydrogenase from the green alga *Chlamydomonas reinhardtii* studied by X-ray absorption spectroscopy. *Biochemistry* 48, 5042–5049.
- Stripp, S.T., Goldet, G., Brandmayr, C., Sanganas, O., Vincent, K.A., et al., 2009b. How oxygen attacks [FeFe] hydrogenases from photosynthetic organisms. *Proc. Natl. Acad. Sci. U. S. A.* 106, 17331–17336.
- Surzycki, R., Cournac, L., Peltier, G., Rochaix, J.D., 2007. Potential for hydrogen production with inducible chloroplast gene expression in *Chlamydomonas*. *Proc. Natl. Acad. Sci. U. S. A.* 104, 17548–17553.
- Thelen, J.J., Ohlrogge, J.B., 2002. Metabolic engineering of fatty acid biosynthesis in plants. *Metab. Eng.* 4, 12–21.
- Tolleter, D., Ghysels, B., Alric, J., Petroutsos, D., Tolstygina, I., et al., 2011. Control of Hydrogen Photoproduction by the Proton Gradient Generated by Cyclic Electron Flow in *Chlamydomonas reinhardtii*. *Plant Cell* .
- Torzillo, G., Scoma, A., Faraloni, C., Ena, A., Johanningmeier, U., 2009. Increased hydrogen photoproduction by means of a sulfur-deprived *Chlamydomonas reinhardtii* D1 protein mutant. *International Journal of Hydrogen Energy* 34, 4529–4536.
- Tsygankov, A., Kosourov, S., Seibert, M., Ghirardi, M.L., 2002. Hydrogen photoproduction under continuous illumination by sulfur-deprived, synchronous *Chlamydomonas reinhardtii* cultures. *International Journal of Hydrogen Energy* 27, 1239–1244.
- White, S.W., Zheng, J., Zhang, Y.M., Rock, 2005. The structural biology of type II fatty acid biosynthesis. *Annu. Rev. Biochem* 74, 791–831.
- Wijffels, R.H., Barbosa, M.J., 2010. An outlook on microalgal biofuels. *Science* 329, 796–799.
- Wijffels, R.H., Barbosa, M.J., Eppink, M.H.M., 2010. Microalgae for the production of bulk chemicals and biofuels. *Biofuel. Bioprod. Bior.* 4, 287–295.
- Winkler, M., Heil, B., Heil, B., Happe, T., 2002. Isolation and molecular characterization of the [Fe]-hydrogenase from the unicellular green alga *Chlorella fusca*. *Biochim. Biophys. Acta* 1576, 330–334.
- Winkler, M., Kuhlert, S., Hippler, M., Happe, T., 2009. Characterization of the key step for light-driven hydrogen evolution in green algae. *J. Biol. Chem.* 284, 36620–36627.
- Winkler, M., Hemschemeier, A., Jacobs, J., Stripp, S., Happe, T., 2010. Multiple ferredoxin isoforms in *Chlamydomonas reinhardtii* - their role under stress conditions and biotechnological implications. *Eur. J. Cell Biol.* 89, 998–1004.

- Work, V.H., D'Adamo, S., Radakovits, R., Jinkerson, R.E., Posewitz, M.C., 2012. Improving photosynthesis and metabolic networks for the competitive production of phototroph-derived biofuels. *Curr. Opin. Biotechnol.* 23, 290–297.
- Wykoff, D.D., Davies, J.P., Melis, A., Grossman, A.R., 1998. The regulation of photosynthetic electron transport during nutrient deprivation in *Chlamydomonas reinhardtii*. *Plant Physiol.* 117, 129–139.
- Xu, H., Miao, X., Wu, Q., 2006. High quality biodiesel production from a microalga *Chlorella protothecoides* by heterotrophic growth in fermenters. *J. Biotechnol.* 126, 499–507.
- Yohn, C., Mendez, M., Behnke, C., Brand, A., 2011. Stress-induced lipid trigger. *USA patent*. USPTO Application : 20120322157.
- Zamalloa, C., Boon, N., Verstraete, W., 2012. Anaerobic digestibility of *Scenedesmus obliquus* and *Phaeodactylum tricornutum* under mesophilic and thermophilic conditions. *Appl. Energ.* 92, 733–738.
- Zhang, L., Melis, A., 2002. Probing green algal hydrogen production. *Philos. Trans. R. Soc. Lond. B Biol. Sci.* 357, 1499–1507; discussion 507–11.
- Zhang, L., Happe, T., Melis, A., 2002. Biochemical and morphological characterization of sulfur-deprived and H₂-producing *Chlamydomonas reinhardtii* (green alga). *Planta* 214, 552–561.

Intentionally left as blank

Respirometric Balance and Carbon Fixation of Industrially Important Algae

Eduardo Bittencourt Sydney, Alessandra Cristine Novak, Julio Cesar de Carvalho, Carlos Ricardo Soccol

Biotechnology Division, Federal University of Parana, Curitiba, Brazil

4.1 INTRODUCTION

The Framework Convention on Climate Change, signed in Rio de Janeiro in 1992, made global warming a major focus, and the development of technologies for reducing/absorbing greenhouse gases (GhG) gained importance. After another 20 years, at Rio+20, the final document stated clear concern about emissions and the need to reduce them by 2020.

[Rubin et al. \(1992\)](#) divided the GhG reduction alternatives into three groups: conservation, direct mitigation, and indirect mitigation. Conservation measures reduce electricity consumption and thus GhG emissions; direct mitigation techniques capture and remove CO₂ emitted by specific sources; and indirect mitigation involves offsetting actions in which GhG producers support reductions in GhG emission.

The concept behind most disposal methods is to offset the immediate effect on the levels of carbon dioxide in the atmosphere by relocation, i.e., by injection into either geologic or oceanic sinks ([Stewart and Hessami, 2005](#)). Relocation in ocean and deep saline formations has the capacity for 10¹² tons of CO₂, whereas global carbon dioxide emissions in 2009 were 33 × 10⁶ tons ([Olivier et al., 2011](#)), which means 30,000 years of relocation. Problems related to this issue are the unknown possible environmental problems (such as acidification, for example), costs, and the necessity to concentrate CO₂ before relocation (how will it work to transport CO₂ emissions, for example?).

Therefore, long-term mitigation technologies for CO₂ and other GhG gas removal came to be developed. They can be generally classified into two categories: (1) chemical reaction-based technologies and (2) biological CO₂ mitigation.

Chemical reaction-based CO₂ mitigation approaches are energy-consuming and costly processes (Lin et al., 2003), and the only economical incentive for CO₂ mitigation using the chemical reaction-based approach is the CO₂ credits to be generated under the Kyoto Protocol (Wang et al., 2008). For example, CO₂ can be instantly absorbed through bubbling it in a hydroxide solution at 40°Celsius, producing sodium or ammonium bicarbonate. However, the demand for these salts (although high—equivalent to around 14Gt/year) is supplied by the Solvay process, whereas a CO₂ process would require previous synthesis of sodium hydroxide.

Biological CO₂ mitigation has attracted a good deal attention as a strategic alternative. Microalgae cultivation gained importance because it associates CO₂ mitigation and production of a wide range of commercial bioproducts.

Despite the fact that the existence of microalgae has been known for a long time, studies for its use as industrial microorganisms are relatively recent. Initial studies of microalgae cultivation began in the late 1940s and early 1950s for its potential as a source of food. Concerns about water pollution in the 1960s increased interest in the use of microalgae in wastewater treatment. The perception in the 1970s that fossil fuels would run out made these microorganisms a focus of renewable fuel production. In the 1980s microalgae were used as a source of value-added products, specifically nutraceuticals. In the late 1980s the low cost of oil caused a loss of interest in microalgae-based energy, whereas research with nutraceuticals and biomass for feed continued. In the 2000s, global warming concerns associated with high oil prices made microalgal bioenergy projects popular again.

To create microalgal products, it is necessary to develop mass-cultivation techniques and to understand the physiological characteristics of each strain. There have been extensive studies on process optimization (media and physicochemical parameter optimization, screening and isolation of high CO₂ tolerants, search for new valuable products, optimization and development of new vessels and systems for cultivation, for example) to try to overcome the economic issues faced in industrial-scale production of microalgae. Two other aspects are gaining importance: the use of industrial residues (to reduce media costs) and the carbon market (carbon credits as an additional element in the economic evaluation of the process).

The evaluation of nutrient needs in microalgal cultures is an important tool in process development using residues (domestic or industrial), and the quantification of carbon dioxide fixation is of great industrial interest since carbon credits can be traded on the international market and companies may use the process as a marketing strategy.

The rate of carbon uptake is limited by the metabolic activity of microalgae, which is in turn limited by photosynthesis. The ability to identify rates of consumption of nutrients is thus of considerable importance to the understanding of the metabolism of microalgae and to avoid problems in industrial cultivation of such microorganisms.

4.1.1 Microalgal Metabolism

Microalgae are a very heterogeneous group of microorganisms. The term *microalgae* includes prokaryotes and eukaryotes. Cyanobacteria (blue-green algae) are frequently unicellular, with some species forming filaments or aggregates. The internal organization of a

cyanobacterial cell is prokaryotic, where a central region (nucleoplasm) is rich in DNA and a peripheral region (chromoplast) contains photosynthetic membranes. The sheets of the photosynthetic membranes are usually arranged in parallel, close to the cell surface. Eukaryotic autotrophic microorganisms are usually divided according to their light-harvesting photosynthetic pigments: Rhodophyta (red algae), Chrysophyceae (golden algae), Phaeophyceae (brown algae), and Chlorophyta (green algae). Their photosynthetic apparatus are organized in special organelles, the chloroplasts, which contain alternating layers of lipoprotein membranes (thylakoids) and aqueous phases (Staehelein, 1986).

All photosynthetic organisms contain organic pigments for harvesting light energy. There are three major classes of pigments: chlorophylls (Chl), carotenoids, and phycobilins. The chlorophylls (green pigments) and carotenoids (yellow or orange pigments) are lipophilic and associated in Chl-protein complexes, while phycobilins are hydrophilic. Chlorophyll molecules consist of a tetrapyrrole ring (polar head, chromophore) containing a central magnesium atom and a long-chain terpenoid alcohol. Structurally, the various types of Chl molecules, designated *a*, *b*, *c*, and *d*, differ in their side-group substituent on the tetrapyrrole ring. All Chl have two major absorption bands: blue or blue-green (450–475 nm) and red (630–675 nm) (Niklas Engstrom, 2012). Chl *a* is present in all oxygenic photoautotrophs.

Photoautotrophic cultures seldom reach very high cell densities; they are more than an order of magnitude less productive than many heterotrophic microbial cultures, the reason that microalgal cultures are carried in very large volumes. However, the microalgal photosynthetic mechanism is simpler than that of higher plants, providing more efficient solar energy conversion. This makes microalgae the most important carbon-fixative group and oxygen producer on the planet. Microalgae cultures have some advantages over vascular plants (Benemann and Oswald, 1996): All physiological functions are carried out in a single cell, they do not differentiate into specialized cells, and they multiply much faster.

4.1.2 Photosynthesis

Photosynthesis can be defined as a redox reaction driven by light energy, in which carbon dioxide and water are converted into metabolites and oxygen. Photosynthesis is traditionally divided into two stages, the so-called *light reactions* and the *dark reactions*. The first process is the *light-dependent process (light reaction)*, which occurs in the grana and requires the direct energy of light to make energy carrier molecules that are used in the second process. The *light-independent process (or dark reaction)* occurs in the stroma of the chloroplasts, where the products accumulated in the products of the light reaction are used to form C-C covalent bonds of carbohydrates. The dark reactions can usually occur if the energy carriers from the light process are present.

In the light reactions, light strikes chlorophyll *a* in such a way as to excite electrons to a higher energy state. In a series of reactions, the energy is converted (along an electron transport process) into ATP and NADPH. Water is split in the process, releasing oxygen as a byproduct of the reaction. The ATP and NADPH are used to make C-C bonds in the dark reactions.

In the dark reactions, carbon dioxide from the atmosphere (or water for aquatic and marine organisms) is captured and reduced by the addition of hydrogen to form carbohydrates ($[\text{CH}_2\text{O}]_n$). The incorporation of carbon dioxide into organic compounds is known as *carbon fixation*. The energy comes from the first phase of the photosynthetic process. Living systems

cannot directly utilize light energy, but they can, through a complicated series of reactions, convert it into C-C bond energy that can be released by glycolysis and other metabolic processes. So, the main role of the light reactions is to provide the biochemical reducing agent NADPH_2 and the chemical energy carrier (ATP) for the assimilation of inorganic carbon, as presented in Equation 4.1:



The fixation of carbon dioxide happens in the dark (in the stroma of chloroplasts) using the NADPH_2 and ATP produced in the light reaction of photosynthesis (Equation 4.2):

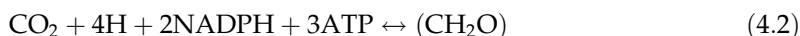

Carbon dioxide is available in water in three different forms: CO_2 , bicarbonate (HCO_3^-), or carbonate (HCO_3^{2-}) (Figure 4.1), the relative amounts of which are pH dependent. Although plants and algae are known to be dependent exclusively on the Calvin-Benson-Bassham cycle (also known as the *Calvin cycle*) (Atomi, 2002), six autotrophic carbon-fixation pathways are known. These are (1) the Calvin cycle, (2) the acetyl-CoA pathway, (3) the 3-hydroxypropionate cycle, (4) the reverse tricarboxylic acid cycle, (5) **3-Hydroxypropionate/4-hydroxybutyrate cycle**, and (6) **Dicarboxylate/4-hydroxybutyrate cycle** (GeorgeFuchs, 2011). This section discusses the Calvin cycle, which is the most important in microalgae.

In the Calvin cycle there is only one enzyme responsible for CO_2 fixation: ribulose 1,5-biphosphate carboxylase/oxygenase, also known as *Rubisco*. Figure 4.2 shows the Calvin

$\text{CO}_2(\text{g}) \leftrightarrow \text{CO}_2(\text{aq}) \leftrightarrow \text{H}_2\text{CO}_3 \leftrightarrow \text{HCO}_3^- \leftrightarrow \text{CO}_3^{2-}$ **FIGURE 4.1** Different forms in which carbon dioxide is available in water.

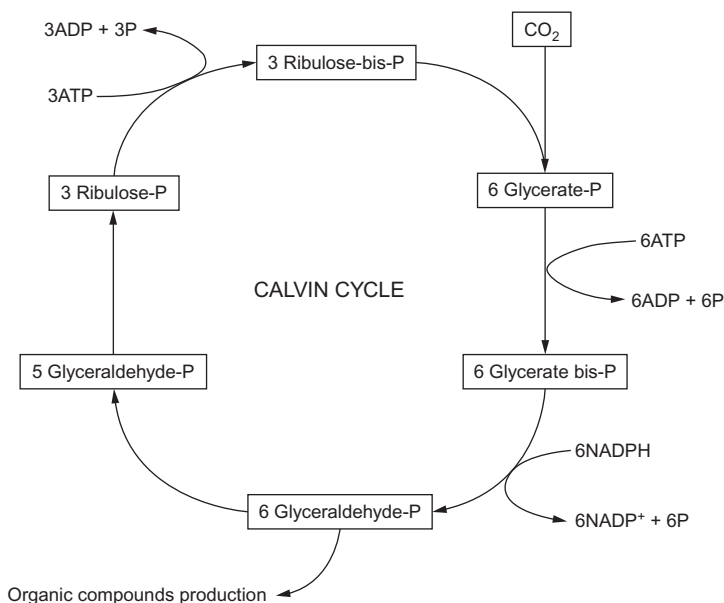
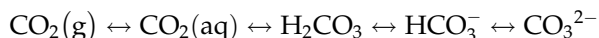

FIGURE 4.2 The dark process of CO_2 capture and transformation through metabolism of photosynthetic microalgae (modified from Masojidek et al., 2004).

cycle, where one molecule of ribulose 1,5-biphosphate and a CO_2 are converted into two glycerate phosphate. CO_2 diffuses through the cell and is captured by the enzyme ribulose biphosphate (Rubisco).



The fixation of CO_2 occurs in four distinct phases (Masojćdek et al., 2004):

1. *Carboxylation*. A reaction whereby CO_2 is added to the five carbon sugar ribulose biphosphate (Ribulose-bis-P) to form two molecules of phosphoglycerate (Glycerate-P). This reaction is catalyzed by the enzyme ribulose biphosphate carboxylase/oxygenase (Rubisco).
2. *Reduction*. To convert Glycerate-P into 3-carbon sugars (Triose-P), energy must be added in the form of ATP and NADPH_2 in two steps, which are the phosphorylation of Glycerate-P to form diphosphoglycerate (Glycerate-bis-P) and the reduction of Glycerate-bis-P to phosphoglyceraldehyde (Glyceraldehyde-P) by NADPH_2 .
3. *Regeneration*. Ribulose-P is regenerated for further CO_2 fixation in a complex series of reactions combining 3-, 4-, 5-, 6-, and 7-carbon sugar phosphates, which are not explicitly shown in the diagram.
4. *Production*. The primary end products of photosynthesis are considered to be carbohydrates, fatty acids, amino acids, and organic acids.

Besides the carboxylase activity described here, all Rubiscos (there is more than one type) are known to display an additional oxygenase activity in which an oxygen molecule, competing with CO_2 for the enzyme-bound eno-diolate of RuBP, reacts with RuBP to form 3-phosphoglycerate and phosphoglycolate (Atomi, 2002). The latter product is subsequently oxidatively metabolized via photorespiration, leading to a net loss in carbon dioxide fixation. Photorespiration thus represents a competing process to carbon fixation, where the organic carbon is converted into CO_2 without any metabolic gain. Photorespiration depends on the relative concentrations of oxygen and CO_2 where a high O_2/CO_2 ratio stimulates this process, whereas a low O_2/CO_2 ratio favors carboxylation. Rubisco has low affinity by CO_2 ; its K_m (half saturation) is approximately equal to the level of CO_2 in air. Thus, under high irradiance, high oxygen level, and reduced CO_2 , the reaction equilibrium is shifted toward photorespiration. For optimal yields in microalgal mass cultures, it is necessary to minimize the effects of photorespiration, achieved by an effective stripping of oxygen and by CO_2 enrichment. For this reason, microalgal mass cultures are typically grown at a much higher CO_2/O_2 ratio than that found in air, which is in turn an opportunity to reuse industrial gas emissions.

The source of nitrogen in cultivation of microalgae seems to cause changes in oxygen production during photosynthesis. The ratio between O_2 evolution rate and CO_2 uptake rate (the photosynthetic quotient, PQ) depends on the composition of the produced biomass and the substrates that are used. Especially oxidized nitrogen sources, which must be reduced before they are incorporated into the biomass, affect the PQ. When nitrate is used, it is expected at an evolution of 1.3 mol O_2 per mol of CO_2 assimilated, whereas nitrite promotes a release of 1.2 mol O_2 and ammonia 1.0 mol O_2 (Eriksen et al., 2007). Approximately 20% of O_2 evolution equivalents can be accounted for by NO_3^- uptake and assimilation under N-replete conditions (Turpin, 1991).

4.1.3 Microalgae Culture Fundamentals

Studies on microalgae are preferably done under controlled conditions. Microalgae bioreactors are often designed differently from bioreactors used to grow other microorganisms. Two parameters are the most important in algae cultivation: efficiency of light utilization and availability of dissolved CO₂.

Like any organism, microalgae have nutritional requirements: carbon sources, energy, water, and inorganic nutrients. In the case of microalgae, the carbon source can be CO₂ and the energy comes from sunlight. As microalgae grow in aqueous suspension, the manipulation and control of culture conditions makes their cultivation feasible, thus the productivity is limited mostly by the available of light. Responses by algal cells to nutrients and cultivation environments can be used to manipulate the processes to favor the production of algal biomass (Benemann et al., 2002).

The development of media for microalgae cultivation involves a sufficient carbon source (carbon is a part of all the organic molecules in the cell, making up as much as 50% of the algal biomass); salt concentration (depending on the original biotope of the alga); nitrogen (represents about 5–10% of microalgae dry weight); phosphorus (part of DNA, RNA, ATP, cell membrane); sulfur (constituent of amino acids, vitamins, sulfolipids and is involved in protein biosynthesis); potassium (cofactor for several enzymes and involved in protein synthesis and osmotic regulation); magnesium (the central atom of the chlorophyll molecule); iron (constituent of cytochromes and important in nitrogen assimilation); pH of the medium; temperature; trace elements, and addition of organic compounds and growth promoters.

Carbon is important because it is the source of energy for many cellular events (such as metabolites production) and reproduction and is part of the physical structure of the cell. In conditions of low dissolved inorganic carbon (DIC), a DIC transport is induced in most microalgae (Matsuda and Colman, 1995), allowing normal cell growth.

Depending on the material used in cultivation of microalgae and the utilization of biomass, three different systems can be distinguished (Becker, 1994):

1. Systems in which a selected algal strain is grown in a so-called *clean process*, using fresh water, mineral nutrients, and carbon sources. The algae in such systems are intended to be utilized mainly as food supplements.
2. Systems using sewage or industrial wastewater as the culture medium. The cultivation of the microalgae involves secondary (BOD removal) and tertiary (nutrient removal) treatments and production of biomass-based products.
3. Cultivation of algae in enclosed systems under sunlight or artificial light, with cells preferably being grown in autotrophic media.

Microalgae are microorganisms that are capable of producing many different compounds of industrial interest, some with high and some with low aggregated value. The final value of the product and its destination directly influence the conditions of cultivation. Therapeutical compounds produced by microalgae, for example, must be produced through a totally controlled and clean process, whereas for the fuel industry residues can be used and the control of the process can be less accurate. The low culture concentration and the corresponding high downstream costs define production trends.

The utilization of complex media (those of which the composition is not determined, such as industrial residues) in the cultivation of microalgae is one alternative to make the production of some microalgal metabolites economically feasible. Associated with residue composition and microalgal metabolism, knowledge of the needs of the microalgae might save time (and money) in the development of a process. It is very important to supply all microalgal chemical needs because it is known that variations in the chemical composition of phytoplankton are also tightly coupled to changes in growth rate (Goldman et al., 1979).

4.2 CARBON DIOXIDE FIXATION BY MICROALGAE

4.2.1 Carbon Dioxide's Role in Photobioreactors

An important issue in most photobioreactors and the first step in CO₂ fixation is the diffusion of CO₂ from the gas phase to the aqueous phase. The solubility of CO₂ in the culture media depends on depth of the pond, the mixing velocity, the productivity of the system, the alkalinity, and the outgassing. It has been reported (Becker, 1994) that only 13–20% of the supplied CO₂ was absorbed in raceway ponds when CO₂ gas was bubbled into the culture fluid as a carbon source. Binaghi et al. (2003) achieved a maximum value of 38% efficiency of carbon utilization in *Spirulina* cultivation. Gas–liquid contact time and gas–liquid interfacial area are, therefore, two key factors to enhance the gas–liquid mass transfer. In addition, high oxygen tension is problematic, since it promotes CO₂ outgassing and competes with CO₂ for the CO₂-fixing enzyme (RuBisCO).

The capacity for carbon dioxide storage in a growth medium is important because it determines the amount of CO₂ that may be used for medium saturation, leading to high growth rates and in-process economics. Since CO₂ reacts with water, producing carbonic acid and its anions, chemical equilibrium will have a significant impact on the amount of carbon dioxide stored. pH is the major determinant of the relative concentrations of the carbonaceous system in water and affects the availability of carbon for algal photosynthesis in intensive cultures (Azov, 1982).

The absorption of CO₂ into alkaline waters may be accelerated by one of two major uncatalyzed reaction paths: the hydration of CO₂ and subsequent acid-base reaction to form bicarbonate ion, and the direct reaction of CO₂ with the hydroxyl ion to form bicarbonate. The rate of the former reaction is faster at pH values below 8, whereas the latter dominates above pH 10. Between pH 8 and 10, both are important.

Microalgae can fixate carbon dioxide from different sources, including CO₂ from the atmosphere, from industrial exhaust gases (e.g. furnaces flue gases), and in form of soluble carbonates. Traditionally, microalgae are cultivated in open or closed reactors and aerated with air or air enriched with CO₂. Industrial exhaust gases contain up to 15% of carbon dioxide in their composition, being a rich (and cheap) source of carbon for microalgae growth.

In microalgae cultivation, high concentrations of CO₂ are not usually used because it may result in decreasing the pH, since unutilized CO₂ will be converted to HCO₃⁻. Shiraiwa et al. (1991) and Aizawa and Miyachi (1986) reported that an increase in CO₂ concentration of several percent resulted in the loss of a carbon concentration mechanism (CCM), and any further increase was always disadvantageous to cell growth. Most processes use air enriched with CO₂ (2–5% CO₂ final concentration), but some studies using high CO₂-resistant strains are being described in scientific literature.

If there is not enough CO₂ gas supply, algae will utilize (bi)carbonate to maintain its growth. When algae use CO₂ from bicarbonate, an increase of pH is observed (a growth indicator), even reaching growth-inhibition pH values. To overcome pH fluctuation, the CO₂ gas injection should be controlled in such a way that photosynthesis rates are balanced with enough and continuous availability of dissolved carbon. Interesting studies about isolation and selection of strains with high CO₂ absorption capacity, which is an important step no matter the process in development, are available in scientific literature. Maintaining constant CO₂-free concentration in the media will keep carbon uptake constant.

The ability to accumulate DIC has been shown to occur in many algae and cyanobacteria (Williams and Colman, 1995). Whereas CO₂ can diffuse into algal cells and is the substrate for carbon fixation by ribulose-1,5-bisphosphate carboxylase/oxygenase (Rubisco), it forms a small proportion of the total available inorganic carbon. The largest proportion of total DIC available to microalgae consists of ionic HCO₃⁻, which has a low capacity for diffusion across cell membranes (Young et al., 2001). A number of eukaryotic microalgae have developed mechanisms that permit the use of HCO₃⁻ for photosynthesis (Miller and Calvin, 1985). Access to the larger pool of HCO₃⁻ is assumed to involve one or both of two basic processes:

1. In some green algae, the use of HCO₃⁻ has been correlated with the presence of external carbonic anhydrase (CA) activity (Aizawa and Miyachi, 1986). In these cases external CA is thought to facilitate the use of HCO₃⁻ by maintaining equilibrium between HCO₃⁻ and CO₂, and thereby maintaining the supply of CO₂ to a specific transporter (Aizawa and Miyachi, 1986).
2. Direct HCO₃⁻ transport via a transmembrane bicarbonate transporter, which has been demonstrated even in cells that have external CA activity (Williams and Turpin, 1987). The involvement of transmembrane ATPase proteins was also reported in DIC uptake by chlorophytes (Ramazanov et al., 1995).

4.2.2 Methods of CO₂ Fixation Quantification

Since outdoor sunlight cannot be controlled, carbon fixation by microalgae is usually studied indoors under artificial illumination. A good deal of scientific effort is being made to evaluate microalgae CO₂ fixation potential. Most of these efforts focus the fixation into biomass (Chae et al., 2006; Jacob-Lopes et al., 2008; Kajiwara et al., 1997). However, these studies did not quantify the total carbon dioxide fixed effectively by microalgae (Jacob-Lopes et al., 2008; Fan et al., 2007), since there are other routes for carbon besides biomass generation, such as mineralization (formation of soluble bicarbonate and carbonate) and production of extracellular products such as polysaccharides, volatile organic compounds (Shaw et al., 2003), organohalogenes (Scarratt and Moore, 1996), hormones, and others.

The determination of global rates of carbon dioxide sequestration through mass balances of CO₂ in the liquid or gas phase of the systems (Eriksen et al., 2007) gives more complete data. One approximation for the rates may be obtained by evaluating dissolved inorganic carbon concentration in the culture media while monitoring the pH variation (see methodology at Valdés et al., 2012). This shows that carbon fixation by microalgae is a complex process whereby biomass production might be a part of the total carbon destination. In addition, little information is available with respect to the simultaneous research of both the global rates of

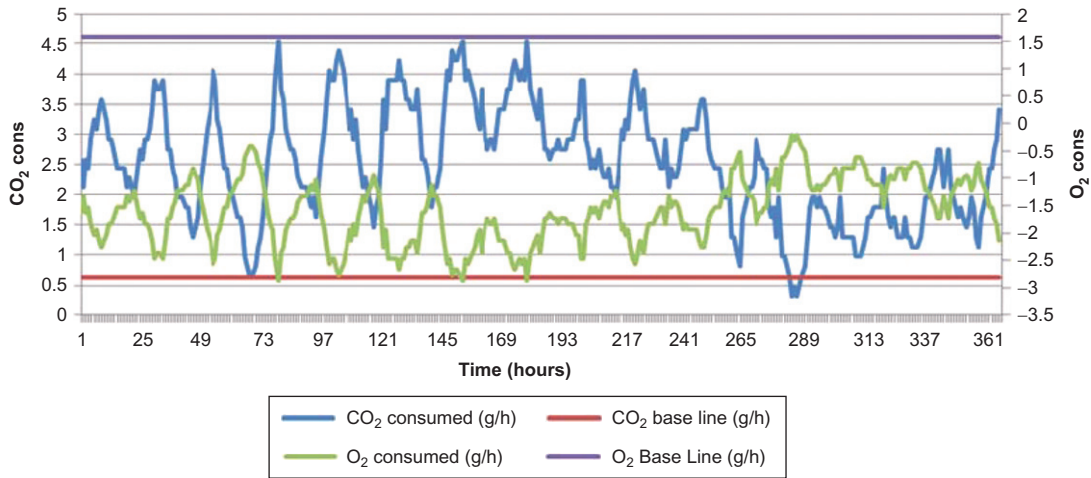

FIGURE 4.3 Gas phase analysis carried by Sydney et al. (2011) showing the carbon consumption and oxygen production profiles.

carbon dioxide sequestration and the rates of incorporation of carbon into the microalgae biomass (Chiu et al., 2008).

Sydney et al. (2011) studied the global CO₂ fixation rate of four microalgae through a mass balance of the gas phase. The experiments were carried out in a photobioreactor coupled with sensors to measure CO₂ in the inlet and outlet gases. The net carbon dioxide mitigation during each microalgal cultivation was evaluated. Nutrient consumption, biomass production (and composition), and possible extracellular products were analyzed throughout the process. It was found that between 70% and 88% of the carbon dioxide consumed was used in biomass production. This finding indicates that, to explore the whole potential of microalgal mitigation capacity (considering negotiations in the carbon market), carbon balance might be carried through (complex) carbon balance in the gas phase. The problem is that it is difficult to carry out this kind of analysis in open photobioreactors and to standardize this methodology. Figure 4.3 presents the profile of carbon dioxide consumption obtained during gas phase analysis during cultivation. It is interesting to note that CO₂ consumption (in blue) has a complementary behavior with O₂ production due to photosynthesis and respiration processes during light and dark cycles.

4.2.3 Carbon Fixation of Industrially Important Microalgae

Carbon fixation by microalgae is in vogue. In the last decade, more than 4,000 papers were published globally on this subject. Table 4.1 presents some rates of carbon dioxide described in the literature.

Among all species of microalgae, four are most common industrially: *Spirulina*, *Chlorella*, *Dunaliella*, and *Haematococcus*. Despite not being used industrially, *Botryococcus* is also largely studied due to its potential use as a source of hydrocarbons. These microalgae's potential for carbon fixation is discussed next.

TABLE 4.1 Data of Biomass Productivity and CO₂ Fixation Rate from Microalgae.

Microalgae Strain	Biomass (mg L ⁻¹ d ⁻¹)	CO ₂ Fixation Rate (mg L ⁻¹ d ⁻¹)	Reference
<i>Spirulina platensis</i>	145	318	Sydney et al., 2011
<i>Chlorella vulgaris</i>	129	251	Sydney et al., 2011
<i>Synechocystis aquatilis</i>	30	50	Zhang et al., 2001
<i>Anabena</i> sp.	310	1450	López et al., 2009
<i>Botryococcus braunii</i>	207	500	Sydney et al., 2011
<i>Dunaliella tertiolecta</i>	143	272	Sydney et al., 2011
<i>Chlorococcum littorale</i>	530	900	Kurano et al., 1996
<i>Aphanothece microscopica</i> Nageli	301	562	Jacob-lobes et al., 2009
<i>Chlorella</i> , <i>Oscillatoria</i> , <i>Oedogonium</i> , <i>Anabaena</i> , <i>Microspora</i> and <i>Lyngbya</i> (mixed culture)	131	161	Tsai et al., 2012

4.2.3.1 *Chlorella vulgaris*

The first photosynthetic microbe to be isolated and grown in pure culture was the freshwater microalga *Chlorella vulgaris*. It is a spherical unicellular eukaryotic green algae that presents a thick cell wall (100–200 nm) as its main characteristic. This cell wall provides mechanical and chemical protection, and its relation to heavy metals resistance is reported, which explains why *C. vulgaris* is one of the most used microorganisms for waste treatment.

The uptake of carbon by *C. vulgaris* cells is done through the enzyme carbonic anhydrase, which catalyzes the hydration of CO₂ to form HCO₃⁻ and a proton. Hirata and collaborators (1996) studied carbon dioxide fixation by this microalga, which showed important variations comparing cultivation under fluorescent lamps and sunlight. In the first case the estimated rate of carbon dioxide fixation was 865 mg CO₂ L⁻¹ d⁻¹; in a sunlight regimen the estimated rate achieved 31.8 mg CO₂ L⁻¹ d⁻¹. Winajarko et al. (2008) achieved a transferred rate of 441.6 g CO₂ L⁻¹ d⁻¹ under the same cultivation conditions as Hirata et al. (1996). According to Sydney et al. (2011), in experiments using classic synthetic media and a 12-h light/dark regimen, *C. vulgaris* biofixation rate of carbon dioxide is near 250 mg L⁻¹ day⁻¹.

Carbon fixation by *Chlorella vulgaris* is variable and depends, among other factors, on the concentration of CO₂ in the gaseous source. Yun et al (1997) cultivated *C. vulgaris* in 15% of carbon dioxide and achieved a fixation of 624 mg L⁻¹ day⁻¹; Scragg et al. (2002) achieved a fixation of 75 mg L⁻¹ day⁻¹ under CO₂ concentration of 0.03%. In the same study, Scragg tested a medium with low nitrogen and the fixation rate was 45 mg L⁻¹ day⁻¹, suggesting that nitrogen also influences carbon uptake rate.

Some studies (Chinassamy et al., 2009; Morais and Costa, 2007) indicate that the best concentration of CO₂ in the gas supplied to *C. vulgaris* growth is about 6%.

4.2.3.2 *Botryococcus braunii*

Botryococcus is a colonial microalga that is widespread in fresh and brackish waters of all continents. It is characterized by its slow growth and by containing up to 50% by weight of hydrocarbons. *B. braunii* is classified into A, B, and L races, mainly based on the difference between the hydrocarbons produced (Metzger and Largeau, 2005). Banerjee et al. (2002) differentiate the races as follows: Race A produces C₂₅ to C₃₁ odd-numbered *n*-alkadienes and alkatrienes; B race produces polymethylated unsaturated triterpenes, called *botryococcenes* (C_{*n*}H_{2*n*-10}, *n* = 30–37); and L race produces a single tetraterpene hydrocarbon C₄₀H₇₈ known as *lycopadiene*.

The cells of *B. braunii* are embedded in a communal extracellular matrix (or “cup”), which is impregnated with oils and cellular exudates (Banerjee et al., 2002). *B. braunii* is capable of synthesizing exopolysaccharides, as reported by Casadevall et al. in 1985. Higher growth and production of EPS, which ranges from 250 g m⁻³ for A and B races to 1 kg m⁻³ for the L race, occur when nitrate is the nitrogen source instead of urea or ammonium salts (Banerjee et al., 2002). Phosphorus and nitrogen are also important factors in accumulation of hydrocarbons by the microorganism (Jun et al., 2003).

The metabolic energy devoted to produce such large amounts of hydrocarbons makes this species noncompetitive in open mass cultures, since strains not so burdened can grow much faster and soon dominate an outdoor pond culture (Benemann et al., 2002). *B. braunii* has been reported to convert 3% of the solar energy to hydrocarbons (Gudin and Chaumont, 1984). Being synthesized by a photosynthetic organism, hydrocarbons from algae can be burned without contributing to the accumulation of CO₂ in the atmosphere.

Dayananda et al. (2007) cultivated *Botryococcus braunii* strain SAG 30.81 in shake flasks and obtained a maximum cell concentration of 0.65 g L⁻¹ under 16:8 light:dark cycle. Experiments with different strains of *B. Braunii* indicate that the biomass yield is inversely proportional to lipid accumulation. The maximum biomass yield achieved was 2 g L⁻¹ (with 40% of lipids) and the lower was 0.2 g L⁻¹ (with 60% of lipids). Outdoor experiments with this microalga achieved a high biomass yield of 1.8 g L⁻¹ but a very low lipid accumulation. It was also showed by Dayananda and collaborators that exopolysaccharides production by *Botryococcus braunii* SAG 30.81 is not affected by light regimen in MBM media, different from lipids and proteins production. Sydney et al. (2011) carried experiments with this same strain under 12 h light:dark cycle in 5% CO₂ enriched air and achieved a high biomass production of 3.11 g L⁻¹ with 33% lipids in 15 days. Carbon dioxide fixation rate was calculated as near 500 mg L⁻¹ day⁻¹. *B. braunii* biomass composition also included 39% proteins, 2.4% carbohydrates, 13% pigments, and 7.5% ash.

Marukami and Ikenouchi (1997) achieved a carbon dioxide fixation greater than 1 gram per liter by *Botryococcus braunii* cultivated for hydrocarbon accumulation.

4.2.3.3 *Spirulina platensis*

Spirulina are multicellular filamentous cyanobacteria actually belonging to two separate genera: *Spirulina* and *Arthrospira*. These encompass about 15 species (Habib et al., 2008). This microorganism grows in water, reproduces by binary fission, and can be harvested and processed easily, having significantly high macro- and micronutrient contents. Their main photosynthetic pigments are chlorophyll and phycocyanin. The helical shape of the filaments (or trichomes) is characteristic of the genus and is maintained only in a liquid environment or culture medium.

Spirulina is found in soil, marshes, freshwater, brackish water, seawater, and thermal springs. Alkaline, saline water (>30 g/L) with high pH (8.5–11.0) favors good production of *Spirulina*, especially where there is a high level of solar radiation. It predominates in higher pH and water conductivity. Like most cyanobacteria, *Spirulina* is an obligate photoautotroph, i.e., it cannot grow in the dark on media containing only organic carbon compounds. It reduces carbon dioxide in the light and assimilates mainly nitrates.

Spirulina contains unusually high amounts of protein, between 55% and 70% by dry weight, depending on the source. It has a high amount of polyunsaturated fatty acids (PUFAs), 30% of its 5–6% total lipids, and is a good source of vitamins (B₁, B₂, B₃, B₆, B₉, B₁₂, C, D, E). *Spirulina* is a rich source of potassium and also contains calcium, chromium, copper, iron, magnesium, manganese, phosphorus, selenium, sodium, and zinc. These bacteria also contain chlorophyll a and carotenoids.

The optimum pH of the *Spirulina sp.* culture is between 8.5 and 9.5 (Watanabe et al., 1995). Cyanobacteria possess a CO₂-concentrating mechanism that involves active CO₂ uptake and HCO₃⁻ transport. In experiments conducted by Morais and Costa (2007), carbon fixation in terms of biomass by *Spirulina platensis* was estimated in 413 mg L⁻¹ d⁻¹, near those achieved by Sydney et al. (2011).

4.2.3.4 *Dunaliella sp.*

Dunaliella is a biflagellate unicellular green alga. Cells are round-shaped and found in brackish environments; it is a motile species and has a high tolerance for salt, temperature, and light. Motion of cells is important since it facilitates nutrient transport, especially in poor-nutrient waters. *Dunaliella* species are relatively easy to culture. The cell divides by simple binary fission, and no evidence of cell lysis, encystment, or spore formation is observed (Segovia et al., 2003).

Dunaliella thrives over a wide pH range and expresses a capacity for extremely efficient DIC accumulation, incorporating a capacity to use HCO₃⁻ in addition to CO₂ (Aizawa and Miyachi, 1986; Young et al., 2001). Kishimoto et al. (1994) cultivated a *Dunaliella* strain for pigment production with 3% of CO₂ and achieved a carbon uptake of 313 mg L⁻¹ day⁻¹. Sydney et al. (2011) cultivated a *D. tertiolecta* strain and achieved a CO₂ fixation rate of 272 mg L⁻¹ day⁻¹.

Dunaliella is an important microalgae for industrial processes since it produces a wide variety of commercial products (mainly pigments) and the rupture of the cells is very easy. β-carotene large-scale production facilities are in operation around the world (Hawaii, United States, Australia, Japan).

4.2.3.5 *Haematococcus sp.*

Haematococcus is a green algae (Chlorophyta), mobile, single-celled, and capable of synthesizing and accumulating the pigment astaxanthin in response to environmental conditions, reaching from 1.5% up to 6% by weight astaxanthin (Vanessa Ghiggi, 2007). The astaxanthin produced by *Haematococcus pluvialis* is about 70% monoester, 25% diesters, and 5% free (Lorenz and Cysewski, 2000).

These algae, however, have some undesirable characteristics compared to other microalgae grown successfully on a commercial scale. The biggest concern is mainly related to a relatively slow growth rate, allowing easy contamination. Therefore, many studies have sought to improve the low rate of growth of vegetative cells, which is, exceptionally, 1.20 div/day (González et al., 2009).

Alternatively, its mixotrophic (Guerin et al., 2003; Gonzáles et al., 2009) and heterotrophic (Hata et al., 2001) metabolism, using acetate as carbon source, has also been studied and documented; however, these conditions have not been applied to commercial-scale cultures and are not interesting in terms of carbon fixation.

4.3 PRACTICAL ASPECTS OF MASS CULTIVATION FOR CO₂ FIXATION

4.3.1 Cultivation Vessels

Many different configurations of photobioreactors are possible: from simple unmixed open ponds to highly complex enclosed ones. The configuration of the bioreactor has great influence on carbon dioxide consumption during algal growth. Most of the recent research in microalgal culturing has been carried out in photobioreactors with external light supplies, large surface areas, short internal light paths, and small dark zones. Examples include open ponds (the cheapest ones), tubular reactors, flat panel reactors, and column reactors (stirred-tank reactors, bubble columns, airlift).

The applications of such systems range from the small-scale production of high-value products to the large-scale production of biomass for feed. The choice between the different designs of photobioreactors must be specific to the intended application and local circumstances.

Open ponds can be an important and cost-effective component of large-scale cultivation technology, and optimal design parameters have been known for many years. The elongated “raceway type” of open pond, using paddlewheels for recirculation and mixing, was developed in the 1950s by the Kohlenbiologische Forschungsstation in Dortmund, Germany. However, sustained open pond production proved to be feasible for only three microalgae: *Spirulina platensis*, *Dunaliella salina*, and fast-growing *Chlorella*, in all cases because contamination by other species can be avoided.

Beyond the economical difference between the types of photobioreactors feasible for algae cultivation, light incidence and CO₂ availability are the two main factors influencing algae growth. Large surface areas are essential to ensure enough light diffusion to the media, but they are normally associated with very little time to mass transfer the gas to the liquid phase (short liquid column). The optimal condition of light diffusion and CO₂ availability is easily achieved in a closed reactor for logical reasons: In open photobioreactors, the undissolved CO₂ is lost to the atmosphere, whereas in closed ones it is possible to increase (and maintain) partial pressure.

4.3.2 Light Diffusion

The most important parameter considered for the development and utilization of a specific type of reactor for microalgae cultivation is the light diffusion. The productivity of photoautotrophic cultures is primarily limited by the supply of light and suffers from low energy-conversion efficiencies caused by inhomogeneous distribution of light inside the cultures (Grobelaar, 2000). At culture surfaces, light intensities are high, but absorption and scattering result in decreasing light intensities and complex photosynthetic productivity profiles inside the cultures (Ogbonna and Tanaka, 2000). High light intensities at culture

surfaces may cause photoinhibition, and the efficiency of light energy conversion into biomass (photosynthetic efficiency) is low. An overdose of excitation energy can lead to production of toxic species (e.g., singlet oxygen) and to photosynthesis damage (Janssen, 2002)

By minimizing depth, volume is reduced or area is increased, light diffusion is maximized, and so is cell concentration. From common types of photobioreactors, light paths in open ponds are usually 10–30 cm depth, in tubular reactors ranges from 1–5 cm, and in flat panel reactors from 2–5 cm.

The light regimen itself is influenced by incident light intensity, reactor design and dimension, cell density, pigmentation of the cells, mixing pattern, and more. In outdoor photobioreactors the light regimen is also influenced by geographical location, time of day, and weather conditions. Nowadays, open paddlewheel-mixed pond is the most commonly used photobioreactor.

Some studies discuss the effect of mixing and productivity due to the “flashing-light” effect: A few milliseconds’ flashes of high light intensity followed by a several-fold longer period of darkness do not reduce culture productivity from those under constant illumination (Kok, 1953). This effect is not observed in ponds, where the light/dark period is longer. For example, although light/dark cycles of 94/94 ms were sufficiently short to increase the photosynthesis efficiency in cultures of *Dunaliella tertiolecta*, light/dark cycles of 3/3 s were too long and the PE decreased in comparison to continuously illuminated cultures (Janssen et al., 2001). This refers to the theory of photosynthesis, in which carbon fixation is not dependent on the presence of light because sufficient energy has been absorbed.

4.3.3 Mixing

To optimize the photosynthesis rate and gas solubility in the media, mixing is very important. Besides that, mixing is important for homogeneous distribution of cells, metabolites, and heat and to transfer gases across gas–liquid interfaces. Mixing can be done mechanically by paddlewheel in raceways (Figure 4.4) or by gas flow in bubble columns.



FIGURE 4.4 Paddlewheel mixing of raceway ponds at Ouro Fino Agronegócio (Brazil).

4.4 CARBON MARKET FOR MICROALGAL TECHNOLOGIES

The Kyoto Protocol invented the concept of carbon emissions trading in a flexible mechanism whereby developed countries could use carbon credits to meet their emission reduction commitments. The world carbon market is based on a cap-and-trade system. According to Mark Lazarowicz (2009), under cap-and-trade, a cap is set on emissions, as explained further by the author: "Allowances are provided, either through purchase or allocation, to emitters covered by the cap. These emitters are required to submit allowances equal to the amount of greenhouse gases emitted over a predetermined period. The difference between expected emissions and the cap creates a price for the allowances. Emitters who can reduce emissions for less than the price of an allowance will do so. If, however, abatement costs more than the price of an allowance, it makes sense to purchase the allowance. The transfer of allowances is the 'trade.' The relative difficulty of abatement or scarcity of allowances sets the price of carbon. In theory, those that can reduce emissions most cheaply will do so, achieving the reduction at the lowest possible cost." For this reason, the carbon market seems to be a temporary alternative while cleaner technologies are developed, including new ones and improvement of the existing ones.

The carbon market jumped from \$63 billion in 2007 to \$126 billion in 2008, which means almost 12 times the value of 2005, according to the World Bank report of 2009. Credits were sold for 4.8 billion tons of carbon dioxide, a value 61% higher than that of the previous year. By 2020 the market could be worth up to \$2–3 trillion per year (Point Carbon, *Carbon Market Transactions in 2020: Dominated by Financials?*, May 2008).

The world carbon market is mainly dependent on energy-use policies. The focus is to replace existing high dependence on fossil fuels with renewable ones; around 90% of total global CO₂ emissions are from fossil fuel combustion (excluding forest fires and woodfuel use; Olivier et al., 2011). The principal technical means of reducing fossil fuel consumption (and consequently emissions) are substituting fossil fuels with renewable or less carbon-content sources of energy and improving energy efficiency. Renewable energy's share of the global energy supply increased from 7% in 2004 to over 8% by 2009 and 2010 (Olivier et al., 2011).

According to the "Long-term trend in global CO₂ emission, 2011 report," total global CO₂ emissions had increased 30% since 2000, to 33 billion tones, and 45% since 1990, the base year of the Kyoto Protocol. In 1990 the industrialized countries, with a mitigation target for total greenhouse gas emissions under the Kyoto Protocol (including the United States, which did not ratify the protocol), had a share in global CO₂ emissions of 68% versus 29% for developing countries. In 2010 the large regional variation in emission growth trends resulted in shares for 54% of developing countries and 43% for mature industrialized countries.

Microalgae can play a very interesting role in this context. While fixating carbon during growth (to be traded in the market), some species can accumulate lipids, which can be used for direct combustion or transformed in biodiesel to replace fossil sources. This is one of the developing technologies that receives more attention from the scientific community around the world.

The carbon market for microalgal carbon mitigation processes is a big challenge. Its entrance in this market will coexist with other renewable energy technologies that are receiving lots of investment, which means that it must be more advantageous or differentiated. Trades of carbon papers are carried mainly based on agriculture and forestry (reforestation, land

management, reduced emissions from deforestation). Great efforts are being made in the development and implantation of renewable energy technologies (wind power, solar photovoltaic, and vegetable-based biodiesel technologies).

In terms of development of more efficient and sustainable industrial processes, microalgae can play an interesting role through combining the use of domestic and industrial wastewater (mainly that lacking fermentable carbon) and industrial gaseous wastes with cogeneration of valuable products, reducing carbon emissions and generating tradable carbon papers. According to the mass balance (Equation 4.3), where the biomass composition is given as $\text{CH}_{1.78} \text{N}_{0.15} \text{O}_{0.52}$ (analysis made in CHNS analyzer carried at the Bioprocess Engineering and Biotechnology Department, Federal University of Parana, Brazil), around 1.8 g_{CO₂} is consumed for each gram of dry biomass produced during microalgal growth. This means that, for producing 1 Carbon Paper (1 ton CO₂), an area less than 1,000 square meters is needed (considering a biomass concentration in the culture of 3 g L⁻¹ and a pond with 20 cm high of liquid).

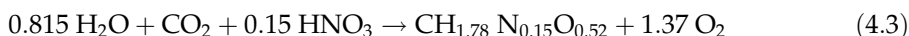

References

- Aizawa, K., Miyachi, S., 1986. Carbonic anhydrase and CO₂ concentrating mechanisms in microalgae and cyanobacteria. *FEMS Microbiol. Rev.* 39, 215–233.
- Atomi, H., 2002. Microbial enzymes involved in carbon dioxide fixation. *J. Biosci. Bioeng.* 94, 497–505.
- Azov, Y., 1982. Effect of pH on Inorganic Carbon Uptake in Algal Cultures. *Appl. Environ. Microbiol.* 43, 1300–1306.
- Banerjee, A., Sharma, R., Chisti, Y., Banerjee, U.C., 2002. *Botryococcus braunii*: A Renewable Source of Hydrocarbons and Other Chemicals. *Crit. Rev. Biotechnol.* 22 (3), 245–279.
- Becker, E.W., 1994. *Microalgae: Biotechnology and Microbiology*. Cambridge University Press, p. 293.
- Benemann, J.R., Oswald, W.J., 1996. Systems and economic analysis of microalgae ponds for conversion of CO₂ to biomass. Master's thesis. University of California, Berkeley.
- Benemann, J.R., Van Olst, J.C., Massingill, M.J., Weissmann, J.C., Brune, D.E., 2002. The controlled eutrophication process: Using microalgae for CO₂ utilization and agricultural fertilizer recycling. GHGT-6, Kyoto, Japan.
- Binaghi, L., Del Borghi, A., Lodi, A., Converti, A., Del Borghi, M., 2003. Batch and fed-batch uptake of carbon dioxide by *Spirulina platensis*. *Process Biochemistry* 38, 1341–1346.
- Chae, S.R., Hwang, E.J., Shin, H.S., 2006. Single cell protein production of *Euglena gracilis* and carbon dioxide fixation in an innovative photo-bioreactor. *Bioresour. Technol.* 97, 322–329.
- Casadevall, E., Dif, D., Largeau, C., Gudin, C., Chamount, D., Desanti, O., 1985. Studies on batch and continuous culture of *Botryococcus braunii*: hydrocarbon production in relation to physiological state, cell ultrastructure and phosphate nutrition. *Biotechnol. Bioeng.* 27, 286.
- Chinassamy, S., Ramakrishnan, B., Bhatnagar, A., Das, K.C., 2009. Biomass Production Potential of a Wastewater Alga *Chlorella vulgaris* ARC 1 under Elevated Levels of CO₂ and Temperature. *Int. J. Mol. Sci.* 10, 518–532.
- Chiu, S.Y., Kao, C.Y., Chen, C.H., Kuan, T.C., Ong, S.C., Lin, C.S., 2008. Reduction of CO₂ by a high-density culture of *Chlorella* sp. in a semicontinuous photobioreactor. *Bioresour. Technol.* 99, 3389–3396.
- Dayananda, C., Sarada, R., Rani, M.U., Shamala, T.R., Ravishankar, G.A., 2007. Autotrophic cultivation of *Botryococcus braunii* for the production of hydrocarbons and exopolysaccharides in various media. *Biomass and Bioenergy* 31, 87–93.
- Engstrom, N., 2012. Cultivation of seven different species of marine microalgae using simulated flue gas mimicking effluents from paper mills as carbon source. Master of Science Thesis in the Master Degree Program Biotechnology. Gothenburg, Sweden, 93 pages.
- Eriksen, N.T., Riisgard, F.K., Gunther, W.S., Iversen, J.J.L., 2007. On-line estimation of O₂ production, CO₂ uptake, and growth kinetics of microalgal cultures in a gas-tight photobioreactor. *J. Appl. Phycol.* 19, 161–174.
- Fan, L., Zhang, Y., Cheng, L., Zhang, L., Tang, D., Chen, H., 2007. Optimization of carbon dioxide fixation by *Chlorella vulgaris* cultivated in a membrane-photobioreactor. *Chem. Eng. Technol.* 8, 1094–1099.

- Fuchs, G., 2011. Alternative Pathways of Carbon Dioxide Fixation: Insights into the Early Evolution of Life? *Annu. Rev. Microbiol.* 65, 631–658.
- Chiggi, V., 2007. Estudo do crescimento e indução da produção do pigmento Astaxantina por *Haematococcus pluvialis*. Master thesis. Federal University of Paraná, 119 pages.
- Goldman, J.C., McCarthy, J.J., Peavey, D.G., 1979. Growth rate influence on the chemical composition of phytoplankton in oceanic waters. *Nature* 279, 210–215.
- González, M.A., Cifuentes, A.S., Gómez, P.L., 2009. Growth and total carotenoid content in four Chilean strains of *Haematococcus pluvialis* Flowtow, under laboratory conditions. *Gayana Botánica* 66, 58–70.
- Grobbelaar, J., 2000. Physiological and technological considerations for optimising mass algal cultures. *J. Appl. Phycol.* 12, 201–206.
- Gudin, C., Chaumont, D., 1984. Solar biotechnology study and development of tubular solar receptors for controlled production of photosynthetic cellular biomass for methane production and specific exocellular biomass. In: Palz, W., Pirrwitz, D. (Eds.), *Energy from biomass*, series E, vol. 5. Reidel, Dordrecht, pp. 184–193.
- Guerin, M., Huntley, M.E., Olaizola, M., 2003. *Haematococcus astaxanthin*: applications for human health and nutrition. *Trends Biotechnol.* 21, 210–216.
- Habib, M.A.B., Parvin, M., Huntington, T.C., Hasan, M.R., 2008. A review on culture, production and use of *Spirulina* as food for humans and feeds for domestic animals and fish. *FAO Fisheries and Aquaculture Circular*. No. 1034.
- Hata, N., Ogbonna, J.C., Hasegawa, Y., Taroda, H., Tanaka, H., 2001. *J. Appl. Phycol.* 13, 395–402(8).
- Hirata, S., Hayashitani, M., Taya, M., Tone, S., 1996. Carbon Dioxide Fixation in Batch Culture of *ChZoreZla* sp. Using a Photobioreactor with a Sunlight-Collection Device. *Journal of Fermentation and Bioengineering* 81 (5), 470–472.
- Jun, W., Suling, Y., Wei, C., Zhao, L.C., 2003. Effect of nutrient conditions on the growth of *Botryococcus braunii*. *Chinese Journal of Process Engineering* 2 (2), 141–145.
- Jacob-Lopes, E., Scoparo, C.H.G., Franco, T.T., 2008. Rates of CO₂ removal by *Aphanothece microscopica* Nägeli in tubular photobioreactors. *Chem. Eng. Process* 47, 1365–1373.
- Jacob-Lopes, E., Scoparo, C.H.G., Lacerda, L.M.C.F., Franco, T.T., 2009. Effect of light cycles (night/day) on CO₂ fixation and biomass production by microalgae in photobioreactors. *Chemical Engineering and Processing: Process Intensification* 48 (1), 306–310.
- Janssen, M., 2002. Cultivation of microalgae: effect of light/dark cycles on biomass yield. Thesis. Wageningen University, Wageningen, The Netherlands, 184 p.
- Janssen, M., et al., 2001. Photosynthetic efficiency of *Dunaliella tertiolecta* under short light/dark cycles. *Enzyme Microb. Technol.* 29, 298–305.
- Kajiwarra, S., Yamada, H., Narumasa, O., 1997. Design of the bioreactor for carbon dioxide fixation by *Synechococcus* PCC7942. *Energy Convers. Mgmt.* 38, 529–532.
- Kishimoto, M., Okakura, T., Nagashima, H., Minowa, T., Yokoyama, S.Y., Yamaberi, K., 1994. CO₂ fixation and oil production using microalgae. *J. Ferment. Bioeng.* 78, 479–482.
- Kok, B., 1953. Experiments on photosynthesis by *Chlorella* in flashing light. In: *Algal Culture from Laboratory to Pilot Plant*, pp. 63–75.
- Kurano, N., Ikemoto, H., Miyashita, H., Hasegawa, T., Hata, H., Miyachi, S., 1996. Fixation and Utilization of Carbon Dioxide by Microalgal Photosynthesis. *Energy Convers. Mgmt.* 36 (6–9), 689–692.
- Lazarowicz, M., 2009. Global carbon trading: A framework for reducing emissions. The Stationery Office. 162 pages.
- Lin, C.C., Liu, W.T., Tan, C.S., 2003. Removal of carbon dioxide by absorption in a rotating packed bed. *Ind Eng Chem Res* 42, 2381–2386.
- López, C.V.G., Fernández, F.G.A., Sevilla, J.M.F., Fernández, J.F.S., Garcia, M.C.C., Grima, E.M., 2009. Utilization of the cyanobacteria *Anabaena* sp. ATCC 33047 in CO₂ removal processes. *Bioresour. Technol.* 100, 5904–5910.
- Lorenz, R.T., Cysewski, G.R., 2000. Commercial potential for *Haematococcus* microalgae as a natural source of astaxanthin. *Trends Biotechnol.* 18 (4), 160–167.
- Masojídek, J., Koblížek, M., Torzillo, G., 2004. Photosynthesis in Microalgae. In: Richmond, A. (Ed.), *Handbook of Microalgal Mass Cultures*. Blackwell Science.
- Matsuda, Y., Colman, B., 1995. Induction of CO₂ and Bicarbonate Transport in the Green Alga *Chlorella ellipsoidea*. *Plant Physiol.* 108, 253–260.
- Metzger, P., Largeau, C., 2005. *Botryococcus braunii*: a rich source for hydrocarbons and related ether lipids. *Appl. Microbiol. Biotechnol.* 66, 486–496.
- Miller, A.G., Calvin, D.T., 1985. Distinction between HCO₃⁻ and CO₂-dependent photosynthesis in the cyanobacterium *Synechococcus leopoliensis* based on the selective response of HCO₃⁻ transport to Na⁺. *FEBS Lett.* 187, 29–32.

- Marukami, M., Ikenouochi, M., 1997. The biological CO₂ fixation and utilization project by RITE (2)—screening and breeding of microalgae with high capability in fixing CO₂. *Energy Convers. Manage.* 38, 493–497.
- Morais, M.G., Costa, J.A.V., 2007. Carbon dioxide fixation by *Chlorella kessleri*, *C. vulgaris*, *Scenedesmus obliquus* and *Spirulina sp.* cultivated in flasks and vertical tubular photobioreactors. *Biotechnol. Lett.* 29, 1349–1352.
- Ogbonna, J.C., Tanaka, H., 2000. Light requirement and photosynthetic cell cultivation: Developments of processes for efficient light utilization in photobioreactors. *J. Appl. Phycol.* 12, 207–218.
- Olivier, J.G.J., Janssens-Maenhout, G., Peters, J.A.H.W., Wilson, J., 2011. Long-term trend in global CO₂ emissions. 2011 report. PBL Netherlands Environmental Assessment Agency, The Hague, 2011; European Union, 2011, 42 pages.
- Ramazanov, Z., Sosa, P.A., Henk, M.C., Del Rio, J., Gomez-Pinchetti, J.L., Garcia-Rena, G., 1995. Low-CO₂-inducible protein synthesis in the green alga *Dunaliella tertiolecta*. *Planta* 195, 519–524.
- Rubin, E., et al., 10 July 1992. Realistic mitigation options for global warming. *Science* 257, 148–266.
- Scarratt, M.G., Moore, R.M., 1996. Production of methyl chloride and methyl bromide in laboratory cultures of marine phytoplankton. *Mar. Chem.* 54, 263–272.
- Scragg, A.H., Illman, A.M., Carden, A., Shales, S.W., 2002. Growth of microalgae with increased calorific values in a tubular bioreactor. *Biomass Bioenergy* 23, 67–73.
- Shaw, S.L., Chisholm, S.W., Prinn, R.G., 2003. Isoprene production by *Prochlorococcus*, a marine cyanobacterium, and other phytoplankton. *Mar. Chem.* 80, 227–245.
- Segovia, M., Haramaty, L., Berges, J.A., Falkowski, P.G., 2003. Cell death in the unicellular chlorophyte *Dunaliella tertiolecta*. A hypothesis on the evolution of apoptosis in higher plants and metazoans. *Plant Physiol.* 132 (1), 99–105.
- Shiraiwa, Y., Yokoyama, S., Satoh, A., 1991. pH-dependent regulation of carbonic anhydrase induction and change in photosynthesis during adaptation of *Chlorella* cells to low CO₂. *J. Phycol.* 39, 355–362.
- Staehelin, L.A., 1986. Supramolecular organization of thylakoid membranes—A status report. *Recent Advances in Photosynthesis Research*, American Society for Plant Physiologists, Baton Rouge, LA, pp. 1–8.
- Stewart, C., Hessami, M.A., 2005. A study of methods of carbon dioxide capture and sequestration—the sustainability of a photosynthetic bioreactor approach. *Energy Convers. Manage.* 46, 403–420.
- Sydney, E.B., da Silva, T.E., Tokarski, A., Novak, A.C., de Carvalho, J.C., Woiciechowski, A.L., et al., 2011. Screening of microalgae with potential for biodiesel production and nutrient removal from treated domestic sewage. *Applied Energy* 88, 3291–3294.
- Tsai, D.D.W., Ramaraj, R., Chen, P.H., 2012. Growth condition study of algae function in ecosystem for CO₂ bio-fixation. *J. Photochem. Photobiol. B* 107, 27–34.
- Turpin, D.H., 1991. Effects of inorganic N availability on algal photosynthesis and carbon metabolism. *J. Phycol.* 27, 14–20.
- Valdés, F.J., Hernández, M.R., Catalá, L., Marcilla, A., 2012. Estimation of CO₂ stripping/CO₂ microalgae Consumption ratios in a bubble column photobioreactor using the analysis of the pH profiles Application to *Nannochloropsis oculata* microalgae culture. *Bioresour. Technol.* 119, 1–6.
- Young, E., Beardall, J., Giordano, M., 2001. Inorganic carbon acquisition by *Dunaliella tertiolecta* (Chlorophyta) involves external carbonic anhydrase and direct HCO₃⁻ utilization insensitive to the anion exchange inhibitor DIDS. *Eur. J. Phycol.* 36, 81–88.
- Yun, Y.S., Lee, S.B., Park, J.M., Lee, C.I., Yang, J.W., 1997. Carbon dioxide fixation by algal cultivation using wastewater nutrients. *J. Chem. Technol. Biotechnol.* 69, 451–455.
- Wang, B., Li, Y., Wu, N., Lan, C.Q., 2008. CO₂ mitigation using microalgae. *Appl. Microbiol. Biotechnol.* 79, 707–718.
- Watanabe, A., De La Noue, J., Hall, D.O., 1995. Photosynthetic performance of a helical tubular photobioreactor incorporating the cyanobacterium *Spirulina platensis*. *Biotechnol. Bioeng.* 47, 261–269.
- Williams, T.G., Colman, B., 1995. Quantification of the Contribution of CO₂, HCO₃⁻ and External Carbonic Anhydrase to Photosynthesis at Low Dissolved Inorganic Carbon in *Chlorella saccharophila*. *Plant Physiol.* 107, 245–251.
- Williams, T.G., Turpin, D.H., 1987. The role of external carbonic anhydrase in inorganic carbon acquisition by *Chlamydomonas reinhardtii*. *Plant Physiol.* 83, 92–96.
- Winajarko, A., Muryanto, D., Simanjuntak, J., Dyah, P.P., Wulan, K., Hermansyah, H., et al., 2008. Biomass production *Chlorella vulgaris* Buitenzorg using series of bubble column photo reactor with a periodic illumination. *Makara, Teknologi* 12 (1), 27–30.
- Zhang, K., Miyachi, S., Kurano, N., 2001. Evaluation of a vertical flat-plate photobioreactor for outdoor biomass production and carbon dioxide biofixation: effects of reactor dimensions, irradiation and cell concentration on the biomass productivity and irradiation utilization efficiency. *Appl. Microbiol. Biotechnol.* 55, 428–433.

Algal Biomass Harvesting

Kuan-Yeow Show¹ and Duu-Jong Lee²

¹Department of Environmental Science and Engineering, Fudan University,
Shanghai, China

²Department of Chemical Engineering, National Taiwan University,
Taipei, Taiwan

5.1 INTRODUCTION

Concern has been growing over carbon emissions and diminishing energy resources related to the use of fossil fuels. To mitigate the impacts of these pressing environmental issues, extensive efforts are being made globally to explore various renewable energy sources that could replace fossil fuels. Biofuels are regarded as promising alternatives to conventional fossil fuels because they have the potential to eliminate most of the environmental problems that fossil fuels create. However, sustainable production of biofuels is hotly debated because it is perceived that biofuels produced from crops, lingo-cellulose, and food sources face various constraints in accomplishing sustainable development at the confluence of biofuel production, climate change mitigation, and economic growth. In view of the still-developing biofuel production process, biodiesel production from microalgae offers greater potential to become an inexhaustible and renewable source of energy.

Algae are a very diverse group of predominantly aquatic photosynthetic organisms that account for almost 50% of the photosynthesis taking place on Earth (Moroney and Ynalvez, 2009). Algae have a wide range of antenna pigments to convert solar energy to chemical energy via photosynthesis, giving different strains of algae their characteristic colors. Early work done with algae contributed much to what is now known about the carbon dioxide fixation pathway and the light-harvesting photosynthetic reactions. The processes of photosynthesis in algae and terrestrial plants are very much alike. Among the three types of carbon dioxide fixation mechanisms known in photosynthetic organisms, two are found in the genus of algae (Moroney and Ynalvez, 2009). Moreover, studies indicate that carbon dioxide fixation in algae is one to two orders of magnitude higher than that of terrestrial plants

(Wang et al., 2008). Thus, algae are deemed to play a vital role in the global carbon cycle by removing excess carbon dioxide from the environment.

Cultivation of rapidly grown microalgae may acquire only 1% of land area needed for conventional crop-based farmlands. A microalgae production scenario estimated the use of only 121,000 hectares of open pond or 58,000 hectares of photobioreactor footprint to meet global annual gasoline requirements (Chisti, 2007). Furthermore, waste water enriched with nutrients such as nitrogen and/or phosphorous can be used as a growing medium for algal cultivation, thus negating the need for fertilizers derived from fossil-fuel energy. Additionally, uptake of nutrients by algae for biomass buildup *per se* is a form of treatment to the waste water in meeting effluent discharge requirements. In addition to biofuel production, cultivated microalgae can be used as bulk commodities in pharmaceuticals, cosmetics, nutraceuticals, and functional foods (Mata et al., 2010).

Algae have been recognized as a promising biofuel resource due to their efficient conversion of solar energy into chemical energy. Because algae biomass is capable of producing much more oil yield per cultivation broth area than other biofuels such as corn and soybean crops, algal biodiesel has attracted widespread attention because of the prospect of its large-scale practical use.

Existing stages for biodiesel production from algae involve a production scheme starting with algal strain development and cultivation, followed by harvesting through separation of the algal biomass from the supporting media, and subsequent further processing such as dewatering, drying, oil extraction and fractionation (Figure 5.1). The objective of this chapter is to present a discussion of the literature review of recent developments in algae processing. The review and discussion focus on stability and separability of algae and algae-harvesting processes. Challenges of and prospects for algae harvesting are also outlined. The review aims to provide useful information to help in future development of efficient and commercially viable technologies for algal biodiesel production.

5.2 STABILITY AND SEPARABILITY OF MICROALGAE

The characteristics of microalgae and the state in which they thrive can greatly affect the choice of algae-harvesting technology and its performance (Cooney et al., 2009). Separation of tiny and loosely suspended algal particles from the broth can be cumbersome because algal

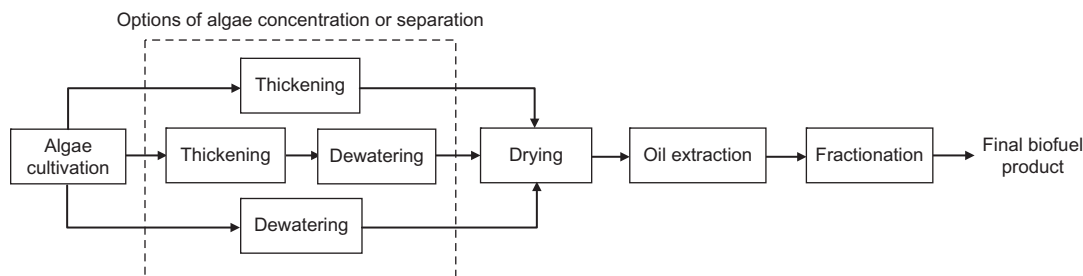

FIGURE 5.1 Schemes for algae cultivation, harvesting, and processing for biofuel production.

cells normally carry negative charge and excess extracellular polymeric substances (EPS) to maintain algal stability in a dispersed state (Gudin and Therpenier, 1986). The stability of microalgae in the growth medium is mainly associated with algal surface charge, size, and density of the algal cells, which in turn influence their separability from aqueous suspensions. Both the electric interactions between algal cells and cell interactions with the surrounding culture broth contribute to the stability of the algal suspension (Tenney et al., 1969), whereas size and density of algal cells dictate their settling rate, which is an important consideration for sedimentation process design. Harvesting cost can be high since the mass fractions in culture broth are generally low.

Studies of the effect on surface charge of particles by various treatment methods have been extensively documented. Farvardin and Collins (1989) noted that pre-ozonation increases surface charge of humic substances. In another study, Chheda et al. (1992) noted an increase in stability of suspension of Na-montmorillonite particles at increased ozone dose, attributed to the increase in surface charge as a result of disruption of metal-oxygen bonds in crystal lattice. These studies, however, reported the existence of an optimal ozone dose whereby the coagulation of particles can be improved.

Conversely, Chheda and Grasso (1994) revealed that ozonation reduced stability of the Na-montmorillonite particles coated with natural organic matters (NOM) in river waters. It was postulated that the adsorption of NOM on Na-montmorillonite particles per se would render the particles more hydrophilic. Subsequent ozonation, however, turns the particle surface less negatively charged. This, in turn, resulted in partial dealuminization of Na-montmorillonite and transformation of coated NOM to increase the hydrophobicity of the particle surface, hence destabilizing the particles. It can be deduced from these studies that appropriate treatment of ozonation would help destabilize particles, leading to improved separation from the medium. Possible mechanisms for enhanced coagulation of suspended particles caused by ozonation were proposed (Reckhow et al., 1986; Plummer and Edzwald, 2002). These mechanisms include:

1. Increase in carboxylic content to enhance adsorption to alum floc and calcium and magnesium precipitates
2. Reduction in molecular weight of adsorbed organics to reduce steric hindrance of particles
3. Breakdown of organometallic bonds to release ions such as Fe^{3+} for organics precipitation
4. Rupture and lyses of algal cells to release biopolymers for coagulation
5. Polymerization to large particles for sedimentation

Henderson et al. (2009) noted that bubbles with surfaces modified using chemicals of both a hydrophobic long tail and a hydrophilic high charge head can yield sufficient algal removal without upstream coagulation and flocculation. In an earlier study by Henderson et al. (2008), it was reported that the algogenic organic matters (AOM) extracted from four algal species (*Chlorella vulgaris*, *Microcystis aeruginosa*, *Asterionella formosa*, and *Melosira sp.*) were dominated by hydrophilic polysaccharides and hydrophobic proteins of low specific UV absorbance and negative zeta potentials. The hydrophobicity of AOM was attributable to the hydrophobic proteins of molecular mass greater than 500 kDa. Additionally, the charge density for the AOM, being attributable to hydrophilic and acidic carbohydrates and not hydrophobic humic acids, decreases inversely with hydrophobicity. On the other hand,

inhibition on ferric chloride coagulation of algae by isolated AOM secreted by cyanobacterium *Aphanothece halophytica* was reported (Chen et al., 2009). It was hypothesized that the AOM can form complex compounds with ferrum thereby inhibits the coagulation. As discussed earlier, ozonation is able to increase hydrophobicity of NOM, thereby enhancing its coagulation. The impact of ozonation on AOM, however, is unclear and yet to be investigated.

Just like planktonic cells, algal cells normally carry negative surface charge. Whereas algal surface charges are derived from ionization of ionogenic functional groups at the algal cell wall (Golueke and Oswald 1970) and selective adsorption of ions from the culture medium, the intensity of the charge is influenced by algal species, ionic concentration of medium, pH, and other environmental conditions.

Based on the principles of the Deyaguin-Landau-Verwey-Overbeek (DLVO) theory of colloid stability, the interactions between colloidal particles are influenced by various interacting forces such as electrostatic double-layer repulsion, van der Waals attraction, and steric interaction. There is a potential energy barrier to be overcome if coagulation of the minute charge particles is to be attained. It can be exceeded by the kinetic energy of the particles or, alternatively, by the reduction of the energetic barrier. This is done by compressing the double layer through either by increasing the counter-ion concentration or by using counter-ions of higher valency (Ives, 1959). Although the double-layer theory is of great theoretical importance, its use is restricted to cases in which specific chemical interactions do not play a role in colloid stability.

Destabilization of colloidal suspension such as that in algal culture as a result of specific chemical interactions is attainable by the presence of organic polymers (Shelef et al., 1984). Commercial polymers, usually those of high molecular weights such as polyelectrolytes or polyhydroxyl complexes, are considered superior coagulants or flocculants. The polymeric coagulation-flocculation is explained by the bridging model, postulating that a polymer can attach itself to the surface of an algal particle by several segments with remainder segments extended into solutions. These segments are then able to attach to vacant sites of other algal particles, forming a three-dimensional floc network (Gregory, 1977).

A planktonic algal cell can be considered a very minute spherical object that falls in a continuous viscous fluid medium at velocities governed by gravity's downward force and the upward drag (or frictional) and buoyancy forces. If the algal particle is falling in the viscous fluid by its own weight due to gravity, then a *terminal velocity*, also known as the *settling velocity*, is reached when this frictional force, combined with the buoyant force, exactly balances the gravitational force, as described by Stokes' law. In actual fact, the settling velocity of planktonic algae in natural habitat is dictated by a variety of complex factors, which include cell mobility, water turbulence and flow, and upwelling caused by winds and temperature stratification (Hutchinson, 1967). The settling velocity of planktonic algae can be reduced in an ecosystem by the following:

1. Motility
2. Reducing cell dimensions
3. Increment of the drag forces as in the Scenedesmus species, which contain seta (Conway and Trainer, 1972)
4. Reducing cell density, as in many blue-green algae, which contain gas vacuoles (Fogg, 1975; Paerl and Ustach, 1982)

Hence, the settling velocity of an algal cell can be increased by increasing cell dimensions, i.e., by cell aggregation into a larger body. This principle is applied in algal separation processes where chemical coagulants are added to form large algal flocs which settle rapidly to the reactor or tank bottom. Conversely, air bubbles, which may attach to the already formed algal flocs, will reduce drastically the floc density, causing the floc to float atop the vessel. Increasing the gravity force will increase the settling velocity of algal cells, which is attainable by applying centrifugal forces on algal suspensions.

In summary, destabilization and flocculation of algal suspension are important considerations in most of the various algal separation and harvesting processes, which are described separately in the following section.

5.3 METHODS OF ALGAE HARVESTING

Separating algae from its medium and/or algal biomass concentrating is known as *harvesting*. Selection of harvesting technologies depends principally on the type of algae (Chen et al., 2011). Harvesting large algae, namely macroalgae, employs laborious work involving simple operations, whereas minute microalgae are normally harvested using mechanical means. Macroalgae grow either in fluid suspension or on a solid medium fed with substrate. To harvest macroalgae grown on solid substrate, they must be detached directly from the medium. The *modus operandi* in harvesting suspended macroalgae is relatively simple and laborious. The harvesting can be accomplished by nets raised from the pond bottom and pulled over a petrol-driven rotary cutter mounted on the harvesting boat. The macroalgae are cut, collected, and transported to land and dried under the sun. Nets are normally harvested three to four times, but the yield reduces progressively over each harvest.

Current work on algae for the commercial production of biofuel mainly focuses on microalgae. The inclination toward microalgae is due largely to its simpler cell structure, rapid growth rate, and high lipid content. However, the most rapidly growing algal species are frequently minute and often motile unicells; these are the most difficult algae to harvest. Processes for biodiesel production from microalgae engage a production unit whereby microalgae is cultivated, separated from the growing medium and thickened, and put through subsequent downstream processing such as dewatering, drying, and lipid extraction. Extracted lipids are processed for biodiesel or other biofuels in similar methods to existing technologies used for other biofuel feedstock.

For microalgae grown in an aqueous medium, thickening of loose algae suspension until a thick algae slurry or cake forms is a vital stage of harvesting. In other words, the water content of algae suspension must be reduced as far as possible to enable practical harvesting and downstream processes. Algae are technically harvested based on the principles of solid-liquid separation processes. The harvesting process may include one or more of the stages of thickening, dewatering, and drying (Figure 5.1). The most common harvesting processes are screening, coagulation, flocculation, flotation, sedimentation, filtration, and centrifugation. Other harvesting techniques such as electrophoresis, electroflotation, and ultrasound are used to lesser extents (Chen et al., 2011). In essence, the choice of technology for algae harvesting must be energy-efficient and relatively inexpensive for viable biofuel production.

5.3.1 Screening

Screening is the first unit operation used in most wastewater treatment plants as well as algae harvesting. The principle of screening involves introducing algae biomass onto a screen of given aperture size. The efficiency of the screening operation depends on the spacing between screen openings and algal particle size. For algae harvesting, microstrainers and vibrating screens are common screening devices.

5.3.1.1 Microstraining

Microstrainers consist of a rotary drum covered by a straining fabric, stainless steel or polyester. The partially submerged drum rotates slowly in a trough of suspended algal particles. The screen is fine mesh that captures only fairly large particles such as algae. As the mesh moves to the top, water spray dislodges the drained particles. When a microstrainer is used to harvest algae, the concentration of harvested algae is still low. Smaller algae can still pass through the screen and are thus not harvested.

Unit costs of microstraining range between \$5 and \$15 per 10⁶ liters, depending on algae size and scale of operation (Benemann et al., 1980). For larger algae, even lower costs may be achieved. Favorable features of microstraining include simple function and construction, simple operation, low investment, negligible wear and tear due to absence of fast-moving mechanical parts, low energy consumption, and high filtration ratios.

Problems encountered with microstrainers include low harvesting efficiency and difficulty in handling particles fluctuations. These problems may be overcome in part by varying the drum rotation speed (Reynolds et al., 1975). Another problem associated with microstraining is the buildup of bacterial and algae biofilm slime on the fabric or mesh. Ultraviolet irradiation, in addition to periodic fabric or mesh cleaning, may help inhibit this biomass growth.

Microstrainers have been widely used in the removal of particles from sewage effluents and in removal of algae from the water supply (Berry, 1961). Successful removal of *Micractinium* from algae ponds has been reported under a condition that growth of unicellular strains of *Scenedesmus* and *Chlorella* does not overcompete the algae to cause deterioration of algae removal (van Vuuren and van Duuren, 1965). Thickening of *Coelastrum proboscideum* to about 1.5% suspended solids by microstrainers was reported when operating at a cost of about DM 0.02/m³ and power consumption of 0.2 kWh/m³ (Mohn, 1980). Some success in clarifying high rate pond effluent with continuous backwashing in microstrainers was achieved (Koopman et al., 1978; Shelef et al., 1980). However, the success was confined to effluent dominated by algae species such as *Micractinium* and *Scenedesmus*, since the smallest mesh available at that time was of 23 µm openings. Greater success has been reported in clarifying stabilization lagoon effluent in reducing suspended solids from up to 80 mg/L to 20 mg/L or less by rotary microstrainers mounted with screens as fine as 1 µm (Wettman and Cravens, 1980).

In a study using microstrainers fitted with 6 µm and 1 µm meshes in clarifying algae pond effluents, the *Francea Micractinium* algae were completely retained by the 6 µm screen, whereas the *Chlorella* algae passed through the 1 µm screen (Shelef et al., 1980). The distinction in algae retention on the screens was evidently due to the difference in size of the algae in each pond. It was noted that although the size of the *Chlorella* algae were larger than 1 µm, they were not retained by the microstrainers. A possible reason could be due to the poor

quality control of mesh size. Continuous operation may overcome part of the problem by building up and maintaining an algal biofilm base layer that serves as a biological fine screen.

5.3.1.2 Vibrating Screens

Vibrating screens are commonly used in industries such as the paper or food industry as a material separating or sorting device. They are also used in municipal wastewater treatment plants to concentrate sludge. Earlier harvesting of *Coelastrum* algae by vibrating screen was reported (Mohn, 1980). Higher algae solids concentration of 7–8% has been harvested under batch operations in comparison with lower algal solids contents of 5–6% when operated in continuous mode. In a study by the Food and Agriculture Organization of the United Nations (Habib et al., 2008), vibrating screens were used for harvesting *Spirulina*, which are multicellular and filamentous blue-green microalgae belonging to two separate genera, *Spirulina* and *Arthrospira*. In the commercial *Spirulina* production as food for humans and domestic animals and fish, vibrating screen filtration used for harvesting achieved very high algal biomass removal efficiency of up to 95% for harvesting up to 20 m³/hour, from which algal slurry of 8–10% biomass solid contents were produced. Compared with the inclining screens counterpart with a filtration area of 2 to 4 m²/unit, the vibrating screens required only one-third of the area.

5.3.2 Coagulation-Flocculation

Use of chemicals to induce *coagulation-flocculation* of algal cells is a routine upstream treatment in various algae-harvesting technologies such as sedimentation (Friedman et al., 1977; Mohn, 1980), flotation (Moraine et al., 1980), filtration (Danquah et al., 2009) and centrifugation (Golueke and Oswald, 1965; Moraine et al., 1980). Coagulation-flocculation causes algal cells to become aggregated into larger clumps, which are more easily filtered and/or settle more rapidly to facilitate harvesting. Chemicals that were used as algal coagulants can be broadly grouped into two categories: inorganic and long-chain organic coagulants.

Inorganic coagulants include metal ions as Al⁺³ and Fe⁺³, which form polyhydroxy complexes at appropriate pH. Hydrated lime is a common coagulant inducer used in water and wastewater treatment. Its use would raise the pH to the point at which a milk-like inorganic compound, magnesium hydroxide, is formed and acts as a coagulant (Folkman and Wachs, 1973; Friedman et al., 1977). Aluminum sulphate (commonly called *alum*, with the chemical formula Al₂(SO₄)₃ · 18 H₂O) or other salts of aluminum, common coagulants used in water treatment, have also been used as coagulants in algae harvesting (Golueke and Oswald, 1965; McGarry, 1970; Moraine et al., 1980). Ferric sulfate was found to be inferior in comparison with alum with respect to the optimal dose, pH, and the quality of the harvested algal paste (Bare et al., 1975; Moraine et al., 1980).

Satisfactory treatment of algal pond effluent has been achieved by lime addition (Folkman and Wachs, 1973; Friedman et al., 1977). However, satisfactory lime treatment was limited to algal cultures containing magnesium above 10 mg/L, and the quality of the harvested product was significantly affected due to excessive calcium content of up to 25% by weight.

Common flocculation theory states that alkaline flocculants neutralize the repelling surface charge of algal cells, allowing them to coalesce into a floc. Based on such electrostatic

flocculation theory, the more cells to be flocculated, the more coagulant would be needed in a linear stoichiometric fashion, rendering flocculation overly expensive. Contrary to this theory of electrostatic flocculation, a study found that the amount of alkaline coagulant needed is a function of the logarithm of cell density, with dense cultures requiring an order of magnitude less base than dilute suspensions, with flocculation occurring at a lower pH (Schlesinger et al., 2012). Various other theories abound that flocculation can be due to multivalent cross-linking or coprecipitation with phosphate or with magnesium and calcium. However, the study revealed that monovalent bases that cannot cross-link or precipitate phosphate work with the same log-linear stoichiometry as the divalent bases, obviating those theories and leaving electrostatic flocculation as the only tenable theory of flocculation with the materials used.

Long-chain organic coagulants or polyelectrolytes could exist as anionic, cationic, and non-ionic synthetic or natural polymeric substances (Stumm and Morgan, 1981). In examining various organic polymers as algal coagulants, it was reported that only the cationic polyelectrolytes were found to be efficient coagulants (Tenney et al., 1969; Tilton et al., 1972; Moraine et al., 1980). Organic cationic polyelectrolytes at low dosages (1–10 mg/L) can induce efficient flocculation of freshwater microalgae (Bilanovic et al., 1988). Effective flocculation was attained at salinity levels lower than 5 g/L. However, the high salinity of the marine environment was found to inhibit flocculation with polyelectrolytes. The reduced effectiveness of cationic polymers to induce microalgae flocculation in high-salinity medium is primarily attributed to the effect of medium ionic strength on the configuration and dimension of the polymer, as indicated by changes in the intrinsic viscosity. At high ionic strength, the polymer shrinks to its smallest dimensions and fails to bridge between algal cells.

Studies also revealed that while anionic polyelectrolytes enhanced lime flocculation, most polyelectrolytes can be used in conjunction with alum or ferric sulfate as coagulant aids to strengthen the flocs, thus enhancing algae harvesting (Friedman et al., 1977). When used as coagulant aids, the polyelectrolytes can be applied at reduced dosages than they would have been used alone. This helps save chemical costs.

Algal coagulation-flocculation mechanisms based on the use of polymeric coagulants were postulated (Tenney et al., 1969; Tilton et al., 1972). Adsorption and the bridging model were hypothesized, and parameters affecting the process were investigated. It was reported that higher molecular weight cationic polyelectrolytes are superior in flocculating algal particles than their lower molecular weight counterparts. Optimal dose decreased with increasing molecular weight. However, very high molecular weight polymers may reverse the algal surface charge, thus stabilizing the suspension (Tilton et al., 1972). The study also pointed out that for a given level of algal flocculation, variations in algal concentrations would affect the polyelectrolyte dosage needed, and the relationship between algal concentration and polyelectrolyte dosage can be established based on stoichiometry (Tenney et al., 1969).

A commercial product called *chitosan*, commonly used for water purification, can also be used as a coagulant but is far more expensive. To create chitosan, the shells of crustaceans are ground into powder and processed to acquire *chitin*, a polysaccharide found in the shells, from which chitosan is derived via deacetylation. Flocculation of three freshwater algae, *Spirulina*, *Oscillatoria*, and *Chlorella*, and one brackish alga, *Synechocystis*, using chitosan was examined (Divakaran and Pillai, 2002). With suspension in the pH range of 4 to 9 and chlorophyll-*a* concentrations in the range of 80 to 800 mg/m³, the chitosan-aided flocculation achieved a clarified water turbidity of 10 to 100 NTU units. The chitosan was found to be

effective in separating the algae by flocculation and settling. It was found that the flocculation efficiency is very sensitive to pH, with optimal pH 7.0 for maximum flocculation of freshwater algal species. The optimal chitosan concentration for maximum flocculation depended on the concentration of algae. Flocculation and settling rates were faster when higher than optimal concentrations of chitosan were used. The settled algal cells were intact and live and could not be redispersed by mechanical agitation. The clarified water may be recycled for fresh cultivation of algae. Studies of harvesting microalgae with chitosan flocculation were also reported (Lavoie and de la Noue, 1983; Morales et al., 1985).

In addition to the type of coagulant, the composition of the algal medium can also influence the optimum flocculation dosage. For lime treatment whereby magnesium hydroxide precipitate is functioning as a coagulant, as discussed earlier, it was found that the higher the dissolved organic substances in the algal suspension, the higher was the concentration of magnesium hydroxide required for good algal flocculation (Folkman and Wachs, 1973). Inhibition of flocculation caused by the presence of dissolved organic matter was also observed in other investigations (Hoyer and Bernhardt, 1980; Narkis and Rebhun, 1981). Conversely, it was found in another study that algal exocellular organic substances reduced the optimal coagulant dose during the early declining growth phase of algal culture but increased the dose during the late growth stages (Tenney et al., 1969). The authors attributed the increased optimal dose to the development of the organic substances into protective colloid.

There are many variables that could affect algal coagulation-flocculation in a collective and complicated manner, rendering predictions for operational conditions almost impossible. Other than algal type, the optimal coagulant dosages can be dictated by the concentrations of phosphate, alkalinity, ammonia, dissolved organic matter, and temperature of the algal medium (Moraine et al., 1980). In practice, optimal coagulant dosages are determined using bench-scale jar tests to simulate the complex coagulation-flocculation process.

Harvesting by chemical flocculation is a method that is often too expensive for large operations. The main disadvantage of this separation method is that the additional chemicals are difficult to remove from the separated algae, probably making it inefficient and uneconomical for commercial use, though it may be practical for personal use. The cost to remove these chemicals may be too expensive to be commercially viable. One way to solve this problem is to interrupt the carbon dioxide supply to the algal system, which would cause algae to flocculate on its own—namely, *autoflocculation*. In some cases this phenomenon is associated with elevated pH due to photosynthetic carbon dioxide consumption corresponding to precipitation of inorganic precipitates (mainly calcium phosphate), which cause the flocculation (Sukenik and Shelef, 1984). In addition to this coprecipitative autoflocculation, the formation of algal aggregates can also be due to excreted organic macromolecules (Benemann et al., 1980), inhibited release of microalgae daughter cells (Malis-Arad et al., 1980), and aggregation between microalgae and bacteria (Kogura et al., 1981).

A fungi pelletization-assisted bioflocculation process for algae harvesting and wastewater treatment was developed (Zhou et al., 2012). Microalga *Chlorella vulgaris* UMN235 and two locally isolated fungal species, *Aspergillus sp.* UMN F01 and UMN F02, were used to study the effect of various cultural conditions on pelletization for fungi–algae complex. The results showed that pH was the key factor affecting formation of fungi–algae pellets, and pH could be controlled by adjusting glucose concentration and the number of added fungal spores.

The best pelletization occurred when adding 20 g/L glucose and approximately 1.2×10^8 /L spores in BG-11 medium, under which almost all of algal cells were captured onto the pellets with shorter retention time. The fungi–algae pellets can be easily harvested by simple filtration due to their large size (2–5 mm). The filtered fungi–algae pellets were reused as immobilized cells for wastewater treatment. It was claimed that the technology developed is highly promising compared with current algae harvesting and biological wastewater treatment technologies in the literature.

5.3.3 Filtration

Filtration is carried out by forcing algal suspension to flow across a filter medium using a suction pump. The algae biomass is retained and concentrated on the medium and is then harvested. The main advantage of filtration is that it is able to harvest microalgae or algal cells of very low density. A pressure drop must be maintained across the medium in order to force fluid to flow through. Depending on the required pressure drop, various filtration methods have been devised with driving force derived from gravity, vacuum, pressure, or magnetic.

Filtration can be categorized either as surface or deep-bed filtration. In *surface filtration*, solids are deposited on the filter medium in the form of a paste or cake. Once an initial thin layer of cake is formed on the medium surfaces as precoat, algal cells are deposited on the precoat, serving as a filter medium per se. As algal deposition grows thicker, the resistance to flow across the medium would increase. The filtration flux would decline for a constant pressure-drop operation. In *deep-bed filtration*, solids are deposited within the filter-bed matrix.

The main problems with using filtration to harvest algae are that the fluid flow is limited to small volumes and by clogging/fouling of the medium by the deposited cells. Several other methods have been devised to avoid filter clogging or membrane fouling. One involves the use of a reverse-flow vacuum in which the pressure operates from above, making the process less vigorous and avoiding algal cell deposition. A second process uses a direct vacuum with a paddle above the filter, providing agitation that prevents the particles from depositing on the medium. Use of a microstrainer as a pretreatment to filtration can reduce clogging and improve algae harvesting. Most filtration operations would include frequent backwashing as a routine maintenance to tackle filter clogging or fouling.

Several filtration methods have been used for algae harvesting with varying degrees of success. The following section discusses various filtration methods that have been used for algae harvesting.

5.3.3.1 Pressure Filtration

Algae can be dewatered and harvested by pressure filtration using either plate-and-frame filter presses or pressure vessels containing filter elements. In plate-and-frame filter press filtration, dewatering is achieved by forcing the fluid from the algal suspension under high pressure. The press consists of a series of rectangular plates with recesses on both sides, which are supported face to face in a vertical position on a frame with a fixed and movable head. A filter cloth is hung or fitted over each plate. The plates are held together with sufficient force to seal them so as to withstand the pressure applied during the filtration process.

In the operation, fluid containing algal suspension is pumped into the space between the plates, and pressure is applied and maintained for several hours, forcing the liquid through the filter cloth and plate outlet ports. The plates are then separated and the dewatered algal cake is harvested. The filtration cycle involves filling the press, maintain the press under pressure, opening the press, washing and discharging the cake, and closing the press. Chemical conditioners such as polyelectrolytes may be used to increase the solids content of the cake.

In filtration by pressure vessel containing filter elements, a number of designs have been devised, such as rotary-drum pressure filters, cylindrical-element filters, vertical tank vertical leaf filters, horizontal tank vertical leaf filters, and horizontal leaf filters. A comparison of the use of different pressure filters for *Coelastrum* harvesting has been investigated (Mohn, 1980). Five different pressure filters—chamber filter press, belt press, pressure-suction filter, cylindrical sieve, and filter basket—were operated. Solids concentrations in the range of 5% to 27% were measured for the harvested algae. Chamber filter press, cylindrical sieve, and filter basket were recommended for algae filtration with respect to energy consideration, reliability, and concentrating capability. A belt filter press was not recommended because of low-density algal cake if filtration was carried out without prior coagulants dosing to the feed. A pressure-suction filter was also not recommended because of low filtration ratio, high investment costs, and unclear operational expenses.

5.3.3.2 Vacuum Filtration

The driving force for vacuum filtration results from the application of suction on the filtrate side of the medium. Although the theoretical pressure drop for vacuum filtration is 100 kPa, it is normally limited to 70 or 80 kPa in actual operation (Shelef et al., 1984). Vacuum filtration can yield algal harvests with moisture contents comparable to those of pressure filtration at lower operating cost if the content of large algal cells in the feed is high.

Five different vacuum filters—vacuum drum filter (not precoated), vacuum drum filter precoated with potato starch, suction filter, belt filter, and filter thickener—have been tested for the harvesting of *Coelastrum* (Mohn, 1980). Suspended-solids content of the harvested algae was in the range of 5–37%. Based on energy consideration, reliability, and dewatering capability, the precoated vacuum drum filter, the suction filter, and the belt filter were recommended. The precoated filter can also be used to harvest tiny microalgae such as *Scenedesmus* (Shelef et al., 1984). The nonprecoated vacuum drum filter was ineffective and not reliable due to clogging problems. The filter thickeners were not recommended because of low solids content (3–7%) of the algal cake, low filtration velocity, high energy demand, and poor reliability.

Dodd and Anderson (1977) were the first to harvest microalgae by a belt filter precoated with eucalyptus and pine-crafts fibers. The use of a precoat was found to cause undesirable operational complexity and increased costs. In another study, fine-weave cloth rather than the precoated filter was investigated (Dodd, 1980). This method required a relatively low energy input and no chemicals were added. It was found to be efficient in harvesting larger species of algae such as *Micractinium*, but it had problems with fouling in smaller algal species such as *Chlorella*. Its capital costs are higher than dissolved-air floatation, but the operating expenditures are the lowest among all harvesting methods with the exception of natural settling (Dodd, 1980).

5.3.3.3 Deep-Bed Filtration

In deep-bed filtration, algae particles are harvested in a depth filter. Smaller than the medium openings, algal particles flow into the medium and are retained within the filter bed. Deep-bed filtration is most often operated as a batch process. When the pressure drop reaches the maximum available, the filter must be taken out of service for backwashing.

Harris et al. (1978) and Reynolds et al. (1974) reported successful separation of algal cells from pond effluent with average solids concentration of 30 mg/L by intermediate sand filtration. The filtration systems, however, rapidly experienced a severe clogging problem and filtration flux dropped drastically.

Intermittent sand filtration was also investigated in a wastewater treatment plant upgrading (Middlebrooks and Marshall, 1974; Marshall and Middlebrooks, 1973). The investigation revealed that only large algal particles can be harvested by separating the dried cake from the surface of the bed. Fine algal particles infiltrated and trapped within the bed could not be efficiently harvested.

5.3.3.4 Cross-Flow Ultrafiltration

A cross-flow ultrafiltration system was adopted for treatment of algae pond effluents to produce thickened algae for animal feed. Up to 20 times of the concentration of the algae had been collected with very high-quality filtered effluent. The main disadvantage of this system is the high energy requirements, which rendered this process uneconomical.

5.3.3.5 Magnetic Filtration

Magnetic filtration was initially used in wastewater treatment for removal of suspended solids and heavy metals (Bitton et al., 1974; Okuda et al., 1975). Magnetic separation using suspended magnetic particles (such as Fe_3O_4 magnetite) was subsequently used in algae removal (Yadidia et al., 1977). Algal cells and the magnetic particles were coagulated, and the fluid was passed through a filter screen encompassed by magnetic field to retain the magnetic precipitates. Algae removal efficiency of between 55% and 94% by a commercial magnetic filter dosed with alum coagulant was reported (Bitton et al., 1974). Higher algae removal (>90%) was achieved using 5–13 mg/L Iron (III) Chloride as primary coagulant and 500–1,200 mg/L magnetite as magnetic particles for pond algal harvesting (Yadidia et al., 1977).

5.3.4 Gravity Sedimentation

Gravity sedimentation is a process of solid-liquid separation that separates a feed suspension into a slurry of higher concentration and an effluent of substantially clear liquid. It is the most common concentration process for sludge treatment at wastewater treatment plants. To remove particles that have reasonable settling velocity from a suspension, gravity sedimentation under free or hindering settling is satisfactory. However, to remove fine particles with a diameter of a few microns and for practicable operation, flocculation should be induced to form larger particles that possess a reasonable settling velocity. The thickened underflow of sludge is withdrawn from the bottom of the tank; the effluent or supernatant overflows a weir and is pumped back to the inlet of the treatment plant.

Gravity sedimentation is used for algae separation where the clarity of the overflow is of primary importance and algal feeds suspension is usually dilute (Mohn and Soeder, 1978; Mohn, 1980; Eisenberg et al., 1981; Venkataraman, 1980; Sukenik and Shelef, 1984) or where a thickening of the underflow and the algae feed slurry is usually more concentrated (Mohn, 1980).

5.3.4.1 Clarification in Simple Sedimentation Tanks or Ponds

There is limited literature on algae sedimentation in ponds without any flocculation process. Isolation of facultative oxidation pond from inflow feed to promote water clarification was investigated (Koopman et al., 1978). Operations involving fill-and-draw cycles for secondary ponds gave rise to significant removal of algae from facultative oxidation pond effluent (Benemann et al., 1980).

Similar secondary ponds were used for algae settling from high rate oxidation pond effluent (Adan and Lee, 1980; Benemann et al., 1980). Well-clarified effluent and algae slurry of up to 3% solids content were achieved at the secondary ponds attributable to algae autoflocculation, which enhanced the settling. The autoflocculation phenomenon is distinctly different from the coprecipitative autoflocculation suggested by Sukenik and Shelef (1984), as discussed earlier. The autoflocculation mechanism involved remained unclear (Eisenberg et al., 1981).

Coagulant dosing to a settling tube to promote algae sedimentation was looked into by Mohn (1980). The batched operation achieved an algal concentration of 1.5% solids content. Algae separation by sedimentation tanks or tubes is considered a simple and inexpensive process. Its concentrating reliability is low without coagulant dosing. Algae autoflocculation may be used as an inexpensive reliable algae separation method. However, the natural flocculation processes should be closely studied and well understood before it can be incorporated for primary concentration.

5.3.4.2 Lamella-Type Sedimentation Tanks

To enhance algae settling, flat inclined plates are incorporated in a settling tank to promote solids contacting and settling along and down the plates. The slopes of plates are designed for the downgliding of the settled algal particles into a sump from which they are removed by pumping (Mohn, 1980; Shelef et al., 1984). Algae were concentrated to 1.6% solids content, and coagulant dosing was suggested if suspension of tiny algae such as *Scenedesmus* is fed to the system (Mohn, 1980). Operational reliability of this method was fair, and further thickening of algae slurry was required.

5.3.4.3 Flocculation-Sedimentation

A process of flocculation followed by gravity sedimentation for algae separation has been studied (Golueke and Oswald, 1965). Treating high rate oxidation pond effluent, the process achieved up to 85% of the algal biomass using alum as a coagulant. The process was found reliable, and various algae species could be separated to achieve an algae slurry of 1.5% solids content. A comparison of the flocculation-sedimentation process with the flocculation-flotation method indicated that the latter exhibited very clear optima operating conditions for algae separation (Friedman et al., 1977; Moraine et al., 1980).

5.3.5 Flotation

An alternative to gravity sedimentation is a process called *flotation*, which is particularly effective for very thin algae suspension. Whereas gravitational separation works best with heavy algae suspension, flotation is used when suspended particles have a settling velocity so low that they are not able to settle in sedimentation tanks. Flotation is simply gravity thickening upside down. Instead of waiting for the sludge particles to settle to the bottom of the tank, liquid-solid separation is brought about by introducing fine air bubbles at the bottom of a flotation tank. The bubbles attach themselves to the particulate matter, and their combined buoyancy encourages the particles to rise to the surface. Once the particles have been floated to the surface, a layer of thickened slurry will be formed and can be collected by a skimming operation. The air-to-solids ratio is probably the most important factor affecting performance of the flotation thickener, which is defined as the weight ratio of air available for flotation to the solids to be floated in the feed stream.

Limited algae biomass is harvested by flotation processes unless coagulant in optimal dose is injected to the algae suspension (Bare et al., 1975). Different coagulants have been used in flotation systems. Chemicals such as aluminum and ferric salts as well as polymers are used to facilitate the flotation. The overall objective is to increase allowable solids loading, percentage of floated solids, and clarity of the effluent.

The principal advantage of flotation over sedimentation is that very small or light algal particles that settle slowly can be harvested in a much shorter time. Flotation systems also offer higher solids concentrations and lower initial equipment cost. There are three basic variations of the flotation thickening system: dissolved-air flotation, electroflotation (also called *electrolytic flotation*), and dispersed-air flotation.

Based on observation of partial natural flotation of algae (van Vuuren and van Duuren, 1965), a full-scale flotation project was carried out (van Vuuren et al., 1965). Subsequently, work on the flocculation-flotation process for clarifying algae pond effluents was conducted (Bare et al., 1975; Moraine et al., 1980; Sandbank et al., 1974).

Other than algae, flotation of other microorganisms (bacteria) was suggested as a classification and separation process. Gaudin et al. (1962) found that *E. coli* may be floated successfully with 4% sodium chloride. Quaternary ammonium salts were used as surface-active agents for effective bacterial flotation (Grieves and Wang, 1966).

5.3.5.1 Dissolved-Air Flotation

In the dissolved-air flotation system, a liquid stream saturated with pressurized air is added to the dissolved-air flotation unit, where it is mixed with the incoming feed. As the pressure returns to atmosphere, the dissolved air comes out of the liquid, forming fine bubbles that bring fine particles with them as they rise to the surface, where they are removed by a skimmer.

The production of fine air bubbles in the dissolved-air flotation process is based on the higher solubility of air in water as pressure increases. Saturation at pressures higher than atmospheric and higher than flotation under atmospheric conditions was examined and used for algae separation (Sandbank, 1979). It was suggested that algae separation by dissolved-air flotation should be operated in conjunction with chemical flocculation (Bare et al., 1975; McGarry and Durrani, 1970). The clarified effluent quality depends on operational parameters

such as recycling rate, air tank pressure, hydraulic retention time, and particle floating rate (Bare et al., 1975; Sandbank 1979), whereas slurry concentration depends on the skimmer speed and its overboard above-water surface (Moraine et al., 1980).

Algae pond effluent containing a wide range of algae species may successfully be clarified by dissolved-air flotation, achieving thickened slurry up to 6%. The solids concentration of harvested slurry could be further increased by a downstream second-stage flotation (Bare et al., 1975; Friedman et al., 1977; Moraine et al., 1980; Viviers and Briers, 1982). High reliability of dissolved-air flotation algae separation can be achieved after optimal operating parameters have been ascertained. Autoflotation of algae by photosynthetically produced dissolved oxygen (DO) following flocculation with alum or C-31 polymer was examined (Koopman and Lincoln, 1983). Algae removal of 80–90%, along with skimmed algal concentrations averaging more than 6% solids, was achieved at liquid overflow rates of up to 2 m/hr. It was reported that the autoflotation was subject to dissolved oxygen concentration. No autoflotation was observed below 16 mg DO/L.

5.3.5.2 Electroflotation

In electroflotation or electrolytic flotation, fine gas bubbles are formed by electrolysis. The formed hydrogen gas attaches to fine algal particles, which float to the surface, where they are removed by a skimmer. Instead of a saturator, a costly rectifier supplying 5–20 DC volts at approximately 11 Amperes per square meter is required. The voltage required to maintain the necessary current density for bubble generation depends on the conductivity of the feed suspension. Further discussion of research on electroflotation is presented in Section 5.3.7.

5.3.5.3 Dispersed-Air Flotation

A variation of dissolved-air flotation is dispersed-air flotation, whereby air is directly introduced to the flotation tank by various means. Large bubbles of about 1 mm are generated by agitation combined with air injection (froth flotation) or by bubbling air through porous media (foam flotation). In froth flotation, the cultivator aerates the water into a froth, then skims the algae from the top. A highly efficient froth-flotation procedure was developed for harvesting algae from dilute suspensions (Levin et al., 1962). The method did not depend on the addition of surfactants. Harvesting was carried out in a long column containing the feed solution, which was aerated from below. A stable column of foam was produced and harvested from a side arm near the top of the column. The cell concentration of the harvest was a function of pH, aeration rate, aerator porosity, feed concentration, and height of foam in the harvesting column. The authors speculated that economic aspects of this process seemed favorable for mass harvesting of algae for food or other purposes.

The removal of algae and attached water using a froth-flotation method as a function of the collector type, aeration rates, the pH of the algal suspension, and temperature of operation was described by Phoochinda et al. (2005). Dispersed-air flotation was used in this study to remove *Scenedesmus quadricauda*. The addition of surfactants such as cetyltrimethylammonium bromide (CTAB) and sodium dodecyl sulfate (SIDS) increased the aeration rates and reduced the size of air bubbles. Only CTAB gave high algal removal (90%), whereas SIDS gave poor algal removal (16%). However, by decreasing the pH values of the algal suspension, it was possible to increase the algal removal efficiency up to 80%. Low-temperature

operation had an important effect on reducing the rate of algal removal, but when the temperature was 20°C or higher, there was little change with further temperature rises.

In a subsequent study, the removal efficiencies of both live and dead algae using the froth-flotation method as a function of the introduction of two types of surfactant, aeration rates, pH, and temperature of operation were compared (Phoochinda et al., 2005). CTAB, a cationic surfactant species, gave comparatively good algal removal efficiency, whereas SIDS, an anionic surfactant species, gave, in comparison, a relatively poor removal efficiency. By decreasing the ambient pH values of the algal suspensions, SIDS gave an increasingly better extent of separation. As the aeration rates were increased, the removal efficiencies of both the live and the dead algae were increased slightly, whereas when the temperature increased from 20–40°C, the removal rates were, more or less, unchanged. In most cases, the removal of the dead algae was greater than that of the live algae. The surface tension of the dead algal suspensions with CTAB was slightly lower than that of the live algal suspensions with CTAB at comparable concentrations, which may facilitate the removal of the dead algae.

Selectivity for air-bubble attachment is based on the relative degree of wetting (wettability), specifying the ability of the algal surface to be wetted when in contact with the liquid. Only particles having a specific affinity for air bubbles would rise to the surface (Svarovsky, 1979). Wettability and frothing are controlled by the following three classes of flotation reagents (Shelef et al., 1984):

1. Frothers, which provide stable froth
2. Collectors (promoters), which are surface-active agents that control the particle surface wettability by varying the contact angle and the particles' electrokinetic properties
3. Modifiers, which are pH regulators

Golueke and Oswald (1965) reported that only 2 out of 18 tested reagents gave satisfactory concentration of algae harvested, with poor algae removal efficiency. In another study, it was reported that algae harvest was primarily controlled by culture pH in the dispersed-air flotation system operated (Levin et al., 1962). Critical pH level was recorded at 4.0, which was attributed to the changes in the algae surface characteristics.

5.3.5.4 Ozone Flotation

An injected air stream containing ozone gas was used in separating microalgae from high rate oxidation pond effluent by ozone flotation. Use of ozone-induced flotation for algae recovery and effluent treatment was studied (Betzer et al., 1980). The ozone gas promotes cell flotation by modification of algae cell wall surface and by releasing some surface active agents from algae cells. The ozone-flotation process has been studied in numerous applications (Jin et al., 2006; Benoufella et al., 1994).

Elimination of a *Microcystis* strain of cyanobacteria (blue-green algae) by the use of ozone flotation was investigated in a pilot study (Benoufella et al., 1994). The oxidizing properties of ozone and the physical aspects of flotation were exploited in the flotation process. A specific ozone utilization rate of *Microcystis* was calculated, and ozone concentration and contact time curves were plotted versus algal removal. The study found that use of ozone in pretreatment leads to an inactivation of the algal cells. A prior coagulation stage was necessary for satisfactory cyanobacteria removal, and use of ferric chloride as a coagulant produced the best performance. Preozonation was also of influence on enhancement of the coagulation

efficiency. Coupling ozone flotation with filtration can improve water quality, with treated effluent indicating low turbidity and low organic content.

5.3.6 Centrifugation

Centrifuges are analogous to sedimentation tanks except that the suspended particles are accelerated in their separation from the suspension by a centrifugal force that is higher than the gravity force. Centrifuges can be grouped into stationery-wall devices (hydrocyclone) or rotating-wall devices (sedimenting centrifuges). Sedimenting centrifuges, more commonly used than hydrocyclones, are bowl-shaped clarifiers with the base wrapped around a center line so that their rotation generates gravitational force of a few thousand times the force of gravity. Suspension is fed into the bowl and rotated. The greater the rotational speed, the more rapidly the solids in the suspension spin out against the rotating bowl wall. Supernatant is removed through a skimming tube or over a weir; solids remain in the bowl (in the case of batch processing) or are constantly or intermittently removed (in the case of continuous operation).

Several centrifugation devices were examined for application in algae separation (Mohn and Soeder, 1978; Mohn, 1980; Moraine et al., 1980; Shelef et al., 1980, 1984). Some of them were very efficient as one-step separation process while others were found either inefficient or required thickened feed slurry. Centrifuges operated in batch mode are less attractive, as their operation has to be stopped for the solids to be released. Although reliability and efficiency of some of the centrifugation methods are high, high operating cost often offset the merits of such devices for algae separation.

The following sections discuss various centrifuge systems used for algae separation. These include hydrocyclone, tubular centrifuge, solid-bowl decanter centrifuge, nozzle-type centrifuge, and solids-ejecting disc centrifuge.

5.3.6.1 Hydrocyclone

A *hydrocyclone* is constructed of a cylindrical section joined to a conical section. Feed is injected tangentially at high speed into the upper cylindrical section, which develops a strong swirling fluid motion. Fluid containing fine particles is discharged through overflow pipe, while the remaining suspension containing coarse particles discharges through the underflow orifice at the cone tip. Application of hydrocyclone for algae harvesting was studied by Mohn (1980). It was reported that only *Coelastrum* algae that grow in large aggregates are harvested by this method. The solid concentration of harvested algae slurry was low, with incomplete solid-liquid separation.

5.3.6.2 Solid-Bowl Decanter Centrifuge

The solid-bowl decanter centrifuge is characterized by a horizontal conical bowl containing a screw conveyor that rotates in the same direction. Feed slurry enters at the center and is spun against the bowl wall. Settled solids are moved by the screw conveyor to one end of the bowl and out of the liquid for drainage before discharge, while separated water forms a concentric inner layer and overflows an adjustable dam plate. The helical screw conveyor pushing the deposited slurry operates at a higher rotational speed than the bowl.

A solid-bowl screw centrifuge was used to separate various types of algae (Mohn, 1980). Fed with an algal suspension of 2% solids, the separated algal slurry was able to attain 22% solids concentrations. Although the reliability of this centrifuge seems to be excellent, the energy consumption is too high. An attempt to concentrate an algae feed of 5.5% solids derived from a flotation process by a co-current solid-bowl decanter centrifuge was not successful (Shelef et al., 1984). Subsequently, algae slurry concentration was improved to 21% TSS by reducing the scroll speed to 5 rpm (Shelef et al., 1984). The solid-bowl decanter centrifuge was recommended for use concurrently with polyelectrolyte coagulant to increase the efficiency.

5.3.6.3 Nozzle-Type Centrifuge

Continuous discharge of solids as a slurry is possible with the nozzle-type disc centrifuge. The shape of the bowl is modified so that the slurry space has a conical section that provides sufficient storage volume and affords a good flow profile for the ejected cake (Shelef et al., 1984). The bowl walls slope toward a peripheral zone containing evenly spaced nozzles. The number and size of the nozzles are optimized to avoid cake buildup and to obtain reasonable concentrated algal biomass.

The application of a nozzle-type disc centrifuge for algae harvesting was suggested by Golueke and Oswald (1965). The influence of nozzle diameter on flow rate, algae removal efficiency, and resultant slurry concentration was looked into. Through comparison with other algae harvesting methods, it was concluded that the nozzle-type centrifuge seemed promising, albeit it is less attractive because of power requirements and capitalization costs. In other studies, the centrifuge appeared to be more effective to harvest *Scenedesmus* than *Coelastrum* (Mohn and Soeder, 1978; Mohn, 1980). By returning the centrifuge underflow to the feed, the solids content of the algae suspension (0.1%) can be concentrated by a factor of 15–150%. The reliability of this device can be ensured as long as the clogging of the nozzles is avoided.

5.3.6.4 Solid-Ejecting Disc Centrifuge

A solid-ejecting disc centrifuge provides intermittent solids ejection by regulating its valve-controlled peripheral ports using a timer or an automatic triggering device. The advantage of this centrifuge for algae harvesting is its ability to produce algal cake in a single step without chemical dosing (Mohn and Soeder, 1978; Mohn, 1980; Shelef et al., 1984). This centrifuge concentrated various types of microalgae effectively, achieving algal cake of 12–25% solids (Mohn, 1980; Moraine et al., 1980). The extent of the algae suspension separation increases with increasing residence time (decreasing feed rate), and the ejected cake concentration is affected by the intervals between successive desludging (Shelef et al., 1984). A solid-ejecting disc centrifuge was found very reliable. The only reported setback was that solids finer than algae may be retained in the overflow, which reduces the separation efficiency (Moraine et al., 1980). High capital and energy costs render this separation method unappealing.

5.3.7 Electrophoresis, Electroflotation, and Electroflocculation Techniques

Electrical approaches to algae dewatering include exploiting electrophoresis, electroflocculation, and electroflotation. An obvious consideration, because algae normally carry a

negative charge, is electrophoresis. In a water solution, however, both electrophoresis and electroflocculation can occur under the same set of circumstances. If a tray of algae in its growth medium were exposed to an electric field by placing metallic electrodes on two sides of the tray and energizing them with a DC voltage, algae concentrations would occur at both electrodes (electrophoresis) and at the bottom of the tray (electrofloculation). A study focused on assessment of the factors influencing electrophoresis and electroflocculation of algae in its growth medium was conducted (Pearsall et al., 2011). The reported experiments show that electrophoresis does occur but is complicated by the effects of the fluid motion. It appears that the coupling of the algal cell and the fluid can be sufficiently strong that fluid motion effects can influence or dominate behavior. Electroflocculation appears to be a robust process (Poelman et al., 1997; Alfafara et al., 2002; Azarian et al., 2007). It does, however, inherently leave electrically induced trace metal flocculants in the dewatered algae.

As mentioned in Section 5.3.5.2, fine gas bubbles formed during the electrolysis, causing the algal particles to float to the surface, where they are skimmed off. An efficient bench-scale electroflotation system for algae flocculation was reported by using the magnesium hydroxide formed in the electrolysis to enable precipitation and, consequently, flocculation (Contreras et al., 1981). Laboratory- and field-scale electroflotation units for algae removal from wastewater oxidation pond effluent were operated (Sandbank et al., 1974; Schwartzburd, 1978; Kumar et al., 1981). A 2 m² pilot-scale unit was tested for clarification of high-rate oxidation pond effluent (Shelef et al., 1984). For satisfactory algae separation, electroflotation is to be followed by or be operated concurrently with alum flocculation (Sandbank et al., 1974).

A wide range of microalgae species were harvested by electroflotation with up to 5% solids in the harvested algae. Decantation after one day further increased the solids concentration to 7–8% (Sandbank, 1979). The energy needs of the electroflotation process are generally high, but for small units (<5 m² area) electricflotation operating costs are less than those of dissolved-air flotation units (Svarovsky, 1979).

5.3.8 Ultrasonic Methods

Successful application of ultrasound technique to harvest microalgae has been reported in a laboratory-scale study (Bosma et al., 2003). An algae separation process based on acoustically induced aggregation followed by enhanced sedimentation was carried out. The efficiency of algae harvesting and the concentration factor of the feed algal biomass concentration were optimized. Efficiency of the separation process was modeled with a satisfactory *R*-squared value of 0.88. The study found that feed-flow rate and algal biomass concentration would significantly influence the process efficiency. Efficiencies higher than 90% were recorded at high biomass concentrations and flow rates between 4 and 6 L/day. As much as 92% of the algae biomass could be harvested, and a concentration factor of 11 could be achieved at these settings. Attempts to harvest at higher efficiency were unfruitful due to small size and low particle density of the microalgae. Feed-flow rate, biomass concentration, and ratio between harvest and feed flows had a significant effect on the concentration factor. Highest concentration factors up to 20 could be reached at low biomass concentrations and low harvest flow rates.

The study claimed that on lab or pilot scale, ultrasonic harvesting has the advantage that, in addition to small footprint, the process can be operated continuously without evoking hydrodynamic shear stress on algal cells, thus maintaining integrity of the algae. Moreover, the system can function as a biofilter when the algae excrete a soluble, high-value product. However, comparing ultrasonic with other harvesting processes, the authors pointed out that on an industrial scale, microalgae-harvesting centrifuges can be better used over the ultrasound aggregation-sedimentation process because of lower energy requirements, better algae separation efficiencies, and higher concentration factors.

Use of ultrasound to improve the removal by coagulation of *Microcystis aeruginosa*, a common species of toxic algae, was investigated (Zhang et al., 2009). The results show that sonication significantly enhances the reduction of algae cells, solution UV254, and chlorophyll-a without increasing the concentration of aqueous microcystins. The main mechanism involved the destruction during ultrasonic irradiation of gas vacuoles inside algae cells that acted as “nuclei” for acoustic cavitation and collapse during the “bubble crush” period, resulting in the settlement of cyanobacteria. The investigation revealed that coagulation efficiency depended strongly on the coagulant dose and sonication conditions. With a coagulant dose of 0.5 mg/L and ultrasonic irradiation for 5 seconds, algae removal efficiency increased from 35% to 67%. Optimal sonication time was determined at 5 seconds, since further sonication would only marginally enhance the coagulation efficiency. The most effective sonication intensity was found to be at 47.2 W/cm², and the highest removal of the algae was recorded at 93.5%. Supported with experimentation on reservoir water, the authors recommended that this method could be successfully applied to natural water containing multiple species of algae.

5.4 CHALLENGES AND PROSPECTS

Biofuel derived from algae is currently a hotly debated topic because its production is one of the more costly processes, which can dictate the sustainability of algae-based biofuel products. There are two major energy and cost constraints to bulk production of microalgae for biofuels: expensive culture systems with high capital costs and high energy requirements for mixing and gas exchange, and the cost of harvesting in achieving feasible algal solids concentration.

Because of the dilute algal suspension, the cost of harvesting microalgal biomass accounts for a significant portion of the overall production cost of microalgal biofuels. Certainly, energy-efficient and cost-effective harvesting are two major challenges in the commercialization of biofuels from algae (Dismukes et al., 2008; Reijnders, 2008). The algae must be concentrated by removing water in an economically viable fashion before further processing such as drying and oil extraction. The lack of cost-effective methodologies for harvesting has been one of the major hurdles for the economic production of algal biofuels, along with challenges associated with variability of microalgae species (e.g., cell size, robustness, surface charge, culture medium constituent, and desired end-product) (Cooney et al., 2009). An effective microalgae separation process should be workable for all microalgae strains, yield a product with a high dry biomass weight, and require moderate cost of operation, energy, and maintenance.

Microalgae harvesting can be a considerable problem because of the small size (3–30 micrometers in diameter) and the stable suspended state of unicellular algal cells. Since the mass fractions in a culture broth are low (typically less than 0.5 kg/m³ dry biomass in some commercial production systems), large volumes of culture need to be processed in order to recover biomass in a feasible quantity (Cooney et al., 2009; Ramanan et al., 2010). In addition, microalgae harvesting is a major bottleneck to microalgae bioprocess engineering owing to its high operating cost, thus reducing the cost of microalgae harvesting is vital. If microalgae can be concentrated about 30–50 times by coagulation–flocculation and gravity sedimentation prior to dewatering, the energy demand for microalgae harvesting could be significantly reduced (Jorquera et al., 2010).

In comparing algae removal using filtration, flotation, centrifugation, precipitation, ion exchange, passage through a charged zone, and ultrasonic vibration, it was concluded that only centrifugation and precipitation can be economically feasible, with centrifugation being marginal (Golueke and Oswald, 1965). In another study examining three different techniques of harvesting microalgae involving centrifugation, chemical flocculation followed by flotation, and continuous filtration with a fine-weave belt filter, it was reported that centrifugation gave good recovery and a thickened slurry but required high capital investment and energy inputs (Sim et al., 1988). Dissolved-air flotation was more economical, but, if the recovered algae were to be incorporated into animal feed, the use of coagulants such as alum could have undesirable effects on the growth rate of the animals. This problem could be overcome by the use of nontoxic coagulants. The continuous filtration process had significant advantages in terms of energy efficiency, economics, and chemical-free operation. The only drawback of this process was that the efficiency depended on the size and morphology of the algae.

Most of the algae-harvesting techniques present several disadvantages, not only because of the high costs of operation but also due to the frequently low separation efficiencies and the intolerable product quality. Algae separation processes such as sedimentation, centrifugation, and filtration involve the use of equipment that could result in deterioration in algal quality due to cell rupture that causes leakage of cell content. Furthermore, in the case of flocculation, the high concentration of metal salts, which is normally used as the coagulant, can have a negative effect on the quality of the final product, as discussed previously (Kim et al., 2005).

High production yields of microalgae have called forth interest due to economic and scientific factors, but it is still unclear whether the production of biodiesel is environmentally sustainable and which transformation steps need further adjustment and optimization. A comparative life-cycle assessment (LCA) of a virtual facility has been undertaken to assess the energetic balance and the potential environmental impacts of the whole process chain, from biomass production to biodiesel combustion (Lardon et al., 2009). The outcome validated the potential of microalgae as an energy source but highlighted the imperative necessity of decreasing the energy and fertilizer requirements.

From another comparative LCA study to compare biodiesel production from algae with canola and ultra-low sulfur diesel with respect to greenhouse gas emissions and costs, it was concluded that the need for a high production rate is a vital key to make algal biodiesel economically attractive (Campbell et al., 2011). In a separate study, it was concluded that the potential greenhouse gas emissions from microalgae operational activities are likely to be

outweighed by the emission reductions associated with the production efficiency and sequestration potential of microalgae (Williams and Laurens, 2010).

Some commercial interests in large-scale algal-cultivation systems are looking to tie into existing infrastructures, such as coal-fired power plants or sewage treatment facilities. Wastes generated from those infrastructures, such as flue gas (carbon dioxide) and wastewater nutrients (nitrogen, phosphorous and other micronutrients), can be converted into raw material resources for algal cultivation. While use of carbon dioxide for algal photosynthesis would help attain carbon sequestration, uptake of waste nutrients for algal growth would eliminate use of fertilizers derived from fossil-fuel energy, thus mitigating emissions.

In essence, algal biofuel is currently more expensive than other fuel options, but it is likely to play a major role in the economy in the long run if technology improvements succeed in bringing down costs. The main challenges are to decrease the energy and fertilizer requirements and to accomplish high production rates in order to make algal bio-diesel economically attractive. The potential of anaerobic digestion of waste oilcakes from oil extraction as a way to reduce external energy demand and to recycle part of the mineral fertilizers is to be further explored (Lardon et al., 2009). Algal biofuel production employing renewable substrates may be a potential answer to overcome some of the economic constraints. There is scope to use certain wastewater effluents containing waste nutrients as cultivation broth. Therefore, production as well as unit energy cost of algal biofuel would be reduced.

A rigorous techno-economic analysis is necessary to draw a clearer prospect comparison between algal biofuel and the various other conventional fossil fuels. In addition to benefits that can be quantified from the use of biofuel for clean energy production, intangible benefits such as flue gas carbon dioxide sequestration, uptake of waste nutrients in place of fertilizers, and biogas energy produced from anaerobic digestion of oilcake should also be considered. These benefits would render a potential for claims of certified emission reductions (CERs) under the Kyoto Protocol for reducing emissions that can be estimated through a holistic LCA of algal biofuel production. The potential for claims of CERs to generate revenue and to finance algal biofuel projects under the Kyoto Protocol for reducing emissions of greenhouse gases appears to be promising. In view of the prospects of technology development and global carbon trading, it may not be an unreasonable expectation that, in the future, algal biofuel will experience a global shift toward employment of energy-efficient algae biofuel production while mitigating greenhouse gas emissions.

5.5 CONCLUSIONS

Algal biofuel is believed to be one of the biofuels for the future in view of its potential to replace depleting fossil fuels. The future role of algal biofuel as a clean fuel producing near-zero emissions and as an energy carrier is increasingly recognized worldwide. Because energy-efficient and cost-effective harvesting are two major hurdles in the commercialization of biofuels from algae, research addressing these challenges should be intensified. Knowledge exchange and cooperation between expert groups of various disciplines should be strengthened in order to leapfrog technological development for algal biofuel.

References

- Adan, B., Lee, E.W., 1980. High rate algae growth pond under tropical conditions. Presented at a workshop on waste treatment and nutrient recovery. Singapore, 27–29 February 1980.
- Alfajara, C.G., Nakano, K., Nomura, N., Igarashi, T., Matsumura, M., 2002. Operating and scale-up factors for the electrolytic removal of algae from eutrophied lakewater. *J. Chem. Technol. Biotechnol.* 77, 871–876.
- Azarian, G.H., Mesdaghinia, A.R., Vaezi, F., Nabizadeh, R., Nematollahi, D., 2007. Algae removal by electrocoagulation process, application for treatment of the effluent from an industrial wastewater treatment plant. *Iran J. Public Health* 36, 57–64.
- Bare, W.F.R., Jones, N.B., Middlebrook, E.J., 1975. Algae removal using dissolved-air flotation. *J. Water Pollut. Control Fed.* 47, 153–169.
- Benemann, J.R., Kopman, B.L., Weismsman, D.E., Eisenverg, D.E., Goebel, R.P., 1980. Development of microalgae harvesting and high rate ponds technologies in California. In: Shelef, B., Solder, C.J. (Eds.), *Algae Biomass*. Elsevier, Amsterdam, p. 457.
- Benoufella, F., Laplanche, A., Boisdon, V., Bourbigot, M.M., 1994. Elimination of microcystis cyanobacteria (blue-green algae) by an ozoflotation process – a pilot-plant study. *Water Sci. Technol.* 30, 245–257.
- Berry, A.E., 1961. Removal of algae by microfilters. *J. Am. Water Works Assoc.* 53, 1503–1508.
- Betzer, N., Argaman, Y., Kott, Y., 1980. Effluent treatment and algae recovery by ozone-induced flotation. *Water Res.* 14, 1003–1009.
- Bilanovic, D., Shelef, G., Sukenik, A., 1988. Flocculation of microalgae with cationic polymers: effects of medium salinity. *Biomass* 17, 65–76.
- Bitton, G., Mitchell, R., De Latour, C., Maxwell, E., 1974. Phosphate Removal by magnetic filtration. *Water Res.* 8, 107–109.
- Bosma, R., van Spronsen, W.A., Tramper, J., Wijffels, R.H., 2003. Ultrasound - a new separation technique to harvest microalgae. *J. Appl. Phycol.* 15, 143–153.
- Campbell, P.K., Beer, T., Batten, D., 2011. Life-cycle assessment of biodiesel production from microalgae in ponds. *Bioresour. Technol.* 102, 50–56.
- Chen, L., Li, P.F., Liu, Z.L., Jiao, Q.C., 2009. The released polysaccharide of the cyanobacterium *Aphanothece halophytica* inhibits flocculation of the algae with ferric chloride. *J. Appl. Phycol.* 21, 327–331.
- Chen, C.Y., Yeh, K.L., Aisyah, R., Lee, D.J., Chang, J.S., 2011. Cultivation, photobioreactor design and harvesting of microalgae for biodiesel production: A critical review. *Bioresour. Technol.* 102, 71–81.
- Chheda, P., Grasso, D., 1994. Surface thermodynamics of ozone-induced particle destabilization. *Langmuir* 10, 1044–1053.
- Chheda, P., Grasso, D., van Oss, C.J., 1992. Impact of ozone on stability of montmorillonite suspensions. *J. Colloid Interface Sci.* 153, 226–236.
- Chisti, Y., 2007. Biodiesel from microalgae. *Biotechnol. Adv.* 25, 294–306.
- Contreras, S., Pieber, M., del Rio, A., Soto, M.A., Toha, J., Veloz, A., 1981. A highly efficient electrolytic method for microalgae flocculation from aqueous cultures. *Biotechnol. Bioeng.* 23, 1165–1168.
- Conway, K., Trainer, F.R., 1972. *Scenedesmus* morphology and flotation. *J. Phycol.* 8, 138–143.
- Cooney, M., Young, G., Nagle, N., 2009. Extraction of bio-oils from microalgae. *Separ. Purif. Rev.* 38, 219–325.
- Danquah, M.K., Ang, L., Uduman, N., Moheimani, N., Forde, G.M., 2009. Dewatering of microbial culture for biodiesel production: exploring polymer flocculation and tangential flow filtration. *J. Chem. Technol. Biotechnol.* 84, 1078–1083.
- Dismukes, G.C., Carrieri, D., Bennette, N., Ananyev, G.M., Posewitz, M.C., 2008. Aquatic phototrophs: efficient alternatives to land-based crops for biofuels. *Curr. Opin. Biotechnol.* 19, 235–240.
- Divakaran, R., Pillai, V.N.S., 2002. Flocculation of algae using chitosan. *J. Appl. Phycol.* 14, 419–422.
- Dodd, J.C., 1980. Harvesting algae grown on pig wastes in Singapore. Paper presented at a Workshop on High Rate Algae Ponds held in Singapore, 1980.
- Dodd, J.C., Anderson, J.L., 1977. An integrated high-rate pond-algae harvesting system. *Progr. Water Technol.* 9, 713–726.
- Eisenberg, D.M., Koopman, B., Benemann, J.R., Oswald, W.J., 1981. Algal bioflocculation and energy conservation in microalgal sewage ponds. *Biotechnol. Bioeng. Symp.* 11, 429–448.
- Farvardin, M.R., Collins, A.G., 1989. Preozonation as an aid in the coagulation of humic substances-optimum preozonation dose. *Water Res.* 23, 307–3136.

- Fogg, G.E., 1975. Algal cultures and phytoplankton ecology, second ed. Univ. Wisconsin Press, Madison, Wisconsin.
- Folkman, Y., Wachs, A.M., 1973. Removal of algae from stabilization pond effluent by lime treatment. *Water Res.* 7, 419–435.
- Friedman, A.A., Peaks, D.A., Nichols, R.L., 1977. Algae separation from oxidation pond effluents. *J. Water Pollut. Control Fed.* 49, 111–119.
- Gaudin, A.M., Davis, N.S., Bangs, S.E., 1962. Flotation of *Escherichia coli* with sodium chloride. *Biotechnol. Bioeng.* 4, 211–222.
- Golueke, C.G., Oswald, W.J., 1965. Harvesting and processing sewage grown planktonic algae. *J. Water Pollut. Control Fed.* 37, 471–498.
- Golueke, C.G., Oswald, W.J., 1970. Surface properties and ion exchange in algae removal. *J. Water Pollut. Control Fed.* 42, R304.
- Gregory, J., 1977. Effect of polymers on colloid stability. In: *Proc. of the NATO Adv. Study on the Scientific Basis of Flocculation*, Cambridge, England, p. 1.
- Grieves, R.B., Wang, S., 1966. Foam separation of *Escherichia coli* with cationic surfactants. *Biotechnol. Bioeng.* 8, 323–336.
- Gudin, C., Therpenier, C., 1986. Bioconversion of solar energy into organic chemicals by microalgae. *Adv. Biotechnol. Processes* 6, 141–151.
- Habib, M.A., Parvin, M., Huntington, T.C., Hasan, M.R., 2008. A review on culture, production and use of spirulina as food for humans and needs for domestic animals and fish. *FAO Fisheries and Aquaculture Circular No. 1034*, Food and Agriculture Organization of the United Nations, FAO Fisheries and Aquaculture Department Rome, Italy.
- Harris, S.E., Felip, D.S., Reynolds, J.H., Middlebrooks, E.J., 1978. Separation of Algae Cells from wastewater lagoon effluents. Vol I: Intermittent Sand Filtration to upgrade waste stabilization lagoon effluent. Report EPA 66/2-78-033 Utah Water Res. Lab, Logan.
- Henderson, R.K., Baker, A., Parsons, S.A., Jefferson, B., 2008. Characterization of algogenic organic matter extracted from cyanobacteria, green algae and diatoms. *Water Res.* 42, 3435–3445.
- Henderson, R.K., Parson, S.A., Jefferson, B., 2009. The potential for using bubble modification chemicals in dissolved-air flotation algae removal. *Sep. Sci. Technol.* 44, 1923–1940.
- Hoyer, U., Bernhardt, H., 1980. Eliminierung organischer Substanzen aus Talsperrenwasser Durch Floccenfiltration. *Wasser* 55, 33–46.
- Hutchinson, G.E., 1967. *A Treatise on Limnology*. John Wiley & Sons Inc., New York, NY, USA.
- Ives, K.J., 1959. The significance of surface electric charge on algae in water purification. *J. Biochem. Microbiol. Tech. Engr.* 1, 37–47.
- Jin, P.K., Wang, X.C., Hu, G., 2006. A dispersed-ozone flotation (DOF) separator for tertiary wastewater treatment. *Water Sci. Technol.* 53, 151–157.
- Jorquera, O., Kiperstok, A., Sales, E.A., Embirucu, M., Ghirardi, M.L., 2010. Comparative energy life-cycle analyses of microalgal biomass production in open ponds and photobioreactors. *Bioresour. Technol.* 101, 1406–1413.
- Kim, S.G., Choi, A., Ahn, C.Y., Park, C.S., Park, Y.H., Oh, H.M., 2005. Harvesting of *Spirulina platensis* by cellular flocculation and growth stage determination. *Lett. Appl. Microbiol.* 40, 190–194.
- Kogura, K., Simidu, U., Tagu, N., 1981. Bacterial attachment to phytoplankton in seawater. *J. Exp. Marine Biol. Ecol.* 5, 197–204.
- Koopman, B.L., Lincoln, E.P., 1983. Autoflotation of algae from high rate pond effluent. *Aquacul Waste* 5, 231–246.
- Koopman, B.L., Thomson, R., Yackzan, R., Benemann, J.R., Oswald, W.J., 1978. Investigation of the pond isolation process for microalgae separation from woodlands waste pond effluents. Final Report, U.C. Berkeley, USA.
- Kumar, H.D., Yadava, P.K., Gaur, J.P., 1981. Electrical flocculation of the unicellular green algae *Chlorella vulgaris*. *Aquacul Bot.* 11, 187–195.
- Lardon, L., Helias, A., Sialve, B., Steyer, J.P., Bernard, O., 2009. Life-cycle assessment of biodiesel production from microalgae. *Environ. Sci. Technol.* 43, 6475–6481.
- Lavoie, A., de la Noue, J., 1983. Harvesting microalgae with chitosan. *J. World Maricul. Soc.* 14, 685–694.
- Levin, G.V., Clendinning, J.R., Gibor, A., Bogar, F.D., 1962. Harvesting of algae by froth flotation. *Appl. Microbiol.* 10, 169–175.
- Malis-Arad, S., Friedlander, M., Ben-Arie, R., Richmond, A.E., 1980. Alkalinity-induced aggregation in *Chlorella vulgaris*. 1. Change in cell volume and cell wall structure. *Plant Cell Physiol* 21, 27–35.

- Marshall, G.R., Middlebrooks, E.J., 1973. Upgrading of wastewater lagoon effluent with intermittent sand filtration. Utah, Water Res. Lab., Utah State Univ, Logan.
- Mata, T.M., Martins, A.A., Caetano, N.S., 2010. Microalgae for biodiesel production and other applications: A review. *Renew Sustain Energy Rev.* 14, 217–232.
- McGarry, M.G., 1970. Algae flocculation with aluminium sulphate and polyelectrolytes. *J. Water Pollut. Control Fed.* 42, R191.
- McGarry, M.G., Durrani, S.M.A., 1970. Flotation as a method of harvesting algae from ponds. Research program report No.5. Asian Institute of Technology, Bangkok, Thailand.
- Middlebrooks, E.J., Marshall, G.R. (Eds.), 1974. Upgrading wastewater stabilization ponds to meet new discharge requirements. Utah, Water Res. Lab., Utah State Univ, Logan PRwF 159–1.
- Reynolds, J.H., Middlebrooks, E.J., Porcella, D.B., Grenney, W.J., 1975. Effects of temperature on oil refinery waste toxicity. *J. Water Pollut. Control Fed.* 47, 2674–2693.
- Mohn, F.H., 1980. Experiences and Strategies in the Recovery of Biomass from Mass Cultures of Microalgae. In: Shelef, B., Solder, C.J. (Eds.), *Algae Biomass*. Elsevier, Amsterdam, pp. 547–571.
- Mohn, F.H., Soeder, C.J., 1978. Improved technologies for harvesting and processing of microalgae and their impact on production costs. *Arch. Hydrobiol. Bech. Ergebn. Lemnol.* 11, 228–253.
- Moraine, R., Shelef, G., Sandbank, E., Bar Moshe, Z., Schwarbard, L., 1980. Recovery of sewage borne algae: Flocculation and centrifugation techniques. In: Shelef, G., Solder, C.J. (Eds.), *Algae Biomass*. Elsevier, North Holland.
- Morales, J., de la Noue, J., Picard, G., 1985. Harvesting marine microalgae species by chitosan flocculation. *Aquacul Eng.* 4, 257–270.
- Moroney, J.V., Ynalvez, R.A., 2009. *Algal Photosynthesis*. eLS. John Wiley & Sons. DOI:10.1002/9780470015902.a0000322.pub2.
- Narkis, N., Rebhun, M., 1981. Inhibition of flocculation processes in systems containing organic matter. In: *Proc. Water Pollut. Control Fed. Annual Conf. Detroit, Michigan, USA*.
- Okuda, T., Sugano, I., Tsuji, T., 1975. Removal of heavy metals by ferrite coprecipitation technique. *Filtr. Separ.* 12, 472.
- Paerl, H.W., Ustach, J.F., 1982. Blue green algae scums: An explanation for their occurrence during freshwater blooms. *Limnol. Oceanogr.* 27, 212–217.
- Pearsall, R.V., Connelly, R.L., Fountain, M.E., Hearn, C.S., Werst, M.D., Hebner, R.E., et al., 2011. Electrically dewatering microalgae. *IEEE Trans. Dielectrics Electric Insulation* 18, 1578–1583.
- Phoochinda, W., White, D.A., Briscoe, B.J., 2005. Comparison between the removal of live and dead algae using froth flotation. *J. Water SRT-AQUA* 54, 115–125.
- Plummer, J.D., Edzwald, J.K., 2002. Effects of chlorine and ozone on algal cell properties and removal of algae by coagulation. *J. Water SRT-Aqua* 51, 307–318.
- Poelman, E., De Pauw, N., Jeurissen, B., 1997. Potential of electrolytic flocculation for recovery of micro-algae. *Resources, Conservation and Recycling* 19, 1–10.
- Ramanan, R., Kannan, K., Deshkar, A., Yadav, R., Chakrabarti, T., 2010. Enhanced algal CO₂ sequestration through calcite deposition by *Chlorella* sp. and *Spirulina platensis* in a mini-raceway pond. *Bioresour. Technol.* 101, 2616–2622.
- Reckhow, D., Singer, P., Trussel, R.R., 1986. Ozone as a coagulant aid. In: *Ozonation: Recent Advances and Research Needs*. AWWA Seminar Proc. No. 20005, Am. Water Works Assoc, Denver, CO, pp. 17–46.
- Reijnders, L., 2008. Do biofuels from microalgae beat biofuels from terrestrial plant? *Trends Biotechnol.* 26, 349–350.
- Reinolds, J.H., Harris, S.E., Hill, D., Felip, D.S., Middlebrooks, E.J., 1974. Intermittent sand filtration to upgrade lagoons effluent. Preliminary report in *Upgrading Wastewater Stabilization Ponds to meet new Discharge Standards by Middlebrooks*. E.J. et al. Utah Water Res, Lab, Logan.
- Sandbank, E., 1979. Harvesting of microalgae from wastewater stabilization pond effluents and their utilization as a fish feed. D.Sc. thesis presented to the senate of the Technion, Israel Institute of Technology.
- Sandbank, E., Shelef, G., Wachs, A.M., 1974. Improved electroflotation for the removal of suspended solids from algae pond effluents. *Water Res.* 8, 587–592.
- Schlesinger, A., Eisenstadt, D., Bar-Gil, A., Carmely, H., Einbinder, S., Gressel, J., 2012. Inexpensive non-toxic flocculation and microalgae contradicts theories; overcoming a major hurdle to bulk algal production. *Biotechnol. Adv* (in press <http://dx.doi.org/10.1016/j.biotechadv.2012.01.011>).
- Schwartzburd, L., 1978. Polyelectrolytes use for clarification of high rate oxidation pond effluents. M.Sc. thesis submitted to senate of the Technion, Israel Institute of Technology.

- Shelef, G., Azov, Y., Moraine, R., Oron, G., 1980. Algae mass production as an integral part of a wastewater treatment and reclamation system. In: Shelef, B., Solder, C.J. (Eds.), *Algae Biomass*. Elsevier, North Holland.
- Shelef, G., Sukenik, A., Green, M., 1984. Microalgae harvesting and processing: A literature review. Report prepared for the US Department of Energy, Technion Research and Development Foundation Ltd, Haifa, Israel.
- Sim, T.S., Goh, A., Becker, E.W., 1988. Comparison of centrifugation, dissolved-air flotation and drum filtration techniques for harvesting sewage-grown algae. *Biomass* 16, 51–62.
- Stumm, W., Morgan, J.J., 1981. *Aquatic Chemistry*. Wiley Interscience, New York, NY, USA.
- Sukenik, A., Shelef, G., 1984. Algal autoflocculation—verification and proposed mechanism. *Biotechnol. Bioeng.* 26, 142–147.
- Svarovsky, L., 1979. *Advanced in solid-liquid separation II sedimentation, centrifugation and flotation*. Chem. Eng. 16, 43–105.
- Tenney, M.W., Echelberger, W.F., Schuessler, R.G., Pavpni, J.L., 1969. Algal flocculation with synthetic organic polyelectrolytes. *Appl. Bacteriol.* 18, 965–971.
- Tilton, R.C., Murphy, J., Dixon, J.K., 1972. The flocculation of algae with synthetic polymeric flocculants. *Water Res.* 6, 155–164.
- van Vuuren, L.R.J., van Duuren, F.A., 1965. Removal of algae from wastewater maturation pond effluent. *J. Water Pollut. Control Fed.* 37, 1256–1262.
- van Vuuren, L.R.J., Meiring, P.G.J., Henzen, M.R., Koble, F.F., 1965. The flotation of algae in water clamation. *Int. J. Air Water Pollut.* 9, 823–832.
- Venkataraman, L.V., 1980. Algae as food/feed. *Systems*. India Society of Biotechnology. Proc. dat. work. HT India, p. 83.
- Viviers, J.M.P., Briers, J.H., 1982. Harvesting of algae grown on raw sewage. *Water SA* 8, 178–186.
- Wang, B., Li, Y., Wu, N., Lan, C.Q., 2008. CO₂ bio-mitigation using microalgae. *Appl. Microbiol. Biotechnol.* 79, 707–718.
- Wettman, J.W., Cravens, J.B., 1980. Cost Effective Lagoon Upgrading with Microscreens. In: Proc. the 3rd Ann. Poll. Cont. Assoc. Oklahoma, USA June 5.
- Yadidia, R., AbeIiovich, A., Belfort, G., 1977. Algae removal by high gradient magnetic filtration. *Environ. Sci. Technol.* 11, 913–916.
- Williams, P.J., Laurens, L.M., 2010. Microalgae as biodiesel and biomass feedstocks: Review and analysis of the biochemistry, energetics and economics. *Energy Environ. Sci.* 3, 554–590.
- Zhang, G.M., Zhang, P.Y., Fan, M.H., 2009. Ultrasound-enhanced coagulation for *Microcystis aeruginosa* removal. *Ultrason. Sonochem.* 16, 334–338.
- Zhou, W., Cheng, Y., Li, Y., Wan, Y., Liu, Y., Lin, X., et al., 2012. Novel fungal pelletization-assisted technology for algae harvesting and wastewater treatment. *Appl. Biochem. Biotechnol* (in press DOI:10.1007/s12010-012-9667-y).

Heterotrophic Production of Algal Oils

*Jin Liu*¹, *Zheng Sun*², *Feng Chen*³

¹Institute of Marine and Environmental Technology, University of Maryland Center for Environmental Science, Baltimore, MD, USA

²School of Energy and Environment, City University of Hong Kong, China

³Institute for Food & Bioresource Engineering, College of Engineering, Peking University, Beijing, China

6.1 INTRODUCTION

Petroleum fuels are recognized as unsustainable due to their depleting supplies and release of greenhouse gas (Chisti, 2008). Renewable biofuels are promising alternatives to petroleum and have attracted unprecedentedly increasing attention in recent years (Hu et al., 2008). Compared with traditional fuels, the carbon-neutral biodiesel releases less gaseous pollutants and is considered environmentally beneficial. Currently biodiesel is mainly produced from vegetable oils, animal fats, and waste cooking oils. Plant oil-derived biodiesel, however, cannot realistically meet the existing need for transport fuels, because immense amounts of arable land have to be occupied to cultivate oil crops, causing a fuel-versus-food conflict (Chisti, 2007). Because of their fast growth and lipid abundance, microalgae have been considered the promising alternative feedstock for biofuel production, and their potential has been widely reported by many researchers in recent years (Chisti, 2007, 2008; Hu et al., 2008; Mata et al., 2010; Liu et al., 2011a).

Mass cultivation of microalgae started almost concurrently in United States, Germany, and Japan in the late 1940s (Burlew, 1964). From then on, the mass culture of algae became one of the hottest topics in algal biotechnology, and increasingly improved culture systems have been developed (Hu et al., 1996; Lin, 2005; Chisti, 2007; Masojidek et al., 2011). Nowadays the most common procedure for mass culture is autotrophic growth in open ponds, where the microalgae are cultured under conditions identical to the external environment. Circular

ponds are the most common device for the large-scale commercial production of *Chlorella* (Lin, 2005). Circular ponds were first built in Japan and then introduced to Taiwan and now are widely adopted in Asia. The size of circular ponds may range from 30 to 50 m in diameter, and a rotating agitator provides culture mixing.

Raceway ponds are another popular open culture device for mass culture of *Chlorella*. They are made from poured concrete or simply dug into the earth covered with a plastic liner and are either set as individual units or arranged as a meandering channel assembled by multiple individual raceways. The culture usually is 20–30 cm in depth and circulated by a motorized paddlewheel.

Although the open pond systems cost less to build and operate and are more durable, with a large production capacity compared to a more sophisticated closed photobioreactor (PBR) design, they have substantial intrinsic disadvantages, including difficulties in managing culture temperature, insufficiency of CO₂ delivery, poor light availability on a per-cell basis, rapid water loss due to evaporation, susceptibility to microbial contamination, poor growth, low cell concentration, and consequently high cost for biomass harvest.

To overcome the inherent limitations associated with open pond systems, closed PBRs of various geometries and configurations were adopted for mass cultivation of microalgae. A popular PBR is a tubular design that is made of clear transparent tubes of a few centimeters in diameter and arranged in various configurations, e.g., a serpentine shape placed above the ground, multiple tubes running in parallel and connected by a manifold structure, α -type cross tubes at an angle with horizontal, or coiled tubes helically around a supporting frame (Lee et al., 1995; Borowitzka, 1999).

Flat plate PBR is another type of PBR design that may be arranged either vertically or inclined to the ground (Tredici et al., 1991; Hu et al., 1996, 1998; Zhang and Richmond, 2003). Although capable of producing much higher cell densities than open ponds, they proved difficult to scale up, and the capital in infrastructure and continuous maintenance may be high. In addition, the light limitation and oxygen accumulation associated with the buildup of cells in PBRs are problematic issues that remain to be resolved.

Due to the significant characteristics such as fast growth, ultrahigh cell density, and high oil productivity associated with heterotrophic algae, heterotrophic production of algal oils has received substantially increasing interest and the scale-up production for possible commercialization is sought, though it may be regarded as less economically viable than using autotrophic growing algal cultures for producing lipid-based biofuels. This chapter provides an overview of the current status of using heterotrophic algae—in particular, *Chlorella*—for oil production. The path forward for further expansion of the heterotrophic production of algal oils with respect to both challenges and opportunities is also discussed.

6.2 HETEROTROPHY OF MICROALGAE

Microalgae are more efficient than higher plants with respect to photosynthesis, through which light, together with CO₂, is converted to chemical energy. Aside from photoautotrophy, some microalgae are capable of growing heterotrophically as well as mixotrophically. *Heterotrophy* refers to the fact that microalgae utilize organic carbon as the solo carbon and energy source for their reproduction in the absence of light; *mixotrophy* is indicative of microalgae performing growth in the presence of light through use of both CO₂

(photosynthesis) and organic carbon sources. A number of microalgae have been reported for heterotrophic growth, among which green algae, in particular, *Chlorella*, are the most studied (Table 6.1). Microalgae are capable of utilizing a wide range of organic carbon sources, including sugars, hydrolyzed carbohydrates, waste molasses, acetate, and glycerol, as well as organic carbons from wastewater (Table 6.1). Regardless of the microalgal species and strains, sugar—in particular, glucose—is the most commonly used organic carbon for boosting heterotrophic growth of microalgae (Table 6.1).

The uptake of external glucose relies on a hexose/H⁺ symport system that has been characterized in *Chlorella* (Hallmann and Sumper, 1996). In the presence of glucose, the hexose/H⁺ symport system is activated and transports glucose and H⁺ (1:1) into cytosol at the cost of equal ATP molecules (Tanner, 2000). The catabolism of transported glucose starts with a phosphorylation of the hexose to form glucose-6-phosphate, an important intermediate product for respiration, storage, and biomass synthesis. Two pathways that share the initially formed glucose-6-phosphate are proposed to be involved in the aerobic glycolysis in algae—namely, the Embden-Meyerhof-Parnas (EMP) pathway and the pentose phosphate (PP) pathway (Figure 6.1; Neilson and Lewin, 1974). Both pathways are present in cytosol and contribute to the glucose metabolism in algae of autotrophy, mixotrophy, and heterotrophy, though their contributions may vary largely (Yang et al., 2000, 2002; Hong and Lee, 2007). For instance, glucose is mainly metabolized via a PP pathway in heterotrophic *Chlorella pyrenoidosa*, which accounts for 90% of total glucose metabolic flux distribution (Yang et al., 2000). The dominant role of a PP pathway was also demonstrated in the heterotrophic culture of the cyanobacterium *Synechocystis* sp. PCC6803 (Yang et al., 2002). In contrast, the EMP pathway serves as the major flux of glucose metabolism in algae in the presence of light (Yang et al., 2000, 2002), suggesting the regulation of light on glycolysis. Table 6.2 shows the central metabolic network of glucose in heterotrophic algae with stoichiometric reactions.

6.3 POTENTIAL OF HETEROTROPHIC ALGAL OILS

In comparison to photoautotrophy, heterotrophic growth mode offers substantial advantages, e.g., elimination of the light requirement, ease of control for monoculture, high cell density, and great biomass productivity (Chen, 1996). Lab-scale heterotrophic production of algae has been reported in recent decades, either in shaking flasks or in small-volume fermenters (Cheng et al., 2009; Liang et al., 2009; Liu et al., 2010, 2011b; Yan et al., 2011). Liang et al (2009) examined the growth of *Chlorella vulgaris* under both phototrophic and heterotrophic conditions and indicated heterotrophic *C. vulgaris* had around threefold higher biomass yield than a phototrophic one. Liu et al (2011b) investigated the growth of *Chlorella zofingiensis*; the alga achieved 10.1 g L⁻¹ of cell density under heterotrophic conditions compared to 1.9 g L⁻¹ under phototrophic conditions. *Chlorella protothecoides*, another well-studied green alga, was reported to achieve as high as up to 17 g L⁻¹ of cell density in heterotrophic batch cultures (Cheng et al., 2009). This may be further improved through using culture techniques such as fed-batch, chemostat, and cell recycling, which have been widely used for fermentation of bacteria or yeasts. For example, the fed-batch *C. protothecoides* achieved a high cell density of 97 g L⁻¹ in a 5-L fermenter (Yan et al., 2011), much higher than that obtained in photoautotrophic culture systems (open ponds or photobioreactors) and close to the yeast yield

TABLE 6.1 Algae Reported with Heterotrophic Growth.

Algae	Carbon Sources	References
Green algae		
<i>Chlamydomonas reinhardtii</i>	Acetate	Chen and Johns, 1994, 1996; Zhang et al., 1999a
<i>Chlorella minutissima</i>	Glucose, starch, sucrose, glycine, acetate, glycerin	Li et al., 2011
<i>Chlorella protothecoides</i>	Glucose, glycerol, hydrolyzed carbohydrates, molasses, municipal wastewater	Zhang et al., 1999b; Miao and Wu, 2006; Cheng et al., 2009; Ruiz et al., 2009; Gao et al., 2010; O'Grady and Morgan, 2011; Yan et al., 2011; Chen and walker, 2012; Zhou et al. 2012
<i>Chlorella pyrenoidosa</i>	Glucose	Running et al., 1994
<i>Chlorella regularis</i>	Glucose, acetate	Endo et al., 1977; Sansawa and Endo, 2004
<i>Chlorella saccharophila</i>	Glucose, glycerol	Tan and Johns, 1991; Isleten-Hosoglu et al., 2012
<i>Chlorella sorokiniana</i>	Glucose	Chen and Johns, 1991; Zheng et al., 2012
<i>Chlorella vulgaris</i>	Agro-industrial co-products, glucose, sucrose, acetate, glycerol	Rattanolpoltee et al., 2008; Mitra et al., 2012; Liang et al., 2009; Scarsella et al., 2009
<i>Chlorella zofingiensis</i>	Glucose, fructose, mannose, sucrose, molasses	Ip and Chen, 2005; Liu et al., 2010, 2011b, 2012a
<i>Haematococcus lacustris</i>	Glucose	Chen et al., 1997
<i>Haematococcus pluviialis</i>	Acetate	Kobayashi et al., 1992
<i>Micractinium pusillum</i>	Glucose, acetate	Bouarab et al., 2004
<i>Pseudococcomyxa chodatii</i>	Glucose	Kiseleva and Kotlova, 2007
<i>Tetraselmis suecica</i>	Glucose, acetate	Day and Tsavalos, 1996; Azma et al., 2011
Diatom		
<i>Cyclotella cryptica</i>	Glucose	Pahl et al., 2010
<i>Nitzschia laevis</i>	Glucose	Wen and Chen, 2001a,b; Chen et al., 2008
Others		
<i>Aphanothece microscopica</i>	Fish processing wastewater	Queiroz et al., 2011
<i>Cryptocodinium Cohnii</i>	Glucose	Couto et al., 2010; Jiang et al., 1999; Jiang and Chen, 2000a,b
<i>Galdieria sulphuraria</i>	Glucose	Schmidt et al., 2005; Sloth et al., 2006
<i>Ochromonas danica</i>	Phenolic mixtures	Semple, 1998
<i>Schizochytrium limacinum</i>	Glycerol	Ethier et al., 2011
<i>Schizochytrium mangrovei</i>	Glucose	Fan et al., 2007
<i>Schizochytrium</i> sp.	Glucose	Ganuza et al., 2008
<i>Spirulina</i> sp.	Glucose	Chojnacka and Noworyta, 2004
<i>Spongiococcum exetricicum</i>	Glucose	Hilaly et al., 1994
<i>Synechocystis</i> sp.	Glucose	Kong et al., 2003

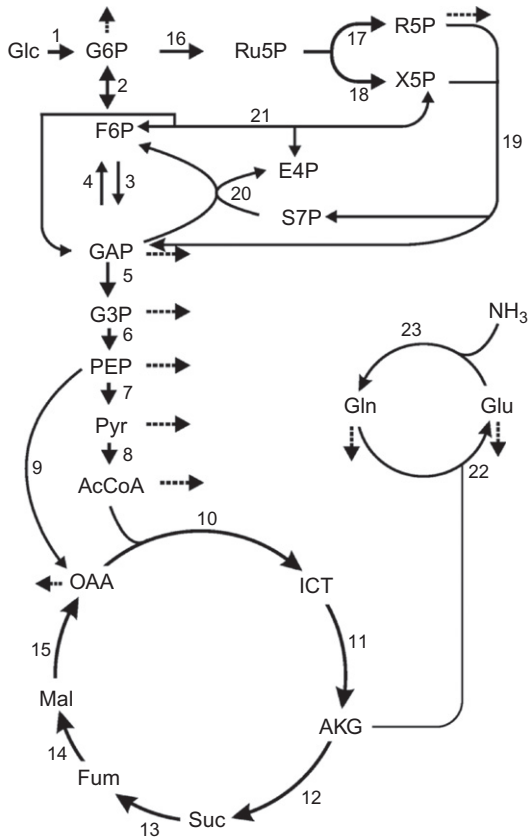

FIGURE 6.1 Central carbon metabolism of microalgae in heterotrophic cultures based on glucose. Glu, Glucose; G6P, Glucose-6-Phosphate; F6P, Fructose-6-Phosphate; GAP, Glyceraldehyde-3-Phosphate; G3P, 3-Phosphoglycerate; PEP, Phosphoenolpyruvate; Pyr, Pyruvate; AcCoA, Acetyl-CoA; ICT, Isocitrate; AKG, α -Ketoglutarate; Suc, Succinyl-CoA; Fum, Fumarate; Mal, Malate; OAA, Oxalacetate; Ru5P, Ribulose-5-Phosphate; R5P, Ribose-5-Phosphate; X5P, Xylulose-5-Phosphate; E4P, Erythrose-4-Phosphate; S7P, Sedoheptulose-7-Phosphate; Glu, Glutamate; Gln, Glutamine. For details of the reactions with numbers, see [Table 6.2](#).

TABLE 6.2 The Central Metabolic Network of Glucose in Heterotrophic Algae with the Stoichiometric Reactions.

Glycolytic pathway

$\text{Glc} + \text{ATP} \Rightarrow \text{G6P} + \text{ADP} + \text{H}$	1
$\text{G6P} \rightleftharpoons \text{F6P}$	2
$\text{F6P} + \text{ATP} \Rightarrow 2\text{GAP} + \text{ADP} + \text{H}$	3
$2\text{GAP} + \text{H}_2\text{O} \Rightarrow \text{F6P} + \text{P}_i$	4
$\text{GAP} + \text{NAD} + \text{P}_i + \text{ADP} \rightleftharpoons \text{G3P} + \text{ATP} + \text{NADH} + \text{H}$	5
$\text{G3P} \rightleftharpoons \text{PEP} + \text{H}_2\text{O}$	6
$\text{PEP} + \text{ADP} \Rightarrow \text{Pyr} + \text{ATP}$	7
$\text{Pyr} + \text{NAD} + \text{CoA} \Rightarrow \text{AcCoA} + \text{NADH} + \text{CO}_2 + \text{H}$	8
$\text{PEP} + \text{CO}_2 + \text{ADP} \Rightarrow \text{OAA} + \text{ATP}$	9

Continued

TABLE 6.2 The Central Metabolic Network of Glucose in Heterotrophic Algae with the Stoichiometric Reactions—Cont'd

Tricarboxylic acid cycle	
OAA + AcCoA + H ₂ O <=> ICT + CoA + H	10
ICT + NAD <=> AKG + NADH + CO ₂	11
AKG + CoA + NAD => Suc + NADH + CO ₂ + H	12
Suc + ADP + P _i + FAD <=> Fum + FADH ₂ + ATP + CoA	13
Fum <=> Mal	14
Fum + NAD + H ₂ O <=> OAA + NADH + H	15
Pentose phosphate pathway	
G6P + 2NADP + H ₂ O => Ru5P + CO ₂ + 2NADPH + 2H	16
Ru5P <=> R5P	17
Ru5P <=> X5P	18
R5P + X5P <=> S7P + GAP	19
S7P + GAP <=> F6P + E4P	20
X5P + E4P <=> F6P + GAP	21
Utilization of nitrogen	
AKG + NADPH + Gln => 2Glu + NADP	22
Glu + NH ₃ + ATP => Gln + ADP + P _i	23

(Li et al., 2007b; Kurosawa et al., 2010; Zhang et al., 2011). Although the growth and biomass production of algae are species/strain dependent and may vary greatly, the overall biomass yield and productivity of heterotrophic algae are significantly higher than those of phototrophic ones, as illustrated by Figures 6.2a and 6.2b.

Heterotrophic culture of algae offers not only high cell density but also high level of oils. The lipid contents of alga cultured heterotrophically were shown in Table 6.3. The lipid content varies from 4.8% to 60% of dry weight, depending on the algal species/strains and culture conditions. Commonly, stresses such as high light intensity and/or nitrogen starvation are required to induce intracellular oil accumulation of algae under photoautotrophic conditions. These stresses, however, are unfavorable for algal growth and biomass production, causing the contradiction between growth and oil synthesis. In contrast, the heterotrophic algae are able to accumulate oil while simultaneously building up biomass; for example, the intracellular oil content of *C. zofingiensis* increased from 0.25 to 0.5 g g⁻¹ (on a dry-weight basis) when the cell density increased from 5 to 42 g L⁻¹ (Liu et al., 2010). The accumulated oil contains mainly neutral lipids, in particular triacylglycerol (TAG). The TAG may account for up to 80% of neutral lipids or 71% of total lipids (Liu et al., 2011b). TAG is regarded as superior to polar lipids (phospholipids and glycolipids) for biodiesel production due to its higher content of fatty acids. Taking into account the rapid growth and abundance of oils, heterotrophic algae usually allow

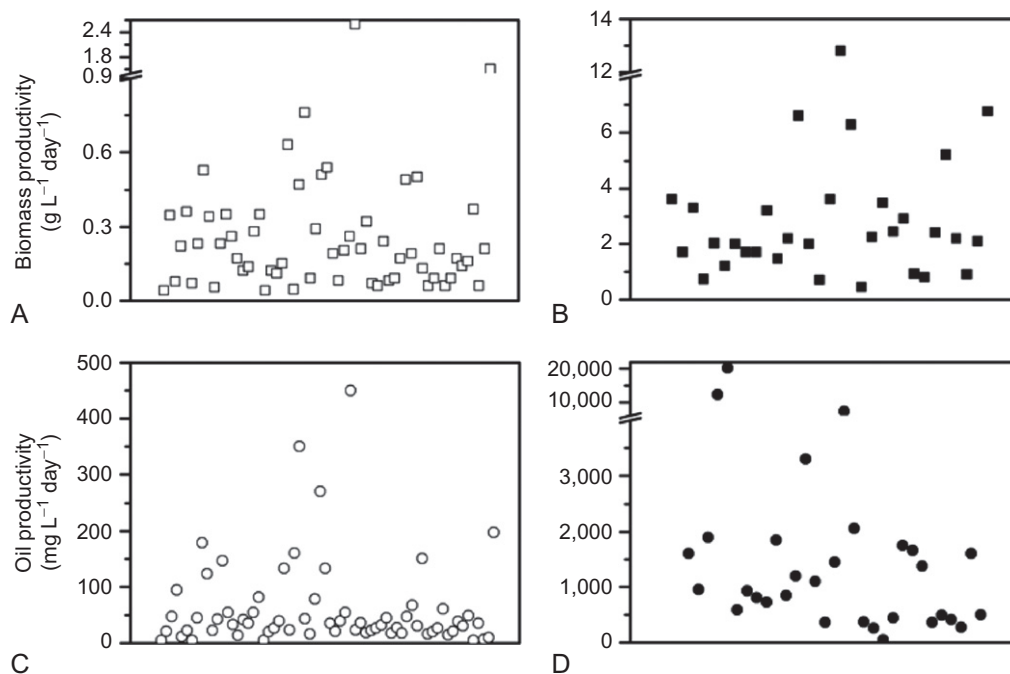

FIGURE 6.2 Biomass (a, b) and oil (c, d) productivities of phototrophic (open) and heterotrophic (filled) algae, based on the data of research articles published in the past decade. The differences in biomass and oil productivities between cultures under phototrophic and heterotrophic growth conditions were statistically significant using Duncan's multiple-range test with the ANOVA procedure.

TABLE 6.3 Oil Content of Heterotrophic Algae.

Algae	Oil Content (% Dry Weight)	References
Green algae		
<i>Chlorella minutissima</i>	16.1	Li et al., 2011
<i>Chlorella protothecoides</i>	44.3-48.7	Li et al., 2007a
<i>Chlorella protothecoides</i>	44	Cheng et al., 2009
<i>Chlorella protothecoides</i>	52.5	Gao et al., 2010
<i>Chlorella protothecoides</i>	58.9	O'Grady and Morgan, 2011
<i>Chlorella protothecoides</i>	32	Chen and Walker, 2012
<i>Chlorella protothecoides</i>	49.4	De la Hoz Siegler et al., 2012
<i>Chlorella protothecoides</i>	28.9	Zhou et al., 2012
<i>Chlorella saccharophila</i>	26.7-36.3	Isleten-Hosoglu et al., 2012
<i>Chlorella sorokiniana</i>	20.1-46	Chen and Johns, 1991
<i>Chlorella sorokiniana</i>	23.3	Zheng et al., 2012

Continued

TABLE 6.3 Oil Content of Heterotrophic Algae—Cont'd

Algae	Oil Content (% Dry Weight)	References
<i>Chlorella vulgaris</i>	23-34	Liang et al., 2009
<i>Chlorella vulgaris</i>	32.9	Rattanapoltee et al., 2008
<i>Chlorella vulgaris</i>	35-58.9	Scarsella et al., 2009
<i>Chlorella vulgaris</i>	11-43	Mitra et al., 2012
<i>Chlorella zofingiensis</i>	52	Liu et al., 2010
<i>Chlorella zofingiensis</i>	51.1	Liu et al., 2011b
<i>Chlorella zofingiensis</i>	48.9	Liu et al., 2012a
Diatoms		
<i>Cyclotella cryptica</i>	4.8-7.4	Pahl et al., 2010
<i>Nitzschia laevis</i>	12.8	Chen et al., 2008
Others		
<i>Aphanothece microscopica</i>	7.1-15.3	Queiroz et al., 2011
<i>Cryptocodinium Cohnii</i>	19.9	Couto et al., 2010
<i>Schizochytrium limacinum</i>	50.3	Ethier et al., 2011
<i>Schizochytrium mangrovei</i>	68	Fan et al., 2007
<i>Schizochytrium</i> sp.	35	Ganuza et al., 2008

a high volumetric oil productivity (Figures 6.2c and 6.2d), e.g., $7.3 \text{ g L}^{-1} \text{ day}^{-1}$ in the case of *C. protothecoides* under fed-batch culture conditions (Yan et al., 2011). The fatty acid characteristics of oils, e.g., carbon chain length and unsaturation degree, largely determine the properties of biodiesel such as cetane number, viscosity, cold flow, and oxidative stability (Knothe, 2005). Although the fatty acid species of algae grown heterotrophically may show few differences in comparison to photoautotrophy, the proportions of individual fatty acid vary greatly. Liu et al. (2011b) investigated the fatty acid profiles of *C. zofingiensis* and indicated that heterotrophic cells contained low levels of C16:0, C16:3, C18:0, and C18:3 but much higher content of C18:1 than autotrophic cells. The proportion of C18:1 is regarded as an important factor for biodiesel quality because it can provide a compromise solution between oxidative stability and low-temperature properties (Knothe, 2009). The higher the C18:1 content, the better the biodiesel quality. The biodiesel derived from heterotrophic algae was analyzed with respect to the key properties (e.g., energy density, viscosity, flash point, cold filter plugging point, and acid value), and the results showed that most properties complied with the specifications established by the American Society for Testing and Materials (Xu et al., 2006).

In addition to the lab-scale cultures, many attempts have been made to develop industrial-scale processes for the heterotrophic cultivation of algae. The heterotrophic *Chlorella* cultures have long been initiated in Japan and Taiwan in the late 1970s; *Chlorella* species were cultured in stainless steel tanks using glucose and/or acetate as carbon and energy sources, with an annual production of 1,100 tons biomass (Lin, 2005). Thereafter, large-scale heterotrophic

cultivation of several other algal strains were reported, for example, *Tetraselmis suecica* in 50,000-L fermenters (Day et al., 1991), *Cryptothecodinium cohnii* with a capacity of 150,000 L (Radmer and Fisher, 1996), and *Spongiococcum exetriccium* fed-batch cultured in 450-L fermenters (Hilaly et al., 1994), though these cultures were used not for oils but for high-value products. Recently, a scale-up heterotrophic cultivation of *C. protothecoides* was reported for oil production in 11,000-L fermenters, where the daily biomass production of 20 kg and oil production of 8.8 kg were achieved (Li et al., 2007a).

Because of the elimination of light requirements and sophisticated fermentation systems that have developed, the scale-up of heterotrophic cultures for high cell density and oil yield is relatively easier to achieve than that of autotrophic cultures. The production of heterotrophic algal cultures, however, is restricted, due largely to (1) the limited number of available heterotrophic species, (2) possible contamination by bacteria or fungi, (3) inhibition of growth by soluble organic substrates (e.g., sugar) at high concentrations, and (4) the relatively high cost of organic carbon sources. The first limitation might be overcome by performing extensive screening analyses. For example, Vazhappilly and Chen (1998) intensively studied the heterotrophic potential of 20 algal strains and suggested that 6 of them showed good heterotrophic growth. As the screening expands, increasing algal species/strains will be identified with heterotrophic potential. In some cases, the obligate photoautotrophic algae can be metabolic engineered to grow heterotrophically. Zaslavskaja et al (2001) reported that a genetically modified *Phaeodactylum tricornutum*, through introducing a gene encoding a glucose transporter, was capable of thriving on exogenous glucose in the absence of light, suggesting an alternative approach to increasing the available number of heterotrophically grown algae. The second problem is due mainly to the relatively slow growth of algae compared with other microorganisms such as bacteria or yeast that grow fast and finally dominate the cultures. Rigorous sterilization and aseptic operation are necessary and considered to be effective to circumvent such possible contamination. Growth inhibition is a common problem occurring in batch cultures, which has restricted the use of batch cultures in commercial production processes. The growth inhibition may be attributed to the high initial concentration of substrates (e.g., sugars) or the possible buildup of certain inhibitory substances produced by algae during culture periods. For example, the sugar concentration of over 20 g L⁻¹ was reported to inhibit the growth of *C. zofingiensis* (Liu et al., 2010, 2012a). Advances in heterotrophic culture systems may eliminate or reduce the growth-inhibition problems, where fed-batch, chemostat, and cell recycle have been intensively investigated (Wen and Chen, 2002a; De la Hoz Siegler et al., 2011; Liu et al., 2012a). The organic carbon sources—in particular, glucose—account for the major cost of a culture medium and contribute to the relatively high cost of heterotrophic production, which makes the algal oils from heterotrophic cultures less economically viable than those from autotrophic cultures. Cheap alternatives are sought with the goal of bringing down production costs, e.g., waste molasses (Yan et al., 2011; Liu et al., 2012a), carbohydrate hydrolysate (Cheng et al., 2009; Gao et al., 2010), and biodiesel byproduct glycerol (O'Grady and Morgan, 2011).

6.4 FACTORS AFFECTING HETEROTROPHIC PRODUCTION OF ALGAL OILS

Heterotrophic growth of algae requires organic carbons, water, and inorganic salts. The growth, lipid content, and fatty acid composition are species/strain specific and can be greatly influenced by a variety of medium nutrients and environmental factors.

Carbon is the main component of algal biomass and accounts for ca 50% of dry weight. Sugars, particularly glucose, are the commonly used organic carbon sources for heterotrophic growth of algae (Table 6.1). Different algae may prefer diverse sugars for heterotrophic growth. Liu et al (2010) studied the effect of various monosaccharides and disaccharides on growth of *C. zofingiensis* and found that glucose, fructose, mannose, and sucrose were efficiently consumed by the cells for rapid growth, whereas lactose and galactose were poorly assimilated and hardly supported the algal growth. In contrast, *C. protothecoides* may be unable to directly assimilate sucrose, and pretreatment using invertase is required to release glucose and fructose (Yan et al., 2011). The growth, lipid content, and fatty acid profile of heterotrophically grown *C. zofingiensis* were slightly affected by the sugar species, namely, glucose, fructose, mannose, and sucrose (Liu et al., 2010) but were influenced to a large extent by the initial concentration of sugars (Liu et al., 2012a). Within the tested range of sugar concentrations (5 to 50 g L⁻¹), higher sugar concentrations gave *C. zofingiensis* higher cell density but at the same time lower specific growth rate (Figure 6.3a). The slow growth at high sugar concentrations is due likely to the substrate inhibition, a common issue confronted in batch cultures. High sugar concentrations also favored the intracellular lipid accumulation of *C. zofingiensis*, in which the lipid content at 30 g L⁻¹ sugar was 0.5 g g⁻¹, 79% greater than that at 5 g L⁻¹ sugar (Figure 6.3b). In addition, the lipid distribution was found to be associated with sugar concentrations. Neutral lipid (NL) is the major lipid class, the proportion of which increased with increased sugar concentrations and could account for up to 85.5% of total lipids. Similar to NL, TAG levels were promoted by higher sugar concentrations (Figure 6.3c). In contrast, the membrane lipids phospholipid (PL) and glycolipid (GL) decreased in response to the increased sugar concentrations (Figure 6.3c). The fatty acid profiles of heterotrophic *C. zofingiensis* were investigated in response to different sugar concentrations (Liu et al., 2012a). C16:0, C16:2, C18:1, C18:2, and C18:3 are the major fatty acids and represented more than 85% of total fatty acids. The levels of C16:0, C16:2, and C18:2 remained nearly unchanged under all tested sugar concentrations. In contrast, C18:1 and C18:3 levels were significantly affected: The former was promoted by higher sugar concentrations, whereas the latter by lower sugar concentrations. In addition, the content of total fatty acids based on dry weight ascended as the sugar concentration increased and could reach as high as 42.2%. Although the mechanism underlying sugar-induced lipid accumulation remains largely unknown, preliminary data suggested the involvement of glucose in triggering the great up-regulation of fatty acid biosynthetic genes, e.g., acetyl-CoA carboxylase and stearoyl-ACP desaturase (Liu et al., 2010; Liu et al., 2012b). Glucose catabolism provides not only energy for lipid/fatty acid synthesis but also acetyl-CoA, the direct precursor of fatty acids. The high sugar levels cause the formation of excess carbon for cell generation, and the carbon flux can be directed to lipid synthesis.

It is worth noting that some algal species prefer other carbon sources over glucose in heterotrophic mode. For example, feeding pure acetic acid enabled *Cryptothecodinium cohnii* to yield much higher productivity of docosahexaenoic acid (DHA) of 1,152 mg L⁻¹ d⁻¹; the superiority of acetic acid to glucose might be because in this alga, the conversion of glucose to acetyl-CoA needs several steps, whereas acetate only needs a single-step action to be activated to acetyl-CoA directly by acetyl-CoA synthetase (de Swaaf et al., 2003). Another alternative carbon source, glycerol, has been commonly used for those algal species naturally occurring in habitats with high osmolarity, such as seawater or saline ponds (Neilson and Lewin,

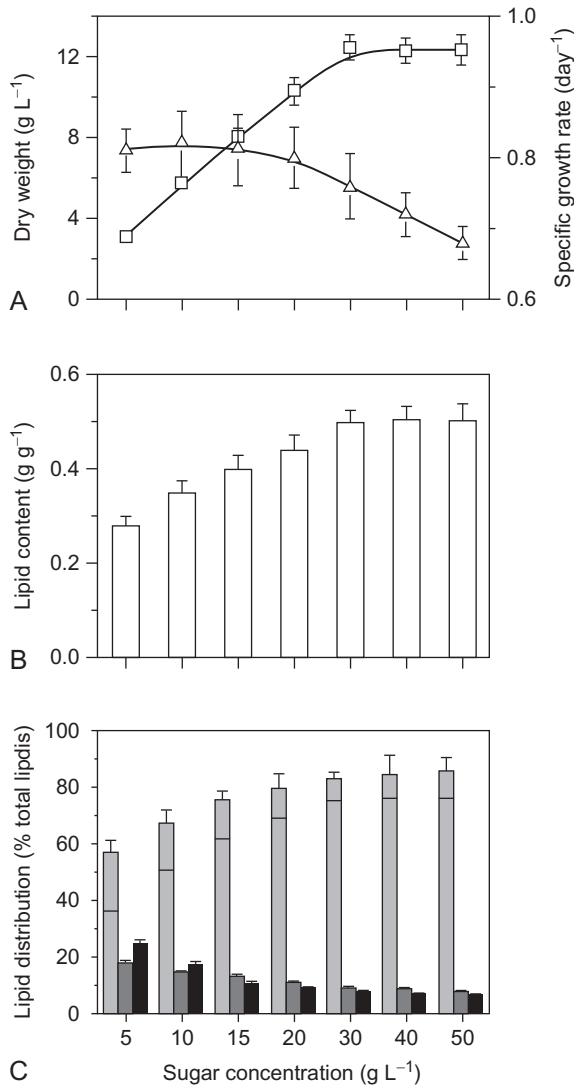

FIGURE 6.3 (A) Growth, (B) lipid content, and (C) lipid composition of *C. zofingiensis* with different initial sugar concentrations. (Δ) specific growth rate; (\square) dry weight; (white column) lipid content; (light gray column) neutral lipids; (gray column) phospholipids; (black column) glycolipids. The horizontal line inside the neutral lipids column marks the portion of TAG in this fraction. Adapted from Liu et al. (2012a) and the permission for reprint requested.

1974), due possibly to that glycerol having the capability to raise the osmotic strength of the solution and consequently keep the osmotic equilibrium in cells (Perez-Garcia et al., 2011).

Nitrogen is the second main component of algal biomass. In autotrophic cultures, nitrogen is an important factor influencing intracellular lipid accumulation, and nitrogen limitation/starvation is generally associated with the enhanced synthesis of lipids, in particular NL (Illman et al., 2000; Hsieh and Wu, 2009; Lacour et al., 2012). In heterotrophic cultures, nitrogen availability also plays an important role in the profiles of lipids and fatty acids. A low level of nitrogen favors the accumulation of intracellular lipids (Scarsella et al., 2009; Xiong et al., 2010a). The heterotrophically grown *Chlorella protothecoides* produced 53.8% of lipids

(on a dry-weight basis) under nitrogen-limiting conditions—over two times of that under nitrogen-sufficient conditions (Xiong et al., 2010a). Nitrogen limitation also promoted carbohydrate synthesis but at the same time lowered the algal growth and protein level as well as the biomass growth yield coefficient on a glucose basis (Xiong et al., 2010a). The authors also analyzed the carbon flux by using ^{13}C -tracer and GC-MS and indicated that *C. protothecoides* utilized considerably more acetyl-CoA for lipid synthesis under nitrogen-limiting conditions than under nitrogen-sufficient conditions (Xiong et al., 2010a). Considering that organic carbons are used in heterotrophic cultures, the carbon/nitrogen (C/N) ratio, controlling the switch between protein and lipid syntheses, is usually employed to show the combined effect of carbon and nitrogen on lipid synthesis. Thus, it is the higher C/N ratios (corresponding to higher carbon concentrations when the initial nitrogen is fixed or lower nitrogen concentrations when the initial carbon is fixed) that trigger the accumulation of lipids, in particular the NLs. The NLs are likely from the excess carbon in the form of acetyl-CoA that enters the lipid synthetic pathway (Liu et al., 2012b) or from the transformation of chloroplast membrane lipids when nitrogen is depleted (García-Ferris et al., 1996). Up-regulation of enzymes involved in lipid biosynthesis, including acetyl-CoA carboxylase (ACCase), stearyl-acyl carrier protein desaturase (SAD), acyl-CoA:diacylglycerol acyltransferase (DGAT), and phospholipid:diacylglycerol acyltransferase (PDAT), was observed to be associated with lipid accumulation (Miller et al., 2010; Guarnieri et al., 2011; Boyle et al., 2012; Msanne et al 2012; Liu et al., 2012b). The enhanced lipid synthesis may be not only related to up-regulation of lipid-synthesizing enzymes under nitrogen limitation/starvation but also to the possible cessation of other enzymes associated with cell growth and proliferation (Ratledge and Wynn, 2002). For those reports that culture age affects lipid accumulation in algae (Liu et al., 2010; Liu et al., 2011b), the underlying reason may be the nitrogen availability in that the aged cultures are accompanied by the depletion of nitrogen, which triggers the accumulation of lipids.

In addition to nitrogen availability, nitrogen sources have been demonstrated to influence the growth and biochemical composition of heterotrophic algae. Algae can utilize various forms of nitrogen, e.g., nitrate, ammonia, urea, glycine, yeast extract, and tryptone (Vogel and Todaro, 1997; Shi et al., 2000; Hsieh and Wu, 2009; Yan et al., 2011). Both nitrate-N and urea-N cannot be directly incorporated into organic compounds but have to be first reduced to ammonia-N. Ammonia and urea are economically more favorable as nitrogen sources than nitrate in that the latter is more expensive per unit N. The uptake of ammonia results in acidification of the medium, and nitrate causes alkalization, whereas urea leads to only minor pH changes (Goldman and Brewer, 1980). In this context, urea is the better choice of nitrogen source for avoiding large pH shifts of unbuffered medium. Shi et al (2000) reported the severe drop in culture pH (below 4) of heterotrophic *C. protothecoides* with ammonia, which resulted in much lower biomass yield compared to with urea or nitrate. Different algal species may favor different nitrogen sources for growth. For example, *Chlorella pyrenoidosa* preferred urea to nitrate or glycine for growth, whereas *C. protothecoides* gave a higher biomass yield when fed nitrate rather than urea (Davis et al., 1964; Shen et al., 2010). Those mutants deficient in nitrate/nitrite reductases have to use ammonia for growth (Dawson et al., 1997; Burhenne and Tischner, 2000).

Nitrogen limitation is not always linked to lipid accumulation in algae, e.g., the diatoms *Achnanthes brevipes* and *Tetraselmis* spp. accumulated carbohydrates rather than lipids upon

nitrogen starvation (Gladue and Maxey, 1994; Guerrini et al., 2000). Diatoms need silicate for growth, and silicate metabolism in diatoms has been reviewed by Martin-Jezequel et al. (2000). In general, silicate limitation/starvation is associated with the enhanced synthesis of lipid in diatoms (Lombardi and Wangersky, 1991; Wen and Chen, 2000). In addition, the content of polyunsaturated fatty acids (e.g., EPA) increased with the depleted silicate (Wen and Chen, 2000). This may be explained by the finding that the silicate-limited diatom cells divert the energy allocated for silicate uptake when silicate is replete into energy storage lipids. Phosphorus plays an important role in the energy transfer of the algal cells as well as in the syntheses of phospholipids and nucleic acids. It was also reported that phosphorus deficiency promoted the accumulation of lipids in certain algae (Lombardi and Wangersky, 1991; Scarsella et al., 2009).

Aside from the medium nutrients, environmental factors play an important role in influencing the heterotrophic growth and lipid profile of algae, including but not restricted to temperature, pH, salinity, dissolved oxygen level, dilution rates, and turbulence (Chen and Johns, 1991; Jiang and Chen, 2000a, b; Chen, et al., 2008; Pahl et al., 2010; Ethier et al., 2011). When temperature shifts, the algae need to alter the thermal responses of membrane lipids to maintain the normal function of membranes (Somerville, 1995). Many studies have proved that in heterotrophic mode, a low temperature can induce the generation of unsaturated fatty acids, and vice versa (Wen and Chen, 2001a; Jiang and Chen, 2000a). There are two possible explanations: (1) a reduction in temperature leads to the decreased membrane fluidness; as a result, the algae need to speed up the desaturation of lipids as a compensation to maintain the proper cell membrane fluidity via the up-regulation of desaturase genes (Perez-Garcia et al., 2011); and (2) the low temperature gives rise to more intracellular molecular oxygen and consequently improves the activities of desaturases and elongases that are involved in the biosynthesis of unsaturated fatty acids (Chen and Chen, 2006). The high salinity was found to enhance the lipid accumulation in *Nitzschia laevis* in heterotrophic mode. Upon changing the concentration of NaCl in the medium from 10 to 20 g L⁻¹, an increase in EPA and polar lipids was observed, accompanied by a slight decline of NLS (Chen et al., 2008). The sufficient oxygen supply is important for algal growth, especially in high cell density fermentation. Chen and Johns (1991) reported that in the heterotrophic culture of *Chlorella sorokiniana*, a high concentration of dissolved oxygen improved the cell growth as well as the fatty acid yield. The effect of pH on growth and lipids of *Cryptocodinium cohnii* was reported by Jiang and Chen (2000b), where the highest DHA content was obtained at pH 7.2.

As such, the optimization of nutritional and environmental factors is of great importance to the development of a high-yield lipid production system by heterotrophic algae. The commonly used approaches for the production optimization are one-at-a-time and statistical methods (Kennedy and Krouse, 1999). The one-at-a-time strategy involves variation of one factor within a desired range while keeping other factors constant (Wen and Chen, 2000; Pahl et al., 2010; Liu et al., 2012a). This strategy is simple and easy to conduct and thus has been widely used for optimizing the production of biomass and desired products. However, the one-at-a-time method has its intrinsic disadvantages, e.g., failing to consider the interactions among factors and requiring a relatively large number of experiments. To overcome these problems, a good choice is the statistical approach-based optimization, which requires three steps: design, optimization, and verification (Kennedy and Krouse, 1999). The raw data obtained after experimental design can be transformed to models or

three-dimensional plots, based on which the optimal factors can be predicted. A verification experiment needs to be conducted to validate the predication. The statistical approach-based optimization has been applied to microalgae for the heterotrophic production of biomass and desired products, e.g., polyunsaturated fatty acid production by *N. laevis* (Wen and Chen, 2001a), biomass production by *Tetraselmis suecica* (Azma et al., 2011), and lipid production by *Chlorella saccharophila* (Isleten-Hosoglu et al., 2012).

6.5 HIGH CELL DENSITY OF HETEROTROPHIC ALGAE

The competitiveness of using heterotrophic algae over photoautotrophic ones for oil production rests largely with the high yield and productivity of biomass as well as of oil in heterotrophic cultivation modes. The high cell density of heterotrophic algae can be achieved by the employment of fed-batch, continuous, and cell-recycle culture strategies that are widely used in the fermentation of bacteria or yeasts.

6.5.1 Fed-Batch Cultivation

In the heterotrophic batch cultures, high initial concentration of substrates, e.g., sugars, is usually used to provide sufficient carbons for obtaining high cell density. Accompanying the high substrate concentration, however, is the occurrence of possible growth inhibition. For instance, the optimal sugar concentration for growing *C. zofingiensis* was reported below 20 g L^{-1} , above which the inhibition of algal growth was observed (Ip and Chen, 2005; Liu et al., 2012a). The substrate-based inhibition caused not only the decreased specific growth rate but also the lowered biomass yield coefficient based on sugars (Sun et al., 2008; Liu et al., 2012a), contributing accordingly to the increased cost input. To overcome the inhibition issue associated with batch cultures, fed-batch cultivation is a commonly used strategy in which the substrate is fed into the algal cultures step by step to maintain it sufficiently for cell growth but below the level of inhibition threshold. There have been a number of reports employing fed-batch strategy to grow algae heterotrophically with the aim of avoiding the possible inhibition caused by the initial high substrate and improving the production potential of biomass as well as of oils (Xu et al., 2006; Li et al., 2007a; Sun et al., 2008; Xiong et al., 2008; Liu et al., 2010; 2012a; De la Hoz Siegler et al., 2011; Yan et al., 2011; Chen and Walker, 2012). Liu et al. (2010) investigated the heterotrophic oil production by *C. zofingiensis* using fed-batch cultures in a 3.7-L bioreactor. A two-stage feeding was adopted: three times of feeding with glucose-containing nutrients (to maintain linear growth) followed by four times of glucose feeding alone (to further increase biomass and induce oil accumulation; Figure 6.4). Glucose concentration of the cultures was maintained between 5 and 20 g L^{-1} . The maximum lipid yield and lipid productivity achieved in the fed-batch cultures were 20.7 g L^{-1} and $1.38 \text{ g L}^{-1} \text{ day}^{-1}$, respectively, representing around a 2.9-fold increase of the those obtained in batch cultures.

Although the employment of fed-batch culture strategy proves able to eliminate the substrate inhibition, it cannot overcome the inhibition caused by the toxic metabolites that would be produced by the algal cultures and accumulate as the cells build up, preventing further enhancement of cell density.

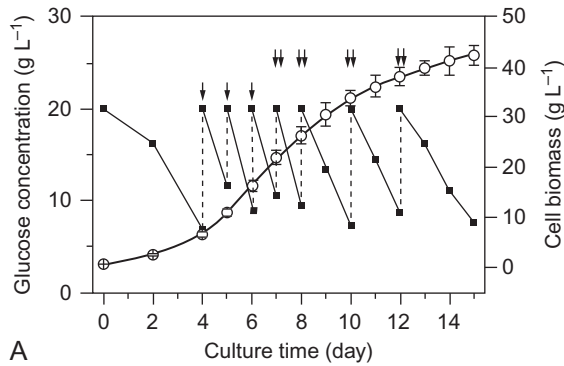
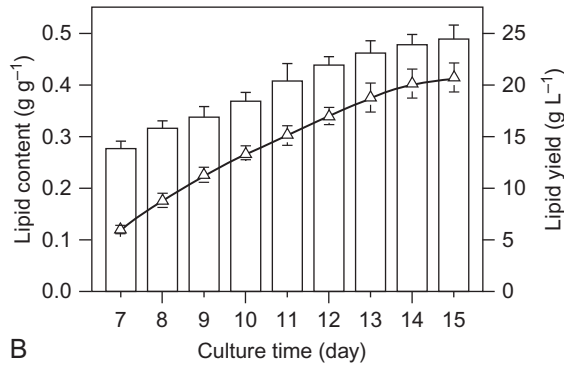

FIGURE 6.4 (A) Growth and glucose consumption and (B) lipid production in a two-stage fed-batch fermentation of *C. zofingiensis* in a 3.7-L fermentor. (○) cell biomass; (□) glucose concentration; (column) lipid content; (Δ) lipid yield; (↓) glucose-containing medium feeding; (↓↓) glucose feeding alone. Adapted from Liu et al. (2010) and the permission for reprint requested.



6.5.2 Continuous Cultivation

The term *continuous cultivation* refers to the fresh medium being continuously added to a well-mixed culture while cells or products are simultaneously removed to keep the culture volume constant. It allows the steady state of kinetic parameters such as specific growth rate, cell density, and productivity and is thus considered an important system for studying the basic physiological behavior of heterotrophic algal cells. Figure 6.5a shows the schematic diagram of the continuous cultivation system. This system is capable of effectively eliminating the metabolite-driven inhibition. There are several reports of continuous cultivation of algae in both photoautotrophic (Molina Grima et al., 1994; Otero et al., 1997) and heterotrophic (Wen and Chen, 2002b; Ethier et al., 2011) growth modes. Ethier et al (2011) investigated the continuous production of oils by the microalga *Schizochytrium limacinum* with various dilution rates (D) and feed glycerol concentrations (S_0). The yields and productivities of biomass, total fatty acids (TFA), and docosahexaenoic acid (DHA), shown in Figure 6.6, were over the range of D from 0.2 to 0.6 day⁻¹ (S_0 fixed at 90 g L⁻¹) and the range of S_0 from 15 to 120 g L⁻¹ (D fixed at 0.3 day⁻¹). The highest biomass productivity is 3.9 g L⁻¹ day⁻¹, obtained with the 0.3 day⁻¹ of D and 60 g L⁻¹ of S_0 (Figure 6.6b). The maximum productivities of both TFA and DHA were also achieved at the same D but with a higher S_0 of 90 g L⁻¹ (Figures 6.6d and 6.6f). Liu et al (2012a) surveyed the feasibility of using a semicontinuous *C. zofingiensis* culture fed with waste molasses for oil production. The waste molasses contains relatively high levels of metal ions and salt that are inhibitory to algal growth, causing the

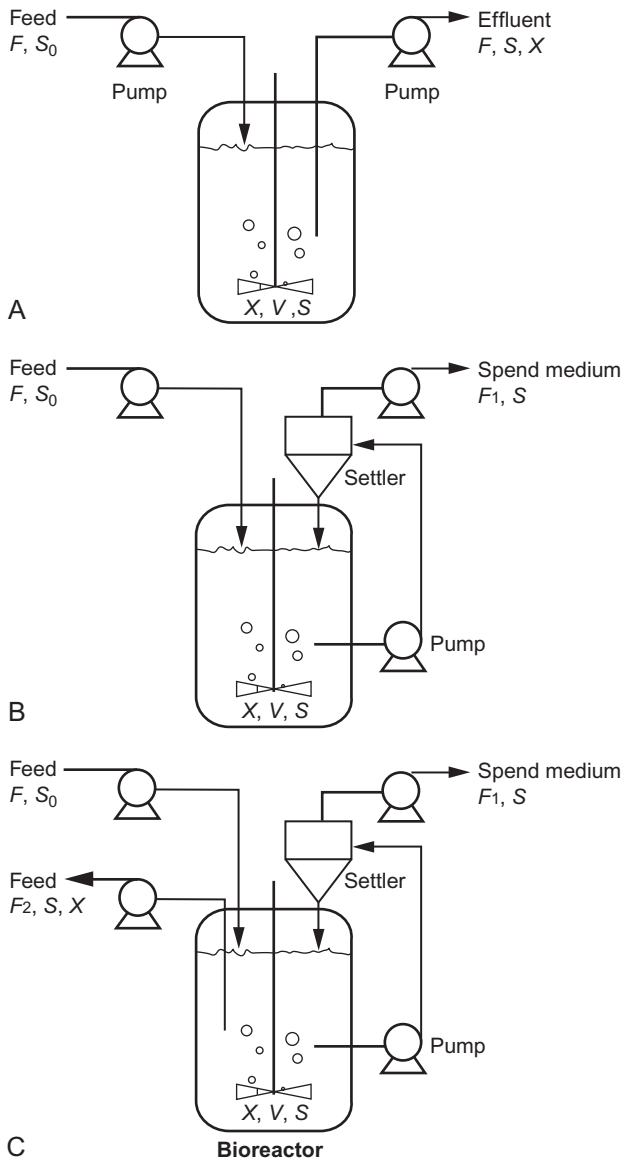

FIGURE 6.5 Schematic diagram of (A) continuous, (B) perfusion, and (C) perfusion-bleeding culture systems. X , cell concentration; V , culture volume; S , carbon concentration in medium; F , flow rate of feed; F_1 , flow rate of perfusion; F_2 , flow rate of bleeding; S_0 , carbon concentration in feed. The flow rates are controlled to keep the culture volume constant.

failure of molasses-based fed-batch cultivation when molasses was not pretreated; in contrast, *C. zothingiensis* in the semicontinuous culture fed with diluted raw molasses showed comparable growth rate and sugar utilization to that with pretreated molasses (Liu et al., 2012a). Although continuous cultivation can promote the productivity, it is worth to mention that accompanying the increase of dilution rate is the drop of cell density as well as of substrate utilization efficiency (Wen and Chen, 2002b). From a cost-effectiveness point of view, this is undesirable in that the residual substrate is wasted with the effluent and more energy input is required to harvest the diluted cells.

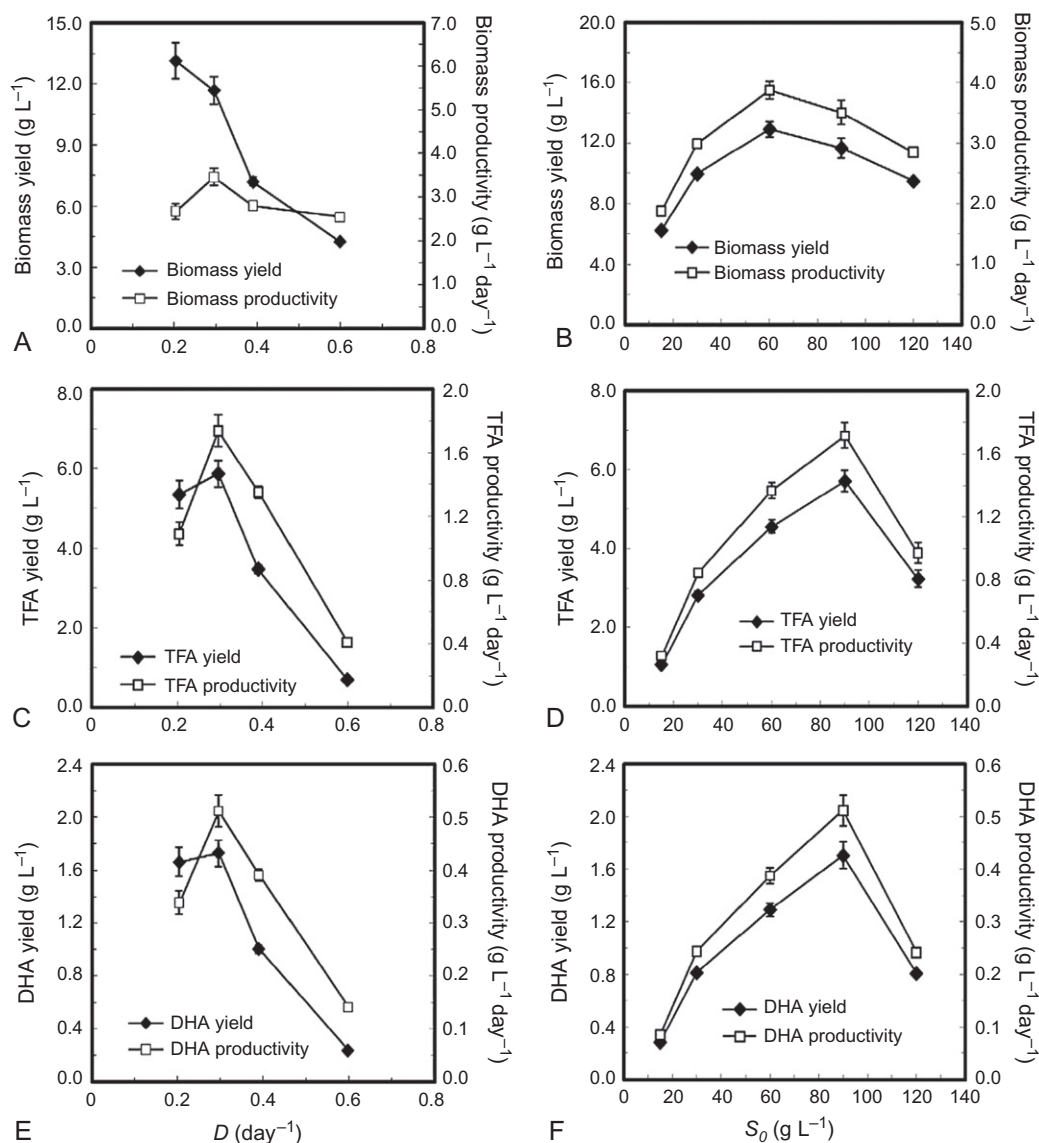

FIGURE 6.6 Algal growth, TFA and DHA production of continuous *Schizochytrium limacinum* in a 7.5-L fermentor with various dilution rates (D) (A, C, E; $S_0=90 \text{ g L}^{-1}$) and feed glycerol concentrations (S_0) (B, D, F; $D=0.3 \text{ day}^{-1}$). Adapted from Ethier et al. (2011) and the permission for reprint requested.

6.5.3 Continuous Cultivation with Cell Recycling

Continuous cultivation with cell recycling, denoted as *perfusion culture*, is a culture technique combining the advantages of both fed-batch and continuous culture systems, namely, avoiding the substrate inhibition and the inhibition caused by toxic metabolites produced by accumulated algal cells while maintaining high cell density and productivity

(Chen and Johns, 1995; Wen and Chen, 2002a). As illustrated by Figure 6.5b, in a perfusion culture system the algal cells are retained by a retention device, whereas the spent medium (cell-free) was removed from the bioreactor; at the same time, fresh medium was fed into the bioreactor to maintain sufficient nutrient supply. Wen and Chen (2002a) used the perfusion culture system to investigate the heterotrophic production of *N. laevis*. By employing an exponential feeding of glucose and manipulating the rates of glucose feeding and spent medium perfusion, the optimal glucose concentration in the feed was determined to be 50 g L^{-1} (Figures 6.7a and 6.7b). With the feeding of optimized glucose concentration ($S_0 = 50 \text{ g L}^{-1}$), a high cell density of 40 g L^{-1} was achieved in the perfusion culture of *N. laevis* (Figure 6.7c). Together with the relatively simple setup and operation as well as high biomass

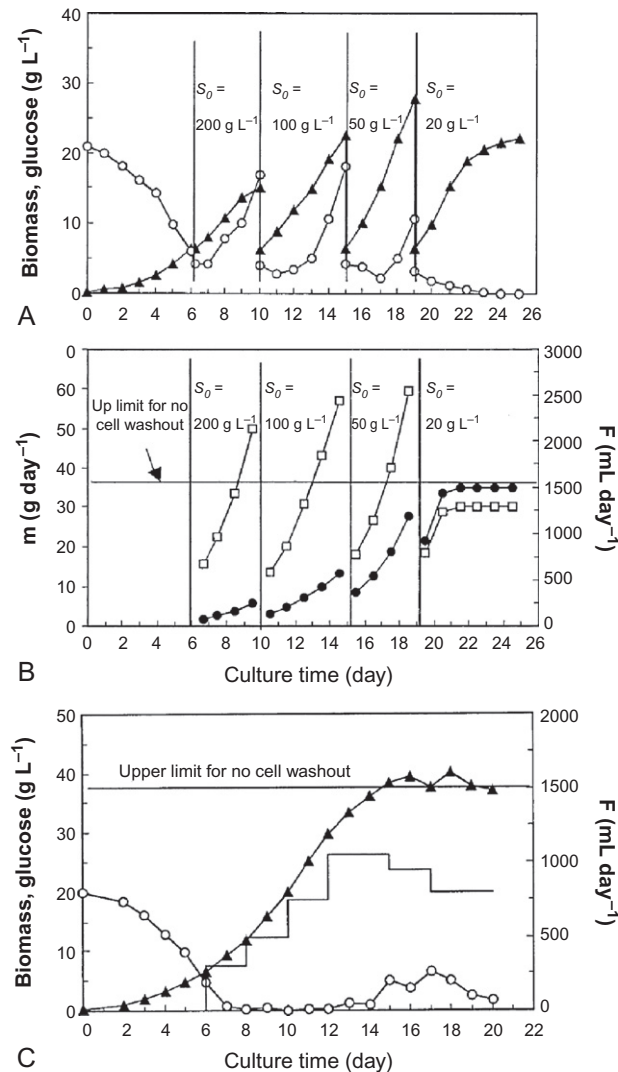

FIGURE 6.7 Perfusion culture of *Nitzschia laevis* with glucose as the carbon source. (A) Growth and glucose consumption of *N. laevis* at different S_0 (with exponential feeding strategy employed); (B) glucose mass supply rate (m) and volumetric perfusion rate (F) of *N. laevis* at different S_0 (with exponential feeding strategy employed); (C) time course of growth and glucose consumption of *N. laevis* with feed glucose concentration (S_0) at 50 g L^{-1} . (○) glucose; (▲) biomass; (□) glucose mass supply rate; (●, line) volumetric perfusion rate. Adapted from Wen and Chen (2002a) with permission to reprint.

yield coefficient based on glucose, the perfusion culture system potentially may be used to grow algae for heterotrophic production of bio-oils.

A modified perfusion culture system that introduces cell bleeding during perfusion operation was also developed for heterotrophic production of algae (Figure 6.5c; Wen and Chen, 2001b). This system could potentially improve the biomass productivity but at the same time lower the cell density, e.g., from 40 g L⁻¹ to less than 20 g L⁻¹ (Wen and Chen, 2001b; Wen and Chen, 2002a).

It is worth mentioning that different algal species/strains may favor different culture systems to achieve maximized cell density, biomass productivity, and oil productivity. An experimental optimization is required for a selected algal strain to demonstrate which culture system is best for the heterotrophic production of oils. Regardless of the algal strain selected and culture system used, the key to optimizing a production system rests with the cost balance of output and input from a cost-effectiveness point of view.

6.6 CHLORELLA AS THE CELL FACTORY FOR HETEROTROPHIC OILS

Chlorella is a genus of unicellular, nonmobile green microalgae first described by Beijerinck in 1890, with *Chlorella vulgaris* being the type species. Commonly, *Chlorella* cells are spherical or ellipsoidal with sizes ranging from 2 to 10 μm in diameter. They are distributed in diverse habitats such as freshwater, seawater, and soil and are free-living or symbiotic with lichens and protozoa (Görs et al., 2010). *Chlorella* cells reproduce themselves through asexual autospore production. Autospores are simultaneously released through rupture of the mother cell wall, with the number varying from 2 to 16. *Chlorella* has a thick and rigid cell wall, the structure of which may differ greatly among species.

There have been more than 100 strains of *Chlorella* reported in the literature. Because they lack conspicuous morphological characters, the classification of *Chlorella* has been problematic. An attempt was made to classify *Chlorella* species based on certain biochemical and physiological characters, i.e., hydrogenase, secondary carotenoids, acid and salt tolerance, lactic acid fermentation, nitrate reduction, thiamine requirement, and the GC content of DNA (Kessler, 1976). By comparing these characters, Kessler (1976) assigned 77 strains of *Chlorella* from the Culture Collection of Algae at Göttingen (SAG, Germany) to 12 taxa and suggested that *Chlorella* represents an assembly of morphologically similar species of a polyphyletic origin. Afterward, Kessler and Huss (1992) examined 58 *Chlorella* strains from the Culture Collection of Algae at the University of Texas at Austin using the above-mentioned biochemical and physiological characters and assigned them into 10 previously established species. The sugar composition of cell walls (either glucosamine or glucose and mannose) was also used as a taxonomical marker for *Chlorella* classification (Takeda, 1991, 1993). Using a 18S rRNA-based phylogenetic approach, Huss et al. (1999) revised the *Chlorella* genus and considered it as a polyphyletic assemblage dispersed over two classes of Chlorophyta, i.e., Chlorophyceae and Trebouxiophyceae. Only four species were suggested to be kept in the *Chlorella* genus: *Chlorella vulgaris*, *Chlorella sorokiniana*, *Chlorella kessleri*, and *Chlorella lobophora*. Later, Krienitz et al (2004) excluded *Chlorella kessleri* from the *Chlorella* genus and reduced the number of species to three. Here we will regard *Chlorella* as *Chlorella sensu lato* and include

the data obtained from those *Chlorella* species that may have been excluded from the *Chlorella* genus by the studies mentioned.

6.6.1 Oil Production Potential

Chlorella has long been used as human health food. Under certain stress conditions, *Chlorella* species are capable of accumulating as high as 60% (w/w, on dry-weight basis) oil within cells (Table 6.4). Together with the characteristics of high growth rate and ease of culture and scale-up in bioreactors, *Chlorella* has attracted unprecedented interest as a feedstock for biofuels, in particular biodiesel (Xu et al 2006; Li et al 2007a; Xiong et al 2008; Hsieh and Wu 2009; Gao et al 2010; Liu et al 2010, 2012a). The synthesized fatty acids in *Chlorella* are mainly of medium length, ranging from 16 to 18 carbons, despite the great variation in fatty acid composition (Table 6.5). Generally, saturated fatty esters possess high cetane numbers and superior oxidative stability, whereas unsaturated, especially polyunsaturated, fatty esters have improved low-temperature properties (Knothe, 2008). It is suggested that the modification of fatty esters—for example, enhancing the proportion of oleic acid (C18:1) ester—can provide a compromise solution between oxidative stability and low-temperature properties and therefore promote the quality of biodiesel (Knothe, 2009). In this regard, *C. protothecoides*, with the highest proportion of oleic acid (71.6%), may be better than other *Chlorella* species as biodiesel feedstock (Cheng et al., 2009). The properties of *C. protothecoides*-derived biodiesel were assessed, and most of them proved to comply with the limits established by the American Society for Testing and Materials (Xu et al., 2006).

There are increasing reports of using heterotrophic *C. protothecoides* cultures for oil production, from laboratory scale to large scale of 11,000-L of culture volume (Table 6.4). The scale-up from 5 to 11,000 L just caused a slight decrease in productivities, suggesting the *C. protothecoides* may represent a potential producer of oils for commercially large-scale production (Li et al., 2007a). In a nonoptimized fed-batch culture of *C. protothecoides*, the record cell density, biomass productivity, and oil productivity were achieved by Yan et al (2011), namely, 97.1 g L⁻¹, 12.8 g L⁻¹ day⁻¹, and 7.3 g L⁻¹ day⁻¹, respectively. Later, using a nonlinear-mode-based optimization approach, De la Hoz Siegler et al. (2012) maximized the cell density and oil productivity of fed-batch culture of *C. protothecoides* to 144 g L⁻¹ and 20.2 g L⁻¹ day⁻¹.

6.6.2 Downstream Processes

Downstream processes of *C. protothecoides* cultures include biomass harvest and drying, cell disruption, oil extraction, and transesterification for biodiesel. Various harvesting methods are applied to *Chlorella* cultures, including flocculation, flotation, filtration, gravity sedimentation, and centrifugation (Lin, 2005; Wiley et al., 2009; Papazi et al., 2010; Lee et al., 2012). The harvest efficiency rests not only with harvesting methods used but also algal species, culture ages, and cell densities. Usually, a harvesting method is not used alone but is coupled with one or more other methods to achieve the highest harvesting efficiency, e.g., a preceding treatment of flocculation was used to improve the performance of flotation, filtration, sedimentation, or centrifugation (Sim et al., 1988; Liu et al., 1999; Wiley et al., 2009). A drying

TABLE 6.4 Growth and Lipid Production of *C. protothecoides* Feeding on Various Organic Carbon Sources.

Cell Density (g L ⁻¹)	Biomass Productivity (g L ⁻¹ day ⁻¹)	Lipid Productivity (g L ⁻¹ day ⁻¹)	Organic Carbons	Culture Conditions ^a	References
16.5	3.6	1.60	Hydrolysate of Jerusalem artichoke tuber	B, flask, 1 L	Cheng et al., 2009
10.8	1.7	0.95	Glucose	B, flask, 1 L	De la Hoz Siegler et al., 2011
30	3.3	1.9	Glucose	FB, bioreactor, 2 L	
—	—	12.3 ^b	Glucose	C, bioreactor, 2 L	
144	—	20.2	Glucose	FB, bioreactor, 2 L	De la Hoz Siegler et al., 2012
6	1.2	0.59	Hydrolysate of sweet sorghum juice	B, flask, 500 mL	Gao et al., 2010
15.5	2.0	0.93	Glucose	FB, bioreactor, 5 L	Li et al., 2007a
12.8	1.7	0.81	Glucose	FB, bioreactor, 750 L	
14.2	1.7	0.73	Glucose	FB, bioreactor, 11,000 L	
14	3.2	1.85	Glycerol	B, flask	O'Grady et al., 2011
13.1	1.46	0.85	Glucose	B, flask, 250 mL	Shen et al., 2010
14.2	2.2	1.2	Glucose	B, bioreactor, 5 L	Xiong et al., 2010b
51.2	6.6	3.3	Glucose	FB, bioreactor, 5 L	Xiong et al., 2008
15.5	2.0	1.1	Glucose	FB, bioreactor, 5 L	Xu et al., 2006
3.7	0.7	0.36	Corn powder hydrolysate	B, flask, 500 mL	
17.9	3.6	1.45	Hydrolyzed molasses	B, flask, 500 mL	Yan et al., 2011
97.1	12.8	7.3	Hydrolyzed molasses	FB, bioreactor, 5 L	
46	6.28	2.06	Glucose	FB, bioreactor, 7 L	Chen and Walker, 2012

^a B, batch; FB, fed-batch; C, continuous.

^b Predicted value.

process following biomass harvest may be needed, depending on whether drying or wet biomass is used for oil extraction. The harvest and drying processes may contribute 20–30% of the total cost of photoautotrophic algal biomass production ([Molina Grima et al., 2003](#)). Although the high cell density associated with heterotrophic algae can reduce the cost contribution,

TABLE 6.5 Fatty Acid Profiles of Selected *Chlorella* Species.

<i>Chlorella</i> Species	C14:0	C15:0	C16:0	C16:1	C16:2	C16:3	C17:0	C18:0	C18:1	C18:2	C18:3	C20 or Above	References
<i>C. ellipsoidea</i>	2		26						4	40	23	5	Abou-Shanab et al., 2011
<i>C. minutissima</i>	2.8		13.5	1.1				3.4	46.1	26.7	3.3		Li et al., 2011
<i>C. protothecoides</i>			14.3	1				2.7	71.6	9.7			Cheng et al., 2009
<i>C. protothecoides</i>	1.1		11.7	0.3			0.4	5.6	59.4	19.1	2.1	0.5	Chen and Walker, 2012
<i>C. protothecoides</i>	2.3		26.2	0.8				17.6	47.6	0.8	0.1	4.5	De la Hoz Siegler et al., 2012
<i>C. pyrenoidosa</i>			17.3		7	9.3		1.2	3.3	18.5	41.8		D'oca et al., 2011
<i>C. saccharophila</i>	2.7		17.6					4.9	32.2	31.1	9.8		Isleten-Hosoglu et al., 2012
<i>C. sorokiniana</i>			25.4	3.1	10.7	4.1		1.4	12.4	34.4	7.1		Chen and Johns, 1991
<i>C. sp</i>			19.1	1				3.1	25.9	6.8	44.2		Matsumoto et al., 2010
<i>C. sp</i>			20.6	6.6	10.4	6	3.4	2.4	12.5	27.2	10.2		Wang et al., 2010
<i>C. sp</i>	3.3	6.4	49.5					10.1	28.5	1.3			Yeesang and Cheirsilp, 2011
<i>C. vulgaris</i>			19.2				4.2	14.6	12.7	3.8	21.1	13.8	Cleber Bertoldi et al., 2006
<i>C. vulgaris</i>			63					9	3	11	13		Converti et al., 2009
<i>C. vulgaris</i>			24	2.1				1.3	24.8	47.8			Yoo et al., 2010
<i>C. vulgaris</i>	1		32	26			1	5	14	28		3	Heredia-Arroyo et al., 2011
<i>C. zofingiensis</i>			22.6	2	7.4	2		2.1	35.7	18.5	7.8		Liu et al., 2010
<i>C. zofingiensis</i>			22.8	2.5	7.5	1.8		2.7	34.2	19.7	7.3		Liu et al., 2012a

finding ways to improve the cost-effectiveness of the harvest and drying steps still represents a big challenge for the *Chlorella* industry if it is to expand from the current high-value, low-quantity specialty products market to a low-value, high-volume commodity products market.

Chlorella has a tough, rigid cell wall, and thus disruption of the cell wall is required for the facilitation of oil extraction. Various disruption methods, e.g., mechanical crushing, ultrasonic treatment, and enzymatic degradation, can be employed for cell-wall disruption. The oils released after cell disruption are suitable for extraction using organic solvents. Supercritical CO₂ is another way for efficiently extracting algal oils, but it is expensive and energy intensive, which restricts the commercialization of this technology (Herrero et al., 2010).

The extracted algal oils are suitable for biodiesel conversion through transesterification. *Transesterification* is a catalytic reaction of oils with a short-chain alcohol (typically methanol or ethanol) to form fatty acid esters. The reaction is reversible; as such, a large excess of alcohol is used in industrial processes to ensure the direction of fatty acid esters. Methanol is the preferred alcohol for industrial use because of its low cost. Commonly, a catalyst is required to facilitate the transesterification, including acids, alkalis, and enzymes. Acid transesterification is considered suitable for the conversion of oils with high free fatty acids but with low reaction rate (Gerpen, 2005). In contrast, alkali catalyzes a much higher transesterification rate, though it is unfavorable for free fatty acids (Fukuda et al., 2001). As a result, alkalis are preferred catalysts for industrial production of biodiesel, and acid pretreatment is usually employed when the oils contain a high content of free fatty acids. The use of lipases for transesterification has also attracted much attention because it produces a high-purity product and enables easy separation of biodiesel from the byproduct glycerol (Ranganathan et al., 2008). However, the cost of the enzyme is still relatively high and remains a barrier to its industrial implementation.

6.7 POSSIBLE IMPROVEMENTS OF ECONOMICS IN HETEROTROPHIC ALGAL OILS

Although heterotrophy of algae shows its potential for oil production, the overall production cost of heterotrophic oils remains relatively high, restricting the commercialization of heterotrophic algal oils. From an estimation of Yan et al. (2011) using heterotrophic *C. protothecoides* for oil production, the unit production cost of algal oils was still much higher than that of plant oils. Glucose represents a major share of the cost of heterotrophic oil production. Using alternative low-cost carbon sources may represent a promising approach to bring down the cost of heterotrophic algal oils. Recently, it has been reported that low-cost sugars were used to grow algae for heterotrophic oil production, e.g., hydrolyzed carbohydrates (Xu et al., 2006; Cheng et al., 2009; Gao et al., 2010) and waste molasses (Yan et al., 2011; Liu et al., 2012a). All these reports suggested the potential of producing algal oils for less cost, such that the algal oils from *C. protothecoides* based on waste molasses cost approximately half those based on glucose (Yan et al., 2011).

The heterotrophic utilization of sugars for biomass by algae remains at a relatively low level, namely, below 0.5 (Cheng et al., 2009; Liu et al., 2010; Yan et al., 2011), which means that more than 50% of sugars were wasted in the form of CO₂. To increase the sugar-to-biomass conversion, a photosynthesis-fermentation mode was proposed and resulted in a

high sugar-to-biomass conversion of 0.62 (Xiong et al., 2010b). The increased sugar-conversion efficiency may be attributed to the refixation of partial CO₂ released from sugar catabolism by the enzyme RuBisCO, which maintained its carboxylation activity in the fermentation stage (Xiong et al., 2010b). In a fermentation system, productivity is greatly related to the medium nutrients as well as fermentation parameters. The manipulation of these factors to achieve a maximized output/input ratio may have great potential for improving production economics of heterotrophic algal oils.

Heterotrophic algal biomass contains not only oils but also substantial amounts of proteins and carbohydrates as well as high-value components such as pigments and vitamins. From a biorefinery's point of view, the residual biomass after oil extraction can be potentially used as food additives, nutraceuticals, and animal feed (Figure 6.8). Also, carbohydrates may be utilized for producing the bio-gas methane by anaerobic digestion. The integrated production of oils and other value-added production, coupled with the possible recycling of water and nutrients, remains a potential strategy to reduce the production cost of algal oils.

Strain improvement by genetic engineering is another feasible and complementary approach to enhancing algal productivity and improving the economics of algal oil production. Introduction of a bacterial hemoglobin in various hosts has been shown to contribute to growth improvement in oxygen-limited conditions (Zhang et al., 2007). This strategy is particularly suitable for heterotrophic growth of algae to achieve the ultrahigh cell density that may be restricted by the lowered dissolved oxygen associated with cell mass buildup. Theoretically, enhanced oil content can be achieved by the direct genetic engineering of oil biosynthetic pathways, e.g., overexpression of the genes involved in fatty acid/lipid synthesis (Madoka et al., 2002; Lardizabal et al 2008); the manipulation of transcriptional factors

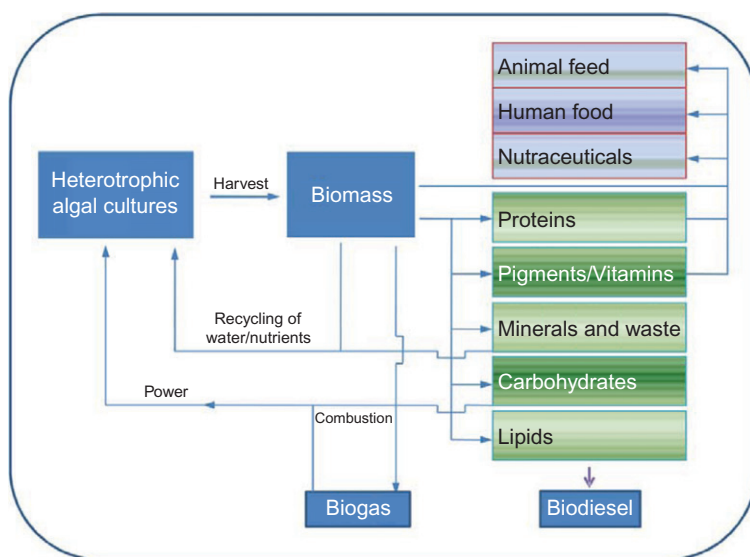

FIGURE 6.8 Schematic illustration of integrated production of biofuels and other products.

related to lipid biosynthesis regulation (Courchesne et al., 2009); or the blocking of competing metabolic pathways that share the common carbon precursors such as starch synthesis (Li et al., 2010). Genetic engineering can also be employed to alter fatty acid compositions of oils for improving biofuel quality, e.g., heterologous expression of thioesterases to accumulate shorter-chain-length fatty acids (Radakovits et al., 2011) or inactivation of the $\Delta 12$ desaturase gene to produce more oleic acid (Graef et al., 2009). In addition, genetic engineering may confer on algae the possibly improved characteristics of tolerance of temperature, salinity, and pH, which will allow cost reduction in algal biomass production and be beneficial for growing selected algae under extreme conditions that limit the proliferation of invasive species. Although genetic engineering of algal oils is currently restricted to certain model algae such as *Chlamydomonas*, the rapid advances in the development of genetic manipulation tools, plus the better understanding of lipid biosynthesis and regulation, will be extended to industrially important algal species for improving the economics of algal oil production.

6.8 CONCLUSIONS

Heterotrophic production has substantial advantages, including rapid growth, ultrahigh cell density, high oil content, and substantial oil productivity. These merits allow significantly lower downstream process costs, though so far the overall oil production from heterotrophic algae is considered not as economically viable as phototrophic production of algal oils. The relatively high cost of heterotrophic algal oils is mainly attributed to the use of expensive organic carbon—in particular, glucose. Advances in the exploration of using low-cost raw materials such as hydrolyzed carbohydrates and waste sugars have enabled potential cost reductions in heterotrophic production of algal oils. Finding ways to further improve the production economics still remains the major challenge ahead for commercialization of heterotrophic algal oils, which will depend to a large extent on significant advancements in culture systems, biorefinery-based integrated production, and algal strain improvement. Breakthroughs and innovations occurring in these areas will greatly expand production capacity and lower production costs, driving heterotrophic algae from today's high-value market into the low-cost commodity product pipelines.

Thanks to the increasing interest of using *Chlorella* biomass as the feedstock for oils, great achievements have been made in heterotrophic culture systems and production models for the algae of this genus, allowing ultrahigh cell density comparable to oleaginous yeasts. To this end, sequencing both the genomes and transcriptomes of several typical *Chlorella* strains is currently underway, which will benefit the development of a new molecular toolbox to successfully manipulate *Chlorella* for more economically feasible industrial production.

Acknowledgments

This study was partially supported by a grant from the 985 Project of Peking University and by the State Oceanic Administration of China.

References

- Abou-Shanab, R.A.I., Hwang, J.H., Cho, Y., Min, B., Jeon, B.H., 2011. Characterization of microalgal species isolated from fresh water bodies as a potential source for biodiesel production. *Appl. Energ.* 88, 3300–3306.
- Azma, M., Mohamed, M.S., Mohamad, R., Rahim, R.A., Ariff, A.B., 2011. Improvement of medium composition for heterotrophic cultivation of green microalgae, *Tetraselmis suecica*, using response surface methodology. *Biochem. Eng. J.* 53, 187–195.
- Borowitzka, M.A., 1999. Commercial production of microalgae: ponds, tanks, tubes and fermenters. *J. Biotechnol.* 70, 313–321.
- Bouarab, L., Dauta, A., Loudiki, M., 2004. Heterotrophic and mixotrophic growth of *Micractinium pusillum* Fresenius in the presence of acetate and glucose: Effect of light and acetate gradient concentration. *Water Res.* 38, 2706–2712.
- Boyle, N.R., Page, M.D., Liu, B., Blaby, I.K., Casero, D., Kropat, J., et al., 2012. Three acyltransferases and nitrogen-responsive regulator are implicated in nitrogen starvation-induced triacylglycerol accumulation in *Chlamydomonas*. *J. Biol. Chem.* 287, 15811–15825.
- Burhenne, N., Tischner, R., 2000. Isolation and characterization of nitrite-reductase-deficient mutants of *Chlorella sorokiniana* (strain 211-8k). *Planta* 211, 440–445.
- Burlew, J.S., 1964. Algal culture: from laboratory to pilot plant. Carnegie Institute of Washington publication, Washington, D.C., USA.
- Chen, F., 1996. High cell density culture of microalgae in heterotrophic growth. *Trends Biotechnol.* 14, 421–426.
- Chen, G.Q., Chen, F., 2006. Growing phototrophic cells without light. *Biotechnol. Lett.* 28, 607–616.
- Chen, F., Johns, M., 1991. Effect of C/N ratio and aeration on the fatty acid composition of heterotrophic *Chlorella sorokiniana*. *J. Appl. Phycol.* 3, 203–209.
- Chen, F., Johns, M.R., 1994. Substrate inhibition of *Chlamydomonas reinhardtii* by acetate in heterotrophic culture. *Process Biochem.* 29, 245–252.
- Chen, F., Johns, M., 1995. A strategy for high cell density culture of heterotrophic microalgae with inhibitory substrates. *J. Appl. Phycol.* 7, 43–46.
- Chen, F., Johns, M.R., 1996. Heterotrophic growth of *Chlamydomonas reinhardtii* on acetate in chemostat culture. *Process Biochem.* 31, 601–604.
- Chen, Y.H., Walker, T.H., 2012. Fed-batch fermentation and supercritical fluid extraction of heterotrophic microalgal *Chlorella protothecoides* lipids. *Bioresour. Technol.* 114, 512–517.
- Chen, F., Chen, H., Gong, X., 1997. Mixotrophic and heterotrophic growth of *Haematococcus lacustris* and rheological behaviour of the cell suspensions. *Bioresour. Technol.* 62, 19–24.
- Chen, G.Q., Jiang, Y., Chen, F., 2008. Salt-induced alterations in lipid composition of diatom *Nitzschia laevis* (Bacillariophyceae). *J. Phycol.* 44, 1309–1314.
- Cheng, Y., Zhou, W., Gao, C., Lan, K., Gao, Y., Wu, Q., 2009. Biodiesel production from Jerusalem artichoke (*Helianthus Tuberosus* L.) tuber by heterotrophic microalgae *Chlorella protothecoides*. *J. Chem. Technol. Biotechnol.* 84, 777–781.
- Chisti, Y., 2007. Biodiesel from microalgae. *Biotechnol. Adv.* 25, 294–306.
- Chisti, Y., 2008. Biodiesel from microalgae beats bioethanol. *Trends Biotechnol.* 26, 126–131.
- Chojnacka, K., Noworyta, A., 2004. Evaluation of *Spirulina* sp. growth in photoautotrophic, heterotrophic and mixotrophic cultures. *Enzyme Microb. Technol.* 34, 461–465.
- Cleber Bertoldi, F., Sant’anna, E., Braga, M.V.D.C., Luiz Barcelos Ollveira, J., 2006. Lipids, fatty acids composition and carotenoids of *Chlorella vulgaris* cultivated in hydroponic wastewater. *Grasas Aceites* 57, 270–274.
- Converti, A., Casazza, A.A., Ortiz, E.Y., Perego, P., Del Borghi, M., 2009. Effect of temperature and nitrogen concentration on the growth and lipid content of *Nannochloropsis oculata* and *Chlorella vulgaris* for biodiesel production. *Chem. Eng. Process* 48, 1146–1151.
- Courchesne, N.M.D., Parisien, A., Wang, B., Lan, C.Q., 2009. Enhancement of lipid production using biochemical, genetic and transcription factor engineering approaches. *J. Biotechnol.* 141, 31–41.
- Couto, R.M., Simoes, P.C., Reis, A., Da Silva, T.L., Martins, V.H., Sanchez-Vicente, Y., 2010. Supercritical fluid extraction of lipids from the heterotrophic microalga *Cryptocodinium colnii*. *Eng. Life Sci.* 10, 158–164.
- Davis, E.A., Dedrick, J., French, C.S., Milner, H.W., Myers, J., Smith, J.H.C., et al., 1964. Laboratory experiments on *Chlorella* culture at the Carnegie Institution of Washington Department of Plant Biology. In: Burlew, J.S. (Ed.), Algal culture: from laboratory to pilot plant. Carnegie Institute of Washington publication, Washington, D.C., USA, pp. 105–153.

- Dawson, H.N., Burlingame, R., Cannons, A.C., 1997. Stable transformation of *Chlorella*: Rescue of nitrate reductase-deficient mutants with the nitrate reductase gene. *Curr. Microbiol.* 35, 356–362.
- Day, J., Tsavalos, A., 1996. An investigation of the heterotrophic culture of the green alga *Tetraselmis*. *J. Appl. Phycol.* 8, 73–77.
- Day, J.D., Edwards, A.P., Rodgers, G.A., 1991. Development of an industrial-scale process for the heterotrophic production of a micro-algal mollusc feed. *Bioresour. Technol.* 38, 245–249.
- De la Hoz Siegler, H., Ben-Zvi, A., Burrell, R.E., McCaffrey, W.C., 2011. The dynamics of heterotrophic algal cultures. *Bioresour. Technol.* 102, 5764–5774.
- De la Hoz Siegler, H., McCaffrey, W.C., Burrell, R.E., Ben-Zvi, A., 2012. Optimization of microalgal productivity using an adaptive, non-linear model-based strategy. *Bioresour. Technol.* 104, 537–546.
- de Swaaf, M.E., Pronk, J.T., Sijtsma, L., 2003. High-cell-density fed-batch cultivation of the docosahexaenoic acid producing marine alga *Cryptocodinium cohnii*. *Biotechnol. Bioeng.* 81, 666–672.
- D'Oca, M.G.M., Viêgas, C.V., Lemões, J.S., Miyasaki, E.K., Morón-Villarreyes, J.A., Primel, E.G., et al., 2011. Production of FAMES from several microalgal lipidic extracts and direct transesterification of the *Chlorella pyrenoidosa*. *Biomass Bioenerg.* 35, 1533–1538.
- Endo, H., Sansawa, H., Nakajima, K., 1977. Studies on *Chlorella regularis*, heterotrophic fast-growing strain II. Mixotrophic growth in relation to light intensity and acetate concentration. *Plant Cell Physiol.* 18, 199–205.
- Ethier, S., Woisard, K., Vaughan, D., Wen, Z., 2011. Continuous culture of the microalgae *Schizochytrium limacinum* on biodiesel-derived crude glycerol for producing docosahexaenoic acid. *Bioresour. Technol.* 102, 88–93.
- Fan, K.W., Jiang, Y., Faan, Y.W., Chen, F., 2007. Lipid characterization of Mangrove thraustochytrid *Schizochytrium mangrovei*. *J. Agr. Food Chem.* 55, 2906–2910.
- Fukuda, H., Kondo, A., Noda, H., 2001. Biodiesel fuel production by transesterification of oils. *J. Biosci. Bioeng.* 92, 405–416.
- Ganaza, E., Anderson, A.J., Ratledge, C., 2008. High-cell-density cultivation of *Schizochytrium* sp. in an ammonium/pH-auxostat fed-batch system. *Biotechnol. Lett.* 30, 1559–1564.
- Gao, C., Zhai, Y., Ding, Y., Wu, Q., 2010. Application of sweet sorghum for biodiesel production by heterotrophic microalga *Chlorella protothecoides*. *Appl. Energ.* 87, 756–761.
- García-Ferris, C., de los Ríos, A., Ascaso, C., Moreno, J., 1996. Correlated biochemical and ultrastructural changes in nitrogen-starved *Euglena gracilis*. *J. Phycol.* 32, 953–963.
- Gerpen, J.V., 2005. Biodiesel processing and production. *Fuel Process Technol.* 86, 1097–1107.
- Gladue, R., Maxey, J., 1994. Microalgal feeds for aquaculture. *J. Appl. Phycol.* 6, 131–141.
- Goldman, J.C., Brewer, P.G., 1980. Effect of nitrogen source and growth rate on phytoplankton-mediated changes in alkalinity. *Limnol. Oceanogr.* 25, 352–357.
- Görs, M., Schumann, R., Gustavs, L., Karsten, U., 2010. The potential of ergosterol as chemotaxonomic marker to differentiate between “*Chlorella*” species (Chlorophyta). *J. Phycol.* 46, 1296–1300.
- Graef, G., LaVallee, B.J., Tenopir, P., Tat, M., Schweiger, B., Kinney, A.J., et al., 2009. A high-oleic-acid and low-palmitic-acid soybean: agronomic performance and evaluation as a feedstock for biodiesel. *Plant Biotechnol. J.* 7, 411–421.
- Guarnieri, M.T., Nag, A., Smolinski, S.L., Darzins, A., Seibert, M., Pienkos, P.T., 2011. Examination of triacylglycerol biosynthetic pathways via de novo transcriptomic and proteomic analyses in an unsequenced microalga. *PLoS ONE* 6, e25851.
- Guerrini, F., Cangini, M., Boni, L., Trost, P., Pistocchi, R., 2000. Metabolic responses of the diatom *Achnanthes brevipes*. (Bacillariophyceae) to nutrient limitation. *J. Phycol.* 36, 882–890.
- Hallmann, A., Sumper, M., 1996. The *Chlorella* hexose H⁺ symporter is a useful selectable marker and biochemical reagent when expressed in *Volvox*. *Proc. Natl. Acad. Sci. U. S. A.* 93, 669–673.
- Heredia-Arroyo, T., Wei, W., Ruan, R., Hu, B., 2011. Mixotrophic cultivation of *Chlorella vulgaris* and its potential application for the oil accumulation from non-sugar materials. *Biomass Bioenerg.* 35, 2245–2253.
- Herrero, M., Mendiola, J.A., Cifuentes, A., Ibáñez, E., 2010. Supercritical fluid extraction: Recent advances and applications. *J. Chromatogr. A* 1217, 2495–2511.
- Hilaly, A.K., Karim, M.N., Guyre, D., 1994. Optimization of an industrial microalgae fermentation. *Biotechnol. Bioeng.* 43, 314–320.
- Hong, S.J., Lee, C.G., 2007. Evaluation of central metabolism based on a genomic database of *Synechocystis* PCC6803. *Biotechnol. Bioprocess. Eng.* 12, 165–173.

- Hu, Q., Guterman, H., Richmond, A., 1996. A flat inclined modular photobioreactor for outdoor mass cultivation of photoautotrophs. *Biotechnol. Bioeng.* 51, 51–60.
- Hu, Q., Kurano, N., Kawachi, M., Iwasaki, I., Miyachi, S., 1998. Ultrahigh-cell-density culture of a marine green alga *Chlorococcum littorale* in a flat-plate photobioreactor. *Appl. Microbiol. Biotechnol.* 49, 655–662.
- Hu, Q., Sommerfeld, M., Jarvis, E., Ghirardi, M., Posewitz, M., Seibert, M., et al., 2008. Microalgal triacylglycerols as feedstocks for biofuel production: perspectives and advances. *Plant J.* 54, 621–639.
- Huss, V.A.R., Frank, C., Hartmann, E.C., Hirmer, M., Kloboucek, A., Seidel, B.M., et al., 1999. Biochemical taxonomy and molecular phylogeny of the genus *Chlorella* sensu lato (Chlorophyta). *J. Phycol.* 35, 587–598.
- Hsieh, C.H., Wu, W.T., 2009. Cultivation of microalgae for oil production with a cultivation strategy of urea limitation. *Bioresour. Technol.* 100, 3921–3926.
- Illman, A.M., Scragg, A.H., Shales, S.W., 2000. Increase in *Chlorella* strains calorific values when grown in low nitrogen medium. *Enzyme Microb. Technol.* 27, 631–635.
- Ip, P.F., Chen, F., 2005. Production of astaxanthin by the green microalga *Chlorella zofingiensis* in the dark. *Process Biochem.* 40, 733–738.
- Isleten-Hosoglu, M., Gultepe, I., Elibol, M., 2012. Optimization of carbon and nitrogen sources for biomass and lipid production by *Chlorella saccharophila* under heterotrophic conditions and development of Nile red fluorescence based method for quantification of its neutral lipid content. *Biochem. Eng. J.* 61, 11–19.
- Jiang, Y., Chen, F., 2000a. Effects of temperature and temperature shift on docosahexaenoic acid production by the marine microalga *Cryptothecodinium cohnii*. *J. Am. Oil Chem. Soc.* 77, 613–617.
- Jiang, Y., Chen, F., 2000b. Effects of medium glucose concentration and pH on docosahexaenoic acid content of heterotrophic *Cryptothecodinium cohnii*. *Process Biochem.* 35, 1205–1209.
- Jiang, Y., Chen, F., Liang, S.Z., 1999. Production potential of docosahexaenoic acid by the heterotrophic marine dinoflagellate *Cryptothecodinium cohnii*. *Process Biochem.* 34, 633–637.
- Kennedy, M., Krouse, D., 1999. Strategies for improving fermentation medium performance: a review. *J. Ind. Microbiol. Biotechnol.* 23, 456–475.
- Kessler, E., 1976. Comparative physiology, biochemistry, and the taxonomy of *Chlorella* (Chlorophyceae). *Plant Syst. Evol.* 125, 129–138.
- Kessler, E., Huss, V.A.R., 1992. Comparative physiology and biochemistry and taxonomic assignment of the *Chlorella* (Chlorophyceae) strains of the culture collection of the University of Texas at Austin. *J. Phycol.* 28, 550–553.
- Kiseleva, M.A., Kotlova, E.R., 2007. The synthesis and utilization of extrachloroplastic lipids in photo- and heterotrophic cultures of the unicellular green algae *Pseudococcomyxa chodatii* grown under phosphate deprivation. *Chem. Phys. Lipids* 149, S81.
- Knothe, G., 2005. Dependence of biodiesel fuel properties on the structure of fatty acid alkyl esters. *Fuel Process Technol.* 86, 1059–1070.
- Knothe, G., 2008. “Designer” biodiesel: Optimizing fatty ester composition to improve fuel properties. *Energ. Fuel* 22, 1358–1364.
- Knothe, G., 2009. Improving biodiesel fuel properties by modifying fatty ester composition. *Energ. Environ. Sci.* 2, 759–766.
- Kobayashi, M., Kakizono, T., Yamaguchi, K., Nishio, N., Nagai, S., 1992. Growth and astaxanthin formation of *Haematococcus pluvialis* in heterotrophic and mixotrophic conditions. *J. Ferment Bioeng.* 74, 17–20.
- Kong, R., Xu, X., Hu, Z., 2003. A TPR-family membrane protein gene is required for light-activated heterotrophic growth of the cyanobacterium *Synechocystis* sp. PCC 6803. *FEMS Microbiol. Lett.* 219, 75–79.
- Krienitz, L., Hegewald, E.H., Hepperle, D., Huss, V.A.R., Rohr, T., Wolf, M., 2004. Phylogenetic relationship of *Chlorella* and *Parachlorella* gen. nov. (Chlorophyta, Trebouxiophyceae). *Phycologia* 43, 529–542.
- Kurosawa, K., Boccazzi, P., de Almeida, N.M., Sinskey, A.J., 2010. High-cell-density batch fermentation of *Rhodococcus opacus* PD630 using a high glucose concentration for triacylglycerol production. *J. Biotechnol.* 147, 212–218.
- Lacour, T., Sciandra, A., Talec, A., Mayzaud, P., Bernard, O., 2012. Neutral lipid and carbohydrate productivities as a response to nitrogen status in *Isochrysis* sp. (T-ISO; Haptophyceae): Starvation versus limitation. *J. Phycol.* 48, 647–656.
- Lardizabal, K., Effertz, R., Levering, C., Mai, J., Pedroso, M.C., Jury, T., et al., 2008. Expression of *Umbelopsis ramanniana* DGAT2A in seed increases oil in soybean. *Plant Physiol.* 148, 89–96.
- Lee, Y.K., Ding, S.Y., Low, C.S., Chang, Y.C., Forday, W., Chew, P.C., 1995. Design and performance of an α -type tubular photobioreactor for mass cultivation of microalgae. *J. Appl. Phycol.* 7, 47–51.

- Lee, D.J., Liao, G.Y., Chang, Y.R., Chang, J.S., 2012. Coagulation-membrane filtration of *Chlorella vulgaris*. *Bioresour. Technol.* 108, 184–189.
- Li, X., Xu, H., Wu, Q., 2007a. Large-scale biodiesel production from microalga *Chlorella protothecoides* through heterotrophic cultivation in bioreactors. *Biotechnol. Bioeng.* 98, 764–771.
- Li, Y., Zhao, Z., Bai, F., 2007b. High-density cultivation of oleaginous yeast *Rhodospiridium toruloides* Y4 in fed-batch culture. *Enzyme Microb. Technol.* 41, 312–317.
- Li, Y., Han, D., Hu, G., Sommerfeld, M., Hu, Q., 2010. Inhibition of starch synthesis results in overproduction of lipids in *Chlamydomonas reinhardtii*. *Biotechnol. Bioeng.* 107, 258–268.
- Li, Z., Yuan, H., Yang, J., Li, B., 2011. Optimization of the biomass production of oil algae *Chlorella minutissima* UTEX2341. *Bioresour. Technol.* 102, 9128–9134.
- Liang, Y., Sarkany, N., Cui, Y., 2009. Biomass and lipid productivities of *Chlorella vulgaris* under autotrophic, heterotrophic and mixotrophic growth conditions. *Biotechnol. Lett.* 31, 1043–1049.
- Lin, L.P., 2005. *Chlorella: its ecology, structure, cultivation, bioprocess and application*. Yi Hsien Publishing, Taipei, Taiwan.
- Liu, J.C., Chen, Y.M., Ju, Y.-H., 1999. Separation of algal cells from water by column flotation. *Separ. Sci. Technol.* 34, 2259–2272.
- Liu, J., Huang, J., Fan, K.W., Jiang, Y., Zhong, Y., Sun, Z., et al., 2010. Production potential of *Chlorella zofingiensis* as a feedstock for biodiesel. *Bioresour. Technol.* 101, 8658–8663.
- Liu, J., Huang, J., Chen, F., 2011a. Microalgae as feedstocks for biodiesel production. In: Stoytcheva, M., Montero, G. (Eds.), *Biodiesel - Feedstocks and processing technologies*. InTech. Available from www.intechopen.com/articles/show/title/microalgae-as-feedstocks-for-biodiesel-production.
- Liu, J., Huang, J., Sun, Z., Zhong, Y., Jiang, Y., Chen, F., 2011b. Differential lipid and fatty acid profiles of photoautotrophic and heterotrophic *Chlorella zofingiensis*: Assessment of algal oils for biodiesel production. *Bioresour. Technol.* 102, 106–110.
- Liu, J., Huang, J., Jiang, Y., Chen, F., 2012a. Molasses-based growth and production of oil and astaxanthin by *Chlorella zofingiensis*. *Bioresour. Technol.* 107, 393–398.
- Liu, J., Sun, Z., Zhong, Y., Huang, J., Hu, Q., Chen, F., 2012b. Stearoyl-acyl carrier protein desaturase gene from the oleaginous microalga *Chlorella zofingiensis*: Cloning, characterization and transcriptional analysis. *Planta* 236, 1665–1676.
- Lombardi, A.T., Wangersky, P.J., 1991. Influence of phosphorus and silicon on lipid class production by the marine diatom *Chaetoceros gracilis* grown in turbidostat cage cultures. *Mar. Ecol. Prog. Ser.* 77, 39–47.
- Madoka, Y., Tomizawa, K.I., Mizoi, J., Nishida, I., Nagano, Y., Sasaki, Y., 2002. Chloroplast transformation with modified accD operon increases acetyl-CoA carboxylase and causes extension of leaf longevity and increase in seed yield in tobacco. *Plant Cell Physiol.* 43, 1518–1525.
- Martin-Jezequel, V., Hildebrand, M., Brzezinski, M., 2000. Silicate metabolism in diatoms: implications for growth. *J. Phycol.* 36, 821–840.
- Masojidek, J., Kopecky, J., Giannelli, L., Torzillo, G., 2011. Productivity correlated to photobiochemical performance of *Chlorella* mass cultures grown outdoors in thin-layer cascades. *J. Ind. Microbiol. Biotechnol.* 38, 307–317.
- Mata, T.M., Martins, A.A., Caetano, N.S., 2010. Microalgae for biodiesel production and other applications: A review. *Renew. Sust. Energ. Rev.* 14, 217–232.
- Matsumoto, M., Sugiyama, H., Maeda, Y., Sato, R., Tanaka, T., Matsunaga, T., 2010. Marine diatom, *Navicula* sp. strain JPCC DA0580 and marine green alga, *Chlorella* sp. strain NKG400014 as potential sources for biodiesel production. *Appl. Biochem. Biotechnol.* 161, 483–490.
- Miao, X., Wu, Q., 2006. Biodiesel production from heterotrophic microalgal oil. *Bioresour. Technol.* 97, 841–846.
- Miller, R., Wu, G., Deshpande, R.R., Vieler, A., Gartner, K., Li, X., et al., 2010. Changes in transcript abundance in *Chlamydomonas reinhardtii* following nitrogen deprivation predict diversion of metabolism. *Plant Physiol.* 154, 1737–1752.
- Mitra, D., van Leeuwen, J., Lamsal, B., 2012. Heterotrophic/mixotrophic cultivation of oleaginous *Chlorella vulgaris* on industrial co-products. *Algal Res.* 1, 40–48.
- Molina Grima, E., Sánchez Pérez, J.A., García Camacho, F., Fernández Sevilla, J.M., Ación Fernández, F.G., 1994. Effect of growth rate on the eicosapentaenoic acid and docosahexaenoic acid content of *Isochrysis galbana* in chemostat culture. *Appl. Microbiol. Biotechnol.* 41, 23–27.

- Molina Grima, E., Belarbi, E.H., Ación Fernández, F.G., Robles Medina, A., Chisti, Y., 2003. Recovery of microalgal biomass and metabolites: process options and economics. *Biotechnol. Adv.* 20, 491–515.
- Msanne, J., Xu, D., Konda, A.R., Casas-Mollano, J.A., Awada, T., Cahoon, E.B., et al., 2012. Metabolic and gene expression changes triggered by nitrogen deprivation in the photoautotrophically grown microalgae *Chlamydomonas reinhardtii* and *Coccomyxa* sp. C-169. *Phytochem.* 75, 50–59.
- Neilson, A.H., Lewin, R.A., 1974. The uptake and utilization of organic carbon by algae: an essay in comparative biochemistry. *Phycologia* 13, 227–264.
- O'Grady, J., Morgan, J.A., 2011. Heterotrophic growth and lipid production of *Chlorella protothecoides* on glycerol. *Bioprocess Biosyst. Eng.* 34, 121–125.
- Otero, A., García, D., Fábregas, J., 1997. Factors controlling eicosapentaenoic acid production in semicontinuous cultures of marine microalgae. *J. Appl. Phycol.* 9, 465–469.
- Pahl, S.L., Lewis, D.M., Chen, F., King, K.D., 2010. Heterotrophic growth and nutritional aspects of the diatom *Cyclotella cryptica* (Bacillariophyceae): Effect of some environmental factors. *J. Biosci. Bioeng.* 109, 235–239.
- Papazi, A., Makridis, P., Divanach, P., 2010. Harvesting *Chlorella minutissima* using cell coagulants. *J. Appl. Phycol.* 22, 349–355.
- Perez-García, O., Escalante, F.M.E., de-Bashan, L.E., Bashan, Y., 2011. Heterotrophic cultures of microalgae: Metabolism and potential products. *Water Res* 45, 11–36.
- Queiroz, M.I., Hornes, M.O., da Silva-Manetti, A.G., Jacob-Lopes, E., 2011. Single-cell oil production by cyanobacterium *Aphanothece microscopica* Nägeli cultivated heterotrophically in fish processing wastewater. *Appl. Energ.* 88, 3438–3443.
- Radakovits, R., Eduafo, P.M., Posewitz, M.C., 2011. Genetic engineering of fatty acid chain length in *Phaeodactylum tricornutum*. *Metab. Eng.* 13, 89–95.
- Radmer, R.J., Fisher, T.C., 1996. Large Scale Production of Docosahexaenoic Acid (DHA). In: Proceedings of Seventh International Conference, Opportunities from Micro- and Macro-algae. International Association of Applied Algology, Knysna, South Africa, p. 60.
- Ranganathan, S.V., Narasimhan, S.L., Muthukumar, K., 2008. An overview of enzymatic production of biodiesel. *Bioresour. Technol.* 99, 3975–3981.
- Ratledge, C., Wynn, J.P., 2002. The biochemistry and molecular biology of lipid accumulation in oleaginous microorganisms. In: Advances in Applied Microbiology. Academic Press, pp. 1–51.
- Rattanaoltee, P., Chulalakasanakul, W., James, A.E., Kaewkannetra, P., 2008. Comparison of autotrophic and heterotrophic cultivations of microalgae as a raw material for biodiesel production. *J. Biotechnol.* 136, S412.
- Ruiz, N.J., García, M.D.C.C., Mirón, A.S., Haftaloui, E.H.B., Camacho, F.G., Grima, E.M., 2009. Lipids accumulation in *Chlorella protothecoides* through mixotrophic and heterotrophic cultures for biodiesel production. *New Biotechnol.* 25, S266.
- Running, J., Huss, R., Olson, P., 1994. Heterotrophic production of ascorbic acid by microalgae. *J. Appl. Phycol.* 6, 99–104.
- Sansawa, H., Endo, H., 2004. Production of intracellular phytochemicals in *Chlorella* under heterotrophic conditions. *J. Biosci. Bioeng.* 98, 437–444.
- Scarsella, M., Parisi, M.P., D'Urso, A., De Filippis, P., Opoka, J., Bravi, M., 2009. Achievements and perspectives in hetero- and mixotrophic culturing of microalgae. In: Pierucci, S. (Ed.), Icheap-9: 9th International Conference on Chemical and Process Engineering, Pts 1–3. Aidic Servizi Srl, Milano, pp. 1065–1070.
- Schmidt, R.A., Wiebe, M.G., Eriksen, N.T., 2005. Heterotrophic high cell-density fed-batch cultures of the phycocyanin-producing red alga *Galdieria sulphuraria*. *Biotechnol. Bioeng.* 90, 77–84.
- Semple, K.T., 1998. Heterotrophic growth on phenolic mixtures by *Ochromonas danica*. *Res. Microbiol.* 149, 65–72.
- Shen, Y., Yuan, W., Pei, Z., Mao, E., 2010. Heterotrophic culture of *Chlorella protothecoides* in various nitrogen sources for lipid production. *Appl. Biochem. Biotechnol.* 160, 1674–1684.
- Shi, X.M., Zhang, X.W., Chen, F., 2000. Heterotrophic production of biomass and lutein by *Chlorella protothecoides* on various nitrogen sources. *Enzyme Microb. Technol.* 27, 312–318.
- Sim, T.S., Goh, A., Becker, E.W., 1988. Comparison of centrifugation, dissolved air flotation and drum filtration techniques for harvesting sewage-grown algae. *Biomass* 16, 51–62.
- Sloth, J.K., Wiebe, M.G., Eriksen, N.T., 2006. Accumulation of phycocyanin in heterotrophic and mixotrophic cultures of the acidophilic red alga *Galdieria sulphuraria*. *Enzyme Microb. Technol.* 38, 168–175.
- Somerville, C., 1995. Direct tests of the role of membrane lipid composition in low temperature-induced photoinhibition and chilling sensitivity in plants and cyanobacteria. *Proc. Natl. Acad. Sci. U. S. A.* 92, 6215–6218.

- Sun, N., Wang, Y., Li, Y.T., Huang, J.C., Chen, F., 2008. Sugar-based growth, astaxanthin accumulation and carotenogenic transcription of heterotrophic *Chlorella zofingiensis* (Chlorophyta). *Process Biochem.* 43, 1288–1292.
- Takeda, H., 1991. Sugar composition of the cell wall and the taxonomy of *Chlorella* (Chlorophyceae). *J. Phycol.* 27, 224–232.
- Takeda, H., 1993. Chemical-composition of cell-walls as a taxonomical marker. *J. Plant Res.* 106, 195–200.
- Tan, C., Johns, M., 1991. Fatty acid production by heterotrophic *Chlorella saccharophila*. *Hydrobiologia* 215, 13–19.
- Tanner, W., 2000. The *Chlorella* hexose/H⁺-symporters. *Int. Rev. Cytol.* 200, 101–141.
- Tredici, M.R., Carozzi, P., Chini Zittelli, G., Materassi, R., 1991. A vertical alveolar panel (VAP) for outdoor mass cultivation of microalgae and cyanobacteria. *Bioresour. Technol.* 38, 153–159.
- Vazhappilly, R., Chen, F., 1998. Eicosapentaenoic acid and docosahexaenoic acid production potential of microalgae and their heterotrophic growth. *J. Am. Oil Chem. Soc.* 75, 393–397.
- Vogel, H.C., Todaro, C.L., 1997. *Fermentation and biochemical engineering handbook: principles, process design, and equipment*, second ed. Noyes Publications, NJ.
- Wang, L., Li, Y., Chen, P., Min, M., Chen, Y., Zhu, J., et al., 2010. Anaerobic digested dairy manure as a nutrient supplement for cultivation of oil-rich green microalgae *Chlorella* sp. *Bioresour. Technol.* 101, 2623–2628.
- Wen, Z.Y., Chen, F., 2000. Heterotrophic production of eicosapentaenoic acid by the diatom *Nitzschia laevis*: effects of silicate and glucose. *J. Ind. Microbiol. Biotechnol.* 25, 218–224.
- Wen, Z.Y., Chen, F., 2001a. Application of statistically-based experimental designs for the optimization of eicosapentaenoic acid production by the diatom *Nitzschia laevis*. *Biotechnol. Bioeng.* 75, 159–169.
- Wen, Z.Y., Chen, F., 2001b. A perfusion-cell bleeding culture strategy for enhancing the productivity of eicosapentaenoic acid by *Nitzschia laevis*. *Appl. Microbiol. Biotechnol.* 57, 316–322.
- Wen, Z.Y., Chen, F., 2002a. Perfusion culture of the diatom *Nitzschia laevis* for ultra-high yield of eicosapentaenoic acid. *Process Biochem.* 38, 523–529.
- Wen, Z.Y., Chen, F., 2002b. Continuous cultivation of the diatom *Nitzschia laevis* for eicosapentaenoic acid production: physiological study and process optimization. *Biotechnol. Progr.* 18, 21–28.
- Wiley, P.E., Brenneman, K.J., Jacobson, A.E., 2009. Improved algal harvesting using suspended air flotation. *Water Environ. Res.* 81, 702–708.
- Xiong, W., Li, X., Xiang, J., Wu, Q., 2008. High-density fermentation of microalga *Chlorella protothecoides* in bioreactor for microbio-diesel production. *Appl. Microbiol. Biotechnol.* 78, 29–36.
- Xiong, W., Liu, L., Wu, C., Yang, C., Wu, Q., 2010a. 13C-Tracer and gas chromatography-mass spectrometry analyses reveal metabolic flux distribution in the oleaginous microalga *Chlorella protothecoides*. *Plant Physiol.* 154, 1001–1011.
- Xiong, W., Gao, C., Yan, D., Wu, C., Wu, Q., 2010b. Double CO₂ fixation in photosynthesis-fermentation model enhances algal lipid synthesis for biodiesel production. *Bioresour. Technol.* 101, 2287–2293.
- Xu, H., Miao, X., Wu, Q., 2006. High-quality biodiesel production from a microalga *Chlorella protothecoides* by heterotrophic growth in fermenters. *J. Biotechnol.* 126, 499–507.
- Yan, D., Lu, Y., Chen, Y.F., Wu, Q., 2011. Waste molasses alone displaces glucose-based medium for microalgal fermentation towards cost-saving biodiesel production. *Bioresour. Technol.* 102, 6487–6493.
- Yang, C., Hua, Q., Shimizu, K., 2000. Energetics and carbon metabolism during growth of microalgal cells under photoautotrophic, mixotrophic and cyclic light-autotrophic/dark-heterotrophic conditions. *Biochem. Eng. J.* 6, 87–102.
- Yang, C.Y., Hua, Q.H., Shimizu, K.S., 2002. Integration of the information from gene expression and metabolic fluxes for the analysis of the regulatory mechanisms in *Synechocystis*. *Appl. Microbiol. Biotechnol.* 58, 813–822.
- Yeesang, C., Cheirsilp, B., 2011. Effect of nitrogen, salt, and iron content in the growth medium and light intensity on lipid production by microalgae isolated from freshwater sources in Thailand. *Bioresour. Technol.* 102, 3034–3040.
- Yoo, C., Jun, S.Y., Lee, J.Y., Ahn, C.Y., Oh, H.M., 2010. Selection of microalgae for lipid production under high levels carbon dioxide. *Bioresour. Technol.* 101, S71–S74.
- Zaslavskaja, L.A., Lippmeier, J.C., Shih, C., Ehrhardt, D., Grossman, A.R., Apt, K.E., 2001. Trophic conversion of an obligate photoautotrophic organism through metabolic engineering. *Science* 292, 2073–2075.
- Zhang, C.W., Richmond, A., 2003. Sustainable, high-yielding outdoor mass cultures of *Chaetoceros muelleri* var. *subsalsum* and *Isochrysis galban* in vertical plate reactors. *Mar. Biotechnol. (NY)* 5, 302–310.

- Zhang, X.W., Chen, F., Johns, M.R., 1999a. Kinetic models for heterotrophic growth of *Chlamydomonas reinhardtii* in batch and fed-batch cultures. *Process Biochem.* 35, 385–389.
- Zhang, X.W., Shi, X.M., Chen, F., 1999b. A kinetic model for lutein production by the green microalga *Chlorella protothecoides* in heterotrophic culture. *J. Ind. Microbiol. Biotechnol.* 23, 503–507.
- Zhang, L., Li, Y., Wang, Z., Xia, Y., Chen, W., Tang, K., 2007. Recent developments and future prospects of *Vitreoscilla* hemoglobin application in metabolic engineering. *Biotechnol. Adv.* 25, 123–136.
- Zhang, J., Fang, X., Zhu, X.L., Li, Y., Xu, H.P., Zhao, B.F., et al., 2011. Microbial lipid production by the oleaginous yeast *Cryptococcus curvatus* O3 grown in fed-batch culture. *Biomass Bioenerg.* 35, 1906–1911.
- Zheng, Y., Chi, Z., Lucker, B., Chen, S., 2012. Two-stage heterotrophic and phototrophic culture strategy for algal biomass and lipid production. *Bioresour. Technol.* 103, 484–488.
- Zhou, W., Min, M., Li, Y., Hu, B., Ma, X., Cheng, Y., et al., 2012. A hetero-photoautotrophic two-stage cultivation process to improve wastewater nutrient removal and enhance algal lipid accumulation. *Bioresour. Technol.* 110, 448–455.

Production of Biofuels from Algal Biomass by Fast Pyrolysis

*Carlos José DalmasNeto¹, Eduardo Bittencourt Sydney²,
Ricardo Assmann¹, Dolivar Coraucci Neto¹,
Carlos Ricardo Soccol²*

¹Ourofino Agronegócio, Rodovia Anhanguera SP 330, Km 298 Distrito Industrial,
Cravinhos, SP, Brazil

²Department of Bioprocess Engineering and Biotechnology,
Federal University of Paraná, Curitiba-Pr, Brazil

7.1 INTRODUCTION

In recent years microalgae are gaining importance mainly due to their potential for fuel production with zero carbon emissions. In the actual context, algal fuel is economically unfeasible compared to petroleum-derived fuel (which costs around US\$0.55/L to U.S. consumers). To successfully make the transition from fossil fuels to biofuels, it is necessary to achieve the same or better quality (chemical and physical characteristics) for at least the same price. At this point, for most of the world, economics have greater influence than the eco-friendly characteristics (renewable sources and less polluting gas emissions) offered by biofuels.

The main reason for this economical limitation of biofuels manufactured from algae is the high costs of culture media and downstream processes (extraction, purification, and transformation) on an industrial scale. To make algal oil technologies economically feasible, these steps might be improved. In terms of culture media, it is in vogue to use wastewater as a partial or complete source of nutrients (carbon dioxide, nitrogen, phosphorous, potassium, magnesium, and some micronutrients) for algal growth as an alternative to reduce cultivation costs, whereas in terms of oil recuperation and transformation fast pyrolysis is a cheap

alternative. This chapter describes a patented technology for biofuel production through fast pyrolysis from lipid-rich microalgae.

7.1.1 The Energetic Issue

Over the last hundred years, world energy consumption has increased greatly. In just the last 38 years, energy demand increased 99%; between 1973 and 2011, consumption went from 6.111 to 12.150 million of tons of petroleum ([International Agency of Energy, 2011](#)). According to the same study, 81% of that energy came from fossil-dependent sources such as petroleum, coal, and natural gas.

The scientific community continues to discuss whether global warming is caused by the excessive increase of carbon dioxide in the atmosphere, but this idea is generally accepted. This situation has caused a rush to development of economically feasible and sustainable technologies, those independent of fossil sources. Among these new technologies, microalgal technologies have gained importance and are being widely explored due to their capacity to absorb carbon dioxide from atmosphere via photosynthesis and their high capacity to accumulate lipids, which can in turn be transformed into different forms of energy.

The independence of organic carbon sources for growth opens the possibility to develop technologies using wastewater that are unfeasible for heterotrophic microorganisms. At the same time, microalgae have many advantages compared to vascular plants ([Benemann and Oswald, 1996](#)): All physiological functions are carried out in a single cell, they don't differentiate into specialized cells and they multiply much faster, they carry low costs for harvest and transportation ([Miyamoto, 1997](#)), they consume less water ([Sheehan et al., 1998](#)), and they have the possibility to be cultured under conditions (such as infertile land) not suitable for the production of conventional crops ([Miyamoto, 1997](#)).

7.1.2 Culture Medium

One of the big challenges of microalgae culture is the search for alternative (and cheap) culture media. Some microalgal species can accumulate up to 70% of lipids but only when cultured in a specific balanced medium, as mentioned by [Chisti \(2007\)](#).

Medium costs are difficult to estimate because much depends on the species of microalga to be cultured. In the literature, medium cost is described as between US\$0.27 and \$0.588 per kg algal biomass ([Molina-Grima et al., 2003](#); [Tapie and Bernard, 1988](#)). Such high cost, the major drawback in biofuel production processes involving microalgae, makes these processes unfeasible. (Just the biomass production step represents almost 40% of the price of the final product.) The necessity to exploit inexpensive and abundantly produced nutritional sources to substitute artificial media is clear.

In this context, the patented technology developed by the company Ourofino Agronegócio, in partnership with the Laboratory of Biotechnological Processes (Federal University of Paraná, Brazil), is a very interesting and economical alternative for the production of biofuels from high-lipid-content microalgal biomass cultured in wastewater from ethanol distilleries. (The present technology was patented: PI0705520-0.)

7.1.3 Vinasse

Vinasse is a liquid residue from the sugarcane-based ethanol industry. After sugarcane juice fermentation by yeast, ethanol concentration in the fermented broth is no more than 10% v/v (due to its toxicity). During distillation, the ethanol is recuperated and everything left is called vinasse. It is produced in high volumes (12–15 liters for each liter of ethanol) and is rich in minerals (Rego and Hernández, 2006). Ethanol production in Brazil in 2012 is estimated at 27.9 billion liters (Empresa de Pesquisa Energética, 2012), which means production of vinasse is around 365 billion liters.

The major problem related to vinasse is its high chemical and biological oxygen demand: 29,000 and 17,000 mgO₂/L (Elia Neto and Nakahodo, 1995), respectively, 100 times more pollutant than average domestic wastewater. Vinasse pollutant strength is mainly due to high organic matter content and the presence of three important nutrients: nitrogen, phosphorous, and potassium (Bittencourt et al., 1978). Due to its composition, vinasse is largely used as fertilizer in sugarcane cultivation. Theoretically, the amount of vinasse allowed per area is regulated by the Brazilian government, but inspection is difficult to be carried out, leading to indiscriminate use.

According to Manhães et al (2003), soils irrigated with vinasse have high concentrations of nutrients at depths that can contaminate groundwater. Around 60% of the Brazilian ethanol is produced in São Paulo state (UNICA, 2010), which is located on the Guarani Aquifer, the second largest underground freshwater reserve in the world.

Given the clear environmental risk caused by poor allocation of vinasse, it is of great importance to apply technical and scientific knowledge for its better distribution, allowing further relocation in water bodies. When used in microalgae cultivation, biological and chemical oxygen demand (BOD and COD, respectively) can reach more than 90% reduction in BOD and more than 80% reduction in COD (DalmasNeto, 2012) in the first cycle of cultivation. Considering three cycles, reduction in BOD and COD can reach more than 95%.

7.1.4 Market Value

To successfully make the transition from fossil fuels to biofuels, it is necessary to achieve a similar or better quality product (chemical and physical characteristics) for at least the same price. This shift toward biofuels will take place if petroleum prices increase so much that the prices of petroleum-derived fuels become greater than those of biofuels. Unfortunately, the eco-friendly characteristics of biofuels (renewable sources and less polluting gas emissions) are not sufficient to lead the transition if no economic benefit is generated.

If we examine gasoline prices since 1997, the strong price increase becomes clear (Figure 7.1). It is accepted that prices of petroleum-based fuels will keep increasing, a situation that forces humankind to search for new sources of energy.

7.1.5 Pyrolysis

Pyrolysis is a physical-chemical process in which biomass is heated to between 400°C and 800°C, resulting in the production of a solid phase rich in carbon and a volatile phase

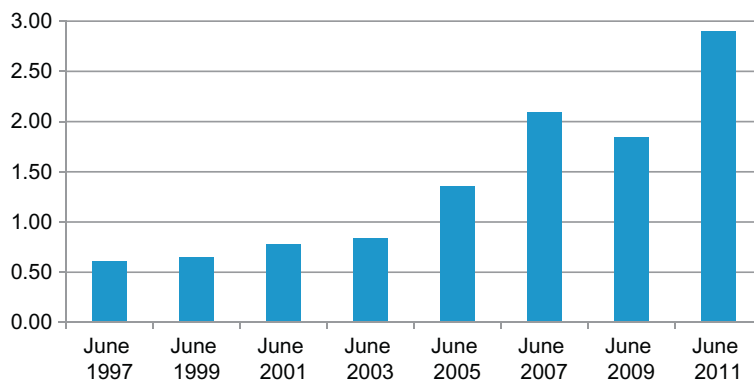

FIGURE 7.1 Price fluctuations of gasoline, New York, NY, USA, 1997–2011. (Adapted from U.S. Energy Information Administration.)

composed of gases and condensable organic vapors (Mesa-Pérez et al., 2005). These organic vapors condensate in two different phases: bio-oil and acid extract (Beenackers and Bridgwater, 1989).

Through pyrolysis, carbon-carbon bonds are broken, forming carbon-oxygen bonds. It is a redox process in which part of the biomass is reduced to carbon (coal) while the other part is oxidized and hydrolyzed yielding phenols, carbohydrate, aldehydes, ketones, and carboxylic acids, which combine to form more complex molecules such as esters and polymers (Rocha et al., 2004).

Due to the extreme conditions to which biomass is submitted, many simultaneous reactions occur, resulting in gaseous, liquid, and solid products:

1. *Gas phase*. Consists primarily of low-weight products that have moderate vapor pressure at room temperature and do not vaporize at pyrolysis temperature.
2. *Liquid phase*. Further subdivided into two other phases determined by density differences:
 - Bio-oil, which is a mixture of many compounds with high molecular weight that became vapors at pyrolysis temperature but condense at room temperature.
 - Acid extract (or aqueous extract), which consists of an aqueous phase with numerous soluble and/or suspended substances.
3. *Solid phase*. Also known as *biochar*, the solid phase is composed of an extremely porous matrix, very similar to charcoal (DalmásNeto, 2012).

Pyrolysis conditions can be manipulated to produce preferably one phase or the other. Residence time is one of the factors that most influence the final result. To produce incondensable gases, high residence time at high temperature is generally used; higher yields of solids are generally achieved by very high residence time at low temperatures (allowing polymerization reactions) (Sánchez, 2003). For preferential production of the liquid phase, fast pyrolysis is often chosen. Table 7.1 summarizes the conditions and main effects of residence time and temperature in gaseous, liquid, and solid product generation. Other pyrolysis technologies and their characteristics are presented in Table 7.2.

TABLE 7.1 Different Proportion of Gas, Liquid and Solid Products obtained Depending on the Pyrolysis Conditions Applied.

Process	Temperature (°C)	Residence Time (s)	Heating Rate	Gas (% p/p)	Liquid (% p/p)	Solid (% p/p)
Fast pyrolysis	500	1	High	15	75	10
Slow pyrolysis	400	3600	Very low	35	30	35
Gasification pyrolysis	800	500	Low	85	5	10

(Adapted from *Bridgwater, 2003*, and *Rocha, 1997*.)

TABLE 7.2 Conditions and Products Generated by Less Usual Pyrolysis Techniques.

Pyrolysis Type	Residence Time	Heating Rate	Temperature (°C)	Main Products
Carbonization	Hours to days	Very low	400	Coal
Conventional	5–30 min	Low	600	Bio-oil, gas
Fast	0.5–5 s	Intermediary	650	Bio-oil
Flash	1 s	High	650	Bio-oil, gas
Ultrafast	0.5 s	Very high	1000	Fuel gas
Vacuum	2–30s	Intermediary	400	Bio-oil
Hydro	10s	High	500	Bio-oil
Methane	10s	High	700	Chemicals

(Adapted from *Bridgwater and Bridge, 1991*.)

Due to its tendency to preferentially form bio-oil, coupled with high-speed reaction and greater productivity, fast pyrolysis is the best model for the production of biofuels from algae.

7.2 FAST PYROLYSIS

A fast pyrolysis system consists basically of a fluidized bed reactor, a cyclone, a condenser, and a combustion chamber, generally constructed as shown in [Figure 7.2](#).

The fluidized bed reactor is where pyrolysis actually occurs. The remaining constituents are responsible for phase separation. The reactor operates at around 450°C. Heating is done by an immersed electrical resistor covered with inert material (silicates, in general). The function of this inert material is to increase the heat transfer between the air and the fluidizing material to be pyrolyzed through abrasive action, increasing the contact surface of the solids ([DalmasNeto, 2012](#)).

Once temperature is achieved, air feeding begins. Then heating stops and the material to be pyrolyzed is fed to the reactor. At this point, an initial temperature fall is observed, caused by air and material entrance in much lower temperatures. Reactor temperature can be

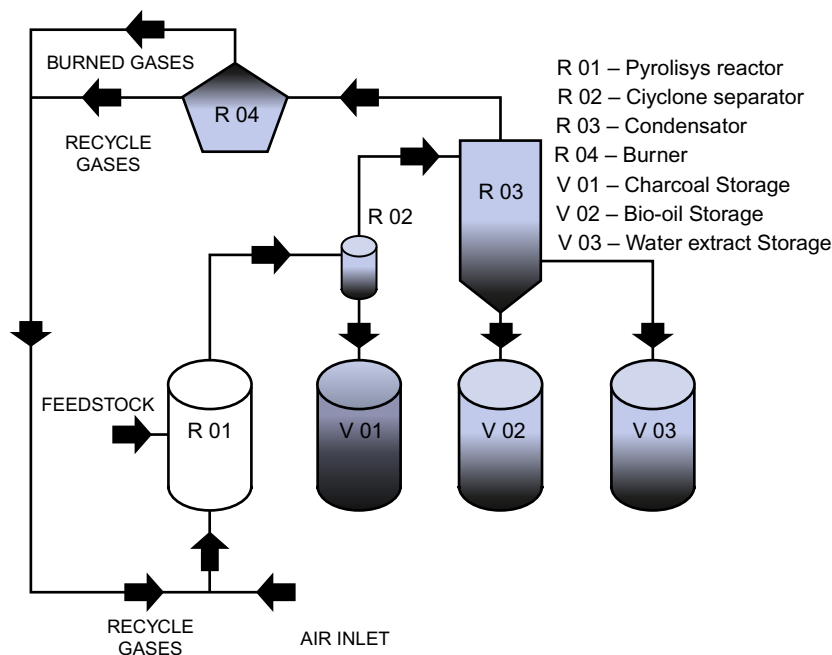

FIGURE 7.2 Diagram of a pyrolysis unit.

immediately reestablished by combustion of the pyrolysis' incondensable gases or by controlled combustion of part of the material fed to the reactor.

The combustion of incondensable gases, such as CO , H_2 , and CH_4 (Cortez et al., 2008), is the best option, generating enough heat for autothermal operation of the reactor, but this entails the acquisition of additional equipment. On the other side, controlled combustion of part of the material fed to the reactor is easier to be handled but means loss of product (about 10% of the material needs to be burned to maintain reactor temperature, according to Mesa-Pérez, 2005).

Residence time is controlled based on material feeding rate, air flow, and reactor volume. Material characteristics such as density and size are taken into account to avoid dragging out the time. After pyrolysis, the gaseous mixture is sent to a cyclone by pneumatic conveying (by the fluidizing air itself). In the cyclone, gaseous and liquid components are separated by centrifugal force. The gaseous products enter the condenser. The condensable fractions are then separated by gravity: In the bottom an output is used for bio-oil gathering, while the acid extract is collected at the middle of the condenser. Gases and very light particles enter a centrifuge located at the top of the condenser, where some light particles condensate, increasing the yield of the liquid phases.

The condenser effluent gases are formed by four fractions. The first one is composed of inert atmospheric gases that adhered to biomass particles when the reactor was fed; the second one consists of inert gases fed with air in fluidization (nitrogen, CO_2). The third fraction involves semioxidized pyrolysis gases such as CO and CH_4 ; the fourth is composed of those gases that are combusted to provide energy to the system. Usually this gas phase is fed back to the system, especially due to the potential of the third fraction to provide energy to the system.

The combustion chamber is responsible for burning all combustible gases generated in the process. It acts as a restorative power cell besides being a security tool (preventing release of flammable gases into the atmosphere).

The following steps and reactions summarize pyrolysis processes (adapted from [Gómez et al., 2008](#)):

1. Drying: Humid material \rightarrow solid material + $\text{H}_2\text{O}(\text{g})$
2. Pyrolysis: Dry material \rightarrow coal + volatile products
3. Combustion reactions:
 - a. $\text{C}(\text{s}) + \text{O}_2 \rightarrow \text{CO}_2(\text{g}) + \text{energy}$
 - b. $2\text{H}_2(\text{g}) + \text{O}_2(\text{g}) \rightarrow 2\text{H}_2\text{O}(\text{g}) + \text{energy}$
4. Heat transfer
5. Mass transfer

The smooth operation of a fast pyrolysis system depends very little on the raw material conditions but strongly depends on its composition (organic matter amount). To be pyrolyzed, the material might be dried and milled into particles smaller than 20 mm ([Bridgwater et al., 1999](#)). Low moisture content is desired to avoid wasted energy (or higher energy demand) and possible influence on calorific power of the final product. (High-moisture-content materials are frequently pyrolyzed but with the drawback mentioned previously.) Particle size might be big enough to avoid excessive biomass drag by fluidizing air (the flow of which is usually high), causing loss of nonpyrolyzed material, but also small enough to allow easy heat transfer and avoid secondary polymerization and carbonization reactions (this will cause coal yield increase, according to [Sánchez, 2003](#)).

[Ganesh, 1990](#) found that both acid and alkaline catalysts tend to increase gas production. The same study noted that desmineralization caused an increase in the superficial area of coal.

Due to the high heating rate to which material is subjected in fast pyrolysis, the residence time might be very short, usually around 1 second ([Gómez, 2002](#)). In this condition, advanced stages of undesirable reactions (such as polymerization and/or decomposition) are avoided.

[Figure 7.3](#) presents the most probable mechanisms of formation of pyrolysis products.

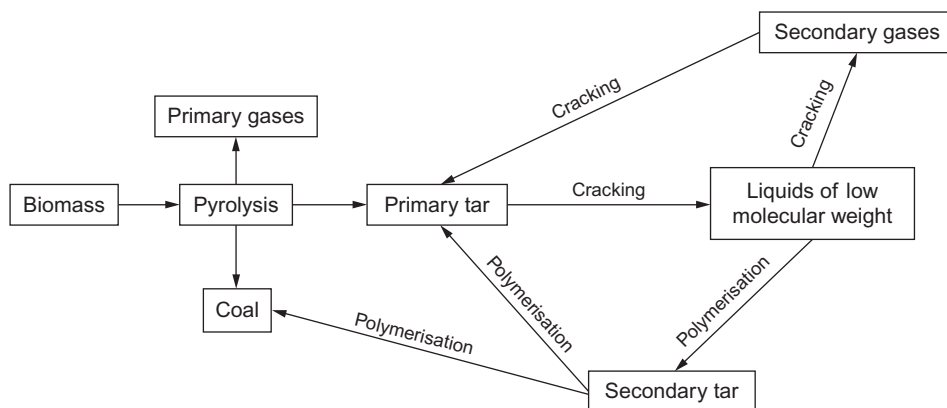

FIGURE 7.3 Most probable mechanisms of formation of pyrolysis products. (Adapted from [Sánchez, 2003](#).)

7.3 YIELDS AND CHARACTERISTICS OF PYROLYSIS OF ALGAL BIOMASS

The microalga used in this experiment is a nongenetically modified organism (non-GMO) adapted to a culture medium containing vinasse from an ethanol distillery. The culture was carried in open ponds (Figure 7.4) at an Ourofino Agronegócio biofuels facility.

After being cultured, the biomass was flocculated, centrifuged, and dried. Dried algal biomass containing about 12% moisture was used in a fast pyrolysis system (see Figure 7.5).

The conditions of fast pyrolysis were:

Reactor temperature: 485 ± 15

Reactor pressure: 1.2 atm

Mass flow: 17 kg/h

Air flow: 1.7 kg/h

The results achieved from fast pyrolysis with algal biomass are shown in Table 7.3. Elemental analyses of each fraction were carried out and are presented in Table 7.4.

To analyze the potential of fuel use, the lower heating value (LHV) was determined according to the method ABNT/NBR11956. Results are shown in Table 7.5.

Bio-oil was the fraction with higher LHV, presenting values very near some vegetable oils. For example, soy oil has an LHV of 9,500.00 kcal/kg, and babassu oil (a typical Brazilian coconut) has around 9,140 kcal/kg.

The obtained algal coal was also superior to some solid fuels, of which the LHV is around 4,000 kcal/kg.



FIGURE 7.4 Open ponds for microalgae cultivation at Ourofino Agronegócio, Brazil.



FIGURE 7.5 Fast pyrolysis equipment.

TABLE 7.3 Yields of Algal Biomass Fast Pyrolysis Experiments Carried Out at Oufino Agronegocio Biofuels Facilities (DalmasNeto, 2012).

Product	Yield (%) (m/m)
Bio-oil	17.4
Acid extract	32.3
Coal	10.8
Gases	39.5

TABLE 7.4 Elemental Analysis of Each Product Generated by Fast Pyrolysis of Algal Biomass. Acid Extract Values are in Terms of Dry Base; The others are in Terms of Wet Base (DalmasNeto, 2012).

Material	Carbon (%)	Hydrogen (%)	Nitrogen (%)	Sulfur (%)	Oxygen (%)	Ash (%)	Moisture (%)
Biomass	45.32	6.85	3.93	0.25	34.35	4.12	5.20
Coal	52.16	3.14	6.86	0.17	15.44	19.08	3.11
Bio-oil	65.49	10.17	1.58	0.07	19.70	0.15	2.73
Extract	64.30	10.44	2.08	0.08	20.31	0.28	0.00

TABLE 7.5 Lower Heating Value (LHV) of Each Product from Fast Pyrolysis (DalmasNeto, 2012).

Fraction	LHV (kcal/kg)
Biomass	5,060
Coal	5,167
Bio-oil	8,071
Acid extract	7,323

It is important to consider the high mass density of the bio-oil: 1,230.00 kg/m³. Volumetric energetic density was then calculated as 9,927.33 kcal/L, which means the amount of energy that 1 liter of bio-oil is capable of providing. This value is 15% higher than diesel oil (8,620 kcal/L) (DalmasNeto, 2012).

The average cost of one tonne of microalgal biomass is about US\$310; one liter of bio-oil produced by this technology in pilot scale is near US\$1.20 per liter. This production cost will probably lower as technology scales up. Bio-oil can provide 85% of the energy that diesel oil can provide (7,922 kcal/US\$ from diesel versus 6,746 kcal/US\$ from bio-oil), which costs around US\$1.28/L. This comparison shows the competitiveness of such bio-oil technology.

7.4 CONCLUSIONS

The technology of fast pyrolysis of algal biomass for the production of bio-oil presented very interesting results, which, combined with low cost and simplicity of operation, make this technology a potential alternative carbon-free-emission fuel process.

References

- Beenackers, A.A.C.M., Bridgwater, A.V., 1989. Gasification and Pyrolysis of biomass in Europe. In: Ferrero, G.L., Maniatis, K., Beukens, A.G., Bridgwater, A.V. (Eds.), *Pyrolysis and Gasification*. Elsevier Appl. Science, London, UK, pp. 129–157.
- Benemann, J.R., Oswald, W.J., 1996. Systems and economic analysis of microalgae ponds for conversion of CO₂ to biomass. Master's thesis. University of California at Berkeley.
- Bittencourt, V.C., Castro, L.J.B., Figueiredo, A.A.M., Paixão, A.C.S., Polli, D.M., 1978. Composição da Vinhaça. *Brasil Açucareiro* 92 (4), 25–35.
- Bridgwater, A.V., Bridge, S.A., 1991. A Review of Biomass Pyrolysis and Pyrolysis Technologies, in *Biomass Pyrolysis Liquids Upgrading and Utilization*, vol. 1. Elsevier Applied Science. pp. 11–93.
- Bridgwater, V.A., Meider, D., Radlein, D., 1999. An overview of fast pyrolysis of biomass. *Org. Geochem.* 30, 1479–1493.
- Bridgwater, V.A., 2003. Renewable fuels and chemicals by thermal processing of biomass. *Chem. Eng. J.* 91 (2), 87–102.
- Chisti, Y., 2007. Biodiesel from Microalgae. *Biotechnol. Adv.* 25, 294–306.
- Cortez, L.A.B., Lora, E.E.S., Gomez, E.O., 2008. Biomassa para energia. Editora da UNICAMP, Campinas, São Paulo, pp. 435–473. Cap. 13.

- Dalmas, N.J.C., 2012. Desenvolvimento de bioprocesso para a produção de biocombustíveis obtidos à partir da pirólise rápida de microalgas. Master's thesis. Universidade Positivo, Curitiba, Brazil.
- Elia Neto, A., Nakahodo, T., 1995. Caracterização físico-química da vinhaça projeto n. 9500278. Relatório Técnico da Seção de Tecnologia de Tratamento de Águas do Centro de Tecnologia Copersucar, Piracicaba, Brazil.
- Empresa De Pesquisa Energética, 2012. Análise de Conjuntura dos Biocombustíveis. Cadernos de Energia EPE. Ministério de Minas e Energia. Governo Federal, Brazil.
- Ganesh, A., 1990. Studies on Characterization of Biomass for Gasification. PhD thesis. Indian Institute of Technology, New Delhi, India.
- Gómez, O.E., 2002. Estudo da pirólise rápida do Capim Elefante em leito fluidizado borbulhante mediante caracterização dos finos de carvão. PhD thesis. Universidade Estadual de Campinas, Campinas, Brazil.
- Gómes, E.O., Mesa Pérez, J.M., Brossard, L.E., 2008. Pirólise rápida de materiais lignocelulósicos para a obtenção de bio-óleo. In: Cortez, L.A.B., Lora, E.S., Olivarez Gómez, O.E. (Eds.), Biomassa para energia. Editora da Unicamp, Campinas. Cap.11, pp. 353–a 418.
- International Agency of Energy, 2011. Available at www.eia.gov/petroleum/gasdiesel/ (accessed 10.09.12.).
- Manhães, M.S., de Souza, D., Berto, P.N.A., 2003. Acúmulo de potássio em solos de áreas canavieiras fertirrigadas no norte fluminense. *Agronomia* 37 (1), 64–68.
- Mesa-Pérez, J.M., Cortez, L.A.B., Brossard-Perez, L.E., Olivares-Gómez, E., Rocha, J.D., 2005. Unidimensional heat transfer analysis of *elephant grass* and sugar cane bagasse slow pyrolysis in a fixed bed reactor. *Fuel Processing Technology* 86 (5), 565–575.
- Miyamoto, K., 1997. Renewable biological systems for alternative sustainable energy production. *FAO Agricultural Services Bulletin*. Food and Agriculture Organization of the United Nation, pp. 1–5.
- Molina-Grima, E., Belarbi, E.H., Acien-Fernandez, F.G., Robles-Medina, A., Yusuf, C., 2003. Recovery of microalgal biomass and metabolites: Process options and economics. *Biotechnol. Adv.* 20 (7–8), 491–515.
- Rego, E.E., Hernández, F.M., 2006. Eletricidade por digestão anaeróbia da vinhaça de cana-de-açúcar: contornos técnicos, econômicos e ambientais de uma opção. In: Encontro De Energia No Meio Rural, vol. 6. Campinas, Brazil.
- Rocha, D.J., 1997. Bio-óleo por hidropirólise de biomassa como precursor de materiais carbonosos. PhD thesis. Universidade Estadual de Campinas, Campinas, Brazil.
- Rocha, J.D., Mesa-Pérez, J.M., Cortez, L.A.B., 2004. Aspectos Teóricos e Práticos do Processo de Pirólise de Biomassa. Energia na Indústria de Açúcar e Alcool. Conference. UNIFEI, Itajubá, Brazil.
- Sánchez, G.C., 2003. Tecnologia da Gaseificação. Universidade de Campinas, Campinas, Brazil.
- Sheehan, J., Dunahay, T., Benemann, J., Roessler, P., 1998. A look back at the U. S. Department of Energy's Aquatic Species Program; Biodiesel from Algae. Close-Out Report. National Renewable Energy Laboratory, Colorado, USA.
- Tapie, P., Bernard, A., 1988. Microalgae production: Technical and economic evaluation. *Biotechnol. Bioeng.* 32, 873–885.
- União Da Indústria De Cana-De-Açúcar – ÚNICA, Dados e cotação: estatísticas. www.unica.com.br/dadosCotacao/estatistica/ (accessed 14.07.12.).
- U.S. Energy Information Administration, www.eia.gov (accessed 10.09.12.).

Intentionally left as blank

Algae Oils as Fuels

S. Venkata Mohan, M. Prathima Devi,
G. Venkata Subhash, Rashmi Chandra

Bioengineering and Environmental Center, CSIR-Indian Institute of Chemical
Technology, Hyderabad, India

8.1 INTRODUCTION

Continuous use of petroleum-derived fuels is recognized as unsustainable due to their depleting supplies and their contribution to the accumulation of greenhouse gases (GHG) in the environment. Biologically produced fuels have been identified as potential alternative energy sources (Posten and Schaubb, 2009; Smith et al., 2009; Rojan et al., 2011; Venkata Mohan et al., 2011) that can mitigate GHG emissions (Hossain et al., 2008). Biofuels are being promoted as one of the most promising routes to lower CO₂ emissions and to reduce the world's dependency on fossil fuels (Groom et al., 2008; Smith et al., 2009). Biofuel production from renewable sources is widely considered as one of the most sustainable alternatives to petroleum sourced fuels and a viable means for environmental and economic sustainability (Dragone et al., 2010).

Crop-based terrestrial sources of biomass face problems associated with a finite area of land available for its cultivation. In this context, algae draw much attention as an alternative source of biomass that is capable of generating fuel. Compared to crop-based counterparts, algae have rapid growth rates. It is estimated that algae could yield 61,000 liters per hectare (L/ha), compared with 200 L/ha to 450 L/ha from crops such as soya and canola (Duan and Savage, 2010). Algae are a known rapidly growing species of which the carbon-fixing rates are much higher than those of terrestrial plants. Microalgae commonly double their biomass within 24 hours (h), and this duration during the exponential growth phase can be as short as 3.5 h (Harrison et al., 2012; Chisti 2007). The prominence of algae-based biofuels evolved due to their domestic origin, carbon neutrality, renewability, abundant availability, higher combustion efficiency, and higher biodegradability (Zhang et al., 2003). Different algal species showed varied lipid content (*Prymnesium parvum*, 22–38%;

Chlamydomonas reinhardtii, 21%; *Chlorella vulgaris*, 22%; *Spirogyra* sp., 11–21%; *Scenedesmus obliquus*, 12–12%; *Scenedesmus dimorphous*, 16.40%; *Porphyridium cruentum*, 4–14%; *Synchococcus* sp., 11%; *Dunaliella bioculata*, 8%; *Tetraselmis maculate*, 3%; based on dry biomass) (Becker, 1994; 2004).

Photosynthesis has been recognized as an efficient carbon sequestration mechanism. Microalgae can sequester atmospheric CO₂ (Chisti, 2007) and utilize carbon as well as inorganic nutrients present in wastewater for their growth and survivability (Venkata Mohan et al., 2011). During photosynthesis, microalgae capture atmospheric CO₂, resulting in the synthesis of carbohydrates. Creating stress on microalgae at this stage causes the photosynthetic mechanism to switch from enhancing the biomass to accumulating lipids. The intracellular lipid granules stored under stress conditions act as precursors for fatty acid biosynthesis. The triglyceride composition of algae upon transesterification with an alcohol can produce algae-derived biodiesel (alkyl esters). Depending on the species, growing conditions, and growth stages, microalgae have been shown to produce various types of lipids including triacylglycerides, phospholipids, glycolipids, and betaine lipids (Greenwell et al., 2010). Microalgae-derived lipids and biomass can be converted into alcohols, methyl esters, and alkanes for use in spark-ignited engines, compression ignition engines, and aircraft gas turbine engines (Harrison et al., 2012). Under specific cultivation conditions, algal oil content can exceed 50% by weight of dry biomass (Chisti, 2007). According to an estimate, the productivity of algae-derived biofuels is predicted to be on the order of 5,000 gallons/acre/year, which is approximately two orders of magnitude greater than the yield from terrestrial oil seed crops such as soybeans (Demirbas, 2007; Weyer et al., 2009).

Biofixation/sequestration of CO₂ using photosynthetic microalgae is one potential option for harnessing renewable energy. Cultivation of algae for biodiesel production is considered more beneficial to the environment than the cultivation of oil crops (Chisti, 2007) because the productivity of algae-derived oils is much higher than the best oil-producing crops (Abou-Shanab et al., 2010). Compared to fossil-driven fuels, microalgae-based biofuels are renewable, biodegradable, and eco-friendly (Ma and Hanna, 1999; Knothe, 2006; Vicente et al., 2010). The cultivation of algae doesn't require arable land, since they can be grown in artificial ponds, on land that's unsuitable for agriculture, on surfaces of lakes or coastal waterways, or in vats on wasteland (Duan and Savage, 2010). Algal-based fuel addresses the major constraints posed by the first- and second-generation biofuels due to its fast growing nature and capability to produce several times higher biomass compared to terrestrial crops and trees, requires low and marginal land and other resources, produces higher lipid and carbohydrate, and so on (Singh et al., 2011). Production of biofuels from microalgae is gaining acceptance because of its economic feasibility and environmental sustainability compared to agro-based fuels. Microalgae-derived biofuels have the potential for scalability (Harrison et al., 2012). Algae-derived biodiesel is currently being promoted as a third-generation biofuel feedstock since algae doesn't compete with food crops and can be cultivated on nonarable land (Dragone et al., 2010). In writing this chapter, a comprehensive attempt was made to summarize the basic and applied aspects of algal-based fuel by synthesizing the contemporary literature in conjunction with recent developments.

8.2 CELLULAR BIOCHEMISTRY TOWARD LIPID SYNTHESIS

Algae are diverse group of organisms that inhabit a vast range of ecosystems, from the extremely cold (Antarctic) to extremely hot (desert) regions of the Earth (Guschina and Harwood, 2006; Round, 1984). Algae account for more than half the primary productivity at the base of the food chain (Hoek et al., 1995). Lipid metabolism (the biosynthetic pathways of fatty acids and triacylglycerol, or TAG synthesis), particularly in algae, has been less studied than in higher plants (Fan et al., 2011). Based on the sequence homology and some shared biochemical characteristics of a number of genes and/or enzymes isolated from algae and higher plants that are involved in lipid metabolism, it is generally believed that the basic pathways of fatty acid and TAG biosynthesis in algae are directly analogous to higher plants (Fan et al., 2011). The *de novo* synthesis of fatty acids in algae occurs primarily in the thylakoid and stromal region of the chloroplast (Liu and Benning, 2012). Algae fix CO₂ during the day via photophosphorylation (thylakoid) and produce carbohydrate during the Calvin cycle (stroma), which converts into various products, including TAGs, depending on the species of algae or specific conditions pertaining to cytoplasm and plastid (Liu and Benning, 2012). Microalgae are proficient at surviving and functioning under phototrophic or heterotrophic conditions or both. A schematic illustration of algal-based lipid biosynthesis by a photoautotrophic mechanism is given in Figure 8.1. The biosynthetic pathway of lipid in algae occurs through four steps: carbohydrates accumulating inside the cell, formation of acetyl-CoA followed by malony-CoA, synthesis of palmitic acid, and finally, synthesis of higher fatty acid by chain elongation.

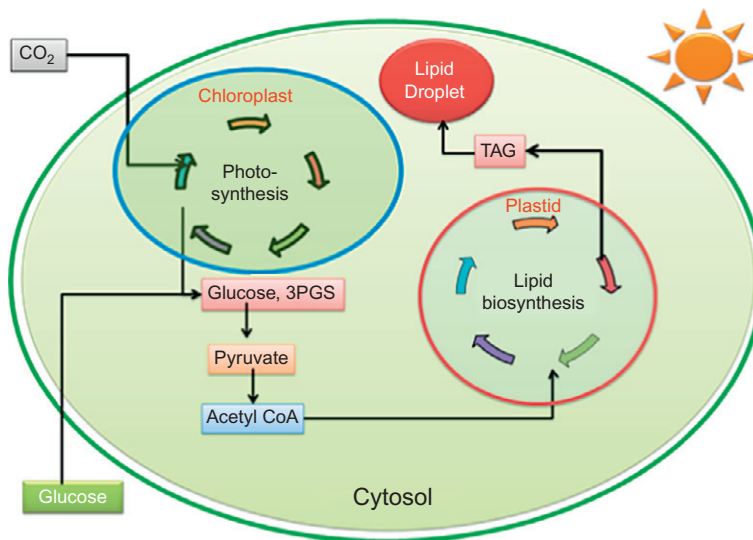

FIGURE 8.1 Localization of various components of the lipid biosynthetic pathway in an algal cell

8.2.1 Glucose Accumulation Inside the Cell

Accumulation of energy-rich compounds is the primary step for microalgal lipid biosynthesis. However, this carbon accumulation varies with both autotrophic and heterotrophic organisms. Autotrophs synthesize their own carbon (photosynthates) through photosynthesis, whereas heterotrophic organisms assimilate it from outside the cell. In photoautotrophs, the chloroplast is the site of photosynthesis where, light reaction takes place at the thylakoid followed by CO₂ fixation to carbohydrates in the stroma of the chloroplast. These photosynthates provide an endogenous source of acetyl-CoA for further lipid biosynthetic pathways. Heterotrophic nutrition is again light-dependent and light-independent, where the carbon uptake will be through an inducible active hexose symport system from outside the cell (Perez-Garcia et al., 2011; Tanner, 1969; Komor, 1973; Komor and Tanner, 1974), and in this process the cell invests energy in the form of ATP (Tanner, 2000). However, carbon assimilation is more favorable in the case of light-independent processes (dark heterotrophic) over light-dependent ones (photoheterotroph). In dark heterotrophic algae, light inhibits the expression of the hexose/H⁺ symport system (Perez-Garcia et al., 2011; Kamiya and Kowallik, 1987), which decreases glucose transport inside the cell. Algae can also accumulate carbon in the presence of light through photoheterotrophic nutrition. Once carbon enters the cytosol, it follows cytosolic conversion of glucose to pyruvate through glycolysis and leads to the generation of acetyl-CoA, similar to photoautotrophs, followed by the pathway of lipid biosynthesis. In mixotrophic nutrition, both the biochemical process of autotrophs and heterotrophs occur simultaneously, and the preference of substrate uptake depends on the substrate availability in addition to other environmental conditions.

8.2.2 Formation of Acetyl-CoA/Malonyl-CoA

Photosynthates provide an endogenous source of acetyl-CoA by activated acetyl-CoA synthetase in the stroma, from free acetate, or from the cytosolic conversion of glucose to pyruvate during glycolysis (Somerville et al., 2000; Schwender and Ohlrogge, 2002). This acetyl-CoA is preferentially transported from the cytosol to the plastid, where it is converted to the fatty acid and subsequently to TAG, which again is transported to the cytosol and forms the lipid bodies (Figure 8.1). The acetyl-CoA pool will be maintained through the Calvin cycle, glycolysis and pyruvate kinase (PK) mediated synthesis of pyruvate from PEP, which occur in the chloroplast in addition to the cytosol. The first reaction of the fatty acid biosynthetic pathway towards the formation of malonyl-CoA from acetyl-CoA and CO₂ is catalyzed by the enzyme Acetyl-CoA carboxylase (ACCase). (Ohlrogge and Browse, 1995). Figure 8.2 illustrates the conversion of acetyl-CoA to malonyl-CoA by utilizing ATP. During this process, seven molecules of acetyl-CoA and seven molecules of CO₂ form seven molecules of malonyl-CoA. This malonyl Co-A undergoes synthesis of long carbon-chain fatty acids through repeating multistep sequences, as represented in Figures 8.2 and 8.3. A saturated acyl group produced by this set of reactions becomes the substrate for subsequent condensation with an activated malonyl group (Ohlrogge and Browse, 1995).

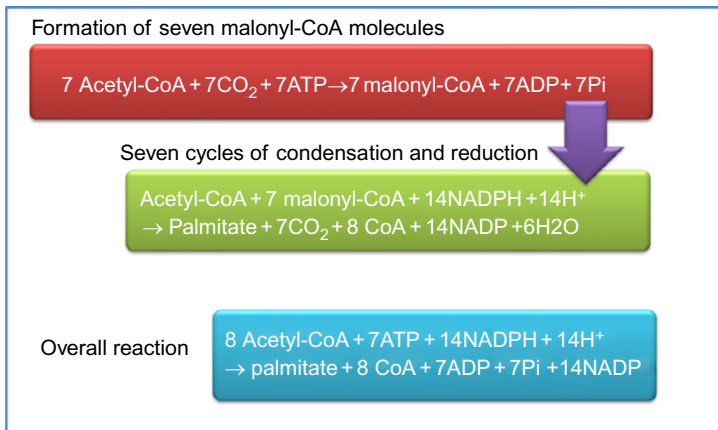

FIGURE 8.2 Cascade of reactions involved in microalgae lipid biosynthesis

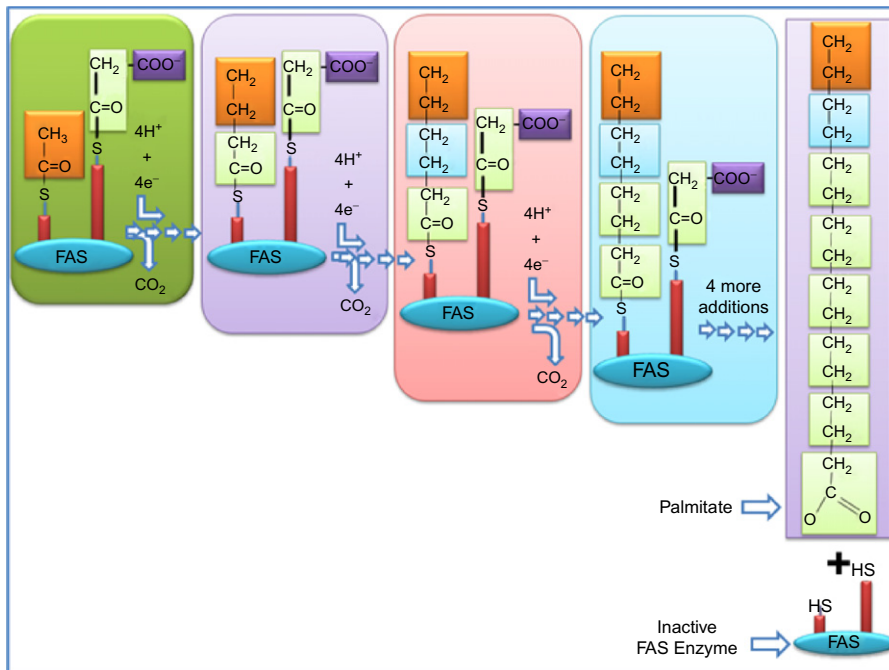

FIGURE 8.3 Sequential chain elongation steps and formation of precursor molecules (palmitic acid) from CO₂

8.2.3 Synthesis of Palmitic Acid

After the formation of seven malonyl-CoA molecules, a four-step repeating cycle (extension by two carbons/cycle), i.e., condensation, reduction, dehydration, and reduction, takes place for seven cycles and forms the principal product of the fatty acid synthase systems, i.e., palmitic acid, which is the precursor of other long-chain fatty acids (Fan et al., 2011;

Alban et al., 1994). With each course of the cycle, the fatty acyl chain is extended by two carbons. Figures 8.2 and 8.3 illustrate the palmitic acid formation and chain elongation. When the chain length reaches 16 carbons, the product (palmitate) leaves the cycle (Liu and Benning, 2012). All the reactions in the synthetic process are catalyzed by a multienzyme complex, i.e., fatty acid synthase (FAS).

8.2.4 Synthesis of Higher Fatty Acids

Palmitate is the precursor of stearate and longer-chain saturated fatty acids as well as palmitoleate and oleate (Pollard and Stumpf, 1980). The palmitic acid gets modified further and lengthened to form stearate (18:0) or even to longer saturated fatty acids (oleate, lineate, etc.) by further additions of acetyl groups through the action of fatty acid elongation systems present in the smooth endoplasmic reticulum (ER) and in mitochondria (Thelen and Ohlrogge, 2002). The mechanism of elongation in the ER is identical to palmitate synthesis, which involves donation of two carbons by malonyl-CoA, followed by reduction, dehydration, and reduction to the saturated 18-carbon product, stearoyl-CoA. Figure 8.4 shows the formation of higher fatty acids from the palmitic acid through different steps of chain elongation. In algae, oleate (from stearoyl-CoA) gets converted to the α and γ linolenates (Thelen and Ohlrogge, 2002). α -linolenate further gets converted to other polyunsaturated fatty acids, while γ -linolenate converts to the eicosatrienoate and further arachidonate. Mammals cannot

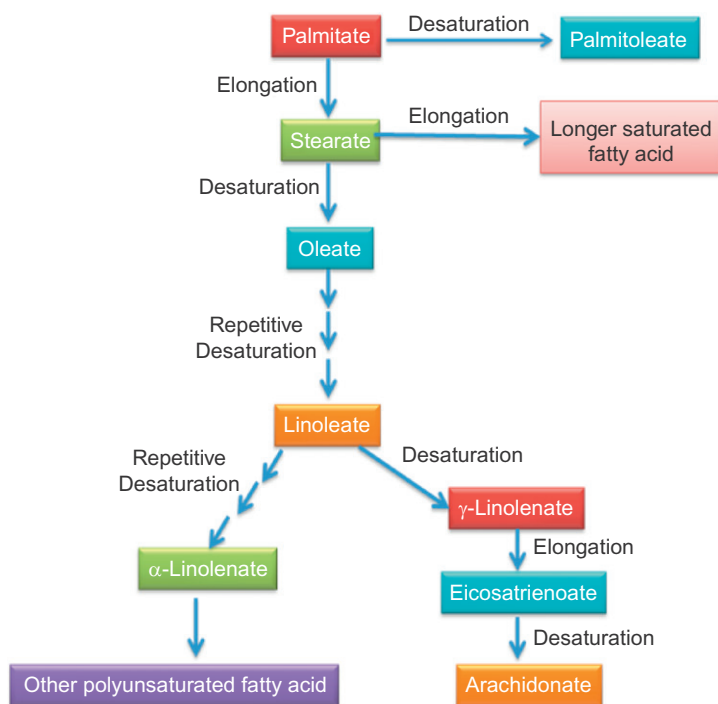

FIGURE 8.4 Schematic representation of long-chain fatty acid formation from palmitic acid

convert oleate to linoleate or linolenate because of the lack of enzymes to introduce double bonds at carbon atoms beyond C9 (Nelson and Cox, 2009). All fatty acids containing a double bond at positions beyond C9 have to be supplied in the diet and are called essential fatty acids.

8.3 NUTRITIONAL MODE OF MICROALGAE

Living organisms can be divided into two large groups, autotrophs and heterotrophs, according to the type of carbon source they utilize. Autotrophic organisms have the capability to convert physical (light) and chemical (CO_2 and H_2O) sources of energy into carbohydrates, which further form the base for the construction of all other carbon-containing biomolecules (Yoo et al., 2011). Mostly, the external energy is stored as a reduced form (carbohydrates) that is compatible with the needs of the cell. Autotrophic organisms are relatively self-sufficient and self-sustainable because they obtain their energy from sunlight (Nelson et al., 1994; Eberhard et al., 2008; Nelson and Yocum, 2006; Krause and Weis, 1991). On the contrary, heterotrophic organisms utilize organic carbon produced by autotrophs as energy sources for their metabolic functions because they cannot utilize atmospheric CO_2 as a carbon source. Oxidative assimilation of carbon begins with a phosphorylation of glucose/hexose, yielding phosphorylated glucose, which is readily available for storage, cell synthesis, and respiration (Figure 8.5). Nutritional modes significantly influence the carbon assimilation and lipid productivity of the microalgae (Xu et al., 2006). Three types of nutritional modes—autotrophic,

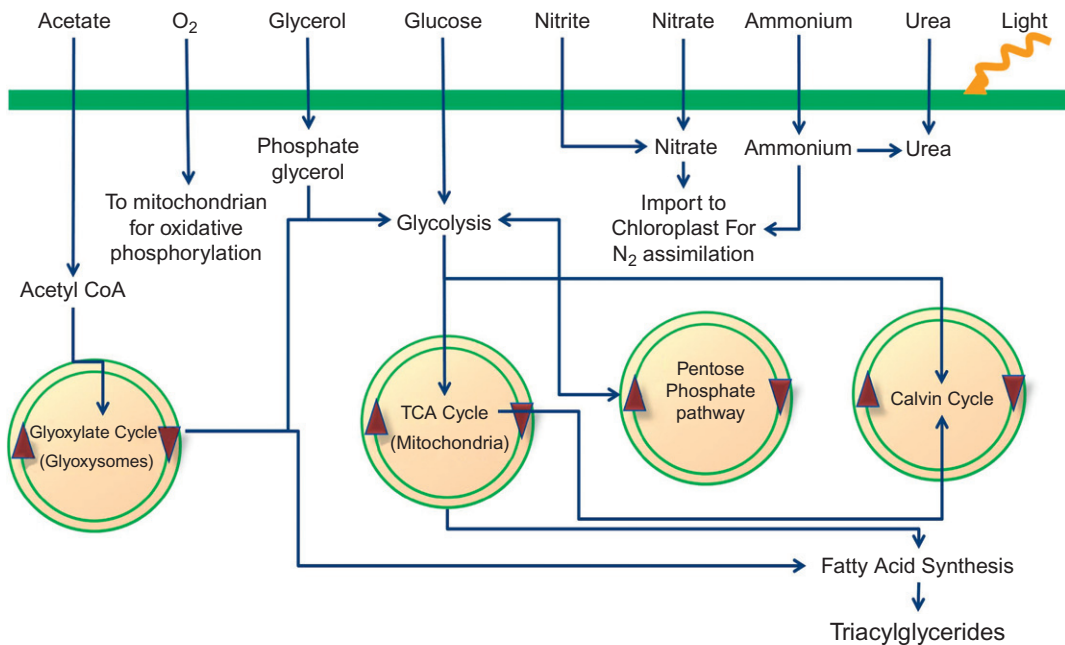

FIGURE 8.5 Schematic representation of the photoheterotrophic metabolic process occurring in microalgae during fatty acid biosynthesis

heterotrophic, and mixotrophic—are reported to produce algal fuel in the presence of light. In addition, the dark heterotrophic nutrition mechanism is also found to be capable of lipid biosynthesis by microalgae under specific conditions.

8.3.1 Photoautotrophic Mechanism

The most common procedure for cultivation of microalgae is autotrophic mode. Microalgae in photoautotrophic nutrition mode use sunlight as the energy source and inorganic carbon (CO_2) as the carbon source to form biochemical energy through photosynthesis (Huang et al., 2010). This is one of the most prevailing environmental conditions for the usual growth of microalgae (Chen et al., 2011). In photoautotrophic nutritional mode, photosynthetically fixed CO_2 in the form of glucose serves as a sole energy source for all metabolic activities (Figure 8.6). The simpler form of photosynthate, such as simpler carbohydrates, serves as sole energy source for carrying out the metabolic activities of the algal cells (Chang et al., 2011). These carbohydrates, under nutrient-limiting and stress conditions, will favor the lipid biosynthesis, which also helps to cope up with the stress (Gouveia and Oliveira, 2009). Lipid productivity greatly depends on the photosynthetic activity in terms of atmospheric CO_2 fixation and microalgae species. Large variations in lipid productivity, ranging from 5% to 68%, were reported under varying operating conditions and species diversity (Murata and Siegenthaler, 2004; Ohloggeav and Browseb, 1995; Chen et al., 2011; Mata et al., 2010). A major advantage of the autotrophic nutritional mode is the algal oil production at the expense of atmospheric CO_2 . Large scale microalgae cultivation systems (such as open/raceway ponds) are usually operated under photoautotrophic conditions (Mata et al., 2010). Autotrophic nutritional mode also has fewer contamination problems compared with other

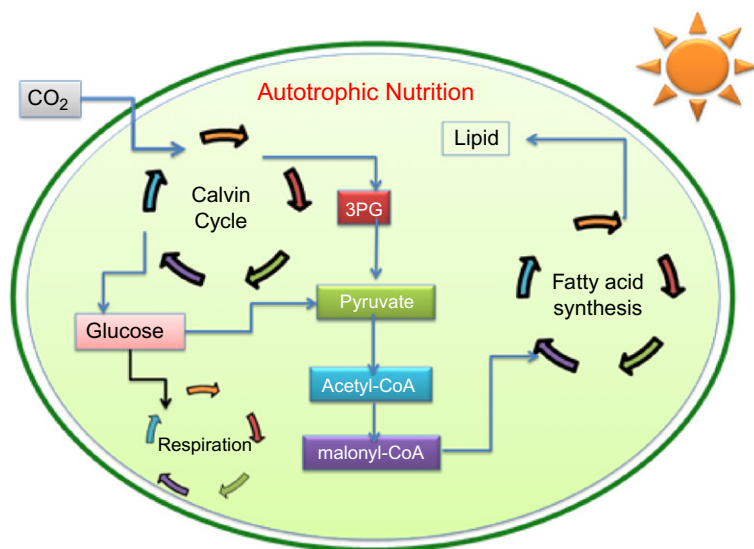

FIGURE 8.6 Autotrophic mode of nutrition in microalgal cells towards CO_2 fixation and lipid biosynthesis

nutritional modes. Under autotrophic nutrition, the photosynthates also get consumed during respiration associated with the biomass growth, and hence the lipid productivity represents the combined effects of oil content and biomass production (Chiu et al., 2008).

8.3.2 Heterotrophic Mechanism

Heterotrophism is a mode of nutrition whereby microalgae utilize external substrates as sole carbon sources for their growth and lipid accumulation. The circumstances in which microalgae use organic molecules as primary energy and carbon sources is called *heterotrophic nutritional mode* (Kaplan et al., 1986). In heterotrophic nutrition, the simpler carbohydrates enter the cell and are subsequently converted to lipids and participate in other metabolic pathways such as respiration (Figure 8.7). Heterotrophic nutrition takes place both in the presence and absence of light. In *photoheterotrophic nutrition*, light acts as an energy source, but the source of carbon remains organic only. Heterotrophic growth in the dark condition is supported by a carbon source replacing the light energy. This unique ability is shared by several species of microalgae (Perez-Garcia et al., 2011). Glucose is the simpler carbon source for heterotrophic microalgae. Higher rates of growth and respiration are obtained with glucose than with any other substrate, such as sugars, alcohols, sugar phosphates, organic acids, and monohydric alcohols. This oxidative assimilation takes place in algae apparently through two pathways; i.e., the Embden Meyerhoff pathway (EMP) and the pentose phosphate pathway (PPP) (Neilson and Lewin, 1974).

Carbon metabolism in heterotrophic growth of microalgae under dark condition occurs via a PPP pathway, whereas the EMP pathway is the main glycolytic process in light conditions (Lloyd, 1974; Neilson and Lewin, 1974; Yang et al., 2000; Hong and Lee, 2007). Both pathways are carried out in the cytosol and are functional in microalgae. However, the PPP pathway might have a higher flux rate than the other, depending on the carbon source and the presence of light (Perez-Garcia et al., 2011). Light is not required for the transport of glucose inside the

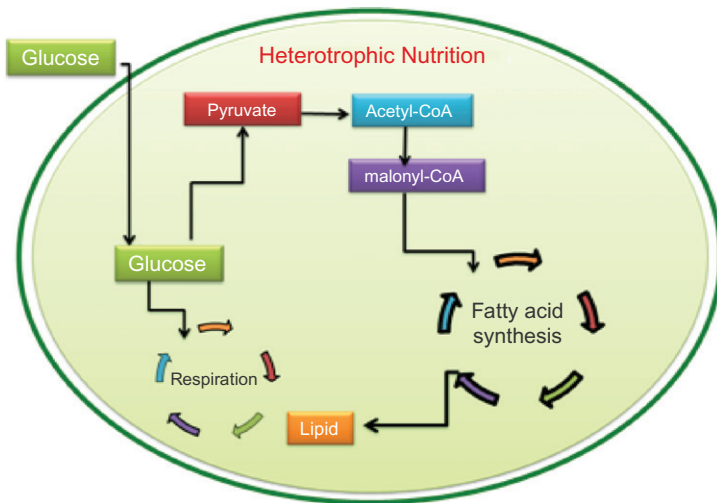

FIGURE 8.7 Heterotrophic mode of nutrition in algal cells towards glucose assimilation and lipid biosynthesis

cell during dark heterotrophic operation. Glucose transport system in the algal cell become inefficient in the presence of light, because of higher availability of photosynthates inside the cell due to photosynthesis and down-regulation of hexose transport protein. The carbon is obtained from outside the cell and converted to the acetyl-CoA via pyruvate, which further converts to malonyl-CoA and subsequently enters the lipid biosynthetic pathway (Figure 8.7). In heterotrophic nutrition mode, because of abundant glucose availability, respiration and other metabolic processes do not compete with the lipid biosynthesis, unlike autotrophic mode. Moreover, microalgae can utilize organic carbon under dark conditions because of the ability of light-independent glucose uptake. Hence, the lipid productivity is high in heterotrophic nutrition mode (Abeliovich and Weisman, 1978).

Heterotrophically it is possible to obtain high densities of microalgal biomass that provide an economically feasible method for large-scale mass production (Chen, 1996; Chen and Johns, 1996; Lee, 2004; Behrens, 2005; Perez-Garcia et al., 2011). Photoheterotrophic nutritional mode avoids the limitations of light dependency, which is the major obstruction to gaining high cell density in large-scale photobioreactors (Huang et al., 2010). *Chlorella protothecoides* showed higher lipid content (40%) during heterotrophic growth (Xu et al., 2006). Higher lipid productivity (3,700 mg/L/d) was also reported by using an improved fed-batch culture strategy in heterotrophic nutritional mode, where the lipid productivity was 20 times higher than that obtained under photoautotrophic cultivation (Xiong et al., in 2008). The major advantage of heterotrophic nutritional mode is the facilitation of wastewater treatment along with lipid productivity, which gives an edge to its application in the present state of increasing pollution loads. Moreover, cost effectiveness, relative simplicity of operation, and easy maintenance are the main attractions of the heterotrophic growth approach (Perez-Garcia et al., 2011). However, heterotrophic systems suffer from contamination problems (Abeliovich and Weisman, 1978; Olguín et al., 2012).

8.3.3 Mixotrophic Mechanism

Microalgae can also function in mixotrophic nutrition mode by combining both the autotrophic and the heterotrophic mechanisms. It facilitates fixing atmospheric CO₂ as well as consuming the organic molecules and micronutrients from the growing environment (Figure 8.8). Microalgae can assimilate available organic compounds as well as atmospheric CO₂ as a carbon source in mixotrophic mode. The CO₂ released by microalgae via respiration will again be trapped and reused in mixotrophic nutritional mode. It differs from photoheterotrophic nutrition mode in terms of CO₂ utilization. The mixotrophs have the ability to utilize organic carbon; therefore, light energy is not a limiting factor for biomass growth (Chang et al., 2011). The acetyl-CoA pool will be maintained from both carbon sources—that is, by the CO₂ fixation (Calvin cycle) and intake from outside the cell, which can further make malonyl-CoA. The photosynthetic metabolism utilizes light and CO₂ for growth and organic photosynthate production, whereas respiration uses the organic photosynthates produced during photosynthesis. If an external carbon source is available in the system, there is a less loss of photosynthate during respiration, and the algae utilize the available excess photosynthates for biomass development. Mixotrophic cultures show reduced photoinhibition and improved growth rates over autotrophic and heterotrophic cultures (Chojnacka and Noworyta, 2004).

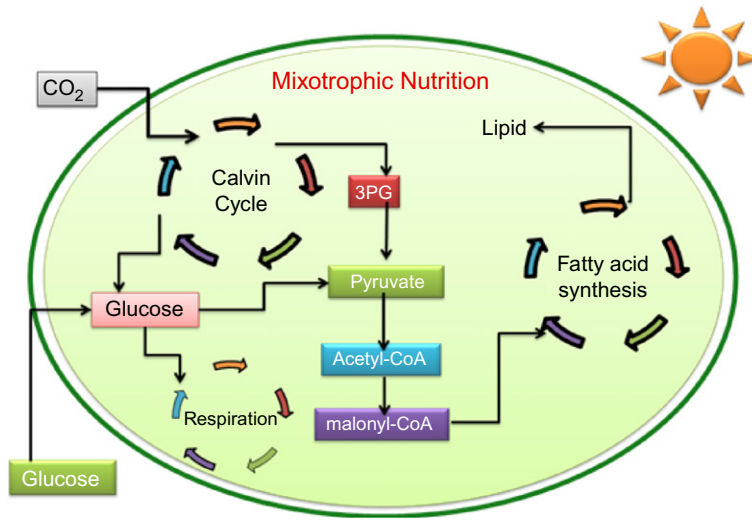

FIGURE 8.8 Mixotrophic mode of nutrition in algal cells towards CO₂ fixation and glucose assimilation for lipid biosynthesis

Algae have the flexibility to switch their nutritional mode based on substrate availability and light condition. If simpler carbohydrates are present in the system, algae shift towards heterotrophic nutrition from autotrophic mode to save energy. *Scenedesmus obliquus* readily adapted to heterotrophic growth in dark conditions utilizing glucose (Abeliovich and Weisman, 1978). Heterotrophic cells differed significantly from photoautotrophic cells with respect to several physiological properties such as the rate of photoassimilation of CO₂ and the rate of incorporation of carbon and chlorophyll *a* concentration. Algal cells in an oxidation pond shared features common to both photoautotrophic and heterotrophic cells (Abeliovich and Weisman, 1978), associating with the mixotrophic mode of operation. Bacteria seem to play a minor role in biological oxygen demand reduction in high-rate oxidation ponds, and their role is probably confined to degradation of biopolymers, thus producing substrates for algal consumption.

The advantages of mixotrophic nutrition are its independence in terms of both photosynthesis and growth substrates (Kong et al., 2012). The mixotrophic growth regime is a variant of the heterotrophic growth regime, where CO₂ and organic carbon are simultaneously assimilated and both respiratory and photosynthetic metabolism operates concurrently (Kaplan et al., 1986; Lee, 2004; Perez-Garcia et al., 2011). Mixotrophism is often observed in ecological water bodies, where the homeostatic structure and function of living systems are supported by chemical, physical, and organic activity in biota that balance the ecological status. Water ecosystems generally consist of nutrients and organic carbon as integral parts (Venkata Mohan et al., 2009), where microalgae, along with other living components, function together symbiotically. Some microalgal species are not truly mixotrophs but have the ability to switch between phototrophic and heterotrophic metabolisms, depending on environmental conditions (Kaplan et al., 1986). Microalgae-accumulating lipids are generally grown in natural

water bodies; therefore, ecological water bodies embedded with diverse microalgae species can be considered as potential reservoirs for harnessing biodiesel. In this regard, an attempt was made to explore the ability and potential of mixed microalgae cultures derived from different water bodies in extracting lipids, which can be further transesterified to biodiesel. The study also focused on the economic mode of lipid production from the treatment of domestic sewage. The growth of algae was shown to be highest under mixotrophic conditions, with higher biomass productivity under photoautotrophic conditions (Bhatnagar et al., 2010; 2011). Mixotrophic cultivation was shown to be a good strategy to obtain a large biomass and high growth rates (Ogawa and Aiba, 1981; Lee and Lee, 2002), with the additional benefit of producing photosynthetic metabolites (Chen, 1996; Perez-Garcia et al., 2011). Solazyme, a renewable oil company in the United States, has developed an integrated algal cultivation process by dark heterotrophic mechanisms, giving carbon sources externally. The company is using various forms of waste material as feedstock for the cultivation of algae in fermenters and harnessing as much as 75% of oil on the basis of dry cell weight. The company is anticipating in selling algal oil to commercial refineries by the end of 2013.

8.4 SUBSTRATES FOR MICROALGAE GROWTH AND LIPID PRODUCTION

8.4.1 CO₂

CO₂ fixation by microalgae through a photoautotrophic mechanism for harnessing liquid fuel is considered a reliable and sustainable approach for the neutralization of CO₂ (Graham and Wilcox, 2000; Takagi et al., 2000; Ge et al., 2011; Wang et al., 2008; Yoo et al., 2010). Microalgae are considered as more photosynthetically efficient than terrestrial plants at fixing CO₂ (Chiu et al., 2008; Indra et al., 2010). Microalgae also have the functional ability to fix CO₂ from the atmosphere and industrial emissions (Brennan and Owende, 2010; Venkata Subhash et al., 2013). In the process of fixation, microalgae use CO₂ as an inorganic carbon source, while water acts as an electron donor for the storage of reserve food material such as carbohydrates, which are further transformed to lipids under certain stress conditions. Many microalgae species are able to utilize carbonates such as Na₂CO₃ and NaHCO₃ for cell growth (Wang et al., 2008). Most algae and cyanobacteria have different CO₂-concentrating mechanisms (CCM) and act as enhancers for higher growth (Ramanan et al., 2010). CCM is activated only at low carbon levels and further depends on the strain, pH, light availability, and so on. The expression of the enzyme carbonic anhydrase (CA) has been associated with the induction of the CCM. *Chlorella* sp., *Spirulina* sp., and *Dunaliella* sp. have been studied for CO₂ sequestration. CO₂ tolerance of *Dunaliella* sp. has been examined and used in the industrial production of beta-carotene (Graham and Wilcox, 2000). In *Chlorella* sp., growth was reported at 20% CO₂ concentration (Hanagata et al., 1992). *Scenedesmus obliquus* and *Spirulina* showed good CO₂ fixation rates when cultivated at 30 °C (Wang, et al., 2008). Mixotrophic cultivation of microalgae (mixed) by supplementing CO₂ externally at different concentrations in domestic sewage showed enhanced biomass growth and lipid productivities (Prathima Devi and Venkata Mohan, 2012). The study documented functional advantages of the mixotrophic mode of nutrition. Photoautotrophic microalgae cultivation facilitates harnessing of

renewable fuel in conjunction with CO₂ fixation in a unified and sustainable approach. However, algal cells cannot efficiently trap atmospheric CO₂ to support the rapid growth needed for commercial operations (Duan and Savage, 2010).

8.4.2 Wastewater

Microalgae have the capability to grow in nutrient-rich environments and accumulate nutrients and metals from wastewater (de-Bashan and Bashan, 2010; Hoffmann, 1998; Mallick, 2002). This makes heterotrophic cultivation of microalgae one of the viable options for lipid biosynthesis. Algae-based biodiesel production is considered both economically and environmentally sustainable when wastewater is used as substrate (Brune et al., 2009; Chisti, 2007; Huntley and Redalje, 2007; Stephens et al., 2010; Venkata Mohan et al., 2011; Prathima Devi et al., 2012). Use of algae as a biocatalyst was generally documented for wastewater treatment in conventional oxidation ponds, raceway ponds, and suspended algal ponds to remove high concentrations of nutrients, especially for polishing purposes. Algae-based treatment systems are efficient in removing nutrients from wastewater compared to chemical-based treatments (Hoffmann, 1998; Martinez et al., 2000; Ruiz-Marin et al., 2010; Zhang et al., 2008) and are environmentally amenable and provide efficient recycling of nutrients (Munoz and Guieysse, 2006; Wilkie and Mulbry, 2002). Usually *Chlorella* sp. and *Scenedesmus* sp. are predominantly observed in the oxidation ponds (Bhatnagar et al., 2010; Ruiz-Marin et al., 2010; Shi et al., 2007; Wang et al., 2010; Masseret et al., 2000). Especially for industrial wastewater treatment, the algae-based remediation process was used as a tertiary unit operation for the removal of heavy metal and organic toxins rather than nutrients (Ahluwalia and Goyal, 2007; de-Bashan and Bashan, 2010). Microalgae cultivation with wastewater treatment is a potential option for environmental sustainability and carbon neutrality.

Five characteristically different ecological water bodies (mixotrophic) were evaluated to assess the biodiesel production capability of their native microalgae (mixed) (Venkata Mohan et al., 2011). The lipid yield varied between 4–26%, mostly depending on the nature and function of the water body. Algal fuel showed reasonably good fuel properties, with higher saturated fatty acids. Algal diversity profiling depicted the presence of high-lipid-accumulating species. The dominance of mixotrophic microalgae (*Chlorella*, *Scenedesmus*, and *Euglena*) and facultative heterotrophs (centric and pinnate diatoms), along with a few photoautotrophs (*Spirogyra*), were observed. *Euglena* can act as both autotrophs (day) and heterotrophs (nights). *Scenedesmus* sp. is generally involved in the natural purification process, and its dominance in all the cultures is a positive sign for wastewater treatment. *Chlorella*, *Euglena*, and diatoms are also known to have the capability to use organic carbon present in the wastewater along with atmospheric CO₂. Ecological water bodies can be considered potential reservoirs for bioenergy production, conjugating with the natural purification process.

Carpet mill effluent documented as a potential source for algal biomass production associated with biodiesel production (Chinnasamy et al., 2010). Two agroindustrial co-products, dry-grind ethanol thin stillage and soy-whey, were studied as nutrient feedstock for mixotrophic/heterotrophic microalgal cultivation for fuel production (Debjani et al., 2012). *Scenedesmus* sp. cultivated in artificial wastewater showed about 12% lipid accumulation along with 33% protein and 27% carbohydrates (Voltolina et al., 1999). *Botryococcus braunii*

grown in secondarily treated sewage as tertiary treatment documented good treatment efficiency along with 17% lipid accumulation (Orpez et al., 2009). *Chlorella* sp. grown in attached mode with dairy manure wastewater showed high biomass growth as well as fatty acid yield (Johnson and Wen, 2010). Cultivation of *Scenedesmus* sp. in fermented swine wastewater yielded lipids and other value-added products in association with nutrient removal (Kim et al., 2007). Nitrogen and phosphorus assimilation associated with lipid production was studied with freshwater microalgae using industrial wastewater (Li et al., 2012).

The functional role of macro/micronutrients—carbon, nitrogen, phosphorus, and potassium—on heterotrophic cultivation of microalgae (mixed) in domestic wastewater was studied on biomass growth and lipid productivity employing sequential growth and starvation phases (Prathima Devi et al., 2012). Nutrient limitation during the starvation phase showed a positive influence on lipid productivity. Nutrient-deprived conditions caused a decrease in the cellular thylakoid membrane content by activating the acyl hydrolase and stimulating the hydrolysis of phospholipids. All these changes increase the intracellular content of fatty acid acyl-CoA. Nitrogen limitation can also activate diacylglycerol acyl transferase, which converts acyl-CoA to TAG (Takagi et al., 2000). Lipid composition of the microalgae oil varied in accordance with the nutrients supplemented (Prathima Devi et al., 2012). Efficient removal of nutrients (nitrates and phosphates) and carbon (as COD) was also noticed. Microalgae diversity visualized the presence of potential lipid-accumulating species, such as *Cosmarium quadrifarium*, *Pediasastrum boryanum*, *Cyclotella bodanica*, *Scenedesmus* sp., and *Cosmarium depressum*. Acid-rich effluents from a fermentative hydrogen-producing reactor were evaluated as potential substrate for lipid accumulation by heterotrophic microalgae cultivation with simultaneous treatment (Venkata Mohan and Prathima Devi, 2012). Microalgae can grow heterotrophically by utilizing volatile fatty acids (VFA), resulting in lipid accumulation. Acetate can be easily assimilated by the algal cell as part of the acetyl-coenzyme A (acetyl-CoA) metabolism in a single-step reaction catalyzed by acetyl-CoA synthetase (Boyle and Morgan, 2009; Chandra et al., 2012). Similar to acetate consumption, butyrate is broken down and gets converted to acetate and then enters the TCA cycle to stimulate the synthesis of glucose. TAG accumulation in response to environmental stress likely occurs as a means of providing an energy deposit that can be readily catabolized in response to a more favorable environment, to allow rapid growth (Prathima Devi et al., 2012). Integration of microalgae cultivation with biohydrogen production showed lipid productivity for biodiesel production along with additional treatment (Chandra and Venkata Mohan, 2011).

8.5 MICROALGAE CULTIVATION

Cultivation of microalgae influences both biomass growth and lipid productivity. Culturing of algae requires the input of light as an energy source for photosynthesis with a sufficient supply of macronutrients (nitrogen and phosphate) and micronutrients (sulphur, potassium, magnesium) in dissolved form (Mata et al., 2010). The main options for algae cultivation on a commercial scale are open-ponds or closed systems called *photobioreactors* (Chisti, 2007; Robert et al., 2012). There are also hybrid configurations that include a mix of the two growth options. Innovations in algae production allow it to become more productive while consuming resources that would otherwise be considered waste (Campbell, 2008).

8.5.1 Open Pond Cultivation Systems

Cultivation of algae in open ponds mimics the natural method of growing algae (Pearson, 1996; Chisti, 2007). Open ponds can be categorized into natural waters (lakes, lagoons, ponds, etc.) and artificial ponds or containers. The most commonly used systems include shallow ponds (large in size), raceway ponds, tanks, and circular ponds. Raceway ponds generally consist of an oval-shaped shallow pond lined with PVC, cement, or clay, having an area of 1–200 ha (Andersen, 2005). Ponds are divided by a series of baffles, and water is moved through the ponds in order to promote mixing of nutrients and uniform algae growth. These ponds are usually constructed in shallow dimensions as the algae need to be exposed to sunlight, and sunlight can only penetrate the water up to a certain limited depth (Chisti, 2007). The ponds are operated in a continuous mode, with CO₂ and nutrients being constantly fed to the pond while the algae-containing water is removed at the other end. Large open-pond cultivation for mass algal production of single-cell protein, health food, and beta-carotene is one of the oldest industrial systems since the 1950s (Chisti, 2007; Perez-Garcia et al., 2011).

Cultivation of microalgae in open ponds presents relatively low construction and operating costs, which invariably result in low production costs (Stephenson et al., 2010; Chen, 1996; Tredici, 2004). Large ponds can be constructed on degraded and nonagricultural lands that avoid the use of high-value lands and crop-producing areas (Chen, 1996; Tredici, 2004). On the contrary, open pond cultivation inherits some drawbacks such as poor light diffusion, losses due to evaporation, CO₂ diffusion from the atmosphere, and the requirement of large areas of land (Harun et al., 2010; Perez-Garcia et al., 2011). Furthermore, contamination by predators and other fast-growing heterotrophs restricts the commercial production of algae in open-air pond/culture systems. Not-so-efficient mixing in open cultivation permits poor mass transfer rates, resulting in low biomass productivity (Pulz, 2001; Harun et al., 2010). Uncontrolled environments in and around the pond pose a multitude of problems that can directly or indirectly stunt algae growth (Mata et al., 2010). Uneven light intensity and distribution within the pond (Kazamia et al., 2012) and uncontrolled pond temperature also have a significant influence on the algal biomass productivity.

8.5.2 Closed Cultivation Systems (Photobioreactors)

As we mentioned, closed cultivation systems that house the growth of algae under controlled conditions are referred as *photobioreactors* (PBRs). Photobioreactors provide a more controlled environment than open ponds because these systems are closed and everything that the algae need to grow (carbon dioxide, water, and light) can be supplied with in the system (Weissman, 1987; Pulz, 2001). There are different types of PBRs reported for algae cultivation. PBRs facilitate better control of culture environment, such as carbon dioxide supply, water supply, optimal temperature, efficient exposure to light, culture density, pH levels, gas supply rate, mixing regime, and so on (Mata et al., 2010). High mass transfer is one of the important criteria for PBR design, especially for CO₂ sequestration (Ugwu et al., 2008). Agitations in PBR are done either mechanically or nonmechanically. Non-mechanical agitation can be observed airlift, bubble column, tubular reactor, and flat panel operations. PBRs specifically designed for CO₂ sequestration have the flexibility of using CO₂-rich gas as a means

of mixing as well as providing nutrients for the growth of algae (Hu et al., 1996). PBRs can be operated in both batch and continuous modes. In comparison with open culture systems, a closed photobioreactor is easy to control with regard to environmental parameters and can achieve high growth rates (Pulz, 2001; Sierra et al., 2008). Higher biomass of microalgae productivity is obtained in closed cultivation systems where contamination can also be prevented (Ramanathan et al., 2011). Fully closed photobioreactors provide opportunities for monoseptic culture of a greater variety of algae than open cultivation systems (Borowitzka, 1999). Various types of closed cultivation systems are studied to a great extent.

8.5.2.1 Vertical Tubular Photobioreactors

Vertical tubular photobioreactors are made up of transparent vertical tubing to allow light penetration (Richmond, 2004). The bottom of the reactor is attached with a sparger to convert the sparged gas into tiny bubbles. This enables mixing and mass transfer of CO₂ and removes the O₂ produced during photosynthesis. Based on the mode of flow, these vertical tubular photobioreactors can be classified as bubble column and airlift reactors (Ramanathan et al., 2011). Ramanathan and his co-workers (2011) cultivated marine microalgae, that is, *Nanochloropsis oculata* and *Chaetoceros calcitrans*, in tubular photobioreactors. The study resulted in higher biomass productivity due to the large illuminating surface area of the photobioreactor.

8.5.2.2 Airlift Photobioreactors

Airlift photobioreactors comprise two interconnecting zones called the *riser*, where the gas mixture is sparged, and the *downcomer*, which does not receive the gas. Generally, an airlift photobioreactor exists in two forms: internal loop and external loop (Chisti, 1989; Miron et al., 2000). In an internal loop reactor, regions are separated either by a draft tube or a split cylinder; in an external loop reactor, the riser and downcomer are separated physically by two different tubes. Mixing in the system is done by bubbling the gas through a sparger in the riser tube, with no physical agitation. A riser is similar to a bubble column, where sparged gas moves upward randomly and haphazardly, which decreases the density of the riser, making the liquid move upward. Gas held up in the downcomer significantly influences the fluid dynamics of the airlift reactor. Increasing the gas hold-up, the difference between a riser and a downcomer, is an important criterion in designing airlift reactors (Chisti, 1989; Kaewpintong et al., 2007). Airlift reactors have the characteristic advantage of creating circular mixing patterns in which liquid culture passes continuously through dark and light phases, giving a flashing-light effect to algal cells (Barbosa et al., 2003). The biomass growth pattern of *Nanochloropsis oculata* and *Scenedesmus quadricauda* was studied inside two vertical airlift photobioreactors suitable for indoor operation, with both salt and freshwater and different lighting systems. Results depicted that the biomass productivity of the cultures was found to depend on the light regimes and the duration of operation.

8.5.2.3 Bubble Column Photobioreactors

Bubble column PBRs are more widely used than other reactors. In them, mixing and CO₂ mass transfer are carried out through spargers with an external light supply (Nigar et al., 2005; Doran, 1995). Photosynthetic efficiency depends on gas flow rate, which further depends on the light and dark cycle as the liquid is circulated regularly from central dark zone

to external photic zone at higher gas flow rate (Janssen et al., 2003). Photosynthetic efficiency can be increased by increasing the gas flow rate (≥ 0.05 m/s), leading to shorter light and dark cycles. Degen et al., 2001 used a bubble column photobioreactor to improve light utilization efficiency of the strain *Chlorella vulgaris* through a flashing-light effect in batch mode operation and achieved 1.7 times higher productivity of biomass (Degen et al., 2001).

8.5.2.4 Flat Panel Photobioreactors

It has been reported that with flat panel/plate photobioreactors, high photosynthetic efficiencies can be achieved (Hu et al., 1996; Richmond, 2000). Accumulation of dissolved oxygen concentrations in flat plate photobioreactors is relatively low compared to horizontal tubular photobioreactors. Milner's (1953) work paved the way to the use of flat culture vessels for cultivation of algae. Flat panel photo bioreactors were used extensively for mass cultivation of different algae (Tredici and Materassi, 1992; Hu et al., 1996; Zhang et al., 2002; Hoekema., 2002). Lack of temperature control and gas engagement zones are some of the inherent disadvantages observed with this type of photobioreactor.

8.5.2.5 Helical-Type Photobioreactors

A coiled transparent and flexible tube of small diameter with separate or attached degassing unit is the basis for the helical type of bioreactor. A centrifugal pump is used to drive the culture through a long tube to the degassing unit. CO₂ gas mixture and feed can be circulated from either direction, but injection from the bottom gives better photosynthetic efficiency (Morita et al., 2001). A degasser facilitates removal of photosynthetically produced oxygen and residual gas of the injected gas stream. This system facilitates better CO₂ transfer from gas phase to liquid phase due to a large CO₂ absorbing pathway (Watanabe et al., 1995). The energy required by the centrifugal pump in recirculating the culture and associated shear stress limits this reactor's commercial use (Briassoulis et al., 2010). Fouling on the inside of the reactor is another disadvantage of this system.

8.5.2.6 Stirred-Tank Photobioreactors

Stirred-tank photobioreactors are the conventional reactor setup in which agitation is provided mechanically with the help of impellers or baffles by providing illumination externally. CO₂-enriched air is bubbled at the bottom to provide a carbon source for algae growth (Petkov, 2000; Demessie and Bekele, 2003). *Protoceratium reticulatum* growth studied in 2 L and 15 L stirred photobioreactors equipped with internal spin filters showed average biomass cell productivity 3.7 times higher than that of the static cultures (Camacho et al., 2011). Low surface-area-to-volume ratio, which in turn decreases light-harvesting efficiency, is the inherent disadvantage of this system. Low surface-area-to-volume ratio and high shear stress imposed due to mechanical agitation limits this reactor's use in CO₂ sequestration (Demessie and Bekele, 2003).

8.6 PREPARATION OF ALGAL FUEL/BIODIESEL

Selection of appropriate inoculum and mode of cultivation are the key aspects involved in microalgae cultivation, which comes under preharvesting. Followed by preharvesting, the

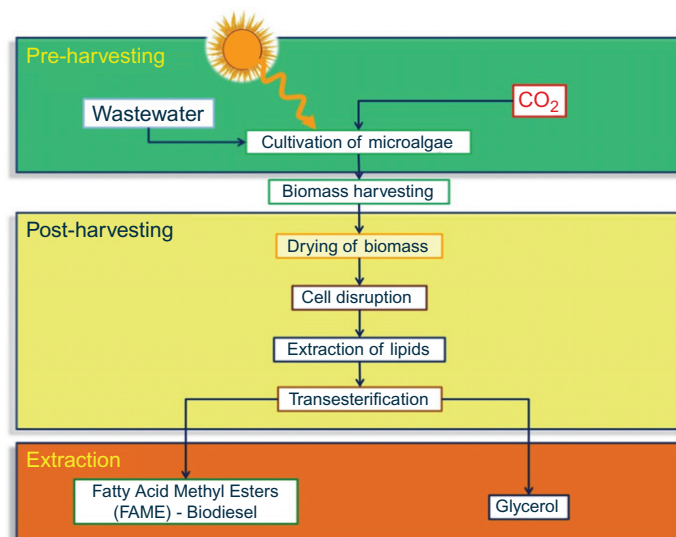

FIGURE 8.9 Schematic view of the processes involved in microalgae processing, from algae biomass cultivation to biodiesel production

processes for converting the algae biomass to biodiesel are crucial and involve a series of sequentially integrated post-harvesting steps: harvesting, drying, cell disruption, extraction, and transesterification, followed by the characterization of the fuel (Figure 8.9). These post-harvesting steps can be performed in different ways depending on the strain, substrate, and extraction method employed. Harvesting algal biomass could be the most energy-demanding process due to its concentration, smaller size, and surface charge, especially when the cultures are operated in open pond systems (Singh et al., 2011). Flocculation, sedimentation, and filtration are the common harvesting techniques that are widely used (Harun et al., 2010). Drying the biomass prior to extraction is a prerequisite so as to avoid moisture interference with the solvents. Drying can be performed using dryers or by exposing the biomass to diffused solar drying. Exposure to solar drying minimizes the production cost as well as power consumption. Subsequent to drying, cell disruption, oil extraction, transesterification of oil to fuel, and characterization of the fuel are explained in the following sections.

8.6.1 Cell Disruption

The disruption of algae cells prior to extraction is of particular importance because the contents of the extracted lipids are determined according to the disruption method and device employed. The selection of appropriate device for disruption is the key factor for enhancing the lipid extraction efficiency (Lee et al., 2010). The following are the methods commonly used for the disruption of algae cells.

8.6.1.1 Expeller Press Method

Expeller pressing (also called *oil pressing*) is a mechanical method applied for the disruption of algae cell membranes by squeezing the cells under high pressure (Mercer and Armenta, 2011). Expeller pressing can also be used as an extraction technique because it

can recover nearly 75% of the oil from algae cells in a single step. The advantages of this method include elimination of a solvent requirement and easy operation, the drawback associated with it is the requirement of a large amount of biomass.

8.6.1.2 Bead-Beating Method

The bead-beating method involves the application of beads for the disruption of the algal cell wall. Continuous exposure of biomass to beads leads to cell-wall rupture, resulting in the release of intracellular contents into the solvent medium. Similar to expeller pressing, this method can also be applied for both disruption and extraction. The influence of bead beating on cell-wall disruption was evaluated for the strains *Botryococcus braunii*, *Chlorella vulgaris*, and *Scenedesmus* sp. using a bead beater (bead diameter of 0.1 mm) (Lee et al., 2010). The method showed a lipid productivity of 28.1%.

Though the disruption of algae cell walls prior to extraction requires an additional step, which is the selection of a cost-effective method, it helps to enhance lipid production efficiencies. The methods discussed here are economical and applicable to mass cultures compared to few other techniques, such as microwaves, sonication, and autoclaving.

8.6.2 Extraction of Algae Oil

Microalgae are composed of single cells surrounded by an individual cell wall, which includes “unusual” lipid classes and fatty acids that differ from those in higher animals and plants (Guschina and Harwood, 2006). For extraction of lipids from microalgae, regular extraction methods may not be applicable (Eline et al., 2012). Extracting and purifying oil from algae is considered challenging due to its energy- and economically intensive nature (Fajardo et al., 2007; Lee et al., 2010; Mercer and Armenta, 2011).

8.6.2.1 Solvent Extraction

The existing procedures for the extraction of lipids from source material usually involve selective solvent extraction, and the starting material may be subjected to drying prior to extraction (Lee et al., 2010). Lipids are soluble in organic solvents but sparingly soluble or insoluble in water. Solubility of lipids is an important criterion for their extraction and typically depends on the type of lipid present and the proportion of nonpolar lipids (principally triacylglycerols) and polar lipids (mainly phospholipids and glycolipids) in the sample (Huang et al., 2010). Several solvent systems are used, depending on the type of sample and its components. The solvents of choice are usually hexane in the case of Soxhlet and Goldfish methods (Additions and Revisions, 2002); chloroform/methanol or chloroform/methanol/water in the case of the Folch Method (Folch and Sloane-Stanley, 1957); or modified Bligh and Dyer Procedure (Bligh and Dyer, 1959). This method is best suited to extract nonpolar lipids because polar lipids are scarcely soluble in nonpolar solvents.

8.6.2.2 Soxhlet Extraction

The Soxhlet extraction procedure is also used commonly for oil extraction. The goldfish extraction procedure may also be employed for this purpose. The Soxhlet extraction procedure is a semicontinuous process that allows the buildup of a solvent in the extraction

chamber for 5 to 20 minutes (Additions and Revisions, 2002). The solvent surrounding the sample is siphoned back into the boiling flask. The procedure provides a soaking effect and does not permit channeling. Polar and bound lipids are not recovered from this method.

8.6.2.3 Wet Lipid Extraction

The wet lipid extraction process uses wet algae biomass by using solvent proportionately (Sathish and Sims, 2012). This method resembles the solvent extraction process but varies with the nature of biomass (wet). The advantage of the process includes the elimination of a drying step, the interference of moisture content with the extraction solvents and lack of wide applicability to all kinds of solvents are the major limitations of this extraction procedure.

8.6.2.4 Hydrothermal Liquefaction

Hydrothermal liquefaction is a process in which biomass is converted in hot compressed water to a liquid biocrude (Brown et al., 2010; Biller et al., 2012). Processing temperatures range from 200–350 °C with pressures of around 15–20 MPa, depending on the temperature, because the water has to remain in the subcritical region to avoid the latent heat of vaporization (Biller et al., 2012). At these conditions, complex molecules are broken down and repolymerized to oily compounds (Peterson et al., 2008). This procedure is ideal for the conversion of high-moisture-content biomass such as microalgae because the drying step of the feedstock is not necessary.

8.6.2.5 Ultrasonic Extraction

Ultrasonic-assisted extractions can recover oils from microalgae cells through cavitation (Harun et al., 2010). During the low-pressure cycle, high-intensity small vacuum bubbles are created in the liquid. When the bubbles attain a certain size, they collapse violently during a high-pressure cycle. During the implosion very high pressures and high-speed liquid jets are produced locally, and the resulting shear forces break the cell structure mechanically. This effect supports the extraction of lipids from algae (Wei et al., 2008). The high-pressure cycles of the ultrasonic waves support the diffusion of solvents, such as hexane, into the cell structure. As ultrasound breaks the cell wall mechanically by the cavitation shear forces, it facilitates the transfer of lipids from the cell into the solvent (Cravotto et al., 2008).

8.6.2.6 Supercritical Carbon Dioxide Extraction (SC-CO₂)

Carbon dioxide usually behaves as a gas in air at standard temperature and pressure (STP) or as a solid called *dry ice* when frozen (Sahena et al., 2009; Mendiola et al., 2007). If the temperature and pressure are both increased from STP to at or above the critical point for carbon dioxide, CO₂ can adopt properties midway between a gas and a liquid and behave as a supercritical fluid, expanding like a gas but with a density like that of a liquid. Supercritical CO₂ is becoming an important commercial and industrial solvent due to its role in chemical extraction in addition to its low toxicity and environmental impact (Cooney et al., 2009). The relatively low temperature of the process and the stability of CO₂ also allow most compounds to be extracted with little damage or denaturing. The main drawbacks of this method include high power consumption and expense and difficulty involved in scaling up at this time (Eller, 1999).

8.6.2.7 Pulse Electric Field Technologies

Pulsed electric field (PEF) processing is a method for processing cells by means of brief pulses of a strong electric field (Guderjan et al., 2007). Algal biomass is placed between two electrodes and the pulsed electric field is applied. The electric field enlarges the pores of the cell membranes and expels its contents (Guderjan et al., 2004).

8.6.2.8 Enzymatic Treatment

Enzymatic extraction uses enzymes to degrade the cell walls, with water acting as the solvent (Mercer and Armenta, 2011). This makes the fraction of oil much easier. The combination of "sono-enzymatic treatment" causes faster extraction and higher oil yields compared to individual ultrasonication and enzymatic extractions alone (Fajardo et al., 2007). The drawbacks associated with the process are lack of commercial feasibility and inapplicability for mass cultures (Halim et al., 2011).

8.6.2.9 Osmotic Shock

Osmotic shock or osmotic stress is a sudden change in the solute concentration around a cell, causing a rapid change in the movement of water across its cell membrane (Fajardo et al., 2007). This shock causes a release in the cellular contents of microalgae. The method is more applicable for the strains cultivated in marine environments (eg. *Nannochloropsis* sp.). Osmotic shock is also induced to release cellular components for biochemical analysis (Mario, 2010). This method is also applied for *Halorubrum* sp. isolated from saltern ponds. The results showed increased lipid productivities and variations in lipid compositions (Lopalco et al., 2003).

Extraction of lipids is a key aspect involved in biomass-to-biodiesel production, the method directly influences the lipid productivity potential of the process. So far, several methods have been employed for extracting the cellular contents (lipids) of microalgae. Each method has its own advantages and disadvantages for practical applicability. Among the processes described, solvent extraction is suitable for extracting lipids from mass cultures but requires large volumes of solvent. The Soxhlet extraction method is applicable only when a single solvent is used and is not suitable for binary solvent applications. However, recovery and reusability of the solvent are possible with this method. The ultrasonic extraction method can perform well when coupled with the enzymatic treatment, but both methods lack cost effectiveness and feasibility for large-scale applications. Supercritical carbon dioxide extraction (SC-CO₂), pulse electric field procedure, osmotic shock, hydrothermal liquefaction, and wet lipid extraction require more optimization efforts for large-scale applications. A suitable method operatable with both binary and single solvents, applicable at large scales and yielding higher lipid productivities, is yet to be optimized for achieving enhanced microalgae lipid yields.

8.7 TRANSESTERIFICATION

The transesterification process consists of the reaction of triglyceride molecules with alcohol in the presence of a catalyst to produce glycerol and mono-alkyl fatty acid esters (Harrison et al., 2012). Biodiesel is typically transesterified using methanol, and therefore the fatty acid

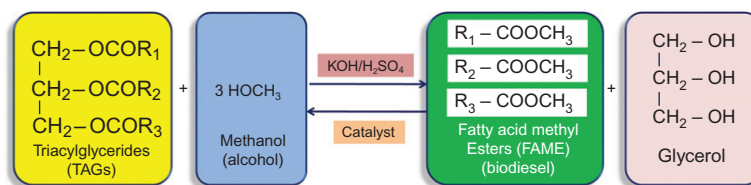

FIGURE 8.10 Transesterification reaction illustrating the conversion of triacyl glycerides to fatty acid methyl esters

alkyl esters that are produced are fatty acid methyl esters (FAME). The fatty acids are reacted with methanol to form diacyl glycerides, monoacyl glycerides, and finally, fatty acid methyl esters (FAMES) (Gong and Jiong, 2011). In this process glycerol is formed as byproduct (Figure 8.10). The transesterification process reduces the viscosity of the FAME compared to the parent oil, whereas the fatty acid composition will not be altered. FAMES are the most prevalent alkyl esters in the current biodiesel market because of the price and availability of methanol compared to other alcohols (Knothe et al., 1997). Alcohols are the key substrates in transesterification. The commonly used alcohols are methanol, ethanol, propanol, butanol, and amyl alcohol, but methanol is widely applied in the transesterification of microalgae oils because of its low cost and physical and chemical advantages. Acid, base, or enzyme catalyzed processes may be applied in transesterification reactions (Canakci and Gerpen, 1999). The nature of the catalyst (acid/base/enzyme) influences the type of reaction. Transesterification can also be performed in the absence of catalysts using a supercritical methanol process that occurs at high temperatures (200–350 °C) and pressures (20–50 MPa). The transesterification reaction proceeds in shorter times (<5 min). Currently, this method is applied for the conversion of vegetable oils and animal fats rather than for microalgae oils (Gong and Jiong, 2011; Kusdiana and Saka, 2001).

8.7.1 Direct Transesterification

The conversion of microalgae oil to biodiesel by direct transesterification involves both extraction and esterification in a single step (Sathish and Sims, 2012; Ehimen et al., 2010). The algae biomass can be effectively converted to fatty acid methyl esters through this process in relatively less time. Minimization of solvents and requirement of less time for reactions are the advantages of this method; the lipid productivity and success rate of the reactions are the associated drawbacks.

8.7.2 Acid-Catalyzed Transesterification

The acid-catalyzed transesterification process involves an acid catalyst ($\text{H}_2\text{SO}_4/\text{HCl}$) to undergo the reaction. These reactions are usually performed at high alcohol-to-oil-molar ratios, low to moderate temperatures and pressures, and high acid-catalyst concentrations (Zhang et al., 2003). Compared to base catalysts, acid catalysts are less susceptible to the presence of free fatty acids in the source feedstock (Helwani et al., 2009), but the reaction rates of

converting triglycerides to methyl esters are too slow (Gerpen, 2005). Repeated application of catalyst in the reactions increases the acid value of the microalgae oil.

8.7.3 Base-Catalyzed Transesterification

Base-catalyzed transesterification of microalgae oil is used most frequently and involves the presence of a base catalyst (hydroxides/carbonates) to precede the reaction (Meher et al., 2006; Vargha and Truter, 2005). In the reaction, the triglycerides are readily transesterified batchwise in the presence of the catalyst at an atmospheric pressure and temperature of 60–70 °C in the presence of excess methanol (Srivastava and Prasad, 2000). The main drawback with the process is the formation of soap at high free fatty acid concentrations (Furuta et al., 2004). Prior removal of free fatty acid and water from algae oils is a prerequisite for the reaction (Demirbas, 2008).

8.7.4 Enzyme-Catalyzed Transesterification

The reaction in an enzyme-catalyzed transesterification process is catalyzed by the enzyme lipase, whereby total triacylglycerides (both extracellular and intracellular) can be converted to biodiesel (Bisen et al., 2010). The conversion process requires complex processing instruments, and the costliness of the enzymes makes the process limiting. Immobilization was employed to overcome the limitations. However, the low feasibility of the process makes the reaction complex (Helwani et al., 2009; Watanabe et al., 2001).

8.8 ALGAL FUEL PROPERTIES

The characterization of the algal oil derived after transesterification showed the possibility of using it as biodiesel. The properties of the microalgae oil are mostly dependent on the feedstock and the conversion method used. Key aspects to evaluate the properties of microalgae oil are acid number, iodine number, specific gravity, density, kinematic viscosity, flash point, pour point, heating value, and cetane number. Table 8.1 illustrates the properties of algal fuel compared to conventional fuel.

Physical properties of microalgae oil show its efficiency to use as biodiesel. Of the properties derived, acid number (AN) indicates the corrosiveness of the oil; iodine values (IV) refer to the degree of unsaturation. The AN and IV recorded within the limits indicate the less corrosiveness and higher saturation of the algae fuel. Similarly, the specific gravity and density enumerated its energy efficiency as fuel. Flash point expresses the lowest temperature at which the oil vaporizes to form an ignitable mixture. The temperature of the flash point recorded for microalgae oil determined the potential of the oil to form ignitable mixtures at relatively lower temperatures over conventional diesel fuel. Pour point is the lowest temperature at which the oil becomes semisolid and loses its flow properties. It is also an important diesel quality parameter in tropical countries like India. The solidifying temperature of the microalgae oil shows its application as diesel. Similar to pour point, viscosity defines the fluids' resistance to flow; heating value is the energy released as heat when a compound

TABLE 8.1 Characterization of Microalgae Biodiesel

S. No.	Fuel Property	Biodiesel Standards (ASTM ^a)	Microalgae Biodiesel	Diesel Fuel (ASTM ^a)
1	Acid number (mg KOH/g of oil)	<0.5	0.42 ^a	0.7–1.0
2	Iodine value (g I/100 g of oil)	<25 (efficient fuel)	19.0 ^a	120
3	Specific gravity (g/cm ³)	0.85–0.90	0.85 ^c	0.82–0.90
4	Density (g/cm ³)	0.88	0.85 ^a	0.86–0.90
5	Kinematic viscosity (mm ² /s)	1.9–6.0	2.0–4.5 ^b	3.5
6	Heating value (MJ/kg)	44	37 ^b	42.2
7	Flash point (°C)	130	>130 ^c	>62
8	Pour point (°C)	–11.6	–6 ^c	–16
9	Cetane number	47	46 ^c	60

^a Venkata Mohan et al., 2011

^b Demirbas, 2008

^c U.S. Department of Energy, 2006

* ASTM = American Society for Testing and Materials

undergoes combustion. The less viscosity and higher energy values recorded for the algae oil denote its comparable features with standard norms and conventional fuel (Demirbas, 2008). Cetane number refers to the ignition quality of the diesel engines where it can be operated efficiently. The relative cetane number of microalgae oil with standard fuel indicates ignition and operational quality of algae fuel. Fatty composition of the microalgae oil (after transesterification) showed diverse fatty acid profiles over the other biological feedstocks (Table 8.2). The microalgae oil profile depicted a higher degree of saturation with wide fuel and food characteristics, whereas the rest of the feedstock documented higher degrees of unsaturation. Algal lipids contain a substantial quantity of long-chain polyunsaturated fatty acids (LC-PUFA), including eicosapentaenoic acid (EPA) and docosahexaenoic acid (DHA) (Chisti 2007). The EPA fatty acid has a carbon chain length of 20 with five double bonds (C20:5), and the DHA fatty acid has a carbon chain length of 22 with six double bonds (C22:6). The algal lipids have greater quantities of LC-PUFA compared to typical feedstock associated with higher quantities of fully saturated fatty acids (C14:0, C16:0 and C18:0), which have implications in terms of fuel properties (Harrison et al., 2012). The fatty acid composition (carbon chain length and degree of unsaturation) of FAME has a major effect on fuel properties. The most important characteristics affected by the level of unsaturation are oxidative stability, ignition quality (i.e., cetane number), and cold flow properties (Graboski and McCormick, 1998; Knothe et al., 1997; Ramos et al., 2009). Fully saturated methyl esters have high oxidative stability and a high cetane number but suffer from poor cold flow properties (Harrison et al., 2012). Conversely, methyl esters with a higher degree of unsaturation have better cold flow properties but decreased oxidative stability and decreased cetane number. Higher concentrations of some of the significant fatty acids, such as palmitic acid (C16:0) and oleic acids (C18:1), in microalgae oil are also a positive feature supporting the biofuel applications.

TABLE 8.2 Comparative Evaluation of Fatty Acid Composition of Microalgae with Other Biological Feedstocks

Fatty Acid	Lipid Number	<i>Jatropha curcas</i> ^a	Fungal Oil ^b	Rapeseed Oil ^b	Sunflower Oil ^b	Palm Oil ^b	Soy Oil ^b	Microalgae Oil		
								<i>Scenedesmus obliquus</i> ^c	<i>Chlorella vulgaris</i> ^c	Mixed Culture ^d
Lauric acid	12:0	Nd*	Nd	Nd	Nd	Nd	Nd	Nd	0.10	0.9
Myristic acid	14:0	0.1	1.6	0.1	Nd	0.7	Nd	Nd	Nd	6.7
Myristoleic acid	14:1	Nd	0.6	Nd	Nd	Nd	Nd	0.66	0.63	Nd
Penta decanoic acid	15:0	Nd	2.5	Nd	Nd	Nd	Nd	Nd	0.44	4.3
Palmitic acid	16:0	14.2	20.7	5.0	6.3	36.7	11.3	52.07	40.31	33.9
Palmitoleic acid	16:1	0.7	1.1	Nd	0.2	0.1	0.1	Nd	3.16	5.5
Stearic acid	18:0	7.0	7.0	1.6	2.2	6.6	3.6	7.48	8.01	15.9
Oleic acid	18:1	44.7	28.0	36.3	20.6	46.1	24.9	21.46	29.29	2.8
Linoleic acid	18:2	32.8	12.7	19.8	52.8	8.6	53.0	4.60	8.54	3.5
Linolenic acid	18:3	0.2	22.5	7.8	3.5	0.3	6.1	2.83	Nd	3.4
Arachidic acid	20:0	0.2	0.3	0.1	1.6	0.4	0.3	Nd	Nd	2.0
Gadoleic acid	20:1	Nd	Nd	9.1	0.3	0.2	0.3	Nd	Nd	Nd
Behenic acid	22:0	Nd	0.4	Nd	7.2	0.1	Nd	Nd	Nd	0.0
Erucic acid	22:1	Nd	0.07	20.2	5.1	Nd	0.3	Nd	Nd	1.3
Lignoceric acid	24:0	Nd	1.2	Nd	0.2	0.1	0.1	Nd	Nd	3.8
Nervonic acid	24:1	Nd	Nd	Nd	Nd	Nd	Nd	Nd	Nd	Nd
Others	–	Nd	1.3	Nd	Nd	Nd	Nd	Nd	Nd	0.1

^a Akbar et al., 2009^b Vicente et al., 2010^c Nascimento et al., 2012^d Venkata Mohan et al., 2011

* Nd=Not detected.

8.9 CONCLUDING REMARKS

Commercialization of algal oil production needs to overcome several obstacles. Space, water availability, efficient light utilization, cultivation system design, productivity of algal culture, algal growth and nutrient uptake, gas transfer and mixing, requirement of cooling, dissolved oxygen degassing, dewatering, oil extraction, and so on are some of the key issues that require considerable attention. Cost-cutting research with a multidisciplinary approach will help resolve some of the inherent limitations prior to up-scaling. Conjunction of the algal fuel production process with waste gas, wastewater, and water reclamation is a promising strategy to be considered for economic viability. Integration of algal fuel with simultaneous production of valuable byproducts will also have a positive impact on the overall process economics. At present, considerable interest in algal-based fuel in conjunction with intensified research makes a testimony that the process of algal biofuels will be economically viable and will be able to replace some proportion of fossil-fuel usage in the near future.

Acknowledgments

The authors want to thank Director, CSIR-IICT, Hyderabad, for his encouragement. Grant from CSIR in the form of the 12th plan task force project "BioEn" (CSC-0116) project is gratefully acknowledged.

References

- Abeliovich, A., Weisman, D., 1978. Role of heterotrophic nutrition in growth of the alga *Scenedesmus obliquus* in high-rate oxidation ponds. *Appl. Environ. Microbiol.* 35, 32–37.
- Abou-Shanab, R.A.I., Jeon, B.H., Song, H., Kim, Y., Hwang, J., 2010. Algae-Biofuel: Potential use as sustainable alternative green energy. *Online Journal on Power and Energy Engineering* 1, 4–6.
- Additions and Revisions to the Official Methods and Recommended Practices of the AOCS. AOCS Press, Champaign, IL, USA, 2002–2003.
- Ahluwalia, S.S., Goyal, D., 2007. Microbial and plant derived biomass for removal of heavy metals from wastewater. *Bioresour. Technol.* 98, 2243–2257.
- Akbar, E., Yaakob, Z., Kamarudin, S., Ismail, M., 2009. Characteristics and Composition of *Jatropha curcas* oil seed from Malaysia and its potential as Biodiesel Feedstock. *Eur. J. Sci. Res.* 29, 396–403.
- Alban, C., Baldet, P., Douce, R., 1994. Localization and characterization of two structurally different forms of acetyl-CoA carboxylase in young pea leaves, of which one is sensitive to aryloxyphenoxypropionate herbicides. *Biochem. J.* 300, 557–565.
- American Oil Chemists Society, 2003. AOCS Official Methods and Recommended Practices, fifth ed. AOCS Press: Champaign, pp. 4–38.
- Andersen, R.A., 2005. *Algal Culturing Techniques*. Elsevier Academic Press, Burlington, USA. pp. 205–216.
- Barbosa, M.J., Janssen, M., Ham, N., Tramper, J., Wijffels, R.H., 2003. Microalgae cultivation in air-lift reactors: modeling biomass yield and growth rate as a function of mixing frequency. *Biotechnol. Bioeng.* 82, 170–179.
- Becker, E.W., 1994. *Microalgae: Biotechnology and Microbiology*. Cambridge University Press, Cambridge, UK.
- Becker, E.W., 2004. Microalgae in human and animal nutrition. *Biotechnology and Applied Phycology* 312–351.
- Behrens, P.W., 2005. Photobioreactor and fermentors: the light and the dark sides of the growing algae. In: Andersen, R.A. (Ed.), *Algal Culturing Techniques*. Elsevier Academic Press, pp. 189–204.
- Bhatnagar, A., Bhatnagar, M., Chinnasamy, S., Das, K., 2010. *Chlorella minutissima*: a promising fuel alga for cultivation in municipal wastewaters. *Appl. Biochem. Biotechnol.* 161, 523–536.
- Bhatnagar, A., Chinnasamy, S., Singh, M., Das, K.C., 2011. Renewable biomass production by mixotrophic algae in the presence of various carbon sources and wastewaters. *Appl. Energy* 88, 3425–3431.

- Billar, P., Ross, A.B., Skill, S.C., Lea-Langton, A., Balasundaram, B., Hall, C., et al., 2012. Nutrient recycling of aqueous phase for microalgae cultivation from the hydrothermal liquefaction process. *Algal Research* 1, 70–76.
- Bisen, P.S., Sanodiya, B.S., Thakur, G.S., Baghel, R.K., Prasad, G.B.K.S., 2010. Biodiesel production with special emphasis on lipase-catalyzed transesterification. *Biotechnol. Lett.* 32, 1019–1030.
- Bligh, E.G., Dyer, W.J., 1959. A Rapid Method of Total Lipid Extraction and Purification. *Can. J. Biochem. Physiol.* 37, 911–917.
- Borowitzka, M.A., 1999. Commercial production of microalgae: ponds, tanks, tubes and fermenters. *J. Biotechnol.* 70, 313–321.
- Boyle, N.R., Morgan, J.A., 2009. Flux balance analysis of primary metabolism in *Chlamydomonas reinhardtii*. *BMC Syst. Biol.* 3, 4.
- Brennan, L., Owende, P., 2010. Biofuels from microalgae: a review of technologies for production, processing, and extractions of biofuels and co-products. *Renew. Sustain. Energ. Rev.* 14, 557–577.
- Brassoulis, D., Panagakis, P., Chionidis, M.T., Lalos, A., 2010. An experimental helical – tubular photobioreactor for continuous production of *Nannochloropsis* sp. *Bioresour. Technol.* 101, 6768–6777.
- Brown, T.M., Duan, P., Savage, P.E., 2010. Hydrothermal liquefaction and gasification of *Nannochloropsis* sp. *Energy & Fuels* 24, 3639–3646.
- Brune, D.E., Lundquist, T.J., Benemann, J.R., 2009. Microalgal biomass for greenhouse gas reductions: potential for replacement of fossil fuels and animal feeds. *J. Environ. Eng.* 135, 1136–1144.
- Camacho, F.G., Gallardo, R.J.J., Sánchez, M.A., Belarbi, E.H., Chisti, Y., Molina, G.E., 2011. Photobioreactor scale-up for a shear-sensitive dinoflagellate microalga. *Process Biochemistry* 46, 936–944.
- Campbell, M., 2008. Biodiesel: Algae as a Renewable Source for Liquid Fuel. *J. Guelph. Engineering* 1, 2–7.
- Canakci, M., Gerpen, J.V., 1999. Biodiesel production via acid catalysis. *Trans. ASAE* 42, 1203–1210.
- Chang, R.L., Ghamsari, L., Manichaikul, A., Hom, E.F.Y., Balaji, S., Fu, W., et al., 2011. Metabolic network reconstruction of *Chlamydomonas* offers insight into light-driven algal metabolism. *Mol. Syst. Biol* 7, Article number 518; <http://dx.doi.org/10.1038/msb.2011.52>.
- Chandra, R., Venkata Mohan, S., 2011. Microalgal community and their growth conditions influence biohydrogen production during integration of dark-fermentation and photo-fermentation processes. *Int. J. Hydrogen Energ.* 36, 12211–12219.
- Chandra, R., Venkata Subhash, G., Venkata Mohan, S., 2012. Mixotrophic operation of photo-bioelectrocatalytic fuel cell under anoxygenic microenvironment enhances the light dependent bioelectrogenic activity. *Bioresour. Technol.* 109, 46–56.
- Chen, F., 1996. High cell density culture of microalgae in heterotrophic growth. *Trends Biotechnol.* 14, 421–426.
- Chen, F., Johns, M.R., 1996. Heterotrophic growth of *Chlamydomonas reinhardtii* on acetate in chemostat culture. *Process Biochem.* 31, 601–604.
- Chen, C.Y., Yeh, K.L., Aisyah, R., Lee, D.J., Chang, J.S., 2011. Cultivation, photobioreactor design and harvesting of microalgae for biodiesel production: A critical review. *Bioresour. Technol.* 102, 71–81.
- Chinnasamy, S., Bhatnagar, A., Hunt, R.W., Das, K.C., 2010. Microalgae cultivation in a wastewater dominated by carpet mill effluents for biofuel applications. *Bioresour. Technol.* 101, 3097–3105.
- Chisti, Y., 1989. *Airlift Bioreactors*. Elsevier, London, UK.
- Chisti, Y., 2007. Biodiesel from microalgae. *Biotechnol. Adv.* 25, 294–306.
- Chiu, S.Y., Kao, C.Y., Chen, C.H., Kuan, T.C., Ong, S.C., Lin, C.S., 2008. Reduction of CO₂ by a high-density culture of *Chlorella* sp. in a semicontinuous photobioreactor. *Bioresour. Technol.* 99, 3389–3396.
- Chojnacka, K., Noworyta, A., 2004. Evaluation of *Spirulina* sp. growth in photoautotrophic, heterotrophic and mixotrophic cultures. *Enzyme Microb. Technol.* 34, 461–465.
- Cooney, M., Young, G., Nagle, N., 2009. Extraction of bio-oils from microalgae. *Sep. Purif. Rev.* 38, 291–325.
- Cravotto, G., Boffa, L., Mantegna, S., Perego, P., Avogadro, M., Cintas, P., 2008. Improved Extraction of Vegetable Oils under High-Intensity Ultrasound and/or Microwaves. *Ultrason. Sonochem.* 15, 898–902.
- de-Bashan, L.E., Bashan, Y., 2010. Immobilized microalgae for removing pollutants: review of practical aspects. *Bioresour. Technol.* 101, 1611–1627.
- Debjani, M., Van, J.L., Buddhi, L., 2012. Heterotrophic/mixotrophic cultivation of oleaginous *Chlorella vulgaris* on industrial co-products. *Algal Research* 1, 40–48.
- Degen, J., Uebele, A., Retze, A., Schmid-Staiger, U., Trosch, W., 2001. A novel airlift photobioreactor with baffles for improved light utilization through the flashing light effect. *J. Biotechnol.* 92, 89–94.
- Demessie, E.S., Bekele, S.U.R., 2003. Pillai Residence time distribution of fluids in stirred annular photoreactor. *Calculus Today* 88, 61–72.

- Demirbas, A., 2007. Importance of biodiesel as transportation fuel. *Energy policy* 35, 4661–4670.
- Demirbas, A., 2008. Comparison of transesterification methods for production of biodiesel from vegetable oils and fats. *Energy Convers. Manage.* 49, 125–130.
- Doran, P.M., 1995. *Bioprocess Engineering Principles*. Academic Press Limited, London.
- Dragone, G., Fernandes, B., Vicente, A.A., Teixeira, J.A., 2010. Third generation biofuels from microalgae. In: Méndez-Vilas, A. (Ed.), *Applied Microbiology and Microbial Biotechnology*. Current Research, Technology and Education, Formatek Research Centre, Spain.
- Duan, P., Savage, P.E., 2010. Hydrothermal liquefaction of a microalga with heterogeneous catalysts. *Industrial and Engineering Chemistry Research* 50, 52–61.
- Eberhard, S.G., Finazzi, F.A., Wollman, 2008. The dynamics of photosynthesis. *Annu. Rev. Genet.* 42, 463–515.
- Ehimen, E.A., Sun, Z.F., Carrington, C.G., 2010. Variables affecting the *in situ* transesterification of microalgae lipids. *Fuel* 89, 677–684.
- Eline, R., Koenraad, M., Imogen, F., 2012. Optimization of an Analytical Procedure for Extraction of Lipids from Microalgae. *J. Am. Oil Chem. Soc.* DOI <http://dx.doi.org/10.1007/s11746-011-1903-z>.
- Eller, F.J., 1999. Interference by methyl levulinate in determination of total fat in low-fat, high-sugar products by gas chromatographic fatty and methyl ester (GC-FAME) analysis. *J. Assoc. Off. Anal. Chem. Int.* 82, 766–769.
- Fajardo, A.R., Cerdán, L.E., Medina, A.R., Gabriel, F., Fernández, A., Moreno, P.A., et al., 2007. Lipid extraction from the microalga *Phaeodactylum tricornutum*. *Eur. J. Lipid. Sci. Technol.* 109, 120–126.
- Fan, J., Andre, C., Xu, C., 2011. A chloroplast pathway for the de novo biosynthesis of triacylglycerol in *Chlamydomonas reinhardtii*. *FEBS Lett.* 585, 1985–1991.
- Folch, J.L., Sloane-Stanley, G.H., 1957. A simple method for the isolation and purification of total lipids from animal tissues. *J. Biol. Chem.* 226, 497–509.
- Furuta, S., Matsushashi, H., Arata, K., 2004. Biodiesel fuel production with solid superacid catalysis in fixed bed reactor under atmospheric pressure. *Catal. Commun.* 5, 721–723.
- Ge, Y., Liu, J., Tian, G., 2011. Growth characteristics of *Botryococcus braunii* 765 under high CO₂ concentrations in photobioreactor. *Bioresour. Technol.* 102, 130–134.
- Gerpen, V.J., 2005. Biodiesel processing and production. *Fuel Processing Technology* 86, 1097–1107.
- Gong, Y., Jiang, M., 2011. Biodiesel production with microalgae as feed stock: from strains to biodiesel. *Biotech. Letters* 33, 1269–1284.
- Gouveia, L., Oliveira, A.C., 2009. Microalgae as a raw material for biofuels production. *J. Ind. Microbiol. Biotechnol.* 36, 269–274.
- Graboski, M.S., McCormick, R.L., 1998. Combustion of fat and vegetable oil derived Fuels in diesel engines. *Progress in Energy and Combustion Science* 24, 125–164.
- Graham, L.E., Wilcox, L.W., 2000. *Algae*. Prentice-Hall, Inc., Upper Saddle River, NJ, USA. 640.
- Greenwell, H.C., Laurens, L.M.L., Shields, R.J., Lovitt, R.W., Flynn, K.J., 2010. Placing microalgae on the biofuels priority list: a review of the technological challenges. *Soc. Interface* 7, 703–726.
- Groom, M.J., Gray, E.M., Townsend, P.A., 2008. Biofuels and biodiversity: principles for creating better policies for biofuel production. *Conserv. Biol.* 22, 602–609.
- Guderjan, M., Topfl, S., Angersbach, A., Knorr, D., 2004. Impact of pulsed electric field treatment on the recovery and quality of plant oils. *J. Food Eng.* 67, 281–287.
- Guderjan, M., Elez-Martínez, P., Knorr, D., 2007. Application of pulsed electric Welds at oil yield and content of functional food ingredients at the production of rapeseed oil. *Innov. Food Sci. Emreg. Tech.* 8, 55–62.
- Guschina, I.A., Harwood, J.L., 2006. Lipids and lipid metabolism in eukaryotic algae. *Prog. Lipid. Res.* 45, 160–186.
- Halim, R., Gladman, B., Danquah, M.K., Webley, P.A., 2011. Oil extraction from microalgae for biodiesel production. *Bioresour. Technol.* 102, 178–185.
- Hanagata, N., Takeuchi, T., Fukujū, Y., Barnes, D.J., Karube, I., 1992. Tolerance of microalgae to high CO₂ and high temperature. *Phytochemical* 31, 3345–3348.
- Harrison, B.B., Marc, E.B., Anthony, J.M., 2012. Chemical and physical properties of algal methyl ester biodiesel containing varying levels of methyl eicosapentaenoate and methyl docosahexaenoate. *Algal Research* 1, 57–69.
- Harun, R., Danquah, M.K., Forde, G.M., 2010. Microalgal biomass as a fermentation feedstock for bioethanol production. *J. Chem. Technol. Biotechnol.* 85, 199–203.
- Helwani, Z., Othman, M.R., Aziz, N., Fernando, W.J.N., Kim, J., 2009. Technologies for production of biodiesel focusing on green catalytic techniques: A review. *Fuel Processing Technology* 90, 1502–1514.
- Hoek, V.C., Mann, D.G., Jahns, H.M., 1995. *Algae. An introduction to phycology*. Cambridge University Press: New York, USA.

- Hoekema, S., 2002. A pneumatically agitated flat-panel photobioreactor with gas re-circulation: anaerobic photoheterotrophic cultivation of a purple non-sulfur bacterium. *Int. J. Hydrogen Energy* 27, 1331–1338.
- Hoffmann, J.P., 1998. Wastewater treatment with suspended and nonsuspended algae. *J. Phycol.* 34, 757–763.
- Hong, S.J., Lee, C.G., 2007. Evaluation of central metabolism based on a genomic database of *Synechocystis* PCC6803. *Biotechnol. Bioprocess Eng* 12, 165–173.
- Hossain, A.B.M.S., Salleh, A., Boyce, A.N., Chowdhury, P., Naquiddin, M., 2008. Biodiesel fuel production from algae as renewable energy. *Am. J. Biochem. Biotech.* 4, 250–254.
- Hu, Q., Guterma, H., Richmond, A., 1996. A flat inclined modular photobioreactor for outdoor mass cultivation of photoautotrophs. *Biotechnol. Bioeng.* 51, 51–60.
- Huang, G., Chen, F., Wei, D., Zhang, X., Chen, G., 2010. Biodiesel production by microalgal biotechnology. *Appl. Energ.* 87, 38–46.
- Huntley, M., Redalje, D., 2007. CO₂ mitigation and renewable oil from photosynthetic microbes: a new appraisal. *Mitig. Adapt. Strategies Glob. Change* 12, 573–608.
- Indra, S., Halldor, G.S., Sigurbjörn, E., Ása, B., Grzegorz, M., 2010. Geothermal CO₂ bio-mitigation techniques by utilizing microalgae at the blue lagoon. In: *Iceland Thirty-Fourth Workshop on Geothermal Reservoir Engineering*. Stanford University, Stanford, CA, USA.
- Janssen, M., Tramper, J., Mur, L.R., Wijffels, R.H., 2003. Enclosed outdoor photobioreactors: light regime, photosynthetic efficiency, scale-up, and future prospects. *Biotechnol. Bioeng.* 81, 193–210.
- Johnson, M.B., Wen, Z.Y., 2010. Development of an attached microalgal growth system for biofuel production. *Appl. Microbiol. Biotechnol.* 85, 525–534.
- Kaewpintong, K., Shotipruk, A., Powtongsook, S., Pavasant, P., 2007. Photoautotrophic high-density cultivation of vegetative cells of *Haematococcus pluvialis* in airlift bioreactor. *Bioresour. Technol.* 98, 288–295.
- Kamiya, A., Kowallik, W., 1987. The inhibitory effect of light on proton-coupled hexose uptake in *Chlorella*. *Plant Cell Physiol.* 28, 621–625.
- Kaplan, D., Richmond, A.E., Dubinsky, Z., Aaronson, S., 1986. Algal nutrition. In: Richmond, A. (Ed.), *Handbook for Microalgal Mass Culture*. CRC Press, pp. 147–198.
- Kazamia, E., Czesnick, H., Van Nguyen, T.T., Croft, M.T., Sherwood, E., Sasso, S., et al., 2012. Mutualistic interactions between vitamin B12-dependent algae and heterotrophic bacteria exhibit regulation. *Environ. Microbiol.* 14, 1466–1476.
- Kim, M.K., Park, J.W., Park, C.S., Kim, S.J., Jeune, K.H., Chang, M.U., et al., 2007. Enhanced production of *Scenedesmus* spp. (green microalgae) using a new medium containing fermented swine wastewater. *Bioresour. Technol.* 98, 2220–2228.
- Knothe, G., 2006. Analyzing biodiesel: standards and other methods. *J. Am. Oil Chem. Soc.* 83, 823–833.
- Knothe, G., Dunn, R., Bagby, M., 1997. Biodiesel: the use of vegetable oils and their derivatives as alternative diesel fuels. *Fuels and Chemicals from Biomass* 172–208.
- Kong, W.B., Song, H., Hua, S.F., Yang, H., Yang, Q.i., Xia, C.G., 2012. Enhancement of biomass and hydrocarbon productivities of *Botryococcus braunii* by mixotrophic cultivation and its application in brewery wastewater treatment. *African Journal of Microbiology Research* 61489–61496.
- Komor, E., 1973. Proton-coupled hexose transport in *Chlorella vulgaris*. *FEBS Lett.* 38, 16–18.
- Komor, Tanner, 1974. The hexose-proton symport system of *Chlorella vulgaris*: specificity, stoichiometry and energetic of sugar-induced proton uptake. *Eur. J. Biochem.* 44, 219–223.
- Krause, G.H., Weis, E., 1991. Chlorophyll fluorescence and photosynthesis: The basics. *Annu. Rev. Plant. Physiol. Plant. Mol. Biol.* 42, 313–349.
- Kusdiana, D., Saka, S., 2001. Kinetics of transesterification in rapeseed oil to biodiesel fuel as treated in supercritical methanol. *Fuel* 80, 693–698.
- Lee, Y.K., 2004. Algal nutrition. Heterotrophic carbon nutrition. In: Richmond, A. (Ed.), *Handbook of Microalgal Culture: Biotechnology and Applied Phycology*. Blackwell Publishing, Oxford, UK, p. 116.
- Lee, K., Lee, C.G., 2002. Nitrogen removal from wastewaters by microalgae without consuming organic carbon sources. *J. Microbiol. Biotechnol.* 12, 979–985.
- Lee, J.Y., Yoo, C., Jun, S.Y., Ahn, C.Y., Oh, H.M., 2010. Comparison of several methods for effective lipid extraction from microalgae. *Bioresour. Technol.* 101, 75–77.
- Li, F.W., Pei, C., Ai, P.H., Chi, M.L., 2012. The feasibility of biodiesel production by microalgae using industrial wastewater. *Bioresour. Technol.* 113, 14–18.
- Liu, B., Benning, C., 2012. Lipid metabolism in microalgae distinguishes itself. *Curr. Opin. Biotechnol.* 24, 300–309.

- Lloyd, D., 1974. Dark respiration. In: Stewart, W.D.P. (Ed.), *Algal Physiology and Biochemistry*. Blackwell Scientific Publications, Oxford, UK, pp. 505–529.
- Lopalco, P., Lobasso, S., Babudri, F., Corcelli, A., 2003. Osmotic shock stimulates de novo synthesis of two cardiolipins in an extreme halophilic archaeon. *J. Lipid Res.* 44, 194–201.
- Ma, F., Hanna, M.A., 1999. Biodiesel production: a review. *Bioresour. Technol.* 70, 1–15.
- Mallik, N., 2002. Biotechnological potential of immobilized algae for wastewater N, P and metal removal: a review. *Biomaterials* 15, 377–390.
- Mario, C.L., 2010. US Patent US2009/060722.
- Martinez, M.E., Sanchez, S., Jimenez, J.M., El Yousfi, F., Munoz, L., 2000. Nitrogen and phosphorus removal from urban wastewater by the microalga *Scenedesmus obliquus*. *Bioresour. Technol.* 73, 263–272.
- Masseret, E., Amblard, C., Bourdier, G., Sargos, D., 2000. Effects of a waste stabilization lagoon discharge on bacterial and phytoplanktonic communities of a stream. *Water Environ. Res.* 72, 285–294.
- Mata, T.M., Martins, A.A., Caetano, N.S., 2010. Microalgae for biodiesel production and other applications: a review. *Renew. Sust. Energ. Rev.* 14, 217–232.
- Meher, L.C., Sagar, D.V., Naik, S.N., 2006. Technical aspects of biodiesel production by transesterification: a review. *Renewable & Sustainable Energy Reviews* 10, 248–268.
- Mendiola, J.A., Jaime, L., Santoyo, S., Reglero, G., Cifuentes, A., Ibanez, E., et al., 2007. Screening of functional compounds in supercritical fluid extracts from *Spirulina platensis*. *Food Chem.* 102, 1357–1367.
- Mercer, P., Armenta, R.E., 2011. Developments in oil extraction from microalgae. *Eur. J. Lipid. Sci. Technol.* 113 (5), 539–547.
- Milner, H.W., 1953. Rocking tray. In: Burlew, J.S. (Ed.), *Algal Culture from Laboratory to Pilot Plant*. Carnegie Institution: Washington, DC, 600, p. 108.
- Miron, S.A., Camacho, G.F., Gomez, C.A., Grima, M.E., Chisti, Y., 2000. Bubble column and airlift photobioreactors for algal culture. *AIChE Journal* 46, 1872–1887.
- Morita, M., Watanabe, Y., Okawa, T., Saiki, H., 2001. Photosynthetic productivity of conical helical tubular photobioreactors incorporating *Chlorella* sp. under various culture medium flow conditions. *Biotechnol. Bioeng.* 74, 137–144.
- Munoz, R., Guieysse, B., 2006. Algal–bacterial processes for the treatment of hazardous contaminants: a review. *Water Res.* 40, 2799–2815.
- Murata, N., Siegenthaler, P.A., 2004. Lipids in Photosynthesis: Structure, Function and Genetics. *Advances in Photosynthesis and Respiration*, Kluwer Academic Publishers, Dordrecht, 6, 1–20.
- Nascimento, M.D., Marquez, J.C.F.O., Rizza, L.S., Echarte, M.M., Curatti, L., 2012. Bioprospecting for fast growing and biomass characterization of oleaginous microalgae from South–Eastern Buenos Aires, Argentina. *Algal Res.* 125, 283–290.
- Neilson, A.H., Lewin, R.A., 1974. The uptake and utilization of organic carbon by algae: an essay in comparative biochemistry. *Phycologia* 13, 227–264.
- Nelson, J.A., Saveriede, P.B., Lefebvre, P.A., 1994. The CRY1 gene in *chlamydomonas reinhardtii*: Structure and use as a dominant selectable marker for nuclear transformation. *Mol. Cell Biol.* 14, 4011–4019.
- Nelson, N., Yocum, C., 2006. Structure and function of photosystems I and II. *Annu. Rev. Plant Biol.* 57, 521–565.
- Nelson, D.L., Cox, M.M., 2009. *Lehninger principles of biochemistry*, fourth ed. W.H. Freeman & Co., New York, USA.
- Nigar, K., Fahir, B., Kutlu, O.U., 2005. Bubble column reactors. *Process Biochemistry* 40, 2263–2283.
- Ogawa, T., Aiba, S., 1981. Bioenergetic analysis of mixotrophic growth in *Chlorella vulgaris* and *Scenedesmus acutus*. *Biotechnol. Bioeng.* 23, 1121–1132.
- Ohlroggeav, J., Browseb, J., 1995. Lipid Biosynthesis. *Plant Cell* 7, 957–970.
- Olguín, E.J., Giuliano, G., Porro, D., Tuberosa, R., Salamin, F., 2012. Biotechnology for a more sustainable world. *Biotechnol. Adv.* 30 (5), 931–932.
- Orpez, R., Martinez, M.E., Hodaifa, G., El Yousfi, F., Jbari, N., Sanchez, S., 2009. Growth of the microalga *Botryococcus braunii* in secondarily treated sewage. *Desalination* 246, 625–630.
- Pearson, H.W., 1996. Expanding the Horizons of Pond Technology and Application in an Environmentally Conscious World. *Water Sci Technol.* 33, 1–9.
- Perez-Garcia, R.O., Bashan, Y., Puente, M.E., 2011. Organic carbon supplementation of municipal wastewater is essential for heterotrophic growth and ammonium removing by the microalga *Chlorella vulgaris*. *J. Phycol.* 47, 190–199.

- Peterson, A., Vogel, F., Lachance, R., Froling, M., Antal, M., Tester, J., 2008. Thermochemical biofuel production in hydrothermal media: A review of sub- and supercritical water technologies. *Energy Environ. Sci.* 1, 32–65.
- Petkov, 2000. Absorber Tower as a Photobioreactor for Microalgae. *Russ. J. Plant Physiol.* 47, 786–788.
- Pollard, M.R., Stumpf, P.K., 1980. Long-chain (C20 and C22) fatty acid biosynthesis in developing seeds of *Tropaeolum majus*: an in vivo study. *Plant Physiol.* 66, 641–648.
- Posten, C., Schaubb, G., 2009. Microalgae and terrestrial biomass as source for fuels: A process view. *J. Biotechnol. Solar Biofuels* 142, 64–69.
- Prathima Devi, M., Venkata Mohan, 2012. CO₂ supplementation to domestic wastewater enhances microalgae lipid accumulation under mixotrophic microenvironment: Effect of sparging period and interval. *Bioresour. Technol.* 112, 116–123.
- Prathima Devi, M., Venkata Subhash, G., Venkata Mohan, S., 2012. Heterotrophic cultivation of mixed microalgae for lipid accumulation and wastewater treatment during sequential growth and starvation phases. Effect of nutrient supplementation. *J. Renew Energy* 43, 276–283.
- Pulz, O., 2001. Photobioreactors: production systems for phototrophic microorganisms. *Appl. Microbiol. Biotechnol.* 57, 287–293.
- Ramanan, R., Kannan, K., Deshkar, A., Yadav, R., Chakrabarti, T., 2010. Enhanced algal CO₂ sequestration through calcite deposition by *Chlorella sp.* and *Spirulina platensis* in a mini-raceway pond. *Bioresour. Technol.* 101, 2616–2622.
- Ramanathan, G., Rajarathinam, K., Boothapandi, M., Abirami, D., Ganesamoorthy, G., Duraipandi, 2011. Construction of vertical tubular photobioreactor for microalgae cultivation. *J. Algal Biomass Utiln.* 2, 41–52.
- Ramos, M.J., Fernandez, C.M., Casas, A., Rodriguez, L., Perez, A., 2009. Influence of fatty acid composition of raw materials on biodiesel properties. *Bioresour. Technol.* 100, 261–268.
- Richmond, A., 2000. Microalgal biotechnology at the turn of the millennium: A personal view. *J. Appl. Phycol.* 12, 441–451.
- Richmond, A., 2004. *Handbook of microalgal culture biotechnology and applied phycology*. Blackwell Publishing Company, Oxford, UK.
- Robert, M.H., Christina, E.C., Tom, N.K., Stephen, L.F., Oybek, K., David, R.S., et al., 2012. Evaluation of environmental impacts from microalgae cultivation in open-air raceway ponds: Analysis of the prior literature and investigation of wide variance in predicted impacts. *Algal Research* 1, 83–92.
- Rojan, P.J., Anisha, G.S., Madhavan, N.K., Pandey, A., 2011. Micro and macroalgal biomass: A renewable source for bioethanol. *Bioresour. Technol.* 102, 186–193.
- Round, F.E., 1984. *The Ecology of Algae*. Cambridge University Press: NY, USA.
- Ruiz-Marin, A., Mendoza-Espinosa, L.G., Stephenson, T., 2010. Growth and nutrient removal in free and immobilized green algae in batch and semi-continuous cultures treating real wastewater. *Bioresour. Technol.* 101, 58–64.
- Sahena, F., Zaidul, I.S.M., Jinap, S., Karim, A.A., Abbas, K.A., Norulaini, N.A.N., et al., 2009. Application of supercritical CO₂ in lipid extraction: A review. *J. Food Eng.* 95, 240–253.
- Sathish, A., Sims, R.C., 2012. Biodiesel from mixed culture algae via a wet lipid extraction procedure. *Bioresour. Technol.* 118, 643–647.
- Schwender, J., Ohlrogge, J.B., 2002. Probing in vivo metabolism by stable isotope labeling of storage lipids and proteins in developing *Brassica napus* embryos. *Plant Physiol.* 130, 347–361.
- Shi, J., Podola, B., Melkonian, M., 2007. Removal of nitrogen and phosphorus from wastewater using microalgae immobilized on twin layers: an experimental study. *J. Appl. Phycol.* 19, 417–423.
- Sierra, E., Acién, F.G., Fernandez, J.M., Garcia, J.L., Gonzalez, C., Molina, E., 2008. Characterization of a flat plate photobioreactor for the production of microalgae. *Chemical Engineering Journal* 138, 136–147.
- Singh, A., Singh, P.N., Murphy, J.D., 2011. Renewable fuels from algae: an answer to debatable land based fuel. *Bioresour. Technol.* 102 (1), 10–16.
- Smith, B., Greenwell, H.C., Whiting, A., 2009. Catalytic upgrading of tri-glycerides and fatty acids to transport biofuels. *Energy Environ. Sci.* 2, 262–271.
- Somerville, C., Browse, J., Jaworski, J.G., Ohlrogge, J.B., 2000. Lipids. In: Buchanan, B., Gruissem, W., Jones, R. (Eds.), *Biochemistry and Molecular Biology of Plants*. American Society of Plant Physiology: Rockville, MD, USA, pp. 465–527.
- Srivastava, A., Prasad, R., 2000. Triglycerides-based diesel fuels. *Renewable and Sustainable Energy Reviews* 4, 111–133.

- Stephens, E., Ross, I.L., King, Z., Musssnug, J.H., Kruse, O., Posten, C., et al., 2010. An economic and technical evaluation of microalgal biofuels. *Nat. Biotechnol.* 28, 126–128.
- Stephenson, A.L., Kazamia, E., Dennis, J.E., Howe, C.J., Scott, S.A., Smith, A.G., 2010. Life-cycle assessment of potential algal biodiesel production in the United Kingdom: A comparison of raceways and air-lift tubular bioreactors. *Energy Fuels* 24, 4062–4077.
- Takagi, M., Watanabe, K., Yamaberi, K., Yoshida, T., 2000. Limited feeding of potassium nitrate for intracellular lipid and triglyceride accumulation of *Nannochloris* sp. UTEX LB1999. *Appl. Microbiol. Biotechnol.* 54, 112–117.
- Tanner, W., 1969. Light-driven active uptake of 3-Omethylglucose via an inducible hexose uptake system of *Chlorella*. *Biochem. Biophys. Res. Commun.* 36, 278–283.
- Tanner, W., 2000. The *Chlorella* hexose-symporters. *Int. Rev. Cytol.* 200, 101–141.
- Thelen, J.J., Ohlrogge, J.B., 2002. Metabolic Engineering of Fatty Acid Biosynthesis in Plants *Metabolic Engineering*. 4, 12–21.
- Tredici, M.R., 2004. Mass production of microalgae: Photobioreactors. In: Richmond, A. (Ed.), *Handbook of microalgal culture: biotechnology and applied phycology*. Blackwell Publishing, Oxford, UK, pp. 178–214.
- Tredici, M.R., Materassi, R., 1992. From open ponds to vertical alveolar panels: the Italian experience in the development of reactor for the mass cultivation of the photoautotrophic microorganisms. *J. Appl. Psychol.* 4, 21–231.
- U.S. Department of Energy, 2006. *Biodiesel Handling and Use Guidelines*, second ed, NREL, Oakridge, England, UK.
- Ugwu, C.U., Aoyagi, H., Uchiyama, H., 2008. Photobioreactors for mass cultivation of algae. *Bioresour. Technol.* 99, 4021–4028.
- Vargha, V., Truter, P., 2005. Biodegradable polymers by reactive blending transesterification of thermoplastic starch with poly(vinyl acetate) and poly(vinyl acetate-co-butyl acrylate). *Eur. Polymer J.* 41, 715–726.
- Venkata Mohan, S., Srikanth, S., Veer Raghavulu, S., Mohanakrishna, G., Kiran Kumar, A., Sarma, P.N., 2009. Evaluation of the potential of various aquatic ecosystems in harnessing bioelectricity through benthic fuel cell: effect of electrode assembly and water characteristics. *Bioresour. Technol.* 100, 2240–2246.
- Venkata Mohan, S., Prathima Devi, M., Mohanakrishna, G., Amarnath, N., Lenin Babu, M., Sarma, P.N., 2011. Potential of mixed microalgae to harness biodiesel from ecological water-bodies with simultaneous treatment. *Bioresour. Technol.* 102, 1109–1117.
- Venkata Mohan, S., Prathima Devi, M., 2012. Fatty acid rich effluent from acidogenic biohydrogen reactor as substrate for lipid accumulation in heterotrophic microalgae with simultaneous treatment. *Bioresour. Technol.* 123, 627–635.
- Venkata Subhash, G., Chandra, R., Venkata Mohan, S., 2013. Microalgae mediated bio-electrocatalytic fuel cell facilitates bioelectricity generation through oxygenic photomixotrophic mechanism. *Bioresour. Technol.* <http://dx.doi.org/10.1016/j.biortech.2013.02.035>.
- Vicente, G., Fernando, B.L., Francisco, J.G., Rosalia, R., Virginia, M., Rosa, A.R.F., et al., 2010. Direct transformation of fungal biomass from submerged cultures into biodiesel. *Energy Fuels* 24, 3173–3178.
- Voltolina, D., Cordero, B., Nieves, M., Soto, L.P., 1999. Growth of *Scenedesmus* sp. in artificial wastewater. *Bioresour. Technol.* 68, 265–268.
- Wang, B., Li, Y., Wu, N., Christopher, Q.L., 2008. CO₂ bio-mitigation using microalgae. *Appl. Microbiol. Biotechnol.* 79, 707–718.
- Wang, L., Li, Y.C., Chen, P., Min, M., Chen, Y.F., Zhu, J., et al., 2010. Anaerobic digested dairy manure as a nutrient supplement for cultivation of oil-rich green microalgae *Chlorella* sp. *Bioresour. Technol.* 101, 2623–2628.
- Watanabe, Y., Shimada, Y., Sugihara, A., Tominaga, Y., 2001. Enzymatic conversion of waste edible oil to biodiesel fuel in a fixed-bed bioreactor. *J. Am. Oil Chem. Soc.* 78, 703–707.
- Watanabe, Y., de la Noue, J., Hall, D.O., 1995. Photosynthetic performance of a helical tubular photobioreactor incorporating the cyanobacterium *Spirulina platensis*. *Biotechnol. Bioeng.* 47, 261–269.
- Wei, F., Gao, G.Z., Wang, X.F., Dong, X.Y., 2008. Quantitative determination of oil content in small quantity of oilseed rape by ultrasound-assisted extraction combined with gas chromatography. *Ultrason. Sonochem.* 15, 938–942.
- Weissman, J., 1987. Photobioreactor Design: Comparison of Open Ponds. *Bioeng. Biotech.* 31, 336–344.
- Weyer, K.M., Bush, D.R., Darzins, A., Willson, B.D., 2009. Theoretical maximum algal oil production. *Bioenergy Research* 3, 204–213.
- Wilkie, A.C., Mulbry, W.W., 2002. Recovery of dairy manure nutrients by benthic freshwater algae. *Bioresour. Technol.* 84, 81–91.
- Xiong, W., Li, X., Xiang, J., Wu, Q., 2008. High-density fermentation of microalga *Chlorella protothecoides* in bioreactor for microbio-diesel production. *Appl. Microbiol. Biotechnol.* 78, 29–36.

- Xu, H., Miao, X., Wu, Q., 2006. High quality biodiesel production from a microalga *Chlorella protothecoides* by heterotrophic growth in fermenters. *J. Biotechnol.* 126, 499–507.
- Yang, C., Hua, Q., Shimizu, K., 2000. Energetics and carbon metabolism during growth of microalgal cells under photoautotrophic, mixotrophic and cyclic light-autotrophic/dark-heterotrophic conditions. *Biochem. Eng. J.* 6, 87–102.
- Yoo, C., Jun, S.Y., Lee, J.Y., Ahn, C.Y., Oh, H.M., 2010. Selection of microalgae for lipid production under high level of carbon dioxide. *Bioresour. Technol.* 101, 71–74.
- Zhang, K., Kurano, N., Miyachi, S., 2002. Optimized aeration by carbon dioxide gas for microalgal production and mass transfer characterization in a vertical flat-plate photobioreactor. *Bioprocess Biosyst. Eng.* 25, 97–101.
- Zhang, Y., Dub, M.A., McLean, D.D., Kates, M., 2003. Biodiesel production from waste cooking oil: 2 Economic assessment and sensitivity analysis. *Bioresour. Technol.* 90, 229–240.
- Zhang, E.D., Wang, B., Wang, Q.H., Zhang, S.B., Zhao, B.D., 2008. Ammonia-nitrogen and orthophosphate removal by immobilized *Scenedesmus sp.* isolated from municipal wastewater for potential use in tertiary treatment. *Bioresour. Technol.* 99, 3787–3793.

Intentionally left as blank

Production of Biohydrogen from Microalgae

Kuan-Yeow Show¹, Duu-Jong Lee²

¹Department of Environmental Science and Engineering, Fudan University,
Shanghai, China

²Department of Chemical Engineering, National Taiwan University, Taipei, Taiwan

9.1 INTRODUCTION

Extensive effort is being made globally to exploring renewable energy sources that could replace fossil fuels in mitigating global warming and other environmental issues. Hydrogen is a promising fuel alternative to conventional fossil fuels because it releases energy explosively without air pollutants in combustion. Most of the hydrogen in use currently is produced through thermochemical processes via electricity generation from fossil fuels. Because the current hydrogen fuel is based on the use of nonrenewable fossil-fuel resources, a major issue related to conventional hydrogen production is sustainability.

Biohydrogen production is deemed a key development in creating a sustainable energy supply and a promising alternative to fossil fuels. Hydrogen production via biological processes is carried out largely at ambient temperatures and pressures and hence is less energy intensive than chemical or electrochemical ones. As a desired green energy product of natural bioconversion, biohydrogen metabolism is primarily the domain of bacteria and microalgae. Within these groups, it involves many taxonomically diverse species, a variety of enzymes, and metabolic pathways and processes (Schulz, 1996; Vignais et al., 2001; Weaver et al., 1980). Biological processes use the enzyme hydrogenase or nitrogenase as a hydrogen-producing protein. This enzyme regulates the hydrogen metabolism of prokaryotes and some eukaryotic organisms, including green algae. The function of nitrogenase as well as hydrogenase is linked with the utilization of metabolic products of photosynthetic reactions that generate reductants from water.

Current development of algal hydrogen production is focusing on biophotolysis and photosynthesis-hydrogen production using various microbial species. Sunlight is necessary for hydrogen production by photosynthetic microorganisms. Photoautotrophic green microalgae and cyanobacteria use carbon dioxide and sunlight as the respective sole carbon and energy sources. The reducing power for cellular photosynthesis and/or biophotolysis comes from water oxidation under light irradiation (Ghirardi et al., 2000; Schütz et al., 2004). This chapter examines the perspectives and state-of-the-art of algal hydrogen research in the context of pathways of hydrogen production, bioreactor design and operation, and economic evaluation. Prospects and challenges in algal hydrogen production are also outlined.

9.2 PATHWAYS OF HYDROGEN PRODUCTION

Biohydrogen can be generated by microorganisms such as microalgae and cyanobacteria through biophotolysis and catabolism of endogenous substrate. Biophotolysis occurs due to the effect of light on the microbial systems, resulting in dissociation of water into molecular hydrogen and oxygen. The light-dependent biophotolysis metabolic pathways can be differentiated into two distinct categories: direct photolysis and indirect photolysis. Whereas electrons derived from water lead to photosynthetic hydrogen production in biophotolysis, electrons from catabolism of endogenous substrate would result in hydrogen production in a distinct mechanism.

9.2.1 Direct Photolysis

Direct photolysis involves water oxidation and a light-dependent transfer of electrons to the [Fe]-hydrogenase, leading to the photosynthetic hydrogen production. Electrons are derived from water upon the photochemical oxidation by photosystem II (PSII or water-plastoquinone oxidoreductase), which is an enzyme located in the thylakoid membrane of algae and cyanobacteria. PSII uses photons from sunlight to energize electrons that are then transferred through the thylakoid membrane electron-transport chain and, via photosystem I (PSI or ferredoxin oxidoreductase) and ferredoxin (Fd), to the hydrocarbon cluster of [Fe]-hydrogenase (Florin et al., 2001). Plastoquinone is reduced to plastoquinol from the transferred electrons, which are used to reduce NADP^+ to NADPH or are used in cyclic photophosphorylation. The energized electrons are replaced by oxidizing water to form hydrogen ions and molecular oxygen, as shown in Figure 9.1. By obtaining these electrons from water, PSII provides the electrons needed for the photosynthesis. The hydrogen ions (protons) generated by the oxidation of water help create a proton gradient that is used by ATP synthase to generate ATP. Protons are the terminal acceptors of these photosynthetically generated electrons in the algal chloroplast. The process results in the simultaneous production of oxygen and hydrogen gases (Spruit, 1958; Greenbaum et al., 1983).

Direct photolysis capitalizes on the photosynthetic capability of microalgae and cyanobacteria to split water directly into oxygen and hydrogen. Cyanobacteria, also known as blue-green algae, belong to a phylum of bacteria that obtain their energy through photosynthesis. Microalgae have evolved the ability to harness solar energy by extracting protons

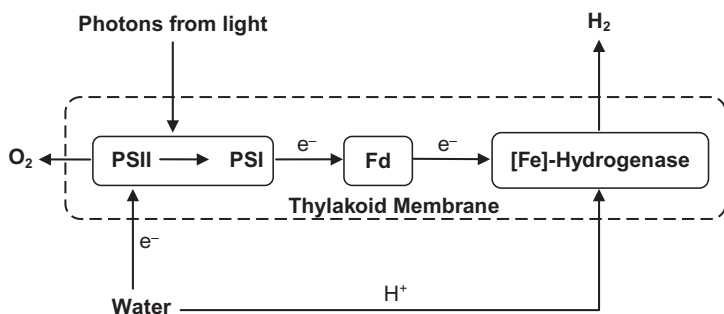

FIGURE 9.1 Simplified schematic of hydrogenase-mediated direct photolysis.

and electrons from water via water-splitting reactions. The biohydrogen production takes place via direct absorption of light and transfer of electrons to two groups of enzymes: hydrogenases and nitrogenases (Manis and Banerjee, 2008). Under anaerobic conditions or when too much energy is captured in the process, some microorganisms vent the excess electrons by using a hydrogenase enzyme that converts the hydrogen ions to hydrogen gas (Sorensen, 2005; Turner et al., 2008). It has been reported that the protons and electrons extracted via the water-splitting process are recombined by a chloroplast hydrogenase to form molecular hydrogen gas with a purity of up to 98% (Hankamer et al., 2007).

In addition to producing hydrogen, the microorganisms also produce oxygen, which in turn suppresses hydrogen production (Kovacs et al., 2006; Kapdan and Kargi, 2006). Research work has been carried out to engineer algae and bacteria so that the majority of the solar energy is diverted to hydrogen production, with bare energy diverted to carbohydrate production to solely maintain cells. Researchers are attempting to either identify or engineer less oxygen-sensitive microorganisms, isolate the hydrogen and oxygen cycles, or change the ratio of photosynthesis to respiration to prevent oxygen buildup (U.S. DOE, 2007). Addition of sulfate has been found to suppress oxygen production. However, the hydrogen production mechanisms are also inhibited (Sorensen, 2005; Turner et al., 2008).

The merit of direct photolysis is that the principal feed is water and the driver energy is derived from sunlight, both of which are readily available. Although this technology has significant promise, it is also facing tremendous challenges. A major challenge is the incompatibility in the simultaneous molecular hydrogen and oxygen production. Photosynthetic hydrogen can only be produced transiently, since oxygen is a strong suppressor of hydrogenate reactions and a powerful inhibitor of the [Fe]-hydrogenase. In addition, the photolysis process requires a significant algae cultivation area to collect sufficient light. Another challenge is achieving continuous hydrogen production under aerobic conditions (U.S. DOE, 2007).

9.2.2 Indirect Photolysis

Other than direct photolysis, photosynthetic hydrogen can be produced through the use of green algae that can directly produce hydrogen under the condition of sulfur deprivation (Manis and Banerjee, 2008). Deprivation of sulfur nutrients in the growth medium causes a reversible inhibition in the activity of oxygenic photosynthesis in green algae

(Melis et al., 2000). Protein biosynthesis is impeded in the absence of sulfur, and the green algae are unable to perform the required turnover of the D1/32-kD reaction center protein of PSII (known as the *psbA chloroplast gene product*) in the thylakoid membrane of algae (Wykoff et al., 1998). Under sulfur deprivation, the photochemical activity of PSII declines, and the absolute activity of photosynthesis becomes less than that of respiration. As a result, the rates of photosynthetic oxygen evolution drop below those of oxygen consumption by respiration (Melis et al., 2000). Such imbalance in the photosynthesis–respiration relationship by sulfur deprivation resulted in net consumption of oxygen by the cells, causing anaerobic conditions in the growth medium. Consequently, an anaerobic condition prevails in the sealed light-dependent algal cultures. With energy derived from light under deprivation of sulfur, the anaerobic algal cultures would elicit the [Fe]-hydrogenase pathway of electron transport in the chloroplast to photosynthetically produce hydrogen (Melis, 2002).

In essence, hydrogen can be produced under sulfur deprivation by circumventing the sensitivity of the [Fe]-hydrogenase to molecular oxygen through a temporal separation of the reactions of oxygen and hydrogen photoproduction. In the course of such a hydrogen production condition (sulfur-deprivation), algal cells consumed significant amounts of internal starch and protein (Zhang et al., 2002). Such catabolic reactions apparently indirectly sustain the hydrogen production process.

Hydrogen production via indirect photolysis by algae is deemed feasible if photon conversion efficiency can be improved for large-scale applications. Algal bioreactors can provide an engineering approach to regulate light inputs to the culture to improve the photon conversion efficiency of algal cell. The improvement of photosynthesis efficiency is too difficult to achieve for conventional crop plants (Hankamer et al., 2007). Recent research has reported a substantial increase in light utilization efficiency of up to 15%, compared with the previous utilization of around 5% (Tetali et al., 2007; Laurinavichene et al., 2008). Some researchers claimed that efficiency between 10% and 13% is attainable by engineering the microorganisms to better utilize the solar energy (Turner et al., 2008). However, improvements must be made to optimize the solar conversion efficiency of the algae under mass culture conditions. Optical shortcomings associated with the chlorophyll antenna size and the light-saturation drawback of photosynthesis need to be addressed before high photosynthetic solar conversion efficiencies in mass culture can be achieved (Melis et al., 1999). Additional challenges that must be tackled include finding ways to recycle photobioreactor components and minimize the chemical cost of the nutrients to support algal growth, since these two items constitute 80–85% of the overall cost of commercial hydrogen production (Melis, 2002).

Photoproduction of hydrogen at a rate of about 12.5 ml H₂/h per gram cell dry weight was reported in a study on indirect biophotolysis with *cyanobacterium anabaena variabilis* (Markov et al., 1997). In another study on indirect biophotolysis with *cyanobacterium gloeocapsa alpicola*, it was found that maintaining the culture at pH value between 6.8 and 8.3 yielded optimal hydrogen production (Troshina et al., 2002). Increasing the temperature from 30°C to 40°C resulted in twofold increase in the hydrogen production. The hydrogen production rate through indirect biophotolysis is comparable to hydrogenase-based hydrogen production by green algae.

Currently, less than 10% of the algae photosynthetic capacity was utilized for biohydrogen production. Research is underway to further improve algal photosynthetic capacity using a molecular engineering approach. Mutant algae with less chlorophyll could be manipulated

for large-scale commercial applications that disperse more light to deeper algae layers in the bioreactor (Hankamer et al., 2007; Beer et al., 2009). Hence, sunlight is made available for more algal cells to generate hydrogen, thus improving the production rate. With technology advancement, biohydrogen production via algae bioreactors will offer a sustainable alternative energy resource in future.

9.2.3 Endogenous Substrate Catabolism

It has been established that electrons are derived from water upon photochemical oxidation by PSII or so-called water plastoquinone oxidoreductase (PQOR) and are transferred to the [Fe]-hydrogenase, leading to the photosynthetic hydrogen production in the direct photolysis process. Apart from the previously described PSII-dependent hydrogen production, catabolism of endogenous substrate and the associated oxidative carbon metabolism in green algae may generate electrons for the photosynthetic systems (Gfeller and Gibbs, 1984; Melis, 2002).

Electrons generated from such an endogenous substrate catabolism flow into the PQ pool between photosystems PSI and PSII (Stuart and GaDron, 1972; Godde and Trebst, 1980). An NADPH-PQOR that has been ascertained in vascular plant chloroplasts supplies electrons to the PQ pool (Shinozaki et al., 1986; Kubicki et al., 1996; Neyland and Urbatsch, 1996; Endo et al., 1998; Field et al., 1998; Sazanov et al., 1998). Daylight assimilation by PSI and the associated electron transfer raise the redox potential of these electrons to the equivalent level of ferredoxin and the [Fe]-hydrogenase. Functioning as the terminal electron acceptor, the hydrogen ions (protons) would lead to the production of molecular hydrogen (Gfeller and Gibbs, 1984; Bennoun, 2001; Gibbs et al., 1986). It has been found that in the presence of the PSII inhibitors 3-(3,4-dichlorophenyl)-1,1-dimethylurea (DCMU), which impede photosynthetic electron flow from PSII to the PQ pool, the process generates molecular hydrogen and carbon dioxide in a stoichiometric ratio of 2 to 1 (Bamberger et al., 1982). Thus, following a dark incubation of the culture under anaerobic conditions and the ensuing induction of the [Fe]-hydrogenase, considerable rates of hydrogen generation can be captured upon illumination of the algae in the presence of DCMU (Happe et al., 1994; Florin et al., 2001).

9.2.4 Dark Fermentation

Dark or heterotrophic fermentation by anaerobes as well as some microalgae, such as green algae on carbohydrate-rich substrates, can produce hydrogen in an anaerobic environment without the need of light energy (Zhang et al., 2006; 2007a, b, c; 2008a, b, c, d; Show et al., 2007; 2010; Lee et al., 2011). The possibility with dark fermentative hydrogen production from algal biomass remains that hydrogen was produced by heterotrophic bacterial satellites present in the algal biomass slurries (Carver et al., 2011; Lakaniemi et al., 2011). It has been well established that methane is generated in conventional anaerobic fermentation in two distinct stages: acidification and methane production. Each stage is carried out by specific microorganisms through syntrophic interactions. Hydrogen is produced in the first-stage

acidogenesis as an intermediate metabolite, which in turn is used as an electron donor by methanogens at the second-stage methanogenesis.

Formation of molecular hydrogen in dark fermentation is generally accomplished through two pathways in the presence of specific coenzymes (Show et al., 2011). One pathway is by a formic acid decomposition route; the other pathway is the reoxidation of nicotinamide adenine dinucleotide (NADH) route represented by $\text{NADH} + \text{H}^+ + 2\text{Fd}^{2+} \rightarrow 2\text{H}^+ + \text{NAD}^+ + 2\text{Fd}^+$ and $2\text{Fd}^{2+} + 2\text{H}^+ \rightarrow 2\text{Fd}^+ + \text{H}_2$ under the mediation of hydrogenase. The Embden-Meyerhof, or glycolytic, pathway is undoubtedly the most common route for glucose degradation to pyruvate, which functions in the presence or absence of oxygen (Prescott et al., 2002). In this pathway, glucose is converted into pyruvate associated with the conversion of NADH from NAD^+ via anaerobic glycolysis represented by $\text{C}_6\text{H}_{12}\text{O}_6 + 2\text{NAD}^+ \rightarrow 2\text{CH}_3\text{COCOOH} + 2\text{NADH} + 2\text{H}^+$. Electron transfer via pyruvate-ferredoxin oxidoreductase or NADH-ferredoxin oxidoreductase and hydrogenase could be affected by the corresponding NADH and acetyl-CoA levels or prevailing environmental conditions. Thus, the oxidation-reduction state has to be balanced through the NADH utilization to form several reduced compounds, i.e., lactate, ethanol, and butanol, resulting in a lowered hydrogen yield.

Theoretically, it is possible to harvest hydrogen at the acidogenesis stage of anaerobic fermentation if only acidogens are left to produce hydrogen gas and other metabolites and the final methanogenesis stage and other hydrogen-consuming biochemical reactions are inhibited during the dark fermentation. However, inhibition of hydrogen-consuming microorganisms in complex microbial consortia decomposing algal biomass for hydrogen production poses a challenging task. It has been reported that the hydrogen produced from green algae *C. vulgaris* and *D. tertiolecta* biomass by anaerobic enriched cultures containing BESA was subsequently consumed by nonmethanogenic microorganisms (Lakaniemi et al., 2011). Similar hydrogen utilization was also reported from the work on hydrogen production by anaerobic sludge fed with lipid-extracted *Scenedesmus* algal biomass (Yang et al., 2010).

During the dark fermentation, carbohydrates are converted into hydrogen gas and volatile fatty acids and alcohols, which are organic pollutants and energy carriers. For the purpose of energy production and protection of the water bodies, a second-stage process is necessary to recover the energy residues remaining in the effluent in the form of fatty acids and alcohols. Thus the fermentative reactor becomes part of a process wherein the effluent post-treatment process and hydrogen utilization should also be included. A possible second-stage process is photofermentation, anaerobic digestion, or microbial fuel cells, which have been assessed in a recent review (Show et al., 2012).

For hydrogen produced from dark fermentation to be used alone in an internal combustion engine or a fuel cell, some issues such as biohydrogen purification, storage, and transport are to be addressed. Unlike a biophotolysis process that produces only hydrogen, the gaseous product of dark fermentation is a mixture of primary hydrogen (generally less than 70%) and CO_2 but may also contain other gases such as CH_4 , H_2S , ammonia, and/or moisture. Purification of the hydrogen is essential before the hydrogen utilization can be practical (Show et al., 2011; 2012). Nevertheless, hydrogen production by dark fermentation is an attractive process in the sense that it does not demand large land space and is not affected by weather conditions (solar radiation is not a requirement). Also, among the biohydrogen production processes, dark fermentation is deemed to be more favorable. Hydrogen is yielded at a high

rate, and various organic compounds and wastewaters are enriched with carbohydrates as the substrate results in low-cost hydrogen production (Hallenbeck and Ghosh, 2009). Hence, the feasibility of the technology yields a growing commercial value.

9.3 BIOREACTOR DESIGN AND OPERATION

Open-pond culture systems and enclosed bioreactor facilities have been used commercially in the recently evolved alga biomass biotechnology, but bioreactor design in algal hydrogen production is still in the research and development stage. Because biohydrogen metabolism is primarily the domain of microalgae, diatoms, or cyanobacteria, the design of a photobioreactor depends on microbiological processes associated with bacteria and microalgae (Show et al., 2008; 2011; 2012). Although these photoheterotrophic bacteria differ in photochemical efficiency, absorption coefficient, and size, the light regime, including light and dark cycles, is assumed to be much more determining than biological factors (Akkerman et al., 2003). Hence the productivity of a photobioreactor is light-dependent, and a large surface-to-volume ratio is a prerequisite for a productive photobioreactor for optimal light exposure of the algae. Provisions for thermal control and monitoring of factors, including flow rates, pH, and dissolved oxygen, sulfur, and hydrogen are essential. Technical development is now moving toward devising gas-tight systems, engineered microalgae culturing, and computer-controlled systems for monitoring and automatic nutrient delivery and culture dilution.

Photobioreactors have been designed to achieve an economical, rapid multiplication and high algal biomass density ($>10^{12}$ cells per cubic meter of culture) (Evens et al., 2000). Various photobioreactor designs, including flat plate, tubular, pond, and pool type, have been investigated (Akkerman et al., 2003). The photobioreactor process, whether of batch or continuous flow, should be designed for optimal light exposure to the algae. Sufficient light supply is vital for adequate biomass growth in achieving high-density culture and for photosynthetic generation of hydrogen. Light conversion efficiencies are low (limited to 10% theoretically) and tend to decrease at higher light intensities because of the light saturation effect (Akkerman et al., 2003). The reason for this inefficiency is that, at high solar intensities, the rate of photon absorption by the chlorophyll antenna of the upper layers of algal biomass far exceeds the rate at which photosynthesis can consume. This phenomenon is attributable to the fact that algae have an intrinsic tendency to accumulate a large assembly of photon-absorbing chlorophyll antenna molecules as a survival strategy. The overabsorption of light by the chlorophyll antenna results in loss of excess photon as heat or other rays. Moreover, cells at the upper layers of the algal mass are subject to severe photoinhibition of photosynthesis due to the high rate of photon absorption (Baroli and Melis, 1996; Melis, 1999).

Research is underway in improving further algal photosynthetic capacity using a molecular engineering approach, whereas algal strains have been manipulated to increase hydrogen production (Hankamer et al., 2007; Beer et al., 2009). It has been reported that a truncated chlorophyll antenna size of the photosystems in the chloroplast of the microalgae could alleviate the optical shortcomings associated with a fully pigmented chlorophyll antenna (Melis et al., 1999; Neidhardt et al., 1998). The work on the truncated chlorophyll antenna size in maximizing solar conversion efficiencies is delineated in Section 9.5. Mutant algae with less

chlorophyll were cultured and are able to distribute more sunlight to deeper layers in the algal biomass for large-scale applications (Hankamer et al., 2007). In this manner, sunlight is made available for more algal cells to generate hydrogen. Hence, for efficient photoproduction of hydrogen, it is critical to dilute the light and distribute it over the entire reactor volume and to mix the culture at high rates so that cells are exposed to the light for only a short time.

Algal photobioreactors can be designed to regulate light inputs to the algal culture to improve its photon conversion efficiency. A substantial increase in light utilization efficiency of up to 15% has been reported (Tetali et al., 2007; Laurinavichene et al., 2008). Conversion efficiency between 10% and 13% is feasible using engineered microbial culture to better utilize the solar energy (Turner et al., 2008). However, improvements must be made to the solar conversion efficiency of the algae for commercial purposes. Critical issues such as the optical shortcomings associated with the chlorophyll antenna size and the light saturation of photosynthesis must be addressed under mass culture conditions (Melis et al., 1999). Technological advancement addressing these issues is discussed in Section 9.5.

Appropriate configuration of the bioreactor needs to be established for the most effective use of light and surface area. Biomass mixing is hence significant to ensure uniform dispersion of nutrients and light illumination in the culture as well as to prevent agglomeration and sedimentation of algal biomass (Melis, 2002). Modular design of experimental systems should be allowed for possible scale-up. Such commercial scale should achieve sustainable gas output and high hydrogen yields with compact configuration. Trapping and withdrawal of hydrogen gas in the system are also important design considerations for photobioreactors. Given the current advancement in photobiohydrogen production, technical and economic strategies for cycling the microalgae between sulfur deprivation and supply must be developed (Laurinavichene et al., 2008).

Various types of photobioreactors had been investigated in a study by Janssen (2002). Small-scale flat panel reactors consisting of a rectangular transparent box were mixed with gas introduced via a perforated tube at the bottom of the reactor. To create a high degree of turbulence, 3 to 4 liters of air per liter of reactor volume per minute must be provided. The panels were illuminated from one side by direct sunlight, and the panels are placed vertically or inclined toward the sun. Light/dark cycles were short in flat panel reactors, and this is probably the key factor leading to high photochemical efficiency. A disadvantage of flat panel reactors systems is that the power consumption of aeration (or mixing with another gas) is high, although mixing is always necessary in any reactor. The large-scale flat plate reactor consists of a rectangular airlift photobioreactor with a large number of light-redistributing plates fixed a few centimeters from each other. Mixing was provided by air injected between adjacent plates, and the culture liquid rises in between.

Tubular photobioreactors consist of long transparent tubes with diameters ranging from 3 to 6 cm and lengths ranging from 10 to 100 m (Janssen, 2002). The culture liquid is pumped through these tubes by means of mechanical or airlift pumps. The tubes can be positioned in many different ways: in a horizontal plane as straight tubes with a small or large number of U-bends; vertical, coiled as a cylinder or a cone; in a vertical plane, positioned in a fence-like structure using U-bends or connected by manifolds; or horizontal or inclined, parallel tubes connected by manifolds. In addition, horizontal tubes can be placed on different reflective surfaces with a certain distance between the tubes. Although tubular reactor design is rather

diverse, the predominant effect of the specific designs on the light regime is a difference in the photon flux density incident on the reactor surface. The shape of the light gradient in the tubes is similar in most designs. Also with respect to liquid mixing, the circumstances in most designs are similar. The length of the tubes is limited because of accumulation of gas, though this might not be so important for nitrogenase-based processes, since they may be less inhibited by hydrogen. The way to scale up is to connect a number of tubes via manifolds. Flat panel reactors normally show a high photochemical efficiency or biomass yield on light energy, while biomass density is also high. Tubular bioreactors in theory should show better efficiencies because of the shorter average light/dark cycles.

Although much of the research has been focused on single-stage photobioreactor systems, multistage bioreactors entailing three or even four bioreactors in biohydrogen production have also been examined (see [Figure 9.2](#)) ([U.S. DOE, 2007](#); [Wang et al., 2011](#); [Show et al., 2011](#)). Sunlight is first filtered through first-stage direct photolysis, in which visible light is utilized by blue-green algae, and the unfiltered infrared ray is used by photosynthetic microbes in the second-stage photofermentative reactor. The effluent from the second-stage photofermentation, together with the biomass feedstock, is fed into a third-stage dark fermentation reactor, where the microorganisms convert the substrate into hydrogen and organic acids. As the effluent is enriched with organic acids, a supply of external organic acids for the photofermentative process can be eliminated. The fourth stage involves the use of a microbial electrolysis cell to convert the organic acids generated from the dark fermentation into hydrogen in a light-independent process. This stage thus can be operated during the night or in low-light conditions.

The increasing attention on hythane has led to research interest in hydrogen production by dark fermentation of biomass in hybrid or multistage bioreactors. Hythane, a mixture of hydrogen and methane, is a highly efficient and ultraclean-burning alternative fuel that is probably the most promising biogas for industrial applications ([Cavinato et al., 2009](#)). However, there are issues to be addressed before multistage bioreactors can be put to practical applications. Integration of multiple biochemical conversion processes poses significant challenges for multistage reactor engineering, system design, process control, operation, and maintenance. Major challenges with the simultaneous production of hydrogen and oxygen from photolytic hydrogen production include respiration-to-photosynthetic-capacity ratio, co-culture balance, and concentration and processing of cell biomass ([Holladay et al., 2009](#)).

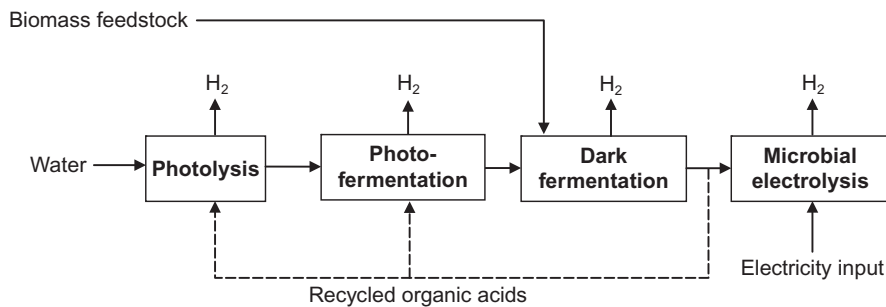

FIGURE 9.2 A multistage hydrogen production bioreactor system. Adapted from [U.S. DOE 2007](#) and [Show et al., 2012](#).

9.4 ECONOMIC EVALUATION

The costs of an algal hydrogen production facility and its operation are important factors to be considered for practical large-scale applications. Detailed cost analyses must be conducted on minimizing the materials and operating costs as well as optimizing the yield and gas collection. Although there are many reports in the literature about biohydrogen production, only a handful of them deal with economic analyses of biohydrogen production. Critical parameters in the cost analyses include the light environment, the climate and land space, reactor construction materials, the mechanism of culture mixing, reactor maintenance, and long-term operational stability with maximal gas production (Melis, 2002).

Benemann (1997) estimated an initial cost for an indirect algal biophotolysis system consisting of open ponds (140 ha) and photobioreactors (14 ha). The plant was assumed to generate 1.2 million GJ per year at 90% plant capacity, with estimated total capital costs for the system at US\$43 million and annual operating costs at US\$12 million. Overall total hydrogen production costs were estimated at US\$10/GJ. The capital costs were almost 90% of total costs at a 25% annual capital charge (Akkerman et al., 2003). The algal ponds were estimated at a cost of US\$6 per square meter (sq m), whereas the photobioreactors, with assumed costs of US\$100 per sq m, were the major capital and operating cost factors. The costs of gas handling were not estimated but were presumed a significant cost factor.

An initial cost for a large-scale (>100 ha) single-stage algal or cyanobacterial biophotolysis process in a near-horizontal tubular reactor system was analyzed (Tredici and Zittelli, 1998). The main objective of the analysis was to determine whether the proposed photobioreactor design could meet the cost requirements for hydrogen production through single-stage biophotolysis. The tubular photobioreactor offers superior features for biohydrogen production due to the internal gas exchange and the effective water-spray cooling. Based on 10% solar energy conversion efficiency, the costs of the tubular photobioreactor were estimated at US\$50 per sq m. The analysis did not include costs for gas handling and assumed a relatively low annual capital charge at 17%. The capital fixed costs were estimated at 80% of total costs, with the tubular material for the photobioreactor the major cost. The hydrogen production costs were estimated at US\$15/GJ, which are comparable to the costs projected for hydrogen produced in a two-stage process from biomass residues projected at €19/GJ (Tredici and Zittelli, 1998).

An estimated 80 kilograms of hydrogen can be produced commercially per acre of cultivation area per day, assuming that the entire capacity of the photosynthesis of the algae could be diverted toward hydrogen production (Melis and Happe, 2001). Based on a realistic 50% capacity, the cost of producing hydrogen comes close to US\$2.80 a kilogram. The authors maintained that the biohydrogen thus generated could compete with gasoline at this price, assuming one kilogram of hydrogen is equivalent to a gallon of gasoline. Currently, less than 10% of algae photosynthetic capacity is utilized for biohydrogen production.

A scale-up modular pilot photobioreactor was operated on site over a six-month period for assessment of economic and reactor performance (Melis, 2002). From the distribution among the various cost inventories derived from the field operation, the costs of materials and nutrients turned out to be the major expenses (84%). A construction cost of US\$0.75 per sq m was

established, which was considerably lower than the range of US\$20–100 per sq m commonly quoted (Zaborsky, 1998). Although the economic analysis probably reflects a simplified, strip-down, bare design, it does provide an indication of the relative cost of the various components such as materials, nutrients, labor, water use, land lease, power, and others that are necessary and sufficient to assemble a commercially viable photobioreactor. The analysis also indicated that, to substantially lower the cost of the overall operation, effort should be directed toward the recycling and reuse of photobioreactor construction materials and growth nutrients.

These economic analyses indicated that photobiohydrogens could be produced at a cost between US\$10 and US\$20 per GJ (Akkerman et al., 2003). This is a reasonable maximal cost target for renewable hydrogen fuel, according to Benemann (2000). It should be noted that the economic analyses were based on optimistic assumptions and are highly presumptive and were intended predominantly to ascertain the major cost drivers for photobiological hydrogen production. At present, biologically produced hydrogen is more costly than other fuel alternatives. Before economic barriers can be meaningfully addressed, many technical and engineering challenges have to be tackled. Nevertheless, these economic analyses provide an indicator that the development of low-cost photobioreactors and the optimization of photosynthetic efficiency are the major R&D challenges.

9.5 PROSPECTS AND CHALLENGES

Given the delicate oxygen-sensitive hydrogenase and the prevailing oxidative environmental conditions, questions have been asked as to whether algal hydrogen production via direct photolysis can ever be utilized to generate hydrogen for practical applications. A practical approach to overcome the oxygen sensitivity of hydrogenases needs to be developed to motivate research on applied algal hydrogen production systems. To this end, it is critical to develop novel methods to separate oxygen from the biochemical activities, thus enabling hydrogen production for extended periods. Advancement in molecular bioengineering also indicates that genetic engineering might offer a feasible approach to developing oxygen-tolerant algal mutant.

Although indirect photolysis hydrogen production technology has significant promise, some crucial challenges are to be addressed. Given that hydrogen production by sulfur deprivation is time limited, a major challenge is to maintain stable hydrogen production for practical uses. Hydrogenase is too oxygen-labile for sustainable hydrogen production. Light-dependent hydrogen production ceases within a few days, since photosynthetically produced oxygen inhibits or inactivates hydrogenases. Substantial rates of hydrogen production were steadily sustained initially for about 60 h in the light, but the yield begins to level off gradually thereafter (Zhang et al., 2002). After about 100 h of sulfur deprivation, the algae need to go back to normal photosynthesis in order to be rejuvenated by replenishing endogenous substrate (Ghirardi et al., 2000). Improvements must be made to maintain the process continuity for commercial applications.

Although it has been established that hydrogen can be produced from endogenous substrate catabolism, the mechanisms this entails are yet fully understood. Rates of water oxidation by the photosynthetic systems can be determined precisely, but the electron transport

by endogenous substrate catabolism and NADPH-PQOR activity are hard to measure (Melis, 2002). Research on hydrogen production from anaerobically incubated and DCMU-inhibited chloroplasts suggests that sizable rates of hydrogen production can be detected only in the initial incubation period (Florin et al., 2001). In other words, hydrogen production via endogenous substrate catabolism is not a sustainable process (Zhang et al., 2002). This observation may suggest a limitation in the capacity of the electron transport and the attendant NADPH-PQOR activity. Nevertheless, the prospect of hydrogen production with endogenous substrate catabolism is important and should warrant further research to fully tap its potential. Application of molecular bioengineering might help increase the capacity of this important process.

Low hydrogen yield and production rate are two major challenges for practical application of biohydrogen production. Genetic manipulation or modification of the hydrogen-producing microorganisms probably will play a vital role in tackling the problem of low yields (Beer et al., 2009). In a recent development, metabolic engineering has received increasing attention in improving biohydrogen production. Improvements in hydrogen yields by existing pathways have been attempted by increasing the flux through gene knockouts of competing pathways or increased homologous expression of enzymes involved in the hydrogen-generating pathways (Hallenbeck and Ghosh, 2009).

Several algal strains related to biohydrogen production have been isolated and manipulated; for example, *C. reinhardtii* strain can increase hydrogen production under high starch conditions (Hankamer et al., 2007). Mutant algae with less chlorophyll were manipulated for large-scale commercial applications that allow more sunlight penetrating into deeper algae layers beneath the water surface in the bioreactor. Hence, sunlight is made available for more algal cells to generate hydrogen, thus improving the production rate. Whereas metabolic flux analysis has been used to guide *a priori* most suitable genetic modifications oriented to a hydrogen yield increase for a fermentative hydrogen production process (Show et al., 2012), the flux balance analysis may also offer a useful tool to provide valuable information for optimization and design of the photosynthetic hydrogen production process.

It has been reported that a truncated chlorophyll antenna size of the photosystems in the chloroplast of the microalgae could alleviate the optical shortcomings and light-saturation effect associated with a fully pigmented chlorophyll antenna (Melis, 2002). With the genetically manipulated algal cells, the drawback of overabsorption of photons by the photosystems can be minimized. A truncated chlorophyll antenna will reduce the loss of energy by the cells, and it will also dampen down photoinhibition of photosynthesis at the surface of the culture. Moreover, a truncated chlorophyll antenna size will alleviate the problem of light attenuation and mutual cell shading by permitting a more consistent illumination to the entire algal biomass. Such altered optical properties of the cells would result in much greater photosynthetic productivity and better solar utilization efficiency in the culture.

Experiments have shown that a smaller chlorophyll antenna size would bring about a higher light intensity for the saturation of photosynthesis in individual algal cells but with an associated threefold improved productivity of the culture (Neidhardt et al., 1998; Melis et al., 1999; Nakajima and Ueda, 1999). Excitation pressure was used as a bioengineering tool in the work to culture green algae with a truncated chlorophyll antenna size. The studies concluded that green algae with a truncated chlorophyll antenna size are essential in augmenting photosynthetic efficiencies and the hydrogen yield under mass culture

conditions. Manipulation of the chlorophyll antenna size in response to light is essentially an inherent reaction of the chloroplasts, since they are inversely related to the incident light. In principle, it is possible to genetically manipulate the relevant regulatory mechanism in the photosystems and, in transforming green algae, to direct the chloroplast biosynthetic and assembly activities toward a permanently truncated chlorophyll antenna size (Melis, 2002).

At this moment, the acceptability of genetically modified microorganisms is another challenge, due to the possible risk of horizontal transference of genetic material. However, this can be ruled out by chromosomal integration and the elimination of plasmids containing antibiotic markers with available molecular tools (Datsenko and Wanner, 2000). Moreover, the improvement of hydrogen production by gene manipulation is mainly focused on the disruption of endogenous genes and not introducing new activities in the microorganisms.

Hydrogen production from water photolysis has the potential to be the cleanest and most direct energy conversion process. Direct biophotolysis, albeit limited by its low hydrogen production, provides a feasible scheme for hydrogen production from water and sunlight. Technology advancement and innovations in enzymes, electron carriers, biomaterials, and genetic engineering may lead to a practical water photolysis system that overcomes the intrinsic oxygen inhibition shortcoming. Hydrogen production via indirect biophotolysis remains far behind the productivity rates of other biofuels. The low energy productivity of biohydrogen can be improved if the energy stored in fermentative products, such as acetic acid, is reused. Mutant algae could be cultured to produce the maximum amount of hydrogen from endogenous carbohydrates via dark fermentation, and then use the residual acetate for accumulation of endogenous carbon reserve in photosynthesis. Alternatively, a microbial electrolysis cell can be incorporated into the system (Figure 9.2) to convert the organic acids generated from the dark fermentation into hydrogen under light-independent process. The hydrogen yield and productivity rate can therefore be significantly improved to make highly compact energy generators for a future hydrogen economy.

In essence, the future of algal hydrogen production depends not only on research advances such as improvement in efficiency through genetically engineering microorganisms and/or the development of bioreactors but also on economic considerations, social acceptance, and the development of hydrogen energy systems.

9.6 CONCLUSIONS

Biohydrogen is believed to be one of the biofuels of the future, combining its ability to potentially reduce our dependence on fossil fuels and to contribute to lowering greenhouse gas emissions from the energy and transportation sectors. The future role of hydrogen as a clean fuel for fuel cells producing near-zero emissions and as an intermediate energy carrier for storage and transport of renewable energy is increasingly recognized worldwide. The role of biohydrogen in a future hydrogen economy, however, remains to be seen. Nevertheless, it is clear that the advent of hydrogen as a renewable energy source will have important economic implications, provided that scientific and technological challenges are overcome. The R&D in the field of algal hydrogen production will therefore be intensified.

References

- Akkerman, I., Janssen, M., Rocha, J.M.S., Reith, J.H., Wijffels, R.H., 2003. Photobiological hydrogen production: Photochemical efficiency and bioreactor design. In: Reith, J.H., Wijffels, R.H., Barten, H. (Eds.), *Biomethane and Biohydrogen: Status and Perspectives of Biological Methane and Hydrogen Production*. Dutch Biological Hydrogen Foundation, Hague, The Netherlands.
- Bamberger, E.S., King, D., Erbes, D.L., Gibbs, M., 1982. H₂ and CO₂ evolution by anaerobically adapted *Chlamydomonas reinhardtii* F60. *Plant Physiol.* 69, 1268–1273.
- Baroli, I., Melis, A., 1996. Photoinhibition and repair in *Dunaliella salina* acclimated to different growth irradiances. *Planta* 198, 640–646.
- Beer, L.L., Boyd, E.S., Peters, J.W., Posewitz, M.C., 2009. Engineering algae for biohydrogen and biofuel production. *Curr. Opin. Biotechnol.* 20, 264–271.
- Benemann, J.R., 1997. Feasibility analysis of photobiological hydrogen production. *Int. J. Hydrogen Energy* 22 (10–11), 979–987.
- Benemann, J.R., 2000. Hydrogen production by microalgae. *J. Appl. Phycol.* 12 (3–5), 291–300.
- Bennoun, P., 2001. Chlororespiration and the process of carotenoid biosynthesis. *Biochim. Biophys. Acta* 1506, 133–142.
- Carver, S.M., Hulatt, C.J., Thomas, D.N., Tuovinen, O.H., 2011. Thermophilic, anaerobic co-digestion of microalgal biomass and cellulose for H₂ production. *Biodegradation* 22, 805–814.
- Cavinato, C., Bolzonella, D., Eusebi, A.L., Pavan, P., 2009. Bio-hythane production by thermophilic two-phase anaerobic digestion of organic fraction of municipal solid waste: preliminary results. *AIDIC Conference Series* 09, 61–66. <http://dx.doi.org/10.3303/ACOS0909008>.
- Datsenko, K.A., Wanner, B.L., 2000. One-step inactivation of chromosomal genes in *Escherichia coli* K-12 using PCR products. *Proc. Natl. Acad. Sci. U. S. A.* 97, 6640–6645.
- Endo, T., Shikanai, T., Sato, F., Asada, K., 1998. NAD(P)H dehydrogenase-dependent, antimycin A-sensitive electron donation to plastoquinone in tobacco chloroplasts. *Plant Cell Physiol.* 39, 1226–1231.
- Evens, T.J., Chapman, D.J., Robbins, R.A., D'Asaro, E.A., 2000. An analytical pat-plate photobioreactor with a spectrally attenuated light source for the incubation of phytoplankton under dynamic light regimes. *Hydrobiol* 434, 55–62.
- Field, T.S., Nedbal, L., Ort, D.R., 1998. Nonphotochemical reduction of the plastoquinone pool in sunPower leaves originates from chlororespiration. *Plant Physiol.* 116, 1209–1218.
- Florin, L., Tsokoglou, A., Happe, T., 2001. A novel type of [Fe]-hydrogenase in the green alga *Scenedesmus obliquus* is linked to the photosynthetic electron transport chain. *J. Biol. Chem.* 276, 6125–6132.
- Gfeller, R.P., Gibbs, M., 1984. Fermentative metabolism of *Chlamydomonas reinhardtii* I Analysis of fermentative products from starch in dark-light. *Plant Physiol.* 75, 212–218.
- Ghirardi, M.L., Zhang, L., Lee, J.W., Flynn, T., Seibert, M., Greenbaum, E., et al., 2000. Microalgae: A green source of renewable hydrogen. *Trends Biotechnol.* 18, 506–511.
- Gibbs, M., Gfeller, R.P., Chen, C., 1986. Fermentative metabolism of *Chlamydomonas reinhardtii* III. Photo-assimilation of acetate. *Plant Physiol.* 82, 160–166.
- Godde, D., Trebst, A., 1980. NADH as electron donor for the photosynthetic membrane of *Chlamydomonas reinhardtii*. *Arch. Microbiol.* 127, 245–252.
- Greenbaum, E., Guillard, R.R.L., Sunda, W.G., 1983. Hydrogen and oxygen photoproduction by marine algae. *Photochem. Photobiol.* 37, 649–655.
- Hallenbeck, P.C., Ghosh, D., 2009. Advances in fermentative biohydrogen production: The way forward? *Trends Biotechnol.* 27, 287–297.
- Hankamer, B., Lehr, F., Rupprecht, J., Mussgnug, J., Posten, C., Kruse, O., 2007. Photosynthetic biomass and H₂ production by green algae: from bioengineering to bioreactor scale-up. *Physiol. Plant* 131, 10–21.
- Happe, T., Mosler, B., Naber, J.D., 1994. Induction, localization and metal content of hydrogenase in the green alga *Chlamydomonas reinhardtii*. *Eur. J. Biochem.* 222, 769–774.
- Holladay, J.D., Hu, J., King, D.L., Wang, Y., 2009. An overview of hydrogen production technologies. *Catalysis Today* 139, 244–260.
- Janssen, M., 2002. Cultivation of microalgae: effect of light/dark cycles on biomass yield. Master's thesis. Wageningen University, Wageningen, The Netherlands.

- Kapdan, I.K., Kargi, F., 2006. Bio-hydrogen production from waste materials. *Enzyme Microb. Technol.* 38, 569–582.
- Kovacs, K.L., Maróti, G., Rákhely, G., 2006. A novel approach for biohydrogen production. *Int. J. Hydrogen Energy* 31, 1460–1468.
- Kubicki, A., Funk, E., Westhoff, P., Steinmuller, K., 1996. Differential expression of plastome-encoded *ndh* genes in mesophyll and bundle-sheath chloroplasts of the C-4 plant sorghum bicolor indicates that the complex I-homologous NAD(P)H-plastoquinone oxidoreductase is involved. *Planta* 199, 276–281.
- Lakaniemi, A.M., Hulatt, C.J., Thomas, D.N., Tuovinen, O.H., Puhakka, J.A., 2011. Biogenic hydrogen and methane production from *Chlorella vulgaris* and *Dunaliella tertiolecta* biomass. *Biotechnol. Biofuels* 4, 34.
- Laurinavichene, T.V., Kosourov, S.N., Ghirardi, M.L., Seibert, M., Tsygankov, A.A., 2008. Prolongation of H₂ photoproduction by immobilized, sulfur-limited *Chlamydomonas reinhardtii* cultures. *J. Biotechnol.* 134, 275–277.
- Lee, D.J., Show, K.Y., Su, A., 2011. Dark fermentation on biohydrogen production: pure culture. *Bioresour. Technol.* 102 (18), 8393–8402.
- Manis, S., Banerjee, R., 2008. Comparison of biohydrogen production processes. *Int. J. Hydrogen Energy* 33, 279–286.
- Markov, S.A., Thomas, A.D., Bazin, M.J., Hall, D.O., 1997. Photoproduction of hydrogen by Cyanobacteria under partial vacuum in batch culture or in a photobioreactor. *Int. J. Hydrogen Energy* 22, 521.
- Melis, A., 1999. Photosystem-II damage and repair cycle in chloroplasts. What modulates the rate of photodamage in vivo? *Trends Plant Sci* 4, 130–135.
- Melis, A., 2002. Green alga hydrogen production: progress, challenges and prospects. *Int. J. Hydrogen Energy* 27, 1217–1228.
- Melis, A., Happe, T., 2001. Hydrogen production Green algae as a source of energy. *Plant Physiol.* 127, 740–748.
- Melis, A., Neidhardt, J., Benemann, J.R., 1999. *Dunaliella salina* (Chlorophyta) with small chlorophyll antenna sizes exhibit higher photosynthetic productivities and photon use efficiencies than normally pigmented cells. *J. Appl. Phycol.* 10, 515–525.
- Melis, A., Zhang, L., Forestier, M., Ghirardi, M.L., Seibert, M., 2000. Sustained photobiological hydrogen gas production upon reversible inactivation of oxygen evolution in the green alga *Chlamydomonas reinhardtii*. *Plant Physiol.* 122, 127–136.
- Nakajima, Y., Ueda, R., 1999. Improvement of microalgal photosynthetic productivity by reducing the content of light harvesting pigment. *J. Appl. Phycol.* 11, 195–201.
- Neidhardt, J., Benemann, J.R., Zhang, L., Melis, A., 1998. Photosystem-II repair and chloroplast recovery from irradiance stress: relationship between chronic photoinhibition, light-harvesting chlorophyll antenna size and photosynthetic productivity in *Dunaliella salina* (green algae). *Photosynth. Res.* 56, 175–184.
- Neyland, R., Urbatsch, L.E., 1996. The *ndhF* chloroplast gene detected in all vascular plant divisions. *Planta* 200, 273–277.
- Prescott, L.M., Klein, D.A., Harley, J.P., 2002. *Microbiology*. McGraw-Hill, NY, USA.
- Sazanov, L.A., Burrows, P.A., Nixon, P.J., 1998. The plastid *ndh* genes code for an NADH-specific dehydrogenase: isolation of a complex I analogue from pea thylakoid membranes. *Proc. Natl. Acad. Sci. U. S. A.* 95, 1319–1324.
- Schulz, R., 1996. Hydrogenases and hydrogen production in eukaryotic organisms and cyanobacteria. *J. Mar. Biotechnol.* 4, 16–22.
- Schütz, K., Happe, T., Troshina, O., Lindblad, P., Leitao, E., Oliveira, P., et al., 2004. Cyanobacterial Hydrogen production: a comparative analysis. *Planta* 218, 350–359.
- Shinozaki, K., Ohme, M., Tanaka, M., Wakasugi, T., Hayashida, N., Matsubayashi, T., et al., 1986. The complete nucleotide sequence of tobacco chloroplast genome: its gene organization and expression. *EMBO J.* 5, 2043–2049.
- Show, K.Y., Zhang, Z.P., Tay, J.H., Liang, T.D., Lee, D.J., Jiang, W.J., 2007. Production of hydrogen in a granular sludge-based anaerobic continuous stirred tank reactor. *International Journal of Hydrogen Energy* 32, 4744–4753.
- Show, K.Y., Zhang, Z., Lee, D.J., 2008. Design of bioreactors for biohydrogen production. *J. Sci. Ind. Res.* 67, 941–949.
- Show, K.Y., Zhang, Z., Tay, J.H., Liang, T., Lee, D.J., Ren, N., et al., 2010. Critical assessment of anaerobic processes for continuous biohydrogen production from organic wastewater. *Int. J. Hydrogen Energy* 35 (24), 13350–13355.

- Show, K.Y., Lee, D.J., Chang, J.S., 2011. Bioreactor and process design for biohydrogen production. *Bioresour. Technol.* 102, 8524–8533.
- Show, K.Y., Lee, D.J., Tay, J.Y., Lin, C.Y., Chang, J.S., 2012. Biohydrogen production: current perspectives and the way forward. *Int. J. Hydrogen Energy* (in press). <http://dx.doi.org/10.1016/j.ijhydene.2012.04.109>.
- Sorensen, B., 2005. *Hydrogen and Fuel Cells: Emerging Technologies and Applications*. Elsevier Academic Press, NY, USA.
- Spruit, C.P., 1958. Simultaneous photoproduction of hydrogen and oxygen by *Chlorella*. *Meded Landbouwhogeschool Wageningen* 58, 1–17.
- Stuart, T.S., GaDron, H., 1972. The mechanism of hydrogen photoproduction by several algae II. The contribution of photosystem II. *Planta* 106, 101–112.
- Tetali, S.D., Mitra, M., Melis, A., 2007. Development of the light-harvesting chlorophyll antenna in the green alga *Chlamydomonas reinhardtii* is regulated by the novel *Tla1* gene. *Planta* 225, 813–829.
- Tredici, M.R., Zittelli, G.C., 1998. Efficiency of sunlight utilization: Tubular versus flat photobioreactors. *Biotechnol. Bioeng.* 57, 187–197.
- Troshina, O., Serebryakova, L., Sheremetieva, M., Lindblad, P., 2002. Production of H₂ by the unicellular Cyanobacterium *gloeocapsa alpicola* CALU 743 during fermentation. *Int. J. Hydrogen Energy* 27, 1283.
- Turner, J., Sverdrup, G., Mann, M.K., Maness, P.C., Kroposki, B., Ghirardi, M., et al., 2008. Renewable hydrogen production. *Int. J. Energy Res.* 32, 379–407.
- U.S. Department of Energy DOE, 2007. Hydrogen, Fuel Cells and Infrastructure Technologies Program, Multi-Year Research, Development and Demonstration Plan. U.S. Department of Energy.
- Vignais, P.N., Billoud, B., Meyer, J., 2001. Classification and phylogeny of hydrogenases. *FEMS Microbiol. Rev.* 25, 455–501.
- Wang, A., Sun, D., Cao, G., Wang, H., Ren, N.Q., Wu, W.M., et al., 2011. Integrated hydrogen production process from cellulose by combining dark fermentation, microbial fuel cells, and a microbial electrolysis cell. *Bioresour. Technol.* 102, 4137–4143.
- Weaver, P.F., Lien, S., Seibert, M., 1980. Photobiological production of hydrogen. *Sol. Energy* 24, 3–45.
- Wykoff, D.D., Davies, J.P., Melis, A., Grossman, A.R., 1998. The regulation of photosynthetic electron-transport during nutrient deprivation in *Chlamydomonas reinhardtii*. *Plant Physiol.* 117, 129–139.
- Yang, Z., Guo, R., Xu, X., Fan, X., Li, X., 2010. Enhanced hydrogen production from lipid-extracted microalgal biomass residues through pretreatment. *Int. J. Hydrogen Energy* 35, 9618–9623.
- Zaborsky, O.R., 1998. *BioHydrogen*. Plenum Publishing, NY, USA.
- Zhang, L., Happe, T., Melis, A., 2002. Biochemical and morphological characterization of sulfur-deprived and H₂-producing *Chlamydomonas reinhardtii* (green alga). *Planta* 214, 552–561.
- Zhang, Z.P., Show, K.Y., Tay, J.H., Liang, D.T., Lee, D.J., Jiang, W.J., 2006. Effect of hydraulic retention time on biohydrogen production and anaerobic microbial community. *Process Biochem.* 41, 2118–2123.
- Zhang, Z.P., Tay, J.H., Show, K.Y., Yan, R., Liang, D.T., Lee, D.J., et al., 2007a. Biohydrogen production in a granular activated carbon anaerobic fluidized bed reactor. *Int. J. Hydrogen Energy* 32, 185–191.
- Zhang, Z.P., Show, K.Y., Tay, J.H., Liang, D.T., Lee, D.J., 2007b. Biohydrogen production with anaerobic fluidized bed reactors—A comparison of biofilm-based and granule-based systems. *Int. J. Hydrogen Energy* 33, 1559–1564.
- Zhang, Z.P., Show, K.Y., Tay, J.H., Liang, D.T., Lee, D.J., Jiang, W.J., 2007c. Rapid formation of hydrogen-producing granules in an anaerobic continuous stirred tank reactor induced by acid incubation. *Biotechnol. Bioeng.* 96, 1040–1050.
- Zhang, Z.P., Show, K.Y., Tay, J.H., Liang, T.D., Lee, D.J., 2008a. Enhanced continuous biohydrogen production by immobilized anaerobic microflora. *Energy and Fuels* 22, 87–92.
- Zhang, Z.P., Advan, S.S., Show, K.Y., Tay, J.H., Liang, D.T., Lee, D.J., 2008b. Characteristics of rapidly formed hydrogen-producing granules and biofilms. *Biotechnol. Bioeng.* 101, 926–936.
- Zhang, Z., Show, K.Y., Tay, J.H., Liang, T., Lee, D.J., 2008c. Biohydrogen production with anaerobic fluidized bed reactors— a comparison of biofilm-based and granule-based systems. *Int. J. Hydrogen Energy* 33, 1559–1564.
- Zhang, Z.P., Show, K.Y., Tay, J.H., Liang, T.D., Lee, D.J., Wang, J.Y., 2008d. The role of acid incubation in rapid immobilization of hydrogen-producing culture in anaerobic upflow column reactors. *Int. J. Hydrogen Energy* 33, 5151–5160.

Applications of Spent Biomass

A. Catarina Guedes¹, Helena M. Amaro^{1,2},
Isabel Sousa-Pinto^{1,3}, F. Xavier Malcata^{1,4}

¹CIIMAR/CIMAR - Interdisciplinary Centre of Marine and Environmental Research,
University of Porto, Porto, Portugal

²ICBAS - Institute of Biomedical Sciences Abel Salazar, Porto, Portugal

³Department of Biology, Faculty of Sciences, University of Porto, Porto, Portugal

⁴Department of Chemical Engineering, University of Porto, Porto, Portugal

10.1 INTRODUCTION

Over the past 50 years, the world population more than doubled. This fact, coupled with an extension of life expectancies and rising standards of living, has led to a dramatic increase in primary energy consumption, chiefly from fossil sources (Jones and Mayfield, 2012).

A suitable alternative is to produce biofuel from photosynthetic organisms, that is, higher plants, algae, and cyanobacteria, which can use sunlight and carbon dioxide to produce a variety of organic molecules, namely carbohydrates, proteins, and lipids. These biomolecules can then be used to generate biomass rich in fuel-like metabolites that can then be extracted (Yang, Guo et al., 2011; Jones and Mayfield, 2012). However, the problem remains: What to do with the spent biomass? In particular, third-generation biofuels based on micro- and macroalgae offer an excellent possibility to displace fossil fuels; it is even believed that ancestors of marine microorganisms were responsible for the formation of petroleum in the first place (Goh and Lee, 2010).

Macroalgae (or seaweeds) are multicellular organisms that take many forms and sizes. They are classified into three broad groups based on their pigmentation: brown algae (Phaeophyceae), red algae (Rhodophyta), and green algae (Chlorophyta). In contrast, microalgae are microscopic organisms, which, beyond Rhodophyta and Chlorophyta, may belong to another three specific groups of unicellular organisms: blue-green algae (Cyanobacteria), diatoms (Bacillariophyta),

and dinoflagellates (Dinophyceae). These species are commonly referred to as *phytoplankton* (Garson, 1993; Samarakoon and Jeon, 2012).

Despite looking similar to land plants, microalgae miss the lignin cross-linking in their cellulose structures because their growth in aquatic environments does not require strong supports (John, Anisha et al., 2011). On the other hand, macroalgae contain significant amounts of sugars (at least 50%) suitable for fermentation (Wi, Kim et al., 2009). In certain marine algae (e.g., red algae), the carbohydrate content is strongly influenced by the presence of agar, a polymer of galactose and galactopyranose. Recent research has attempted to develop methods of saccharification to release galactose from agar and to release glucose from cellulose so as to increase fermentation yields in terms of bioethanol (Jones and Mayfield, 2012). Other studies have shown that red algae such as *Gelidium amansii* and brown algae such as *Saccharina japonica* are both potential sources of biohydrogen via anaerobic fermentation (Jones and Mayfield, 2012). Unfortunately, harmful algal blooms in lakes, ponds, and oceans may result in drastic effects on those ecosystems, so removal of those algae for biogas production is welcome (Du, Li et al., 2011).

Microalgae are ubiquitous microorganisms that are characterized by a remarkable metabolic plasticity; they may indeed be cultivated in brackish and wastewaters that provide suitable nutrients (e.g., NH_4^+ , NO_3^- , and PO_4^{3-}) at the expense of only sunlight and atmospheric carbon dioxide (CO_2). On the other hand, metabolic engineering has been taken advantage of to produce molecular hydrogen or to improve the lipid content as storage products (Amaro et al., 2011).

Overall, economic analyses have consistently indicated that algal-based biofuel feasibility hinges on the possibility of production coproducts with a market value from the spent biomass (Stephens, Ross et al., 2010). A wide range of fine chemicals may indeed be extracted from said biomass, depending on the species at stake (Raja, Hemaiswarya et al., 2008); these hold added value sufficiently high to contribute to the economic feasibility of biofuel manufacture. Such bioproducts include sugars for production of bioethanol and biomethane, both via fermentation of biomass; intermediate value products, e.g., proteins for animal feedstock; and high-value products such as active principles bearing antimicrobial, antioxidant, antitumoral, and anti-inflammatory features for pharmaceutical purposes. Finally, biomass may be pyrolyzed to produce sequestered carbon in the form of biochar, which holds value as a soil enhancer (Kruse and Hankamer, 2010). A general overview of applications of spent biomass is given in Figure 10.1.

When discussing the upgrade of spent biomass, one should take into account the process that originated it or the target metabolite from which the biofuel is obtained. For example, if the objective is to produce biohydrogen, the spent biomass consists of essentially intact cells, whereas when accumulated lipids are required of biodiesel, the spent biomass takes the form of oilcake. Compounds such as carbohydrates, hydrocarbons, and the biomass itself may still be transformed into secondary biofuels such as ethanol, oil, biochar, and syngas, as shown in Figure 10.2. On the other hand, the spent biomass from production of a biofuel may be used to high value-added products via extraction (see Table 10.1). Therefore, this chapter is organized according to two perspectives: spent biomass used for further biofuel production and spent biomass as a source of value-added products, namely as fine chemicals or feed or even in bioremediation.

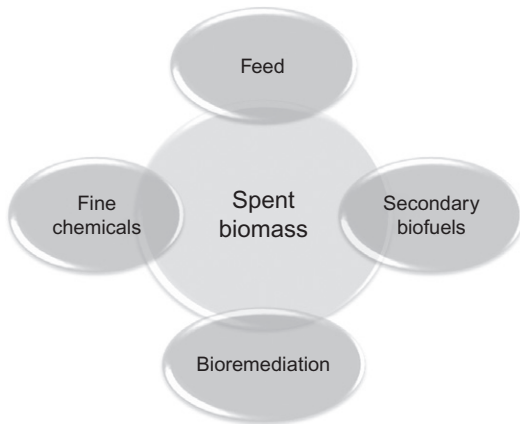

FIGURE 10.1 General applications of spent algal biomass.

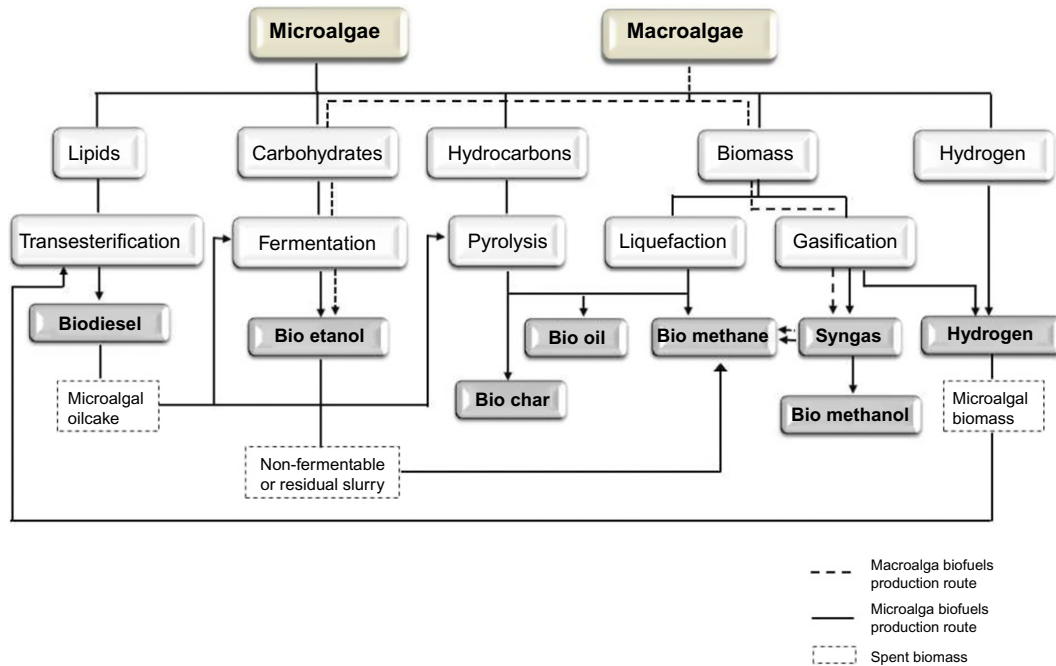

FIGURE 10.2 Applications of spent biomass for secondary biofuel production after their use in primary and corresponding routes.

10.2 SPENT BIOMASS FOR BIOFUEL PRODUCTION

Algae can produce, but they can also behave as material for production of several biofuels. The main possibilities will be scrutinized below, focusing on reuse of spent biomass for complementary production of secondary biofuel.

TABLE 10.1 Biomass Resulting from Alga-based Processing Towards Biofuels, and Treatment of Corresponding Spent Biomass for Secondary Biofuel Production.

Biomass Processing	Feedstock Conditions	Feedstock Pre-treatment	Main Products	Residual Biomass	Benefits of Residue or Byproducts	Reference
Hydrogen release	–	–	Hydrogen	Intact cells for biofuel production or value-added product extraction	Biomass can be used for biofuel production or high-value products extraction	(Yang, Guo et al., 2011)
Transesterification	Crude microalgal oil composed mainly of TAG	–	Biodiesel of more than 90% conversion	Oilcake rich in carbohydrates and proteins for ethanol production	Crude glycerol can be used as feed in heterotrophic microalgal culture Excess alcohol and catalysis can be recycled to the system	(Suali and Sarbatly, 2012)
Fermentation	Biomass rich in carbohydrates	Release of carbohydrates	Ethanol: 23%	Residual slurry for methane production	CO ₂ can be fed into phototrophic microalgal culture Unfermentable cellulose may be processed for animal feed	(Suali and Sarbatly, 2012)
Pyrolysis	Biomass free of water	Drying of biomass	Bio-oil: 28.6–57.9% (fast pyrolysis) Pyrolysis gas: 13–25% (slow pyrolysis)	–	Syngas can be converted into methanol Biochar may be used in agriculture Fluidizing gas can be recycled to pyrolysis reactor	(Heilmann, Jader et al., 2011)
Liquefaction	Moisture content of biomass up to 65%	Surge bin catalysis for slurry generation	–	–	Aqueous byproduct is obtained for microalgal culture	(Ross, Biller et al., 2010)
Gasification	Low levels of moisture below 40%, and low levels of nitrogen and alkali	–	H ₂ : 5–56% CO: 9–52%	–	Hydrocarbons are synthesized for methanol production at yields up to 64% of biomass	(Suali and Sarbatly, 2012)

10.2.1 Hydrogen

Chlamydomonas reinhardtii has been comprehensively investigated in terms of potential hydrogen photoproduction; in addition to hydrogen, a variable amount of byproducts are generated as part of the microalgal biomass. Its volatile nature permits the biomass to remain essentially intact (Kruse, Rupprecht et al., 2005).

To obtain further energy, the biomass can itself be processed via extraction and transesterification of the remaining lipids to produce biodiesel. For example, the total lipid content of the biomass of the *C. reinhardtii* strain D1 after photobiological hydrogen production is $15 \pm 2\%$ on a dry-weight basis; oil may then be extracted, being composed of 3.3% w/w_{oil} phytols, 21% w/w_{oil} triglycerides, 39% w/w_{oil} polar lipids, and 37% w/w_{oil} highly polar lipids, to eventually biodiesel composed of 41% saturated fatty esters, 53% mono unsaturated fatty esters, and 7.2% polyunsaturated fatty esters (mainly linoleic acid) (Torri, Samorì et al., 2011). This mix of methyl esters adheres to European Union (EU) standard EN 14214 pertaining to biodiesel specifications.

Following biodiesel production from the spent biomass, the lipid-free residue can still be used for animal feed or be anaerobically digested into biogas (Sialve, Bernet et al., 2009) as discussed in further detail in the following paragraph. Moreover, pyrolysis of the residue left after extraction may represent another pathway to produce extra energy (Mohan et al., 2006). Pyrolysis of the microalgal extraction residue may lead to oil with a quality lying between petroleum tar and bio-oil from lignocellulosic biomass (Miao et al., 2004); the mass yields of biochar, oil, and gas are $44 \pm 1\%$, $28 \pm 2\%$, and $28 \pm 1\%$, respectively. The ash content of said biochar, obtained via combustion at 700 °C, was $45 \pm 5\%$. On an ash-free basis, the mass yields of biochar, oil, and gas were $24 \pm 5\%$, $38 \pm 9\%$, and $36 \pm 1\%$, respectively (Torri, Samorì et al., 2011). Since a major portion of ashes, phosphorus, and nitrogen are retained in biochar, it may be used as fertilizer to improve the productivity of soil, thus contributing to abatement of greenhouse gases while making it possible to convert carbon-neutral energy into carbon-negative bio-energy (Kruse and Hankamer, 2010).

Additionally, production of biogas via fermentation of the microalgal biomass offers the possibility to recycle a large proportion of the original nutrients. Although this option is not economically feasible at low throughput rates, it will become a more interesting possibility as medium costs become a larger fraction of the final cost, coupled with consideration of phosphorous limitations (Cordell, Drangert et al., 2009).

10.2.2 Ethanol

Production of ethanol from algal biomass is chiefly obtained via fermentation of its starch, sugar, and cellulose. In the case of microalgae, carbohydrate contents amount to 70–72% (Brányiková, Maršálková et al., 2011), with starch dominating (i.e., up to 60% dry weight, depending on culture condition) (Dragone, Fernandes et al., 2011). Conversely, the most abundant sugars in brown macroalgae are alginates, mannitol, and glucan, i.e., glucose polymers in the form of laminarin or cellulose (Wargacki, Leonard et al., 2012).

In the case of microalgae, production of ethanol starting from the microalgal oilcake after biodiesel production is to be taken into consideration. By the end of production of ethanol, the waste can be in turn recycled, and the CO₂ generated can be fed to phototrophic microalgae

culture, while nonfermentable cellulose can be further processed as an animal feed supplement (Suali and Sarbatly, 2012).

Finally, the nonfermentable (or residual) slurry, composed mainly of proteins, lipids, and organic acids or alkali, can be used as feedstock for methane production by up to 10%; alternatively, the cells may be ruptured to release their proteins or enzymes as useful byproducts (Suali and Sarbatly, 2012).

10.2.3 Bio-oil

Bio-oil production can be achieved along two alternative approaches: biomass pyrolysis or biomass thermochemical liquefaction, as explained in this section.

The pyrolysis process is basically an anaerobic heating process carried out at high temperatures (between 200 °C and 750 °C). Pyrolysis may take place quickly or slowly; the former produces bio-oil (19–58% of the final product) and biochar (Miao et al., 2004; Grierson, Strezov et al., 2009). On the other hand, slow pyrolysis results in gas and biochar, with methane and CO₂ accounting for most of the gaseous product.

Bio-oil produced from microalgal spent biomass is more stable than that produced from traditional crops (e.g., wood), although it is not as stable as fossil fuel (Mohan et al., 2006). Such bio-oil is composed mainly of aliphatic and aromatic hydrocarbons, phenols, long-chain fatty acids, and nitrogenous compounds (Du, Li et al., 2011). During pyrolysis 10–25% of biomass is converted into char (i.e., solid porous carbon particles), whereas 10–30% becomes a (noncondensable) gas (Grierson, Strezov et al., 2009; Ross, Biller et al., 2010).

An alternative fuel gas is synthesis gas (syngas), a gas mixture that comprises carbon monoxide (CO) and dioxide as well as hydrogen. It can be obtained by gasification of algal biomass via a process consisting of reaction of carbonaceous compounds with atmospheric air, steam, or oxygen at high temperature (ranging from 200 °C to 700 °C) in a gasifier (Suali and Sarbatly, 2012). As a result, one obtains clean H₂ with yields from 5–56%, and CO with yields ranging from 9–52% (Abuadala, Dincer et al., 2010). Methane can be considered a coproduct since it is produced only to low levels, 2–25% (Suali and Sarbatly, 2012). The hydrocarbon products of gasification can be further processed to produce methanol: at 1000 °C, methanol production is 64% (w/w), on a biomass weight basis.

Another method for bio-oil production is thermochemical liquefaction of biomass. This requires heating the biomass at temperatures between 200 °C and 500 °C, under pressures above 20 bar in the presence of a catalyst. This process leads to bio-oil yields of 9–72%, together with a gaseous mixture (containing, for example, H₂) ranging from 6–20% (Ross, Biller et al., 2010; Suali and Sarbatly, 2012). The remaining ash ranges in term from 0.2–0.5%. The product of biomass liquefaction is somewhat comparable to crude fuel: most biomass feedstock characterized a ratio of solid to water of 1:10 lead to a bio-oil yields of ca. 37% (Zou, Wu et al., 2010).

The profile of products is mainly affected by the biomass composition and the processing conditions of temperature, pressure, residence time, and catalyst. The bio-oil yield can be 5–25% higher than the lipid content of the original microalgae, depending on the composition in other compounds such as carbohydrates (Biller and Ross, 2011). For instance, *Dunaliella tertiolecta* is mainly composed of crude protein (63.6%) and fat (20.5%) and produces a bio-oil

yield of ca. 37% on an organic basis (Minowa, Yokoyama et al., 1995); on the other hand, *Spirulina* sp. (a well-known food supplement, owing to its protein content) was reported to produce a bio-oil yield of up to 54% (Matsui, Nishihara et al., 1997). *Microcystis viridis*, which is composed of 46% carbon, 7.3% hydrogen, and 9.5% nitrogen, was able to lead to up to 33% bio-oil (Yang, Feng et al., 2004).

The aqueous coproduct of biomass liquefaction can be recycled to the microalgal culture; it is indeed rich in nitrogen, phosphorus, and potassium. The growth rate of microalgae cultured in a medium containing 0.1% aqueous coproduct was found to be one-half of that in microalgae cultured with established media, e.g., BG11 (Jena, Vaidyanathan et al., 2011).

10.2.4 Biochar

Biochar is a solid material obtained as the product of carbonization of biomass. This material can adsorb fatty acids, thus unfolding a potential application as hydrophobic adsorbent for use in water and air purification systems. Despite biochars possessing a relatively hydrophobic core, they are wetted by water due to such hydrophilic functional groups as carboxylic acids, aldehyde, and hydroxyl on the surface (Mursito, Hirajima et al., 2010), so these biochars may be useful as reinforcing additives in cement and organic polymers. The low ash content of carbonized char (Heilmann, Jader et al., 2011) also points to potential application as a carbon source for production of synthesis gas or as an alternative to coke in steel manufacture. This material may be easily stored in subterranean locations, thus entailing a form of carbon sequestration; it may also be applied in soil amendment, since it is rapidly attacked by soil microorganisms (Heilmann, Jader et al., 2011).

10.2.5 Biodiesel

Biodiesel typically consists of a mixture of fatty acid alkyl esters obtained by transesterification of oils or fats, which are normally composed of 90–98% triglycerides, much smaller levels of mono- and diglycerides and free fatty acids, and residual amounts of phospholipids, phosphatides, carotenes, tocopherols, sulphur compounds, and water (Bozbas, 2008).

The biomass left after biodiesel production takes the form of an oilcake containing glycerol as a byproduct of transesterification. This compound may then be refined and sold to the pharmaceutical industry or else used livestock feed (Shirvani, Yan et al., 2011). The oilcake stores 35–73% of its total energy as carbohydrates and proteins (Hu, Sommerfeld et al., 2008), and three distinct options may be considered: (1) an adjacent coal-fired power system that co-fires the left biomass (Xu et al., 2006); (2) a direct combustion of the oilcake in an integrated biomass-heating system (Amaro et al., 2011); or (3) a biomass combined heat and power unit (Huang and Wang, 2004) for energy cogeneration (and, indirectly, electricity production) (Bozbas, 2008; Mata, Martins et al., 2010; Yang, Guo et al., 2011).

Despite these possibilities, most oilcakes from microalgal origin are fermented into ethanol or methane or else to H_2 via anaerobic digestion. Alternatively, they may be incorporated in livestock feed or simply used as organic fertilizer, owing to a particularly high N:P ratio.

10.3 SPENT BIOMASS FOR FINE CHEMICAL PRODUCTION

In this section, some aspects of algal biology and biochemistry are introduced in view of their relevance to the underlying economics. The composition of algal biomass in terms of polysaccharides, proteins, lipids, pigments, iodine, phenols, and halogenated compounds is expected to critically determine its overall value.

10.3.1 Polysaccharide Material

Algae contain large contents of polysaccharides, notably as contributors to cell-wall structure but also as storage polysaccharides (Holdt and Kraan, 2011). Polysaccharides are polymers of simple sugars (monosaccharides) linked by glycosidic bonds. They entertain numerous commercial applications as stabilizers, thickeners, and emulsifiers in food (including beverages) and feed (Tseng, 2001).

Different groups of algae produce specific types of polysaccharides; for example, green algae produce starch for energy storage, which consists of both amylose and amylopectin, in a way similar to higher plants (Williams and Laurens, 2010). Their total concentrations range from 4–76% of dry weight (Holdt and Kraan, 2011).

On the other hand, macroalgae have a low lipid content, and even though their carbohydrate content is normally high, most of it is accounted for by dietary fibers that are not taken up by the human body but are rather utilized as a bulking agent (Holdt and Kraan, 2011).

The polysaccharides consist mainly of cellulose and hemicelluloses as well as neutral polysaccharides, yet cell-wall and storage polysaccharides are species-specific: green algae may contain sulphated galactans and xylans, whereas brown algae may have alginic acid, fucoidan (sulphated fucose), laminarin (β -1,3 glucan), and sargassan, and red algae may contain agars, carrageenans, xylans, floridean starch (amylopectin-like glucan), and water-soluble sulphated galactan as well as porphyran (Chandini, Ganesan et al., 2008). Cyanobacteria can produce cyanophycin and multi-L-arginyl-poly-L-aspartic acid (Williams and Laurens, 2010), but the contents of both common and species-specific polysaccharides undergo seasonal variations (Holdt and Kraan, 2011).

Algal polysaccharides can be classified as dietary fibers and hydrocolloids, as is done in the following sections, but they usually possess more than just one type of functional group.

10.3.1.1 Dietary Fibers

These kinds of polysaccharides are very diverse in chemical structure and in composition in the algal biomass. Edible marine macroalgae contain 33–62% total fibers (on a dry-weight basis), quite a bit higher than in higher plants, and such fibers are rich in soluble fractions (Dawczynski, Schubert et al., 2007). Recall that dietary fibers may be insoluble (e.g., cellulose, mannans, and xylan) or water-soluble (e.g., agars, alginic acid, furonan, laminaran, and porphyran, addressed in further detail in the next subsection).

These algal fibers are commonly extracted by precipitation, as described by Venugopal (2008), and may be used as nutraceuticals for functional food formulation (Holdt and Kraan, 2011). Examples of polysaccharides bearing antitumor and antiherpetic bioactivity (among others) are tabulated in Table 10.2.

TABLE 10.2 Bioactivities of Polysaccharides Extracted from Spent Algal Biomass.

Polysaccharide	Bioactivity	Reference
Sulphated polysaccharides	Anti-inflammatory Antiviral against VHSV, ASFV Antioxidant Anticoagulant	(Matsui, Muizzuddin et al., 2003) (Fabregas, García et al., 1999) (Li, Zhang et al., 2005) (Zhao, Xue et al., 2008)
p-KG03 exopolysaccharide	Immunostimulatory Antiviral against <i>Encephalomyocarditis virus</i>	(Yim, Kim et al., 2004)
Polysaccharides	Antiviral against HSV1, 2, influenza A virus	(Lee, Hayashi et al., 2004)
GA3P exopolysaccharide	Antitumoral against human myeloid leukemia K562 cells	(Umemura, Yanase et al., 2003)
Algins/alginate acid	Antibacterial	(Holdt and Kraan, 2011)
Polysaccharides	Antitumoral Antiherpetic Anticoagulant Hypocholesterolemic	(Athukorala, Lee et al., 2007) (Ye, Wang et al., 2008) (Amano, Kakinuma et al., 2005) (Murata and Nakazoe, 2001)
Carrageenan	Anticoagulant Antitumoral Antiviral	(Morrissey, Kraan et al., 2001)
Alginate	Antihypertensive Toxic chemical absorption preventive Hypocholesterolemic Hypolipidemic Protective against carcinogens via coating of surface membranes in stomach and intestine Antidiabetic Antibacterial Anticancer	(Murata and Nakazoe, 2001) (Kim and Lee, 2008) (Nishide, Anzai et al., 1993)
Agar	Hypoglycemic Anti-aggregative Antitumoral Antioxidant Anti-inflammatory	(Holdt and Kraan, 2011) (Murata and Nakazoe, 2001)
Agarose + agaropectin (7:3)	Anti-aggregative Antitumoral α -Glucosidase inhibition Pro-inflammatory cytokine TNF- α suppressive Inducible nitric oxide synthase (iNOS) suppressive Antioxidant	(Morrissey, Kraan et al., 2001) (Murata and Nakazoe, 2001) (Athukorala, Lee et al., 2007) (Amano, Kakinuma et al., 2005)
Phycarine	Immunostimulatory	(Mayer, Rodriguez et al., 2007)

10.3.1.2 Hydrocolloids

The group of phycocolloid polymers, commonly termed *hydrocolloids* because they are soluble in water, includes alginates, carrageenans, and agars—and red and brown macroalgae have long been used for the production of such compounds (Carlsson, 2007). These polymers are either located in the cell walls or within the cells where they serve as storage materials (Tseng, 2001).

Hydrocolloids account for the major industrial products derived from algae (Radmer, 1996; Pulz and Gross, 2004). They possess several useful properties for the food industry in thickening agents, forming gels and water-soluble films that are commonly applied to stabilize such products as ice cream, toothpaste, and mayonnaise (Tseng, 2001), thus taking advantage of their forming a gel upon cooling (Carlsson, 2007). Each major subgroup is described in further detail in the follow subsections.

10.3.1.2.1 ALGINATES

Alginates are polymers extracted from the cell walls of various brown algae, particularly the species *Laminaria*, *Saccharina*, *Macrocystis*, and *Ascophyllum*. They are composed of D-mannuronic acid and L-guluronic acid monomers, available in both acid and salt forms; the latter constitutes 40–47% of the dry weight of this brown algal biomass (Arasaki and Arasaki, 1983; Rasmussen and Morrissey, 2007).

Alginates are commonly applied as intermediate feedstock in the food and pharmaceutical industries as stabilizers for the preparation of emulsions and suspensions in ice cream, jam, cream, custard, lotions, and toothpaste but also as coatings for pills. Furthermore, they have found application in the production of paint, construction materials, glue, and paper as well as in the oil, photo, and textile industries (Radmer, 1996).

Besides these technological functions, alginates possess bioactivities, as depicted in Table 10.2. Positive favorable dietary effects of alginates upon faecal microbial fauna have been claimed, as well as prebiotic features (Wang, Han et al., 2006); for instance, the bioactive food additive Detoxal™ contains calcium alginate and exhibits antitoxic effects on hepatitis. Additionally, mannuronate surfactants derived from alginate have been applied in cosmetics, health products, and agrochemicals (Benvegnu and Sassi, 2010).

10.3.1.2.2 CARRAGEENANS

Carrageenans are composed of linear polysaccharide chains, with sulphate half-esters attached to the sugar unit. They are normally classified according to their structural characteristics, and there are at least 15 distinct structures.

Carrageenans are used in the food, textile, and pharmaceutical industries, where they are sought as aids to stabilize emulsions and suspensions. Most carrageenan is currently produced from cell walls of *Eucheuma* and *Kappaphycus* spp. Food applications for carrageenans (usually labeled E 407) include canned foods, dessert mousses, salad dressings, bakery fillings, ice cream, instant desserts, and pet foods. They are also used as suspension agents and stabilizers in drugs, lotions, and medicinal creams. An illustrative medical application is treatment of bowel problems, such as diarrhea, constipation, or dysentery; they are also used to make internal poultices to control stomach ulcers (Morrissey, Kraan et al., 2001).

10.3.1.2.3 AGARS

Agar is a mixture of polysaccharides, typically extracted from the cell walls of red algae; it is composed of agarose and agaropectin and exhibits structural and functional properties similar to those of carrageenans. Like carrageenans, agar is also extracted with hot water. The genera *Gelidium* and *Gracilaria* are the major commercial sources of agar (Carlsson, 2007). Like carrageenans, agar is used as stabilizers for emulsions and suspensions and as gelling agents. Approximately 90% of all agar produced worldwide is intended for food applications; the remainder is used in the manufacture of capsules for medical applications and as a medium for cell cultures (Carlsson, 2007). Agar affects absorption of ultraviolet radiation (Murata and Nakazoe, 2001) and exhibits a few bioactivities as well (see Table 10.2).

10.3.2 Proteinaceous Compounds

Algal proteins may play both structural and nutritional roles, so their extraction from spent biomass is of potentially commercial interest. One application is for animal feed due their richness in essential amino acids (Williams and Laurens, 2010). The nonprotein nitrogen consists of amino acids, peptides, amines, and nucleotides and accounts for 10–20% of the total nitrogen in algae (Arasaki and Arasaki, 1983).

Recently, a few studies have been reported with respect to the organic solvent extractions due to the experience of remaining toxic residues with the target compounds, so enzyme-assisted extractions have attracted particular interest. Mechanical techniques such as ultrasound sonication and pulverizing the lyophilized materials by grinding might also be helpful. Namely, bioactive peptides can be obtained in three ways: (1) hydrolysis by digestive enzymes from animals; (2) hydrolysis by proteolytic enzymes, harvested by microorganisms or plants; and (3) hydrolysis by proteolytic microorganisms during fermentation (Samarakoon and Jeon, 2012).

10.3.2.1 Proteins

The proteins, peptides, and amino acids vary with the algal species as well as the habitat and the season (Arasaki and Arasaki, 1983). In general, the protein content is relatively low in brown algae but is higher in green and red algae. Proteins may indeed represent 35–45% of dry matter in macroalgae (Holdt and Kraan, 2011) and even 60%–70% in microalgae (Babadzhanov, Abdusamatova et al., 2004; Samarakoon and Jeon, 2012). These levels are comparable to those found in high-protein vegetables (e.g., soybeans), in which proteins account for up to 40% of their dry mass (Murata and Nakazoe, 2001).

Most algal species contain all essential amino acids and are in particular a rich source of aspartic and glutamic acids (Fleurence, 1999). The levels of some amino acid residues are actually higher than those found in terrestrial plants—for example, threonine, lysine, tryptophan, cysteine, methionine, and histidine (Galland-Irmouli, Fleurence et al., 1999). Brown algae proteins have been reported as good sources of threonine, valine, leucine, lysine, glycine, and alanine but poor sources of cysteine, methionine, histidine, tryptophan, and tyrosine (Dawczynski, Schubert et al., 2007). Red algae possess high quantities of glutamic and aspartic acids but lower levels of basic amino acids compared to the other two algal groups (Fleurence, 1999).

Bioactive proteins and peptides have been found in micro- and macroalgae that possess a nutraceutical potential (DeFelice, 1995), as is the case of their role in reducing the risk of cardiovascular diseases (Erdmann, Cheung et al., 2008). Several other bioactivities are presented in Table 10.3.

10.3.2.2 Peptides

Bioactive peptides usually contain 3–20 amino acid residues, and their activities stem from both their amino acid composition and sequence (Pihlanto-Leppälä, 2000). Usually such short chains of amino acids are inactive within the sequence of the parent protein, but they become active upon release during gastrointestinal digestion or during food processing, including

TABLE 10.3 Bioactivities of Proteinaceous Compounds Extracted from Spent Algal Biomass.

Proteinaceous Compound	Bioactivity	Reference	
Total protein	Mitogenic of lymphocytes Erythrocyte agglutination	(Bird, Chiles et al., 1993) (Holdt and Kraan, 2011)	
Protein	Lectin		
	Antibiotic	(Liao, Lin et al., 2003)	
	Antibacterial against <i>Vibrio vulnificus</i>	(Smit, 2004)	
	Anti-inflammatory	(Bird, Chiles et al., 1993)	
	Antinociceptive	(Sugawara, Baskaran et al., 2002)	
	Mitogenic of lymphocytes	(Cardozo, Guaratini et al., 2007)	
	Apoptosis, metastasis and differentiation promoter		
	Binder of carbohydrates, including viruses, bacteria, fungi and parasites	(Mori, O'Keefe et al., 2005)	
	Antiviral against HIV		
	Anti-adhesive	(Holdt and Kraan, 2011)	
	Cytotoxic	(Liao, Lin et al., 2003)	
	Platelet aggregation inhibitory		
	Agglutinin glycoprotein	Mitogenic of lymphocytes Cytotoxic against several cancer cell lines Antitumoral	(Holdt and Kraan, 2011) (Sugahara, Ohama et al., 2001)
	Mycin-binding agglutinin	Anti-inflammatory	(Bitencourt, Figueiredo et al., 2008)
Peptides	Depsipeptide (kalahide F)	Antitumoral Antiviral against AIDS	(Smit, 2004)
	Hexapeptide (SECMA 1)	Mitogenic	(Ennamany, Saboureau et al., 1998)
	Cyclic pentapeptide (galaxamide)	Antiproliferative against human renal cell carcinoma GRC-1 and hepatocellular carcinoma HepG2	(Xu, Liao et al., 2008) (Sato, Hosokawa et al., 2002)
	Dipeptide	Blood pressure reducer Inhibitory of angiotensin-converting enzyme	(Sato, Hosokawa et al., 2002) (Suetsuna, Maekawa et al., 2004)

Continued

TABLE 10.3 Bioactivities of Proteinaceous Compounds Extracted from Spent Algal Biomass—Cont'd

Proteaceous Compound	Bioactivity	Reference
Peptide	Inhibitory of angiotensin-converting enzyme Hypocholesterolemic Enhancer of hepatic function Reducer of plasma glucose Antioxidant	(Holdt and Kraan, 2011) (Smit, 2004)
Oligopeptides	Analog of the neurotransmitter γ -aminobutyric acid (GABA)	(Aneiros and Garateix, 2004)
Amino acids	Taurine Antihypertensive Hypocholesterolemic Antidiabetic Preventive of vascular diseases and hepatitis Antioxidant	(Militante and Lombardini, 2002) (Zhang, Li et al., 2003) (Houston, 2005) (Mochizuki, Takido et al., 1999)
Laminine	Hypertensive Depressor of smooth muscle contraction	(Holdt and Kraan, 2011)

fermentation. Examples of bioactive peptides obtained by enzymatic hydrolysis of algal proteins (Kim and Wijesekara, 2010) are shown in Table 10.3 together with their characteristic physiological roles.

10.3.2.3 Free Amino Acids

The free amino-acid fraction of macroalgae is composed chiefly of alanine, taurine, ornithine, citrulline, and hydroxyproline (Holdt and Kraan, 2011). In the case of microalgae, high quantities of lysine, methionine, cysteine, and threonine have been reported (Morist, Montesinos et al., 2001), which differ among species (McHugh, Food et al., 2003).

All essential amino acids were reported in brown and red seaweed species, whereas red species feature unusually high concentrations of taurine compared to their brown counterparts (Dawczynski, Schubert et al., 2007). Taurine is not a true amino acid due to the lack of a carboxyl group, but it contains a sulfonated acid group instead. It is found in fish and shellfish in addition to macroalgae. A number of health-promoting properties of algal amino acids are depicted in Table 10.3.

In addition to taurine, other unusual (but bioactive) amino acids, such as laminine, kainoids, and mycosporine-like amino acids, have been found in marine macroalgae. Kainoids are a unique group of amino acids that are structurally and functionally related to aspartic and glutamic acids; they have attracted an interest due to their strong insecticidal, anthelmintic, and neuroexcitatory properties (Parsons, 1996). Algal extracts containing domoic and kainic acid have indeed been used as anthelmintic agents in Japan for centuries for treatment of ascariasis caused by the parasitic roundworm (Parsons, 1996; Smit, 2004). Such compounds are currently being tested against neurophysiological disorders such as Alzheimer's and Parkinson's diseases and epilepsy (Smit, 2004).

10.3.3 Lipid Compounds

Depending on the primary biofuel target, a broad group of naturally occurring lipids remain in algal spent biomass; these include fats; waxes; sterols; fat-soluble vitamins (e.g., A, D, E and K); mono-, di-, and triacylglycerols; diglycerides, and phospholipids (Williams and Laurens, 2010). Of particular importance are polyunsaturated fatty acids (PUFA); interest has emerged in recent years owing to their potential therapeutic uses in addition to nutritional applications derived from physiological roles in actual cells. PUFAs have been thoroughly studied, especially ω 3 long-chain PUFA (LC-PUFA), in regard to docosahexaenoic acid (DHA), eicosapentaenoic acid (EPA), and α -linolenic acid (ALA). Their importance to human health has backed up market demand for them (Guedes et al., 2011a).

The predominant PUFA in various marine algae is EPA at concentrations as high as 50% of its total fatty acid content (Murata and Nakazoe, 2001; Dawczynski, Schubert et al., 2007). Marine algae also contain 18:4 n-3, which is hardly found in other organisms; notably, red alga species contain significant quantities of EPA and arachidonic acid (20:4), whereas green algae are unique in their content of 16:4, varying from 4.9% to 23.1% of the total fatty acids, besides 16:0, 18:1, and 18:3 acids. Unsaturated fatty acids predominate in all brown algae and saturated fatty acids in red algae, both groups being balanced sources of n-3 and n-6 acids (Mabeau and Fleurence, 1993; Sánchez-Machado, López-Hernández et al., 2004).

The main effects of n-3 fatty acids on human health can be classified into three categories: (1) structural components of cell and organelle membranes, (2) significant role in lowering blood lipids, and (3) precursors in mediating biochemical and physiological responses. Human beings have to include ALA, EPA, and/or DHA in their daily diet, especially via inclusion of marine products. However, algae exhibit competitive advantages as sources of PUFAs: Fish (the most common source) have typically lower contents (on a mass basis) and are subjected to seasonal variations in fatty acid profile, besides their being proven to be contaminated by heavy metals (Guil-Guerrero, Navarro-Juárez et al., 2004). Furthermore, they have a limited capacity to synthesize PUFA, so most of them are simply accumulated from their microalgal diet (Guedes et al., 2011a). Algae are indeed a good source of EPA (Plaza, Cifuentes et al., 2008) and an important source of n-3 PUFAs (Murata and Nakazoe, 2001). Besides the well-accepted effect of 18:4 n-3 on the immune system in humans (Ishihara, Murata et al., 1998), several other bioactivities have been reported, as tabulated in Table 10.4.

The relative composition of algal lipids depends greatly on the species as well as available nutrients and prevailing environmental conditions during cell culture and harvest. For instance, it has been shown that the composition of algal lipids varies considerably with the growth cycle, under nutrient limitation and a diurnal light/dark cycle (Ekman A, Bulow L et al., 2007; Greenwell, Laurens et al., 2010). Many algal species can be induced to accumulate substantial contents of lipids; although average lipid contents vary between 1% and 70%, some species may reach 90% (w/w_{DW}) (Guedes et al., 2011a). Concerning their extraction, several methods can be applied, but the most common are expeller/oil pressing, liquid-liquid extraction (solvent extraction), supercritical fluid extraction (SFE), and ultrasound techniques, all of which bear advantages and limitations, as discussed elsewhere (Singh and Gu, 2010).

TABLE 10.4 Bioactivities of Lipid Compounds Extracted from Spent Algal Biomass.

Lipid Compound	Bioactivity	Reference
Sterols	Anti-inflammatory	(Guzmán, Gato et al., 2001)
Eicosapentaenoic acid	Antimicrobial against MRSA, <i>Listonella anguillarum</i> and <i>Lactococcus garvieae</i> Antioxidant	(Guedes et al., 2011b)
α -Linolenic acid	Antibacterial	(Ohta, Chang et al., 1993)
Phospholipids	Contributor to lipoprotein formation in liver, nervous system conduction and protection, memory storage, and muscle control	(Holdt and Kraan, 2011)
Choline	Methyl donor and precursor of acetylcholine	(Holdt and Kraan, 2011)

10.3.3.1 Phospholipids

Phospholipids (PLs) consist of fatty acids and a phosphate-containing moiety attached to either glycerol or (the amino alcohol) sphingosine, thus resulting in compounds with fat-soluble and water-soluble regions that are ubiquitous in cell membranes. Glycerol-containing PLs include phosphatidic acid, phosphatidylcholine (PC), phosphatidylethanolamine (PE), phosphatidylinositol, and phosphatidylserine. Sphingomyelin (SPH), a major PL, consists of sphingosine and PC. Phospholipids and choline entail several benefits for human health, as depicted in Table 10.4. The level of phospholipids in various red macroalgae varies from 10–21% of total lipids; the main ones are PC (62–78%) and PG (10–23%) (Dembitsky and Rozentsvet, 1990).

Dietary phospholipids act as natural emulsifiers and as such they facilitate digestion and absorption of fatty acids, cholesterol, and other lipophilic nutrients. Algal phospholipids appear to bear a number of advantages relative to fish oils because they are more resistant to oxidation (rancidity), have higher contents of EPA and DHA and provide them with a better bioavailability, and entail a wider spectrum of health benefits for humans and animals (Holdt and Kraan, 2011).

10.3.3.2 Glycolipids

Glycolipids are carbohydrate-attached lipids that can be extracted from algal biomass. Their role is to provide energy and to serve as markers for cellular recognition owing to their association with cell membranes.

Red algae contain monoglycosyldiacylglycerol (MGDG), diglycosyldiacylglycerol (DGDG), and sulphaquinovosyldiacyl-glycerol at essentially similar levels. Conversely, MGDG and DGDG are the chief glycolipids in green algae. On the other hand, the MGDG content of brown algae varies from 26–47%, the DGDG content from 20–44%, and the ulphaquinovosyldiacylglycerol content from 18–52% of the total glycolipids (Dembitsky and Rozentsvet, 1990).

10.3.3.3 Sterols

Sterols occur naturally in plants and animals; the most familiar type of the latter is cholesterol, which is vital to cellular functioning due to its role in the fluidity of the cell

membrane, besides serving as a secondary messenger in developmental signaling. Furthermore, cholesterol is a precursor of fat-soluble vitamins and steroid hormones.

The content and type of sterols vary with the alga species: green algae contain 28-isofucocholesterol, cholesterol, 24-methylene-cholesterol, and β -sitosterol, whereas brown algae contain fucosterol, cholesterol and brassicasterol; red algae contain desmosterol, cholesterol, sitosterol, fucosterol, and chalinasterol. The predominant sterol in brown algae, fucosterol, accounts for 83–97% of the total sterol content, whereas desmosterol, in red algae, accounts for 87–93% (Sánchez-Machado, López-Hernández et al., 2004; Kumar, Ganesan et al., 2008).

10.3.4 Pigment Materials

10.3.4.1 Chlorophylls

Chlorophylls are green, lipid-soluble pigments found in all algae, higher plants, and cyanobacteria that carry out photosynthesis (Rasmussen and Morrissey, 2007). Chlorophyll is converted into pheophytin, pyropheophytin, and pheophorbide in processed vegetable foods following ingestion by humans. These valuable bioactive compounds show antimutagenic effect so are thus likely play a significant role in cancer prevention—specifically via inhibition of myeloma cell multiplicity via pheophorbide (Simon, Alvin et al., 1999). Moreover, chlorophylls are used as a natural food-coloring agent and has antioxidant as well as antimutagenic properties.

The process of extracting chlorophyll from marine algae begins with dewatering and desalting the highly dilute culture (0.1–1% w/v, in the case of microalgae). Chlorophyll is then extracted from the dried biomass by organic solvent extraction or SFE. This process is followed by a fractionation step to separate the chlorophyll pigments and derivatives. Many studies have been carried out to optimize chlorophyll extraction and fractionation from algae (Liqun, Pengcheng et al., 2008; Hosikian, Lim et al., 2010).

10.3.4.2 Carotenoids

Carotenoids are the most widespread pigments in nature and they appear in all algae, higher plants, and many photosynthetic bacteria. Their role is to protect from light radiation in the red, orange, or yellow wavelengths. Chemically speaking, carotenoids are tetraterpenes, whereas carotenes are hydrocarbons and xanthophylls contain one or more oxygen molecules (Lobban and Harrison, 1994). All xanthophylls synthesized by higher plants, e.g. violaxanthin, antheraxanthin, zeaxanthin, neoxanthin, and lutein, can also be synthesized by green algae. However, these possess additional xanthophylls, that is, loroxanthin, astaxanthin, and canthaxanthin. Diatoxanthin, diadinoxanthin, and fucoxanthin can also be produced by brown algae or diatoms (Guedes et al., 2011c). In general, green algae contain β -carotene, lutein, violaxanthin, neoxanthin, and zeaxanthin, whereas red species contain mainly α - and β -carotene, lutein, and zeaxanthin. β -carotene, violaxanthin, and fucoxanthin are present chiefly in brown species (Haugan and Liaaen-Jensen, 1994).

Extraction of carotenoids from algae has been boosted in recent years in the alimentary and aquaculture fields (Lamers, Janssen et al., 2008), driven by consumers' environmental and health awareness and commercial feasibility. The major large-scale applications are

food and health. Carotenoids' antioxidant properties have been shown to play a role in preventing pathologies linked to oxidative stress (Yan, Chuda et al., 1999).

Recall that most oxidation reactions in foods are deleterious, e.g., degradation of vitamins, pigments, and lipids, with consequent loss of nutritional value and development of off-flavors (Bannister, O'Neill et al., 1985; Fennema, 1996). On the other hand, carotenoids are particularly strong dyes, even at ppm levels. Specifically, canthaxanthin, astaxanthin, and lutein have been in regular use as pigments and accordingly have been included as ingredients of feed for salmonid fish and trout as well as poultry, to enhance the reddish color of fish meat or the yellowish color of egg yolk (Lorenz and Cysewski, 2000; Plaza, Herrero et al., 2009). Furthermore, β -carotene has experienced an increasing demand as pro-vitamin A (retinol) in multivitamin preparations. It is usually included in the formulation of healthy foods under antioxidant claims (Krinsky and Johnson, 2005; Spolaore, Joannis-Cassan et al., 2006). Some carotenoids are part of vitamins, which have diverse biochemical functions, including hormones, antioxidants, mediators of cell signaling, and regulators of cell and tissue growth and differentiation (Holdt and Kraan, 2011).

In humans, oxidation reactions driven by reactive oxygen species can lead to protein damage as well as DNA decay or mutation; these may, in turn, lead to several syndromes, such as cardiovascular diseases, some kinds of cancer, and degenerative diseases, besides aging in general (Kohen and Nyska, 2002). As potential biological antioxidants, carotenoids have the ability to stimulate the immune system and may be involved in as many as 60 life-threatening diseases, including various forms of cancer, coronary heart diseases, premature aging, and arthritis (Mojaat, Pruvost et al., 2008). Carotenoids exhibit hypolipidemic and hypocholesterolemic effects as well (Guedes et al., 2011c). A summary of these bioactivities is provided in Table 10.5.

TABLE 10.5 Bioactivities of Carotenoid Compounds Extracted from Spent Algal Biomass.

Carotenoid Compound	Bioactivity	Reference
β -carotene	Antioxidant	(Plaza, Herrero et al., 2009)
Astaxanthin	Antioxidant Anti-inflammatory Antitumoral against colon cancer	(Plaza, Herrero et al., 2009)
Cantaxanthin	Antioxidant	(Plaza, Herrero et al., 2009)
Lutein	Antioxidant	
Violaxanthin	Antioxidant	
Diadinochrome A, B, diatoxanthin/ cynthiixanthin	Antitumoral	(Holdt and Kraan, 2011)
Fucoxanthin	Anti-obesity	(Sugahara, Ohama et al., 2001) (Plaza, Cifuentes et al., 2008)
Zeaxanthin	Preventer of ophthalmological diseases	(Astorg, 1997)

Concerning carotenoid extraction, methodologies such as solvent extraction, supercritical extraction, or expanded bed absorption chromatography can be applied, as described by Liam et al. (Liam, Anika et al., 2012).

10.3.4.3 *Phycobiliproteins*

Unlike chlorophylls and carotenoids, phycobiliproteins are water-soluble and form particles (phycobilisomes) on the surface of thylakoids rather than being embedded in the membranes. These proteins are major photosynthetic accessory pigments in algae and include phycoerythrin, phycocyanin, allophycocyanin, and phycoerythrocyanin (Jian-Feng, Guang-Ce et al., 2006).

Phycobiliproteins consist of pigmented phycobilins, i.e., linear tetrapyrroles. Various combinations of the two major phycobilins—phycoerythrobilin (red) and phycocyanobilin (blue)—can absorb at distinct spectral regions (Lobban and Harrison, 1994). Within phycobilisomes, phycobiliproteins play an important role in the photosynthetic process of at least three families of algae: Rhodophyta, Cyanophyta, and Cyptophyta (Chronakis, Galatanu et al., 2000; Aneiros and Garateix, 2004). The additional photosynthetic pigments make light harvesting possible in deep waters because surface light wavelengths for some colors are almost completely absorbed below 10 m (Voet, Voet et al., 2008).

The aforementioned proteins have been used as natural colorants for food and cosmetic applications, e.g., chewing gum, ice sherbets and gellies, and dairy products, in addition to lipsticks and eyeliners (Bermejo Román, Álvarez-Pez et al., 2002; Sekar and Chandramohan, 2008). Several phycobiliproteins have been shown to exhibit antioxidant, anti-inflammatory, neuroprotective, hypocholesterolemic, hepatoprotective, antiviral, antitumoral, liver-protecting, serum lipid-reducing, and lipase-inhibiting activities (Sekar and Chandramohan, 2008). Therefore, such health products as tablets, capsules, or powders that include phycocyanin have successfully reached the market in recent times (Guil-Guerrero, Navarro-Juárez et al., 2004). This type of pigment can be recovered by several techniques, e.g., solvent extraction and pressurized liquid extraction as well as expanded bed absorption chromatography, as covered by Liam et al. (Liam, Anika et al., 2012).

10.3.5 Halogenated Materials

10.3.5.1 *Iodine*

Marine algae are known for their high mineral content, so they have been used as feed and food supplements. In fact, they have 10–100 times the mineral content of traditional vegetables (Arasaki and Arasaki, 1983; Nishizawa, 2002), with ash reaching levels of up to 55% on a dry-weight basis, whereas sweet corn has a content of 2.6% and spinach an exceptionally high mineral content of 20% (Rupérez, Ahrazem et al., 2002). The mineral composition varies according to phylum as well as such other factors as seasonal, environmental, geographical, and physiological variations.

The mineral iodine deserves particular attention because its concentration may reach quite high levels in certain brown algae—say, 1.2% of dry weight. For instance, *Saccharina japonica* (kombu) is an excellent source of iodine, so it has been used for centuries in China as a dietary iodine supplement to prevent goiter; most of it is dried and eaten directly in soups, salads, and tea or used to make secondary products with various seasonings (Lobban and Harrison,

1994). Furthermore, kelp was used as raw material for extraction of iodine in Ireland during the 17th century (Morrissey, Kraan et al., 2001). Nevertheless, excessive iodine intake in sensitive persons can trigger hyperactivity of the thyroid gland, similar to the myxoedema reaction (Holdt and Kraan, 2011), so brown alga consumption has to be limited. The main methods of extracting iodine from seaweed, such as incineration, blowout, ion exchange, and activated carbon adsorption, have been fully discussed and compared in terms of advantages and shortcomings by Jinggang et al. (Wang, Feng et al., 2008).

10.3.5.2 Halogenated Derivatives

Besides iodine, compounds derived from halogens are produced by red and brown macroalgae (Butler and Carter-Franklin, 2004). Halogenated compounds appear as several classes of primary and secondary metabolites, including indoles, terpenes, acetogenins, phenols, fatty acids, polyhalogenated monoterpenes, and volatile halogenated hydrocarbons (e.g., bromoform, chloroform, and dibromomethane) (Dembitsky and Rozentsvet, 1990; Butler and Carter-Franklin, 2004). In many cases, they possess biological activities of pharmacological interest, as emphasized in Table 10.6. These compounds may also play

TABLE 10.6 Bioactivities of Polyphenol and Halogenated Compounds Extracted from Spent Algal Biomass.

Compound	Bioactivity	Reference			
Polyphenol	Phorotannins	Antioxidant	(Plaza, Cifuentes et al., 2008)		
		Radiation protection	(Yuan and Walsh, 2006)		
		Antiproliferative	(Cérantola, Breton et al., 2006)		
		Antibiotic	(Chandini, Ganesan et al., 2008)		
		Antidiabetes	(Kang, Park et al., 2003)		
		Anticancer	(Lim, Cheung et al., 2002)		
		Anti-HIV	(Zubia et al., 2008)		
		Hepatoprotective	(Li, Li et al., 2007)		
		Anti-allergic	(Sampath-Wiley, Neefus et al., 2008)		
		Plasmin inhibitor	(Zhang, Tiller et al., 2007)		
		Photo chemopreventive	(Yuan, Carrington et al., 2005)		
		Antibacterial	(Li, Qian et al., 2009)		
		Anti-inflammatory	(Zou, Qian et al., 2008)		
		Preventive against cardiovascular diseases	(Yong, Zhong-Ji et al., 2008)		
		Preventive against arthritis	(Holdt and Kraan, 2011)		
		Preventive against autoimmune disorders			
		Polyphenol	Fucol, Fucophlorethol, Fucodiphloroethol G Ergosterol	Antioxidant	(Garbisa, Sartor et al., 2001)
					(Maliakal, Coville et al., 2001)
					(Kang, Park et al., 2003)
Halogenated compound		Antibacterial	(Vairappan, Suzuki et al., 2001)		
		Antitumoral	(Fuller, Cardellina et al., 1992)		
		Antituberculosis			
		Cytotoxicity			

multifunctional ecological roles (Suzuki, Takahashi et al., 2002; Brito, Cueto et al., 2002). These kinds of compounds can be extractable by SFE or/and using solvents (Pourmortazavi and Hajimirsadeghi, 2007) or by pressurized liquid with solid-phase extraction (Onofrejeva, Vařıckova et al., 2010).

10.3.6 Phenolic Materials

Phenols (sometimes called *phenolics*) are a class of chemical compound consisting of a hydroxyl group (–OH) directly bound to an aromatic hydrocarbon group. The simplest of this class is phenol, the parent compound used as disinfectant and for chemical synthesis. Phlorotannins are an extremely heterogeneous group of phenolic compounds in terms of structure and degree of polymerization; accordingly, they provide a wide range of biological activities (Holdt and Kraan, 2011). Green and red macroalgae possess low concentrations of phenols (Mabeau and Fleurence, 1993) compared to brown macroalgae that are particularly rich in phlorotannin. Typical phenolic contents vary from 1–14% of dry macroalga biomass. Such polyphenols as fucol, fucophlorethol, fucodiphloroethol G, and ergosterol as well as phlorotannin are abundant in brown macroalgae and possess strong antioxidant effects. The concentration of polyphenols exhibits seasonal variations and shows a significant time correlation with the algal reproductive state, besides being affected by a number of other parameters such as location and salinity (Holdt and Kraan, 2011).

Polyphenols entail a cosmetic and pharmacological value owing to their antioxidative activity; they also have shown other favorable effects, e.g., protection from radiation as well as antibiotic and antidiabetic qualities. Several of these effects were tested in bacteria, cell cultures, rodents, and even humans, namely with regard to sexual performance and desire. Certain polyphenols may work as preventative medicines due their several bioactivities (see Table 10.6); in particular, phlorotannins are candidates for development of unique natural antioxidants for further industrial applications in functional food, cosmetic, and pharmaceutical formulations (Li, Qian et al., 2009).

For their extraction, several methods can be applied using Soxhlet-based solvent extraction or ultrasonic extraction, as discussed elsewhere (Mahugo Santana, Sosa Ferrera et al., 2009).

10.4 BIOREMEDIATION

In addition to being a source of secondary biofuels and value-added compounds, the spent biomass of algae may also be applied as CO₂ sequester and wastewater treatment, as detailed next.

10.4.1 Carbon Dioxide Sequestering

Algae have higher growth rates and higher photosynthetic efficiencies than terrestrial plants, so they are more efficient in capturing atmospheric carbon (Packer, 2009). However, flue gases from industrial plants have been reported as a suitable feed of algae. The use of algae for carbon sequestration is at present considered feasible if they are used as biofuel feedstock rather than merely as a carbon sequester (Suali and Sarbatly, 2012).

10.4.2 Wastewater Treatment

Because algae require a variety of organic nutrients, it is possible to use them in wastewater treatment. In fact, wastewater has a significantly higher content of individual amino acids that support growth of algae, and they have been shown to reduce the chemical oxygen demand (COD) and biochemical oxygen demand (BOD) in wastewater (Christenson and Sims, 2011).

10.5 FEED

A final important use of spent biomass is a feed—for plants as fertilizers but also for such aquatic animals as fish or even zooplankton. These two applications are discussed in further detail in this section.

10.5.1 Fertilizer (Plant Feed)

Commercial fertilizers, used for long periods, have adverse effects on soil productivity and environmental quality, so interest in environmentally friendly, sustainable agricultural practices has been on the rise. In developing and implementing sustainable agriculture techniques, biofertilization is of great importance to alleviate deterioration of natural ecosystems and to reduce the impact of environmental pollution while integrating nutrient supply into agriculture. Biofertilizers include mainly nitrogen-fixing, phosphate-solubilizing, and plant growth-promoting microorganisms, as in the case of microalgae.

Marine algae and algae-derived products have been widely used as nutrient supplements and as biostimulants or biofertilizers to increase plant growth and yield. The regulatory substances cytokinins, auxins, gibberellins, and betaines in algae can induce plant growth (Valente, Gouveia et al., 2006), but their roles as macro- and micronutrients also make them valuable components of biofertilizers. A few commercial products based on marine algae are ready available for use in agriculture, but ongoing research has featured several alga species in terms of ascertaining their effects on plant growth. For instance, recent work with *Laminaria digitata* indicated that this marine macroalga (traditionally used as soil amendment in many parts of the world) improves seed germination and rooting in terrestrial plants (Thorsen, Woodward et al., 2010).

Several pieces of evidence confirmed that microalgae are beneficial in plant cultivation by producing growth-promoting regulators, vitamins, amino acids, polypeptides, and antibacterial and antifungal substances that exert phytopathogen biocontrol as well as polymers, especially exopolysaccharides that improve both plant growth and productivity (de Mulé, de Caire et al., 1999). Other indirect growth-promotion effects may be claimed, such as enhancing the water-holding capacity of soils or substrates, improving availability of plant nutrients, and producing antifungal and antibacterial compounds (Schwartz and Krienitz, 2005). In hydroponic cultivation, microalgae present a few extra benefits: The oxygen produced by photosynthesis avoids anaerobiosis in the root system while releasing such growth-hormones as auxins, cytokins, gibberellins, abscisic acid, and ethylene (Schwartz and Krienitz, 2005). Equally important and promising is the high N:P ratio exhibited by microalgae, which is an extra indicator of its potential as fertilizer.

10.5.2 Animal Feed

The moisture content of fresh marine algae is quite high and can account for up to 94% of their biomass. However, marine algae contain such nutritional elements as proteins, lipids, carbohydrates, vitamins, and minerals that are in high demand for animal feed (Zubia et al., 2008). In particular, the ash content is high compared to that of vegetables (Murata and Nakazoe, 2001) and includes both macrominerals and trace elements.

Fish feeding represents over 50% of the whole operating costs in intensive aquaculture, with protein being the most expensive dietary source (Lovell, 2003). Nowadays 24% of the fish harvested by fisheries worldwide is used to produce fish meal and fish oil, thus putting high pressure on fisheries that aquaculture has attempted to alleviate. This demand promoted extensive efforts to find alternative sources of protein sources for aquatic feed; unfortunately, plants are poor protein sources in fish diets owing to their deficiency in certain essential amino acids, their content of antinutritional compounds, and taste problems.

Conversely, microalgae have been traditionally used to enrich zooplankton, which will in turn be used to feed fish and other larvae. In addition to providing proteins contain essential amino acids, they carry such other key nutrients as vitamins, essential PUFAs, pigments, and sterols, which may then be transferred upward through the food chain (Guedes and Malcata, 2012).

On the other hand, contamination by bacteria that attack fish can potentially devastate aquaculture farms. Microalgal fatty acids longer than 10 carbon atoms can induce lysis of bacterial protoplasts; said ability depends on composition, concentration, and degree of unsaturation of free lipids (Guedes et al., 2011b). The contents of carotenoids are important in aquaculture as well. In fact, artificial diets that lack natural pigments preclude such organisms as salmon or trout to acquire their characteristic red color (muscle), which, in nature, is a result of ingesting microalgae containing red pigments; without such a color, a lower market value will result (Guedes and Malcata, 2012).

10.6 FINAL CONSIDERATIONS

Due to the dramatic increase in primary energy consumption and the increasingly strict environmental issues triggered by fossil-fuel sources, it is our firm belief that development of algal biofuel is urged. As discussed in this chapter, the main challenges pertaining to algal biofuel viability entail lower environmental impact beyond a number of associated benefits (namely, CO₂ reduction and wastewater treatment), which may contribute to ensuring economic competitiveness.

However, associated with biofuel production is the spent biomass that is produced, with huge potential in terms of applications—from secondary biofuels through feed formulations and fine chemicals to bioremediation purposes. Therefore, biofuel production using spent biomass entails a strong economic interest, as thoroughly discussed in this chapter.

For competitiveness in this algae-based scenario, industry should follow an integral upgrade approach via implementation of an algal-based biorefinery, thus maximizing the economic return on all components of algal biomass, aiming at the point of zero residues.

A careful analysis of the current state of the art indicates that it is difficult to develop algal biofuel to the point where it can fully replace fossil fuels, in either developing or developed economies. Governments should indeed adopt an affirmative action by enforcing carbon taxes to limit use of fossil fuels as well as subsidizing investment, funding R&D efforts, and promoting consumption of renewable energies. Multilateral alternative energy developments will probably be necessary to fully address the CO₂ emission objectives of the Copenhagen Agreement and the Kyoto Protocol—and extensive cultivation of algae could play a central role in that process.

Acknowledgments

This work received partial funding from project MICROPHYTE (ref. PTDC/EBB-EBI/102728/2008), coordinated by author F. Xavier Malcata and under the auspices of ESF (III Quadro Comunitário de Apoio) and the Portuguese State.

A postdoctoral fellowship (ref. SFRH/BPD/72777/2010), supervised by author F. Xavier Malcata and cosupervised by author Isabel Sousa-Pinto, was granted to author A. Catarina Guedes, also under the auspices of ESF. A Ph.D. fellowship (ref. SFRH/BD/62121/2009), further supervised by author F. Xavier Malcata and cosupervised by author Isabel Sousa-Pinto, was granted to author Helena M. Amaro, again under the auspices of ESF.

References

- Abuadala, A., Dincer, I., et al., 2010. Exergy analysis of hydrogen production from biomass gasification. *Int. J. Hydrogen Energ.* 35 (10), 4981–4990.
- Amano, H., Kakinuma, M., et al., 2005. Effect of a seaweed mixture on serum lipid level and platelet aggregation in rats. *Fisheries Sci.* 71 (5), 1160–1166.
- Amaro, H.M., Guedes, A.C., et al., 2011. Advances and perspectives in using microalgae to produce biodiesel. *Appl. Energy* 88 (10), 3402–3410.
- Aneiros, A., Garateix, A., 2004. Bioactive peptides from marine sources: pharmacological properties and isolation procedures. *J. Chromatogr. B* 803 (1), 41–53.
- Arasaki, S., Arasaki, T., 1983. *Vegetables from the Sea: low calorie, high nutrition to help you look and feel better.* Tokyo: Japan Publications, Japan.
- Astorg, P., 1997. Food carotenoids and cancer prevention: An overview of current research. *Trends in Food Sci. Technol.* 8 (12), 406–413.
- Athukorala, Y., Lee, K.W., et al., 2007. Anticoagulant activity of marine green and brown algae collected from Jeju Island in Korea. *Bioresour. Technol.* 98 (9), 1711–1716.
- Babadzhanov, A.S., Abdusamatova, N., et al., 2004. Chemical composition of *Spirulina platensis* cultivated in Uzbekistan. *Chem. Nat. Compd.* 40 (3), 276–279.
- Bannister, J., O'Neill, P., et al., 1985. *Free Radicals in Biology and Medicine.* Harwood Academic Publishers, London, England.
- Benvegna, T., Sassi, J.F., 2010. Oligomannuronates from seaweeds as renewable sources for the development of green surfactants. In: Rauter, A.P., Vogel, P., Queneau, Y. (Eds.), *Carbohydrates in Sustainable Development*, vol. 294. Springer Berlin Heidelberg, pp. 143–164.
- Bermejo Román, R., Álvarez-Pez, J.M., et al., 2002. Recovery of pure B-phycoerythrin from the microalga *Porphyridium cruentum*. *J. Biotechnol.* 93 (1), 73–85.
- Billar, P., Ross, A.B., 2011. Potential yields and properties of oil from the hydrothermal liquefaction of microalgae with different biochemical content. *Bioresour. Technol.* 102 (1), 215–225.
- Bird, K., Chiles, T., et al., 1993. Agglutinins from marine macroalgae of the southeastern United States. *J. Appl. Phycol.* 5 (2), 213–218.
- Bitencourt, F.S., Figueiredo, J.G., et al., 2008. Antinociceptive and anti-inflammatory effects of a mucin-binding agglutinin isolated from the red marine alga *Hypnea cervicornis*. *Naunyn Schmiedebergs Arch. Pharmacol.* 377 (2), 139–148.

- Bozbas, K., 2008. Biodiesel as an alternative motor fuel: Production and policies in the European Union. *Renew. Sustain. Energy Rev.* 12 (2), 542–552.
- Brányiková, I., Maršálková, B., et al., 2011. Microalgae—novel highly efficient starch producers. *Biotechnol. Bioeng.* 108 (4), 766–776.
- Brito, M., Cueto, A.R., et al., 2002. Oxachamigrenes, new halogenated sesquiterpenes from *Laurencia obtusa*. *J. Nat. Prod.* 65 (6), 946–948.
- Butler, A., Carter-Franklin, J.N., 2004. The role of vanadium bromoperoxidase in the biosynthesis of halogenated marine natural products. *ChemInform.* 35 (17), no-no.
- Cardozo, K.H.M., Guaratini, T., et al., 2007. Metabolites from algae with economical impact. *Comp. Biochem. Physiol. C Toxicol. Pharmacol.* 146 (1–2), 60–78.
- Carlsson, A.S., 2007. *Micro- and Macro-algae: Utility for Industrial Applications: Outputs from the EPOBIO Project*. CPL Press, Newbury, UK.
- Cérantola, S., Brevet, F., et al., 2006. Co-occurrence and antioxidant activities of fucol and fucophlorethol classes of polymeric phenols in *Fucus spiralis*. *Bot. Mar.* 49 (4), 347.
- Chandini, S.K., Ganesan, P., et al., 2008. *In vitro* antioxidant activities of three selected brown seaweeds of India. *Food Chem.* 107 (2), 707–713.
- Christenson, L., Sims, R., 2011. Production and harvesting of microalgae for wastewater treatment, biofuels, and bioproducts. *Biotechnol. Adv.* 29 (6), 686–702.
- Chronakis, I.S., Galatanu, A.N., et al., 2000. The behaviour of protein preparations from blue-green algae (*Spirulina platensis* strain Pacifica) at the air/water interface. *Colloid Surface A* 173 (1–3), 181–192.
- Cordell, D., Drangert, J.O., et al., 2009. The story of phosphorus: Global food security and food for thought. *Global Environ. Chang.* 19 (2), 292–305.
- Dawczynski, C., Schubert, R., et al., 2007. Amino acids, fatty acids, and dietary fibre in edible seaweed products. *Food Chem.* 103 (3), 891–899.
- de Mulé, M.C.Z., de Caire, G.Z., et al., 1999. Effect of cyanobacterial inoculation and fertilizers on rice seedlings and postharvest soil structure. *Commun. Soil Sci. Plant Anal.* 30 (1–2), 97–107.
- DeFelice, S.L., 1995. The nutraceutical revolution: its impact on food industry R&D. *Trends in Food Sci. Technol.* 6 (2), 59–61.
- Dembitsky, V.M., Rozentsvet, O.A., 1990. Phospholipid composition of some marine red algae. *Phytochemistry* 29 (10), 3149–3152.
- Dragone, G., Fernandes, B.D., et al., 2011. Nutrient limitation as a strategy for increasing starch accumulation in microalgae. *Appl. Energy* 88 (10), 3331–3335.
- Du, Z., Li, Y., et al., 2011. Microwave-assisted pyrolysis of microalgae for biofuel production. *Bioresour. Technol.* 102 (7), 4890–4896.
- Ekman, A.L.S., Bulow, L., et al., 2007. Elevated atmospheric CO₂ concentration and diurnal cycle induce changes in lipid composition in *Arabidopsis thaliana*. *New Phytol.* 174 (3), 591–599.
- Ennamany, R., Saboureau, D., et al., 1998. SECMA 1 (R), a mitogenic hexapeptide from *Ulva* algae modulates the production of proteoglycans and glycosaminoglycans in human foreskin fibroblast. *Hum. Exp. Toxicol.* 17 (1), 18–22.
- Erdmann, K., Cheung, B.W.Y., et al., 2008. The possible roles of food-derived bioactive peptides in reducing the risk of cardiovascular disease. *J. Nutr. Biochem.* 19 (10), 643–654.
- Fabregas, J., García, D., et al., 1999. *In vitro* inhibition of the replication of haemorrhagic septicaemia virus (VHSV) and African swine fever virus (ASFV) by extracts from marine microalgae. *Antiviral Res.* 44 (1), 67–73.
- Fennema, O.R., 1996. *Food Chemistry*. Marcel Dekker, New York, NY, USA.
- Fleurence, J., 1999. Seaweed proteins: biochemical, nutritional aspects and potential uses. *Trends in Food Sci. Technol.* 10 (1), 25–28.
- Fuller, R.W., Cardellina, J.H., et al., 1992. A pentahalogenated monoterpene from the red alga *Portieria hornemannii* produces a novel cytotoxicity profile against a diverse panel of human tumor cell lines. *J. Med. Chem.* 35 (16), 3007–3011.
- Galland-Irmouli, A.V., Fleurence, J., et al., 1999. Nutritional value of proteins from edible seaweed *Palmaria palmata* (dulse). *J. Nutr. Biochem.* 10 (6), 353–359.
- Garbisa, S., Sartor, L., et al., 2001. Tumor gelatinases and invasion inhibited by the green tea flavanol epigallocatechin-3-gallate. *Cancer* 91 (4), 822–832.
- Garson, M.J., 1993. The biosynthesis of marine natural products. *Chem. Rev.* 93 (5), 1699–1733.

- Goh, C.S., Lee, K.T., 2010. A visionary and conceptual macroalgae-based third-generation bioethanol (TGB) biorefinery in Sabah, Malaysia as an underlay for renewable and sustainable development. *Renew. Sustain. Energy Rev.* 14 (2), 842–848.
- Greenwell, H.C., Laurens, L.M.L., et al., 2010. Placing microalgae on the biofuels priority list: a review of the technological challenges. *J. R. Soc. Interface* 7 (46), 703–726.
- Grierson, S., Strezov, V., et al., 2009. Thermal characterisation of microalgae under slow pyrolysis conditions. *J. Anal. Appl. Pyrol.* 85 (1–2), 118–123.
- Guedes, A.C., Amaro, H.M., et al., 2011a. Fatty acid composition of several wild microalgae and cyanobacteria, with a focus on eicosapentaenoic, docosahexaenoic and α -linolenic acids for eventual dietary uses. *Food Res. Int.* 44 (9), 2721–2729.
- Guedes, A.C., Amaro, H.M., et al., 2011b. Microalgae as sources of high added-value compounds—a brief review of recent work. *Biotechnol. Prog.* 27 (3), 597–613.
- Guedes, A.C., Amaro, H.M., et al., 2011c. Microalgae as sources of carotenoids. *Mar. Drugs* 9 (4), 625–644.
- Guedes, A.C., Malcata, F.X., 2012. Chapter 4- Nutritional value and uses of microalgae in aquaculture. In: Muchlisin, Z.A. (Ed.), *Aquaculture*. InTech. ISBN: 978-953-307-974-5. Available from: <http://www.intechopen.com/articles/show/title/nutritional-value-and-uses-of-microalgae-in-aquaculture>.
- Guil-Guerrero, J.L., Navarro-Juárez, R., et al., 2004. Functional properties of the biomass of three microalgal species. *J. Food Eng.* 65 (4), 511–517.
- Guzmán, S., Gato, A., et al., 2001. Antiinflammatory, analgesic and free radical scavenging activities of the marine microalgae *Chlorella stigmatophora* and *Phaeodactylum tricornutum*. *Phytother. Res.* 15 (3), 224–230.
- Haugan, J.A., Liaen-Jensen, S., 1994. Algal carotenoids 54. Carotenoids of brown algae (Phaeophyceae). *Biochem. Syst. Ecol.* 22 (1), 31–41.
- Heilmann, S.M., Jader, L.R., et al., 2011. Hydrothermal carbonization of microalgae II. Fatty acid, char, and algal nutrient products. *Appl. Energy* 88 (10), 3286–3290.
- Holdt, S., Kraan, S., 2011. Bioactive compounds in seaweed: functional food applications and legislation. *J. Appl. Phycol.* 23 (3), 543–597.
- Hosikian, A., Lim, S., et al., 2010. Chlorophyll extraction from microalgae: a review on the process engineering aspects. *Int. J. Chem. Eng.* 2010, 1–11.
- Houston, M.C., 2005. Nutraceuticals, vitamins, antioxidants, and minerals in the prevention and treatment of hypertension. *Prog. Cardiovasc. Dis.* 47 (6), 396–449.
- Hu, Q., Sommerfeld, M., et al., 2008. Microalgal triacylglycerols as feedstocks for biofuel production: perspectives and advances. *Plant. J.* 54 (4), 621–639.
- Huang, H.L., Wang, B.G., 2004. Antioxidant capacity and lipophilic content of seaweeds collected from the Qingdao coastline. *J. Agric. Food Chem.* 52 (16), 4993–4997.
- Ishihara, M., Murata, M., et al., 1998. Inhibition of icosanoid production in MC/9 mouse mast cells by n-3 polyunsaturated fatty acids isolated from edible marine algae. *Biosci. Biotechnol. Biochem.* 62 (7), 1412–1415.
- Jena, U., Vaidyanathan, N., et al., 2011. Evaluation of microalgae cultivation using recovered aqueous co-product from thermochemical liquefaction of algal biomass. *Bioresour. Technol.* 102 (3), 3380–3387.
- Jian-Feng, N., Guang-Ce, W., et al., 2006. Method for large-scale isolation and purification of R-phycoerythrin from red alga *Polysiphonia urceolata* Grev. *Protein Expr. Purif.* 49 (1), 23–31.
- John, R.P., Anisha, G.S., et al., 2011. Micro and macroalgal biomass: a renewable source for bioethanol. *Bioresour. Technol.* 102 (1), 186–193.
- Jones, C.S., Mayfield, S.P., 2012. Algae biofuels: versatility for the future of bioenergy. *Curr. Opin. Biotechnol.* 23 (3), 346–351.
- Kang, K., Park, Y., et al., 2003. Antioxidative properties of brown algae polyphenolics and their perspectives as chemopreventive agents against vascular risk factors. *Arch. Pharm. Res.* 26 (4), 286–293.
- Kim, I.H., Lee, J.H., 2008. Antimicrobial activities against methicillin-resistant *Staphylococcus aureus* from macroalgae. *J. Ind. Eng. Chem.* 14 (5), 568–572.
- Kim, S.K., Wijesekara, I., 2010. Development and biological activities of marine-derived bioactive peptides: A review. *J. Functional Foods* 2 (1), 1–9.
- Kohen, R., Nyska, A., 2002. Invited review: oxidation of biological systems: oxidative stress phenomena, antioxidants, redox reactions, and methods for their quantification. *Toxicol. Pathol.* 30 (6), 620–650.
- Krinsky, N.I., Johnson, E.J., 2005. Carotenoid actions and their relation to health and disease. *Mol. Aspects Med.* 26 (6), 459–516.

- Kruse, O., Hankamer, B., 2010. Microalgal hydrogen production. *Curr. Opin. Biotechnol.* 21 (3), 238–243.
- Kruse, O., Rupprecht, J., et al., 2005. Improved photobiological H₂ production in engineered green algal cells. *J. Biol. Chem.* 280 (40), 34170–34177.
- Kumar, C.S., Ganesan, P., et al., 2008. Seaweeds as a source of nutritionally beneficial compounds: A review. *J. Food Sci. Technol. Mysore* 45 (1), 1–13.
- Lamers, P.P., Janssen, M., et al., 2008. Exploring and exploiting carotenoid accumulation in *Dunaliella salina* for cell-factory applications. *Trends Biotechnol.* 26 (11), 631–638.
- Lee, K., Hayashi, M., 2004. Novel antiviral fucoidan from sporophyll of *Undaria pinnatifida* (Mekabu). *Chem. Pharm. Bull. (Tokyo)* 52 (9), 1091–1094.
- Li, K., Li, X.M., et al., 2007. Natural bromophenols from the marine red alga *Polysiphonia urceolata* (Rhodomelaceae): Structural elucidation and DPPH radical-scavenging activity. *Bioorg. Med. Chem.* 15 (21), 6627–6631.
- Li, N., Zhang, Q., et al., 2005. Toxicological evaluation of fucoidan extracted from *Laminaria japonica* in Wistar rats. *Food Chem. Toxicol.* 43 (3), 421–426.
- Li, Y., Qian, Z.J., et al., 2009. Chemical components and its antioxidant properties in vitro: An edible marine brown alga, *Ecklonia cava*. *Bioorg. Med. Chem.* 17 (5), 1963–1973.
- Liam, B., Anika, M., et al., 2012. Phytochemicals from algae. In: *Biorefinery Co-Products: Phytochemicals, Primary Metabolites and Value-Added Biomass Processing*. John Wiley & Sons, Ltd, Chichester, UK. <http://dx.doi.org/10.1002/9780470976692.ch10>.
- Liao, W.R., Lin, J.Y., et al., 2003. Antibiotic activity of lectins from marine algae against marine vibrios. *J. Ind. Microbiol. Biotechnol.* 30 (7), 433–439.
- Lim, S.N., Cheung, P.C.K., et al., 2002. Evaluation of antioxidative ctivity of extracts from a brown seaweed. *Sargassum siliquastrum*. *J. Agric Food Chem.* 50 (13), 3862–3866.
- Liqun, Y., Pengcheng, L., et al., 2008. The extraction of pigments from fresh *Laminaria japonica*. *Chin. J. Oceano. Limn.* 26 (2), 193–196.
- Lobban, C.S., Harrison, P.J., 1994. *Seaweed Ecology and Physiology*. Cambridge University Press, New York, NY, USA.
- Lorenz, R.T., Cysewski, G.R., 2000. Commercial potential for *Haematococcus* microalgae as a natural source of astaxanthin. *Trends Biotechnol.* 18 (4), 160–167.
- Lovell, R.T., 2003. Diet and Fish Husbandry. *Fish Nutrition*. In: John, E.H., Ronald, W.H. (Eds.), Academic Press, San Diego, CA, USA, pp. 703–754.
- Mabeau, S., Fleurence, J., 1993. Seaweed in food products: biochemical and nutritional aspects. *Trends in Food Sci. Technol.* 4 (4), 103–107.
- Mahugo Santana, C., Sosa Ferrera, Z., et al., 2009. Methodologies for the extraction of phenolic compounds from environmental samples: new approaches. *Molecules* 14 (1), 298–320.
- Maliakal, P.P., Coville, P.F., et al., 2001. Tea consumption modulates hepatic drug metabolizing enzymes in Wistar rats. *J. Pharm. Pharmacol.* 53 (4), 569–577.
- Mata, T.M., Martins, A.A., et al., 2010. Microalgae for biodiesel production and other applications: A review. *Renew. Sustain. Energy Rev.* 14 (1), 217–232.
- Matsui, M., Muizzuddin, N., et al., 2003. Sulfated polysaccharides from red microalgae have antiinflammatory properties *in vitro* and *in vivo*. *Appl. Biochem. Biotechnol.* 104 (1), 13–22.
- Matsui, T.O., Nishihara, A., et al., 1997. Liquefaction of micro-algae with iron catalyst. *Fuel* 76 (11), 1043–1048.
- Mayer, A.D., Rodriguez, R.G.S., et al., 2007. Marine pharmacology in 2003–4: marine compounds with anthelmintic antibacterial, anticoagulant, antifungal, anti-inflammatory, antimalarial, antiplatelet, antiprotozoal, antituberculosis, and antiviral activities; affecting the cardiovascular, immune and nervous systems, and other miscellaneous mechanisms of action. *Comp. Biochem. Physiol. C. Toxicol. Pharmacol.* 145 (4), 553–581.
- McHugh, D.J., Food, et al., 2003. A guide to the seaweed industry. Food and Agriculture Organization of the United Nations.
- Miao, X., Wu, Q., et al., 2004. Fast pyrolysis of microalgae to produce renewable fuels. *J. Anal. Appl. Pyrol.* 71 (2), 855–863.
- Militante, J.D., Lombardini, J.B., 2002. Treatment of hypertension with oral taurine: experimental and clinical studies. *Amino Acids* 23 (4), 381–393.
- Minowa, T., Yokoyama, S.y., 1995. Oil production from algal cells of *Dunaliella tertiolecta* by direct thermochemical liquefaction. *Fuel* 74 (12), 1735–1738.
- Mochizuki, H., Takido, J., et al., 1999. Improving effect of dietary taurine on marked hypercholesterolemia induced by a high-cholesterol diet in streptozotocin-induced diabetic rats. *Biosci. Biotechnol. Biochem.* 63 (11), 1984–1987.

- Mohan, D., Pittman, C.U., et al., 2006. Pyrolysis of Wood/Biomass for Bio-oil: A Critical Review. *Energ. Fuel.* 20 (3), 848–889.
- Mojaat, M., Pruvost, J., et al., 2008. Effect of organic carbon sources and Fe²⁺ ions on growth and β-carotene accumulation by *Dunaliella salina*. *Biochem. Eng. J.* 39 (1), 177–184.
- Mori, T., O'Keefe, B.R., et al., 2005. Isolation and characterization of griffithsin, a novel HIV-inactivating protein, from the red alga *Griffithsia* sp. *J. Biol. Chem.* 280 (10), 9345–9353.
- Morist, A., Montesinos, J.L., et al., 2001. Recovery and treatment of *Spirulina platensis* cells cultured in a continuous photobioreactor to be used as food. *Process Biochem.* 37 (5), 535–547.
- Morrissey, J., Kraan, S., et al., 2001. A guide to commercially important seaweeds on the Irish coast. Bord Iascaigh Mhara/Irish Sea Fisheries Board, Dun Laoghaire, Co, Dublin, Ireland.
- Murata, M., Nakazoe, J., 2001. Production and use of marine algae in Japan. *Jarq. Jpn. Agr. Res. Q.* 35 (4), 281–290.
- Mursito, A.T., Hirajima, T., et al., 2010. Upgrading and dewatering of raw tropical peat by hydrothermal treatment. *Fuel* 89 (3), 635–641.
- Nagayama, K., Shibata, T., et al., 2003. Algicidal effect of phlorotannins from the brown alga *Ecklonia kurome* on red tide microalgae. *Aquaculture* 218 (1–4), 601–611.
- Nishide, E., Anzai, H., et al., 1993. Effects of alginates on the ingestion and excretion of cholesterol in the rat. *J. Appl. Phycol.* 5 (2), 207–211.
- Nishizawa, K., 2002. Seaweeds kaiso: bountiful harvest from the seas: sustenance for health & well being by preventing common life-style related diseases. Japan Seaweed Association, Kochi, Japan.
- Ohta, S., Chang, T., et al., 1993. Antibiotic substance produced by a newly isolated marine microalga *Chlorococcum* HS-101. *Bull. Environ. Contam. Toxicol.* 50 (2), 171–178.
- Onofrejevá, L., Vašíčková, J., et al., 2010. Bioactive phenols in algae: the application of pressurized-liquid and solid-phase extraction techniques. *J. Pharm. Biomed. Anal.* 51 (2), 464–470.
- Packer, M., 2009. Algal capture of carbon dioxide; biomass generation as a tool for greenhouse gas mitigation with reference to New Zealand energy strategy and policy. *Energ. Policy* 37 (9), 3428–3437.
- Parsons, A.F., 1996. ChemInform abstract: recent developments in kainoid amino acid chemistry. *ChemInform* 27 (28), 4149–4174.
- Pihlanto-Leppälä, A., 2000. Bioactive peptides derived from bovine whey proteins: opioid and ace-inhibitory peptides. *Trends in Food Sci. Technol.* 11 (9–10), 347–356.
- Plaza, M., Cifuentes, A., et al., 2008. In the search of new functional food ingredients from algae. *Trends in Food Sci. Technol.* 19 (1), 31–39.
- Plaza, M., Herrero, M., et al., 2009. Innovative natural functional ingredients from microalgae. *J. Agric. Food Chem.* 57 (16), 7159–7170.
- Pourmortazavi, S.M., Hajimirsadeghi, S.S., 2007. Supercritical fluid extraction in plant essential and volatile oil analysis. *J. Chromatogr. A* 1163 (1–2), 2–24.
- Pulz, O., Gross, W., 2004. Valuable products from biotechnology of microalgae. *Appl. Microbiol. Biotechnol.* 65 (6), 635–648.
- Radmer, R.J., 1996. Algal diversity and commercial algal products. *Bioscience* 46 (4), 263.
- Raja, R., Hemaiswarya, S., et al., 2008. A Perspective on the Biotechnological Potential of Microalgae. *Crit. Rev. Microbiol.* 34 (2), 77–88.
- Rasmussen, R.S., Morrissey, M.T., 2007. Marine biotechnology for production of food ingredients Vol. 52. *Advances in Food and Nutrition Research*. L. T. Steve, Academic Press.
- Ross, A.B., Biller, P., et al., 2010. Hydrothermal processing of microalgae using alkali and organic acids. *Fuel* 89 (9), 2234–2243.
- Rupérez, P., Ahrazem, O., et al., 2002. Potential antioxidant capacity of sulfated polysaccharides from the edible marine brown seaweed *Fucus vesiculosus*. *J. Agric. Food Chem.* 50 (4), 840–845.
- Samarakoon, K., Jeon, Y.J., 2012. Bio-functionalities of proteins derived from marine algae: A review. *Food Res. Int.* 48 (2), 948–960.
- Sampath-Wiley, P., Neefus, C.D., et al., 2008. Seasonal effects of sun exposure and emersion on intertidal seaweed physiology: Fluctuations in antioxidant contents, photosynthetic pigments and photosynthetic efficiency in the red alga *Porphyra umbilicalis* Kützing (Rhodophyta, Bangiales). *J. Exp. Mar. Biol. Ecol.* 361 (2), 83–91.
- Sánchez-Machado, D.I., López-Hernández, J., et al., 2004. An HPLC method for the quantification of sterols in edible seaweeds. *Biomed. Chromatogr.* 18 (3), 183–190.

- Sato, M., Hosokawa, T., et al., 2002. Angiotensin I-converting enzyme inhibitory peptides derived from wakame (*Undaria pinnatifida*) and their antihypertensive effect in spontaneously hypertensive rats. *J. Agric. Food Chem.* 50 (21), 6245–6252.
- Schwartz, D., Krienitz, L., 2005. Do algae cause growth-promoting effects on vegetables grown hydroponically? In: Price, M.R. (Ed.), *Fertigation: Optimizing the utilization of water and nutrients*. International Potash Institute, Beijing, China, pp. 161–170.
- Sekar, S., Chandramohan, M., 2008. Phycobiliproteins as a commodity: trends in applied research, patents and commercialization. *J. Appl. Phycology* 20 (2), 113–136.
- Shirvani, T., Yan, X., et al., 2011. Life cycle energy and greenhouse gas analysis for algae-derived biodiesel. *Energy Environ. Sci.* 4 (10), 3773–3778.
- Sialve, B., Bernet, N., et al., 2009. Anaerobic digestion of microalgae as a necessary step to make microalgal biodiesel sustainable. *Biotechnol. Adv.* 27 (4), 409–416.
- Simon, C., Alvin, S., et al., 1999. Effect of dietary chlorophyll derivatives on mutagenesis and tumor cell growth. *Teratog Carcinog Mutagen* 19 (5), 313–322.
- Singh, J., Gu, S., 2010. Commercialization potential of microalgae for biofuels production. *Renew. Sustain. Energy Rev.* 14 (9), 2596–2610.
- Smit, A.J., 2004. Medicinal and pharmaceutical uses of seaweed natural products: a review. *J. Appl. Phycol.* 16 (4), 245–262.
- Spolaore, P., Joannis-Cassan, C., et al., 2006. Commercial applications of microalgae. *J. Biosci. Bioeng.* 101 (2), 87–96.
- Stephens, E., Ross, I.L., et al., 2010. An economic and technical evaluation of microalgal biofuels. *Nat. Biotechnol.* 28 (2), 126–128.
- Suali, E., Sarbatly, R., 2012. Conversion of microalgae to biofuel. *Renew. Sustain. Energy Rev.* 16 (6), 4316–4342.
- Suetsuna, K., Maekawa, K., et al., 2004. Antihypertensive effects of *Undaria pinnatifida* (wakame) peptide on blood pressure in spontaneously hypertensive rats. *J. Nutr. Biochem.* 15 (5), 267–272.
- Sugahara, T., Ohama, Y., et al., 2001. The cytotoxic effect of *Eucheuma serra* agglutinin (ESA) on cancer cells and its application to molecular probe for drug delivery system using lipid vesicles. *Cytotechnology* 36 (1), 93–99.
- Sugawara, V., Baskaran, W., et al., 2002. Brown algae fucoxanthin is hydrolyzed to fucoxanthinol during absorption by Caco-2 human intestinal cells and mice. *J. Nutr.* 132 (5), 946–951.
- Suzuki, M., Takahashi, Y., et al., 2002. Brominated metabolites from an Okinawan *Laurencia intricata*. *Phytochemistry* 60 (8), 861–867.
- Thorsen, M., Woodward, S., et al., 2010. Kelp (*Laminaria digitata*) increases germination and affects rooting and plant vigour in crops and native plants from an arable grassland in the Outer Hebrides, Scotland. *J. Coast. Conservat.* 14 (3), 239–247.
- Torri, C., Samori, C., et al., 2011. Preliminary investigation on the production of fuels and biochar from *Chlamydomonas reinhardtii* biomass residue after bio-hydrogen production. *Bioresour. Technol.* 102 (18), 8707–8713.
- Tseng, C.K., 2001. Algal biotechnology industries and research activities in China. *J. Appl. Phycol.* 13 (4), 375–380.
- Umemura, K., Yanase, K., et al., 2003. Inhibition of DNA topoisomerases I and II, and growth inhibition of human cancer cell lines by a marine microalgal polysaccharide. *Biochem. Pharmacol.* 66 (3), 481–487.
- Vairappan, C.S., Suzuki, M., et al., 2001. Halogenated metabolites with antibacterial activity from the Okinawan *Laurencia species*. *Phytochemistry* 58 (3), 517–523.
- Valente, L.M.P., Gouveia, A., et al., 2006. Evaluation of three seaweeds *Gracilaria bursa-pastoris*, *Ulva rigida* and *Gracilaria cornea* as dietary ingredients in European sea bass (*Dicentrarchus labrax*) juveniles. *Aquaculture* 252 (1), 85–91.
- Venugopal, V., 2008. Seaweed hydrocolloids. *Marine Products for Healthcare*. CRC Press pp. 297–338.
- Voet, D., Voet, J.G., et al., 2008. *Fundamentals of Biochemistry: Life at the Molecular Level*, 2nd Edition, John Wiley and Co.
- Wang, J., Feng, L., et al., 2008. Advance in extraction of iodine. *Inorganic Chemicals Industry* 11.
- Wang, Y., Han, F., et al., 2006. *In vivo* prebiotic properties of alginate oligosaccharides prepared through enzymatic hydrolysis of alginate. *Nutr. Res.* 26 (11), 597–603.
- Wargacki, A.J., Leonard, E., et al., 2012. An engineered microbial platform for direct biofuel production from brown macroalgae. *Science* 335 (6066), 308–313.
- Wi, S.G., Kim, H.J., et al., 2009. The potential value of the seaweed *Ceylon moss* (*Gelidium amansii*) as an alternative bioenergy resource. *Bioresour. Technol.* 100 (24), 6658–6660.

- Williams, P.J.I.B., Laurens, L.M.L., 2010. Microalgae as biodiesel & biomass feedstocks: Review & analysis of the biochemistry, energetics & economics. *Energy Environ. Sci.* 3 (5), 554–590.
- Xu, H., Miao, X., et al., 2006. High quality biodiesel production from a microalga *Chlorella protothecoides* by heterotrophic growth in fermenters. *J. Biotechnol.* 126 (4), 499–507.
- Xu, W.J., Liao, X.J., et al., 2008. Isolation, structure determination, and synthesis of galaxamide, a rare cytotoxic cyclic pentapeptide from a marine algae *Galaxaura filamentosa*. *Org. Lett.* 10 (20), 4569–4572.
- Yan, Y., Chuda, M., et al., 1999. Fucoxanthin as the major antioxidant in *Hijikia fusiformis*, a common edible seaweed. *Biosci. Biotechnol. Biochem.* 63 (3), 605–607.
- Yang, Y.F., Feng, C.P., et al., 2004. Analysis of energy conversion characteristics in liquefaction of algae. *Resour. Conserv. Recy.* 43 (1), 21–33.
- Yang, Z., Guo, R., et al., 2011. Fermentative hydrogen production from lipid-extracted microalgal biomass residues. *Appl. Energy* 88 (10), 3468–3472.
- Ye, H., Wang, K., et al., 2008. Purification, antitumor and antioxidant activities in vitro of polysaccharides from the brown seaweed *Sargassum pallidum*. *Food Chem.* 111 (2), 428–432.
- Yim, S.J., Kim, S.H., et al., 2004. Antiviral effects of sulfated exopolysaccharide from the marine microalga *Gyrodinium impudicum* strain KG03. *Mar. Biotechnol.* 6 (1), 17–25.
- Yong, L., Zhong-Ji, Q., et al., 2008. Bioactive phloroglucinol derivatives isolated from an edible marine brown alga, *Ecklonia cava*. *J. Biotechnol.* 136, S578–S578.
- Yuan, Y.V., Carrington, M.F., et al., 2005. Extracts from dulse (*Palmaria palmata*) are effective antioxidants and inhibitors of cell proliferation *in vitro*. *Food Chem. Toxicol.* 43 (7), 1073–1081.
- Yuan, Y.V., Walsh, N.A., 2006. Antioxidant and antiproliferative activities of extracts from a variety of edible seaweeds. *Food Chem. Toxicol.* 44 (7), 1144–1150.
- Zhang, J., Tiller, C., et al., 2007. Antidiabetic properties of polysaccharide- and polyphenolic-enriched fractions from the brown seaweed *Ascophyllum nodosum*. *Can. J. Physiol. Pharmacol.* 85 (11), 1116–1123.
- Zhang, Q.B., Li, N., et al., 2003. *In vivo* antioxidant activity of polysaccharide fraction from *Porphyra haitanensis* (Rhodophyta) in aging mice. *Pharmacol. Res.* 48 (2), 151–155.
- Zhao, X., Xue, C.H., et al., 2008. Study of antioxidant activities of sulfated polysaccharides from *Laminaria japonica*. *J. Appl. Phycol.* 20 (4), 431–436.
- Zou, S., Wu, Y., et al., 2010. Bio-oil production from sub- and supercritical water liquefaction of microalgae *Dunaliella tertiolecta* and related properties. *Energy Environ. Sci.* 3 (8), 1073–1078.
- Zou, Y., Qian, Z.J., et al., 2008. Antioxidant effects of phlorotannins isolated from *Ishige okamurae* in free radical mediated oxidative systems. *J. Agric. Food Chem.* 56 (16), 7001–7009.
- Zubia, M., Payri, C., et al., 2008. Alginate, mannitol, phenolic compounds and biological activities of two range-extending brown algae, *Sargassum mangarevense* and *Turbinaria ornata* (Phaeophyta: Fucales), from Tahiti (French Polynesia). *J. Appl. Phycol.* 20 (6), 1033–1043.

Intentionally left as blank

Hydrothermal Upgradation of Algae into Value-added Hydrocarbons

Rawel Singh, Thallada Bhaskar, Bhavya Balagurumurthy

Biofuels Division, CSIR-Indian Institute of Petroleum, Dehradun, India

11.1 INTRODUCTION

Concerns over energy supply security, global climate change as well as local air pollution, and the increasing price of energy services are having a growing impact on policy making throughout the world. Today's energy and transport system, which is based mainly on fossil energy carriers, can in no way be evaluated as sustainable. The search for a sustainable and environment-friendly source of hydrocarbons is the need of the hour. Research efforts directed toward the conversion of biomass into a liquid transportation fuel have their origins in the first U.S. energy crisis of October 1973, a consequence of the Yom Kippur War and the Organization of Petroleum Exporting Countries (OPEC) oil embargo. Subsequently, the 1979 Iranian revolution and more recent concerns about the security of imported petroleum and the contribution of carbon dioxide (CO₂) emissions to global warming trends have led to renewed efforts to provide an essentially CO₂-neutral supply of transportation fuel (Blanch, 2012).

It has been long expected that biofuels and biorefineries can at least partially mitigate these problems and create more sustainable and balanced economies. To date three generations of biofuels have been developed. The first-generation biofuels were made from edible feedstock such as corn, soybean, sugarcane, and rapeseed. Biofuel production from these resources was, rightfully or not, blamed for the subsequent surge in food prices. Second-generation biofuels produced from waste lignocellulosic biomass and dedicated lignocellulosic feedstock such as miscanthus, switchgrass, or poplar have advantages over those of the first generation. The main advantages are higher yields and lower land requirement (in both quality and quantity).

The concept of using algae to make fuels was already being discussed 50 years ago (Oswald and Golueke, 1960), but a concerted effort began with the oil crisis of the 1970s. Large research

programs in Japan and the United States focused on developing microalgal energy production systems. Third-generation biofuel feedstock, micro-, and macroalgae can have an edge over the previous two generations. These marine organisms show the prospect of high biomass yields without requiring any arable land and have the potential to be cultivated in containment off-shore (Trent, 2012). Moreover, some algal species grow well in saline, brackish, and waste water, which makes them more promising feedstock than terrestrial crops that rely exclusively on fresh water. These features, along with successful methods for large-scale algae cultivation and processing, can make third-generation feedstock superior to that of previous generations (Daroch et al., 2012).

The typical differences between lignocellulosic biomass and algal biomass are depicted in Figure 11.1. The transition from first- and second-generation to third-generation biofuels offers a reduction in land requirements. This is due to higher energy yields per hectare as we move along this transition as well as utilization of nonagricultural land (Fenton and Ó hUallacháin, 2012). In addition, algae do not deplete any soil nutrients that could aid agriculture. Green and blue-green (cyanobacteria) microalgae have been on Earth for millions of years and differ substantially from higher plants. They are single-celled microorganisms that live in aquatic environments, and all components necessary for life and procreation are located within a single cell. In higher terrestrial plants, specialized cells with specific functions are required, making up roots, stems, flowers, and other functional parts. Cellulose, hemicellulose, and lignin often provide structural support for these specialized cells and are present in significant quantities. In contrast, microalgae and cyanobacteria are not lignocellulosic in

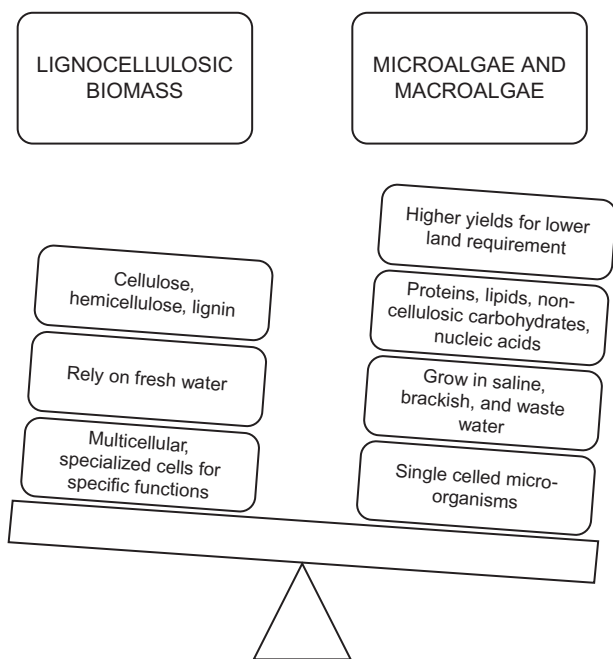

FIGURE 11.1 Differences between lignocellulosic biomass and algae.

composition but are composed of proteins, lipids, noncellulosic carbohydrates, and nucleic acids (Heilmann et al., 2010).

Today, efforts are being made to maximize the productivity of biomass and identify new species of plants and processes to fulfill future demands for food, fodder, materials, and energy. The utilization of algae is seen as one of the possible alternatives (Kröger and Müller-Langer, 2012). Algae are a feedstock that has certain advantages over land-based feedstock. Under favorable conditions, the growth rate of algae is estimated to be 5–10 times higher than land-based crops, implying a higher production rate of theoretically convertible biomass. Additionally, certain species may have a high fraction of lipids or carbohydrates of up to 70–80 wt% (Chisti, 2007). There are several reasons for the high production rate. One of them is the higher photosynthetic efficiency.

Many commercial efforts are underway to maximize economic return and improve energy balances in algal cultivation. Currently, much work is focused on extracting high-value chemicals (e.g., nutraceuticals) and energy-dense lipids (e.g., for biodiesel) from algae, but this still leaves behind a large residual of “defatted” biomass. Effective utilization of defatted algal biomass will be necessary to achieve favorable energy balances and production costs (Pan et al., 2010).

The use of macroalgae for energy production has received less attention for the production of fuels/chemicals, despite the fact that macroalgae have long been cultivated for several purposes (food production, chemical extraction) in China, Korea, the Philippines, and Japan. The productivity is in the range of 1–15 kg m⁻² y⁻¹ dry weight (10–150 t_{dw} ha⁻¹ y⁻¹) for a seven- to eight-month culture. Either brown algae (*Laminaria*, *Sargassum*) or red algae have been used so far for such purposes (Aresta et al., 2003).

11.2 ALGAL BIOMASS

The term *algae* can refer to microalgae, cyanobacteria (the so-called “blue-green algae”), and macroalgae (or seaweed). As a first approximation, the composition of algal biomass is similar to that of conventional plant biomass, with both containing primarily lipids, carbohydrates, and protein. However, unlike conventional plant crops, algae lack the structural component lignin. This can be viewed as advantageous in the separation of more valuable carbohydrates from less valuable lignin, which is often complicated and resource intensive. Also, algae are commonly cultured under dilute conditions, and whereas this results in the need for extensive dewatering, it also allows for growth conditions to be tweaked to meet market demands in real time (Foley et al., 2011).

Unlike plants that contain predominantly cellulose I β (monoclinic crystalline form), algal cells contain cellulose I α (triclinic crystalline form) (Hayashi et al., 1997; Atalla and Van der Hart, 1984). The latter form contains weaker hydrogen bonding resulting from spatial arrangement of individual cellulose chains with respect to one another. Carbohydrate profiles of algae and terrestrial plants also differ significantly. Both groups contain hemicelluloses—heterogeneous polysaccharide composed of pentoses, mainly xylose, that can be utilized for fermentative bioethanol production. In addition, algae contain various contents of other heteropolysaccharides that are largely species-dependent. Red seaweeds, for example, are

mainly composed of polymers of modified galactose: carrageenan and agar. The major cell wall component of red algae *K. alvarezii* is j-carrageenan (Khambhaty et al., 2012; Meinita et al., 2012), a linear, sulphated polysaccharide composed of galactose that cannot be directly metabolized to ethanol. Another rhodophyte, *Gelidium amansii*, is predominantly composed of agar (Kim et al., 2011), a polysaccharide composed of D- and L-galactose derivatives. Brown algae of *Laminaria sp.* (Adams et al., 2009; Horn et al., 2000; Kim et al., 2011), on the other hand, are rich in mannitol and contain large quantities of laminaran, a polysaccharide composed of 1,3 linked and 1,6 linked glucopyranose units terminated with D-mannitol. These sugars and sugar alcohols could be an additional pool of carbohydrates when combined with an appropriate conversion scheme. Besides these heteropolysaccharides, both micro- and macroalgae store their reserves as starch. The highest contents of starch were reported for microalgae *C. reinhardtii* UTEX90 (Choi et al., 2010; Nguyen et al., 2009) and reached as much as 35–45% of dry cellular weight (Daroch et al., 2012).

In addition to fungible biofuels, a variety of biofuels and products can be generated using algae precursors. There are several aspects of algal biofuel production that have combined to capture the interest of researchers and entrepreneurs around the world: (1) high per-acre productivity, (2) nonfood-based feedstock resources, (3) use of nonproductive, nonarable land, (4) utilization of a wide variety of water sources (fresh, brackish, saline, marine, produced, and waste water), (5) production of both biofuels and valuable coproducts, and (6) potential recycling of CO₂ and other nutrient waste streams (Varfolomeev and Wasserman, 2011).

11.2.1 Microalgae/Defatted Microalgae

Microalgae are microscopic photosynthetic organisms that are found in both marine and freshwater environments. Their photosynthetic mechanism is similar to that of land-based plants, but due to a simple cellular structure and submerged in an aqueous environment where they have efficient access to water, CO₂, and other nutrients, they are generally more efficient in converting solar energy into biomass. These organisms constitute a polyphyletic and highly diverse group of prokaryotic (two divisions) and eukaryotic (nine divisions) organisms. The classification into divisions is based on various properties such as pigmentation, the chemical nature of the photosynthetic storage product, the organization of photosynthetic membranes, and other morphological features. The most frequently used microalgae are *Cyanophyceae* (blue-green algae), *Chlorophyceae* (green algae), *Bacillariophyceae* (including the diatoms), and *Chrysophyceae* (including golden algae). Many microalgae species are able to switch from phototrophic to heterotrophic growth. As heterotrophs, the algae rely on glucose or other utilizable carbon sources for carbon metabolism and energy. Some algae can also grow mixotrophically (Carlsson et al., 2007).

Microalgae have the following advantages over crops as a source of biomass. They are more effective biological systems for converting sun power into organic compounds; microalgae, like bryophytes, have no complex reproductive system; it is possible to induce in many microalgae species generation of valuable proteins, hydrocarbons, lipids, and pigments in extremely high concentrations; they are organisms that have a simple cycle of cell pressure; and they can be grown in various water areas (Vonshak, 1990).

11.2.2 Production Systems

Today there are three main types of system for the production of microalgae. These systems are open cultivators (flow reactors, raceway ponds), tubular photobioreactors or fermenters (photobioreactors), and vertical reactors (vertical growth reactors). Open cultivators consist of parallel circular tunnels situated on the earth. Microalgae inside them are moved by a wheel mixer (Salis, 2010). It is difficult to control the conditions under which microalgae are developed in these reactors because they can be contaminated by other microorganisms.

11.2.3 Harvesting of Microalgae

Conventional processes used to harvest microalgae include concentration through centrifugation, foam fractionation (Csordas and Wang, 2004), flocculation (Knuckey et al., 2006; Poelman et al., 1997), membrane filtration (Rossignol et al., 2000), and ultrasonic separation. Harvesting costs may contribute 20–30% to the total cost of algal biomass (Molina Grima et al., 2003). The microalgae are typically small, with a diameter of 3–30 μm , and the culture broths may be quite dilute at less than 0.5 g L^{-1} . Thus, large volumes must be handled. The harvesting method depends on the species and cell density and, often, the culture conditions.

11.3 MACROALGAE

Seaweeds or macroalgae belong to the lower plants, meaning that they do not have roots, stems, and leaves. Instead they are composed of a *thallus* (leaf-like structure) and sometimes a stem and a foot. Macroalgae represent a diverse group of eukaryotic, photosynthetic marine organisms. Unlike microalgae, which are unicellular, the macroalgal species are multicellular and possess plant-like characteristics. They are typically composed of a blade or lamina, the stipe, and a holdfast for anchoring the entire structure to hard substrates in marine environments. The general features of these structures are very diverse in the various taxa comprising macroalgae. There are forms of which the primary feature comprises long blades, forms that are branched, and others that are leafy and that form mats. Moreover, some forms possess air bladders that act as flotation devices that enable some species to stand upright or occur free-floating on ocean surfaces. They are often fast growing and can reach sizes of up to 60 m in length (McHugh, 2003). They are classified into three broad groups based on the composition of photosynthetic pigmentation: (1) brown seaweed (*Phaeophyceae*), (2) red seaweed (*Rhodophyceae*), and (3) green seaweed (*Chlorophyceae*). Seaweeds are mainly utilized for the production of food and the extraction of hydrocolloids.

11.3.1 Production Systems

The world production of seaweeds was some 8 million metric tons (MMT) in 2003 (McHugh, 2003). Seaweeds are used in the production of food, feed, chemicals, cosmetics, and pharmaceutical products. Seaweeds are mainly produced for end users in Asian countries such as China, the Philippines, North and South Korea, Japan, and Indonesia. The United

States, Canada, and European countries such as France, Germany, and the Netherlands are attempting to establish large-scale seaweed cultivation (Buck and Buchholz, 2004).

11.3.2 Habitats for Red, Green, and Brown Macroalgae

In their natural environment, macroalgae grow on rocky substrates and form stable, multilayered, perennial vegetation, capturing almost all available photons. Due to the fact that seaweeds are fixed to their substrate, values for maximum productivity may be 10 times higher for a seaweed stand than for a plankton population and can be as high as $1.8 \text{ kg C m}^{-2} \text{ y}^{-1}$. Commercial farming of seaweed has a long history, especially in Asia. The kelp *Laminaria japonica* is the most important, with 4.2 million tons (Mio.t) cultivated mainly in China (Luning and Pang, 2003). Approximately 200 species of seaweeds are used worldwide, about 10 of which are intensively cultivated, including the brown algae *Laminaria japonica* and *Undaria pinnatifida*; the red algae *Porphyra*, *Eucheuma*, *Kappaphycus*, and *Gracilaria*; and the green algae *Monostroma* and *Enteromorpha* (Luning and Pang, 2003).

11.4 THERMOCHEMICAL CONVERSION

Pyrolysis forms the base of thermochemical conversion in most cases. The products of conversion include biocrude, tars, charcoal (carbonaceous solid), and permanent gases, including methane, hydrogen, carbon monoxide, and carbon dioxide. The products and ratios in which they are formed vary depending on the reaction parameters, such as environment, reactors used, final temperature, rate of heating, and source of heat. *Pyrolysis* is the fundamental chemical reaction process and is simply defined as the chemical change that occurs when heat is applied to a material in the absence of oxygen. *Hydrothermal upgradation* (HTU) is one of the processes of a general term of thermochemical conversion (TCC), which includes gasification, liquefaction, and pyrolysis. Various conversion processes for the production of a wide range of products from algal biomass are provided in Figure 11.2.

The hydrothermal upgradation process is a promising liquefaction process because it can be used for the conversion of a broad range of biomass feedstock. The process is especially best suited to wet materials; the drying of feedstock is not necessary because the water is used as one of the reactants. This thermochemical means of reforming biomass may have energetic advantages since, when water is heated at high pressures, a phase change to steam is avoided, which in turn avoids large enthalpic energy penalties. Superior to pyrolysis technology, high-pressure direct liquefaction technology has the potential for producing liquid oils with much higher caloric values and a range of chemicals, including vanillin, phenols, aldehydes, and organic acids (Appell et al., 1971). The advantage of liquefaction is that the bio-oil produced is not miscible with water and has a lower oxygen content, and therefore higher energy content, than pyrolysis-derived oils (Goudriaan et al., 2001; Huber et al., 2006). Oxygen heteroatom removal occurs most readily by dehydration, which removes oxygen in the form of water, and by decarboxylation, which removes oxygen in the form of carbon dioxide (Peterson et al., 2008). The changes and optimization of reaction parameters and catalysts can produce the functional hydrocarbons/specialty chemicals in a single step. In the following sections the process of hydrothermal upgradation is explained in detail and its use for the valorization of algae is discussed.

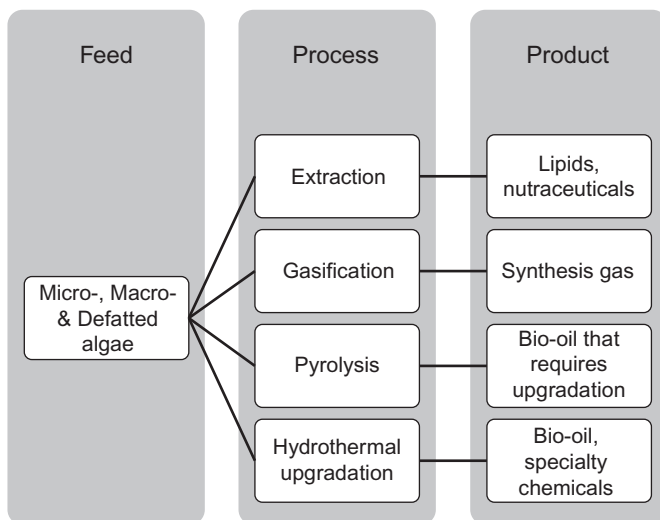

FIGURE 11.2 Product profile from algae by various processes.

11.5 HYDROTHERMAL UPGRADATION

Hydrothermal upgradation (HTU) is a process for the conversion of complex organic materials such as waste biomass into crude oil and other value-added chemicals. Hydrothermal liquefaction involves the reaction of biomass in water at high temperature and pressure, with or without the presence of a catalyst. The products include a biocrude, an aqueous fraction, a gaseous fraction, and unconverted organic and inorganic content. The hydrothermal processing of biomass was investigated by Shell research in the 1980s (Ruyter et al., 1987) and is the basis of the HTU process (Goudriaan et al., 2000). Hydrothermal technologies are broadly defined as chemical and physical transformations in high-temperature (200–600°C), high-pressure (5–40 MPa) liquid or supercritical water. Hydrothermal processing of lignocellulosic biomass has received extensive interest over the last two decades for both the production of liquid fuels (subcritical conditions) and for gasification (supercritical conditions) and is extensively reviewed by Peterson et al. (Peterson et al., 2008).

11.5.1 Reaction Media: Subcritical and Supercritical Water

Water is an ecologically safe substance that is widespread throughout nature. Below the critical point, the vapor pressure curve separates the liquid and vapor phases (Franck and Weingärtner, 1999) and ends at the critical point ($T_c=373^\circ\text{C}$, $p_c=22.1\text{ MPa}$, and $\rho_c=320\text{ kg m}^{-3}$). Beyond the critical point, the density of the supercritical water (SCW) can be varied continuously from liquid-like to gas-like values without any phase transition over a wide range of conditions.

Water plays an essential role in HTU. It is therefore critical to understand the fundamentals of water chemistry when subjected to high-temperature conditions. Water is rather benign and will not likely react with organic molecules under standard environmental conditions (20°C and 1 bar). However, when the temperature increases, two properties of water molecules change substantially. First, the relative permittivity (dielectric constant), ϵ_r , of water

decreases quickly when the temperature increases. When the thermal energy increases, the shared electron between oxygen and hydrogen atoms tends to circulate more evenly and the electronegativity of the oxygen molecule is reduced (becomes less polar). For example, when temperature increases from 25°C to 300°C, the relative permittivity decreases from 78.85 to 19.66, resulting in water molecules from very polar to fairly nonpolar, in relative terms. This polarity change makes water more affinitive to the organic hydrocarbons, most of which are nonpolar molecules.

Second, the dissociation of water dramatically increases with the increase in temperature. Water, like any other aqueous solution, splits into H^+ and OH^- ions in hydrolysis or dissociation. This process is reversible and the rate is sufficiently rapid that it can be considered to be in equilibrium at any instant (Zhang, 2010).

The complete miscibility of supercritical water and gases as well as many organic compounds makes SCW an excellent solvent for homogeneous reactions of organic compounds with gases, like the oxidation of organic compounds with oxygen and air. The absence of phase boundaries leads to a rapid and complete reaction. From the macroscopic point of view, SCW is a nonpolar solvent; from a microscopic view, water is a molecule with a strong dipole moment of 1.85 D. Water in the supercritical state is able to react with different compounds. Therefore water is both solvent and reactant in a variety of reactions.

The ionization constant of water increases with temperature and reaches a maximum near 250°C; the amount of dissociation is three times what it would be at ambient temperatures and pressures. Therefore, subcritical water in the 220–300°C region offers opportunities as both a benign solvent and a self-neutralizing catalyst. Here, water acts as both reactant and reaction medium. Water as reactant leads to hydrolysis reactions and rapidly degrades the polymeric structure of biomass to water-soluble products (Kumar, 2010).

Hot compressed water in the sub- and supercritical states exhibits exciting physical and chemical properties, which can be varied continuously from gas-like to liquid-like behavior. This opens up several promising opportunities for separation processes and chemical reactions.

11.5.2 Hydrothermal Chemistry

Water at high temperatures becomes a good solvent for hydrocarbons that are typically nonpolar hydrophobic under standard environmental conditions. Ionic reactions of organics should be favored by increased solubility in water. The enhancement of this solubility of hydrocarbons in water will further enhance the possibilities of contact of dissociated H^+ with hydrocarbons and hence accelerates the activities of hydrolysis. Water has the ability to carry out condensation, cleavage, and hydrolysis reactions and to affect selective ionic chemistry. This is largely due to changes in its chemical and physical properties, which become more compatible with the reactions of organics as the temperature is increased.

Hot water as a reactant and catalyst likely creates a second pathway for the cascade of molecular transformations that leads to oil. In this pathway, water causes organic material to disintegrate and reform (by adding H^+ to an open carbon bond) into fragments, which then transform into hydrocarbons. This implies that hot water becomes a catalyst for a series of ionic reactions. The acidic and basic nature of hot water—rather than heat—drives this cascade. For example, water may function first as a base, nibbling away at certain linkages in the

organic material. As new molecular fragments build up and modify the reaction environment, water can change its catalytic nature. It can then act as an acid, accelerating different reactions. The resulting products attack parts of the remaining molecules, further speeding the breakdown (Siskin and Katritzky, 1991).

The exact pathways of HTU to produce crude oil from biomass remain unclear, and additional research is needed. The following examples may give some hints of possible pathways of HTU of waste biomass feedstock. The basic reaction mechanism can be described as depolymerization of the biomass; decomposition of biomass monomers by cleavage, dehydration, decarboxylation; and deamination and recombination of reactive fragments (Toor et al., 2011).

In a study by Appell et al. (Appell et al., 1975), one of the mechanisms for the conversion of carbohydrates into oil that was consistent with the results is as follows.

Sodium carbonate reacts with carbon monoxide and water to yield sodium formate:

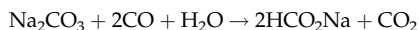

Vicinal hydroxy groups in the carbohydrates undergo dehydration to form an enol followed by isomerization to a ketone. The following reaction will be initiated with the attack of H^+ on the compound with vicinal hydroxyl groups; the water molecule will be eliminated to form carbocation, and further rearrangement is:

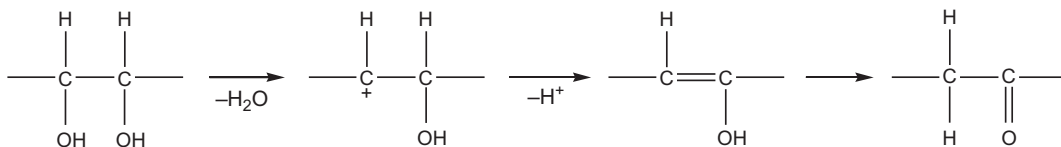

The newly formed carbonyl group is reduced to the corresponding alcohol with formate ion and water:

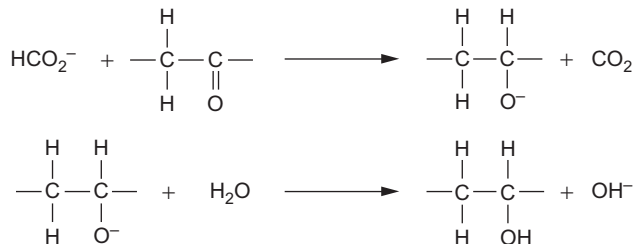

The hydroxyl ion then reacts with additional carbon monoxide to regenerate the formate ion:



A variety of side reactions may occur, and the final product is a complex mixture of compounds. One of the beneficial side reactions occurring in alkaline conditions is that the carbonyl groups tend to migrate along the carbon backbone. When two carbonyl groups become vicinal, a benzylic type of rearrangement occurs, yielding a hydroxy acid. The hydroxy acid readily decarboxylates, causing a net effect of reducing the remainder of the carbohydrate-derived molecule.

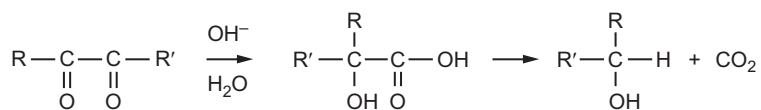

This type of reaction is beneficial to HTU because it leads to the formation of paraffin-type structures, which have less oxygen than the original compounds. In addition, the reaction happens by disproportionation and does not require any additional reducing agent. Aldol condensation may also be part of the reaction process. Aldol condensation occurs between a carbonyl group on one molecule and two hydrogens on another molecule with the elimination of water. The condensation product is a high-molecular-weight compound, typically with high viscosity. Condensation reactions become a major pathway in the absence of reducing agents such as carbon monoxide and hydrogen. Reducing agents keep the carbonyl content of the reactant system sufficiently low so that liquid instead of solid products are formed.

In a study by Appell et al. (Appell et al., 1980), the authors believed that the free hydrogen radical (H^\bullet), not the hydrogen molecule (H_2), participates in the chemical conversion reactions. Thus, they concluded that the addition of carbon monoxide (CO) to the process was more efficient than the addition of hydrogen gas. Based on the water-gas shift reaction, carbon monoxide reacts with water to form carbon dioxide and two hydrogen radicals:



In the presence of the hydrogen radicals, the oxygen is removed from the compounds containing carbonyl and hydroxyl groups, then forms paraffin and water. A possible pathway is described in the following four reactions (He, 2000):

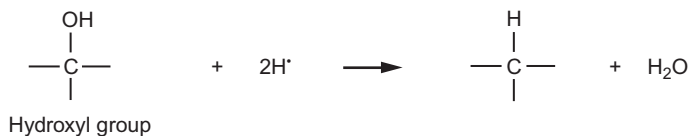
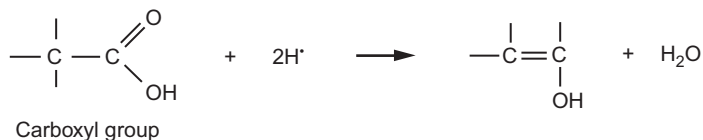
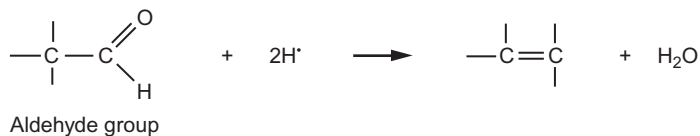
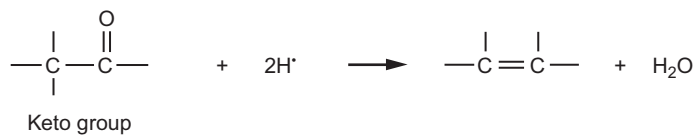

11.5.3 Reactors

Conventional hydrothermal treatment processes are divided into three categories: batch-type reactor, semibatch reactor, and continuous reactor.

In a batch reactor, water and reactant are sealed in the same reactor. The reactor is heated from outside or inside. Due to the easy handling and operation of a batch reactor, many results and analysis data in various operation conditions have been reported. But productivity in a batch system does not meet commercial demand. Steel batch autoclaves are used in most cases. Steel autoclaves have the disadvantage of heating slowly, and thus some time is required to reach reaction temperature (Manarungson et al., 1990). Other reactor types include capillaries and tubular steel reactors. Quartz capillaries have also been used as batch microreactors.

In a semibatch reactor, a reactor is filled with reactant and hot compressed water is introduced to the reactant separately. Temperature control of the slurry and flow rate control of the hot water are simple, and moreover product is obtained continuously. However, reactants have to be refilled in the reactor for continuous production. Sakaki et al. developed a semibatch system (Sakaki et al., 1998), but productivity was still very low.

There are two methods in a continuous system; one is a separate type, and the other is a slurry type. Feeding of solid feedstock into a high-pressure reactor is the biggest challenge to the operation of the separate process. On the other hand, a commercial high-pressure slurry pump is available for continuous feeding of high-concentration slurry (Kobayashi et al., 2011). For continuous operation, tubular steel reactors are often used. Other types of reactors, such as the stirred tank reactor, can be used in principle, but to date this configuration has not yet been applied (Navarro et al., 2009).

11.5.4 Catalysts

Catalysts are important in hydrothermal liquefaction processes, and a range of catalysts has been proposed for the subcritical processing of biomass to tailor the reaction to a specific product and enhance the reaction rates of the proceeding reactions. These catalysts comprise homogeneous catalysts such as mineral acids, organic acids, and bases as well as heterogeneous catalysts such as zirconium dioxide, anatase titania, and other materials (Moller et al., 2011).

11.5.5 Homogeneous

The addition of alkali salts has a positive influence on hydrothermal processes. It improves gasification, accelerates the water gas shift, and increases liquid yields (Watanabe et al., 2005; Yang and Montgomery, 1996; Mok et al., 1992). In addition, the catalysts raise the pH, thereby inhibiting dehydration of the biomass monomers. A high degree of oxygen removal in the form of dehydration instead of decarboxylation might result in unsaturated compounds that easily polymerize to char and tar. Indeed, alkali is also known to suppress char and tar formation (Toor et al., 2011).

Song et al. (Song et al., 2004) investigated the effect of the addition of 1.0 wt% of Na_2CO_3 on the liquefaction of corn stalk and concluded that the use of a catalyst increased the yield of

biocrude (from 33.4% to 47.2%); however, no elaboration on the action of the catalyst was made. Similarly, alkali in the form of K_2CO_3 was shown to have a positive effect on hydrothermal treatment of wood biomass at $280^\circ C$ for 15 min (Karagoz et al., 2006). In a similar study performed with the same equipment and utilizing wood biomass, the authors observed that potassium salts were more effective than sodium salts, and they ranked the salts in order of catalytic activity as follows: $K_2CO_3 > KOH > Na_2CO_3 > NaOH$. The catalysts improved liquid yields and decreased the amount of solid residue. Minowa et al. (Minowa et al., 1998) tested the catalytic action of Na_2CO_3 during hydrothermal conversion of cellulose. Above $300^\circ C$ the catalyst decreased secondary tar formation from the oil product and catalyzed the gasification of the aqueous organics. The study shows how nicely cellulose is converted at different temperatures.

One important catalytic action of alkali during hydrothermal liquefaction is the acceleration of the so-called water gas shift, and thus it favors H_2 and CO_2 formation at the expense of CO . The produced hydrogen gas may act as a reducing agent, increasing the heat value and quality of the oil product. The mechanism proceeds via formation of a formate salt (Schmieder et al., 2000; Sinag et al., 2004) and is more thoroughly described next.

A formate salt ($HCOO^-K^+$) is formed when the alkali salt reacts with CO from the gasification:



Hydrogen is obtained when formate reacts with water:

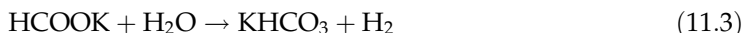

In the next step, CO_2 is produced from $KHCO_3$:



The overall reaction can be written as:

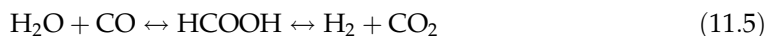

There are also other positive effects of homogeneous catalysts, such as enhanced decarboxylation of fatty acids. For example, Watanabe et al. (Watanabe et al., 2006) improved the conversion of C_{17} -acid (fatty acid) decomposition from 2% to 32% by addition of a KOH catalyst.

11.5.6 Heterogeneous Catalysts

Heterogeneous catalysts have so far mostly been used in gasification processes, where they are reported to have a significant positive effect on low-temperature processes. In addition, during hydrothermal liquefaction some gasification is crucial, since oxygen is removed during this process. However, extensive gasification will reduce the bio-oil yield. Nickel, palladium, and platinum catalysts were tested during gasification of cellulose at $350^\circ C$, 25 MPa, and 10–180 min reaction time, and it was reported that mainly methane and carbon dioxide were produced over supported nickel catalysts, whereas mainly hydrogen and carbon dioxide were produced over supported palladium and platinum catalysts. Most likely the gas is produced by direct gasification of aqueous compounds of the primary biomass degradation

(Minowa and Inoue, 1999). Various other heterogeneous catalysts have been tested in hydrothermal conversion processes; however, the main focus has been to improve gasification, not liquid yields. Examples of these catalysts are Ni/Al₂O₃, Ru/TiO₂, and ZrO₂ (Elliot et al., 1993; Elliot et al., 1994). Catalysis of gasification at conditions below 400°C was extensively reviewed by Peterson et al. (Peterson et al., 2008). In a rare study of heterogeneous catalysts at semihydrothermal conditions, Watanabe et al. (Watanabe et al., 2006) tested the effect of zirconia (ZrO₂) on stearic acid (C₁₇H₃₅COOH) decomposition at 400°C and 25 MPa for 30 min. Zirconia has a high density of amphoteric sites on the surface, which means that it potentially promotes both acid and base-catalyzed reactions. They observed that zirconia (ZrO₂) enhanced the conversion of the C₁₇-acid, and the main products were the C₁₆-alkene, acetic acid, and 2-Nonadecanone.

11.6 HYDROTHERMAL PROCESSES FOR UPGRADATION OF ALGAE

Algal biomass is attractive for renewable liquid fuels, but much water accompanies this aquatic biomass feedstock. The energy requirements for drying algae are very high, which militates against a large-scale fuel production process employing this step. Thus, there is a need for processes that convert wet algal biomass directly and therefore operate in the aqueous phase. Two major considerations of the emerging algal biofuel industry are the energy-intensive dewatering of the algae slurry and nutrient management. The process is suitable for high-moisture aquatic biomass such as defatted microalgae and macroalgae because the biomass is processed as slurry in hot compressed water.

11.6.1 Hydrothermal Liquefaction of Model Compounds

To understand the reactivity of wet algal biomass, it is necessary to understand the reactivity of model compounds (components of algal biomass). Experiments with wet algal biomass are very useful for understanding how the yields and comparison of different product fractions (e.g., crude bio-oil, aqueous phase products, gaseous products, and solid products) vary with hydrothermal processing conditions. Such data can be used to develop phenomenal kinetics models that have utility for process design and optimization. Such data provide little insight into the details of the chemistry that occurs. However, to elucidate some of these details, several studies have been carried out with simpler organic molecules (phytol, ethyloleate, phenylalanine, and a model phospholipid) that mimic the structural features and functional groups present in microalgae and/or crude algal bio-oil from hydrothermal liquefaction (Savage et al., 2012a).

Changi et al. examined the behavior of phytol, an acyclic diterpene C₂₀-alcohol and a model compound for algal biomass, in high-temperature water (HTW) at 240°C, 270°C, 300°C, and 350°C. Under these conditions, the major products include neophytadiene, isophytol, and phytone. The minor products include pristene, phytene, phytane, and dihydrophytol. Neophytadiene is likely formed via dehydration of phytol, whereas isophytol can be obtained via an allylic rearrangement. Phytol disappearance follows first-order

kinetics with activation energy of $145 \pm 20 \text{ kJ mol}^{-1}$ and a pre-exponential factor of $109.94 \pm 0.12 \text{ s}^{-1}$. Delplot analysis discriminated between primary and nonprimary products and led to a potential set of reaction pathways. A kinetics model based on the proposed pathways was consistent with the experimental data (Changi et al., 2012).

Formic acid, acetic acid, lactic acid, glycolic acid, 2-hydroxybutyric acid, succinic acid, malic acid, mannuronic acid, and guluronic acid were obtained by the hydrothermal treatment of alginate. The total yield of the organic acids was 46% at maximum yield 350°C , 40 MPa, and 0.7 s reaction time (Aida et al., 2012). The formation of organic acids suggests that the carboxyl group structure of the alginate is preserved during the hydrothermal decomposition of the alginate. The formation of dicarboxylic acids is evidence that oxidation reactions occur during the hydrothermal treatment, introducing carboxyl groups into the decomposition products. The product distribution indicates that both acid and base catalyzed reactions occur during the hydrothermal treatment of alginate. Hydrothermal treatment of uronic acid, glucuronic acid, gave the same organic acids as those obtained from hydrothermal treatment of alginate (Aida et al., 2012).

11.6.2 Hydrothermal Liquefaction of Microalgae

The HTU is evaluated for its potential as a process to convert algae and algal debris into a liquid fuel within a sustainable algae biorefinery concept in which, next to fuels (gaseous and liquid), high-value products are coproduced, nutrients and water are recycled, and the use of fossil energy is minimized.

Microalgae strains of *Chlorella vulgaris*, *Scenedesmus dimorphus*, and the cyanobacteria *Spirulina platensis* and *Chlorogloeopsis fritschii* were processed in batch reactors at 300°C and 350°C . The biocrude yields ranged from 27–47 wt%. The biocrudes were of low O and N content and high heating value, making them suitable for further processing. Growth occurred in heavy dilutions where the amounts of growth inhibitors were not too high. The results show that the closed-loop system using the recovered aqueous phase offers a promising route for sustainable oil production and nutrient management for microalgae (Biller et al., 2012).

Hydrothermal liquefaction (300°C and 10–12 MPa) was used to produce bio-oils from *Scenedesmus* (raw and defatted) and *Spirulina* biomass that were compared against Illinois shale oil. Sharp differences were observed in the mean bio-oil molecular weight (pyrolysis 280–360 Da; hydrothermal liquefaction 700–1330 Da) and the percentage of low boiling compounds (bp $< 400^\circ\text{C}$) (pyrolysis 62–66%; hydrothermal liquefaction 45–54%). Analysis of the energy consumption ratio (ECR) also revealed that for wet algal biomass (80% moisture content), hydrothermal liquefaction is more favorable (ECR 0.44–0.63) than pyrolysis (ECR 0.92–1.24) due to required water volatilization in the latter technique (Vardon et al., 2012).

Yu et al (Yu et al., 2011) studied the conversion of a fast-growing, low-lipid, high-protein microalgae species, *Chlorella pyrenoidosa*, via hydrothermal liquefaction into four products: biocrude oil, aqueous product, gaseous product, and solid residue. The effects of operating conditions (reaction temperature and retention time) on the distributions of carbon and nitrogen in hydrothermal liquefaction products were quantified. Carbon recovery (CR), nitrogen recovery (NR), and energy recovery in the biocrude oil fraction generally increased with the increase of reaction temperature as well as the retention time. The highest-energy recovery of

biocrude oil was 65.4%, obtained at 280°C with 120 min retention time. Both carbon and nitrogen tended to preferentially accumulate in the hydrothermal liquefaction biocrude oil products as temperature and retention time increased, but the opposite was true for the solid residual product. The NR values of hydrothermal liquefaction aqueous product also increased with reaction temperature and retention time. 65–70% of nitrogen and 35–40% of carbon in the original material were converted into water-soluble compounds when reaction temperature was higher than 220°C and retention time was longer than 10 min. The CR of gas was less than 10% and is primarily present in the form of carbon dioxide.

Garcia et al. used the freshwater microalgae *Desmodesmus sp.* as feedstock for HTU over a very wide range of temperatures (175–450°C) and reaction times (up to 60 min) using a batch reactor system. The different product phases were quantified and analyzed. The maximum oil yield (49 wt%) was obtained at 375°C and 5 min reaction time, recovering 75% of the algal calorific value into the oil and an energy densification from 22 to 36 MJ kg⁻¹. At increasing temperature, both the oil yield and the nitrogen content in the oil increased. A pioneering visual inspection of the cells after HTU shows a large step increase in the HTU oil yield when going from 225–250°C at 5 min reaction time, which coincided with a major cell wall rupture under these conditions. Additionally, it was found that the oil components, by extractive recovery after HTU below 250°C, did change with temperature, even though the algal cells were visually still unbroken. Finally, the possibilities of recycling growth nutrients became evident by analyzing the aqueous fractions obtained after HTU. From the results obtained, the authors concluded that HTU is most suited as post-treatment technology in an algae biorefinery system after the wet extraction of high-value products, such as protein-rich food/feed ingredients and lipids (Garcia et al., 2012).

Vardon et al. studied the influence of wastewater feedstock compounds on hydrothermal liquefaction biocrude oil properties and physicochemical characteristics. *Spirulina* algae, swine manure, and digested sludge were converted under hydrothermal liquefaction conditions (300°C, 10–12 MPa, and 30 min reaction time). Biocrude yields ranged from 9.4% (digested sludge) to 32.6% (*Spirulina*). Although similar higher heating values (32.0–34.7 MJ kg⁻¹) were estimated for all product oils, more detailed characterization revealed significant differences in biocrude chemicals. Feedstock components influenced the individual compounds identified as well as the biocrude functional group chemicals. Molecular weights tracked with obdurate carbohydrate content and followed the order *Spirulina* < swine manure < digested sludge (Vardon et al., 2011).

Valdez et al. performed hydrothermal liquefaction of *Nannochloropsis sp.* at 350°C for 60 min and analyzed the gas, crude bio-oil, dissolved aqueous solids, and insoluble residual solids product fractions. Most of the carbon and hydrogen in the algal biomass appear in the crude bio-oil product, as desired. A majority of the original nitrogen appears as ammonia in the aqueous phase. They used both nonpolar solvents (hexadecane, decane, hexane, and cyclohexane) and polar solvents (methoxycyclopentane, dichloromethane, and chloroform). Hexadecane and decane provided the highest gravimetric yields of bio-oil (39 ± 3 and 39 ± 1 wt%, respectively), but these crude bio-oils had a lower carbon content (69 wt% for decane) than those recovered with polar solvents such as chloroform (74 wt%) and dichloromethane (76 wt%). Fatty acids were the most abundant components, but some aromatic and sulfur- and nitrogen-containing compounds were also quantified. The amount of free fatty acids in the crude bio-oil significantly depended on the solvent used, with polar

solvents recovering more fatty acids than nonpolar solvents. The bio-oil recovered with chloroform, for example, had fatty acid content equal to 9.0 wt% of the initial dry algal biomass (Valdez et al., 2011).

Biller and Ross liquefied a range of model biochemical components, microalgae, and cyanobacteria with different biochemical contents under hydrothermal conditions at 350°C, approximately 200 bar in water, 1 M Na₂CO₃ and 1 M formic acid. The model compounds include albumin and a soya protein, starch and glucose, the triglyceride from sunflower oil, and two amino acids. Microalgae include *Chlorella vulgaris*, *Nannochloropsis occulata*, and *Porphyridium cruentum* and the cyanobacteria *Spirulina*. The yields and product distribution obtained for each model compound have been used to predict the behavior of microalgae with different biochemical composition and have been validated using microalgae and cyanobacteria. Broad agreement is reached between predictive yields and actual yields for the microalgae based on their biochemical composition. The yields of biocrude are 5–25 wt% higher than the lipid content of the algae, depending on biochemical composition. The yields of biocrude follow the trend lipids > proteins > carbohydrates (Biller and Ross, 2011).

Valdez et al. investigated hydrothermal liquefaction of *Nannochloropsis sp.* at different temperatures (250–400°C), times (10–90 min), water densities (0.3–0.5 g mL⁻¹), and biomass loadings (5–35 wt%). Liquefaction produced a biocrude with light and heavy fractions, along with gaseous, aqueous, and solid byproduct fractions. The gravimetric yields of the product fractions from experiments at 250°C, summed to an average of 100 ± 4 wt%, shows mass balance closure at 250°C. The gravimetric yields of the product fractions are independent of water density at 400°C. Increasing the biomass loading increases the biocrude yield from 36 to 46 wt%; the yields of light and heavy biocrude depend on reaction time and temperature, but their combined yield depends primarily on temperature. Regardless of reaction time and temperature, the yield of products distributed to the aqueous phase is 51 ± 5 wt% and the light biocrude is 75 ± 1 wt%. Two-thirds of the N in the alga is immediately distributed to the aqueous phase, and up to 84% can be partitioned there. Up to 85% of the P is distributed to the aqueous phase in the form of free phosphate for nutrient recycling. Up to 80% of the chemical energy in the alga is retained within the biocrude (Valdez et al., 2012).

Biller et al. processed a range of microalgae and lipids extracted from terrestrial oil seed at 350°C at pressures of 150–200 bars in water using heterogeneous catalysts. The results indicate that the biocrude yields from the liquefaction of microalgae were increased slightly with the use of heterogeneous catalysts, but the higher heating value (HHV) and the level of deoxygenation increased by up to 10%. Under hydrothermal conditions, the lipids from microalgae and oil seeds decompose to fatty acids and are hydrogenated to more saturated analogues. The use of heterogeneous catalysts causes an increase in deoxygenation of the biocrude. The Co/Mo/Al₂O₃ and Pt/Al₂O₃ appear to selectively deoxygenate the carbohydrate and protein fractions, whereas the Ni/Al₂O₃ deoxygenates the lipid fraction. This is illustrated by the presence of alkanes for the Ni/Al₂O₃ catalyst. The use of a Ni/Al₂O₃ catalyst also appears to promote gasification reactions (Biller et al., 2011).

Microalgae can be converted to an energy-dense bio-oil via pyrolysis; however, the relatively high nitrogen content of this bio-oil presents a challenge for its direct use as fuels. Therefore, hydrothermal pretreatment was employed to reduce the N content in

Nannochloropsis oculata feedstock by removing proteins without requiring significant energy inputs. The effects of reaction conditions on the yield and composition of pretreated algae were investigated by varying the temperature (150–225°C) and reaction time (10–60 min). Compared with untreated algae, pretreated samples had higher carbon contents and enhanced heating values under all reaction conditions and 6–42% lower N contents at 200–225°C for 30–60 min. The pyrolytic bio-oil from pretreated algae contained less N-containing compounds than that from untreated samples, and the bio-oil contained mainly (44.9% GC–MS peak area) long-chain fatty acids (C₁₄–C₁₈), which can be more readily converted into hydrocarbon fuels in the presence of simple catalysts (Du et al., 2012).

Schuping et al. investigated the hydrothermal liquefaction of microalgae *Dunaliella tertiolecta* cake under various liquefaction temperatures, holding times, and catalyst dosages. It was observed that the maximum bio-oil yield of 25.8% was obtained at a reaction temperature of 360°C and a holding time of 50 min using 5% Na₂CO₃ as a catalyst. The bio-oil is composed of fatty acids, fatty acid methyl esters, ketones, and aldehydes. Its empirical formula is CH_{1.44}O_{0.29}N_{0.05}, and its heating value is 30.74 MJ kg⁻¹. The bio-oil product is a possible eco-friendly green biofuel and chemical (Shuping et al., 2010).

Ross et al. aimed to investigate the conditions for producing high-quality, low-molecular-weight biocrude from microalgae and cyanobacteria containing low lipid contents including *Chlorella vulgaris* and *Spirulina*. The influence of process variables such as temperature (300°C and 350°C) and catalyst type has been studied. Catalysts employed include the alkali, potassium hydroxide and sodium carbonate, and the organic acids, acetic acid and formic acid. The yields of biocrude are increased using an organic acid catalyst; produced biocrude has a lower boiling point and improved flow properties. The biocrude contains a carbon content of typically 70–75% and an oxygen content of 10–16%. The nitrogen content in the biocrude typically ranges from 4% to 6% and the HHV range was from 33.4 to 39.9 MJ kg⁻¹. Analysis by GC/MS indicates that the biocrude contains aromatic hydrocarbons, nitrogen heterocycles, and long-chain fatty acids and alcohols. A nitrogen balance indicates that a large proportion of the fuel nitrogen (up to 50%) is transferred to the aqueous phase in the form of ammonium. The remainder is distributed between the biocrude and the gaseous phase, the latter containing HCN, NH₃, and N₂O, depending on catalyst conditions. The addition of organic acids results in a reduction of nitrogen in the aqueous phase and a corresponding increase of NH₃ and HCN in the gas phase. The addition of organic acids has a beneficial effect on the yield and boiling-point distribution of the biocrude produced (Ross et al., 2010).

Shen et al. studied the application of microalgae to the production of acetic acid under hydrothermal conditions with H₂O₂ oxidant. Results showed that acetic acid was obtained with a good yield of 14.9% based on a carbon base at 300°C for 80 s with 100% H₂O₂ supply. This result should be helpful to facilitate studies for developing a new green and sustainable process to produce acetic acid from microalgae, which are the fastest-growing sunlight-driven cell factories (Shen et al., 2011).

The hydrothermal method includes adding dried and pulverized algae raw material to 0.05–0.15 M base solution or 0.05–0.15 M acid solution, soaking at room temperature for at least 20 h, and adding the soaked liquid and modified natural mordenite catalyst at a mass ratio of 1: 0.02–0.05 to a pressure reactor. The base solution is NaOH, KOH and/or sodium carbonate solution, and the acid solution is sulfuric acid, acetic acid, and/or formic acid (Hu et al., 2011).

11.6.3 Hydrothermal Liquefaction of Algae Followed by Catalytic Hydrothermal Upgradation

Savage et al. demonstrated hydrothermal liquefaction to produce a crude bio-oil from wet algae paste and then hydrothermal catalytic upgrading of the biocrude to produce hydrocarbon product in high yield. This work provides new results on the liquefaction pathways and kinetics and on the roles and effectiveness of different upgrading catalysts for removing heteroatoms from algae and reducing the viscosity of the biocrude (Savage et al., 2012b).

Duan et al. reported the catalytic hydrotreatment of crude bio-oil produced from the hydrothermal liquefaction of microalgae (*Nannochloropsis sp.*) over Pd on C (5% Pd/C) in supercritical H₂O (SCW) at 400°C and 3.4 MPa high-pressure H₂. Longer reaction times and higher catalyst loadings did not favor the treated oil yield due to the increasing amount of gas and coke products formation but did lead to treated bio-oil with higher HHV (41–44 MJ kg⁻¹) than that of the crude feed. Highest HHV of treated oil (ca. 44 MJ kg⁻¹) was obtained after 4 h using an 80% intake of catalyst on crude bio-oil. The product oil produced at longer reaction times and higher catalyst loadings, which was a freely flowing liquid as opposed to being the viscous, sticky, tar-like crude bio-oil material, was higher in H and lower in O and N than the crude feed, and it was essentially free of S (below detection limits). Typical H/C and O/C molar ratio ranges for the bio-oils treated at different reaction times and catalyst loadings were 1.65–1.79 and 0.028–0.067, respectively. The main gas-phase products were unreacted H₂, CH₄, CO₂, C₂H₆, C₃H₈, and C₄H₁₀. Overall, many of the properties of the treated oil obtained from catalytic hydrotreatment in SCW in the presence of Pd/C are very similar to those of hydrocarbon fuels derived from fossil-fuel resources (Duan and Savage, 2011a).

Duan and Savage determined the influence of a Pt/C catalyst, high-pressure H₂, and pH on the upgrading of a crude algal bio-oil in supercritical water (SCW). The SCW treatment led to product oil with a higher heating value (ca. 42 MJ kg⁻¹) and lower acid number than the crude bio-oil. The product oil was also lower in O and N and essentially free of sulfur. Including the Pt/C catalyst in the reactor led to freely flowing liquid product oil with a high abundance of hydrocarbons. Overall, many of the properties of the upgraded oil obtained from catalytic treatment in SCW are similar to those of hydrocarbon fuels derived from fossil-fuel resources (Duan and Savage, 2011b).

11.6.4 Hydrothermal Liquefaction of Macroalgae

Ross et al. studied the preliminary classification of five macroalgae from the British Isles: *Fucus vesiculosus*, *Chorda filum*, *Laminaria digitata*, *Fucus serratus*, and *Laminaria hyperborea*, and *Macrocystis pyrifera* from South America, using a Van Krevelen diagram. The macroalgae have been characterized for proximate and ultimate analysis, inorganic content, and calorific value. The different options for thermal conversion and behavior under combustion and pyrolysis have been evaluated and compared to several types of terrestrial biomass, including miscanthus, short rotation willow coppice, and oat straw. Thermal treatment of the macroalgae has been investigated using thermogravimetry (TGA) and pyrolysis-GC-MS. Combustion behavior is investigated using TGA in an oxidizing atmosphere. The suitability of macroalgae for the different thermal processing routes is discussed. Ash chemistry restricts the use of macroalgae for direct combustion and gasification. Pyrolysis produces a range of pentosans and a significant proportion of nitrogen-containing compounds. High char yields

are produced. Significant differences in fuel properties exist between kelps and terrestrial biomass. The heating value is lower than that of the terrestrial energy crops (cf. 14–16 MJ kg⁻¹ to 17–20 MJ kg⁻¹) since, in general, the ash content is higher. Consequently, the metal contents (especially alkali metals) are, for the most part, higher in the seaweeds studied here compared to the terrestrial biomass. Total halogen content is in the range 0.5–11% in kelps, which is also significantly higher than the terrestrial biomass (1–1.5%). Thus it is clear that unless washing were utilized to reduce the alkali levels, these macroalgae could not be used in dedicated systems without encountering problems in component failure (Ross et al., 2008).

The liquefaction of “green tide” macroalgae *Enteromorpha prolifera* in sub- or supercritical alcohols in a batch reactor has been investigated. Under the conditions of the reaction time of 15 min and algae/solvent ratio set at 1:10, the macroalgae in methanol at 280°C produced a bio-oil yield at 31.1 wt% of dry wt, and the ethanol at 300°C yielded bio-oil at 35.3 wt%. The bio-oils obtained by liquefaction of macroalgae in alcohols are mainly composed of ester compounds. A variety of fatty acid (C₃–C₂₂) esters (Me or ethyl) in the bio-oils obtained in methanol and ethanol, respectively, were qualified by GC-MS, and their relative contents are above 60% of the total area for each bio-oil. Overall, bio-oils obtained in two alcohols are very similar to biodiesel in composition. The elemental analysis of bio-oils indicated that bio-oils still have high oxygen content (Zhou et al., 2012).

The marine brown algae, *Sargassum patens* C. Agardh, floating on the Yellow Sea, was collected and converted to bio-oil through hydrothermal liquefaction with a modified reactor. A maximum yield of 32.1 ± 0.2 wt% bio-oil was obtained after 15 min at 340°C at a feedstock concentration of 15 g biomass/150 mL water, without using a catalyst. The bio-oil had a heating value of 27.1 MJ kg⁻¹ and contained water, lipid, alcohol, phenol, esters, ethers, and aromatic compounds. The solid residue obtained had a high ash and oxygen content. The results suggest that *Sargassum patens* C. Agardh have potential as biomass feedstock for fuel and chemical products (Li et al., 2012).

The brown macroalga *Laminaria saccharina* was converted into biocrude by hydrothermal liquefaction. A maximum biocrude yield of 19.3 wt% was obtained with a 1:10 biomass-to-water ratio at 350°C and a residence time of 15 min without the presence of the catalyst. The biocrude had an HHV of 36.5 MJ kg⁻¹ and is similar in nature to a heavy crude oil or bitumen. The solid residue has high ash content and contains a large proportion of calcium and magnesium. The aqueous phase is rich in sugars and ammonium and contains a large proportion of potassium and sodium (Anastasakis and Ross, 2011).

Marine macroalgae *Enteromorpha prolifera*, one of the main algae genera for green tide, was converted to bio-oil by hydrothermal liquefaction in a batch reactor at temperatures of 220–320°C. The liquefaction products were separated into a dichloromethane-soluble fraction (bio-oil), water-soluble fraction, solid residue, and gaseous fraction. A moderate temperature of 300°C with 5 wt% Na₂CO₃ and reaction time of 30 min led to the highest bio-oil yield of 23.0 wt%. The HHV of bio-oils obtained at 300°C were around 28–30 MJ kg⁻¹. Acetic acid was the main component of the water-soluble products (Zhou et al., 2010).

11.6.5 Two-Step Sequential Hydrothermal Liquefaction

To make algal biofuel economically viable, extraction of value-added coproducts, along with oil, appears absolutely necessary. The major barrier in algal coproduct development is the lack of an efficient separation technology. To address this issue, a unique two-step

sequential hydrothermal liquefaction (SEQHTL) technology for the simultaneous production of value-added polysaccharides and bio-oil from algal-biomass was developed. The first step involves the subcritical water extraction of valuable algal (*Chlorella sorokiniana*) polysaccharides at 160°C. The polysaccharide-rich water extract was removed and precipitated with ethanol. In the next step, the extracted biomass was liquefied to bio-oil at 300°C. The yield of bio-oil by SEQHTL was 24% of the dry wt. In addition, this method also extracted 26% of the polysaccharides present, whereas *direct hydrothermal liquefaction* (DIRHTL) generated only 28% bio-oil. In the SEQHTL method, biochar formation was remarkably low, and as such, SEQHTL produced 63% less biochar than DIRHTL. The yield of biochar production is negligible correlated to polysaccharide content ($p > 0.98$), suggesting a majority of carbohydrates present in algal biomass were converted into biochar. This conversion did not significantly influence the bio-oil production. Comparative GC-FID, GC-MS, NMR, FT-IR analysis and ESI-MS of the bio-oil extracted by SEQHTL with DIRHTL showed no significant differences. Elemental analysis of the SEQHTL bio-oil demonstrated that it contained 70% carbon, 0.8% nitrogen, and 11% oxygen (Chakraborty et al., 2012).

11.6.6 Hydrothermal Gasification of Algae

Different seaweed species were gasified in supercritical water as biomass feedstock. The experimental conditions were 500°C of temperature and 1 h of reaction time. The coke yields were found to be significantly lower than those obtained with lignocellulosic and protein contained wastes. The gaseous species detected contained mainly hydrogen, methane, and carbon dioxide. Hydrogen yields ranging between 11.8 and 16 g H₂ kg⁻¹ seaweed have been obtained. On the other hand, the methane yields were found to be in the range of 39 and 104 g CH₄ kg⁻¹ seaweed. Dissolved organic carbon (DOC) values of aqueous phase show the extent of higher gasification (Schumacher et al., 2011).

Guan et al. reported results from a systematic study of the gasification of the alga *Nannochloropsis sp.* in supercritical water at 450–550°C. The gaseous products were mainly H₂, CO₂, and CH₄, with lesser amounts of CO, C₂H₄, and C₂H₆. Higher temperatures, longer reaction times, higher water densities, and lower algae loadings provided higher gas yields. The algae loading strongly affected the H₂ yield, which more than tripled when the loading was reduced from 15 wt% to 1 wt%. The water density had little effect on the gas composition. The temporal variation of intermediate products indicated that some (e.g., alkanes) reacted quickly, whereas others (aromatics) reacted more slowly (Guan et al., 2012).

11.6.7 Hydrothermal Carbonization of Algae

Employing relatively moderate conditions of temperature (ca. 200°C), time (<1 h), and pressure (<2 MPa), microalgae can be converted in an energy-efficient manner into an algal char product that is of bituminous coal quality. Potential uses for the product include creation of synthesis gas and conversion into industrial chemicals and gasoline; application as a soil nutrient amendment; and as a carbon-neutral supplement to natural coal for generation of electrical power. Some strains of cyanobacteria also provided high-quality chars, but yields were only half those obtained with green microalgae (Heilmann et al., 2010).

11.7 OPPORTUNITIES AND CHALLENGES

The rapid commercial expansion of the algal biofuel industry is an excellent example of sustainable product development with dramatic future potential for contributions to fuel supplies, yet many questions regarding algae production remain unanswered. The state of knowledge regarding the potential environmental impact of the production of algae and algae-derived biofuels continues to be incomplete, fragmented, and largely obscured by proprietary concerns. However, this knowledge is changing rapidly, facilitated by research and industry and driven by economics. Commercialization of the production of algae-derived biofuels as part of the overall biofuel industry will have a profound future impact on society. Waste products that are currently discharged into the environment as contaminants will be utilized to produce much-needed renewable energy sources. Now is the time to initiate the development of an algae industry evaluation methodology that allows for the advancement of knowledge and evaluation tools for authorities to best understand the potential implications (Menetrez, 2012).

The process of generating biofuel from algae involves the growth, concentration, separation, and conversion of microalgae biomass, some of which can be genetically altered. After separating the desired biofuel product or products from the microalgae biomass, a significant portion of byproduct remains. It is important that the remaining byproducts have a useful and safe purpose for the economic feasibility and environmental sustainability of the process. Post-extraction byproducts must be used efficiently and completely. Since no biofuel is carbon-neutral in the current scenario, significant fossil-fuel input is needed for growing, processing, and extracting the oil, which might offset the positive aspects of the algal biofuel (U.S. DOE, 2006).

Microalgae hold great promise as starting materials for biofuel production, but significant challenges exist for the developing industry. Present economy-of-scale differences between the algal oil industry and the petrochemical industry are immense and will require significant investment in the form of government-funded incentives for liquid fuels derived from microalgae. The present microalgae manufacturing industry is very small at only 5000 tons y^{-1} (Pulz and Gross, 2004). It is almost completely devoted to synthesizing high-value nutraceutical products and is not extensively engaged in the mass production of high oil-containing microalgae. In addition, microalgae require significantly higher levels of nitrogen than terrestrial plants to achieve effective growth rates, which increases the cost of production (Brezinski, 2004).

Moreover, microalgae do not achieve concentrations at maturity in their natural aqueous growth media >1 wt%. Therefore, to become a significant industrial commodity in terms of cost and scale, growth and harvesting technologies need to be developed that can economically provide higher concentrations required for industrial-scale processing operations. Actual extraction processes for lipids and lipid-derived materials require considerable improvement. Essentially, any process suitable for commercial consideration must not dry algae by evaporating water. The energy input to evaporate water is significant, and the heat energy input required will, with very few exceptions, be greater than any energy output that can be obtained by combustion of the dried material (Heilmann et al., 2011).

Although algal biofuels possess great potential, profitable production is quite challenging. Much of this challenge is rooted in the thermodynamic constraints associated with

producing fuels with high energy, low entropy, and high exergy from dispersed materials (Beal et al., 2012).

One of the difficulties with using conventional gasification technologies for converting high-moisture biomass such as algae is the low thermal efficiency that results from the need to vaporize the water in and with the feedstock. Thus, conventional biomass gasification processes require a dry feedstock. Of course, energy is still required to do this drying prior to gasification, and the energy needed here offsets some of the energy gained by producing the gaseous product. Gasifying wet biomass in supercritical water is a means of circumventing this energy penalty (Guan et al., 2012).

In addition to these holistic challenges, some of the other challenges with respect to the reactors and catalyst are as follows: Due to the high pressures needed for processing, special reactor and separator designs are required. The process has to be designed in a way that can handle solids loading in excess of 15–20 wt% and handle feedstock with impurities. Proper heat-recovery systems have to be designed because the reactors operate at very high temperatures in pressurized conditions. Feeding at high pressures into the reactor is always a challenge and is a major problem in small-scale plants. In the case of heterogeneous catalysts, the catalyst has to be robust and should not deactivate easily due to the formation of coke. If homogeneous catalysts are used, they must be recovered at the end of the process and reused again. Another most important phenomenon that occurs is the wall effect, which can cause serious problems after scaling up if not understood at lab-scale level (Peterson et al., 2008).

With respect to the conversion methods, effective heat and mass transfer is required for the proper conversion of feedstock into the desired products. This requires advanced design of reactors used for conversion and preparation of hybrid catalysts.

Acknowledgments

The authors thank the Director, Indian Institute of Petroleum, Dehradun, for his constant encouragement and support. RS thanks the Council of Scientific and Industrial Research (CSIR), New Delhi, India, for providing a senior research fellowship (SRF). The authors also thank the CSIR for financial support.

References

- Adams, J.M., Gallagher, J.A., Donnison, I.S., 2009. Fermentation study on *Saccharina latissima* for bioethanol production considering variable pre-treatments. *J. Appl. Phycol.* 21, 569–574.
- Aida, T.M., Yamagata, T., Abe, C., Kawanami, H., Watanabe, M., Smith Jr., R.I., 2012. Production of organic acids from alginate in high temperature water. *J. Supercrit. Fluids* 65, 39–44.
- Anastasakis, K., Ross, A.B., 2011. Hydrothermal liquefaction of the brown macro-algae *Laminaria Saccharina*: Effect of reaction conditions on product distribution and composition. *Bioresour. Technol.* 102, 4876–4883.
- Appell, H.R., Fu, Y.C., Friedman, S., Yavorsky, P.M., Wender, I., 1971. Converting organic wastes to oil. Report of Investigation No. 7560. U.S. Bureau of Mines, Washington, D.C., USA.
- Appell, H.R., Fu, Y.C., Illig, E.G., Steffgen, F.W., Miller, R.D., 1975. Converting of Cellulosic Wastes to Oil. Report of Investigation 8013. U.S. Bureau of Mines, Washington, D.C., USA.
- Appell, H.R., Fu, Y.C., Friedman, S., Yavorsky, P.M., Wender, I., 1980. Converting Organic Wastes to Oil: A Renewable Energy Source. Report of Investigations 7560. U.S. Bureau of Mines, Washington, D.C., USA.
- Aresta, M., Dibenedetto, A., Tommasi, I., 2003. Energy from Macro-algae. *Fuel Chem. Div. Prep.* 48, 260–261.
- Atalla, R.H., Van der Hart, D.L., 1984. Native cellulose: a composite of two distinct crystalline forms. *Science* 223, 283–285.

- Beal, C.M., Hebner, R.E., Webber, M.E., 2012. Thermodynamic analysis of algal biocrude production. *Energy* 44, 925–943.
- Billler, P., Ross, A.B., 2011. Potential yields and properties of oil from the hydrothermal liquefaction of microalgae with different biochemical content. *Bioresour. Technol.* 102, 215–225.
- Billler, P., Riley, R., Ross, A.B., 2011. Catalytic hydrothermal processing of microalgae: Decomposition and upgrading of lipids. *Bioresour. Technol.* 102, 4841–4848.
- Billler, P., Ross, A.B., Skill, S.C., Lea-Langton, A., Balasundaram, B., Hall, C., et al., 2012. Nutrient recycling of aqueous phase for microalgae cultivation from the hydrothermal liquefaction process. *Algal Res.* 1, 70–76.
- Blanch, H.W., 2012. Bioprocessing for biofuels. *Curr. Opin. Biotech.* 23, 390–395.
- Brezinski, M.A., 2004. The Si:C:N ratio of marine diatoms: interspecific variability and the effect of some environmental variables. *J. Phycol.* 21, 345–357.
- Buck, B.C., Buchholz, C.M., 2004. The offshore ring: A new system design for the open ocean aquaculture of macro algae. *J. Appl. Phycol.* 16, 355–369.
- Carlsson, A.S., van Beilen, J.B., Möller, R., Clayton, D., 2007. Micro- and macro-algae: utility for industrial applications, Outputs from the EPOBIO project (D. Bowles, Ed.). CNAP, University of York, CPL Press, UK.
- Chakraborty, M., Miao, C., McDonald, A., Chen, S., 2012. Concomitant extraction of bio-oil and value added polysaccharides from *Chlorella sorokiniana* using a unique sequential hydrothermal extraction technology. *Fuel* 95, 63–70.
- Changi, S., Brown, T.M., Savage, P.E., 2012. Reaction kinetics and pathways for phytol in high-temperature water. *Chem. Eng. J.* 189–190, 336–345.
- Chisti, Y., 2007. Biodiesel from microalgae. *Biotechnol. Adv.* 25, 294–306.
- Choi, S.P., Nguyen, M.T., Sim, S.J., 2010. Enzymatic pretreatment of *Chlamydomonas reinhardtii* biomass for ethanol production. *Bioresour. Technol.* 101, 5330–5336.
- Cordas, A., Wang, J.K., 2004. An integrated photobioreactor and foam fractionation unit for the growth and harvest of *Chaetoceros* spp. in open systems. *Aquacult. Eng.* 30, 15–30.
- Daroch, M., Geng, S., Wang, G., 2012. Recent advances in liquid biofuel production from algal feedstocks. *Appl. Energy*. <http://dx.doi.org/10.1016/j.apenergy.2012.07.031>.
- Du, Z., Mohr, M., Ma, X., Cheng, Y., Lin, X., Liu, Y., et al., 2012. Hydrothermal pretreatment of microalgae for production of pyrolytic bio-oil with a low nitrogen content. *Bioresour. Technol.* 120, 13–18.
- Duan, P., Savage, P.E., 2011a. Catalytic hydrotreatment of crude algal bio-oil in supercritical water. *Appl. Catal. B Environ.* 104, 136–143.
- Duan, P., Savage, P.E., 2011b. Upgrading of crude algal bio-oil in supercritical water. *Bioresour. Technol.* 102, 1899–1906.
- Elliot, D.C., Sealock, L.J., Baker, E.G., 1993. Chemical processing in high-pressure aqueous environments. 2. Development of catalysts for gasification. *Ind. Eng. Chem. Res.* 32, 1542–1548.
- Elliot, D.C., Phelps, M.R., Sealock, L.J., Baker, E.G., 1994. Chemical processing in high pressure aqueous environments. 3. Continuous-flow reactor process development experiments for organics destruction. *Ind. Eng. Chem. Res.* 33, 566–574.
- Fenton, O., Ó hUallacháin, D., 2012. Agricultural nutrient surpluses as potential input sources to grow third generation biomass (microalgae): A review. *Algal Res* 1, 49–56.
- Foley, P.M., Beach, E.S., Zimmerman, J.B., 2011. Algae as a source of renewable chemicals: opportunities and challenges. *Green Chem* 13, 1399–1405.
- Franck, E.U., Weingärtner, H., 1999. IUPAC—Chemical Thermodynamics. In: Letcher, T.M. (Ed.), Blackwell, U.K, Oxford, p. 105.
- Garcia, A.L., Torri, C., Samori, C., van der Spek, J., Fabbri, D., Kersten, S.R.A., et al., 2012. Hydrothermal treatment (HTT) of microalgae: evaluation of the process as conversion method in an algae biorefinery concept. *Energy Fuels* 26, 642–657.
- Guan, Q., Savage, P.E., Wei, C., 2012. Gasification of alga *Nannochloropsis* sp. in supercritical water. *J. Supercrit Fluid* 61, 139–145.
- Goudriaan, et al., 2000. Thermal efficiency of the HTU process for biomass liquefaction. In: Proceedings of the Progress in Thermochemical Biomass Conversion, Tyrol, Austria.
- Goudriaan, F., van de Beld, B., Boerefijn, F.R., Bos, G.M., Naber, J.E., van der Wal, S., et al., 2001. In: Brigdwater, A.V. (Ed.), Progress in thermochemical biomass Conversion 2. Blackwell Science, Oxford, U.K., pp. 1312–1325.

- Hayashi, N., Sugiyama, J., Okano, T., Ishihara, M., 1997. Selective degradation of the cellulose I-alpha component in *Cladophora* cellulose with *Trichoderma viride* cellulase. *Carbohydr. Res.* 305, 109–116.
- He, B., 2000. Thermochemical conversion of swine manure to produce oil and reduce waste. Ph.D. Dissertation, University of Illinois at Urbana–Champaign, Urbana, IL, USA.
- Heilmann, S.M., Davis, H.T., Jader, L.R., Lefebvre, P.A., Sadowsky, M.J., Schendel, F.J., et al., 2010. Hydrothermal carbonization of microalgae. *Biomass Bioenerg.* 34, 875–882.
- Heilmann, S.M., Jader, L.R., Harned, L.A., Sadowsky, M.J., Schendel, F.J., Lefebvre, P.A., et al., 2011. Hydrothermal carbonization of microalgae II. Fatty acid, char, and algal nutrient products. *Appl. Energ.* 88, 3286–3290.
- Horn, S.J., Aasen, I.M., Ostgaard, K., 2000. Ethanol production from seaweed extract. *J. Ind. Microbiol. Biot.* 25, 249–254.
- Hu, X., Xu, Y., Li, W., 2011. Method for preparation of fuel oil substitute by catalytic direct liquefaction of algal biomass. CN 102002381 A 20110406.
- Huber, G.W., Iborra, S., Corma, A., 2006. Synthesis of transportation fuels from biomass: Chemistry, catalysts, and engineering. *Chem. Rev.* 106, 4044–4098.
- Karagoz, S., Bhaskar, T., Muto, A., Sakata, Y., 2006. Hydrothermal upgrading of biomass: effect of K_2CO_3 concentration and biomass/water ratio on products distribution. *Bioresour. Technol.* 97, 90–98.
- Khambhaty, Y., Mody, K., Gandhi, M.R., Thampy, S., Maiti, P., Brahmbhatt, H., et al., 2012. *Kappaphycus alvarezii* as a source of bio ethanol. *Bioresour. Technol.* 103, 180–185.
- Kim, N.J., Li, H., Jung, K., Chang, H.N., Lee, P.C., 2011. Ethanol production from marine algal hydrolysates using *Escherichia coli* KO11. *Bioresour. Technol.* 102, 7466–7469.
- Knuckey, R.M., Brown, M.R., Robert, R., Frampton, D.M.F., 2006. Production of microalgal concentrates by flocculation and their assessment as aquaculture feeds. *Aquacult. Eng.* 35, 300–313.
- Kobayashi, N., Okada, N., Tanabe, Y., Itaya, Y., 2011. Fluid Behavior of Woody Biomass Slurry during Hydrothermal Treatment. *Ind. Eng. Chem. Res.* 50, 4133–4139.
- Kröger, M., Müller-Langer, F., 2012. Review on possible algal-biofuel production processes. *Biofuels* 3, 333–349.
- Kumar, S., 2010. Hydrothermal Treatment for Biofuels: Lignocellulosic Biomass to Bioethanol, Biocrude, and Biochar. Ph.D. dissertation, Auburn University, Alabama, USA.
- Li, D., Chen, L., Xu, D., Zhang, X., Ye, N., Chen, F., et al., 2012. Preparation and characteristics of bio-oil from the marine brown alga *Sargassum patens* C. Agardh. *Bioresour. Technol.* 104, 737–742.
- Luning, K., Pang, S.J., 2003. Mass cultivation of seaweeds: current aspects and approaches. *J. Appl. Psychol.* 15, 115–119.
- Manarungson, S., Mok, W.S., Antal Jr., M.J., 1990. Abstr. Pap. Am. Chem. Soc .
- McHugh, D.J., 2003. A guide to the seaweed industry. FAO, Rome FAO Fisheries Technical Paper No. 441.
- Meinita, M.D.N., Kang, J.Y., Jeong, G.T., Koo, H.M., Park, S.M., Hong, Y.K., 2012. Bioethanol production from the acid hydrolysate of the *carrageenophyte Kappaphycus alvarezii* (cottonii). *J. Appl. Phycol.* 4, 857–862.
- Menetrez, M.Y., 2012. An overview of algae biofuel production and potential environmental impact. *Environ. Sci. Technol.* 46, 7073–7085.
- Minowa, T., Zhen, F., Ogi, T., 1998. Cellulose decomposition in hot-compressed water with alkali or nickel catalyst. *J. Supercrit. Fluids* 13, 253–259.
- Minowa, T., Inoue, S., 1999. Hydrogen production from biomass by catalytic gasification in hot compressed water. *Renew. Energ.* 16, 1114–1117.
- Mok, W.S.L., Antal, M.J., Varhegyi, G., 1992. Productive and parasitic pathways in dilute acid-catalyzed hydrolysis of cellulose. *Ind. Eng. Chem. Res.* 31, 94–100.
- Molina Grima, E.M., Belarbi, E.H., Fernandez, F.G.A., Medina, A.R., Chisti, Y., 2003. Recovery of microalgal biomass and metabolites: process options and economics. *Biotechnol. Adv.* 20, 491–515.
- Moller, M., Nilges, P., Harnisch, F., Schroder, U., 2011. Subcritical water as reaction environment: Fundamentals of hydrothermal biomass transformation. *ChemSusChem* 4, 566–579.
- Navarro, R.M., Sa´nchez-Sa´nchez, M.C., Alvarez-Galvan, M.C., del Valle, F., Fierro, J.L.G., 2009. Hydrogen production from renewable sources: biomass and photocatalytic opportunities. *Energ. Environ. Sci.* 2, 35–54.
- Nguyen, M.T., Choi, S.P., Lee, J., Lee, J.H., Sim, S.J., 2009. Hydrothermal acid pretreatment of *Chlamydomonas reinhardtii* biomass for ethanol production. *J. Microbiol. Biotechnol.* 19, 161–166.
- Oswald, W.J., Golueke, C.G., 1960. Biological transformation of Solar Energy. *Adv. Appl. Microbiol.* 2, 223–262.
- Pan, P., Hu, C., Yang, L., Li, Y., Dong, L., Zhu, L., et al., 2010. The direct pyrolysis and catalytic pyrolysis of *Nannochloropsis* sp. residue for renewable bio-oils. *Bioresour. Technol.* 101, 4593–4599.

- Peterson, A.A., Vogel, F., Lachance, R.P., Froling, M., Antal, M.J., Tester, J.W., 2008. Thermochemical biofuel production in hydrothermal media: a review of sub- and supercritical water technologies. *Energy Environ. Sci.* 1, 32–65.
- Poelman, E., DePauw, N., Jeurissen, B., 1997. Potential of electrolytic flocculation for recovery of micro-algae. *Res. Conserv. Recycl.* 19, 1–10.
- Pulz, O., Gross, W., 2004. Valuable products from biotechnology of microalgae. *Appl. Microbiol. Biotechnol.* 65, 635–648.
- Ross, A.B., Jones, J.M., Kubacki, M.L., Bridgeman, T., 2008. Classification of macro algae as fuel and its thermochemical behavior. *Bioresour. Technol.* 99, 6494–6504.
- Ross, A.B., Biller, P., Kubacki, M.L., Li, H., Lea-Langton, A., Jones, J.M., 2010. Hydrothermal processing of microalgae using alkali and organic acids. *Fuel* 89, 2234–2243.
- Rossignol, N., Lebeau, T., Jaouen, P., Robert, J.M., 2000. Comparison of two membrane photobioreactors, with free or immobilized cells, for the production of pigments by a marine diatom. *Bioprocess Eng.* 23, 495–501.
- Ruyter, et al., 1987. Process for producing hydrocarbon-containing liquids from biomass. U.S. Patent 4,670,613, to Shell International Research.
- Sakaki, T., Shibata, M., Miki, T., Hirose, H., 1998. Oligosaccharification of cellulose using a hot compressed water flow type reactor and enzymatic hydrolysis of formed oligosaccharide. *J. Jpn. Inst. Energy* 77, 1111–1115.
- Salis, A., 2010. In: Timmis, K.N. (Ed.), *Handbook of Hydrocarbon and Lipid Microbiology*. Springer-Verlag, Berlin, Germany, pp. 2827–2839.
- Savage, P., Changi, S., Dickinson, J., 2012a. Insights from model compound studies into hydrothermal production of hydrocarbons from algae. Abstracts of Papers, 244th ACS National Meeting & Exposition, Philadelphia, PA, USA.
- Savage, P., Valdez, P., Li, Z., 2012b. Abstracts of Papers, 244th ACS National Meeting & Exposition, Hydrothermal process for making hydrocarbons from wet algal biomass. Philadelphia, PA, USA.
- Schmieder, H., Abeln, J., Boukis, N., Dinjus, E., Kruse, A., Kluth, M., et al., 2000. Hydrothermal gasification of biomass and organic wastes. *J. Supercrit. Fluids* 17, 145–153.
- Schumacher, M., Yanik, J., Sinäg, A., Kruse, A., 2011. Hydrothermal conversion of seaweeds in a batch autoclave. *J. Supercrit. Fluids* 58, 131–135.
- Shen, Z., Zhou, J., Zhou, X., Zhang, Y., 2011. The production of acetic acid from microalgae under hydrothermal conditions. *Appl. Energy* 88, 3444–3447.
- Shuping, Z., Yulong, W., Mingde, Y., Kaleem, I., Chun, L., Tong, J., 2010. Production and characterization of bio-oil from hydrothermal liquefaction of microalgae *Dunaliella tertiolecta* cake. *Energy* 35, 5406–5411.
- Sinag, A., Kruse, A., Rathert, J., 2004. Influence of the heating rate and the type of catalyst on the formation of key intermediates and on the generation of gases during hydrolysis of glucose in supercritical water in a batch reactor. *Ind. Eng. Chem. Res.* 43, 502–508.
- Siskin, M., Katritzky, A., 1991. Reactivity of organic compounds in hot water: Geochemical and technological implications. *Science* 254, 231–237.
- Song, C., Hu, H., Zhu, S., Wang, G., Chen, G., 2004. Non-isothermal catalytic liquefaction of corn stalk in subcritical and supercritical water. *Energy Fuels* 18, 90–96.
- Toor, S.S., Rosendahl, L., Rudolf, A., 2011. Hydrothermal liquefaction of biomass: A review of subcritical water technologies. *Energy* 36, 2328–2342.
- Trent, J., 2012. OMEGA: The future of biofuels? In: The ASEAN algae biofuels conference Singapore.
- U.S. DOE, 2006. Report to Congress on the interdependence of energy and water. U.S. Department of Energy, Washington, D.C., USA.
- Valdez, P.J., Dickinson, J.G., Savage, P.E., 2011. Characterization of Product Fractions from Hydrothermal Liquefaction of *Nannochloropsis* sp. and the Influence of Solvents. *Energy Fuels* 25, 3235–3243.
- Valdez, P.J., Nelson, M.C., Wang, H.Y., Lin, X.N., Savage, P.E., 2012. Hydrothermal liquefaction of *Nannochloropsis* sp.: Systematic study of process variables and analysis of the product fractions. *Biomass Bioenergy* 1–15, in press.
- Vardon, D.R., Sharma, B.K., Scott, J., Yu, G., Wang, Z., Schideman, L., et al., 2011. Chemical properties of biocrude oil from the hydrothermal liquefaction of *Spirulina algae*, swine manure, and digested anaerobic sludge. *Bioresour. Technol.* 102, 8295–8303.
- Vardon, D.R., Sharma, B.K., Blazina, G.V., Rajagopalan, K., Strathmann, T.J., 2012. Thermochemical conversion of raw and defatted algal biomass via hydrothermal liquefaction and slow pyrolysis. *Bioresour. Technol.* 109, 178–187.

- Varfolomeev, S.D., Wasserman, L.A., 2011. Microalgae as Source of Biofuel, Food, Fodder, and Medicines. *Appl. Biochem. Microbiol.* 47, 789–807.
- Vonshak, A., 1990. Recent advances in microalgal biotechnology. *Biotech. Adv.* 8, 709–727.
- Watanabe, M., Aizawa, Y., Iida, T., Aida, T.M., Levy, C., Sue, K., et al., 2005. Glucose reactions with acid and base catalysts in hot compressed water at 473 K. *Carbohydr. Res.* 340, 1925–1930.
- Watanabe, M., Iida, T., Inomata, H., 2006. Decomposition of a long chain saturated fatty acid with some additives in hot compressed water. *Energy Convers. Manage.* 47, 3344–3350.
- Yang, B.Y., Montgomery, R., 1996. Alkaline degradation of glucose: effect of initial concentration of reactants. *Carbohydr. Res.* 280, 27–45.
- Yu, G., Zhang, Y., Schideman, L., Funk, T., Wang, Z., Urbana, I.L., 2011. Distributions of carbon and nitrogen in the products from hydrothermal liquefaction of low-lipid microalgae. *Energy Environ. Sci.* 4, 4587–4595.
- Zhang, Y., 2010. Hydrothermal Liquefaction to Convert Biomass into Crude Oil. In: Blaschek, H.P., Ezeji, T.C., Scheffran, J. (Eds.), *Biofuels from Agricultural Wastes and Byproducts*. Blackwell Publishing, pp. 201–232.
- Zhou, D., Zhang, L., Zhang, S., Fu, H., Chen, J., 2010. Hydrothermal liquefaction of macro algae *Enteromorpha prolifera* to bio-oil. *Energy Fuels* 24, 4054–4061.
- Zhou, D., Zhang, S., Fu, H., Chen, J., 2012. Liquefaction of Macro algae *Enteromorpha prolifera* in Sub-/Supercritical Alcohols: Direct Production of Ester Compounds. *Energy Fuels* 26, 2342–2351.

Scale-Up and Commercialization of Algal Cultivation and Biofuel Production

Man Kee Lam, Keat Teong Lee

School of Chemical Engineering, Universiti Sains Malaysia, Pulau Pinang, Malaysia

12.1 INTRODUCTION

Increasing energy demand coupled with serious environmental concerns over the last 10 years have made the search for renewable and sustainable energy a key challenge of this century (Singh and Gu, 2010). To date, many countries are still heavily dependent on crude petroleum as a source of transportation fuel, and the price of petroleum has always fluctuated in the global fuel market. In addition, 57.7% of the primary energy consumed has been used in the transportation sector, where the consumption rate of fossil diesel fuel was estimated to be 934 million tonnes per year (Kulkarni and Dalai, 2006; Lam et al., 2010). Nevertheless, fossil fuels are nonrenewable resources that are limited in supply and will one day be exhausted (Sharma and Singh, 2009). The concern regarding limited energy resources is caused by the rapid growth in human population and industrialization (Pimentel and Pimentel, 2006). Due to our knowledge of the impending shortage of energy resources, the era of inexpensive fossil fuel no longer exists. Instead, the world is facing a shortage in the fossil fuel supply, bitter conflicts, and an increasing number of undernourished people, especially in the undeveloped countries (Lam et al., 2010).

Lately, much attention has been devoted to the cultivation of algae for biofuel production. Algae are desirable for biofuel production compared to land-based plants because (1) algae are fast-growing microorganisms, with reproducibility 100 times faster than land-based plants and able to double their biomass in less than one day; (2) some algal strains can accumulate significant amounts of lipids within their cells (as high as 75% of their weight), and the

lipids can be converted to biodiesel; (3) algal-based biofuels do not interfere with food security concerns; (4) fertile land is not required to cultivate algae and thus their cultivation does not compete with agricultural land, and (5) cultivation of algae could be coupled with wastewater treatment and biological CO₂ mitigation that enhances the sustainability of algal-based biofuels (Chisti, 2007; Mata et al., 2010; Mutanda et al., 2011; Pittman et al., 2011). The residue of algal biomass after lipid extraction could be further converted to produce different types of biofuels such as bioethanol, biomethane, and biohydrogen (Harun et al., 2010). Examples of algal strains that have been widely evaluated for biofuel production include *Botryococcus braunii*, *Neochloris oleabundans*, *Nannochloropsis* sp., *Chlorella vulgaris*, *Dunaliella salina*, and *Haematococcus pluvialis* (Chisti, 2007; Harun et al., 2010; Mata et al., 2010; Singh and Gu, 2010).

To date, large-scale algal cultivation still faces several technical challenges that hinder the commercialization potential of algal biomass as a renewable feedstock for biofuel production. The challenges can be divided into two categories: (1) upstream processes: algal selection and cultivation method, energy input for operating closed photobioreactors, nutrient sources, water reusability and footprint, and sensitivity of algae to surrounding environment; and (2) downstream processes: harvesting and drying techniques for algal cells, effective algal lipid extraction methods, algal biodiesel conversion technologies, and biodiesel quality and potential to diversify biofuel production from algal residue after the lipid-extraction process. Beyond the technical challenges, the economic feasibility of commercial algal biofuel production is still questionable because algal cultivation and associated biofuel production technologies are still under development. As such, an in-depth understanding of these technical and economically related problems should be able to help identify possible solutions to enhance the commercial potential of algal biofuels (Bull and Collins, 2012). In this chapter, several important technical problems surrounding the entire algal biofuels supply chain are discussed, especially from a thermodynamic (energy-balance) perspective. In addition, techno-economic assessments of algal biofuel production are included at the end of this chapter to benchmark the current status of algal biofuels compared to fossil fuels and other renewable fuels.

12.2 LIFE-CYCLE ENERGY BALANCE OF ALGAL BIOFUELS

Ever since the positive prospects of cultivating algal cells for biofuel production began being extensively deliberated in the literature (Chisti, 2007; Singh et al., 2011; Singh and Gu, 2010; Wijffels and Barbosa, 2010), recent active research and development have further propelled this industry a step closer to scaling up and commercialization. However, the issue of energy balance in the entire system boundary of algal biofuels is not clearly addressed, mainly due to limited availability of commercial cultivation plants for technical assessment. Based on several life-cycle assessments (LCAs) of algal biofuel production, most of the studies unfortunately revealed a negative energy balance in their assessments, especially when algae were cultivated in closed photobioreactors (Jorquera et al., 2010; Razon and Tan, 2011; Stephenson et al., 2010). Although some important parameters (biomass yield, lipid productivity, specific growth rate) assumed in the LCA studies were predominantly based on findings from laboratory scale and might be irrelevant for large-scale production, it gives

a baseline to visualize and to verify energy balance-related problems in the algal biofuel production system. As a result, several precautionary steps could be suggested to further improve the energy conversion efficiency of algal biofuel production before commencing the commercialization stage.

Energy-efficiency ratio (EER) is usually used as an indicator to address the energy conversion efficiency for the entire biofuel production process. The EER is defined as the ratio of total energy output to total energy input, where a ratio higher than 1 designates net positive energy generated, and vice versa (Lam and Lee, 2012; Lam et al., 2009). Table 12.1 shows a comparative study on EER for biodiesel derived from various energy feedstocks such as oil palm, jatropha, rapeseed, sunflower, and algae. The values presented in the table are a rough indicator because all the LCA studies were conducted based on different assumptions and system boundaries. From the information presented in the table, it can be observed that biodiesel derived from oil-bearing crops is much more energy efficient than biodiesel derived from algae. All the EER values for biodiesel derived from oil-bearing crops are more than 1, whereas algal-derived biodiesel has an EER value as low as 0.07. These quantitative results showed that the cultivation of algae for biodiesel production does not necessarily produce a positive energy output but, worse still, could pose a critical risk of unsustainable biodiesel production. In addition, several issues such as reusability of water to recultivate algae, the possibility of using contaminated wastewater as a nutrient source, and the extraction and transesterification conversion efficiency have not been clearly accounted for in those LCA studies. If these factors are taken into consideration, the EER value is expected to decrease significantly.

However, there are exceptional cases where the EER values are positive, such as those studies performed by Lardon et al. (2009), Batan et al. (2010), Jorquera et al. (2010), Sander and Murthy (2010), and Clarens et al. (2010). These studies highlighted the importance of choosing suitable cultivation methods (e.g., nutrient deficiency to increase lipid productivity), nutrient sources (e.g., wastewater), open pond/photobioreactor design, and downstream biomass

TABLE 12.1 Energy-efficiency Ratio (EER) for Various Energy Crops and Algae.

Feedstock	EER	Comment	Reference
Oil-bearing crops			
Jatropha	1.92	Included coproduct production	(Lam et al., 2009)
Jatropha	1.85	Excluded biogas production	(Achten et al., 2010)
Jatropha	3.4	Included biogas production	(Achten et al., 2010)
Palm oil	2.27	Included coproduct production	(Lam et al., 2009)
Palm oil	3.53	Included coproduct production	(Yee et al., 2009)
Palm oil	3.58	Included coproduct production	(Pleanjai and Gheewala, 2009)
Palm oil	2.42	Excluded coproduct production	(Pleanjai and Gheewala, 2009)

Continued

TABLE 12.1 Energy-efficiency Ratio (EER) for Various Energy Crops and Algae—Cont'd

Feedstock	EER	Comment	Reference
Rapeseed	1.44	Included coproduct production	(Yee et al., 2009)
Rapeseed	5	Based on Chilean conditions	(Iriarte et al., 2010)
Sunflower	3.5	Based on Chilean conditions	(Iriarte et al., 2010)
Algae			
<i>Chlorella vulgaris</i>	0.35	Tubular photobioreactor	(Stephenson et al., 2010)
<i>Chlorella vulgaris</i>	1.46	Raceway pond	(Stephenson et al., 2010)
<i>Chlorella vulgaris</i>	0.98	Sufficient nutrients condition and biomass are dried prior to extraction	(Lardon et al., 2009)
<i>Chlorella vulgaris</i>	3.54	Sufficient nutrients condition and biomass are not dried prior to extraction	(Lardon et al., 2009)
<i>Chlorella vulgaris</i>	1.25	Low nitrogen culture and biomass are dried prior to extraction	(Lardon et al., 2009)
<i>Chlorella vulgaris</i>	4.34	Low nitrogen culture and biomass are not dried for extraction	(Lardon et al., 2009)
<i>Haematococcus pluvaris</i>	0.25–0.54	<i>Haematococcus pluvaris</i> strain	(Razon and Tan, 2011)
<i>Nannochloropsis</i>	0.09–0.12	<i>Nannochloropsis</i> strain	(Razon and Tan, 2011)
<i>Nannochloropsis</i>	1.08	<i>Nannochloropsis</i> strain	(Batan et al., 2010)
<i>Nannochloropsis</i> sp.	3.05	Raceways: The system boundary is limited to the cultivation stage, excluding dewatering, drying, extraction, and transesterification stages	(Jorquera et al., 2010)
<i>Nannochloropsis</i> sp.	1.65	Flat plate: The system boundary is limited to the cultivation stage, excluding dewatering, drying, extraction, and transesterification stages	(Jorquera et al., 2010)
<i>Nannochloropsis</i> sp.	0.07	Tubular photobioreactors: The system boundary is limited to the cultivation stage, excluding dewatering, drying, extraction, and transesterification stages	(Jorquera et al., 2010)
Not specified	3.33	Filter press as primary dewatering method (bioethanol is considered a secondary product)	(Sander and Murthy, 2010)
Not specified	1.77	Centrifuge as primary dewatering method (bioethanol is considered a secondary product)	(Sander and Murthy, 2010)
Not specified	1.06	Base case: Inorganic (chemical) fertilizers as nutrient source	(Clarens et al., 2010)
Not specified	13.2	Conventional activated sludge as nutrient source	(Clarens et al., 2010)

processing options that can enhance the EER value of algal biodiesel. In the following sections, several energy-related problems in producing algal biofuels are comprehensively elaborated to propose possible strategies to commercialize this renewable fuel.

12.2.1 Open Ponds and Closed Photobioreactors

To commercialize algal biofuels, the first challenge is the mass production of algal biomass with minimal energy input and in a cost-effective manner. Phototrophic cultivation appears to be the preferred method to cultivate algae because sunlight is abundantly available at no cost. Apart from that, phototrophic algae are able to capture CO₂ from flue gases and could potentially act as a superior carbon sink, offering an added advantage to this cultivation method. However, this method has its limitations, especially in temperate countries where suitable sunlight intensity is not always available throughout the year (Lam and Lee, 2012). The open pond system and the closed photobioreactor are among the cultivation systems that are suitable for growing phototrophic algae. An ideal cultivation system should meet the following requirements: (1) has a large effective illumination area, (2) utilizes optimal gas-liquid transfer, (3) is simple to operate, (4) maintains a low contamination level, (5) has low capital and operating costs, and (6) utilizes a minimal amount of land (Xu et al., 2009). Unfortunately, this ideal cultivation system is yet to be realized, even with intensive research and field trials.

The following section details the basic design of the open and closed photobioreactors, including their advantages, limitations, and factors to consider before attempting to scale up both cultivation systems.

12.2.1.1 Raceway Pond Systems

The raceway pond system is currently the most economically feasible cultivation method for mass production of algal biomass, primarily due to its relatively low capital cost and ease of operation. The pond usually consists of a closed-loop recirculation channel (oval in shape) where mixing and circulation are provided by paddlewheels to avoid algal biomass sedimentation. The CO₂ source is sparged at the bottom of the raceway pond, as shown in Figure 12.1 (Chisti, 2007; Greenwell et al., 2010; Stephenson et al., 2010). Some raceway ponds incorporate artificial light in the system; however, this design is not practical and is economically infeasible for commercial production (Singh et al., 2011).

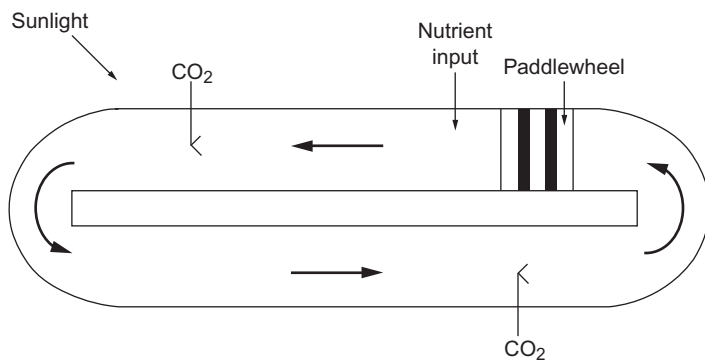

FIGURE 12.1 Raceway pond for algal cultivation. (Modified from Brennan and Owende, 2010.)

Raceway ponds are normally constructed with either concrete or compacted earth and lined with white plastic bags. The depth of the pond is usually 0.2–0.5 m to ensure that algae receive adequate exposure to sunlight (Brennan and Owende, 2010; Chisti, 2007). Under this cultivation system, the recorded algal biomass productivity and yield were 0.05–0.1 g/L/day and 0.3–0.5 g/L, respectively (Pulz, 2001); but are highly dependent on algal strains, cultivation conditions, and local weather.

Although raceway ponds have the advantages of low energy input and low operating cost, this system still suffers several limitations, such as massive loss of water due to high evaporation rate and being easily contaminated by undesired microorganisms (e.g., bacteria, fungus, and protozoa) that could annihilate the entire algal population (Schenk et al., 2008). Hence, regular cleaning and maintenance are required in the raceway pond to ensure that the algae are growing under optimal conditions. In this regard, high lipid content and biomass productivity of algae for biofuel production are not the only factors to be considered, but other considerations such as fast growth rate, ease of cultivation, and ability to survive under extreme environmental conditions are equally important to ensure the existence of monoculture in a raceway pond. *Chlorella*, for example, can grow well in a nutrient-rich medium, *Spirulina* grows favorably at high pH and bicarbonate concentration, and *D. salina* is well adapted to a highly saline medium (Borowitzka, 1999; Brennan and Owende, 2010).

12.2.1.2 Closed Photobioreactors

To overcome the limitations of the open pond system in algae cultivation, closed photobioreactors are designed to ensure that algal cells are always grown under optimal conditions with high consistency in biomass productivity. Since the conditions in a closed photobioreactor system are strictly controlled, the contamination level in the cultivation medium is minimized. This permits the cultivating of single algal strain for a prolonged period, and water sources may be reutilized for subsequent cultivation cycles (Brennan and Owende, 2010; Chisti, 2007). Closed photobioreactors are a more flexible system than the raceway pond because the photobioreactors can be optimized according to the biological and physiological characteristics of the algal strain that is being cultivated (Mata et al., 2010). For example, cultivation pH, temperature, CO₂ concentration, mixing intensity, and nutrient level can be manipulated to suit the optimal growing conditions of different algal strains.

These advantages have attracted the interest of many researchers to further improve on the operating conditions of closed photobioreactors for commercial-scale implementations. Depending on the algal strains and cultivation conditions, a closed photobioreactor always offers high biomass productivity, generally in the range of 0.05–3.8 g/L/day (Brennan and Owende, 2010). Several types of closed photobioreactor designs, such as flat plate, tubular, and column, are discussed in Table 12.2. For comparison purposes, the characteristics of a raceway pond are also included in Table 12.2.

Recently, a few LCA studies have been performed to evaluate the overall energy balance for cultivating algal biomass in raceway ponds and airlift tubular closed photobioreactors, as shown in Table 12.3. From the table, we see that the airlift tubular photobioreactor can achieve high biomass productivity compared to the raceway pond, but the energy input to operate the entire system was approximately 350% higher than for the raceway pond. Despite the advantages of low contamination and minimum water loss due to evaporation, the airlift tubular photobioreactor consumed a huge amount of electricity to power heavy-duty pumps so that

TABLE 12.2 Various Photobioreactor Designs for Algal Cultivation. (Chisti, 2007; Mata et al., 2010; Sierra et al., 2008; Ugwu et al., 2008; Xu et al., 2009)

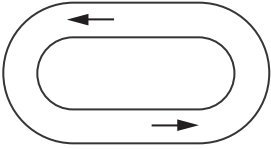
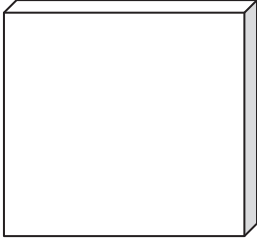
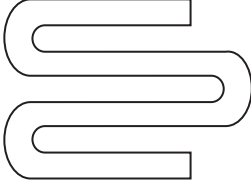
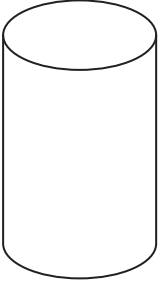
	Raceway Pond	Flat Plate	Tubular	Vertical Column
Conceptual design				
Design characteristics	<p>Consists of closed-loop recirculation channel (oval shape)</p> <p>Usually built using concrete or compacted earth-lined pond with white plastic</p> <p>Mixing and circulation are provided by paddlewheels</p> <p>The depth of the pond is usually 0.2–0.5 m to ensure algae receive adequate exposure to sunlight</p>	<p>Bioreactor with rectangular shape</p> <p>The flat plates are usually made of transparent plastic or glass</p> <p>Usually coupled with gas sparger</p> <p>The light path (depth) is dependent on algal strain; ranges between 1.3 and 10 cm</p>	<p>Consists of an array of straight, coiled, or looped transparent tubes</p> <p>The tubes are usually made of transparent plastic or glass</p> <p>Usually coupled with a pump or airlift technology</p> <p>Tube diameter is limited (0.1 m) to increase the surface/volume ratio</p>	<p>Bioreactor with vertically arranged cylindrical column</p> <p>The columns are usually made of transparent plastic or glass</p> <p>Usually coupled with a pump or airlift technology</p> <p>Optimum column diameter is 0.2 m with 4 m height</p>
Advantages	Easy to construct and operate	Large illumination surface area gives maximum utilization of solar energy	Large illumination surface area	High mass-transfer rate with good mixing

Continued

TABLE 12.2 Various Photobioreactor Designs for Algal Cultivation (Chisti, 2007; Mata et al., 2010; Sierra et al., 2008; Ugwu et al., 2008; Xu et al., 2009)—Cont'd

	Raceway Pond	Flat Plate	Tubular	Vertical Column
	Low energy input and low cost	Low concentration of dissolved oxygen	Relatively higher biomass productivity	Compact, easy to operate, and relatively low cost
		Can be positioned vertically or inclined at an optimum angle facing the sun	Potential of cell damage is minimized if airlift system is used	Lower power consumption
		Lower power consumption		
Disadvantages	Water loss due to high evaporation rate	Scale-up requires many compartments and support materials	Requires large land area because long tubes are used	Small illumination surface area
	Difficulty in controlling the temperature and pH	Difficulty in controlling culture temperature	Potential in accumulating high concentration of O ₂ (poison to algae) in culture medium if tubes are too long	Cell sedimentation may occur if airlift system is not used
	Susceptible to contamination		Decreasing CO ₂ concentration along the tubes may cause the algae to be deprived of carbon source	
			Mixing is problematic in extended tubes	

TABLE 12.3 Energy Consumption in Various Algal Culture Systems. (Razon and Tan, 2011)

Culture System	Energy Consumption ^a (GJ/Tonne of Biodiesel)	Reference
Raceway	4–11	(Lardon et al., 2009)
Raceway	13–15	(Jorquera et al., 2010)
Raceway	22–30	(Stephenson et al., 2010)
Raceway	53–158	(Campbell et al., 2011)
Airlift tubular	195–231	(Stephenson et al., 2010)
Airlift tubular	537	(Jorquera et al., 2010)

^a Energy associated with electricity consumption to operate culture system.

Raceway: Paddlewheel and gas sparging

Flat plate: Pump and gas sparging

Airlift tubular: Airlift pump and gas sparging

sufficient mixing and optimum gas–liquid transfer rate are attained. Cultivating algae using the airlift tubular photobioreactor could easily lead to a negative energy balance in producing algal biofuels if no precautionary steps are taken to reduce the energy input. Furthermore, the energy input does not include the energy used for artificial lights during the nighttime, harvesting and drying of algal biomass, water treatment, lipid extraction, and biodiesel conversion. If these factors are taken into consideration, the overall energy balance for cultivating algae for biofuel production is expected to be even more negative, as revealed by Stephenson et al. (2010) and Razon and Tan (2011) (Table 12.1). Other photobioreactor designs, such as column type and flat plate, are relatively low cost compared to airlift tubular photobioreactors, making them more feasible for commercialization. However, more extensive research is required to improve the CO₂ transfer and mixing in these photobioreactors with minimum energy input.

12.2.2 Harvesting and Drying of Algal Biomass

Harvesting of algal biomass refers to the separation of algae from water for subsequent biofuel production. The process consists of two distinctive steps: (1) bulk harvesting, to separate algae from bulk suspension via gravity sedimentation, flocculation, and flotation, and (2) thickening, to concentrate the algal slurry after bulk harvesting using techniques such as centrifugation and filtration (Brennan and Owende, 2010; Chen et al., 2011). Harvesting of algal biomass is extremely challenging because of algae's small cell size (generally 1–20 µm) and suspension in water (Lam and Lee, 2012; Suali and Sarbatly, 2012). The mass ratio of algal biomass to water is considered very low, even if the algae are cultivated in a closed photobioreactor (Chen et al., 2011). For example, the mass ratio of algal biomass to water lies in the range of 0.00035–0.027 for algae cultivated in a closed photobioreactor, assuming a biomass productivity of 0.05–3.8 g/L/day and cultivated for seven days. When the algal cultivation system (typically a closed photobioreactor) is scaled up for mass production of algal biomass, an average of 73 tonnes of water need to be processed when harvesting 1 tonne of algal biomass. This amount of water is quite substantial; thus, developing effective algal

harvesting methods is exceptionally important to strengthen the possibility of commercializing algal biofuel production. Table 12.4 summarizes the current available algal biomass harvesting technologies.

A recent LCA study revealed that current technologies for harvesting and drying algal biomass consumed a significant amount of energy input to produce algal biodiesel (Sander and Murthy, 2010). The study assessed two types of algal thickening methods (without prior bulk harvesting), namely, filter press and centrifugation, and reported that each method contributed 88.6% and 92.7%, respectively, to the total energy input for the LCA. Thus,

TABLE 12.4 Algal Biomass Harvesting Methods. (Brennan and Owende, 2010; Greenwell et al., 2010; Molina Grima et al., 2003; Schenk et al., 2008)

Harvesting Method	Process Description	Advantages	Disadvantages
Centrifugation	Governed by Stokes' law: Sedimentation of suspended solids is determined by density and radius of algal cells Concentrated algal biomass can be obtained Centrifugation force: 5,000–10,000 g with 95% removal efficiency	Rapid and efficient	Energy intensive and high maintenance cost
Flocculation	To aggregate the algal biomass to a larger size and hence ease sedimentation Flocculants used: Ferric chloride (FeCl_3), aluminum sulfate ($\text{Al}_2(\text{SO}_4)_3$, alum), and ferric sulfate ($\text{Fe}_2(\text{SO}_4)_3$) Normally used as a pretreatment step to centrifugation, gravity sedimentation, and filtration	Cost effective	The algal biomass cannot be used for some downstream applications such as animal feed or for anaerobic digestion
Floation	Trapping algal biomass by dispersing micro air bubbles The fine bubbles (less than 10 μm) adhere to the biomass (after flocculation process), making them very buoyant and causing them to rise rapidly to the surface	Applicable to process large volume of biomass	Toxicity of flocculants may reduce algal biomass value
Filtration	Filter press and membrane filter (micro and ultrafiltration) are operated under pressurized or vacuum condition	Filter press: Effective in recovering algae of relatively large size (e.g., <i>Spirulina platensis</i>)	Filter press: Ineffective to recover small algae (e.g., <i>Scenedesmus</i> and <i>Chlorella</i>)

Continued

TABLE 12.4 Algal Biomass Harvesting Methods (Brennan and Owende, 2010; Greenwell et al., 2010; Molina Grima et al., 2003; Schenk et al., 2008)—Cont'd

Harvesting Method	Process Description	Advantages	Disadvantages
		Micro/ultrafiltration: Effective in recovering large and small algae	Micro/ultrafiltration: High cost due to membrane replacement, membrane clogging, and maintenance
Gravity sedimentation	Governed by Stokes' law: Sedimentation of suspended solids is determined by density and radius of algal cells Algae are left to settle naturally by means of gravity	Low cost because no additional chemicals or physical treatment needed	Requires relatively longer settling time Not effective for small algae
Ultrasonication	Ultrasound wave (20–100 MHz) compresses and stretches molecular spacing of a medium through which it passes and hence creates a cavitation effect Algal cells are disrupted immediately, thus facilitating sedimentation rate	Can be operated continuously without inducing shear stress on the algal biomass	Safety problem

harvesting algal biomass using solely centrifugation or filtration is still far from commercial application because of the high energy consumption and high operating cost.

On the other hand, bulk harvesting methods such as flocculation offer an alternative approach to harvesting algal biomass with lower energy input and at a reasonable cost. Conventional flocculants, such as ferric chloride (FeCl_3), aluminium sulphate ($\text{Al}_2(\text{SO}_4)_3$), and ferric sulphate ($\text{Fe}_2(\text{SO}_4)_3$) (Brennan and Owende, 2010), which are widely used in wastewater treatment plants, can be used to agglomerate algal cells to become dense flocs (slurry) and subsequently settle out of the cultivation medium (de Godos et al., 2011). After the flocculation process, water that is still retained in the algal slurry can be concentrated further through centrifugation or filtration (Suali and Sarbatly, 2012).

Nevertheless, conventional flocculants that are always referred to as multivalent salts could contaminate the algal biomass and may affect the quality of the final product. Although no scientific work or assessment has been carried out to justify this claim, flocculant toxicity should not be ignored, especially if health-related products are to be extracted from algal biomass before the algal biomass is diverted to biofuel production. Other organic polymeric flocculants that are biodegradable and less toxic offer an alternative and environmentally friendly way to harvest algal biomass, but these organic polymeric flocculants require further development prior to application on the commercial scale.

After concentrating the algal slurry to 5–15% dry solid content through centrifugation or filtration, further dehydration or drying of the slurry is necessary to facilitate subsequent biofuel production (Brennan and Owende, 2010; Lam and Lee, 2012). The presence of water could severely inhibit the biofuel processing and conversion, including lipid extraction using

chemical solvents and biodiesel production through transesterification (Ehimen et al., 2010). The water would cause some difficulty in recovery of chemical solvents as well as biodiesel refining, requiring even higher energy input for subsequent water separation.

Several dehydration methods are currently applicable to drying the algal slurry, including solar drying, spray drying, freeze drying, and fluidized bed drying (Brennan and Owende, 2010; Desmorieux and Decaen, 2005; Orset et al., 1999; Prakash et al., 1997). Solar drying is apparently the most inexpensive dehydration method because it is free, but a large drying surface is required, and it is time-consuming (Prakash et al., 1997). Nevertheless, solar drying is not feasible in temperate countries where sunlight is not always available throughout the year (Lam and Lee, 2012). Thus, the use of heat generated from fossil fuels cannot be avoided to ensure that the algal slurry is continuously dried for each cultivation cycle. Some LCA studies have emphasized that a large amount of energy is consumed in drying the algal slurry, making commercial algal biofuel production even more challenging (Cooney et al., 2011; Lardon et al., 2009; Lohrey and Kochergin, 2012; Sander and Murthy, 2010; Xu et al., 2011). For example, Sander and Murthy (2010) revealed that using natural gas as the fuel to dry the algal slurry consumed nearly 69% of the overall energy input and consequently resulted in a negative energy balance for producing algal biofuels. Heavy dependence on fossil fuels to dry the algal slurry could reduce the market potential and feasibility for producing algal biofuels; thus, new development of an efficient drying method is required to ensure that the energy input in this step is minimized (Lohrey and Kochergin, 2012).

12.3 POTENTIAL BIOFUEL PRODUCTION FROM ALGAE

12.3.1 Biodiesel

12.3.1.1 *Lipid Extraction*

Currently the main interest in algal cultivation is to convert algal lipids to biodiesel (Chisti, 2007). Biodiesel is an alternative diesel fuel that offers several advantages to the environment; it is biodegradable and nontoxic as well as possession high lubricity, low SO_x, and low CO emissions (Jacobson et al., 2008; Lam et al., 2010).

After the algal biomass is dehydrated, the biomass then proceeds to the lipid-extraction process. Unlike terrestrial oil-bearing crops, extraction of lipids from algal biomass is relatively difficult because of the presence of the thick cell wall that prevents the release of interlipids. Hence, the use of a mechanical press that is effective in extracting oil from terrestrial oil-bearing crops is generally not applicable to algal biomass (Lam and Lee, 2012). Ideally, the algal lipid-extraction technology should display a high level of specificity and selectivity solely toward algal lipids (e.g., acylglycerol) to avoid the coextraction of other compounds such as protein, carbohydrates, ketones, and carotenes that cannot be directly converted to biodiesel (Halim et al., 2012).

Apparently, using chemical solvent to extract algal lipids seems to be the most suitable method since it is widely practiced in laboratory-scale research. This is because chemical solvent has high selectivity for the algal lipids and the algal lipids are soluble in the chemical solvent. This allows even interlipids to be extracted by diffusion across algal cell walls (Halim et al., 2012; Ranjan et al., 2010). Chemical solvents such as n-hexane, methanol, ethanol, and

mixed polar/nonpolar chemical solvents (e.g., methanol/chloroform and hexane/isopropanol) are effective for extraction of the algal lipids, but the extraction efficiency is highly dependent on algal strains (Halim et al., 2012; Lam and Lee, 2012).

However, before chemical solvent extraction can be implemented on a commercial scale, several issues must be addressed: (1) a large quantity of chemical solvent is required for effective lipid extraction, (2) solvent toxicity and safety must be considered, (3) additional energy input will be needed for solvent recovery, and (4) additional costs will be incurred for wastewater treatment. Other advanced technologies to improve algal lipid-extraction efficiency, such as autoclaving (Lee et al., 2010), supercritical CO₂ (Couto et al., 2010; Halim et al., 2011; Tang et al., 2011), and ultrasonication (Adam et al., 2012; Lee et al., 2010; Prabakaran and Ravindran, 2011), are still under investigation, and further optimization is urgently required before extending the technologies to the commercial scale.

12.3.1.2 Homogeneous Catalyst

After the extraction process, the algal lipids are ready to be converted into biodiesel through transesterification, whereby the lipids react with a short-chain alcohol (e.g., methanol) in the presence of a catalyst (Sharma and Singh, 2009). Since the reaction is reversible, an alcohol-to-oil molar ratio of more than 3 is usually used to push the reaction toward the product side at reflux temperature (60–70 °C) using a homogeneous base catalyst (e.g., KOH and NaOH) to accelerate the reaction. At the end of the reaction, two obvious layers will be observed due to gravity separation: The top layer is biodiesel (the main product), whereas the bottom layer is glycerol (byproduct). Subsequently, biodiesel is subjected to several purification steps, such as water washing and evaporation, to produce pure biodiesel of high quality. In a recent optimization study, more than 90% of algal biodiesel (*Chlorella vulgaris*) yield was attained at a reaction temperature of 43 °C, with a methanol-to-oil molar ratio of 14, 0.42 wt% of NaOH, and a reaction time of 90 minutes (Plata et al., 2010).

Nevertheless, it is important to note that the presence of a high free fatty acid (FFA) content in algal lipids (more than 0.5% w/w) may prevent the use of a homogeneous base catalyst for the transesterification reaction (Ehimen et al., 2010; Zhu et al., 2008). This is because FFA will react with the base catalyst to form soap, resulting in a low biodiesel yield and causing significant difficulty in product separation and purification. An alternative acid catalyst (e.g., sulfuric acid, H₂SO₄) will be a better choice because it is not sensitive to the FFA content in the oil and thus esterification (FFA is converted to alkyl esters) and transesterification can occur simultaneously. Nevertheless, the acid catalyst has a significant drawback from a commercialization aspect for the following reasons: (1) the reaction is extremely slow and a high concentration of catalyst is required to accelerate the reaction, (2) reuse and recycling of the catalyst are not possible, and (3) strong acidic properties of the catalyst will cause serious corrosion on valves, pipelines, and reactor walls (Lam et al., 2010).

12.3.1.3 Heterogeneous Catalyst

The use of a heterogeneous catalyst (base or acid) for biodiesel production has been recently and extensively explored. The main advantage of a heterogeneous catalyst over a homogeneous catalyst is that the former can be recycled and regenerated for repeated reaction cycles, resulting in minimum catalyst loss and improvement of the economic feasibility of biodiesel production. Furthermore, the catalyst can easily be separated at the end of the

reaction using filtration; therefore, product contamination is reduced and the number of water washing cycles (purification) is minimized (Lam and Lee, 2012).

Heterogeneous catalysts can generally be divided into two categories:

1. Catalysts with basic sites, such as CaO, MgO, ZnO, and waste materials impregnated with KOH or NaOH. This type of catalyst can catalyze transesterification under mild reaction conditions with a high yield of biodiesel usually attained. Nevertheless, due to the basic properties of the catalyst, it is highly sensitive to the FFA content in the oil and results in soap formation instead of biodiesel. Leaching of active sites from the catalyst is another limitation that can cause product contamination and catalyst deactivation.
2. Catalysts with acidic sites, such as $\text{SO}_4^{2-}/\text{ZrO}_2$, $\text{SO}_4^{2-}/\text{TiO}_2$, $\text{SO}_4^{2-}/\text{SnO}_2$, zeolites, sulfonic ion-exchange resins, and sulfonated carbon-based catalysts. These catalysts are insensitive to the FFA content in oil and are able to perform esterification and transesterification simultaneously. However, the reaction rate is exceptionally slow; hence, extreme reaction conditions such as high temperature (more than 100 °C) with high alcohol-to-oil molar ratio (more than 12:1) are necessary to accelerate the overall reaction rate.

To date, the application of heterogeneous catalysts to algal biodiesel conversion is still scarcely reported in literature, primarily because algal lipids are a relatively new feedstock that is not commercially available in the market. In a recent study carried out by Umdu et al. (2009), CaO supported with Al_2O_3 was used as a heterogeneous base catalyst in transesterification of *Nannochloropsis oculata* lipids (Umdu et al., 2009). The highest algal biodiesel yield attained was 97.5% under the following reaction conditions: reaction temperature of 50 °C, methanol-to-lipid molar ratio of 30:1, catalyst loading of 2 wt%, and reaction time of 4 h. The long reaction time was required mainly because of the initial three immiscible phases (lipid-alcohol-catalyst) that increase mass-transfer limitations in the system. When pure CaO was used as catalyst in the transesterification of algal lipids, insignificant biodiesel yield was recorded, but when CaO supported with Al_2O_3 (ratio 8:1 w/w) was used instead, significantly better results were achieved due to the increasing basic density and basic strength of the catalyst. Other heterogeneous catalysts such as Mg-Zr and hierarchical zeolites have also been investigated for transesterification of algal lipids; however, unsatisfactory biodiesel yield (less than 30%) was attained (Carrero et al., 2011; Krohn et al., 2011).

12.3.1.4 *In situ* Transesterification

In situ transesterification, better known as *reactive extraction*, has been developed with the purpose of simplifying the biodiesel production process by allowing extraction and transesterification to occur in a single step, in which oil-bearing seeds or algal biomass are in direct contact with the chemical solvent in the presence of a catalyst (acid or base). Through intensive research in recent years, the optimum conditions for *in situ* transesterification have become well established for different edible and nonedible oil feedstock, such as jatropha (Shuit et al., 2010), soybeans (Haas and Scott, 2007), and castor (Hincapié et al., 2011). However, the main constraint in commercializing this technology is the requirement of a high volume of chemical solvent, and the process is limited to homogeneous catalyst usage only.

In situ transesterification of algal biomass has been explored to attain high biodiesel conversion, including optimization of the alcohol-to-lipid molar ratio, reaction temperature, catalyst loading, and the effect of the use of a cosolvent, microwave, and ultrasonication. In a study performed by Ehimen et al. (2010), dried *Chlorella* biomass was subjected to *in situ* transesterification, attaining 90% of biodiesel yield at a reaction temperature of 60 °C, a methanol-to-lipid molar ratio of 315:1, a H₂SO₄ concentration of 0.04 mol, and a reaction time of 4 h.

To further reduce methanol consumption for the *in situ* transesterification, adding a cosolvent to the reaction mixture is suggested to increase the solubility of the algal lipids in methanol, creating a single phase reaction that could subsequently improve the reaction mass transfer rate. A yield of approximately 95% *Chlorella pyrenoidosa* biodiesel was attained when hexane was used as a cosolvent (hexane-to-lipid molar ratio of 76:1). The methanol-to-lipid molar ratio was significantly reduced to 165:1 and the total reaction time was shortened to 2 h at a reaction temperature of 90 °C and a catalyst loading of 0.5 M H₂SO₄. Nevertheless, the presence of water in the reaction media could impede the *in situ* transesterification and cause negligible biodiesel conversion (Ehimen et al., 2010). Thus, extensive drying of algal biomass is absolutely necessary to facilitate biodiesel conversion by avoiding the occurrence of any side reactions and to simplify the subsequent refining processes (Lam and Lee, 2012).

Other technologies that could further improve the reaction conditions for *in situ* transesterification of algal biomass are microwave irradiation (Patil et al., 2011a; Patil et al., 2012), ultrasonication (Koberg et al., 2011), and supercritical alcohol (Levine et al., 2010; Patil et al., 2011b). However, these technologies are still far from commercialization due to safety- and health-related problems.

12.3.2 Bioethanol

Apart from biodiesel, bioethanol is another attractive biofuel that is used as a substitute for gasoline. Biomass that contains sugar, starch, or cellulose is used by yeast as a substrate during the fermentation process, releasing bioethanol as the product and CO₂ as the byproduct (Brennan and Owende, 2010). Since algae are able to accumulate significant amounts of carbohydrates (mainly referred to as starch) inside their cells, the potential to utilize the carbohydrate for bioethanol production is high (Harun et al., 2010). Among the algal strains that have been identified as having high carbohydrate content are *Chlamydomonas reinhardtii* (53%), *C. reinhardtii* (45%), *Chlorella vulgaris* (12–37%), *Chlorella* sp. (21–27%), and *Scenedesmus* sp. (13–20%) (John et al., 2011).

Unlike terrestrial plants, algal cells are buoyant and thus do not require lignin and hemicelluloses for structural support (John et al., 2011). Therefore, carbohydrate extraction from algal biomass is expected to be simpler than carbohydrate extraction from lignocellulosic materials; avoiding the complicated pretreatment steps to remove lignin and the economic feasibility of bioethanol production can consequently be improved. Nevertheless, the extracted algal carbohydrates need to be hydrolyzed further (hydrolysis process) to simple reducing sugars (e.g., glucose) for yeast to effectively convert the sugar into bioethanol during the fermentation process.

Recently, several effective carbohydrate hydrolysis methods for algal biomass, such as using dilute acid solution (Harun and Danquah, 2011), dilute alkaline solution

TABLE 12.5 Effect of Various Hydrolysis Methods on Bioethanol Yield from Algal Biomass.

Feedstock	Pretreatment	Ethanol Yield (g Ethanol/g Substrate)	Reference
<i>Chlorococum</i> sp.	Supercritical CO ₂	0.38	(Harun et al., 2010a)
<i>Chlorococum humicola</i>	Acid	0.52	(Harun and Danquah, 2011b)
<i>Chlorococum infusionum</i>	Alkaline	0.26	(Harun et al., 2011b)
<i>Chlamydomonas reinhardtii</i>	Enzymatic	0.24	(Choi et al., 2010)

(Harun et al., 2011), and enzymatic methods (Choi et al., 2010; Harun and Danquah, 2011), have been reported in the literature, as shown in Table 12.5. The data in the table show that the bioethanol yields are comparable to the yields attained from sugar and lignocellulosic feedstocks, indicating that it is technically viable to produce bioethanol from algal biomass. Reutilization of the algal residue after lipid extraction for bioethanol conversion instead of using the freshly dried algal biomass is also possible (Lam and Lee, 2011). This would be a more realistic approach because two different types of biofuels are simultaneously produced from the algal biomass, and thus the life-cycle energy balance of algal biofuels can be further strengthened.

This concept has been proven viable in a recent study in which lipids from *Chlorococum* sp. were preextracted with supercritical CO₂ at 60 °C and subsequently subjected to fermentation with the yeast *Saccharomyces bayanus* (Harun et al., 2010). From the study, algal biomass with pre-extracted lipids gave 60% higher bioethanol concentration for all samples than the dried algal biomass without lipid extraction. This is because during supercritical CO₂ extraction of lipids, the algal cell wall is ruptured due to the high temperature and pressure required for the supercritical process (Harun et al., 2010). The rupturing of the cell wall leads to the release of carbohydrates and subsequently being hydrolyzed to simple reducing sugar. Thus the algal residues after lipid extraction are readily available for fermentation with yeast. Based on this study, a maximum bioethanol yield of 3.83 g/L was achieved from 10 g/L of lipid-extracted algal residue.

12.3.3 Bio-Oil

Bio-oil is another important biofuel that can be obtained from thermochemical conversion of biomass, such as pyrolysis and hydrothermal liquefaction (Brennan and Owende, 2010). Bio-oil has been considered a promising feedstock to replace petroleum fuel for power generation due to its high energy density and convenience in storage or transport compared to gaseous products (Pan et al., 2010; Xiu and Shahbazi, 2012). In addition, bio-oil is biodegradable, is CO₂ or greenhouse gas neutral, and, compared to petroleum-based fuel, generates significantly less NO_x and SO_x when combusted in an engine. Bio-oil is therefore a “green fuel” with benefits to the environment (Jena and Das, 2011; Miao and Wu, 2004). Bio-oil production to date is mainly based on lignocellulosic biomass as raw material. However, the bio-oil obtained could not be directly used as transportation fuel due to its high viscosity, high oxygen content, high corrosiveness, and thermal instability (Pan et al., 2010; Xu et al., 2010). The poor quality of bio-oil is

due to the presence of a complicated composition of cellulose, hemicelluloses, and lignin, which in turn produces a highly oxygenated and acidic bio-oil that must be upgraded prior to use (Grierson et al., 2011; Mohan et al., 2006; Pan et al., 2010). Thus, the research for more appropriate biomass is urgently needed to exploit the actual potential of bio-oil as a green and renewable fuel.

Algal biomass appears to be a prospective source for bio-oil production since algal cells contain no lignin and have lack of cellulose. In a study reported by Miao and Wu (2004), the highest bio-oil yield attained from fast pyrolysis of heterotrophically cultivated *Chlorella protothecoides* was 57.9% at a pyrolysis temperature of 450 °C. The pyrolysis temperature required was much lower than that for pyrolysis of wood or lignocellulosic biomass (~650 °C) (Mohan et al., 2006; Pan et al., 2010), indicating that algal bio-oil production could substantially reduce the energy input in the pyrolysis process. The algal bio-oil obtained was characterized to have lower oxygen content, higher heating value (41 MJ/kg), lower density (0.92 kg/L), and lower viscosity (0.02 Pa s) compared to bio-oil derived from wood (Miao and Wu, 2004). In another study performed by Pan et al. (2010), *Nannochloropsis* sp. residue after lipid extraction was further reutilized to produce bio-oil via catalytic pyrolysis. By using HZSM-5 as a catalyst and at a pyrolysis temperature of 400 °C, approximately 19.7% of bio-oil with better quality (lower oxygen content and higher aromatic hydrocarbon concentration) was successfully recovered from the process, compared to direct pyrolysis without a catalyst. The study also suggested that instead of using the algal residue for bioethanol production that involves multiple steps (i.e., hydrolysis, neutralization, and fermentation), the pyrolysis process offers a more direct way to produce bio-oil with higher energy density compared to bioethanol.

Since algae are aquatic microorganisms, extensive drying of algal biomass is required to produce algal bio-oil through the pyrolysis process. As mentioned in Section 12.2.2, the need to dry the wet algal slurry is one of the detrimental factors that impede the commercialization of algal biofuels, primarily due to the high consumption of energy in the drying process. In this regard, hydrothermal liquefaction could be an attractive alternative to produce bio-oil from algae, because hydrothermal liquefaction circumvents the need for water removal, and directly process the algal biomass without thermal drying (Garcia Alba et al., 2012). The aim of hydrothermal liquefaction is to obtain low-molecular-weight liquid fuels from high-molecular-weight compounds by converting the biomass in water at high temperature and pressure (Shuping et al., 2010). Algal biomass is an excellent feedstock for application of this technology because the small size of the algal cells will enhance rapid thermal transfer for achieving the required processing temperature (Heilmann et al., 2010).

In a study performed by Brown et al. (2010), hydrothermal liquefaction of *Nannochloropsis* sp. slurry with a water content of 79 wt% was carried out at 350 °C for 60 minutes. A maximum of 43 wt% of bio-oil was successfully recovered, as reported in the study, and the bio-oil obtained had a high heating value of 39 MJ/kg, which is comparable to petroleum crude oil (43 MJ/kg) (Brown et al., 2010; Pan et al., 2010). However, the recovered bio-oil has a relatively higher composition of nitrogen and oxygen, and thus deoxygenation and denitrogenation are necessary to upgrade the bio-oil (Brown et al., 2010; Jena et al., 2012). Producing and upgrading the bio-oil simultaneously via hydrothermal liquefaction in a single step becomes possible by adding a heterogeneous catalyst to the process. Heterogeneous catalysts such as Co/Mo/Al₂O₃, Pt/Al₂O₃, Ni/Al₂O₃, and NiO are able to increase the

deoxygenation reaction and subsequently reduce the oxygen content and viscosity of the algal bio-oil that is produced (Biller et al., 2011; Jena et al., 2012).

12.4 TECHNO-ECONOMIC EVALUATION OF ALGAL BIOFUELS

Apart from the perspective of energy balance, economic feasibility, coupled with technological innovations, plays a critical role in ensuring the successful production of algal biofuels on a commercial scale. Based on an ideal assumption that algae could grow at a very rapid rate (typically requiring less than 10 days to reach the stationary growth phase) and could accumulate a high lipid content (30–70%) inside the cells, the resulting algal biodiesel should be able to compete or at least be on par with the current petrol-diesel price.

A preliminary cost analysis conducted by Chisti (2007) revealed that oil recovered from algal biomass produced in closed photobioreactors cost approximately \$2.80/L, assuming that the algal biomass contained 30% oil and the oil-recovery process contributed 50% to the total production cost. However, in comparison to the average petrol-diesel price of \$1.20/L gross delivered in the year 2010 (McHenry, 2012), the estimated algal biodiesel price is still much too high for commercial use, unless the algal biomass contains 70% oil, which could further reduce the price to \$0.72/L (Chisti, 2007).

In a recent algal technological road map reported by the U.S. Department of Energy, a more robust system of modeling and comprehensive techno-economic analyses for algal biofuels should be developed to reach the goal of commercialization in the next 5 to 15 years (Fishman et al., 2010). An economic breakdown of multiple algal processing units with different integration systems could help address the techno-economic feasibility of algal biofuels before reaching the commercial scale (Amer et al., 2011). An in-depth understanding of the techno-economic feasibility of algal biofuels is required to not only maximize profits and minimize investment risk but also to stimulate the consideration of the “bigger picture” in identifying the critical problems for scaling up this process and recommending specific corrective measures (Davis et al., 2011; Delrue et al., 2012; Harun et al., 2011; Sun et al., 2011). The following sections describe some significant results from recent techno-economic studies of algal biofuels.

12.4.1 The Economic Road Map of Algal Biofuels

Figure 12.2 shows the projected techno-economic performance of algal biofuels at the current phase as well as the projected outcome for the future. From the figure, it can be observed that current algal biofuel production is still in its infancy stage for commercialization, predominantly due to the high investment cost and premature technology. However, with emerging technologies and innovation through progressive R&D efforts, the way will be paved to develop truly sustainable algal biofuels with affordable production costs in the near future. All the technical problems surrounding the supply chain of algal biofuels, such as nutrient source, cultivation system, harvesting and drying processes, and biofuel-conversion technology, must be resolved to attain its commercialization threshold and economic viability. Thus, current techno-economic assessments of algal biofuels should be highly

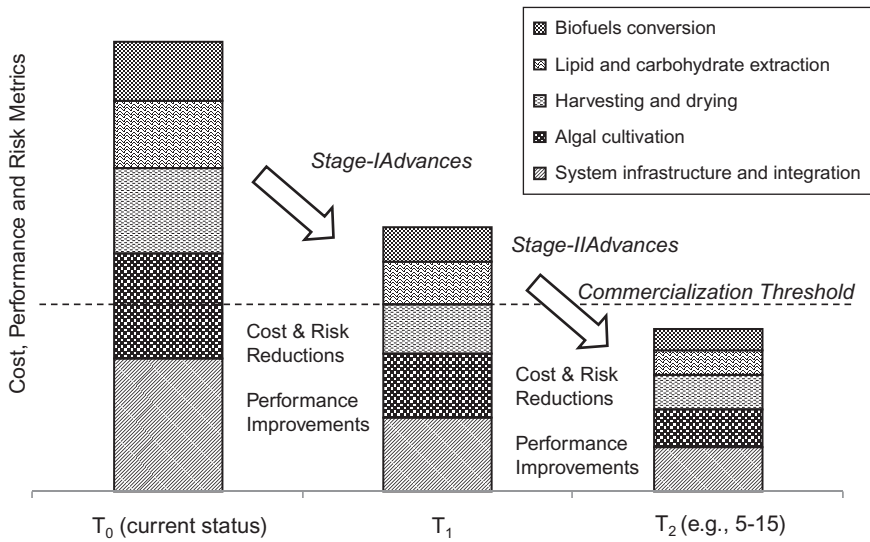

FIGURE 12.2 Road map of techno-economic algal biofuels. (Modified from Fishman et al., 2010.)

interdisciplinary, with a flexible modeling and analysis framework that can completely address the multiple pathways, coupled with various integration systems for algal biofuel production.

The production cost of algal biofuels is defined as the sum of capital and operating costs minus the revenues derived from all coproduct, as shown in Eq. 12.1 (Sun et al., 2011). Capital cost is usually related to one-time expenses such as the cost of land, buildings (e.g., indoor cultivation systems, offices, and laboratories), equipment (photobioreactors, dryer, filter press), and infrastructure (piping and pumps), whereas operating cost is associated with day-to-day expenses such as power (e.g., to operate photobioreactors), raw materials (nutrients and water), labor costs, and maintenance fees (Sun et al., 2011).

The coproduct that could possibly be derived from algal biomass residue after lipid extraction is carbohydrate, which can be an excellent substrate for anaerobic digestion or fermentation process to produce biomethane or bioethanol, respectively. The biomethane and/or bioethanol produced can be diverted to use at an algal cultivation farm to reduce the associated energy burden, or it can be sold as energy fuel. However, additional capital and operating cost will be required to build the facilities to convert carbohydrates to biomethane/bioethanol. In the worst-case scenario, the coproduct processing facilities may consume substantial amounts of cost and energy due to the low conversion efficiency of biomethane or bioethanol, making it commercially impractical to integrate the coproducts into the supply chain of algal biodiesel. On the other hand, coproducts that have high market value, such as phytonutrients and proteins, could be the alternative options instead of carbohydrates.

$$C_{\text{production}} = \sum_i C_{\text{capital},i} + \sum_j C_{\text{operating},j} - \sum_k C_{\text{co-product},k} \quad (12.1)$$

12.4.2 Current Scenario

Due to the overwhelming response and interest in cultivating algae as a sustainable source of energy, several comprehensive techno-economic assessments have revealed the actual potential of this renewable source on a commercial scale (Amer et al., 2011; Davis et al., 2011; Delrue et al., 2012; Sun et al., 2011). Referring to Figure 12.3, the average biodiesel selling prices for algae cultivated in an open pond and a closed photobioreactor are \$2.97/L and \$4.93/L, respectively, or 66% higher for algae cultivated in a closed photobioreactor compared to an open pond. Clearly, although the closed photobioreactor has the advantage of permitting a single strain culture and has high biomass productivity, this cultivation system is still considered expensive from the techno-economic point of view. On the other hand, algal biodiesel produced using the open pond system faces high economic competition from first- and second-generation biodiesel. The estimated biodiesel selling prices for biodiesel produced from soybean oil, jatropha oil, and waste frying oil were \$1.35/L (Hu et al., 2008), \$1.4/L (Wang et al., 2011), and \$0.73/L (Araujo et al., 2010), respectively, which are much lower compared to algal biodiesel but very close to the selling price of petro-diesel at \$1.2/L (McHenry, 2012). Although the biomass and lipids productivity of algae are superior to terrestrial oil-bearing crops, nevertheless the cultivation and downstream processing stages are much more complicated and consumed significant amounts of energy input. This result also indicates that the positive opportunity for using algal biomass to generate alternative fuel has been overclaimed, and thus advanced improvements are needed to address the feasibility of utilizing this renewable feedstock for commercial use.

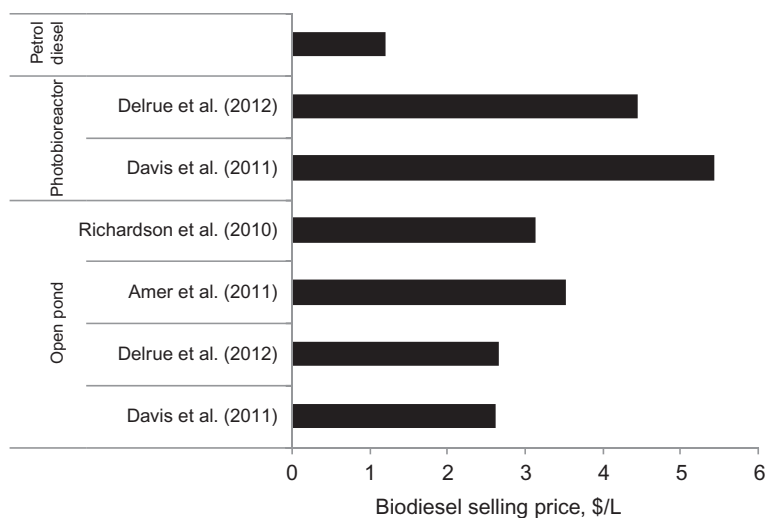

FIGURE 12.3 Estimated algal biodiesel selling price based on various cultivation systems. (Amer et al., 2011; Davis et al., 2011; Delrue et al., 2012; Richardson et al., 2010.)

12.4.3 Insight into the Economic Breakdown of Algal Biofuels

Algal biofuel technology is currently still in an early stage of development and therefore economically unfavorable for scaling-up purposes. Thus, analyzing the detailed economic breakdown of the multistage processing of algal biofuels will certainly open up a new direction in identifying, evaluating, and verifying the actual problems that result in the high production cost of algal biofuels. A detailed discussion of the economic breakdown follows:

- *Capital cost.* The capital cost is the main cost driver in the entire system boundary of algal biofuels. A study performed by Davis et al. (2011) revealed that the capital cost of algae cultivated in an open pond and in a closed photobioreactor contributed approximately 91.0% and 94.7% of the total production costs, respectively. The total capital cost for algae cultivated in a closed photobioreactor was 153.8% higher than an open pond system, indicating the high investment risk in scaling up a closed photobioreactor for algal biomass production. Furthermore, the closed photobioreactor manufacturing cost contributes a large portion to the total capital cost at 52.7%, or 12.7 times higher than the open pond manufacturing cost. A similar result was also reported by Ación et al. (2012); in an actual algal biomass production plant, the capital cost contributed 87.2% of the total production cost, whereas 34% of the total capital cost was utilized to purchase equipment such as closed photobioreactors, a freeze dryer, and a decanter (Ación et al., 2012). The closed photobioreactor manufacturing cost was lower compared to the study by Davis et al. (2011), which accounted only 16.1% of the total capital cost, but if other associated expenses such as installation costs, instrumentation and control, piping, engineering, and supervision were included, the cost to set up the closed photobioreactor cultivation system would reach up to 45% of the total capital cost. Based on the data presented, reduction of the associated equipment cost for algal cultivation systems by simplifying the overall designs and materials used, but allowing high productivity of algal biomass, is deemed necessary.
- *Operating cost.* The total operating cost for algal biomass production cultivated in a closed photobioreactor was dominated by labor cost (88.3%), followed by power consumption and water cost (9.2%), and finally nutrient and CO₂ cost (2.5%) (Ación et al., 2012). In this regard, it is obvious that reducing the amount of labor (e.g., one worker/hectare or less) could significantly help reduce the overall operating cost. Reducing the amount of labor can be accomplished by introducing extensive automation into the entire algal biomass production plant, from cultivation farm to final biofuel production process (Ación et al., 2012). On the contrary, the raceway pond required 32.7% lower operating costs than the closed photobioreactor (Davis et al., 2011), primarily due to the ease of operating the open pond system and, hence, less power consumption. The high power consumption in the closed photobioreactor cultivation system (usually referred as an *airlift tubular photobioreactor*) is caused primarily by the use of heavy-duty pumps to circulate and to provide sufficient mixing of the algae (Lam and Lee, 2012). Hence, extensive research efforts to design an innovative closed photobioreactor with less power consumption that has the potential to be easily scaled up are necessary to move the algal biofuels industry to the next level. Water consumption cost is another important issue that should not be ignored. Although the total water cost is lower compared to the power consumption cost, incessant waste of water could cause an enormous water footprint in algal biofuel

production and lead to irreversible consequences for regional water resources (Subhadra, 2011). Several precautionary steps should be taken because the evaporation rate for the open pond system is exceptionally high (~ 0.3 cm/day), resulting in a massive waste of water in this cultivation system. The water consumed in the open pond system was approximately 3.3–6.7 times higher than in the photobioreactor (Davis et al., 2011; Delrue et al., 2012), where continuously pumping fresh water into the system could inevitably increase the overall operating cost, especially for long-term operation.

- *Coproducts.* Valuable coproducts such as carbohydrates and proteins remain in the algal biomass after lipid extraction. These products could be further utilized to increase the revenue of algal biomass. Unfortunately, in some recent techno-economic studies, the coproducts did not bring a significant return to reduce the production cost of algal biofuels (Davis et al., 2011; Sun et al., 2011). For example, when biogas production facilities (e.g., using residue of algal biomass for biomethane production) was incorporated into the algal biodiesel production plant, the total coproduct sales revenue could reduce the operating cost by only 12.7–18.2% (Davis et al., 2011). However, the contributions from coproducts, especially those that have higher economic value, such as bio-butanol, should not be totally ignored, because the process for producing them could be further improved in the near future as technology develops (Davis et al., 2011).

12.5 CONCLUSION

Cultivating algae as a sustainable source of biomass for biofuel production illustrates a new trend in the renewable energy industries. The advantages and promises of algal biofuels are alleged to bring a revolutionary breakthrough in balancing the global fuel demand with better environmental protection. However, producing algal biofuels requires a large cultivation system and substantial energy requirements, which subsequently induce a negative impact in commercializing these renewable fuels. Several technical challenges, such as cultivation method, harvesting and drying processes, and biofuels conversion technologies using algal biomass, are still in the infancy phase, and extensive ventures in research and development are urgently needed to address the commercial feasibility of this renewable energy source. From the techno-economic point of view, algal biofuels are currently considerably more expensive than fossil fuels; thus political support is desirable to strengthen the economic viability of algal biofuels and to be able to compete in the global fuel market. Sustained support from technology developers, politicians, and policymakers, as well as acceptance from the public, are the driving forces to materialize this commercially viable biofuel source as a solution to future energy concerns.

Acknowledgment

The authors would like to acknowledge the funding given by the Universiti Sains Malaysia (Research University Grant No.814146, Postgraduate Research Grant Scheme No. 8044031, and USM Vice-Chancellor's Award) for the preparation of this chapter.

References

- Achten, W.M.J., Almeida, J., Fobelets, V., Bolle, E., Mathijs, E., Singh, V.P., et al., 2010. Life cycle assessment of Jatropha biodiesel as transportation fuel in rural India. *Appl. Energy* 87, 3652–3660.
- Acién, F.G., Fernández, J.M., Magán, J.J., Molina, E., 2012. Production cost of a real microalgae production plant and strategies to reduce it. *Biotechnol. Adv.* 30, 1344–1353.
- Adam, F., Abert-Vian, M., Peltier, G., Chemat, F., 2012. “Solvent-free” ultrasound-assisted extraction of lipids from fresh microalgae cells: A green, clean and scalable process. *Bioresour. Technol.* 114, 457–465.
- Amer, L., Adhikari, B., Pellegrino, J., 2011. Techno-economic analysis of five microalgae-to-biofuels processes of varying complexity. *Bioresour. Technol.* 102, 9350–9359.
- Araujo, V.K.W.S., Hamacher, S., Scavarda, L.F., 2010. Economic assessment of biodiesel production from waste frying oils. *Bioresour. Technol.* 101, 4415–4422.
- Batan, L., Quinn, J., Willson, B., Bradley, T., 2010. Net energy and greenhouse gas emission evaluation of biodiesel derived from microalgae. *Environ. Sci. Technol.* 44, 7975–7980.
- Billler, P., Riley, R., Ross, A.B., 2011. Catalytic hydrothermal processing of microalgae: Decomposition and upgrading of lipids. *Bioresour. Technol.* 102, 4841–4848.
- Borowitzka, M.A., 1999. Commercial production of microalgae: ponds, tanks, tubes and fermenters. *J. Biotechnol.* 70, 313–321.
- Brennan, L., Owende, P., 2010. Biofuels from microalgae—A review of technologies for production, processing, and extractions of biofuels and co-products. *Renew. Sustain. Energy Rev.* 14, 557–577.
- Brown, T.M., Duan, P., Savage, P.E., 2010. Hydrothermal liquefaction and gasification of *Nannochloropsis* sp. *Energy Fuels* 24, 3639–3646.
- Bull, J.J., Collins, S., 2012. Algae for biofuel: Will the evolution of weeds limit the enterprise? *Evolution* 66, 2983–2987.
- Campbell, P.K., Beer, T., Batten, D., 2011. Life cycle assessment of biodiesel production from microalgae in ponds. *Bioresour. Technol.* 102, 50–56.
- Carrero, A., Vicente, G., Rodríguez, R., Linares, M., Del Peso, G.L., 2011. Hierarchical zeolites as catalysts for biodiesel production from *Nannochloropsis* microalga oil. *Catal Today* 167, 148–153.
- Chen, C.Y., Yeh, K.L., Aisyah, R., Lee, D.J., Chang, J.S., 2011. Cultivation, photobioreactor design and harvesting of microalgae for biodiesel production: A critical review. *Bioresour. Technol.* 102, 71–81.
- Chisti, Y., 2007. Biodiesel from microalgae. *Biotechnol. Adv.* 25, 294–306.
- Choi, S.P., Nguyen, M.T., Sim, S.J., 2010. Enzymatic pretreatment of *Chlamydomonas reinhardtii* biomass for ethanol production. *Bioresour. Technol.* 101, 5330–5336.
- Clarens, A.F., Resurreccion, E.P., White, M.A., Colosi, L.M., 2010. Environmental life cycle comparison of algae to other bioenergy feedstocks. *Environ. Sci. Technol.* 44, 1813–1819.
- Cooney, M.J., Young, G., Pate, R., 2011. Bio-oil from photosynthetic microalgae: Case study. *Bioresour. Technol.* 102, 166–177.
- Couto, R.M., Simões, P.C., Reis, A., Da Silva, T.L., Martins, V.H., Sánchez-Vicente, Y., 2010. Supercritical fluid extraction of lipids from the heterotrophic microalga *Cryptocodium cohnii*. *Eng. Life Sci.* 10, 158–164.
- Davis, R., Aden, A., Pienkos, P.T., 2011. Techno-economic analysis of autotrophic microalgae for fuel production. *Appl. Energy* 88, 3524–3531.
- de Godos, I., Guzman, H.O., Soto, R., García-Encina, P.A., Becares, E., Muñoz, R., et al., 2011. Coagulation/flocculation-based removal of algal-bacterial biomass from piggery wastewater treatment. *Bioresour. Technol.* 102, 923–927.
- Delrue, F., Setier, P.A., Sahut, C., Cournac, L., Roubaud, A., Peltier, G., et al., 2012. An economic, sustainability, and energetic model of biodiesel production from microalgae. *Bioresour. Technol.* 111, 191–200.
- Desmorieux, H., Decaen, N., 2005. Convective drying of spirulina in thin layer. *J. Food Eng.* 66, 497–503.
- Ehimen, E.A., Sun, Z.F., Carrington, C.G., 2010. Variables affecting the in situ transesterification of microalgae lipids. *Fuel* 89, 677–684.
- Fishman, D., Majumdar, R., Morello, J., Pate, R., Yang, J., 2010. National Algal Biofuels Technology Roadmap. U.S. Department of Energy, Office of Energy Efficiency and Renewable Energy, Biomass Program.
- García Alba, L., Torri, C., Samorì, C., Van Der Spek, J., Fabbri, D., Kersten, S.R.A., et al., 2012. Hydrothermal treatment (HTT) of microalgae: Evaluation of the process as conversion method in an algae biorefinery concept. *Energy Fuels* 26, 642–657.

- Greenwell, H.C., Laurens, L.M.L., Shields, R.J., Lovitt, R.W., Flynn, K.J., 2010. Placing microalgae on the biofuels priority list: A review of the technological challenges. *J. R. Soc. Interface* 7, 703–726.
- Grierson, S., Strezov, V., Shah, P., 2011. Properties of oil and char derived from slow pyrolysis of *Tetraselmis chui*. *Bioresour. Technol.* 102, 8232–8240.
- Haas, M.J., Scott, K.M., 2007. Moisture removal substantially improves the efficiency of in situ biodiesel production from soybeans. *J. Am. Oil Chem. Soc.* 84, 197–204.
- Halim, R., Danquah, M.K., Webley, P.A., 2012. Extraction of oil from microalgae for biodiesel production: A review. *Biotechnol. Adv.* 30, 709–732.
- Halim, R., Gladman, B., Danquah, M.K., Webley, P.A., 2011. Oil extraction from microalgae for biodiesel production. *Bioresour. Technol.* 102, 178–185.
- Harun, R., Danquah, M.K., 2011. Enzymatic hydrolysis of microalgal biomass for bioethanol production. *Chem. Eng. J.* 168, 1079–1084.
- Harun, R., Danquah, M.K., 2011. Influence of acid pretreatment on microalgal biomass for bioethanol production. *Process Biochem.* 46, 304–309.
- Harun, R., Danquah, M.K., Forde, G.M., 2010. Microalgal biomass as a fermentation feedstock for bioethanol production. *J. Chem. Technol. Biotechnol.* 85, 199–203.
- Harun, R., Davidson, M., Doyle, M., Gopiraj, R., Danquah, M., Forde, G., 2011. Techno-economic analysis of an integrated microalgae photobioreactor, biodiesel and biogas production facility. *Biomass Bioenergy* 35, 741–747.
- Harun, R., Jason, W.S.Y., Cherrington, T., Danquah, M.K., 2011. Exploring alkaline pretreatment of microalgal biomass for bioethanol production. *Appl. Energy* 88, 3464–3467.
- Harun, R., Singh, M., Forde, G.M., Danquah, M.K., 2010b. Bioprocess engineering of microalgae to produce a variety of consumer products. *Renew. Sustain. Energy Rev.* 14, 1037–1047.
- Heilmann, S.M., Davis, H.T., Jader, L.R., Lefebvre, P.A., Sadowsky, M.J., Schendel, F.J., et al., 2010. Hydrothermal carbonization of microalgae. *Biomass Bioenergy* 34, 875–882.
- Hincapié, G., Mondragón, F., López, D., 2011. Conventional and in situ transesterification of castor seed oil for biodiesel production. *Fuel* 90, 1618–1623.
- Hu, Z., Tan, P., Yan, X., Lou, D., 2008. Life cycle energy, environment and economic assessment of soybean-based biodiesel as an alternative automotive fuel in China. *Energy* 33, 1654–1658.
- Iriarte, A., Rieradevall, J., Gabarrell, X., 2010. Life cycle assessment of sunflower and rapeseed as energy crops under Chilean conditions. *J. Cleaner Prod.* 18, 336–345.
- Jacobson, K., Gopinath, R., Meher, L.C., Dalai, A.K., 2008. Solid acid catalyzed biodiesel production from waste cooking oil. *Appl. Catal. B* 85, 86–91.
- Jena, U., Das, K.C., 2011. Comparative evaluation of thermochemical liquefaction and pyrolysis for bio-oil production from microalgae. *Energy Fuels* 25, 5472–5482.
- Jena, U., Das, K.C., Kastner, J.R., 2012. Comparison of the effects of Na_2CO_3 , $\text{Ca}_3(\text{PO}_4)_2$, and NiO catalysts on the thermochemical liquefaction of microalga *Spirulina platensis*. *Appl. Energy* 98, 368–375.
- John, R.P., Anisha, G.S., Nampoothiri, K.M., Pandey, A., 2011. Micro and macroalgal biomass: A renewable source for bioethanol. *Bioresour. Technol.* 102, 186–193.
- Jorquera, O., Kiperstok, A., Sales, E.A., Embiruçu, M., Ghirardi, M.L., 2010. Comparative energy life-cycle analyses of microalgal biomass production in open ponds and photobioreactors. *Bioresour. Technol.* 101, 1406–1413.
- Koberg, M., Cohen, M., Ben-Amotz, A., Gedanken, A., 2011. Bio-diesel production directly from the microalgae biomass of *Nannochloropsis* by microwave and ultrasound radiation. *Bioresour. Technol.* 102, 4265–4269.
- Krohn, B.J., McNeff, C.V., Yan, B., Nowlan, D., 2011. Production of algae-based biodiesel using the continuous catalytic Mcgyan[®] process. *Bioresour. Technol.* 102, 94–100.
- Kulkarni, M.G., Dalai, A.K., 2006. Waste cooking oil: An economical source for biodiesel: A review. *Ind. Eng. Chem. Res.* 45, 2901–2913.
- Lam, M.K., Lee, K.T., 2011. Renewable and sustainable bioenergies production from palm oil mill effluent (POME): Win-win strategies toward better environmental protection. *Biotechnol. Adv.* 29, 124–141.
- Lam, M.K., Lee, K.T., 2012. Microalgae biofuels: A critical review of issues, problems and the way forward. *Biotechnol. Adv.* 30, 673–690.
- Lam, M.K., Lee, K.T., Mohamed, A.R., 2010. Homogeneous, heterogeneous and enzymatic catalysis for transesterification of high free fatty acid oil (waste cooking oil) to biodiesel: A review. *Biotechnol. Adv.* 28, 500–518.

- Lam, M.K., Lee, K.T., Rahmanmohamed, A., 2009. Life cycle assessment for the production of biodiesel: A case study in Malaysia for palm oil versus jatropha oil. *Biofuels, Bioprod. Biorefin.* 3, 601–612.
- Lardon, L., Hélias, A., Sialve, B., Steyer, J.P., Bernard, O., 2009. Life-cycle assessment of biodiesel production from microalgae. *Environ. Sci. Technol.* 43, 6475–6481.
- Lee, J.Y., Yoo, C., Jun, S.Y., Ahn, C.Y., Oh, H.M., 2010. Comparison of several methods for effective lipid extraction from microalgae. *Bioresour. Technol.* 101, S75–S77.
- Levine, R.B., Pinnarat, T., Savage, P.E., 2010. Biodiesel production from wet algal biomass through in situ lipid hydrolysis and supercritical transesterification. *Energy Fuels* 24, 5235–5243.
- Lohrey, C., Kochergin, V., 2012. Biodiesel production from microalgae: Co-location with sugar mills. *Bioresour. Technol.* 108, 76–82.
- Mata, T.M., Martins, A.A., Caetano, N.S., 2010. Microalgae for biodiesel production and other applications: A review. *Renew. Sustain. Energy Rev.* 14, 217–232.
- McHenry, M.P., 2012. Technical, mitigation, and financial comparisons of 6 kWe grid-connected and stand-alone wood gasifiers, versus mineral diesel and biodiesel generation for rural distributed generation. *Energy* 40, 428–437.
- Miao, X., Wu, Q., 2004. High yield bio-oil production from fast pyrolysis by metabolic controlling of *Chlorella protothecoides*. *J. Biotechnol.* 110, 85–93.
- Mohan, D., Pittman, C.U., Steele, P.H., 2006. Pyrolysis of wood/biomass for bio-oil: A critical review. *Energy Fuels* 20, 848–889.
- Molina Grima, E., Belarbi, E.H., Ación Fernández, F.G., Robles Medina, A., Chisti, Y., 2003. Recovery of microalgal biomass and metabolites: Process options and economics. *Biotechnol. Adv.* 20, 491–515.
- Mutanda, T., Ramesh, D., Karthikeyan, S., Kumari, S., Anandraj, A., Bux, F., 2011. Bioprospecting for hyper-lipid producing microalgal strains for sustainable biofuel production. *Bioresour. Technol.* 102, 57–70.
- Orset, S., Leach, G.C., Morais, R., Young, A.J., 1999. Spray-drying of the micro alga *Dunaliella salina*: Effects on β -carotene content and isomer composition. *J. Agric. Food Chem.* 47, 4782–4790.
- Pan, P., Hu, C., Yang, W., Li, Y., Dong, L., Zhu, L., et al., 2010. The direct pyrolysis and catalytic pyrolysis of *Nannochloropsis* sp. residue for renewable bio-oils. *Bioresour. Technol.* 101, 4593–4599.
- Patil, P.D., Gude, V.G., Mannarswamy, A., Cooke, P., Munson-McGee, S., Nirmalakhandan, N., et al., 2011a. Optimization of microwave-assisted transesterification of dry algal biomass using response surface methodology. *Bioresour. Technol.* 102, 1399–1405.
- Patil, P.D., Gude, V.G., Mannarswamy, A., Cooke, P., Nirmalakhandan, N., Lammers, P., et al., 2012. Comparison of direct transesterification of algal biomass under supercritical methanol and microwave irradiation conditions. *Fuel* 97, 822–831.
- Patil, P.D., Gude, V.G., Mannarswamy, A., Deng, S., Cooke, P., Munson-McGee, S., et al., 2011b. Optimization of direct conversion of wet algae to biodiesel under supercritical methanol conditions. *Bioresour. Technol.* 102, 118–122.
- Pimentel, D., Pimentel, M., 2006. Global environmental resources versus world population growth. *Ecol Econ* 59, 195–198.
- Pittman, J.K., Dean, A.P., Osundeko, O., 2011. The potential of sustainable algal biofuel production using wastewater resources. *Bioresour. Technol.* 102, 17–25.
- Plata, V., Kafarov, V., Moreno, N., 2010. Optimization of third generation biofuels production: Biodiesel from microalgae oil by homogeneous transesterification. *Chem. Eng. Trans.* 21, 1201–1206.
- Pleanjai, S., Gheewala, S.H., 2009. Full chain energy analysis of biodiesel production from palm oil in Thailand. *Appl. Energy* 86, S209–S214.
- Prabakaran, P., Ravindran, A.D., 2011. A comparative study on effective cell disruption methods for lipid extraction from microalgae. *Lett. Appl. Microbiol.* 53, 150–154.
- Prakash, J., Pushparaj, B., Carozzi, P., Torzillo, G., Montaini, E., Materassi, R., 1997. Microalgal biomass drying by a simple solar device. *Int. J. Sol. Energy* 18, 303–311.
- Pulz, O., 2001. Photobioreactors: Production systems for phototrophic microorganisms. *Appl. Microbiol. Biotechnol.* 57, 287–293.
- Ranjan, A., Patil, C., Moholkar, V.S., 2010. Mechanistic assessment of microalgal lipid extraction. *Ind. Eng. Chem. Res.* 49, 2979–2985.
- Razon, L.F., Tan, R.R., 2011. Net energy analysis of the production of biodiesel and biogas from the microalgae: *Haematococcus pluvialis* and *Nannochloropsis*. *Appl. Energy* 88, 3507–3514.

- Richardson, J.W., Outlaw, J.L., Allison, M., 2010. The economics of microalgae oil. *AgBioForum* 13, 119–130.
- Sander, K., Murthy, G.S., 2010. Life cycle analysis of algae biodiesel. *Int. J. Life Cycle Assess* 15, 704–714.
- Schenk, P., Thomas-Hall, S., Stephens, E., Marx, U., Mussgnug, J., Posten, C., et al., 2008. Second Generation Biofuels: High-Efficiency Microalgae for Biodiesel Production. *BioEnergy Res.* 1, 20–43.
- Sharma, Y.C., Singh, B., 2009. Development of biodiesel: Current scenario. *Renew. Sustain. Energy Rev.* 13, 1646–1651.
- Shuit, S.H., Lee, K.T., Kamaruddin, A.H., Yusup, S., 2010. Reactive extraction of *Jatropha curcas* L. Seed for production of Biodiesel: Process optimization study. *Environ. Sci. Technol.* 44, 4361–4367.
- Shuping, Z., Yulong, W., Mingde, Y., Kaleem, I., Chun, L., Tong, J., 2010. Production and characterization of bio-oil from hydrothermal liquefaction of microalgae *Dunaliella tertiolecta* cake. *Energy* 35, 5406–5411.
- Sierra, E., Acién, F.G., Fernández, J.M., García, J.L., González, C., Molina, E., 2008. Characterization of a flat plate photobioreactor for the production of microalgae. *Chem. Eng. J.* 138, 136–147.
- Singh, A., Nigam, P.S., Murphy, J.D., 2011. Mechanism and challenges in commercialisation of algal biofuels. *Bioresour. Technol.* 102, 26–34.
- Singh, J., Gu, S., 2010. Commercialization potential of microalgae for biofuels production. *Renew. Sustain. Energy Rev.* 14, 2596–2610.
- Stephenson, A.L., Kazamia, E., Dennis, J.S., Howe, C.J., Scott, S.A., Smith, A.G., 2010. Life-cycle assessment of potential algal biodiesel production in the united kingdom: A comparison of raceways and air-lift tubular bioreactors. *Energy Fuels* 24, 4062–4077.
- Suali, E., Sarbatly, R., 2012. Conversion of microalgae to biofuel. *Renew. Sustain. Energy Rev.* 16, 4316–4342.
- Subhadra, B.G., 2011. Water management policies for the algal biofuel sector in the Southwestern United States. *Appl. Energy* 88, 3492–3498.
- Sun, A., Davis, R., Starbuck, M., Ben-Amotz, A., Pate, R., Pienkos, P.T., 2011. Comparative cost analysis of algal oil production for biofuels. *Energy* 36, 5169–5179.
- Tang, S., Qin, C., Wang, H., Li, S., Tian, S., 2011. Study on supercritical extraction of lipids and enrichment of DHA from oil-rich microalgae. *J. Supercrit Fluids* 57, 44–49.
- Ugwu, C.U., Aoyagi, H., Uchiyama, H., 2008. Photobioreactors for mass cultivation of algae. *Bioresour. Technol.* 99, 4021–4028.
- Umdu, E.S., Tuncer, M., Seker, E., 2009. Transesterification of *Nannochloropsis oculata* microalga's lipid to biodiesel on Al₂O₃ supported CaO and MgO catalysts. *Bioresour. Technol.* 100, 2828–2831.
- Wang, Z., Calderon, M.M., Lu, Y., 2011. Lifecycle assessment of the economic, environmental and energy performance of *Jatropha curcas* L. biodiesel in China. *Biomass Bioenergy* 35, 2893–2902.
- Wijffels, R.H., Barbosa, M.J., 2010. An outlook on microalgal biofuels. *Science* 329, 796–799.
- Xiu, S., Shahbazi, A., 2012. Bio-oil production and upgrading research: A review. *Renew. Sustain. Energy Rev.* 16, 4406–4414.
- Xu, J., Jiang, J., Lv, W., Dai, W., Sun, Y., 2010. Rice husk bio-oil upgrading by means of phase separation and the production of esters from the water phase, and novolac resins from the insoluble phase. *Biomass Bioenergy* 34, 1059–1063.
- Xu, L., Brilman, D.W.F., Withag, J.A.M., Brem, G., Kersten, S., 2011. Assessment of a dry and a wet route for the production of biofuels from microalgae: Energy balance analysis. *Bioresour. Technol.* 102, 5113–5122.
- Xu, L., Weathers, P.J., Xiong, X.R., Liu, C.Z., 2009. Microalgal bioreactors: Challenges and opportunities. *Eng. Life Sci.* 9, 178–189.
- Yee, K.F., Tan, K.T., Abdullah, A.Z., Lee, K.T., 2009. Life cycle assessment of palm biodiesel: Revealing facts and benefits for sustainability. *Appl. Energy* 86, S189–S196.
- Zhu, L.Y., Zong, M.H., Wu, H., 2008. Efficient lipid production with *Trichosporon fermentans* and its use for biodiesel preparation. *Bioresour. Technol.* 99, 7881–7885.

Life-Cycle Assessment of Microalgal-Based Biofuels

Pierre Collet¹, Daniele Spinelli², Laurent Lardon¹, Arnaud Hélias^{1,3}, Jean-Philippe Steyer¹, Olivier Bernard⁴

¹INRA UR0050, Laboratoire de Biotechnologie de l'Environnement,
Avenue des Etangs, Narbonne, France

²Department of Chemistry and Center for Complex System Investigation,
University of Siena, Siena, Italy

³Montpellier SupAgro, Montpellier, France

⁴INRIA BIOCORE, Sophia Antipolis Cedex, France

13.1 INTRODUCTION

Environmental impacts and depletion of fossil energies have promoted the development of alternative and renewable sources of energy. Nonetheless, it is clear now that the replacement of current fossil energy will require both the development of new strategies to reduce our global energy consumption and the development of a panel of renewable energy sources. Renewable energy can be extracted from solar, wind, or geothermal energy. However, these energy forms are globally hard to store and hence cannot yet replace our consumption of fossil fuel for some important functions, such as powering cars and planes.

So far, several paths have been explored to produce fuels from renewable sources, the most developed strategies leading to the production of so-called first- and second-generation biofuels. First-generation biofuels are based on fuel production (ethanol or methylester) from a currently cultivated and harvested biomass (e.g., corn, rapeseed). Second-generation biofuels correspond to the development of new energy production pathways from usual feedstock not reclaimed by food production (e.g., straw or wood). The development of first-generation biofuels has been criticized—first, because of the direct competition they create with food crops in a context where food security is a raising concern, and second, because of their actual poor environmental performance. Indeed, inputs to production (e.g., fertilizer

or pesticides), feedstock culture, harvest, and transformation imply fuel consumption and lead to new pollutant emissions (Börjesson and Tufvesson, 2011), especially emissions of greenhouse gases to the environment (Searchinger et al., 2008). Consequently, energy and environmental benefits of these biofuels are limited. Second-generation biofuels improve environmental performance but are not free of criticisms.

These observations advocate for the necessity of systematically assessing new energy production paths with a *life-cycle assessment (LCA) perspective*, which means, first, the adoption of a cradle-to-grave perspective, that is, looking at resource depletion, energy consumption, and substance emissions of all the processes required to achieve the production and use of the fuel, and second, the assessment of several environmental impacts, not only global warming potential or net energy production. LCA is an ISO method developed with this aim: It allows the detection of pollution transfer from one step to another or from one kind of environmental impact to another. The European Directive on Renewable Energy (European Union, 2009), adopted in 2009, embraces LCA as a reference method to assess environmental impacts of biofuel and to meet greenhouse gas reduction objectives of 50% in 2017.

Third-generation biofuels correspond to the development of bioenergy productions based on new feedstock reputed to have lower land competition. Microalgae belong to this third category. Their very high actual photosynthetic yield and their ability to accumulate lipids, or, for some species, starch, added to the possibility that they can be cultivated in controlled environments, promise the potential of biofuel that has a low competition with food crops (Chisti, 2007) and limited environmental impacts. In addition, the ability to use CO₂ directly from industrial emissions as a source of carbon for the growth of microalgae is a promising feature for flue-gas mitigation (Huntley and Redalje, 2007; Chisti, 2007). However, this promise should be challenged. So far, microalgae industrial production has been developed only for the production of high-value molecules (such as beta-carotenes) or dietary supplements (*Spirulina* or *Chlorella* can be found as pills in health shops); hence, energy or environmental performance has never been a concern. Moreover, the scale of the existing facilities is far smaller than that required for fuel production (at least several hundred ha). It is necessary to assess the expected environmental performance of these potential production systems in order to detect technological bottlenecks and to determine which processes should be optimized in priority. This approach is now necessary to design a sound, energetically efficient, and environmentally friendly biofuel production system.

Since the new focus of international scientific and economic communities on microalgae-based biofuel, many environmental, energy, or economical assessments have been published, with different final energy carriers or different production assumptions. Here we propose to review a set of publications, all of them published in peer-reviewed scientific journals, using the LCA method to assess the environmental impacts linked to microalgae-based biofuel. The lack of real industrial facilities dedicated to energy production from microalgae imposes the use of models and extrapolations to describe the production systems. In addition, system frontiers and coproduct management differ among the studies. Altogether, this leads to divergences between publication results. This review aims to identify and explain this variability and then to propose guidelines to improve future LCAs of algal-based bioenergy production systems. This work is a mirror of this diversity and underlines the difficulty in comparing different studies without common assumptions.

13.2 ASSESSED FUNCTIONS, ASSOCIATED FUNCTIONAL UNITS, AND PERIMETERS OF MICROALGAE PRODUCTION LCAs

The main selection criterion has been a clear definition of a functional unit. The concept of *functional unit* (FU) is the main characteristic of the LCA (Udo de Haes et al., 2006) and allows relevant and fair comparisons between studies or between different technological options. Here the studies are briefly described:

- *Kadam (2002) (Kad)*. Comparative LCA of electricity production from coal only or from coal and microalgal biomass. Half of the CO₂ emitted from the power plant is assumed to be captured by a monoethanolamine (MEA) process.
- *Lardon et al. (2009) (Lar)*. LCA of biodiesel production in open raceways with or without nitrogen stress and with wet or dry extraction of the lipids.
- *Baliga and Powers (2010) (Bal)*. LCA of biodiesel production in photobioreactors located in cold climates. Cultivation is realized under greenhouses; heat losses from a local power plant are used as the heat source.
- *Batan et al. (2010) (Bat)*. LCA of biodiesel production in photobioreactors based on the Greenhouse Gases, Regulated Emissions, and Energy use in Transportation (GREET) model.
- *Clarens et al. (2010) (Cla10)*. Comparative LCA of the energy content of microalgae with terrestrial crops used as biofuel feedstock. Microalgae are cultivated in open raceways using chemical fertilizers.
- *Jorquera et al. (2010) (Jor)*. Comparative LCA of microalgal biomass production in open raceways, tubular photobioreactors, and flat plate photobioreactors.
- *Sander and Murthy (2010) (San)*. LCA of biodiesel production in open raceways based on the GREET model with a culture in two stages (first photobioreactors, then open raceways).
- *Stephenson et al. (2010) (Ste)*. Comparative LCA of biodiesel production in open raceways and photobioreactors. Oil extraction residues are treated by anaerobic digestion; the digestates are used as fertilizers.
- *Brentner et al. (2011) (Bre)*. Combinatorial LCA of industrial production of microalgal biodiesel. The base configuration consists of cultivation in open raceways, hexane extraction of dry algae, and methanol transesterification. Oilcakes are considered as a waste; the optimized configuration is composed of cultivation in PBR, extraction with *in situ* esterification by supercritical methanol, anaerobic digestion of oilcakes, and use of the digestates as fertilizers.
- *Campbell et al. (2011) (Cam)*. LCA and economic analysis of biodiesel production in open ponds. Pure CO₂ produced during the synthesis of nitrogen fertilizer is used as a source of carbon.
- *Clarens et al. (2011) (Cla11)*. LCA of algae-derived biodiesel and bioelectricity for transportation. Four types of bioenergy production are compared: (1) anaerobic digestion of bulk microalgae for bioelectricity production, (2) biodiesel production with anaerobic digestion of oilcakes to produce bioelectricity, (3) biodiesel production with combustion of oilcakes to produce bioelectricity, and (4) direct combustion of microalgae biomass to produce bioelectricity. Four ways to supply nutrients are compared: (1) pure CO₂, (2) CO₂ captured from a local coal power plant, (3) CO₂ in flue gas, (4) CO₂ in flue gas and nutrients in wastewater.

- [Collet et al. \(2011\)](#) (Col). LCA of biogas production from anaerobic digestion of bulk microalgae. Biomass is grown in open raceways; digestates are used as fertilizers.
- [Hou et al. \(2011\)](#) (Hou). LCA of biodiesel from microalgae and comparison with soybean and jatropha.
- [Khoo et al. \(2011\)](#) (Kho). LCA of biodiesel from microalgae. Cultivation is carried out in two phases: first in photobioreactors, then in open raceway.
- [Yang et al. \(2011\)](#) (Yan). LCA of biodiesel production limited to water and nutrient consumption.

Among the 15 selected papers, two functions are assessed: either *biomass production* (two publications) or *bioenergy production* (14 publications). Three final vectors for the bioenergy are considered: methylester (11 publications), methane (2 publications), and electricity (2 publications). It is worth noting that these different energy carriers have different characteristics. Methane and methylester are easily storable, unlike electricity. There is also an important diversity of FUs. Most of the studies focus on the production of biodiesel as the main energy output from microalgae. The amount of biodiesel produced is described in different units: volume ([Baliga and Powers, 2010](#)), mass ([Stephenson et al., 2010](#)), or energy content ([Lardon et al., 2009](#)). Unfortunately, there is no consensus on the values of energy content or on the mass density of algal oil and algal methylester; in addition, the description of the energy content is not harmonized and can be based either on the lower heating value (LHV) or the high heating value (HHV). Finally, among the studies dedicated to biodiesel production, six are *well-to-pump* studies, which means that the use of the fuel is not included in the perimeter ([Baliga et Powers, 2010](#); [Batan et al., 2010](#); [Sander and Murthy, 2010](#); [Brentner et al., 2011](#); [Khoo et al., 2011](#); [Yang et al., 2011](#)), and five are *well-to-wheel* studies, where the use of the fuel is included ([Lardon et al., 2009](#); [Stephenson et al., 2010](#); [Campbell et al., 2011](#); [Clarens et al., 2011](#); 2011; [Hou et al., 2011](#)).

This diversity of FUs leads to a diversity of perimeters for the inventory. [Table 13.1](#) summarizes the assessed systems. The different steps potentially included in the perimeter of the study can be classified among five categories: production of the inputs required for the cultivation (I), cultivation (C), harvesting and conditioning of microalgae (H), transformation into different types of energy carrier (T), and, eventually, use of the produced energy (U).

[Figures 13.1](#) and [13.2](#) illustrate the various options met in the selected LCAs. The culture phase is the more consensual, with two options: open raceways or photobioreactors. The transformation phase is the one with the largest number of alternatives, including the final energy carrier or the fate of the coproducts.

13.3 MODELING THE INVENTORY DATA

According to the LCA method, once the FU, the perimeter of the study, and the system have been defined, each process included in the perimeter has to be characterized in terms of technical inputs and outputs, energy and resource consumption, and emissions into the environment. Because of the lack of industrial data on microalgae culture or transformation, the inventory data compiled in the selected studies often rely on extrapolation from lab-scale results, adaptation from similar processes used in different conditions or with different feedstock, or modeling.

TABLE 13.1 Functional Units and Perimeters of Selected Studies.

Reference	Functional Unit	Heating Value	Perimeter				
			I	C	H	T	U
Kad	Production of 1 MWh of electricity	–	✓	✓	✓	✓	✓
Lar	Combustion of 1 MJ of biodiesel	37.8 MJ _{LHV} kg ⁻¹	✓	✓	✓	✓	✓
Bal	Production of 1 L of biodiesel	–	✓	✓	✓	✓	
Bat	Production of 1 MJ of biodiesel	–	✓	✓	✓	✓	
Cla10	Production of 317 GJ of algae	MJ _{HHV} kg ⁻¹	✓	✓	✓		
Jor	Production of 100 t DM of algae	–	✓	✓			
San	Production of 1000 MJ of biodiesel	41.2 MJ _{HHV} kg ⁻¹	✓	✓	✓	✓	
Ste	Combustion of 1 t of biodiesel	MJ _{LHV} kg ⁻¹	✓	✓	✓	✓	✓
Bre	Production of 10 GJ of algal methylester	34 MJ-HHV kg ⁻¹	✓	✓	✓	✓	
Cam	Carriage of 1 t.km	–	✓	✓	✓	✓	✓
Cla11	Vehicle kilometer traveled	23.1 MJ-X kg ⁻¹	✓	✓	✓	✓	✓
Col	Combustion of 1 MJ of methane	6.96 MJ _{LHV} m ⁻³	✓	✓	✓	✓	✓
Hou	Combustion of 1 MJ of biodiesel	–	✓	✓	✓	✓	✓
Kho	Production of 1 MJ of biodiesel	40 MJ _{LHV} kg ⁻¹	✓	✓	✓	✓	
Yan	Production of 1 kg of biodiesel	–	✓	✓	✓	✓	

13.3.1 Choice of Inputs

The *input category* refers here to any product or service required at some point of the microalgae culture or transformation. It includes the *materials* used to build cultivation systems, *fertilizers* and chemical *reactants*, production of *electricity*, and *heat* required at the facility. Almost all the publications consider these inputs in exhaustive ways, except:

- [Jorquera et al. \(2010\)](#). Fertilizers are not taken into account.
- [Clarens et al. \(2010, 2011\)](#). Infrastructures are not taken into account.
- [Sander et Murthy \(2010\)](#). Only flows that contribute to more than 5% of the total mass, energy, and economy are taken into account.

The energy and the fertilizer are the most influencing inputs on the final environmental performance and energy balance.

13.3.1.1 Energy

Table 13.2 specifies the electricity and heat sources used in the publications in our study. The electricity mix is determined by the country where the production is supposed to take place; in some publications, electricity and heat consumption are totally or partially covered by internal production from the microalgae, either by anaerobic digestion of the oilcakes

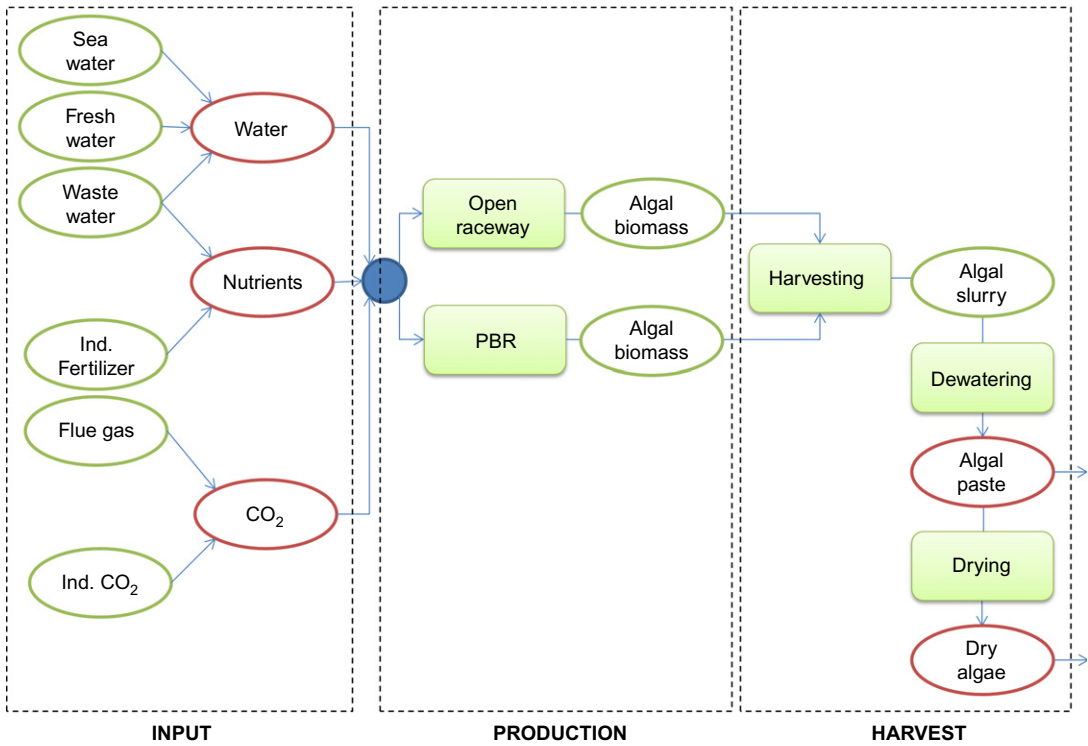

FIGURE 13.1 System diagram for input, biomass production, and biomass conditioning.

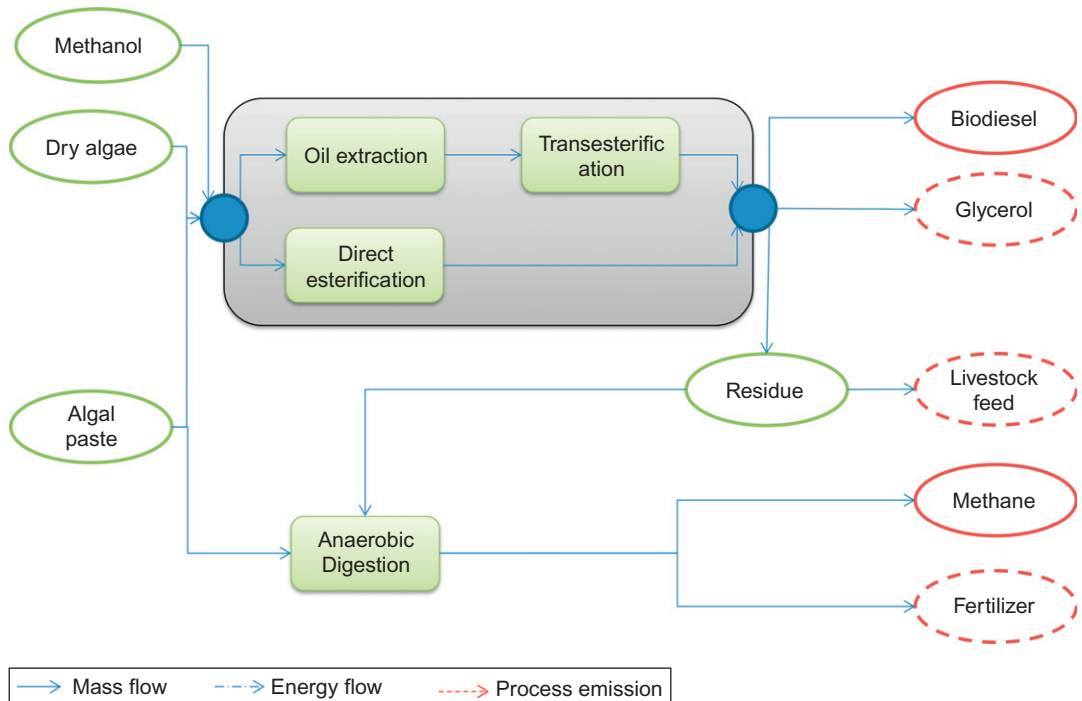

FIGURE 13.2 System diagram for biomass transformation. (UF=plain circles; coproducts=dashed circles.)

TABLE 13.2 Energy Sources Used to Produce Biomass and Biofuels from Microalgae.

Energy	Electricity								Heat		
	Mix USA	Mix UK	Mix EU	Mix Australia	Mix China	Coal	Algae	NC	Natural Gas	Algae	NC
Ref	Bal	Ste	Lar	Cam	Hou	Kad	Ste	Jor	Kad	Ste	Cam
	Bat		Col				Bre	KhoYan	Lar	Bre	Kho
	Clal0						Cam		Bal	Clal1	Yan
	San						Clal1		Bat	Col	
	Clal1								San		
									Clal1		
									Hou		

NC = Not communicated.

(Stephenson et al., 2010; Brentner et al., 2011; Campbell et al., 2011; Clarens et al., 2011) or of the algal biomass (Clarens et al., 2011; Collet et al., 2011) or by direct combustion of microalgal biomass or extraction residue (Clarens et al., 2011).

Most of the authors (Lardon et al., 2009; Baliga et Powers, 2010; Sander and Murthy, 2010; Stephenson et al., 2010; Khoo et al., 2011) underlined the important contribution of energy consumption to the global-warming potential of algal energy productions. The sensitivity of this choice has been assessed with inventories from the EcoInvent database and the ReCiPe impact assessment method (Goedkoop et al., 2009) in a hierarchical perspective. With this perspective, characterization factors of the global-warming potential are the ones defined by the IPCC (IPCC, 2006). As shown in Figure 13.3, climate change impact can vary by a factor of two according to the chosen electric mix. Consequently, the potential reduction of greenhouse gases by producing bioenergy from microalgae is strongly correlated with the origin of the electricity. It is important to note that the variations of endpoint impacts (i.e., human

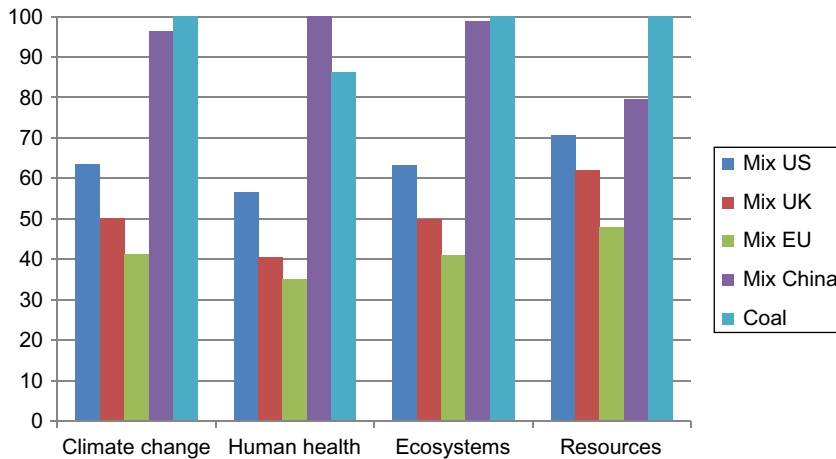

FIGURE 13.3 Climate change and endpoint impacts of various electric mixes (percentage of the worst case by impact category).

health, ecosystems, and resources) are almost identical to that of the climate change impact. This underlines the strong dependence of all the impacts on the energy mix composition.

13.3.1.2 Nutrients

The nutrient requirement is known to depend on the species but also on the stress that has been induced to stimulate lipid or carbohydrate storage. The nitrogen and phosphorus quota can strongly vary during a starvation period (Geider and La Roche, 2002). The hypotheses on required fertilizers strongly vary according to the species and between the publications for the same species (Lardon et al., 2009; Stephenson et al., 2010; Yang et al., 2011). Needs in nitrogen vary from 10.9 g kgDM^{-1} (Lardon et al., 2009) to $20.32 \text{ g kgDM}^{-1}$ (Stephenson et al., 2010) in limiting conditions and from 9.41 g kgDM^{-1} (Kadam, 2002) to 77.6 g kgDM^{-1} (Clarens et al., 2011) without stress. Needs in phosphorus vary from 2.4 g kgDM^{-1} (Lardon et al., 2009) to 2.58 g kgDM^{-1} (Khoo et al., 2011) in limiting conditions, and from 0.02 g kgDM^{-1} (Kadam, 2002) to 71 g kgDM^{-1} (Yang et al., 2011) without stress. All the authors agree on high nutrient consumption for the culture of microalgae, but they differ on the ways to provide them (see Table 13.3). Some authors, such as Sander and Murthy (2010) and Clarens et al. (2010, 2011), consider that the needs in nitrogen and phosphorus can be totally or partially covered by the addition of wastewater to the growth medium. But in most of the publications, nutrients are provided by chemical fertilizers. To reduce the nutrient consumption, several authors suggest recycling the digestates resulting from the anaerobic digestion of oilcakes (Stephenson et al., 2010; Brentner et al., 2011; Campbell et al., 2011; Clarens et al., 2011) or of bulk microalgae (Clarens et al., 2011; Collet et al., 2011).

Figure 13.4 shows environmental impacts of various fertilizer sources. As previously demonstrated for the energy mix, the source of nutrients can have important consequences on the environmental balance of the energy production from microalgae. Climate-change impact and endpoint impacts on human health and ecosystem can vary by a factor of two, based on the chosen nitrogen fertilizer. For these three impacts, ammonium nitrate is the worst one, and the impacts of ammonium sulphate, calcium nitrate, and urea are quite the same. Concerning resource consumption, urea is the worst, mainly because of the high amount of natural gas used for its production. Clarens et al. (2010, 2011) and Sander and Murthy (2010) suggest using wastewater to grow algae. This assumption allows reducing the consumed quantities of freshwater and chemical fertilizers. However, mineral elements' content in wastewater can strongly vary depending on the place and the period of the year. For these reasons, from our point of view it seems very difficult to rely on such fertilizers.

13.3.2 Cultivation of Microalgae

13.3.2.1 Cultivation System and Growth Medium

Microalgae cultivation is generally realized in two kinds of systems: open raceways (ORW) or photobioreactors (PBR). ORWs are shallow ponds (between 10 and 50 cm depth). They can be built in concrete (Lardon et al., 2009) or simply carved from the ground (Campbell et al., 2011) and can be recovered by a plastic liner made of high-density polyethylene (HDPE) (Collet et al., 2011) or polyvinylchloride (PVC). Ponds are generally open but can be sheltered under a greenhouse. This kind of system is commonly used in the industry to produce

TABLE 13.3 Various Sources of Nutrients Used for Microalgae Cultivation.

Ref	Nitrogen			Phosphorus			Potassium		
	Mineral	Organic and Recycled	NC	Mineral	Organic and Recycled	NC	Mineral	Organic and Recycled	NC
Kad	Ammonia	-	-	Single superphosphate	-	-	Potassium sulphate	-	-
Lar	Calcium nitrate	-	-	Single superphosphate	-	-	Chloride potassium	-	-
Bal	-	-	X	-	-	X	-	-	-
Bat	-	-	X	-	-	X	-	-	-
Cla10	-	Urea, wastewater	-	Single superphosphate	Wastewater	-	-	-	-
Jor	-	-	-	-	-	-	-	-	-
San	-	Wastewater	-	-	Wastewater	-	-	-	-
Ste	Ammonium nitrate	-	-	Triple superphosphate	-	-	-	-	-
Bre	Ammonium nitrate	-	-	Calcium phosphate	-	-	-	-	-
Cam	-	-	X	-	-	X	-	-	-
Cla11	Ammonium phosphate	Digestates	-	Ammonium phosphate	Digestates	-	-	-	-
Col	Ammonium sulphate	Digestates	-	Single superphosphate	Digestates	-	Chloride potassium	Digestates	-
Hou	-	-	X	-	-	X	-	-	-
Kho	Sodium nitrate	-	-	Sodium phosphate	-	-	-	-	-
Yan	-	-	X	-	-	X	-	-	X

NC=Not communicated.

microalgae used as foodstuffs (Shimamatsu, 2004; Del Campo et al., 2007). PBRs are closed systems that allow the intensification of the culture. There are numerous types and very different designs of PBR. They can be tubular (TPBR) or made of flat panels (FPBR) (Jorquera et al., 2010) or more rustically made of simple polyethylene bags soaked in a thermostatic water bath (Batan et al., 2010).

The choice of growth medium can be made independently of the cultivation system. Depending on the chosen species, algae can be cultivated in fresh water, brackish water, or seawater. The use of wastewater has also been suggested by several authors (Clarens et al., 2010, 2011; Sander and Murthy, 2010), offering the double advantage of an unreclaimed source of water and nutrients. However, it should be acknowledged that microalgae grown in wastewater could not be used afterward as feedstock for fish or cattle. Water consumption has

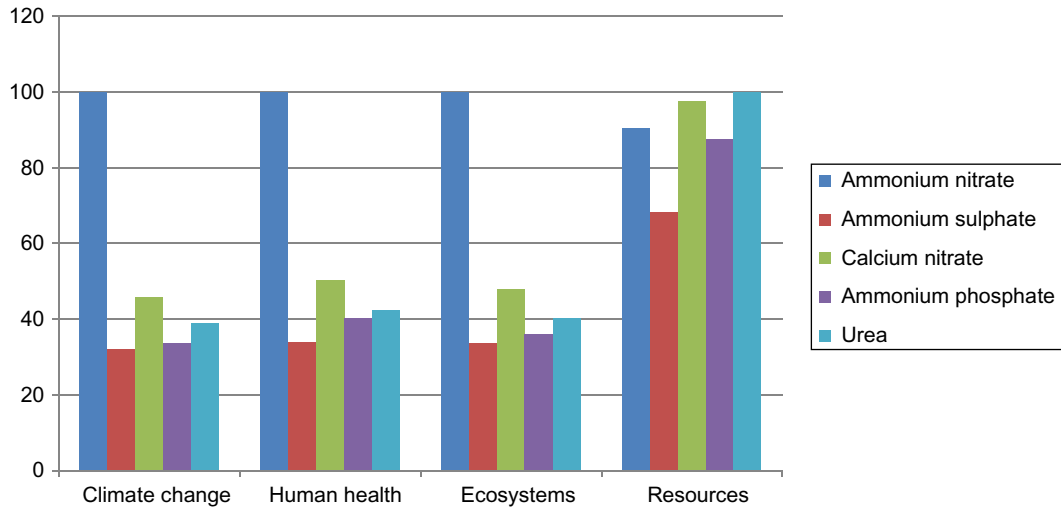

FIGURE 13.4 Climate change and endpoint impacts of various fertilizers (percentage of the worst case by impact category).

been identified as one of the main environmental concerns of bioenergy production from microalgae. Consequently, some authors suggest growing algae in seawater in order to have an unlimited resource (Batan et al., 2010; Khoo et al., 2011). Brackish water from groundwater is also used in some systems (Clarens et al., 2011). It should be noted that fresh water is still required in these systems in order to stabilize the salinity.

Table 13.4 lists cultivation systems, growth media, and cultivated species mentioned in the selected studies.

13.3.2.2 Operating Conditions

Mineral composition, C/N ratio, and growth rate of microalgae vary naturally according to environmental conditions (light and temperature), availability of nutrients, or occurrence of stress. For instance, the application of nitrogen starvation induces, for some species, the storage of lipids (Ketchum and Redfield, 1949). However the increase of lipid content is done to the detriment of cell division, and consequently the mass productivity is lower. Therefore, it should be highlighted that all these properties are correlated and cannot be determined on the basis of independent assumptions or sources.

As shown on Table 13.5, a large variability of productivity, lipid fraction, or nutrient requirement is observed among the various studies. In four publications (Lardon et al., 2009; Batan et al., 2010; Stephenson et al., 2010; Khoo et al., 2011), authors suggest to impose nitrogen deprivation on the algae. To overcome the problem of the growth-rate reduction under nutrient stresses, some authors suggest cultivating microalgae in two steps. First, microalgal biomass is cultivated in nitrogen-replete conditions in order to reach a high growth rate. Then microalgae are submitted to nitrogen deprivation to increase their lipid content.

TABLE 13.4 Cultivation Systems, Growth Media, and Cultivated Species.

Ref	Cultivation System		Growth Medium				Cultivated Species
	ORW	PBR	Freshwater	Seawater	Brackish Water	Wastewater	
Kad	X	–	–	X	X	–	NC
Lar	X	–	X	–	–	–	<i>Chlorella vulgaris</i>
Bal	–	X	–	X	–	–	<i>Phaeodactylum tricornutum</i>
Bat	–	X	–	X	–	–	<i>Nannochloropsis salina</i>
Cla10	X	–	X	–	–	X	NC
Jor	X	X	–	X	–	–	<i>Nannochloropsis</i> sp.
San	X	–	–	–	–	X	NC
Ste	X	X	X	–	–	–	<i>Chlorella vulgaris</i>
Bre	X	X	X	–	–	–	<i>Scenedesmus dimorphus</i>
Cam	X	–	–	X	–	–	NC
Cla11	X	–	–	–	X	X	<i>Tetraselmis</i> sp., <i>Cyclotella</i> sp., <i>Dunaliella</i> sp., <i>Phaeodactylum tricornutum</i>
Col	X	–	X	–	–	–	<i>Chlorella vulgaris</i>
Hou	X	–	–	X	–	–	NC
Kho	X	X	–	X	–	–	<i>Nannochloropsis</i> sp.
Yan	X	–	X	–	–	–	<i>Chlorella vulgaris</i>

NC = Not communicated.

Growth rate is known to be species dependent and strongly influenced by light and temperature (Falkowski and Raven, 1997). It can be strongly reduced by the stress protocol used to induce lipid accumulation by nutrient deprivation (Lacour et al., 2012). Depending on the location, cultivation system, species, and protocol, growth rate and biomass concentration can therefore vary by more than an order of magnitude. The hypotheses made in LCA studies reflect this large spectrum. In ORW, growth rates vary from 25 (Batan et al., 2010; Collet et al., 2011) to $40.6 \text{ g m}^{-2} \text{ d}^{-1}$ (Clarens et al., 2010). In PBR, productivities are much higher and vary from 270 (Jorquera et al., 2010) to $1536 \text{ g m}^{-3} \text{ d}^{-1}$ (Brentner et al., 2011). The PBR conception has a strong influence on the growth rate (Jorquera et al., 2010). Microalgae concentrations range from 0.5 (Lardon et al., 2009) to 1.67 g L^{-1} (Stephenson et al., 2010) in an OR, and from 1.02 (Jorquera et al., 2010) to 8.3 g L^{-1} (Stephenson et al., 2010) in a PBR. Expected lipid contents vary broadly between authors: from 17.5% (Lardon et al., 2009) to 50% (Kadam, 2002) without nitrogen deprivation and from 25% (Khoo et al., 2011) to 50% with nitrogen deprivation (Batan et al., 2010; Stephenson et al., 2010).

TABLE 13.5 Operating Conditions and Needs in Fertilizers for Microalgae Cultivation.

Ref	Growth Rate ($\text{g m}^{-2} \text{d}^{-1}$ for ORW) ($\text{g m}^{-3} \text{d}^{-1}$ for PBR and FPBR)	Concentration (g L^{-1})	Nitrogen Deprivation	Lipid (%)	Nutrients ($\text{g kg}^{-1}\text{DM}$)			
					N	P	K	CO ₂
Kad	ORW: 31.4	0.8	No	50	9.41	0.02	0.01	2.16
Lar	ORW: 24.75	0.5	No	17.5	46	9.9	8.2	1.8
	ORW: 19.25		Yes	38.5	10.9	2.4	2.0	2.0
Bal	–	3.4	No	30	65	13	–	0.51
Bat	ORW: 25	–	Yes	50	–	–	–	–
Clal0	ORW: 40.6	1	No	–	70	14.73	–	1.6
Jor	ORW: 35 FPBR: 270 PBR: 560	ORW: 0.35 FPBR: 2.7 TPBR: 1.02	No	29.6	–	–	–	–
San	–	0.5	No	30	–	–	–	–
Ste	ORW: 30 PBR: 1,000	ORW: 1.67 PBR: 8.3	Yes	50	20.32	–	–	2.30
Bre	ORW: 27.5 PBR: 1536	ORW: 0.47 PBR: 4	No	31.25	82	10	–	1.79
Cam	ORW: 30	–	No	–	5.6	0.56	–	1.68
Clal1	ORW: 27.9	1.4	No	19.6	77.6 (including wastewater)	5.17 (including wastewater)	–	2.36
Col	ORW: 25	0.5	No	–	61	8.1	6.59	1.345
Hou	ORW: 30	–	No	45	5.5	0.56	–	1.68
Kho	ORW: 25 PBR: NC	0.5	Yes	25	24.7	2.58	–	1.83
Yan	ORW: 35	1	No	35	33	71	58	–

13.3.2.3 Quantity and Quality of CO₂

CO₂ must be supplied to the growth medium to reach high algal productivities. It has been shown that, provided that pH is regulated, the microalgae can be very tolerant to the source of CO₂ (Doucha et al., 2005). However, the dissolution efficiency, together with the ability of microalgae to consume this CO₂, are very dependent on the cultivation system. The supply rate in the LCA studies ranges from 0.51 to 2.36 kgCO₂ kgDM⁻¹. Depending on the studies, CO₂ is supplied from compressed and purified gas or from the flue gas of a local power plant, either after capture or directly (Table 13.6). The percentages of CO₂ in the flue gas vary from 5% (Stephenson et al., 2010) to 15% (Brentner et al., 2011; Campbell et al., 2011). It is common to point out the lack of knowledge of the long-term consequences on algae and on culture facility due to the use of flue gas. However, Yoo et al. (2010) demonstrated that *Botryococcus braunii* and *Scenedesmus* sp. could grow using flue gas as a source of carbon. Energy costs of

TABLE 13.6 Various Forms of CO₂ and Steps Included in the Inventory.

Ref	Forms of CO ₂ Injected into the Growth Medium	Steps Included in the Inventory		
		Purification	Transport	Injection
Kad	(a) Pure CO ₂	(a) Yes, from flue gas from power plants at 14% in CO ₂	Yes	Yes
	(b) Flue gas at 14%	(b) No		
Lar	NC	No	No	Yes
Bal	Pure CO ₂	Yes	Yes	Yes
Cla10	Pure CO ₂	No	No	No
Ste	(a) Flue gas at 12.5%	No	No	Yes
	(b) Flue gas at 9%			
	(c) Flue gas at 5%			
Bre	(a) Pure CO ₂	(a) No, from flue gas ammoniac plants at 100% of CO ₂	No	Yes
	(b) Pure CO ₂	b) Yes, from flue gas power plants at 15% of CO ₂		
Cam	(a) Pure CO ₂	a) No, from flue gas ammoniac plants at 100% of CO ₂	Yes	Yes
	(b) Pure CO ₂	b) Yes, from flue gas power plants at 15% of CO ₂		
Cla11	(a) Pure CO ₂	(a) No	Yes	Yes
	(b) Pure CO ₂	(b) Yes		
	(c) Flue gas at 12.5%	(c) No		
Col	Pure CO ₂ +CO ₂ recovered from the purification of the biogas+ dissolved CO ₂ in the anaerobic digestion output flow	Yes, just for the CO ₂ coming from the biogas	No	Yes
Kho	Pure CO ₂	No	No	Yes

injection and head losses are always taken into account. The injection of flue gas in the growth medium without prior enrichment or compression requires compressing higher volumes of gas and reduces the efficiency of the gas-injection system. Hence there is a clear trade-off in terms of energy consumption between prior purification and gas injections. Some authors (Kadam, 2002; Brentner et al., 2011; Clarens et al., 2011) include in their study the costs of purification and transport.

13.3.2.4 Emissions to the Environment

CO₂ emissions inevitably occur in ORW because of the poor efficiency of the injection system and because of the natural outgassing from the growth medium. Only four publications

(Kadam, 2002; Stephenson et al., 2010; Campbell et al., 2011; Collet et al., 2011) take into account these losses, with respective emissions of CO₂ equal to 0.07%, 30%, 10%, and 10%. A few studies only consider emissions of other gases. Campbell et al. (2011) consider that 0.11% of the nitrogen is volatilized without specifying the forms of the emissions. According to Hou et al. (2011), 0.5% is volatilized as NH₃. Finally, Batan et al. (2010) mention NH₃ volatilization without quantification.

13.3.3 Harvesting and Conditioning of the Biomass

It is widely acknowledged that one of the major bottlenecks of bioenergy production from microalgae lies in the concentration step. The selected studies assess a large variety of technologies to achieve concentration, dewatering, and sometimes drying of the algal biomass. The final dry-matter content (DM) before biofuel production depends also on the transformation process. For instance, anaerobic digestion of bulk microalgae requires a low DM content, from 5% (Collet et al., 2011) to 14% (Clarens et al., 2011). DM content for biodiesel production varies from 14% (Clarens et al., 2011) in the case of wet extraction to 90% (Lardon et al., 2009) in the case of dry extraction and from 50–98% for direct combustion. Table 13.7 summarizes harvesting and conditioning technologies in regard to the biomass transformation option selected in the various studies.

Several studies suggest a first step of flocculation/sedimentation to concentrate the biomass (Table 13.7). It was supposed to be done by pH adjustment with lime (Lardon et al., 2009; Brentner et al., 2011) or by addition of aluminium sulphate (Clarens et al., 2010; Stephenson et al., 2010; Brentner et al., 2011), chloride iron (Hou et al., 2011; Khoo et al., 2011), or chitosan (Brentner et al., 2011). For some species, harvesting can be done by passive sedimentation. This first step results in algal slurry with a DM content varying from 2% (Lardon et al., 2009) to 14% (Clarens et al., 2011). An important issue for the characterization of this step is the determination of the settling velocity and the ratio of biomass staying in the supernatant. Still, the concentration of the algal slurry after settling is not high enough to allow efficient down-processing. The most classical way to further increase the biomass concentration is centrifugation, even though this method is considered one of the most energy consuming (Molina Grima et al., 2003). Collet et al. (2011) use data from a spiral plate centrifuge, which is reputed to consume less energy; other authors rely on rotary drums (Lardon et al., 2009). Finally, solar drying was used in one study (Kadam, 2002), which led to an important decrease of the energy consumption of this step.

13.4 MICROALGAL BIOMASS TRANSFORMATION INTO ENERGY

Studied LCAs use three different kinds of energy carriers: electricity obtained by direct combustion of the biomass, biodiesel by sequential or direct triglycerides esterification, and biogas by anaerobic digestion.

TABLE 13.7 Conditioning and Dry-Matter Content of the Algal Slurry in Regard to its Transformation Into an Energy Carrier.

Ref	Harvesting and Conditioning	Biomass Transformation		
		Electricity	Oil Extraction/ Transesterification	Biogas
Kad	Centrifugation 1: 0.8% Centrifugation 2: 12% Solar drying: 50%	Co-combustion with coal	–	–
Lar	Flocculation: 2% Rotary press: 20% Dry extraction belt dryer: 90%	–	Hexan-methanol	–
	Wet extraction: 20%			
Bal	Centrifugation: 30% Steam drying: 95%	–	Hexane-methanol	–
Bat	Centrifugation: NC	–	Hexane-methanol	–
Clal0	Flocculation: NC Centrifugation: 10%	–	–	–
San	Filter press: NC Plate separator: NC Dryer: 91%	–	Hexane-methanol	–
Ste	Flocculation Centrifugation: 22%	–	Hexane-methanol	Oilcakes: 0.383 m ³ CH ₄ kgDM ⁻¹
Bre	Flocculation Centrifugation: 20%	–	Hexane-methanol Supercritical CO ₂ – methanol Sonication + esterification Supercritical methanol	Oilcakes: 0.800 m ³ CH ₄ kgDM ⁻¹
Cam	Flocculation: NC Dissolved air flotation: NC	–	Hexane-methanol	Oilcakes: 0.320 m ³ CH ₄ kgDM ⁻¹
Clal1	Autoflocculation: 1.4% Settling: 14%	Drying (90–98% DM) Co-combustion with coal	Hexane-methanol	Oilcakes: 0.369 m ³ CH ₄ kgDM ⁻¹ Algae: 0.441 m ³ CH ₄ kgDM ⁻¹
Col	Natural settling: 1% Centrifugation: 5%	–	–	Algae: 0.262 m ³ CH ₄ kgDM ⁻¹
Hou	Flocculation	–	Hexane-methanol	–
Kho	Flocculation: 3% Centrifugation: 15%	–	Hexane-methanol	–
Yan	Drying, up to 90%	–	Hexane-methanol	–

NC = Not communicated.

13.4.1 Electricity Production

Electricity production is the easiest process to develop. Biomass is first dried up to 50% or 98% DM and then burned in co-combustion with coal. According to [Clarens et al. \(2011\)](#), this transformation path has the lowest impacts on the environment. However, it is important to note that in this study, the heat needed to dry the biomass comes from the recovery of flue gas and hence is not accounted for in the environmental balance nor the energy balance.

13.4.2 Biodiesel Production

Very scarce data are available to build up an inventory of microalgal oil extraction. Characterization of the lipid content of microalgae is based on techniques and solvents that cannot be extrapolated to industrial-scale techniques, and often the characterization is done on lyophilized algae, which of course is not an option for bioenergy production. Hence inventories for oil extraction and methylester production are usually based on inventories of vegetable oil production and transesterification (e.g., rapeseed or soybean). Some studies specify a phase of pretreatment based on homogenizers. The rapid compression and decompression of the algal slurry is supposed to disrupt cell walls and hence increase extraction efficiency and digestibility of extraction residues ([Stephenson et al., 2010](#); [Clarens et al., 2011](#)). Triglycerides are extracted with an organic solvent; hexane, lipids, and aqueous phases are then separated and the oil/hexane mixture is finally purified by distillation. During distillation, most of the hexane is recovered, so only a small quantity is lost by volatilization.

In all the concerned studies, triglyceride esterification is performed by reaction with methanol and with alkaline catalysis. This step requires heating, mixing, and the addition of a base, usually potassium hydroxide. The reaction yield can be significantly reduced by a concurrent saponification reaction, which is enhanced by water. Consequently there is a trade-off between the energy to invest for dewatering and drying the biomass and the energy for extracting and down-processing the lipid fraction, with reaction yields drastically affected by the water content. Other approaches have been proposed, such as supercritical CO₂ extraction of lipids or *in situ* esterification. Both approaches could suffer from too high water content. More recently, *in situ* esterification with supercritical methanol has been proposed as a way to overcome this issue. This last option was selected in the LCA-based optimization proposed [Brentner et al. \(2011\)](#).

13.4.3 Biogas Production

Finally, biomass can be converted into biogas, either directly from the microalgal biomass or indirectly by the anaerobic digestion of the oilcakes. Various kinds of energies can thus be produced, and the perimeters of the study could be different. Methane potential strongly varies depending on the species composition and degradability ([Sialve et al., 2009](#)). In the considered studies, it ranges from 0.262 ([Collet et al., 2011](#)) to 0.800 m³CH₄ kgDM⁻¹ ([Brentner et al., 2011](#)). It should be noted that this last value is higher than the theoretical maximum value for *Scenedesmus* ([Sialve et al., 2009](#)). Energy consumption of anaerobic digesters is usually ignored. It is regrettable, since long hydraulic retention times required to digest low biodegradable materials (from 10 to 40 days) represent a significant energy effort for mixing and

heating. Heat consumption is estimated at $2.45 \text{ MJ kg}_{\text{DM}}^{-1}$ in Collet et al. (2011), and electricity consumption is estimated at $0.47 \text{ MJ kg}_{\text{DM}}^{-1}$ in Brentner et al. (2011) and $0.39 \text{ MJ kg}_{\text{DM}}^{-1}$ in Collet et al. (2011).

13.5 ENVIRONMENTAL IMPACT ASSESSMENT

The inventory phase allows the estimation of all resources, products, and emissions required for the production of one unit of the FU. This inventory phase will be used to determine potential environmental impacts, including global-warming potential, and the energy balance. In addition to the variability stemming from different process designs or parameter assumptions, the way of handling coproducts and the actual method chosen to assess energy balance or environmental impacts will strongly affect the conclusions.

13.5.1 The Coproducts Issue

One of the statements of the LCA methodology is to link every economic and environmental flow to the reference flow of the FU. However, several processes implied in the production of the FU can lead to the production of several products. Two approaches are possible to handle the multifunctionality of the system: allocation or substitution. The *allocation* approach consists of distributing the environmental burden of the upstream between all the coproducts of the multi-output process. This distribution should be based on the most sensitive criterion, e.g., mass, economic value, or energy content of the products. The *perimeter expansion* (or *substitution*) option consists of adding the coproduct to the FU. The ISO norm for LCA stipulates that perimeter expansion should be preferred when possible. When substitution is not possible, energy allocation should be preferred for processes leading to the production of energy.

Among the 15 publications, 3 publications (Kadam, 2002; Clarens et al., 2010; Jorquera et al., 2010) analyze systems without coproducts. Table 13.8 presents the various coproducts and the choices between allocation and substitution. Several processes can lead to coproducts:

- The oil extraction process leads to the production of an extraction residue (oilcake); only Lardon et al. (2009) chose to use an energy-based allocation at this level. Other authors (Stephenson et al., 2010; Brentner et al., 2011; Campbell et al., 2011; Clarens et al., 2011) chose to directly treat the oilcake by anaerobic digestion. Oilcakes can also replace other products: aquaculture or livestock food, carbohydrates' source for bioethanol production.
- Oil esterification produces methylester and glycerol; here economic and energy allocation are often used. In case of substitution, glycerol is mainly used as a source of heat.
- Anaerobic digestion produces biogas and solid and liquid digestates; these digestates can be considered waste (and hence cannot support a part of the environmental burden of the process), fertilizer, or soil conditioner. The liquid digestate can be recirculated to the culturing device and hence substituted to a fraction of the mineral fertilizer required for the algae. The produced biogas is transformed into heat used on site to heat the digesters and/or converted into electricity. Electricity is also consumed on site, and the surplus is injected into the network (Stephenson et al., 2010; Clarens et al., 2011).

TABLE 13.8 Management of the Coproducts and Impact Assessments.

Ref	Management of the Coproducts	Energy Balance	Impact Assessment
Kad	No coproduct	NER	Climate change, depletion of natural resources, acidification, eutrophication (CML)
Lar	Oilcakes: Energy allocation Glycerol: Energy allocation	NER CED	10 impacts (CML)
Bal	Oilcakes: Substitution with soybean oilcakes based on their protein content	NER	Climate change, toxic emissions (air), land use, acidification (unspecified method)
Bat	Oilcakes: Substitution with aquaculture food	NER	Climate change (IPCC)
Cla10	No coproduct	CED	Climate change (IPCC), land use, eutrophication (unspecified method)
Jor	No coproduct	NER	–
San	Oilcakes: Substitution with maize for ethanol production	NER	Climate change (IPCC), liquid and solid waste (unspecified method)
Ste	Oilcakes: System expansion (anaerobic digestion to produce biogas) Digestates are considered waste Glycerol: Economic allocation on the pharmaceutical market or substitution to heat production	NER CED	Climate change (IPCC)
Bre	Oilcakes: System expansion (anaerobic digestion to produce biogas) Glycerol: Economic allocation	NER CED	Climate change, eutrophication, land use (TRACI)
Cam	Oilcakes: System expansion (anaerobic digestion to produce biogas) Digestates considered waste	–	Climate change (Kyoto Protocol)
Cla11	Oilcakes: System expansion (anaerobic digestion to produce biogas) Digestates considered mineral fertilizers	NER CED	Climate change (IPCC)
Col	Digestates considered mineral fertilizers	–	9 impacts (CML)
Hou	Oilcake: Mass allocation Glycerol: Mass allocation	NER	10 impacts (CML)
Kho	Not taken into account	NER	Climate change (unspecified)
Yan	Not taken into account	–	–

13.5.2 Energy Balance

Because the aim of biofuel production is to provide a substitute for the use of fossil energy, it is important to check that the proposed system manages to create energy and does not use more energy than it produces. Publications use different metrics to evaluate the energy performances of the assessed systems. The *net energy ratio* (NER), defined as the ratio of produced energy/consumed energy, totals energy consumption as seen at the facility gate. This means that the consumption of 1 MJ of electricity will be accounted for as 1 MJ of invested energy. Other studies measure energy consumption in terms of *cumulated energy ratio* (CER); in that case the price of using 1 MJ of electricity will depend on how it has been produced and will measure the total quantity of primary energy used to create the MJ of electricity. Both approaches have their own interest; a NER will focus on the system technology, whereas a CER will also include the effect of the technological environment of the production system. None of the approaches considers the fraction of storable energy (which could have been directly used for transportation) mobilized by the process. Table 13.8 summarizes the environmental and energy assessment methods.

13.5.3 Environmental Impacts

Most of the studies include impact assessments in their results. Only Yang et al. (2011) limit their publication to the inventory step, and Jorquera et al. (2010) only assess the energy balance. All the other publications assess the potential reduction of greenhouse gas emissions in addition to the energy balance. However, only three studies estimate other environmental impacts, as defined by the LCA ISO norm: abiotic depletion, potential acidification, eutrophication, ozone depletion, human toxicity, marine toxicity, photochemical oxidation, ionizing radiation, land use, freshwater toxicity, and terrestrial toxicity. In most of the studies, climate change is assessed with the characterization factors given by the IPCC (IPCC, 2006) for a temporal horizon of 100 years. Brentner et al. (2011) and Campbell et al. (2011) use different characterization factors, and Khoo et al. (2011) do not present the used methodology to assess climate change. Table 13.9 illustrates the divergence of characterization factors among the different methods.

As explained in the previous sections, perimeters, modeling assumptions, and impact assessment methods can differ significantly among the publications. This results in a large

TABLE 13.9 Climate Change Characterization Factors of the three Main Greenhouse Gases.

Gas	GWP-100 (g-eq CO ₂ g ⁻¹)		
	IPCC	TRACI	Kyoto Protocol
CO ₂	1	1	1
CH ₄	25	23	21
N ₂ O	298	296	310

TABLE 13.10 Greenhouse Gas Balance of Production and Use of Algal Bioenergy.

Ref	CO ₂ (g CO ₂ eq/MJ)	Output
Kad	0.061	Electricity
Lar	59.9	Biodiesel
Bal	18.5	Biodiesel
Bat	-75.3 ^a -1.31 ^b	Biodiesel
Clal0	56.8	Biomass
San	-18.0	Biodiesel
Ste	13.6	Biodiesel
Bre	534 ^c 80.5 ^d	Biodiesel
Cam	-0.729	Biodiesel
Clal1	48.7 ^e	Electricity ^e
Col	61.02	Methane biofuel
Hou	15.0*	Biodiesel
Kho	310*	Biodiesel

^a Combustion is not taken into account.

^b Combustion is taken into account.

^c Base configuration.

^d Best configuration.

^e Scenario 4D (direct combustion of algal biomass for bioelectricity production).

* Extrapolations of figure data.

variability of the results related to the global-warming potential (GWP) and the energy return on investment (EROI) and hampers the capacity to compare results. However, we gathered results for these two indicators within the selected studies. Table 13.10 presents the GWP of the various publications, and Figure 13.5 illustrates the relationship between EROI and GWP. Coproduct management has an important influence on the climate-change results. In some studies, climate change impact is negative, which means that the considered system fixes more greenhouse gases than it emits. In [Batan et al. \(2010\)](#), the negative score is due to the substitution of algal oilcakes to soybean oilcakes used to feed livestock. In [Sander and Murthy \(2010\)](#), it corresponds to the substitution of algal oilcakes to maize for the production of bioethanol. Finally, in [Campbell et al. \(2011\)](#), it corresponds to the electricity production from biogas produced by anaerobic digestion of the algal oilcakes.

When only the NER is considered to determine the EROI, favorable values are determined by most of the studies. However, when CER is taken into account, the EROI is limited (1.8 for the best case, 0.96 for the less favorable). It can also be observed that poor EROI (between 0 and 1) corresponds to high GWP.

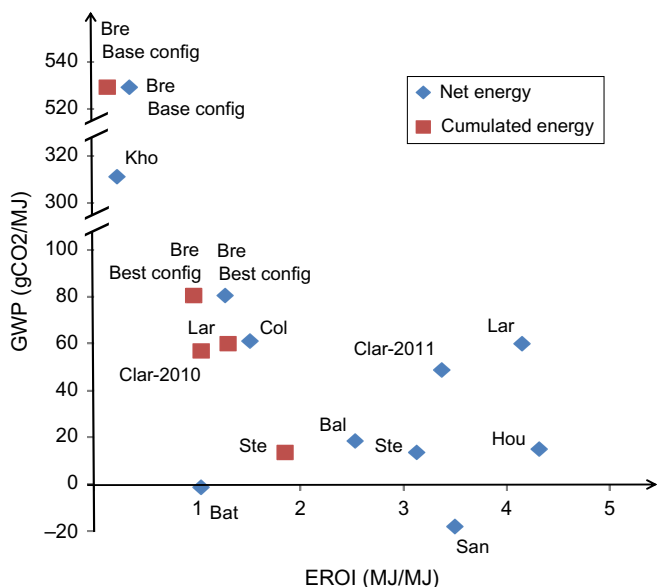

FIGURE 13.5 GWP versus EROI for 1 MJ of biomass and/or biofuel. EROI is expressed in NER (diamond) and CER (square).

13.6 DISCUSSION AND GUIDELINES

13.6.1 Perimeter and Functional Units

The lack of inclusion of biofuel combustion from the perimeter of the study can facilitate the comparison between different technologies or energy production pathways, but it hampers the assessment of the real carbon balance; indeed, some of the carbon atoms of the methylester stem from methanol, which is usually produced from fossil fuel (Stephenson et al., 2010). Moreover, it ignores environmental impacts from combustion (such as photochemical oxidation and particulate matter formation). Finally, all engines do not have the same efficiency, and hence a fair comparison should be based on the available work produced by the use of the fuel rather than on the chemical property of the fuel only.

To harmonize LCA results and provide a better basis for comparisons, the energy content of intermediate products (raw algae, oil, oil extraction residues, and methylester) should be systematically provided and justified. We also recommend using the LHV instead of the HHV; indeed, in most cases, biofuel will be used in engines (internal combustion engines or turbines) that are unable to use the energy stored in the water vapor resulting from fuel combustion.

As shown in the preceding section, the choice of using allocation or substitution to handle the multifunctionality of processes has a strong influence on the results. Even though the system expansion is *a priori* preferable, it can lead to an increase in the overall uncertainty when performance of substituted processes are little known (performance of anaerobic digestion of oilcakes) or if the validity of the substitution is questionable (use of oilcake extraction as animal food, for instance).

13.6.2 Inventory

Inventory data of microalgal-based energy production systems are based on models or extrapolation of lab-scale or pilot-scale data. This is a clear source of uncertainty and variability between studies. Consequently, it is important that each new study clearly sources its data and provides detailed inventory data for each process of the production. Hence, a mass and energy balance of each process should be provided, with specific attention to the flow of fossil and biogenic carbon.

13.6.2.1 Input

It is a common practice when performing an LCA of a first- or second-generation biofuel to exclude infrastructures. Indeed, in these systems, it has been shown that their impact was negligible, and the inventory of every element of the infrastructure could be a tedious task. On the contrary, algal biomass production requires the construction of culture facilities, either raceways or photobioreactors. These two options differ from each other by the type of infrastructure they require, and they also differ from a usual crop by the need for a heavy culture infrastructure. As a consequence, LCAs of algae-based systems that exclude the infrastructure do not allow a fair comparison between options for algae culture and between algal-based and terrestrial plant-based biofuels.

13.6.2.2 Culture

As already pointed out, growth rates, biomass composition, C/N ratios, fertilizer requirements, and energy content of the algae are correlated parameters and hence should not be set according to independent assumptions. We advocate for the definition of chemical properties of each biochemical compartment of the algae (e.g., carbohydrates, lipids, membrane) in order to justify the fertilizer budget, the energy content of the raw algae, and the extraction residue. This would hopefully reduce the spread of values for very important parameters such as nutrient requirement, lipid content, or growth rate.

BIOMASS TRANSFORMATION

Experimental studies exploring new technologies to extract energy from algal biomass are often based on lyophilized algae or use solvents that are difficult to use at the industrial scale (e.g., chloroform). For instance, oil extraction performance and oil esterification yields are of primary importance to realize the LCA of algal biodiesel. Yet up to now LCA studies have demonstrated that dry extraction was too expensive in terms of energy, but at the same time there is a lack of reliable data to assess the wet extraction path.

Anaerobic digestion is mostly used to produce bioenergy from the obtained residues after lipid extraction. Energy consumption should be taken into account, and the potential methane production must be more realistically assessed with existing data in order to avoid overestimation of the global energy balance. Operational parameters such as the organic loading rate or the hydraulic retention time should be specified, since they directly influence the energy consumption of the anaerobic process.

MATURE AND EMERGING TECHNOLOGIES

Chosen technologies for the harvesting, processing, and transformation steps are of different levels of maturity among the publications and even within each study. Some are well-known industrial technologies (such as cultivation in open ponds), but others are hazardous extrapolations from lab-scale pilot studies. Used data in the harvest and extraction steps are particularly variable. For instance, solar drying is used in a study (Kadam, 2002), whereas its feasibility at the industrial scale and the absence of alteration of the lipid content of the algae have not been demonstrated (Lardon et al., 2009). Dry-matter content before lipid extraction is also very variable; some authors consider that a percentage of 15–20% is enough (Lardon et al., 2009; Clarens et al., 2011). This is a wet-extraction technology, and the applications at the industrial scale are barely known. To limit the effect of potential unrealistic processes, we recommend studying at least two scenarios, one including mature technologies and another one with emerging processes.

13.6.2.3 Emissions to the Environment

As we have previously underlined, few publications take into account nitrogen emissions to the environment. We advocate for a better consideration of this problem. Because of the important flow of reactive nitrogen (ammonia, nitrate, or urea), the high concentrations of microorganisms in the culture medium, and the occurrence of anoxic conditions during night periods, it is very likely that nitrogen emissions (NH_3 and N_2O) take place at the cultivation system level (Fagerstone et al., 2011). These emissions are harmful to the environment, causing acidification and global warming. N_2O is indeed a greenhouse gas with a GWP much higher than the CO_2 (298 kg-eq CO_2 kg^{-1} at a temporal horizon of 100 years).

Recent publications put the stress on the question (Frank et al., 2012) or proposed emission factors derived from lab-scale measurements (Fagerstone et al., 2011) equal to 0.037 g N_2O kg N^{-1} in ORW. Indirect emissions of N_2O due to the transformation of the volatilized ammoniac and nitrous oxides have been ignored up to now, whereas they can be estimated at 1.6 g N_2O kg N^{-1} (IPCC, 2006).

More experimental data are required to provide trustable emission factors. Single emission factors are not satisfying because the control of some parameters of the system, such as the dissolved oxygen content, the pH, the reactive nitrogen concentration, and the agitation, influence the processes responsible for gas emissions.

13.6.3 Impact Assessment

13.6.3.1 Climate Change and Consideration of Biogenic Carbon

An important point in the assessment of greenhouse gases is the consideration of the fixation of CO_2 during photosynthesis in the cultivation step and the emissions of CO_2 during the combustion step (if this last step is included in the perimeter of the study). In the publications of Batan et al. (2010) and Clarens et al. (2010), the fixed CO_2 is negatively counted in the global balance of the greenhouse gas (respectively, -75.3 g CO_2 eq MJ^{-1} and -69.4 g CO_2 eq MJ^{-1}). But this CO_2 is then emitted to the atmosphere during the combustion step. This emission is considered by Batan et al. (2010) but not by Clarens et al. (2010), so in this last case the production of bioenergy from microalgae is a sink of carbon, and the greenhouse balance

is widely underestimated. In most of the LCA studies, fixation and then emission of biogenic carbon in the atmosphere are considered neutral processes from a “climate-change” point of view. Consequently, most of the authors do not count the fixation of the CO₂ during the cultivation step nor the emission during the combustion step. We recommend dedicating specific attention to this point to guarantee a sound carbon balance.

13.6.3.2 Energy Balance

Energy balance should systematically be realized in order to guarantee the consistency of the proposed system with long-term economic constraints. As pointed out previously, CER and NER can significantly differ by their conclusions. Hence we recommend always providing both values, since the NER focuses on the performance of the algae production and transformation facility and is independent of country-specific constraints such as the energy mix, whereas the CER will exhibit the consequences of using inputs with high energy demand, such as nitrogen fertilizers or electricity. Our experience showed also that the energy balance is sometimes expressed as the ratio of produced energy over consumed energy but at other times as the ratio of consumed energy over produced energy. The first follows a logic of return on investment (ROI); the second follows the logic of impact assessment, where resource consumption and effects on the environment are standardized by the functional unit. This duality is confusing for many readers, and we recommend keeping the logic of the ROI because the energy balance is mainly an economic issue.

13.6.3.3 Other Environmental Impacts

The use of a large variety of impact assessment methodologies can be potentially problematic if one wants to compare LCA studies. For instance, the comparison of the results of the “eutrophication” impact is not possible between the study of [Kadam \(2002\)](#) and the study of [Brentner et al. \(2011\)](#). In the first case, the methodology used is CML and the eutrophication impact is expressed in phosphate equivalent, whereas in the second publication the methodology used is TRACI and the impact is expressed in nitrogen equivalent. Moreover, some studies do not precisely state the impact assessment methodology ([Clarens et al., 2010, 2011](#)).

A comparison of the LCA results of bioenergy production from microalgae with results for fossil fuels and other biofuels should be included. The strengths and weaknesses of this new kind of bioenergy production compared to fossil fuel or classical bioenergy production from biomass must be identified. Assessed impacts should include climate change and an energy balance, but impacts that have reduced the interest in first-generation biofuel (such as land use change occupation or impacts linked with the nitrogen flows or the use of chemical products) and have motivated the abandonment of fossil fuel (ozone layer depletion or abiotic resource depletion) should also be presented. A focus should also be made on the quantity and the quality of required water, since evaporation or water spray to cool the process could lead to drastic water consumption ([Béchet et al., 2010, 2011](#)).

13.7 CONCLUSION

This chapter presents a critical review of 15 publications about LCA and bioenergy production from microalgae. The review illustrated the variability of assumptions made about

technological and environmental performance of the different processes involved in the production and transformation of algal biomass. The main conclusion of this analysis is that there is real difficulty in comparing the environmental burdens of the proposed setups, and there is now a need for clear guidelines to ensure that each new LCA study will consolidate the current knowledge. This is of key importance, since the objective of LCA works will more and more often consist of guiding the design of new biofuel production systems and prove that they lead to actual progress in terms of environmental impact. In this spirit, there is a clear gain for the LCA community to accept a set of rules and guidelines to make any new analysis comparable to the existing ones.

As a consequence, we have proposed some guidelines for the LCA to allow a clearer and sounder comparison between processes and to better estimate the potential and challenges of microalgae for biofuel production.

Acknowledgments

This chapter presents research results supported by the ANR-08-BIOE-011 Symbiose project. Authors P. Collet, A. Hélias, and L. Lardon are members of the Environmental Life Cycle and Sustainability Assessment research group (ELSA; www.elsa-lca.org). They thank all the other members of ELSA for their advice.

References

- Baliga, R., Powers, S.E., 2010. Sustainable Algae Biodiesel Production in Cold Climates. *International Journal of Chemical Engineering* 2010, 1–13.
- Batan, L., Quinn, J., Willson, B., Bradley, T., 2010. Net energy and greenhouse gas emission evaluation of biodiesel derived from microalgae. *Environ. Sci. Technol.* 44, 7975–7980.
- Béchet, Q., Shilton, A., Fringer, O.B., Muñoz, R., Guieysse, B., 2010. Mechanistic modeling of broth temperature in outdoor photobioreactors. *Environ. Sci. Technol.* 44, 2197–2203.
- Béchet, Q., Shilton, A., Park, J.B.K., Craggs, R.J., Guieysse, B., 2011. Universal temperature model for shallow algal ponds provides improved accuracy. *Environ. Sci. Technol.* 45, 3702–3709.
- Börjesson, P., Tufvesson, L.M., 2011. Agricultural crop-based biofuels – resource efficiency and environmental performance including direct land use changes. *Journal of Cleaner Production* 19, 108–120.
- Brentner, L.B., Eckelman, M.J., Zimmerman, J.B., 2011. Combinatorial life cycle assessment to inform process design of industrial production of algal biodiesel. *Environ. Sci. Technol.* 45, 7060–7067.
- Campbell, P.K., Beer, T., Batten, D., 2011. Life cycle assessment of biodiesel production from microalgae in ponds. *Bioresour. Technol.* 102, 50–56.
- Chisti, Y., 2007. Biodiesel from microalgae. *Biotechnol. Adv.* 25, 294–306.
- Clarens, A.F., Resurreccion, E.P., White, M.A., Colosi, L.M., 2010. Environmental life cycle comparison of algae to other bioenergy feedstocks. *Environ. Sci. Technol.* 44, 1813–1819.
- Clarens, A.F., Nassau, H., Resurreccion, E.P., White, M.A., Colosi, L.M., 2011. Environmental impacts of algae-derived biodiesel and bioelectricity for transportation. *Environ. Sci. Technol.* 45, 7554–7560.
- Collet, P., Hélias, A., Lardon, L., Ras, M., Goy, R.A., Steyer, J.P., 2011. Life-cycle assessment of microalgae culture coupled to biogas production. *Bioresour. Technol.* 102, 207–214.
- Del Campo, J.A., García-González, M., Guerrero, M.G., 2007. Outdoor cultivation of microalgae for carotenoid production: current state and perspectives. *Appl. Microbiol. Biotechnol.* 74, 1163–1174.
- Doucha, J., Straka, F., Lívanský, K., 2005. Utilization of flue gas for cultivation of microalgae *Chlorella* sp. in an outdoor open thin-layer photobioreactor. *Journal of Applied Phycology* 17, 403–412.
- European Union, 2009. Directive 2009/28/EC of the European Parliament and of the Council of 23 April 2009 on the promotion of the use of energy from renewable sources and amending and subsequently repealing Directives 2001/77/EC and 2003/30/EC.

- Fagerstone, K.D., Quinn, J.C., Bradley, T.H., De Long, S.K., Marchese, A.J., 2011. Quantitative measurement of direct nitrous oxide emissions from microalgae cultivation. *Environ. Sci. Technol.* 45, 9449–9456.
- Falkowski, P.G., Raven, J.A., 1997. *Freshwater Biology in Aquatic Photosynthesis*. Blackwell, Oxford, USA.
- Frank, E.D., Han, J., Palou-Rivera, I., Elgowainy, A., Wang, M.Q., 2012. Methane and nitrous oxide emissions affect the life-cycle analysis of algal biofuels. *Environmental Research Letters* 7, 014030.
- Geider, R., La Roche, J., 2002. Redfield revisited: variability of C: N: P in marine microalgae and its biochemical basis. *Eur. J. Phycol.* 37 (1), 1–17.
- Goedkoop, M.J., Heijungs, R., Huijbregts, M., De Schryver, A., Struijs, J., Van Zelm, R., ReCiPe, 2008. A life cycle impact assessment method which comprises harmonised category indicators at the midpoint and the endpoint level; First edition Report I: Characterisation; 6 January 2009. Retrieved from <http://www.lcia-recipe.net>.
- Hou, J., Zhang, P., Yuan, X., Zheng, Y., 2011. Life cycle assessment of biodiesel from soybean, jatropha and microalgae in China conditions. *Renew. Sustain. Energ. Rev.* 15 (9), 5081–5091.
- Huntley, M.E., Redalje, D.G., 2007. CO₂ mitigation and renewable oil from photosynthetic microbes: a new appraisal. *Mitigat. Adapt. Strat. GL* 12 (4), 573–608.
- IPCC, 2006. 2006 IPCC Guidelines for National Greenhouse Gas Inventories. Prepared by the National Greenhouse Gas Inventories Programme, Eggleston, H.S., Buendia, L., Miwa, K., Ngara, T., Tanabe, K. (Eds.). IGES, Kanagawa, Japan.
- Jorquera, O., Kiperstok, A., Sales, E.A., Embiruçu, M., Ghirardi, M.L., 2010. Comparative energy life-cycle analyses of microalgal biomass production in open ponds and photobioreactors. *Bioresour. Technol.* 101, 1406–1413.
- Kadam, K., 2002. Environmental implications of power generation via coal-microalgae cofiring. *Energy* 27, 905–922.
- Ketchum, B.H., Redfield, A.C., 1949. Some physical and chemical characteristics of algae growth in mass culture. *J. Cell. Comp. Physiol.* 33, 281–299.
- Khoo, H.H., Sharratt, P.N., Das, P., Balasubramanian, R.K., Naraharisetti, P.K., Shaik, S., 2011. Life cycle energy and CO₂ analysis of microalgae-to-biodiesel: preliminary results and comparisons. *Bioresour. Technol.* 102, 5800–5807.
- Lacour, T., Sciandra, A., Talec, A., Mayzaud, P., Bernard, O., 2012. Neutral lipid and carbohydrate productivities as a response to nitrogen status in *Isochrysis* Sp. (T-Iso; Haptophyceae): Starvation versus limitation I. *J. Phycol.* 48 (3), 647–656.
- Lardon, L., Hélias, A., Sialve, B., Steyer, J.P., Bernard, O., 2009. Life-Cycle Assessment of Biodiesel Production from Microalgae. *Environ. Sci. Technol.* 43, 6475–6481.
- Molina Grima, E., Belarbi, E.H., Ación Fernández, F.G., Robles Medina, A., Chisti, Y., 2003. Recovery of microalgal biomass and metabolites: process options and economics. *Biotechnol. Adv.* 20, 491–515.
- Sander, K., Murthy, G.S., 2010. Life cycle analysis of algae biodiesel. *International Journal of Life Cycle Assessment* 15, 704–714.
- Searchinger, T., Heimlich, R., Houghton, R.A., Dong, F., Elobeid, A., Fabiosa, J., et al., 2008. Use of U.S. croplands for biofuels increases greenhouse gases through emissions from land-use change. *Science* 319, 1238–1240.
- Shimamatsu, H., 2004. Mass production of *Spirulina*, an edible microalga. *Hydrobiologia* 512, 39–44.
- Sialve, B., Bernet, N., Bernard, O., 2009. Anaerobic digestion of microalgae as a necessary step to make microalgal biodiesel sustainable. *Biotechnol. Adv.* 27, 409–416.
- Stephenson, A.L., Kazamia, E., Dennis, J.S., Howe, C.J., Scott, S.A., Smith, A.G., 2010. Life-Cycle Assessment of Potential Algal Biodiesel Production in the United Kingdom: A Comparison of Raceways and Air-Lift Tubular Bioreactors. *Energy & Fuels* 24, 4062–4077.
- Udo de Haes, H., Sleswijk, A.W., Heijungs, R., 2006. Similarities, Differences and Synergisms Between HERA and LCA—An Analysis at Three Levels. *Human and Ecological Risk Assessment: An International Journal* 12, 431–449.
- Yang, J., Xu, M., Zhang, X., Hu, Q., Sommerfeld, M., Chen, Y., 2011. Life-cycle analysis on biodiesel production from microalgae: water footprint and nutrients balance. *Bioresour. Technol.* 102, 159–165.
- Yoo, C., Jun, S.Y., Lee, J.Y., Ahn, C.Y., Oh, H.M., 2010. Selection of microalgae for lipid production under high levels carbon dioxide. *Bioresour. Technol.* 101 (Suppl.), S71–S74.

Economics of Microalgae Biomass Production

F.G. Acién, J.M. Fernández, E. Molina-Grima

Department of Chemical Engineering, University of Almería, Almería, Spain

14.1 INTRODUCTION

Microalgae have been proposed as the potential source for a wide range of products, ranging from fine chemicals and pharmaceuticals to nutraceuticals and additives, foods, and feeds and as a biofuel source as well as playing a role in wastewater treatment (Borowitzka, 1999; Richmond, 2000). However, of all these products and roles, only a few are performed on an industrial scale. Microalgae are produced as a source of certain carotenoids, such as β -carotene and astaxanthin; microalgae biomass is also produced as food in nutraceutical applications and as feed for aquaculture. The amount of microalgae produced worldwide for these markets is around 5 kt/year. The price of microalgae biomass ranges from €10–300/kg, and the size of these markets is from 10–50 kt/year (Pulz and Gross, 2004). The development of new applications for microalgae biomass can increase the present production capacity. Thus, large-scale markets such as energy or commodities have the potential to absorb enormous amounts of microalgae biomass—up to 10^4 kt/year—but the price of biomass in these markets is far lower, from €0.01–0.50/kg. For this reason, microalgae biomass production costs must likewise be reduced to comply with these markets (Chisti, 2007).

Even though biomass production is normally performed under continuous operation in order to maximize the system yield, some products can be produced by varying operation modes from discontinuous to continuous-discontinuous combinations, as is the case with astaxanthin. Whatever the final use of the microalgae biomass and whichever production mode is used, the steps required to produce it are the same. The culture medium has to be prepared and introduced into the photobioreactors, where the biomass is produced, then it has to be harvested and stabilized. Alternatively, it can be processed to create products according to adequate downstream schemes (see Figure 14.1). Each one of these steps requires

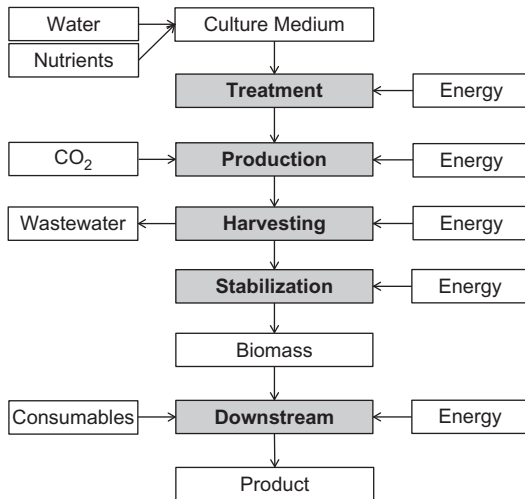

FIGURE 14.1 General scheme of microalgae biomass production systems. Major inputs are nutrients, water, and CO₂ in addition to energy. Processes can be built to produce stabilized biomass or final products according to an adequate downstream process.

materials and energy input. In addition, waste released in each step has to be treated. Different possibilities exist for each of the necessary steps, the overall yield and cost of the finished product being a function of the final scheme used. For example, a culture medium might be prepared using fine chemicals, fertilizers, or wastes—the resultant costs using wastes being less but the final biomass quality produced significantly diminished.

In this chapter, the cost of producing microalgae biomass is reviewed for various applications using various schemes. Analysis is performed based on (1) the product obtained, (2) the overall scheme of the process, and (3) the production capacity. In each case, the major factors determining total production costs are identified and strategies are discussed to reduce those costs.

14.2 METHODOLOGY FOR COST ANALYSIS OF MICROALGAE PRODUCTION

To assess the microalgae biomass production cost of any process, it is necessary to know the complete process flowchart in detail, including a list of equipment and equipment size in addition to raw material uptake and energy consumption (Kalk and Langlykke, 1986).

Figure 14.2 summarizes the steps necessary to define the major contributions to production cost: (1) depreciation, (2) raw materials and utilities, and (3) labor and supervision. The total production cost is calculated as the sum of depreciation plus direct production costs (raw materials and utilities, along with labor and supervision). From the block diagram of the process (the conceptual approach), a detailed process flowchart can be defined based on production capacity and kinetic parameters of the different unit operations performed. The flowchart allows us to know the type and size of equipment necessary as well as the mass and energy

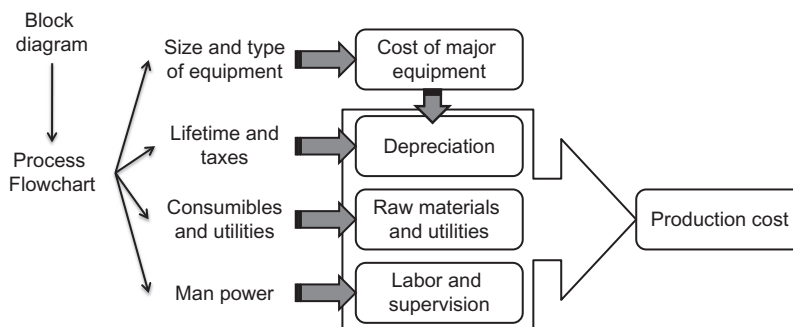

FIGURE 14.2 Steps necessary to perform a cost analysis for a microalgae production process.

balances on the entire process. The cost of major equipment can be obtained from the suppliers or, alternatively, from bibliographic references or databases. From this information, the total fixed capital is calculated, multiplying by the corresponding Lang factors according to the nature of the item. The value of these factors is available for a wide variety of processes, values for microalgae-based processes being previously verified (Acién et al., 2012a). The depreciation includes not only amortization of the fixed capital, which is a function of the estimated lifetime, but also the property tax, insurance, and purchase tax.

The direct production cost includes raw materials, utilities, labor, and others (supervision, maintenance, tax, contingencies, etc.). The amount of raw materials required is calculated from mass balances according to the specified flowchart, whereas the consumption of utilities is calculated from the power and water use of the process. The cost of raw materials has to include transport to the facility and the market values obtained from suppliers. With regard to power, the cost of electricity can vary according to consumption and energy required; therefore, a detailed analysis of different suppliers is recommended.

Water is an important utility for microalgae production; thus its cost needs to be accurately determined. Water cost is a function of its quality (seawater, brackish water, freshwater, wastewater) and uptake volume. Moreover, in this section the cost of wastewater treatment of effluents from the facility has to be included. Whatever the quality of water used, the cost of pumping the water into and out of the facility has to be included in the power consumption item, separate from the power required to operate the facility, which is mainly related to water recirculation in the photobioreactors.

Labor consists of the workers necessary to correctly operate the process and the general costs of supervision and management, in addition to maintenance, taxes, and contingencies. To determine the direct production cost, it is necessary to know the cost of the raw materials, power, water, and labor, whereas the other costs are calculated by previously defined factors. The labor cost varies widely as a function of personnel qualification levels and facility location. Supervision and other costs are calculated based on the number of personnel directly involved in the operation of the facility and their salaries. Therefore, by reducing the number or salary levels of direct personnel, the labor and supervision cost greatly reduces.

Following this methodology, it is possible to ascertain the production cost of microalgae biomass for any facility. Moreover, the production cost at any other scale can also be approximated simply by modifying the cost of major equipment according to the scale chosen and

then multiplying the direct cost by the adequate factor in order to increase the production capacity. The process or equipment cost can be scaled up or down from a basic size using an exponential law for which a value of 0.85 is considered appropriate. This equation is not valid for large-scale changes because a certain technology can be feasible at one scale but might not be available on a larger scale. Thus, a maximum scale-up factor of 10 is considered acceptable without revising the technology. Whenever larger requirements are needed, the scale-up has to be solved by multiplying the number of units.

$$\text{Cost}B = \text{Cost}A \left(\frac{\text{Size}B}{\text{Size}A} \right)^{0.85} \quad (14.1)$$

14.3 CASE STUDY

14.3.1 Production of High-Value Carotenoids

Carotenoids such as astaxanthin and beta-carotene are examples of high-value products obtained from microalgae. Astaxanthin is a carotenoid that is naturally synthesized in some plants and bacteria but especially in the microalga *Haematococcus pluvialis*. It is widely used in aquaculture for salmon and trout farming as well as in dietary supplements (Guerin et al., 2003; Higuera-Ciapara et al., 2006).

Astaxanthin can be produced synthetically at a cost of \$1,000/kg, its market size being more than \$200 million per year, with the market price above \$2,000/kg (Olaizola, 2003). However, because synthetic astaxanthin is derived from petrochemicals, its use is only permitted in aquaculture. It is not allowed for human consumption nor in animal feed other than in aquaculture applications, so for these other uses natural astaxanthin production is required (Li et al., 2011).

Astaxanthin is produced from *Haematococcus pluvialis* using a two-step strategy. First, green vegetative cells are produced under optimal growth conditions; they are then put under stress to trigger the accumulation of astaxanthin (Guerin et al., 2003; Olaizola, 2003). Because *Haematococcus pluvialis* is easily contaminated with other fast-growing strains such as *Scenedesmus* or *Chlorella*, the production is ideally performed in discontinuous mode. To enhance the process yield, repeated batches or semicontinuous cultures can be used to produce green vegetative cells, but this has always to be carried out using closed photobioreactors to avoid contamination problems. The second step is performed for a short time, 5–10 days, under nutrient deprivation conditions and high irradiance, so this step is usually carried out in cheaper open photobioreactors. Although a one-step production technique has been reported at the pilot scale, no commercial production using this methodology exists (Del Río et al., 2008; García-Malea et al., 2009).

One of most extensive cost analyses carried out on astaxanthin production from *Haematococcus pluvialis* has recently been published (Li et al., 2011). Cost analysis data were obtained from the operation of a pilot-scale facility consisting of an 8,000 L airlift tubular photobioreactor and a 100 m² raceway photobioreactor located in Shenzhen, China. Biomass is harvested by sedimentation and centrifugation, and then it is stabilized in a dryer, then additionally disrupted by pulverization (see Figure 14.3). The production capacity of the pilot

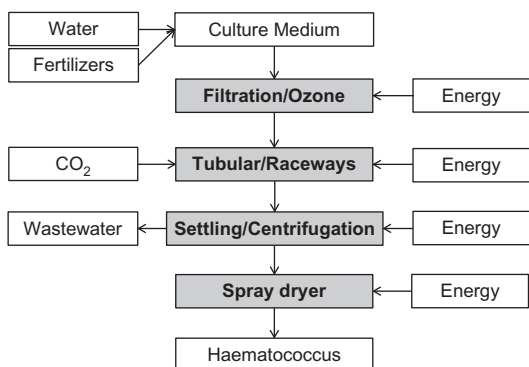

FIGURE 14.3 Block diagram of the process for the production of astaxanthin from *Haematococcus*. (Adapted from Li et al., 2011.)

plant is estimated at 140 kg/year of dry *Haematococcus pluvialis* biomass with 2.5% astaxanthin content: meaning an astaxanthin production capacity of 3.5 kg/year. From these data, the authors extrapolate the production cost of a projected facility, located at a different location under better environmental conditions, producing 900 kg/year of astaxanthin (36 t/year of biomass); that is, a 260 times greater production capacity than demonstrated. Scale-up is performed by multiplying the number of units equal to that used on the pilot scale; thus a total of 30 airlift tubular photobioreactors and 200 raceway photobioreactors were considered. From this analysis the total fixed capital required to build up the facility is close to \$1.5 million, the direct production cost including manpower being close to \$0.5 million/year. Thus, the expected biomass production cost is \$14/kg and \$718/kg for biomass and astaxanthin, respectively. These costs are much lower than usually reported for this process (which range from \$2,000–3,000/kg); the authors attributing this fact to the low cost of the photobioreactors used and of manpower in China. Thus, if the same production facility were located in the United States, labor would cost approximately \$600/kg of astaxanthin, compared to only \$120/kg of astaxanthin in China.

Data from Li et al. (Li et al., 2011) demonstrated that to produce high-value biomass, the complexity of the process is greater and the use of reactors with adequate control systems is mandatory. In this case, depreciation represents more than 23% of the total production cost, although major costs relate to utilities (33%) and labor (30%) (see Figure 14.4). The utility cost is mainly a result of the facility's high power consumption, whereby temperature is controlled by cooling the culture volume in tubular photobioreactors; the cost of water is not relevant. Raw material cost is principally due to fertilizer use, representing up to 54% of raw material cost, in addition to pure CO₂, which represents up to 39%. The depreciation cost is mainly a function of tubular photobioreactor and raceway pond costs, representing 25% and 16% of total fixed capital, respectively. Machinery cost related to harvesting is low because *Haematococcus pluvialis* is easily separated from the supernatant by sedimentation.

From these data, it is clearly shown that a reduction in power consumption is a major factor in reducing the production cost of this facility. Consequently, one third of power consumption comes from the cooling of the tubular photobioreactors, one third is related to raceway power consumption, and the rest is consumed in gas supply and harvesting (including drying). Any reduction in cooling requirements or improvements in raceway reactor fluid dynamics can help significantly improve the economic viability of the system. Regarding

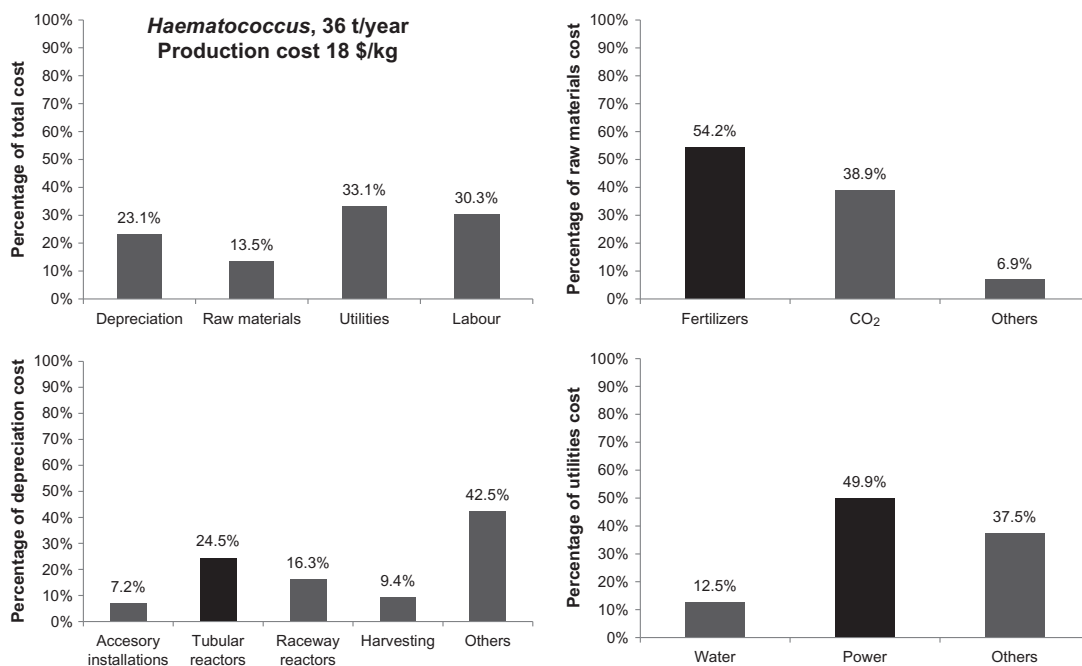

FIGURE 14.4 Analysis of production costs related to the production of *Haematococcus pluvialis* using tubular and raceway reactors scaled up to 36 t/year. (Adapted from Li et al., 2011.)

raw materials, the fertilizer cost cannot be reduced, so the only possibility is to reduce their consumption. Finally, with regard to the depreciation cost, it is possible to reduce the cost of tubular photobioreactors by increasing their size instead of installing multiply units. The precise total production cost obtained using these improvements can be evaluated only if their viability is previously demonstrated not to influence the overall process yield, but it can reach up to 30% of total production.

14.3.2 Production of High-Value Biomass Using Closed Photobioreactors

Certain strains of microalgae biomass are accepted as functional food for human and animals. This is because they contain active compounds such as omega-3 fatty acids (eicosapentanoic acid-EPA, decosahexaenoic acid-DHA), chlorophylls, carotenoids, phycobiliproteins, and the like. Although the production of strains containing these compounds can be performed in open reactors, it is preferable to carry out the process in closed photobioreactors to ensure good manufacturing practices, as imposed by the food and pharmaceutical industry.

Marine strains such as *Pavlova viridis* (Hu et al., 2008), *Nannochloropsis* sp. (Chini Zittelli et al., 1999) and *Phaeodactylum tricornutum* (Ación et al., 2000) have proven useful for the outdoor production of omega-3 fatty acid-rich biomass in closed photobioreactors. However, its production cost is higher than omega-3 produced heterotrophically or obtained from fish oil.

For this reason, a cost-effective system based on autotrophic growth is not yet available. Concerning freshwater strains, *Chlorella* biomass is accepted for human consumption and is produced by more than 70 companies. The Taiwan Chlorella Manufacturing Co. Ltd. (Taipei, Taiwan) is the largest producer, with 400 t/year, although there is also significant production in Klötze, Germany, with 130 t/year using tubular photobioreactors. Annual world sales of *Chlorella* are in excess of \$38,000 million (Spolaore et al., 2006).

Chlorella biomass has related health benefits, such as being an active immunostimulator and reducer of blood lipids, among other things, in addition to its taste, flavor, and coloring properties. There is also a demand for microalgae biomass production of monoalgal strains by the feed market. Thus, microalgae can be incorporated into fish, pet, and farm animal feed. In 1999, the production of microalgae for aquaculture reached 1,000 t/year (62% for molluscs, 21% for shrimps, and 16% for fish) (Spolaore et al., 2006). The importance of algae in this domain is not surprising, given that microalgae are the natural food source for these animals. The main microalgae applications in aquaculture are associated with nutrition, either being used fresh (as the sole component or as a basic nutrient food additive) or for coloring the flesh of salmonids and for inducing other biological activities.

The production cost of monoalgal microalgae biomass in closed photobioreactors has recently been analyzed (Ación et al., 2012a) (see Figure 14.5); a pilot-scale facility of 0.04 Ha consisting of 10 tubular photobioreactors, each one 3 m³, operated in continuous mode at an average dilution rate of 0.34 L/day year round. Fertilizers are used to prepare the culture medium, which is filtered and ozonized to sterilize it. The strain *Scenedesmus almeriensis* is cultivated under controlled pH (by injecting pure CO₂) and temperature excess is avoided by passing cool water from heat exchangers located inside the reactors. *S. almeriensis* has proven to be a source of lutein, with an average percentage of this carotenoid in the biomass of 1% (dw) all through the year (Sánchez et al., 2008).

Biomass productivity throughout the year ranges from 0.3 to 0.7 g/L. The biomass is harvested and concentrated by centrifugation daily in continuous mode, then is freeze-dried to obtain dry biomass; a production capacity of 3.8 t/year has been reported. Analysis of the facility's production cost shows depreciation (42.6%) and labor (51.6%) as being the main factors contributing to the final biomass cost of up to \$89/kg (see Figure 14.6). As expected for the production of microalgae biomass using closed photobioreactors for the production step, in addition to centrifugation for harvesting and freeze drying for stabilization, these are the

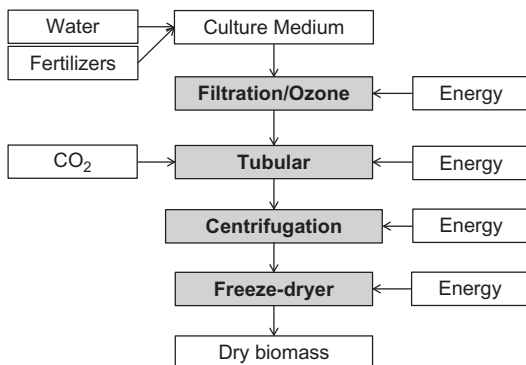

FIGURE 14.5 Block diagram of the process for the production of *Scenedesmus almeriensis* dry biomass in tubular photobioreactors. (Adapted from Ación et al., 2012a.)

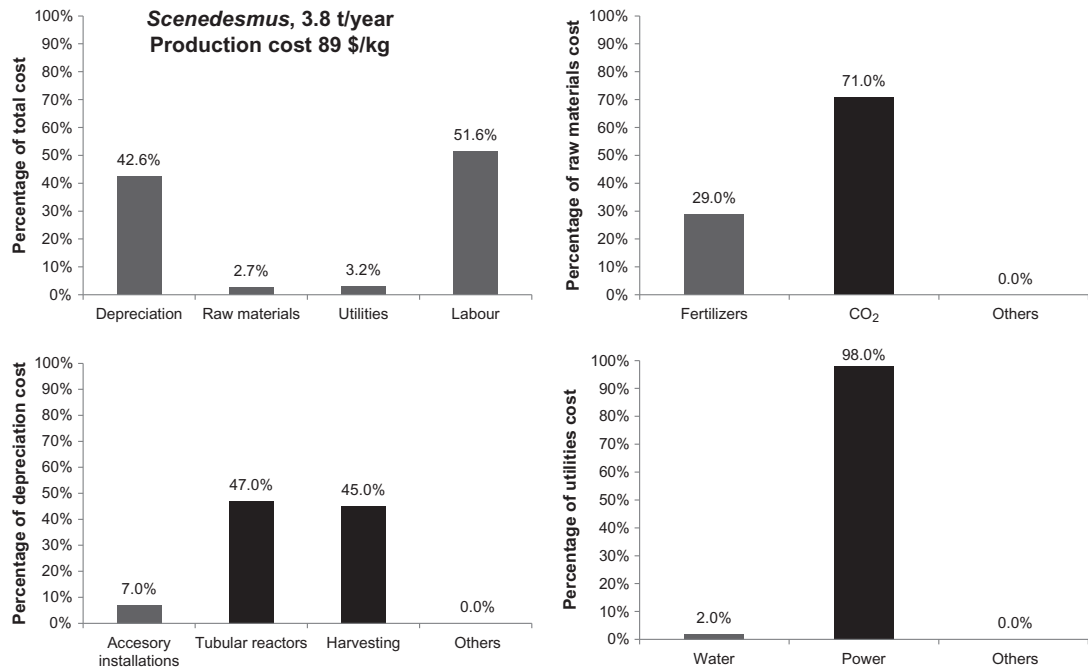

FIGURE 14.6 Analysis of production costs related to the production of *Scenedesmus almerienseis* using tubular reactors scaled up to 3.8 t/year. (Adapted from Acién et al., 2012a.)

major contributions to the depreciation cost. Closed photobioreactors make up 47% of the depreciation cost, whereas harvesting represents 45%. Although raw material and utility costs are much lower than depreciation and labor costs, the contributions of CO₂ and power costs are highly relevant. The cost of CO₂ represents 71% of raw material cost, whereas power represents 98% of the utility cost. These reported data have been obtained and verified over two years of operation, making their robustness higher than other cost analyses performed using laboratory data.

From these results it can be concluded that, to reduce the production cost, it is necessary to reduce labor by implementing extensive automation in addition to reducing the depreciation cost by simplifying the equipment used and increasing production capacity. Indeed, by increasing the production capacity up to 200 t/year, by adequate scale-up of the process, by reducing manpower to 1 person/ha, and by avoiding the use of expensive equipment such as freeze dryers and sterilization units, the production cost can be reduced to \$16/kg versus \$89/kg at small scale (Acién et al., 2012a). This reduction to less than 20% of the initial value demonstrates that the production capacity increase has a great effect on the reduction of the production cost. Therefore, the obtained value is similar to that reported (Norsker et al., 2010), indicating a production cost of \$5.4/kg when producing microalgae biomass in tubular photobioreactors at scales up to 100 ha.

It has also been reported that the production cost in tubular photobioreactors is lower than that obtained using flat panels or open raceways. This is due to the lower productivity and

higher harvesting costs in these reactors compared to tubular photobioreactors (Posten, 2009), production costs being as high as \$6.4/kg and \$7.7/kg when using flat panels and open raceways, respectively (Norsker et al., 2010). These studies demonstrate that biomass productivity is a key factor determining the total production cost, in addition to the unitary cost of the reactor and unitary harvesting cost. Moreover, production costs can be lower using tubular photobioreactors instead of open raceways in spite of lower costs for the latter; this is because of the higher productivity achieved in tubular photobioreactors and lower volume to be processed in the harvesting step.

14.3.3 Production of Low-Value Biomass for Biofuels

The idea of producing biofuels from microalgae comes from the 1960s (Oswald and Golueke, 1960); now, given the high price of petroleum and the global-warming problem, attention has refocused on this idea. Microalgae have several advantages over crops in the production of biofuels: They have high productivity and do not compete for fertile land or water, thus do not affect the food supply nor other crop products. Microalgae have been proposed as the unique third-generation biofuel source (Chisti, 2007). However, for this to become a reality, the production of microalgae still has to demonstrate its sustainability, in addition of being produced on a large scale and at a comparably low price, as with traditional crops like soya, corn, or palm. As an example, palm oil is produced at a volume of 40 million t/year and has a market value of €0.5/kg. To replace only 5% of the U.S. demand for transport fuel, it would be necessary to produce more than 66,000 kt/year of oil-rich biomass at production costs below \$400/t (Chisti, 2007). Moreover, to replace all transport fuels in Europe with biodiesel from microalgae, 9.25 million ha (almost the surface area of Portugal) would be needed, assuming a productivity of 40,000 L/ha year (Wijffels and Barbosa, 2010).

To produce microalgae-based biofuels that are able to compete in the worldwide energy markets, it is essential to minimize the energy and nutrient input along with their cost, in addition to optimizing the culture yield and developing adequate transformation routes that allow the valorization of the entire biomass according to the biorefinery concept (see Figure 14.7). For the production of biomass, the use of wastewater is required as the nutrient (nitrogen and phosphorous) source, in addition to free CO₂ from flue gases as the carbon source, resulting in purified water and profits obtained from the wastewater treatment process (Jorquera et al., 2010; Norsker et al., 2010; Ación et al., 2012a). With regard to valorization, the microalgae biomass produced under high-productivity conditions is composed of

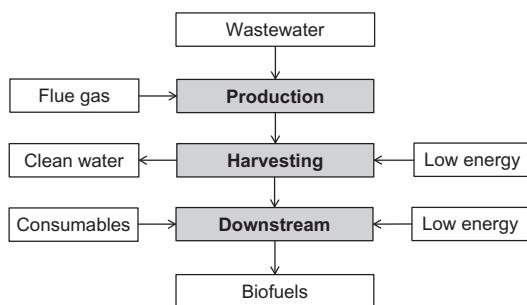

FIGURE 14.7 Block diagram of the process for the production of biofuels from microalgae using wastewater and flue gases.

proteins (30–50%), carbohydrates (20–30%), lipids (10–30%), and ash (5–10%) (Vargas et al., 1998; Chisti, 2007). Biodiesel can be obtained from the saponifiable lipids (approximately 50% of total lipids), whereas bioethanol can be produced from fermentable sugars (approximately 30% of total carbohydrates); thus a mere 20–30% of the biomass would be used if only biodiesel and bioethanol production were carried out. The remaining biomass waste has been suggested as useful in biogas production; however, the economic value of biogas is low due to its low calorific value, CO₂ content, and gas nature.

Other than this, biofuel production by hydrothermal liquefaction of the entire biomass has been likewise proposed (Biller and Ross, 2012). In a general scheme, the microalgae could be used to produce biodiesel by extraction/transesterification processes, and waste biomass could be fermented anaerobically to produce biogas, which in the end could be used as both energy and as a CO₂ source. Alternatively, amino acids (Romero et al., 2012) and/or bioethanol could be produced from microalgae biomass (John et al., 2011). The biodiesel production capacity of microalgae is assumed to be up to 35,000 L/ha/year (Rodolfi et al., 2009), whereas the production of bioethanol can reach values up to 38,000 L/ha/year (Harun et al., 2010), although these values have not yet been demonstrated on an industrial scale.

Whatever the transformation route to produce biofuels from microalgae biomass, it is clear that the production step has to be positive in terms of energy balance, in addition to being cheap—a value of \$0.5/kg being widely agreed as the upper limit. Recently, several economic analysis approximations of biofuel production from microalgae have been published (Douskova et al., 2009; Norsker et al., 2010; Singh and Gu, 2010; Wijffels et al., 2010; Williams and Laurens, 2010). Due to the lack of both existing facilities and a defined technology, only approximations can be made, all of which include significant uncertainty. Microalgae biomass production costs for different scenarios have recently been analyzed (Ación et al., 2012b). The base scenario considered is the operation of a 100-ha facility consisting of raceway reactors with a V/S ratio depth of 0.2 m³/m², operated in continuous mode at 0.2 L/day. The power consumption dedicated to mixing is 2 W/m³, while an energy consumption of 0.1 kWh/m³ is assumed for harvesting using a flocculation–sedimentation step, followed by centrifugation. The use of pure raw materials (CO₂ and fertilizers) is considered, a biomass productivity of 20 g/m² day being assumed for the year overall. From these data a production cost of \$1.12/kg is reached, a major percentage corresponding to raw material cost due to the use of pure CO₂ and fertilizers but especially due to the cost of using pure CO₂ (see Figure 14.8).

The second major contribution to overall production is depreciation, especially the cost of harvesting equipment, meaning the sedimenter and centrifugation units, amounting to 59.8% of the total equipment cost. Regarding the utility cost, this mainly corresponds to the power consumption for both operating the photobioreactors and harvesting, water cost being negligible in spite of water evaporation losses of 30,000 m³/ha year. From these data, it is concluded that to reduce the biomass production cost and approach the target value of \$0.5/kg, it is mandatory to improve CO₂ use efficiency or even to replace it using flue gases. Moreover, clean water can be replaced by wastewater, thus avoiding the use of fertilizers. Under these conditions, the production cost reduces to \$0.55/kg, which approaches the target value of \$0.50/kg.

Considering similar conditions (free flue gases and wastewater), production costs of \$0.70/kg have been reported using closed photobioreactors, whereas this value increased up to \$1.3/kg

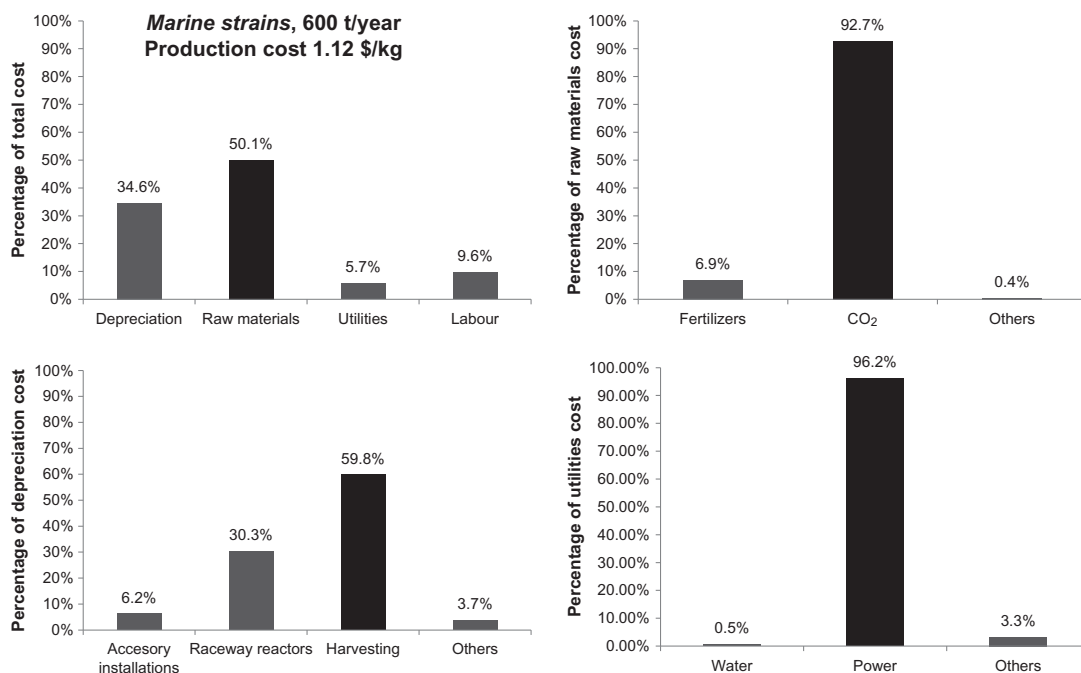

FIGURE 14.8 Analysis of production costs related to the production of microalgae biomass using open raceways scaled up to 600 t/year. (Adapted from Acien et al., 2012a.)

when using open raceways due to their lower productivity (Norsker et al., 2010). To reduce the production cost below this value, it is necessary to improve the productivity of the system to approximate the maximum theoretical values, which have only been demonstrated under fully controlled conditions at a low scale. Therefore, increasing productivity to 40 g/m² day, the production cost reduces to \$0.21/kg, and considering a maximal productivity of 60 g/m² day under optimal location and operating conditions, the production cost could be reduced as far as \$0.14/kg (Acien et al., 2012a). Recently it has been reported that to be competitive with petroleum at \$100/barrel, the biomass with a 40% oil content will need to be produced at \$0.16/kg if no credit is allowed for the residual biomass, or at \$0.25/kg if a credit is allowed for the nutrients in the residual biomass (Chisti, 2012).

To break the bottleneck for microalgae production used in energy production, it is essential to develop more productive photobioreactor systems while reducing their cost dramatically. The productivity of open raceways varies widely according to the location, strain, and operating conditions; long-term productivity in commercial raceways is lower than 47 t/ha year, although values of up to 91 t/ha year (Borowitzka, 1999) have been reported. Design and operation optimization for open raceways in order to improve their efficiency and productivity is currently performed starting from the basics: fluid dynamics and mass transfer characterizations (Mendoza et al., 2012; Sompech et al., 2012; Chiaramonti et al., 2013). Regarding the photobioreactor cost, it has been reported that to guarantee an economical production design for energy products, the investment costs cannot exceed €40/m²

(Hankamer et al., 2007). The cost of open raceways is in the \$13/m² range, which includes the compacted earth, lining, baffles, and paddlewheel, but this cost can be much higher if special designs or plastic-cover structures are used. In addition, this cost does not take into account the harvesting process: The machinery required to collect microalgae biomass from diluted cultures has been demonstrated to be highly expensive. Considering a scaled-up size of 100 ha, the total investment cost has been reported as varying from \$48/m² for open raceways to \$66/m² for tubular photobioreactors (Norsker et al., 2010).

From these data, it can be concluded that although microalgae are not yet produced on a large scale for energy purposes, recent advances allow us to be optimistic and to expect this process to develop in a sustainable and economical way within the next 10 to 15 years (Wijffels and Barbosa, 2010).

References

- Acíen, F.G., Sánchez-Pérez, J.A., Fernández-Sevilla, J.M., García Camacho, F., Molina-Grima, E., 2000. Modeling of eicosapentaenoic acid (EPA) production from *Phaeodactylum tricornutum* cultures in tubular photobioreactors. Effects of dilution rate, tube diameter, and solar irradiance. *Biotechnol. Bioeng.* 68, 173–183.
- Acíen, F.G., Fernández-Sevilla, J.M., Magán, J.J., Molina-Grima, E., 2012a. Production cost of a real microalgae production plant and strategies to reduce it. *Biotechnol. Adv.* 30 (6), 1344–1353.
- Acíen, F.G., González-López, C.V., Fernández-Sevilla, J.M., Molina-Grima, E., 2012b. Conversion of CO₂ into biomass by microalgae: How realistic a contribution may it be to significant CO₂ removal? *Appl. Microbiol. Biotechnol.* 96, 577–586.
- Biller, P., Ross, A.B., 2012. Hydrothermal processing of algal biomass for the production of biofuels and chemicals. *Biofuels* 3, 603–623.
- Borowitzka, M.A., 1999. Commercial production of microalgae: ponds, tanks, tubes and fermenters. *J. Biotechnol.* 70, 313–321.
- Chiaromonti, D., Prussi, M., Casini, D., Tredici, M.R., Rodolfi, L., Bassi, N., et al., 2013. Review of energy balance in raceway ponds for microalgae cultivation: Re-thinking a traditional system is possible. *Appl. Energy* 102, 101–111.
- Chini Zittelli, G., Lavista, F., Bastianini, A., Rodolfi, L., Vincenzini, M., Tredici, M.R., 1999. Production of eicosapentaenoic acid by *Nannochloropsis* sp. cultures in outdoor tubular photobioreactors. *J. Biotechnol.* 70, 299–312.
- Chisti, Y., 2007. Biodiesel from microalgae. *Biotechnol. Adv.* 25, 294–306.
- Chisti, Y., 2012. Raceways-based production of algal crude oil. In: Clemens, P., Christian, W. (Eds.), *Microalgal Biotechnology: Potential and Production*. DeGruyter, Göttingen, Germany, pp. 113–146.
- Del Río, E., Acíen, F.G., García-Malea, M.C., Rivas, J., Molina-Grima, E., Guerrero, M.G., 2008. Efficiency assessment of the one-step production of astaxanthin by the microalga *Haematococcus pluvialis*. *Biotechnol. Bioeng.* 100, 397–402.
- Douskova, I., Doucha, J., Livansky, K., MacHat, J., Novak, P., Umysova, D., et al., 2009. Simultaneous flue gas bioremediation and reduction of microalgal biomass production costs. *Appl. Microbiol. Biotechnol.* 82, 179–185.
- García-Malea, M.C., Acíen, F.F., del Río, E., Fernández-Sevilla, J.M., Cerón, M.C., Guerrero, M.G., et al., 2009. Production of astaxanthin by *haematococcus Pluvialis*: Taking the one-step system outdoors. *Biotechnol. Bioeng.* 102, 651–657.
- Guerin, M., Huntley, M.E., Olaizola, M., 2003. *Haematococcus astaxanthin*: Applications for human health and nutrition. *Trends Biotechnol.* 21, 210–216.
- Hankamer, B., Lehr, F., Rupprecht, J., Mussnug, J.H., Posten, C., Kruse, O., 2007. Photosynthetic biomass and H₂ production by green algae: From bioengineering to bioreactor scale-up. *Physiol. Plant* 131, 10–21.
- Harun, R., Danquah, M.K., Forde, G.M., 2010. Microalgal biomass as a fermentation feedstock for bioethanol production. *J. Chem. Technol. Biotechnol.* 85, 199–203.
- Higuera-Ciapara, I., Félix-Valenzuela, L., Goycoolea, F.M., 2006. Astaxanthin: A review of its chemistry and applications. *Crit. Rev. Food Sci. Nutr.* 46, 185–196.

- Hu, C., Li, M., Li, J., Zhu, Q., Liu, Z., 2008. Variation of lipid and fatty acid compositions of the marine microalga *Pavlova viridis* (Prymnesiophyceae) under laboratory and outdoor culture conditions. *World Journal of Microbiology and Biotechnology* 24, 1209–1214.
- John, R.P., Anisha, G.S., Nampoothiri, K.M., Pandey, A., 2011. Micro and macroalgal biomass: A renewable source for bioethanol. *Bioresour. Technol.* 102, 186–193.
- Jorquera, O., Kiperstok, A., Sales, E.A., Embiruçu, M., Ghirardi, M.L., 2010. Comparative energy life-cycle analyses of microalgal biomass production in open ponds and photobioreactors. *Bioresour. Technol.* 101, 1406–1413.
- Kalk, J., Langlykke, A., 1986. Cost estimation for biotechnology projects. In: *Manual of Industrial Microbiology and Biotechnology*. American Society of Microbiology, Washington, DC, pp. 363–385.
- Li, J., Zhu, D., Niu, J., Shen, S., Wang, G., 2011. An economic assessment of astaxanthin production by large scale cultivation of *Haematococcus pluvialis*. *Biotechnol. Adv.* 29, 568–574.
- Mendoza, J.L., Granados, M.R., Godos, I., Ación, F.G., Molina-Grima, E., Banks, C., et al., 2012. Fluid-dynamic characterization of real-scale raceway reactors for microalgae production. *Biomass Bioenergy* in press.
- Norsker, N., Barbosa, M.J., Vermuë, M.H., Wijffels, R.H., 2010. Microalgal production - A close look at the economics. *Biotechnol. Adv.* 29, 24–27.
- Olaizola, M., 2003. Commercial development of microalgal biotechnology: From the test tube to the marketplace. *Biomol. Eng.* 20, 459–466.
- Oswald, W.J., Golueke, C.G., 1960. Biological transformation of solar energy. *Adv. Appl. Microbiol.* 2, 223–262.
- Posten, C., 2009. Design principles of photo-bioreactors for cultivation of microalgae. *Engineering in Life Sciences* 9, 165–177.
- Pulz, O., Gross, W., 2004. Valuable products from biotechnology of microalgae. *Appl. Microbiol. Biotechnol.* 65, 635–648.
- Richmond, A., 2000. Microalgal biotechnology at the turn of the millennium: A personal view. *J. Appl. Phycol.* 12, 441–451.
- Rodolfi, L., Zittelli, G.C., Bassi, N., Padovani, G., Biondi, N., Bonini, G., et al., 2009. Microalgae for oil: Strain selection, induction of lipid synthesis and outdoor mass cultivation in a low-cost photobioreactor. *Biotechnol. Bioeng.* 102, 100–112.
- Romero, J.M., Ación, F.G., Fernández-Sevilla, J.M., 2012. Development of a process for the production of l-amino-acids concentrates from microalgae by enzymatic hydrolysis. *Bioresour. Technol.* 112, 164–170.
- Sánchez, J.F., Fernández-Sevilla, J.M., Ación, F.G., Rueda, A., Peérez-Parra, J., Molina-Grima, E., 2008. Influence of culture conditions on the productivity and lutein content of the new strain *Scenedesmus almeriensis*. *Process Biochemistry*.
- Singh, J., Gu, S., 2010. Commercialization potential of microalgae for biofuels production. *Renewable and Sustainable Energy Reviews* 14, 2596–2610.
- Sompech, K., Chisti, Y., Srinophakun, T., 2012. Design of raceway ponds for producing microalgae. *Biofuels* 3, 387–397.
- Spolaore, P., Joannis-Cassan, C., Duran, E., Isambert, A., 2006. Commercial applications of microalgae. *J. Biosci. Bioeng.* 101, 87–96.
- Vargas, M.A., Rodríguez, H., Moreno, J., Olivares, H., Del Campo, J.A., Rivas, J., et al., 1998. Biochemical composition and fatty acid content of filamentous nitrogen-fixing cyanobacteria. *J. Phycol.* 34, 812–817.
- Wijffels, R.H., Barbosa, M.J., 2010. An outlook on microalgal biofuels. *Science* 329, 796–799.
- Wijffels, R.H., Barbosa, M.J., Eppink, M.H.M., 2010. Microalgae for the production of bulk chemicals and biofuels. *Biofuel. Bioprod. Biorefining* 4, 287–295.
- Williams, P.J.L.B., Laurens, L.M.L., 2010. Microalgae as biodiesel & biomass feedstocks: Review & analysis of the biochemistry, energetics and economics. *Energy Environ. Sci.* 3, 554–590.

Intentionally left as blank

Index

Note: Page numbers followed by *f* indicate figures and *t* indicate tables.

A

- Agars, 215
- Airlift photobioreactors, 170
- Algae oils
 - algal fuel/biodiesel, 171–175, 177–179
 - cellular biochemistry, lipid synthesis, 157–158
 - microalgae (*see* Microalgae)
 - transesterification, 175–177
- Algal biofuels
 - biodiesel (*see* Biodiesel, algal biofuels)
 - biodiesel selling price, cultivation systems, 280, 280*f*
 - bioethanol (*see* Bioethanol, algal biofuels)
 - biomass and lipids productivity, 280
 - bio-oil (*see* Bio-oil, algal biofuels)
 - capital and operating cost, 281
 - closed photobioreactors, 265–269
 - commercial cultivation plants, technical assessment, 262–263
 - conventional flocculants, 271
 - co-product, carbohydrate, 279–280, 282
 - dehydration/drying, slurry, 271–272
 - EER, energy crops and algae, 263, 263*t*
 - fossils, 261
 - harvesting, algal biomass, 269–270, 270*t*
 - land-based plants, 261–262
 - LCAs, 262–263
 - market potential and feasibility, 272
 - open ponds (*see* Open pond systems, algal biofuels)
 - phytonutrients and proteins, 279–280
 - preliminary cost analysis, 278
 - production, commercial scale, 278
 - production cost, 279
 - progressive R&D efforts, 278–279
 - renewable and sustainable energy, 261
 - solar drying, 272
 - technical challenges, 262
 - techno-economic feasibility, 278
 - thickening methods, 270–271
 - types, 261–262
 - water consumption cost, 281
- Algal biomass
 - carbohydrate profiles, 237–238

- composition, 237
- harvesting (*see* Harvesting, algal biomass)
- harvesting of microalgae, 239
- microalgae/defatted microalgae, 238
- production systems, 239
- red seaweeds, 237–238
- Algal fuel/biodiesel
 - post-harvesting steps, 171–172
 - preparation
 - cell disruption, 172–173
 - extraction, algae oil (*see* Extraction, algae oil)
 - processing, 172*f*
 - properties
 - fatty acid composition, 179*t*
 - microalgae biodiesel characterization, 178*t*
 - physical properties, 177–178
 - pour point, 177–178
- Alginates, 214

B

- Biochar, 211
- Biodiesel
 - algal biofuels
 - heterogeneous catalyst, 273–274
 - homogeneous catalyst, 273
 - in situ* transesterification, 274–275
 - lipid extraction, 272–273
 - fatty acid alkyl esters, 211
 - microalgae fuel production
 - acetyl CoA pools, 48–49
 - 16- and 18-carbon fatty acids, 48–49
 - animal species, lipid droplet proteome, 52
 - de novo* biosynthesis, TAG, 51
 - DGATs catalyzation, 49–51
 - ectopic expression, WRI1 results, 51–52
 - fatty acid assembly, ER and chloroplast, 51
 - GPAT and LPAAT, 49
 - lipid and TAG biosynthesis, 48
 - lipid biosynthesis and fatty acid, 51–52
 - lipid droplets/lipid bodies, 52
 - malonyl-ACP by MCT synthesis, 48–49
 - MLDP, 52

- Biodiesel (*Continued*)
- mRNAs, 49–51
 - nitrogen deficiency, 49–51
 - nitrogen starvation, 51
 - nutrient starvation, 48
 - oleaginous green microalgae species, 48
 - pathways and subcellular localizations, 48–49, 50f
 - PDATs, 49
 - production, oilcake, 211
- Bioethanol, algal biofuels
- bioethanol yield, 275–276, 276t
 - carbohydrate extraction, biomass, 275
 - gasoline, 275
 - high carbohydrate contents, algal strains, 275
 - hydrolysis methods, 275–276
 - supercritical CO₂ extraction, lipids, 276
- Biofertilizers, biomass applications, 19–20
- Biofuels. *See also* Cultivation, microalgae
- biomass applications, 19
 - low-value biomass production
 - advantages, microalgae, 321
 - biogas value, 321–322
 - closed photobioreactors, 322–323
 - depreciation, 322
 - design and operation optimization, open raceways, 323–324
 - energy, 323–324
 - hydrothermal liquefaction, 322
 - microalgae-based, 321–322
 - open raceways, scaled up to 600 tons/year, 322, 323f
 - raceway reactors, 322
 - third-generation biofuel source, 321
 - wastewater and flue gases, 321–322, 321f
- Biofuels production. *See also* Algal biofuels
- algal biomass
 - culture medium, 144
 - energetic issue, 144
 - market value, 145
 - pyrolysis (*see* Pyrolysis)
 - vinasse, 145
 - zero carbon emissions, 143
 - spent biomass
 - biochar, 211
 - biodiesel, 211
 - bio-oil, 210–211
 - ethanol, 209–210
 - halogenated materials, 222–224
 - hydrogen, 209
 - lipid compounds, 218–220
 - phenolic materials, 224
 - pigment materials, 220–222
 - polysaccharide material, 212–215
 - proteinaceous compounds, 215–217
- Biohydrogen, microalgae fuel production
- advantages, *Chlamydomonas* genetics, 56
 - aerobic photosynthetic growth to anaerobic physiology state, 52
 - bioreactor design and operation, 195–197
 - CEF, 55–56
 - cells immobilization, solid surface, 57
 - direct biophotolysis, 201
 - economic evaluation, 198–199
 - electron transport pathways, hydrogen production, 53, 54f
 - FDXs, 55
 - [FeFe]-hydrogenases catalyzation, 53
 - genetically modified microorganisms, 201
 - genetic and metabolic engineering approaches, 54–55
 - hexose uptake protein, *Chlorella kessleri*, 55–56
 - hydrogenase, 199
 - hydrogen production (*see* Hydrogen production, biophotolysis)
 - integration, biology and engineering, 57
 - low hydrogen yield and production rate, 200
 - metabolic engineering/biotechnology strategies, 52
 - mutant algae, 200
 - mutants defective, D1 protein, 55
 - Nac2* gene, 56
 - photo-fermentation-based and dark-fermentation-based H₂ production units, 57
 - reduced FDX, 53
 - sequential mutagenesis, 56–57
 - spectroscopy analysis, 56–57
 - starch accumulation, 54
 - starch metabolism, H₂ evolution, 53
 - sulfur deprivation enhancement, 53–55
 - truncated chlorophyll antenna size, photosystems, 200–201
- Biomass
- applications
 - biofertilizers, 19–20
 - biofuels, 19
 - biopigments, 18
 - biopolymers, 18–19
 - drugs, 18
 - food, 17–18
 - harvesting process
 - centrifugation, 14
 - electrophoresis, 15
 - filtration, 14–15
 - flocculation, 14
 - flotation, 15
 - removal of biomass, culture medium, 13
 - sedimentation, gravity, 14
 - selection, 13
 - techniques, 13

- Bio-oil
- algal biofuels
 - bioethanol production, 277
 - heterogeneous catalysts, 277–278
 - hydrothermal liquefaction, 276–277
 - lignocellulosic biomass, 276–277
 - poor quality, 276–277
 - pyrolysis, 276–277
 - wet algal slurry, 277
 - production
 - Dunaliella tertiolecta*, 210–211
 - microalgal spent biomass, 210
 - Microcystis viridis*, 210–211
 - pyrolysis, 210
 - thermochemical liquefaction, 210
- Biopigments, biomass applications, 18
- Biopolymers, biomass applications, 18–19
- Bioreactor
- biohydrogen production
 - algal photobioreactors, 196
 - flat panel reactors, 196
 - hythane, 197
 - multistage bioreactors, 197, 197f
 - mutant algae, 195–196
 - open-pond culture systems and enclosed bioreactor facilities, 195
 - photobioreactors, 195
 - single-stage, 197
 - truncated chlorophyll antenna size, 195–196
 - tubular photobioreactors, 196–197
 - design and operation
 - airlift reactors, 32–33
 - closed *vs.* open systems, 29
- Bioremediation
- carbon dioxide sequestering, 224
 - wastewater treatment, 225
- Botryococcus braunii*, CO₂ fixation
- botryococcenes*, 77
 - exopolysaccharides synthesis, 77
 - hydrocarbon accumulation, 77
 - phosphorus and nitrogen, 77
 - photosynthetic organism, 77
 - strain SAG 30.81, 77
- Bubble column PBRs, 170–171
- C**
- Carbondioxide (CO₂)
- biofixation/sequestration, microalgae, 156
 - fixation (*see* CO₂ fixation)
 - sequestering, 224
- Carbon market, microalgal
- cap-and-trade system, 81
 - credits, 81
 - domestic and industrial wastes, 82
 - energy-use policies, 81
 - fossil sources, 81
 - Kyoto Protocol, 81
 - trades, carbon papers, 81–82
- Carbon sources, microalgae cultivation systems, 24
- Carrageenans, 214
- CCM. *See* CO₂-concentrating mechanisms (CCM)
- CEF. *See* Cyclic electron flow (CEF)
- Cell disruption, algae cells
- bead-beating method, 173
 - expeller press method, 172–173
- Cell recycling, continuous cultivation
- algal species/strains, 129
 - cell bleeding, 129
 - glucose mass supply and volumetric perfusion rate, 127–129, 128f
 - growth and glucose consumption, 127–129, 128f
 - perfusion culture, 127–129
 - time course, growth and glucose consumption, 127–129, 128f
- Centrifugation, algal biomass harvesting
- algae separation, 101
 - analogous to sedimentation tanks, 101
 - hydrocyclone, 101
 - nozzle-type centrifuge, 102
 - solid-bowl decanter centrifuge, 101–102
 - solid-ejecting disc centrifuge, 102
- CERs. *See* Certified emission reductions (CERs)
- Certified emission reductions (CERs), 106
- Cetyltrimethylammonium bromide (CTAB)
- algal removal efficiency, 100
 - surfactants, 99–100
- Chlorella*
- B vitamins, 8
 - chlorophyll and photosynthetic capacity, 7
 - classification, 7
 - compounds, nutritional benefits to human health, 8
 - description, 7
 - protein content, 8
- Chlorella protothecoides*, heterotrophic algal oils
- classification and species, 129–130
 - description, 129
 - downstream processes, 130–133
 - oil production, 130, 131t, 132t
 - rRNA-based phylogenetic approach, 129–130
- Chlorella vulgaris*, CO₂ fixation
- concentration, 76
 - description, 76
 - enzyme carbonic anhydrase, 76
- Closed photobioreactors
- active compounds, 318
 - algal biofuels

- Closed photobioreactors (*Continued*)
- airlift tubular photobioreactor, 266–269
 - biological and physiological characteristics, 266
 - CO₂ transfer and mixing, 266–269
 - cultivation cycles, 266
 - energy consumption, algal culture systems, 266–269, 269*t*
 - PBRs designs, 266, 267*t*
 - analysis, production costs, 319–320, 320*f*
 - biomass productivity, 319–321
 - Chlorella* biomass, 319
 - comparison, microalgae production, 16, 16*t*
 - description, 16
 - flat panels/open raceways, 320–321
 - functional food, human and animals, 318
 - homogeneity, medium and mass transfer, 16
 - labor reduction, 320
 - marine strains, 318–319
 - photosynthetic efficiency and higher production, biomass, 2
 - production, *Scenedesmus almeriensis* dry biomass, 319, 319*f*
- Closed systems, microalgae cultivation systems
- advantages, 31
 - flat plate photobioreactors, 33–34
 - horizontal tubular photobioreactors, 34–35
 - photobioreactors, 31
 - prospects and limitations, culture systems, 31, 32*t*
 - requirements, GMP guidelines, 31
 - types, 31
 - vertical column photobioreactors, 31–33
- Coagulation-flocculation, algal biomass harvesting
- adsorption and bridging model, 92
 - algae-harvesting technologies, 91
 - alkaline flocculants, 91–92
 - anionic polyelectrolytes, 92
 - autoflocculation, 93
 - commercial product, chitosan, 92–93
 - fungi pelletization-assisted bioflocculation process, 93–94
 - inorganic, 91
 - lime treatment, 93
 - long-chain organic, 92
 - marine environment, polyelectrolytes, 92
 - monovalent and divalent bases, 91–92
 - optimal coagulant dosages, 93
 - satisfactory treatment, algal pond effluent, 91
 - settled algal cells, 92–93
- CO₂-concentrating mechanisms (CCM), 166–167
- CO₂ fixation
- biological mitigation, 68
 - carbon market, microalgal technologies (*see* Carbon market, microalgal)
 - chemical reaction-based CO₂ mitigation approach, 68
 - conservation, direct and indirect mitigation techniques, 67
 - evaluation, nutrient needs, 68
 - existence, microalgae, 68
 - mass cultivation (*see* Mass cultivation, CO₂ fixation)
 - mass-cultivation techniques, 68
 - microalgae (*see* Microalgae, CO₂ fixation)
 - microalgal metabolism, 67–73
 - open pond systems
 - engineering, photobioreactor, 11
 - gas absorption, reactions, 11
 - horizontal/airlift photobioreactors, 11
 - microalgal cultivation, 11
 - open tanks, 11
 - production, biomass, 11
 - reduction in pH, 11
 - photosynthesis (*see* Photosynthesis, CO₂ fixation)
 - rate, carbon uptake, 68
 - reducing/absorbing GhG, 67
 - relocation, 67
- Commercialization. *See* Algal biofuels
- Continuous cultivation
- algal growth, TFA and DHA production, 125–126, 127*f*
 - with cell recycling, 127–129
 - continuous, perfusion and perfusion-bleeding culture systems, 125–126, 126*f*
 - description, 125–126
- Cost analysis, microalgae biomass production
- equipments and equipment size, 314
 - exponential law, 315–316
 - labor, 315
 - materials, 315
 - steps, 314–315, 315*f*
 - water, 315
- Cross-flow ultrafiltration, 96
- CTAB. *See* Cetyltrimethylammonium bromide (CTAB)
- Cultivation, microalgae
- advantages and disadvantages, open and closed algal plants, 28–29, 29*t*
 - AGS system, 36–40
 - algae biomass, 36
 - Algenol's Direct to Ethanol[®], 36, 37*t*, 40*f*
 - carbon sources, 24
 - closed cultivation systems (*see* Photobioreactors (PBRs))
 - closed systems (*see* Closed systems, microalgae cultivation systems)
 - comparison, biofuel companies, 36, 37*t*
 - description, 168
 - emissions to environment, 299–300
 - flexible plastic film photobioreactors, Algenol, 36, 41*f*
 - and growth medium, 294–296

- light supply, 25–26
 - limitations, 36
 - nitrogen source, 24–25
 - open pond systems
 - categories, 169
 - Chlorella*, 7–8
 - Dunaliella*, 8
 - drawbacks, 169
 - parameters, 6–7
 - Spirulina*, 7
 - types of bioreactors, 6
 - operating conditions, 296–297
 - PBR designs, 29
 - pH, 26–27
 - physiological and growth characteristics, 29
 - production, biofuels, 28
 - production, high-value products, 29
 - quantity and quality, CO₂, 298–299
 - salinity, 27
 - sapphire's green crude farm, raceway open ponds, 40, 42f
 - seamibiotic's pilot plant, 40, 42f
 - Solzayme's heterotrophic algae cultivation platform, 40–41, 43f
 - Solix Lumian™, AGS4000 system, 36–40, 42f
 - temperature, 26
- Cyclic electron flow (CEF)
- ATP/NADPH ratio, 55–56
 - noc1* mutant, 55–56
 - optimal photosynthetic activity, 55–56
- D**
- Dark/heterotrophic fermentation, 193–195
 - Deep-bed filtration
 - algal cells separation, pond effluent, 96
 - description, 96
 - intermittent sand filtration, 96
 - Defatted microalgae, 238
 - Dewatering
 - algae cultivation, harvesting and processing, 86, 86f
 - coagulation-flocculation and gravity sedimentation, 105
 - downstream processing, 89
 - electrical approaches to algae, 102–103
 - plate-and-frame filter press filtration, 94–95
 - DGATs. *See* Diacylglycerol acyltransferases (DGATs)
 - Diacylglycerol acyltransferases (DGATs)
 - acyl-CoA, 49
 - overexpression, arabidopsis, 49–51
 - Dietary fibers
 - antitumor and antiherpetitic bioactivity, 212, 213t
 - edible marine macroalgae, 212
 - Direct hydrothermal liquefaction (DIRHTL), 253–254
 - Direct photolysis, hydrogen production
 - cyanobacteria, 190–191
 - description, 190
 - hydrogenase-mediated, 190, 191f
 - merits, 191
 - plastoquinone, 190
 - DIRHTL. *See* Direct hydrothermal liquefaction (DIRHTL)
 - Dispersed-air flotation
 - classes, reagents, 100
 - CTAB and SIDS, 99–100
 - froth-flotation method, 99–100
 - harvesting algae, dilute suspensions, 99
 - pH level, 100
 - removal efficiency, live and dead algae, 100
 - selectivity, air-bubble attachment, 100
 - Dissolved-air flotation
 - liquid stream saturation, 98
 - production, fine air bubbles, 98–99
 - solids concentration, harvested slurry, 99
 - Downstream process, *Chlorella protothecoides*
 - cell-wall disruption, 133
 - cultures, 130–133
 - harvest and drying, 130–133
 - transesterification, 133
 - Drying
 - algae cultivation, harvesting and processing, 86, 86f
 - biomass
 - methods, 16
 - production, low-cost commodities and high-value products, 15–16
 - downstream processing, 89
 - and oil extraction, 104
 - Dunaliella*
 - biological activities, 8
 - CO₂ fixation, 78
 - eukaryotic green algae, 8
 - natural source, β-carotene, 8
 - saline stress, NaCl concentration, 8
 - salinity with optimal growth, 8
- E**
- EER. *See* Energy-efficiency ratio (EER)
 - Electroflotation, 99
 - Endogenous substrate catabolism, 193, 199–200
 - Energy-efficiency ratio (EER)
 - algal biodiesel, 263–265
 - defined, 263
 - energy conversion efficiency, 263
 - energy crops and algae, 263f
 - Energy, LCAs
 - climate change and endpoint impacts, electric mixes, 293–294, 293f

- Energy, LCAs (*Continued*)
 Ecoinvent database and ReCiPe impact assessment
 method, 293–294
 sources, biomass and biofuels, 291–293, 293*t*
- Environmental impact assessment, LCAs
 coproducts issue, 303–304
 description, 303
 energy balance, 305
 environmental impacts, 305–306
- Ethanol production, 209–210
- Expeller pressing, 172–173
- Extraction, algae oil
 enzymatic treatment, 175
 hydrothermal liquefaction, 174
 osmotic shock, 175
 PEF processing, 175
 SC-CO₂, 174
 solvent extraction, 173
 Soxhlet extraction, 173–174
 ultrasonic extraction, 174
 wet lipid extraction process, 174
- F**
- Fast pyrolysis
 condenser effluent gases, 148
 fluidized bed reactor, 147
 heating, 147
 incondensable gases combustion, 148
 low moisture content, 149
 probable mechanisms, 149, 149*f*
 reactor temperature, 147–148
 residence time, 148, 149
 steps and reactions, 149
 system, 147
 unit, 148*f*
- FDXs. *See* Ferredoxins (FDXs)
- Fed-batch cultivation
 algal cultures and cells build up, 124
 growth and glucose consumption and lipid
 production, 124, 125*f*
 heterotrophic oil production, *C. zofingiensis*, 124
 substrates, 124
- Feed, spent biomass
 animal feed, 226
 fertilizer (plant feed), 225
- Ferredoxins (FDXs)
 and CEF, 55–56
 [FeFe]-hydrogenases, 55
 photosynthetic electron transport chain, 53
- Filtration, algal biomass harvesting
 advantages, 94
 cross-flow ultrafiltration, 96
 deep-bed, 96
 forcing algal suspension, medium to suction pump, 94
 frequent backwashing, 94
 magnetic, 96
 pressure, 94–95
 problems, 94
 surface/deep-bed, 94
 vacuum, 95
- Flat panel photobioreactors, 171
- Flat plate photobioreactors
 advantages, photoautotrophic microorganisms, 33–34
 hydrodynamic stress, microalgae cells, 33–34
 plate-type, microalgae cultivation, 33–34, 34*f*
- Flocculation, biomass harvesting process, 14
- Flocculation-sedimentation, 97
- Flotation
 advantages, 98
 classification and separation process, 98
 description, 15, 98
 dispersed-air, 99–100
 dissolved-air, 98–99
 divisions, 102–103
 electroflotation, 99
 flocculation-flotation process, 98
 limited algae biomass, 98
 ozone, 100–101
 variations, 98
- FU. *See* Functional unit (FU)
- Fuel production, microalgae
 biodiesel (*see* Biodiesel, microalgae fuel production)
 biofuel feedstocks, 47
 biohydrogen (*see* Biohydrogen, microalgae fuel
 production)
 custom-made molecular toolkits, 59
 economics, microalgae-based, 59–60
 elucidation, molecular mechanisms, 59
 green alga *Chlamydomonas reinhardtii*, 47–48
 integrated omics approaches, 59
 LCE (*see* Light conversion efficiency (LCE))
 microalgal biology, 47–48
 recycling and recovery, co-products, 58–59
- Functional unit (FU)
 biomass transformation, 290, 292*f*
 description, 289–290
 input, biomass production and conditioning, 290, 292*f*
 LHV/HHV, 290
 and perimeters, selected studies, 290, 291*t*
 studies/technological options, 289–290
 vectors, bioenergy, 290
- G**
- Glycerol-3-phosphateacyltransferase (GPAT)
 lipid metabolism and catabolism, 52
 and LPAAT, 49

- Glycolipids, 219
GMP. *See* Good manufacturing practice (GMP) guidelines
Good manufacturing practice (GMP) guidelines, 31
GPAT. *See* Glycerol-3-phosphateacyltransferase (GPAT)
Gravity sedimentation, algal biomass harvesting
 algae separation, 97
 clarification, simple tanks/ponds, 97
 description, 96
 flocculation-sedimentation, 97
 lamella-type sedimentation tanks, 97
- H**
Haematococcus sp., CO₂ fixation, 78–79
Halogenated materials
 bioactivities, polyphenol and halogenated compounds, 223–224, 223t
 iodine, 222–223
Harvesting, algal biomass
 anaerobic digestion, waste oilcakes, 106
 aquatic photosynthetic organisms, 85–86
 biofuel production, 86, 86f
 centrifugation (*see* Centrifugation, algal biomass harvesting)
 CERs, 106
 coagulation-flocculation (*see* Coagulation-flocculation, algal biomass harvesting)
 coal-fired power plants/sewage treatment facilities, 106
 cultivation and nutrients, 86
 definition, 89
 disadvantages, 105
 electroflocculation techniques, 102–103
 electrophoresis and electroflotation, 102–103
 energy-efficient and cost-effective harvesting, 104
 expensive culture systems and cost of harvesting, 104
 filtration (*see* Filtration, algal biomass harvesting)
 flotation (*see* Flotation)
 fossil fuels, 85
 gravity sedimentation (*see* Gravity sedimentation, algal biomass harvesting)
 high production yields, microalgae, 105
 LCA, 105–106
 mechanisms, carbon dioxide fixation, 85–86
 in microalgae, 105
 processes and techniques, 89
 production, 85
 screening (*see* Screening, algal biomass harvesting)
 solar energy into chemical energy, 86
 stability and separability, microalgae, 86–89
 techno-economic analysis, 106
 ultrasonic methods (*see* Ultrasonic methods, algal biomass harvesting)
 water content, 89
- Helical-type photobioreactors, 171
Heterotrophic algal oils
 acetyl-CoA synthetase, 120–121
 Achnanthes brevipes and *Tetraselmis* spp, 122–123
 advantages, 113–116
 algae reported, growth, 112–113, 114t
 autotrophic growth, open ponds, 111–112
 biomass and oil productivities, 113–116, 117f
 carbon, 120
 carbon and energy source, microalgae, 112–113
 cell factory, *Chlorella* (*see* *Chlorella protothecoides*, heterotrophic algal oils)
 central carbon metabolism, microalgae, 113, 115f
 central metabolic network, glucose, 113, 115t
 Chlamydomonas, 134–135
 Chlorella protothecoides, 113–116
 circular ponds, 111–112
 contents, 119
 continuous cultivation, 125–126, 127–129
 EMP and PP pathways, 113
 environmental factors, 123
 enzymes up-regulation, lipid biosynthesis, 121–122
 fatty acid profiles, *C. zofingiensis*, 116–118
 fed-batch cultivation, 124
 fermentation system, 133–134
 flat plate PBR, 112
 growth, lipid content and lipid composition, *C. zofingiensis*, 120, 121f
 hexose/H⁺ symport system, 113
 high cell density, 124
 industrial-scale processes, 118–119
 integrated production, biofuels, 134, 134f
 low-cost sources, 133
 low temperature, unsaturated fatty acids, 123
 mass cultivation, microalgae, 111–112
 nitrogen, 121–122
 oil content, 116–118, 117t
 one-at-a-time and statistical methods, 123–124
 organic carbon sources, 119
 PBR design, 112
 petroleum fuels, 111
 plant oil-derived biodiesel, 111
 production, cultures, 119
 raceway ponds, 112
 rigorous sterilization and aseptic operation, 119
 strain improvement, genetic engineering, 134–135
 sugars utilization, biomass, 133–134
 uptake, ammonia, 122
- Heterotrophism, 163
HHV. *See* High heating value (HHV)
High heating value (HHV), 290

- High-value carotenoids
 astaxanthin and beta-carotene, 316
 cost analysis data, 316–317
Haematococcus pluvialis, 316
 process, production, 316–317, 317f
 reduction, power consumption, 317–318
 tubular and raceway reactors, 317, 318f
- Horizontal tubular photobioreactors
 coil-type systems, 35
 commercial production, 34–35
 improvement, air-residence time, 35
 for microalgae cultivation, 34–35, 35f
- Hybrid photobioreactors
 description, 17
 α -shaped reactor, 17
- Hydrocolloids
 agars, 215
 alginates, 214
 carrageenans, 214
- Hydrogen production
 biogas production, 209
 biophotolysis
 dark fermentation, 193–195
 direct photolysis, 190–191
 endogenous substrate catabolism, 193
 indirect photolysis, 191–193
Chlamydomonas reinhardtii, 209
 lipid-free residue, 209
 pyrolysis, 209
- Hydrothermal carbonization, algae, 254
- Hydrothermal gasification, algae, 254
- Hydrothermal liquefaction, algae upgradation
 algae, catalytic hydrothermal upgradation, 252
 macroalgae, 252–253
 microalgae, 248–251
 model compounds, 247–248
 two-step sequential, 253–254
- Hydrothermal upgradation (HTU)
 algae upgradation, 247–254
 algae utilization, 237
 algal biomass, 237–239
 biofuel production, 235
 catalysts, 245
 commercialization, 255
 conventional gasification technologies, 256
 definition, 241
 heterogeneous catalysts, 246–247
 homogeneous, 245–246
 hydrothermal chemistry, 242–244
 lignocellulosic biomass and algal biomass,
 236–237, 236f
 macroalgae, 239–240
 post-extraction byproducts, 255
 reaction media, 241–242
 reactors, 245
 TCC (*see* Thermochemical conversion (TCC))
- ## I
- Indirect photolysis, hydrogen production
 algal bioreactors, 191–192
cyanobacterium gloeocapsa alpicola, 192
 mutant algae, 192–193
 protein biosynthesis, 191–192
 sulfur deprivation, 191–192
- Inventory data, microalgae
 culture
 biomass transformation, 308
 description, 308
 mature and emerging technologies, 309
 description, 308
 emissions to environment, 309
 input, 308
- ## L
- Lamella-type sedimentation tanks, 97
- LCAs. *See* Life-cycle assessments (LCAs)
- LCE. *See* Light conversion efficiency (LCE)
- LEDs. *See* Light-emitting diodes (LEDs)
- LHCI. *See* Light harvest complex I (LHCI)
- LHV. *See* Lower heating value (LHV)
- Life-cycle assessments (LCAs)
 algal-based bioenergy production systems, 288
 algal biofuel production, 105–106, 262–263
 assumptions and system boundaries, 263
 climate change and biogenic carbon, 309–310
 cultivation, microalgae (*see* Cultivation, microalgae)
 depletion and environmental impacts, fossil
 energies, 287
 energetic balance and environmental impacts, 105
 energy (*see* Energy, LCAs)
 energy balance, 310
 environmental impact assessment, 303–306
 environmental impacts, 310
 first-and second-generation biofuels, 287–288
 FU (*see* Functional unit (FU))
 harvesting and conditioning, biomass, 300, 301f
 harvesting and drying algal biomass, 270–271
 input category, 291
 inventory data (*see* Inventory data, microalgae)
 ISO method, 288
 microalgae culture/transformation, inventory
 data, 290
 microalgal biomass transformation, 300–303
 nutrients (*see* Nutrients, LCAs)
 peer-reviewed scientific journals, 288
 perimeter and functional units, 307

- production systems, 288
 - raceway ponds and airlift tubular closed
 - photobioreactors, 266–269
 - third-generation biofuels, 288
 - Light conversion efficiency (LCE)
 - culture productivity, 58
 - defined, 58
 - LHCI and LHCII, 58
 - light-harvesting chlorophyll antenna sizes, 58
 - uneven distribution, light, 58
 - Light-emitting diodes (LEDs), 28
 - Light harvest complex I (LHCI), 58
 - Lipid compounds
 - glycolipids, 219
 - n-3 fatty acids, human health, 218
 - PLs, 219
 - sterols, 219–220
 - Lipid synthesis
 - acetyl-CoA/malonyl-CoA formation, 158
 - algal-based, photoautotrophic mechanism, 157, 157f
 - de novo synthesis, fatty acids, 157
 - glucose accumulation, inside cell, 158
 - higher fatty acids synthesis, 160–161
 - palmitic acid synthesis, 159–160
 - Lower heating value (LHV), 290
 - LPAAT. *See* Lysophosphatidic acid acyltransferase (LPAAT)
 - Lysophosphatidic acid acyltransferase (LPAAT)
 - and GPAT, 49
 - lipid metabolism and catabolism, 52
- M**
- Macroalgae
 - description, 205–206, 239
 - production systems, 239–240
 - red, green, and brown macroalgae habitats, 240
 - sugars, 206
 - Magnetic filtration, 96
 - Major lipid droplet protein (MLDP), 52
 - Malonyl-CoA:ACPtransacylase (MCT), 48–49
 - Mass cultivation, CO₂ fixation
 - cultivation vessels, 79
 - light diffusion, 79–80
 - mixing, 80
 - MCT. *See* Malonyl-CoA:ACPtransacylase (MCT)
 - Metabolic engineering, microalgae. *See* Fuel production, microalgae
 - Microalgae. *See also* Cultivation, microalgae: Economics, microalgae biomass production: Fuel production, microalgae
 - biohydrogen production (*see* Biohydrogen, microalgae fuel production)
 - and biotechnology
 - advantages, 2–3
 - aquatic and terrestrial, 2–3
 - biotransformation, 2
 - cyanobacteria, 2
 - description, 2
 - growth conditions and bioreactors, 2
 - industrial importance, ramifications, 2
 - bryophytes, 238
 - CO₂ fixation
 - biomass productivity and CO₂ fixation rate, 75, 76f
 - bioreactors, 72
 - Botryococcus braunii*, 77
 - carbon and DIC transport, 72
 - Chlorella vulgaris*, 76
 - development, media, 72
 - Dunaliella sp.*, 78
 - gas phase analysis, 75, 75f
 - global rates determination, 74–75
 - Haematococcus sp.*, 78–79
 - mineralization and extracellular products, 74
 - nutritional requirements, 72
 - PBRs (*see* Photobioreactors (PBRs), CO₂ fixation)
 - Spirulina platensis*, 77–78
 - systems, 72
 - therapeutical compounds, 72
 - utilization, complex media, 73
 - cultivation, 168–171
 - description, 238
 - energy-dense bio-oil, 250–251
 - harvesting, 239
 - hydrothermal liquefaction, 248–251
 - nutritional mode, 161–166
 - production systems, 239
 - substrates, growth and lipid production, 166–168
 - Microalgae biomass production
 - analysis, 314
 - continuous-discontinuous combinations, 313–314
 - cost analysis (*see* Cost analysis, microalgae biomass production)
 - downstream schemes, 313–314, 314f
 - fine chemicals and pharmaceuticals, 313
 - high-value biomass (*see* Closed photobioreactors)
 - high-value carotenoids, 316–318
 - large-scale markets, 313
 - low-value biomass (*see* Biofuels)
 - Microalgal biomass transformation, LCAs
 - biodiesel production, 302
 - biogas production, 302–303
 - electricity production, 302
 - energy carriers, 300
 - Microalgal metabolism
 - description, 68–69
 - eukaryotic autotrophic microorganisms, 68–69

- Microalgal metabolism (*Continued*)
 organic pigments, harvesting light energy, 69
 photoautotrophic cultures, 69
- Microstraining
 biological fine screen, 90–91
 with 6 μm and 1 μm meshes, 90–91
- Micractinium and Scenedesmus, 90
 problems, 90
 rotary drums, 90
 sewage effluents and water supply, 90
 unit costs, 90
- Mixotrophism, 165–166
- MLDP. *See* Major lipid droplet protein (MLDP)
- N**
- Nitrogen source, microalgae cultivation systems, 24–25
- Nozzle-type centrifuge, 102
- Nutrients, LCAs
 chemical fertilizers, 294
 climate change and endpoint impacts, fertilizers, 294, 296f
 lipid/carbohydrate storage, 294
- Nutritional mode, microalgae
 autotrophic and heterotrophic organisms, 161–162
 heterotrophic mechanism, 163–164
 living organisms, divisions, 161–162
 mixotrophic mechanism, 164–166
 photoautotrophic mechanism, 162–163
 photoheterotrophic metabolic process, 161–162, 161f
- O**
- Open pond systems
 advantages and disadvantages, 2
 algal biofuels
 advantages, limitations and factors, 265
 phototrophic cultivation, 265
 raceway, 265–266
 requirements, cultivation system, 265
 applications, biomass (*see* Biomass, applications)
 biotechnology and microalgae, 2–3
Chlorella vulgaris, 1
 closed photobioreactors (*see* Closed photobioreactors)
 commercial production, 3
 company Olson Microalgae with commercial
 production, *Spirulina* capsules, 4, 5f
 construction, tanks, 3
 cultivation, *Spirulina*, 4, 4f, 5f
 description, 1–2
 development, cultivation systems, 1
 drying, biomass (*see* Drying process, biomass)
 environmental variations, 3
 fixation, carbon dioxide (CO₂), 11
Haematococcus pluvialis, 4
 harvest, biomass (*see* Biomass, harvesting process)
 hybrid photobioreactors, 17
 hydrodynamics, 10
 industrial scale, companies, 3–4
 light spectrum and intensity, 9–10
 microalga cultivation, vinasse and carbon dioxide,
 6, 6f
 microalgae cultivation systems
 classification, 30
 limitations, 30
 raceway, 30–31
 simple, 30
 microalgal biotechnology, 1
 photobioreactors, 3
 pH values, 12–13
 raceway, shallow big/circular forms, 3
 reactor design (*see* Photobioreactors (PBRs), open
 pond systems)
 sterility, cultivation, 13
 temperature (*see* Temperature, open pond systems)
- Ozone flotation, 100–101
- P**
- Palmitic acid synthesis, 159–160
- PBRs. *See* Photobioreactors (PBRs)
- PDATs. *See* Phospholipid:diacylglycerolacyltransferases
 (PDATs)
- PEF processing. *See* Pulsed electric field (PEF)
 processing
- Peptides, 216–217
- Perimeter and functional units
 allocation/substitution, 307
 energy content, intermediate product, 307
 technologies/energy production pathways, 307
- Phospholipid:diacylglycerolacyltransferases (PDATs)
 lipid metabolism and catabolism, 52
 synthesis, TAG, 49
- Phospholipids (PLs), 219
- Photobioreactors (PBRs)
 airlift, 170
 biofuels production and biorefineries, 23–24
 biomass productivity, 27–28
 bubble column, 170–171
 cell concentration, 27
 CO₂ fixation
 gas–liquid mass transfer, 73
 gas to aqueous phase, 73
 high CO₂-resistant strains, 73
 isolation and selection, strains, 74
 process, HCO₃⁻, 74
 sources, 73
 storage and pH, 73
 uncatalyzed reaction paths, 73

- commercialization, microalgae-based products, 23–24
 commercial-scale processes, 28
 design and operation, microalgae cultivation systems, 27
 flat panel, 171
 helical-type, 171
 high mass transfer, 169–170
 LEDs, 28
 limitation, light energy, 27–28
 microalgae cultivation and biofuels (*see* Cultivation, microalgae)
 microorganisms/alien microalgae species, 27
 open pond systems
 biofilms, 9
 glass, fiberglass and PVC, 9
 materials, construction, 9
 outdoor microalgae cultivation system, 28
 sequestration, CO₂, 169–170
 stirred-tank, 171
 vertical tubular, 170
- Photosynthesis
 autotrophs, 158
 carbon sequestration mechanism, 156
 CO₂ fixation
 ATP and NADPH, 69
 Calvin-Benson-Bassham cycle, 70
 dark process, CO₂ capture and transformation, 70–71, 70f
 defined, 69
 different forms, water, 70, 70f
 hydrogen addition, carbohydrates ([CH₂O]_n), 69–70
 light and dark reactions, 69
 light reaction, 70
 nitrogen source, microalgae cultivation, 71
 phases, 71
 photorespiration, 71
- Pigment materials
 carotenoids, 220–222
 chlorophylls, 220
 phycobiliproteins, 222
- PLs. *See* Phospholipids (PLs)
- Polysaccharide material
 algal polysaccharides, 212
 description, 212
 dietary fibers, 212–213
 hydrocolloids, 214–215
 macroalgae, 212
- Pressure filtration
 chemical conditioners, 94–95
 designs and types, 95
 plate-and-frame presses/vessels, 94–95
- Proteinaceous compounds
 algal proteins, 215
 bioactive peptides, 215
 free amino-acids, 217
 peptides, 216–217
 proteins, 215–216
- Proteins, 215–216
- Pulsed electric field (PEF) processing, 175
- Pyrolysis
 characteristics, 147t
 description, 145–146
 fast, 147–149
 proportion of gas, liquid and solid product, 146, 147t
 reactions, 146
 residence time, 146
 yields and characteristics
 algal biomass, 151t
 average cost, 152
 conditions, fast, 150
 elemental analysis, 151t
 equipment, 151f
 lower heating value (LHV), 152t
 open ponds, 150, 150f
- R**
- Raceway pond systems
 algal cultivation, 265, 265f
 biomass productivity and yield, 266
Chlorella, *Spirulina* and *D. salina*, 266
 description, 30–31, 265
 drawbacks, 31
 limitations, 266
- S**
- SC-CO₂. *See* Supercritical carbon dioxide extraction (SC-CO₂)
- Screening, algal biomass harvesting
 description, 90
 microstraining, 90–91
 vibrating screens, 91
- SEQHTL. *See* Sequential hydrothermal liquefaction (SEQHTL)
- Sequential hydrothermal liquefaction (SEQHTL), 253–254
- SIDS. *See* Sodium dodecyl sulfate (SIDS)
- Simple ponds, 30
- Sodium dodecyl sulfate (SIDS)
 poor algal removal, 99–100
 surfactants, 99–100
- Solid-bowl decanter centrifuges, 101–102
- Solid-ejecting disc centrifuge, 102
- Solix Lumian™, AGS4000 system, 36–40, 42f
- Spent biomass
 alga-based processing, 208t
 biofuel production, 207–211

- Spent biomass (*Continued*)
 bioremediation, 224–225
 feed, 225–226
 fine chemical production, 212–224
 macroalgae, 205–206
 secondary biofuel production, 207f
- Spirulina*
 definition, 7
 hormogonia, 7
 inhabitation medias, 7
 life cycle, 7
 morphology and taxonomy, 7
 supply of nutrients, 7
- Spirulina platensis*, CO₂ fixation
 habitats, 78
 optimum pH, 78
 proteins and potassium, 78
 Spirulina and *Arthrospira*, 77
- Stability and separability, microalgae
 AOM, 87–88
 cell dimensions, 89
 commercial polymers, 88
 description, 86–87
 destabilization and flocculation, 89
 DLVO theory, colloid stability, 88
 ionogenic functional groups, 88
 mechanisms, enhanced coagulation, 87
 NOM, 87
 settling velocity, planktonic algae, 88–89
 treatment methods, 87
- Sterols, 219–220
- Stirred-tank photobioreactors, 171
- Supercritical carbon dioxide extraction (SC-CO₂), 174
- T**
- TCC. *See* Thermochemical conversion (TCC)
- Temperature, open pond systems
 cell morphology and physiology, 11
 closed photobioreactors, 12
 high temperatures, 11–12
 raceway-type photobioreactors, 12
 solubility, O₂ and CO₂, 12
- Thermochemical conversion (TCC)
 liquefaction, 240
 product profile, 241f
 pyrolysis, 240
- Thickening
 algae cultivation, harvesting and processing, 86, 86f
 for microalgae, 89
- Transesterification process
 acid-catalyzed, 176–177
 alcohols, 175–176
 base-catalyzed, 177
 biodiesel, 175–176
 direct, 176
 enzyme-catalyzed, 177
 triacyl glycerides conversion, 176f
- U**
- Ultrasonic methods, algal biomass harvesting
 advantages, 104
 algae separation process, 103
 biofilter, 104
 coagulation, *Microcystis aeruginosa*, 104
 “nuclei” and “bubble crush” period, 104
- V**
- Vacuum filtration
 algal harvests with moisture contents, 95
 capital costs, 95
 eucalyptus and pine-rafts fibers, 95
 types, 95
- Vertical column photobioreactors
 airlift reactors, 32–33
 bubble column reactors, 32
 description, 31–32
 prospects and limitations, culture systems,
 31–32, 32f
 sparger’s design, 32
- Vertical tubular photobioreactors, 170
- Vibrating screens, 91
- Vinasse, 145
- W**
- Wastewater
 acid-rich effluents, fermentative hydrogen-producing
 reactor, 168
 biodiesel production, 167–168
 ecological water bodies, 167
 macro/micronutrients, 168
 microalgae, 167