

Random Structures in the retina

B. Cessac, Biovision team, INRIA, and Neuromod Institute
Sophia Antipolis, France



NeuroMod

1. The retina and its dynamics

2. Retinal waves

3. Retinal anticipation

The retina and its dynamics

The visual system

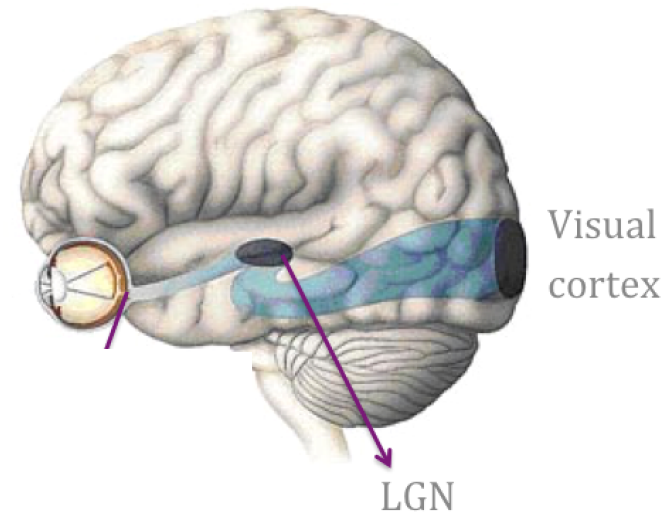

The visual system

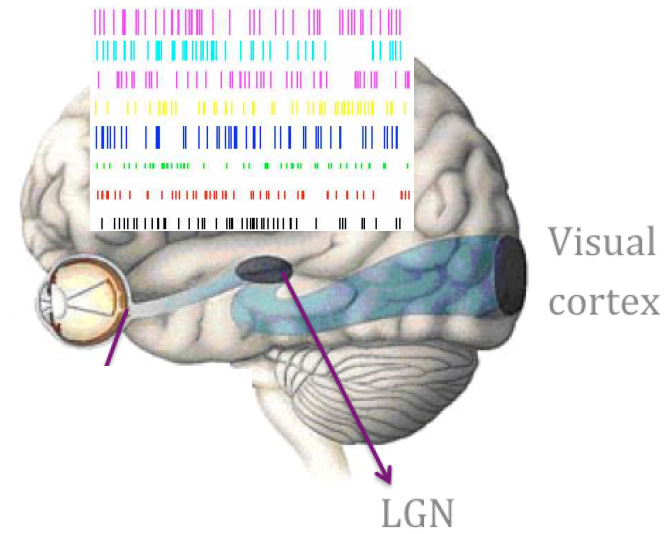

The visual system

Retina's layered structure

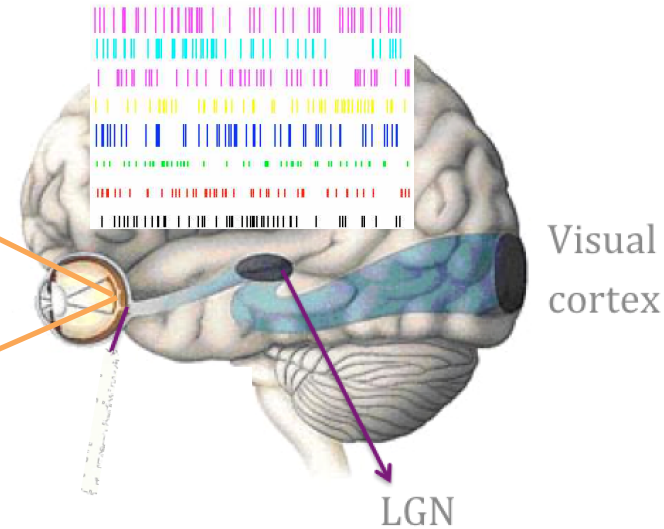
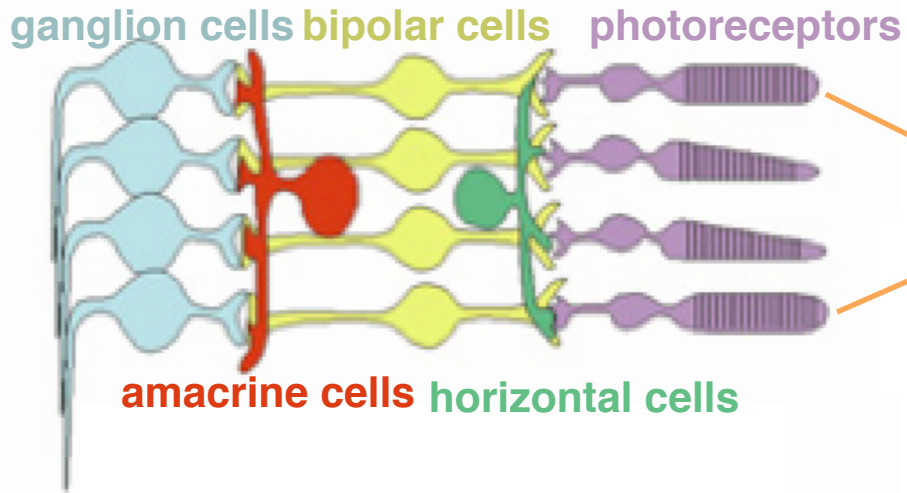

The visual system

Retina's layered structure

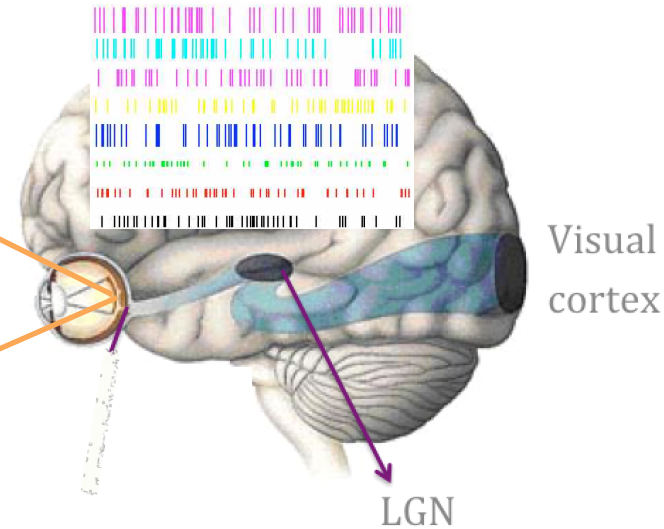
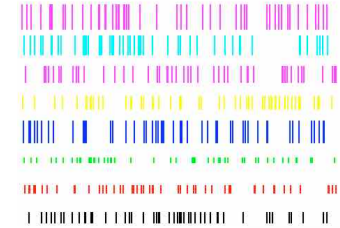
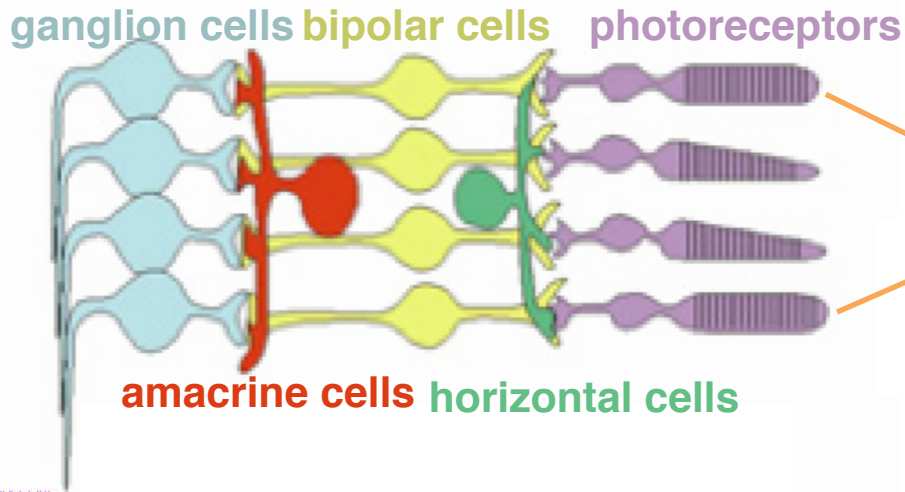

The visual system

Retina's layered structure

ganglion cells bipolar cells photoreceptors

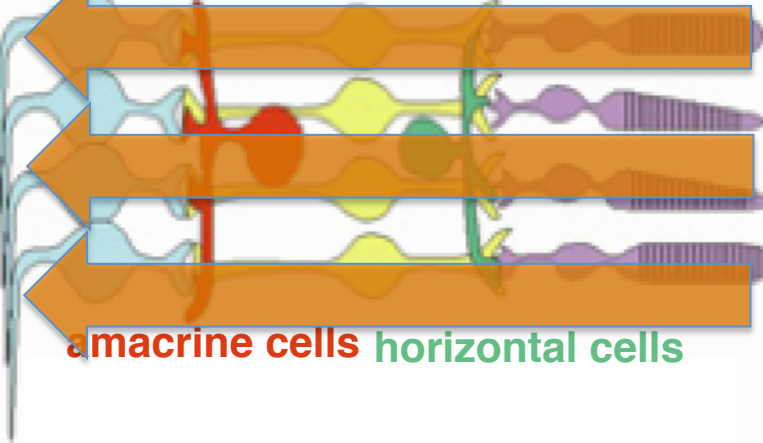
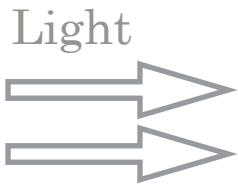

amacrine cells horizontal cells

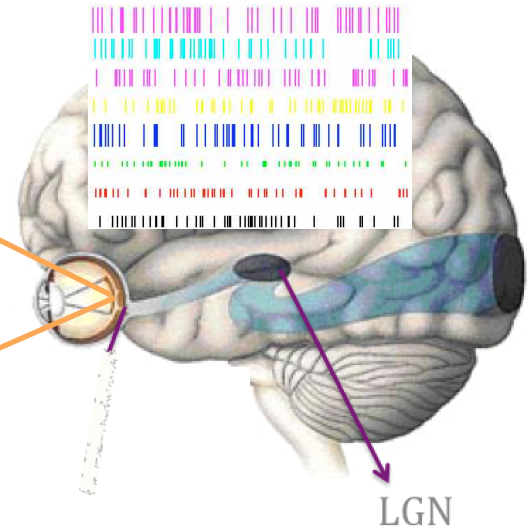

Visual cortex

LGN

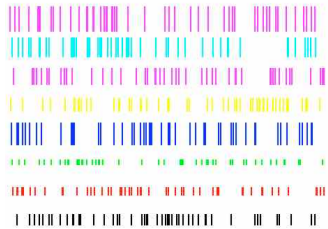

The visual system

Retina's layered structure

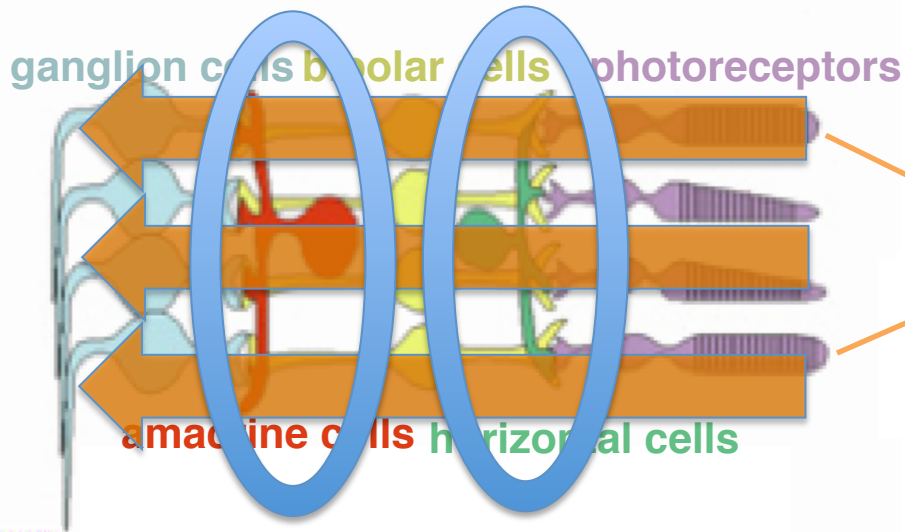

Light

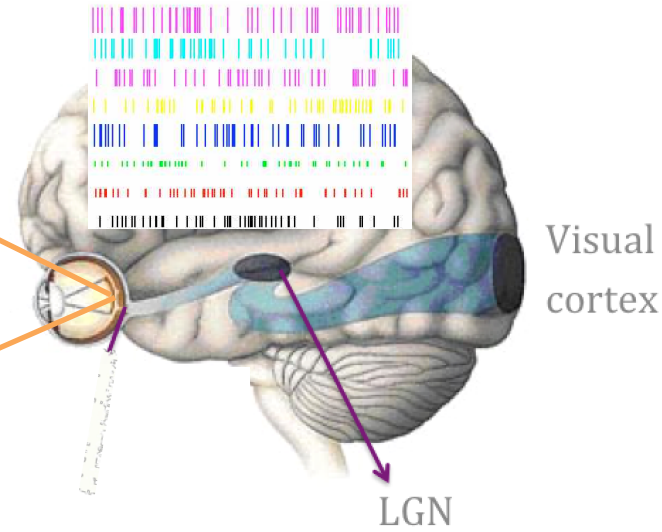
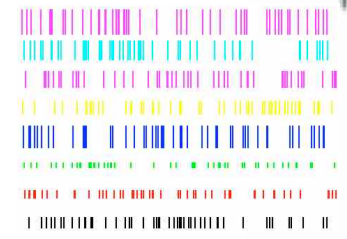

The visual system

Retina's layered structure

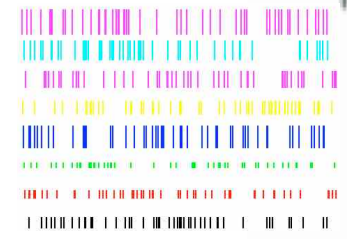
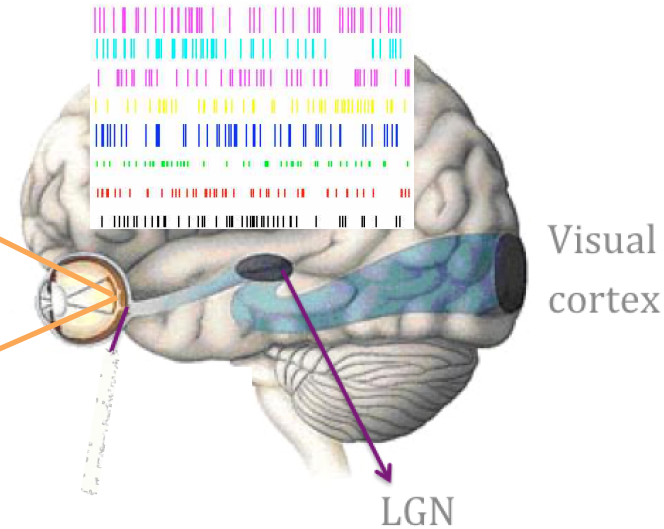
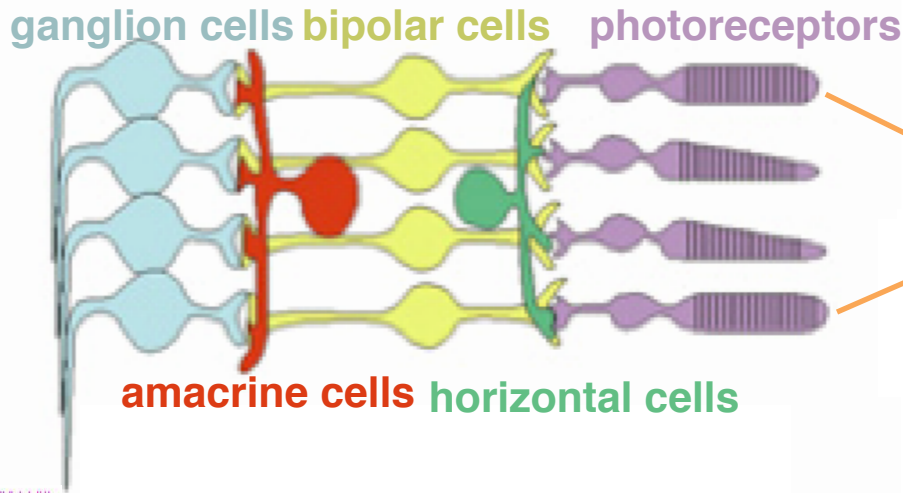

« Analogic computing »
No spikes (except in GCs)
Low energy consumption
Dedicated circuits
Small number of neurons
Specialized synapses

A modeller point of view

1. The retina is a ***high dimensional, non autonomous*** dynamical system, layered and structured, with ***non stationary and spatially inhomogeneous entries*** (visual scenes).

A modeller point of view

1. The retina is a ***high dimensional, non autonomous*** dynamical system, layered and structured, with ***non stationary and spatially inhomogeneous entries*** (visual scenes).
2. ***Local circuits*** of non linear cells, connected with non linear synapses efficiently process the ***local visual information***. These local circuits are connected together, spanning the whole retina in a ***regular tiling***.

A modeller point of view

1. The retina is a ***high dimensional, non autonomous*** dynamical system, layered and structured, with ***non stationary and spatially inhomogeneous entries*** (visual scenes).
2. ***Local circuits*** of non linear cells, connected with non linear synapses efficiently process the ***local visual information***. These local circuits are connected together, spanning the whole retina in a ***regular tiling***.
3. The conjunction of non linearities and regular structure can produce a highly ***disordered spatio-temporal*** dynamics.

A modeller point of view

1. The retina is a ***high dimensional, non autonomous*** dynamical system, layered and structured, with ***non stationary and spatially inhomogeneous entries*** (visual scenes).
2. ***Local circuits*** of non linear cells, connected with non linear synapses efficiently process the ***local visual information***. These local circuits are connected together, spanning the whole retina in a ***regular tiling***.
3. The conjunction of non linearities and regular structure can produce a highly ***disordered spatio-temporal*** dynamics.
4. The retina is sensitive to ***changes in its physiology*** (development, pharmacology, pathologies). These changes can be addressed from the point of view of ***bifurcations theory***.

Retinal waves

Random structures as high dimensional spatio-temporal chaos.

D. Karvouniari (PhD 2014-2018), Biovision team, INRIA, Sophia Antipolis

L. Gil, INLN, Sophia Antipolis

O. Marre, Institut de la Vision, Paris

S. Picaud, Institut de la Vision, Paris

B. Cessac, Biovision team, INRIA, Sophia Antipolis

Acknowledgement: M. Hennig, E. Sernagor.

The structure of the adult retina

Retina's layered structure

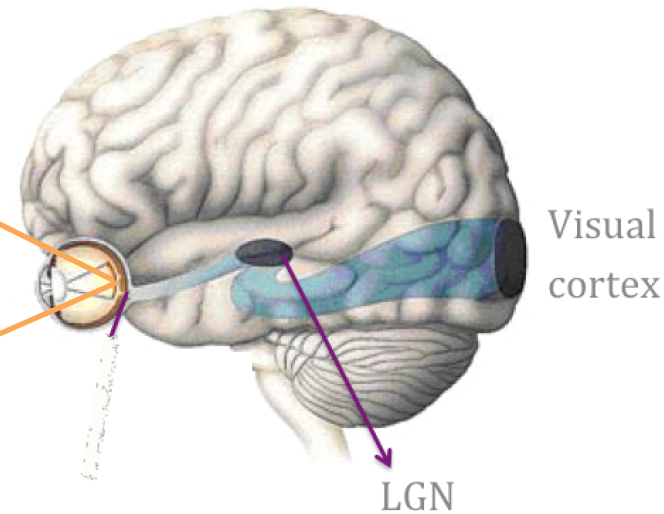
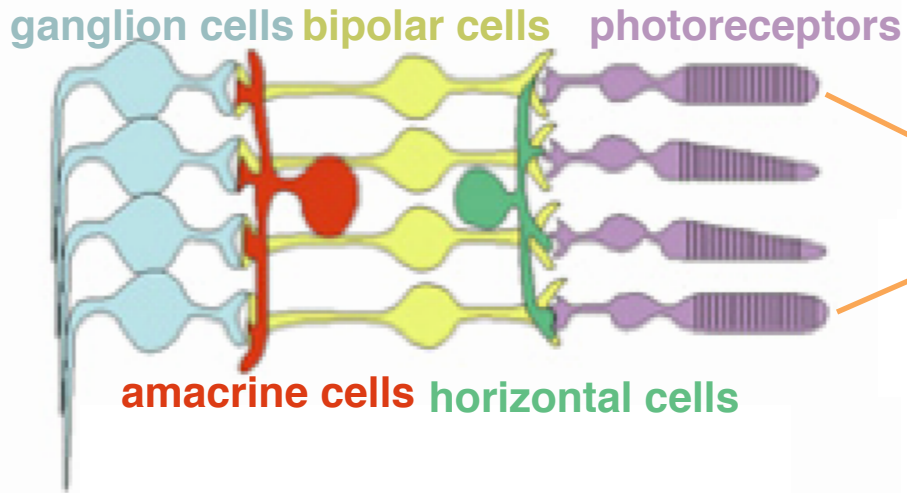

The structure of the retina during development

Retina's layered structure
is shaped during development

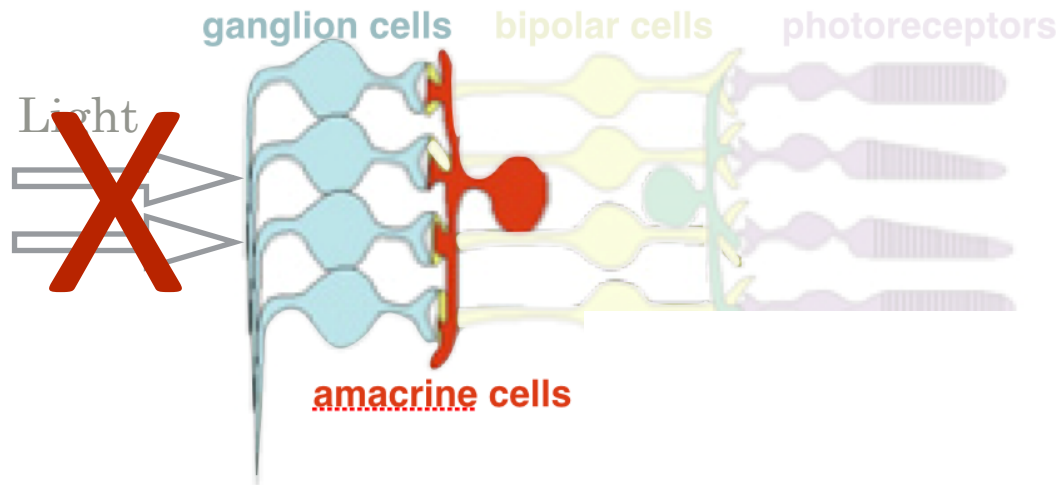

But How?



Retinal waves!

Retinal waves

Spontaneous spatio-temporal waves during development
Disappear short after birth
when vision is functional

Recordings from the retina

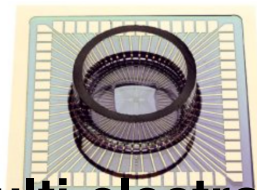
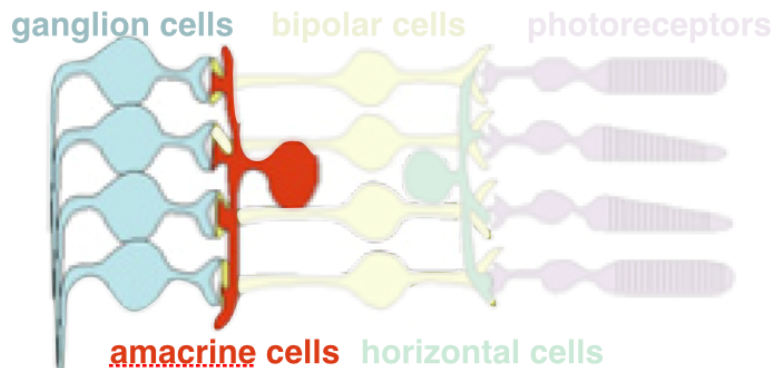

**Multi-electrode
array
(MEA)**

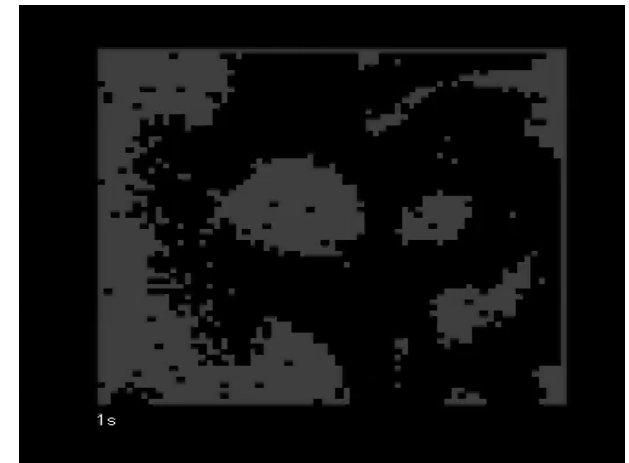

*MEA recording of the voltage from
a mouse retina (courtesy E
Sernagor).*

Stages of Retinal Waves During Development

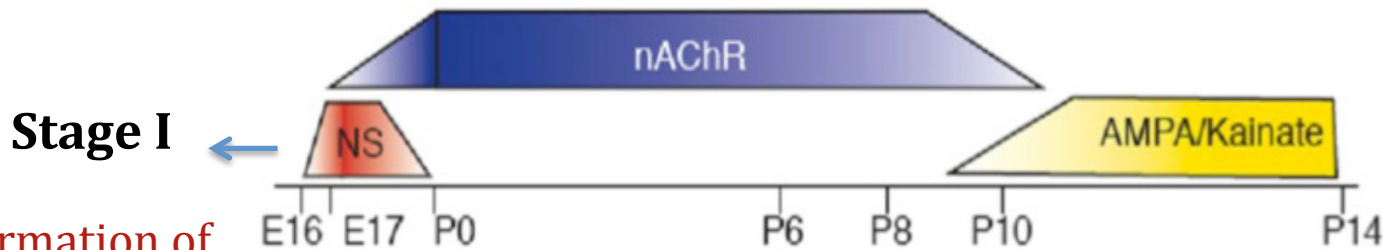

- Formation of retina circuitry
- Chemical synapses not formed yet
- Gap junction-mediated

Stages of Retinal Waves During Development

Stage II

- Retinotopic mapping
- Nicotinic Acetylcholine Receptors (nAChR)

Stage I

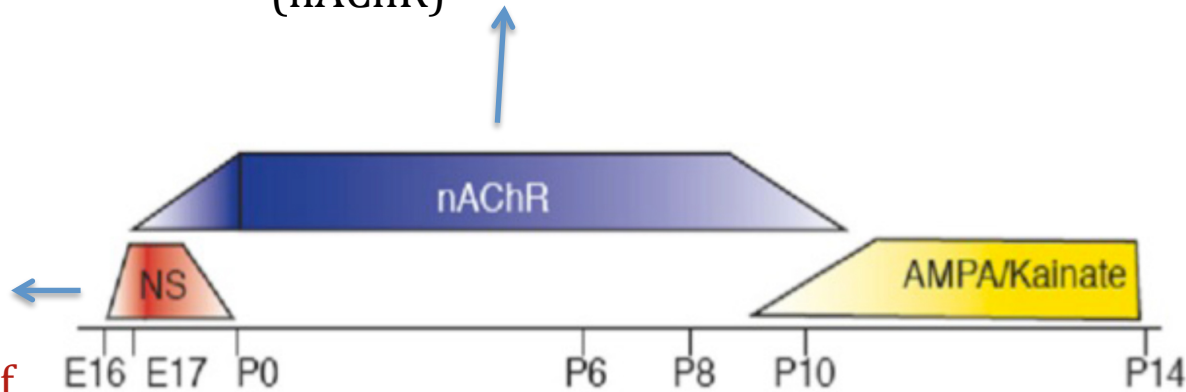

- Formation of retina circuitry
- Chemical synapses not formed yet
- Gap junction-mediated

Stages of Retinal Waves During Development

Stage II

- Retinotopic mapping
- Nicotinic Acetylcholine Receptors (nAChR)

Stage III

- Disappear when vision is functional
- Glutamate – AMPA receptors

Stage I

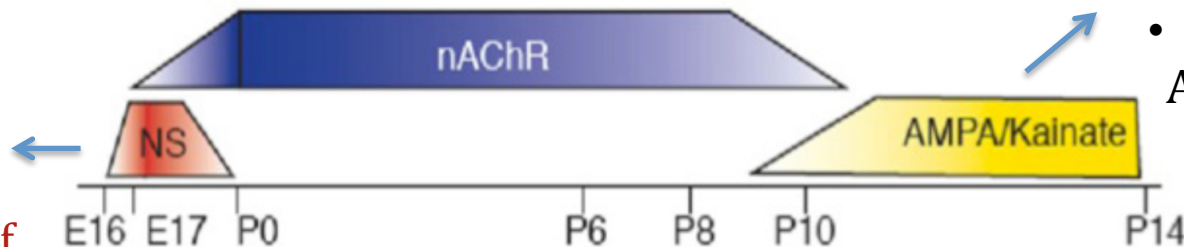

- Formation of retina circuitry
- Chemical synapses not formed yet
- Gap junction-mediated

Variability within retinal waves

i) Across species

Godfrey et al. 2007

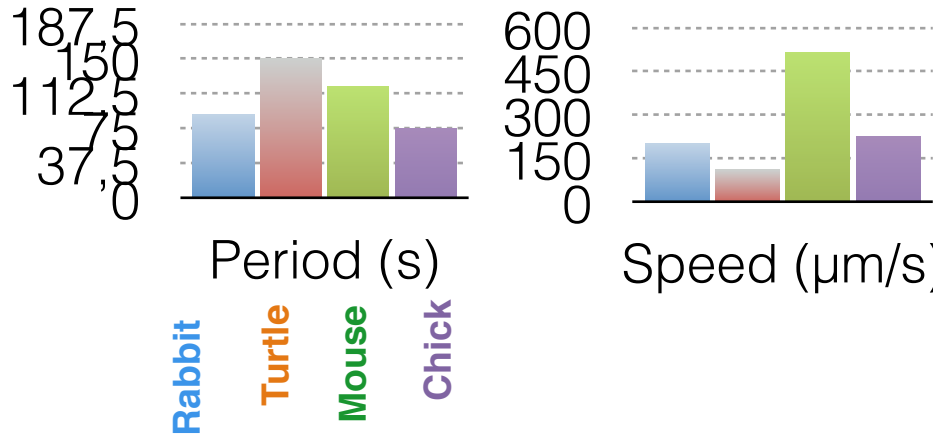

Variability within retinal waves

i) Across species

Godfrey et al. 2007

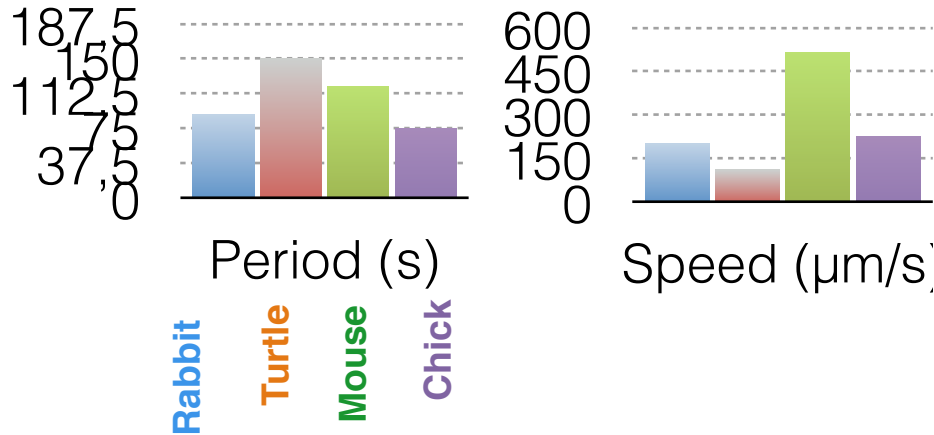

ii) Development

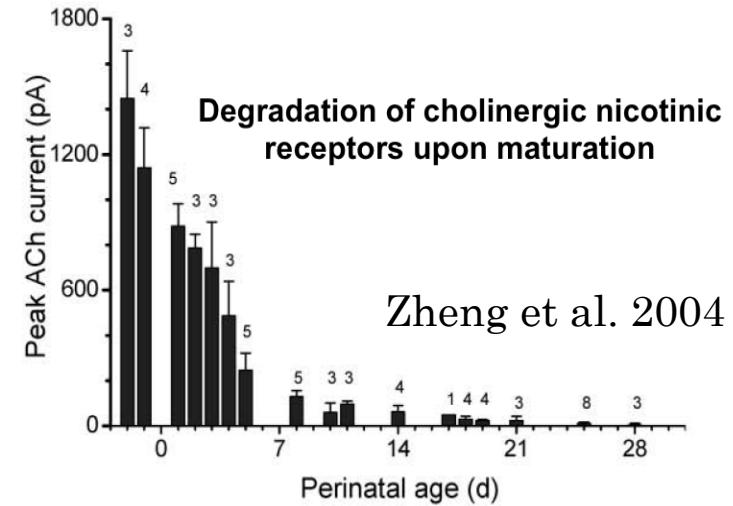

Variability within retinal waves

i) Across species

Godfrey et al. 2007

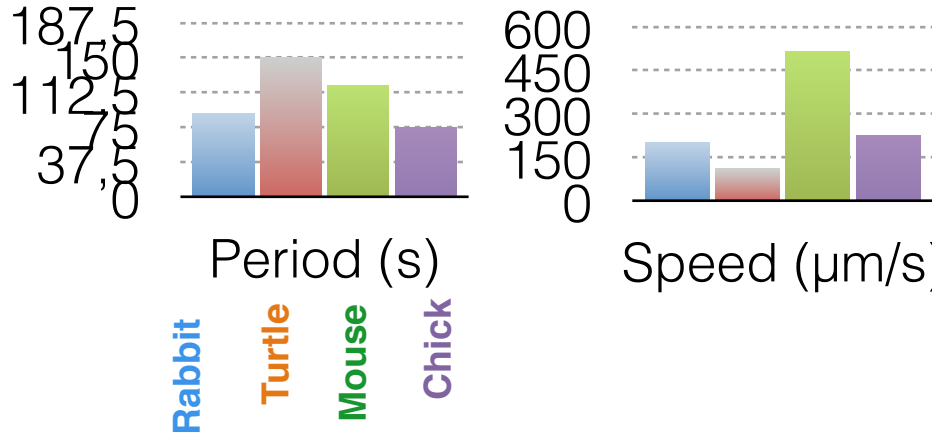

ii) Development

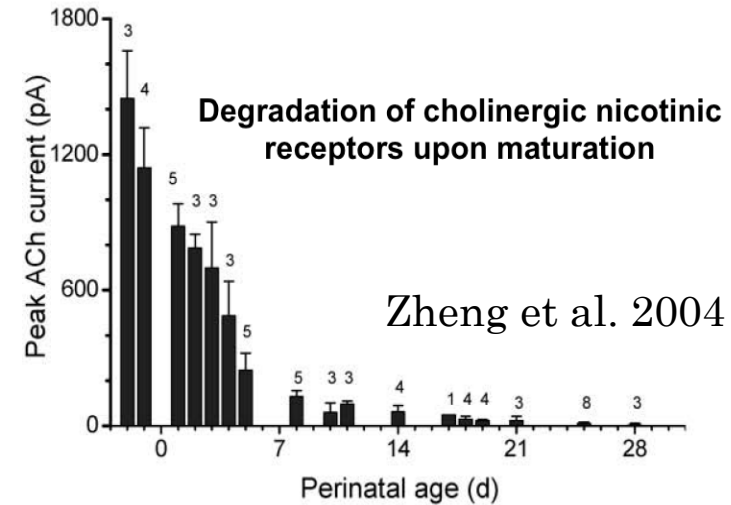

iii) Pharmacology

P4

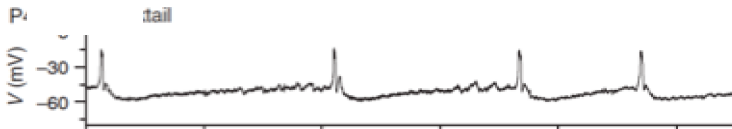

P8



0 Time (sec) 50

Variability within retinal waves

i) Across species

Godfrey et al. 2007

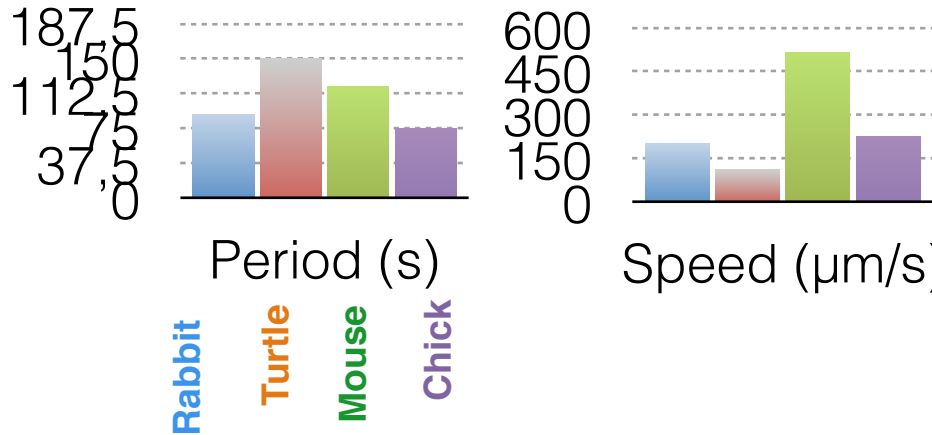

ii) Development

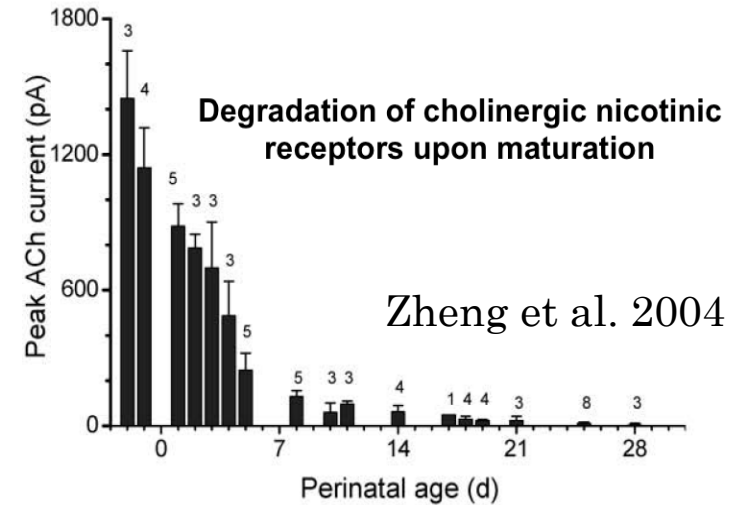

iii) Pharmacology

P4

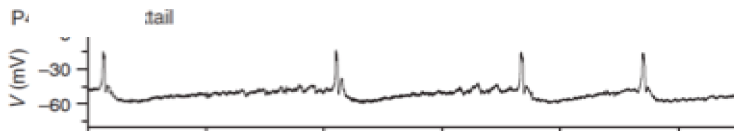

P8

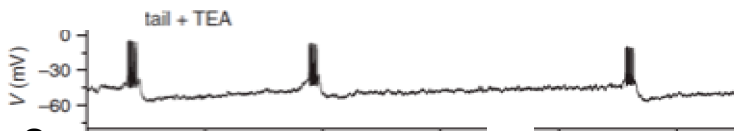
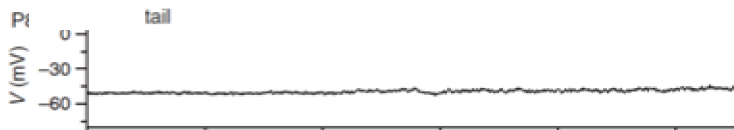

0 Time (sec) 50

iv) Spatial Variability

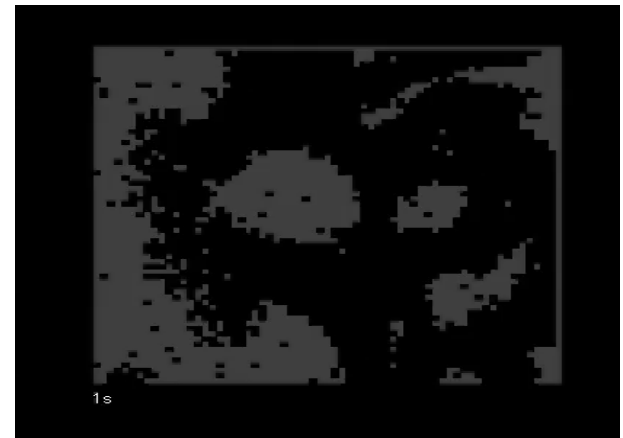

Variability within retinal waves

i) Across species

Godfrey et al. 2007

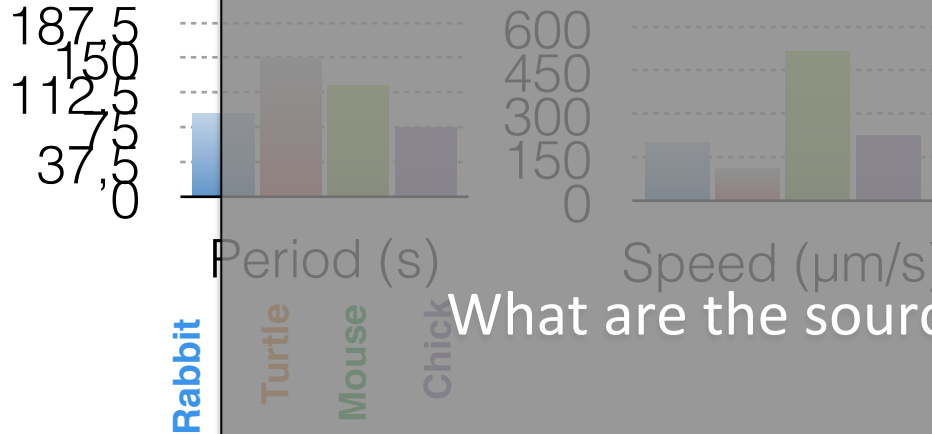

ii) Development

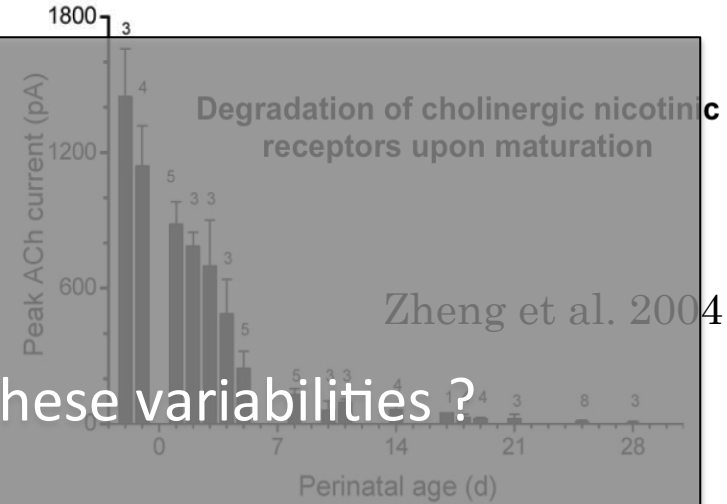

What are the sources of these variabilities?

Is there a unique, global, mechanism explaining them?

iii) Pharmacology

P4



P8

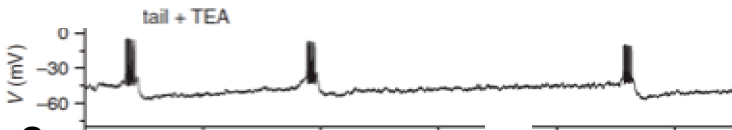

0 Time (sec) 50

iv) Spatial Variability

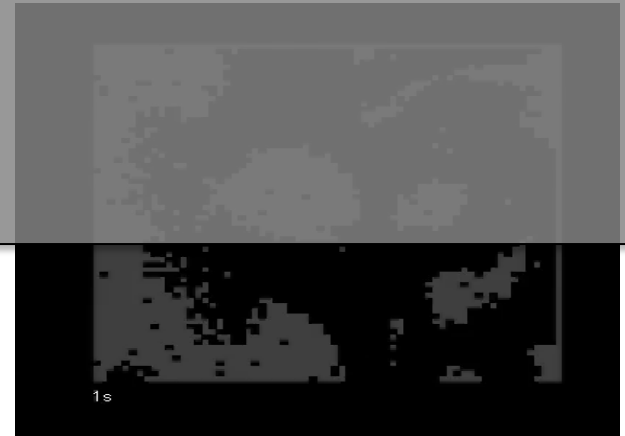

Focus on stage II retinal waves

Stage II retinal waves are well studied experimentally and there is already existing work on their modeling

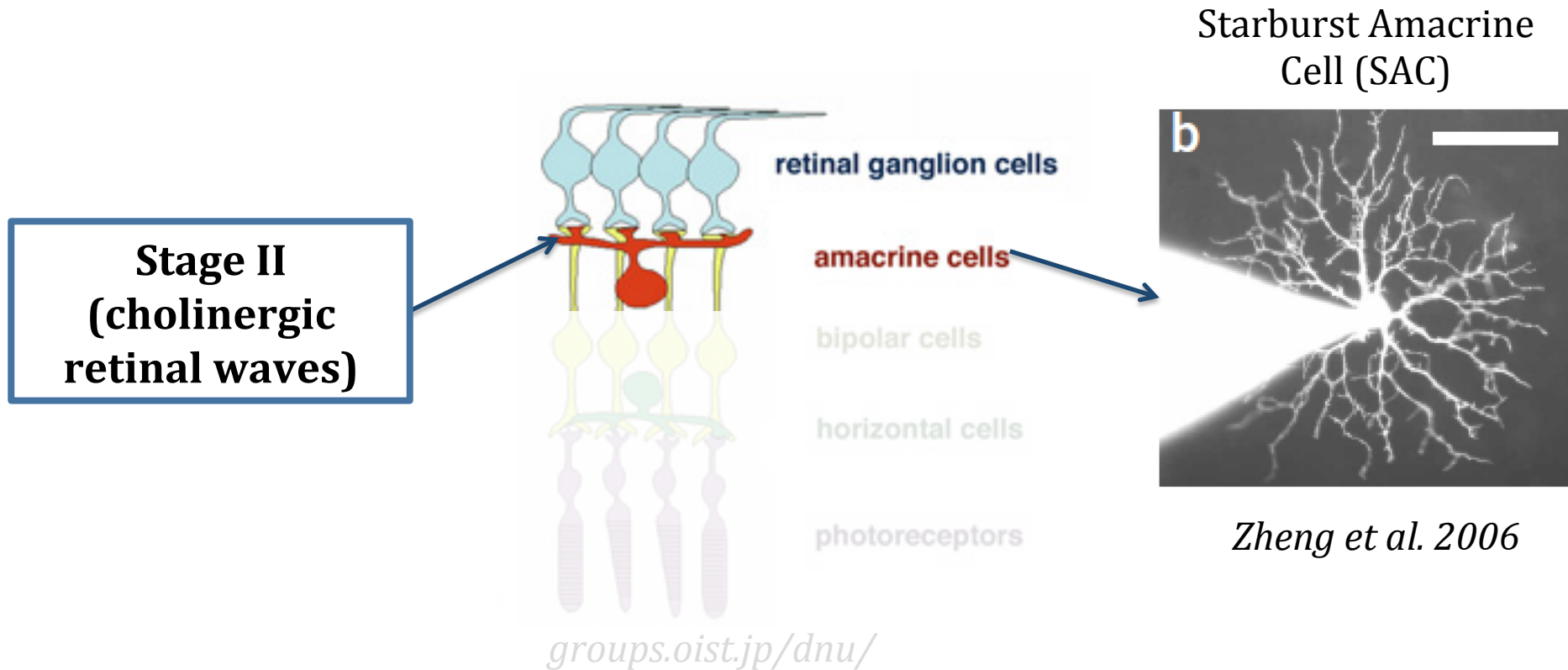

Experiments for the emergence of retinal waves

Retinal waves require three components:

- i) Spontaneous bursting activity

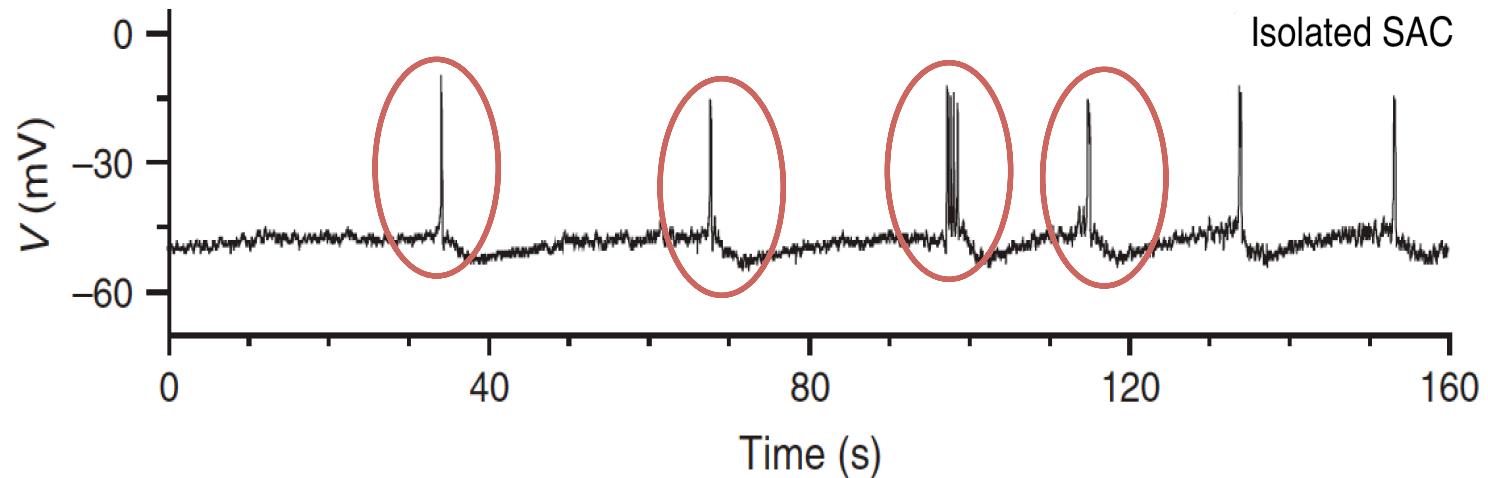

Experiment for isolated neurons,
Zheng et al., 2006, Nature

Experiments for the emergence of retinal waves

Retinal waves require three components:

- i) Spontaneous bursting activity
- ii) Refractory mechanism (slow After HyperPolarisation- sAHP)

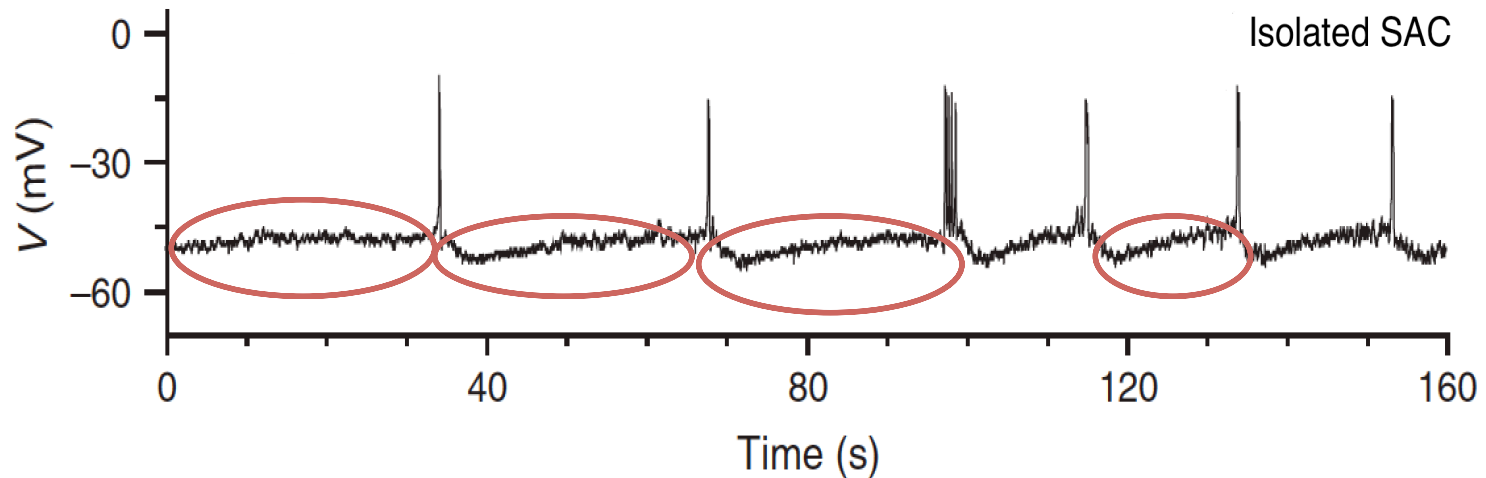

Experiment for isolated neurons,
Zheng et al., 2006, Nature

Experiments for the emergence of retinal waves

Retinal waves require three components:

- i) Spontaneous bursting activity
- ii) Refractory mechanism (slow After HyperPolarisation- sAHP)
- iii) Coupling (through Acetylcholine neurotransmitter)

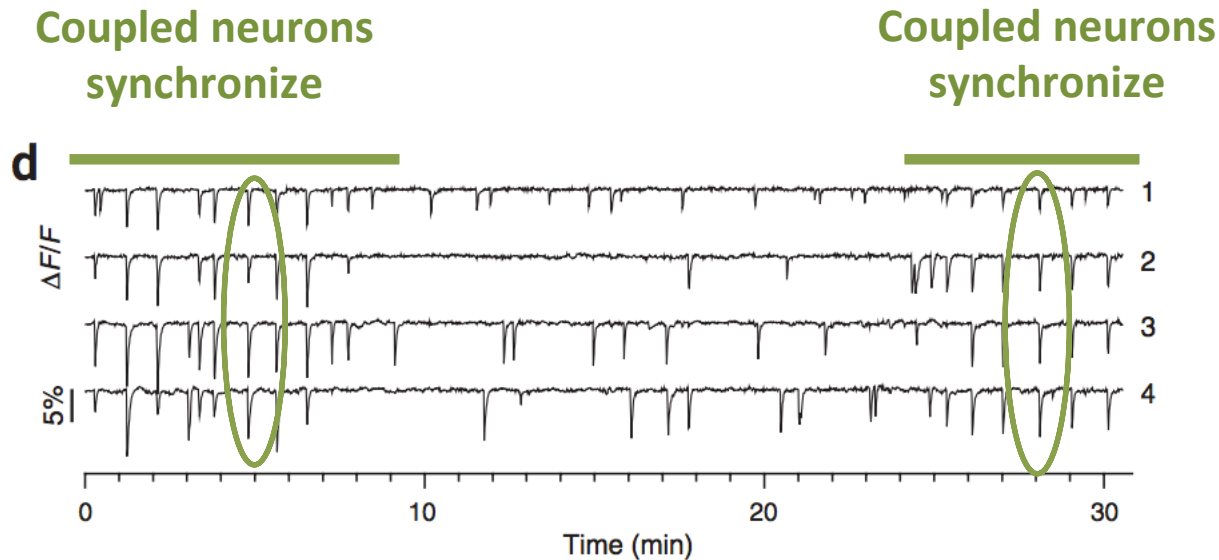

Experiment for coupled and isolated neurons, Zheng et al., 2006, Nature

Experiments for the emergence of retinal waves

Retinal waves require three components:

- i) Spontaneous bursting activity
- ii) Refractory mechanism (slow After HyperPolarisation- sAHP)
- iii) Coupling (through Acetylcholine neurotransmitter)

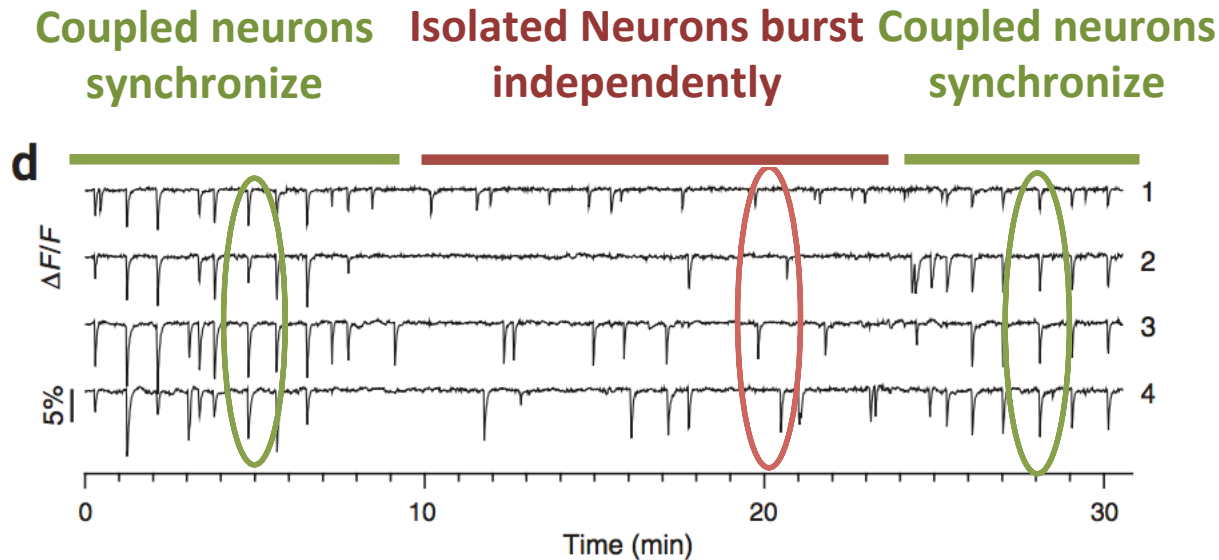

Experiment for coupled and isolated neurons, Zheng et al., 2006, Nature

Experiments for the emergence of retinal waves

Retinal waves require three components:

Several models of stage II retinal waves have been proposed already:

ii) Refractory mechanism (slow After HyperPolarisation- sAHP)

iii) Coupling (through Acetylcholine neurotransmitter)

- Feller et al, Neuron, 1997.
- Eglon et al, J. Neuroscience 2000.
- Godfrey & Swindale. PLoS Comput Biol, 2007.
- Hennig et al, J. Neuroscience, 2009
- Lansdell et al, PLoS Computational Biology, 2014.

But none of them as studied simultaneously these 3 aspects:

- (i) realistic model of spontaneous bursting
- (ii) sAHP biophysical modelling
- (iii) realistic Ach interaction.

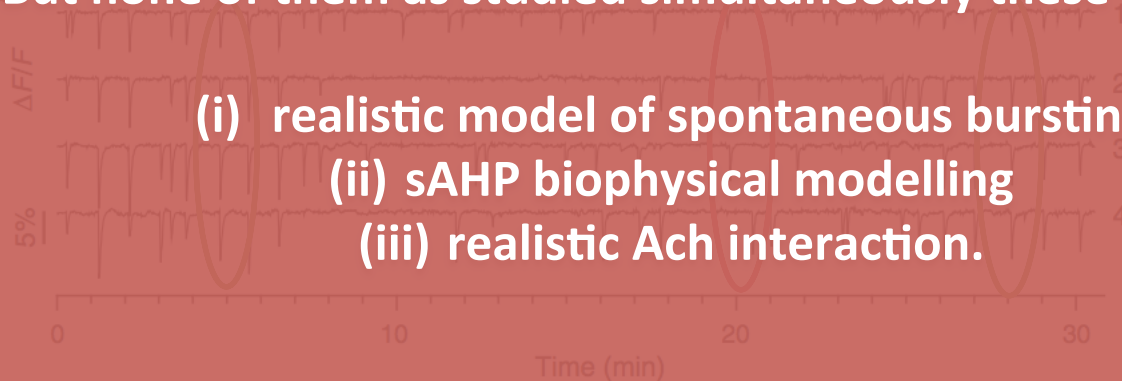

Experiment for coupled and isolated neurons, Zheng et al., 2006, Nature

A network model for stage II retinal waves

A network model for stage II retinal waves

Membrane potential dynamics

$$C_m \frac{\partial V}{\partial t} = -g_L^M(V - V_L) - g_{Ca}(V)(V - V_{Ca}) - g_K N(V - V_K)$$

$$\tau_N \frac{\partial N}{\partial t} = \Lambda(V)(N_\infty(V) - N)$$

**Morris-Lecar &
Fast K⁺ channels**

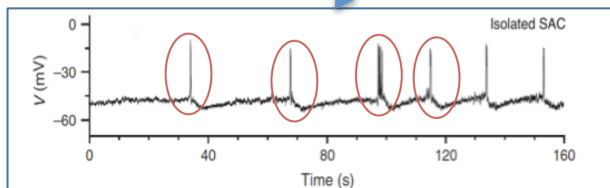

A network model for stage II retinal waves

Membrane potential dynamics

$$C_m \frac{\partial V_i}{\partial t} = -g_L^M (V_i - V_L) - g_{Ca} (V_i) (V_i - V_{Ca}) - g_K N_i (V_i - V_K) - g_{sAHP} R_i^4 (V_i - V_K)$$

$$\tau_N \frac{\partial N}{\partial t} = \Lambda(V) (N_\infty(V) - N)$$

**Morris-Lecar &
Fast K⁺ channels**

**sAHP current
Refractory
mechanism**

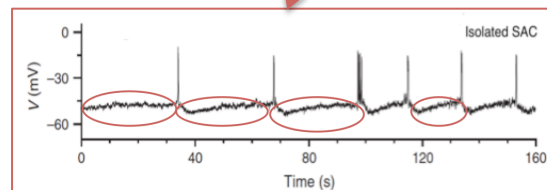
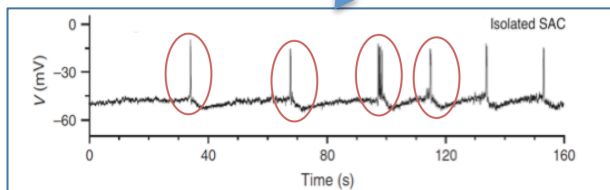

sAHP current

- **Definition**
 - Slow After Hyperpolarisation Current
 - Calcium-dependent slow potassium channels
- **Mechanism**
 - Model SK-like channels (Abel et al. 2004)
 - Gating Mechanism: **Four** ions Ca^{2+} bind to Calmodulin (CaM)

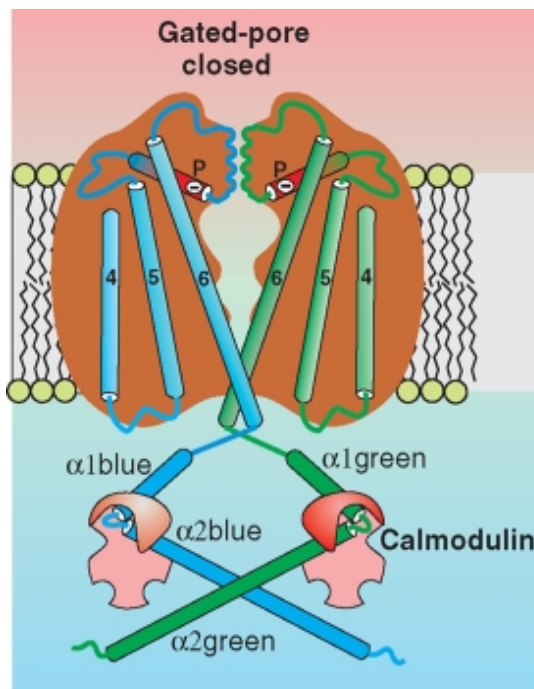

Closed

Ca^{2+}
➔

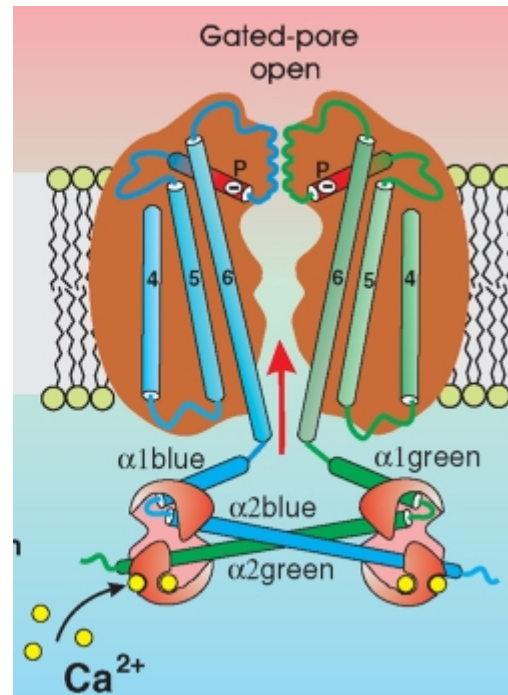

Open

*Calcium gated
potassium
channel*

*superhimik.livejournal.
com/*

sAHP current

- Four Ca^{2+} ions bound to calmodulin open the channel
- I_{sAHP} current depends on gating variable R as follows:

$$I_{sAHP} = g_{sAHP}^m R^4 (V - V_K) \quad (\text{Hennig et al. 2009})$$

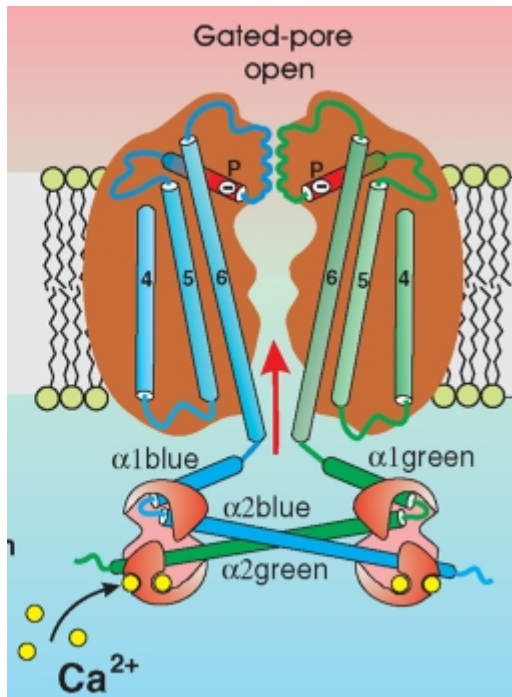

The conductance is proportional to the fourth power of R because four terminals are needed to open the channel.

superhimik.livejournal.com/

Set of equations for sAHP current

Activated Ca-gated K⁺ channel

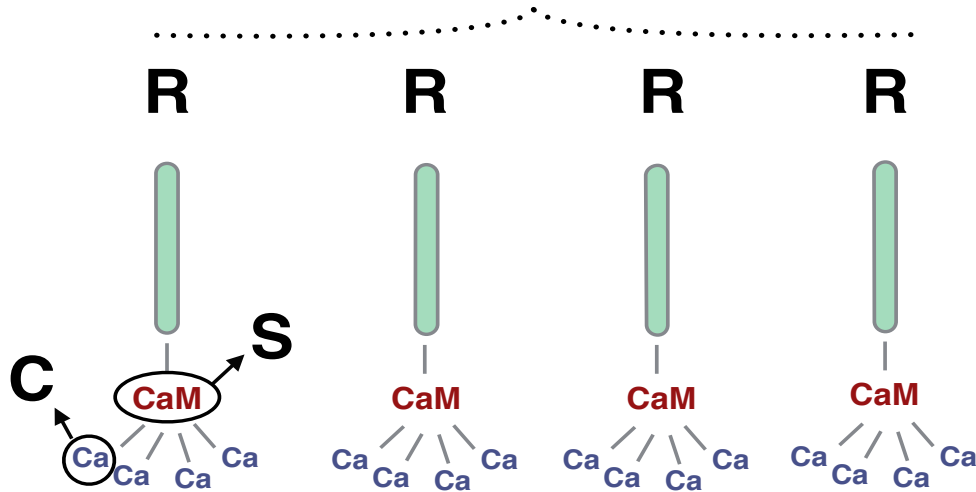

Gating mechanism

All 4 subunits R of the channel are bound to activate the channel



Saturated Calmodulin molecule (CaM) bind to each channel subunit



4 Calcium ions bound to each saturated Calmodulin complex S

Set of equations for sAHP current

Activated
Ca-gated K⁺ channel

$$\tau_R \frac{dR}{dt} = a_R S(1 - R) - R$$

R : Probability that one terminal of the channel is open

$$\tau_S \frac{dS}{dt} = -S + a_S C^4(1 - S)$$

S : Fraction of saturated calmodulin concentration (CaM)

$$\tau_{Ca} \frac{dC}{dt} = -a_R \frac{C}{H_x} + C_o + \delta_{Ca} I_{Ca}(V)$$

C : Intracellular Calcium concentration

SACs Network

Model synaptic interactions

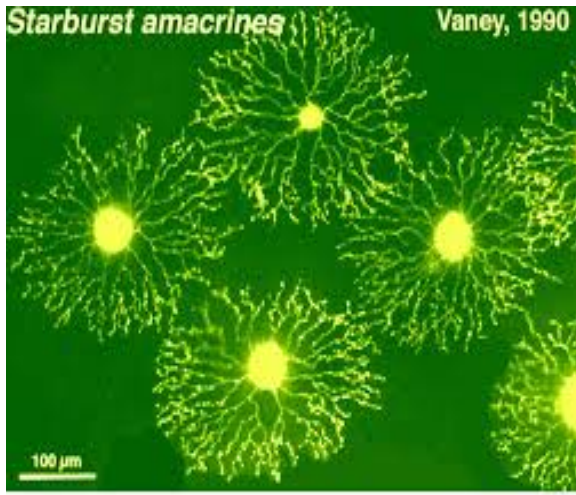
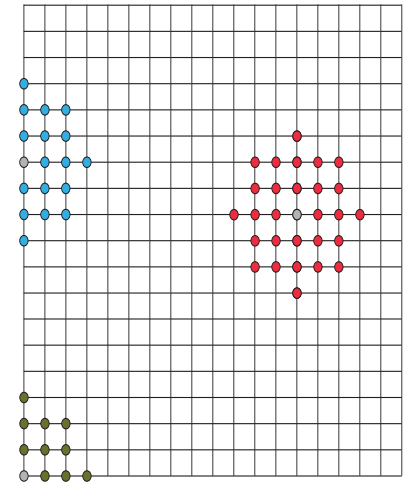
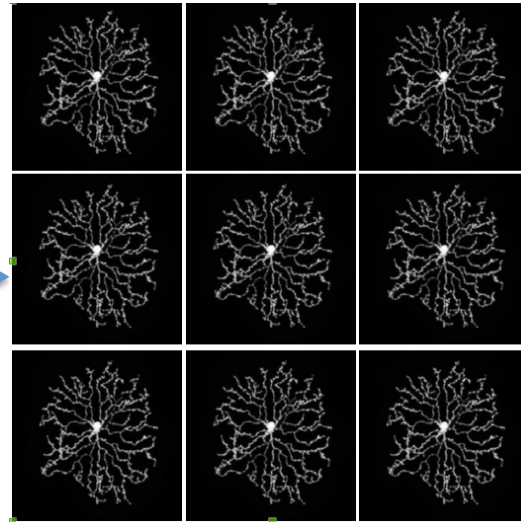

Fig 7. Starburst amacrine cells are stained with Lucifer yellow in whole-mount rabbit retina.



SACs realistic connections

SACs on a lattice

SACs become points on a lattice

Acetylcholine current

- Molecular nicotinic receptors (nAChR)
- Two molecules of acetylcholine bind to open a nicotinic channel
- The nicotinic conductance depends on the second power of the acetylcholine neurotransmitter concentration A

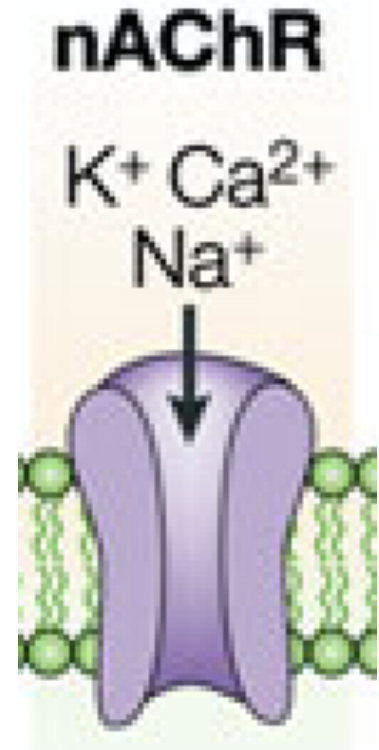

$$g_{ACh} = g_{ACh}^m \frac{A^2}{K_d^2 + A^2}$$

A network model for stage II retinal waves

Membrane potential dynamics

$$C_m \frac{\partial V_i}{\partial t} = -g_L^M (V_i - V_L) - g_{Ca} (V_i) (V_i - V_{Ca}) - g_K N_i (V_i - V_K) - g_{sAHP} R_i^4 (V_i - V_K) - \sum_j g_{j,Ach} (A_j) (V_i - V_{Ach})$$

$$\tau_N \frac{\partial N}{\partial t} = \Lambda(V) (N_\infty(V) - N)$$

**Morris-Lecar &
Fast K⁺ channels**

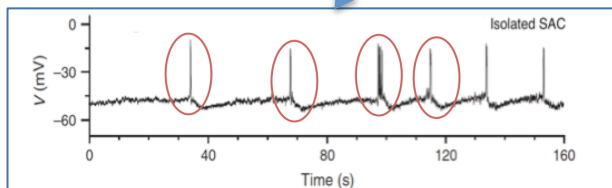

**sAHP current
Refractory
mechanism**

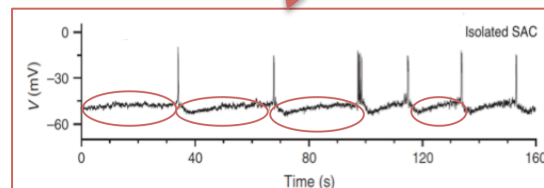

**Ach current
Network
effect**

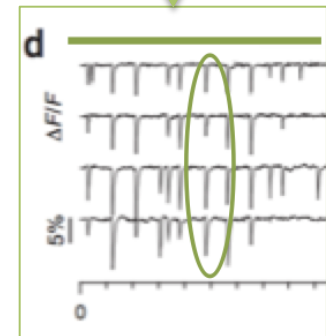

A network model for stage II retinal waves

$$\left\{ \begin{array}{l} C_m \frac{dV_i}{dt} = -g_L(V_i - V_L) - g_C M_\infty(V_i)(V_i - V_C) - g_K N_i(V_i - V_K) \\ \quad - G_{sAHP}(R_i)(V_i - V_K) - G_A(\{A_k\}_{k \in \mathcal{B}_i})(V_i - V_A) \\ \\ \tau_N \frac{dN_i}{dt} = \Lambda(V_i)(N_\infty(V_i) - N_i) \\ \\ \tau_C \frac{dC_i}{dt} = -\frac{\alpha_C}{H_X} C_i + C_0 - \delta_C g_C M_\infty(V_i)(V_i - V_C) \\ \\ \tau_S \frac{dS_i}{dt} = \alpha_S(1 - S_i)C_i^4 - S_i \\ \\ \tau_R \frac{dR_i}{dt} = \alpha_R S_i(1 - R_i) - R_i \\ \\ \frac{dA_i}{dt} = -\mu A_i + \beta_A T_A(V_i), \end{array} \right.$$

A network model for stage II retinal waves

N neurons, 6 N equations

$$\left\{ \begin{array}{l}
 C_m \frac{dV_i}{dt} = -g_L(V_i - V_L) - g_C M_\infty(V_i)(V_i - V_C) - g_K N_i(V_i - V_K) \\
 \quad - G_{SAPD}(R_i)(V_i - V_K) - G_A(\{A_k\}_{k \in \mathcal{N}})(V_i - V_A) \\
 \tau_N \frac{dN_i}{dt} = \Lambda(V_i)(N_\infty(V_i) - N_i) \\
 \tau_C \frac{dC_i}{dt} = -\frac{\alpha_C}{H_X} C_i + C_0 - \delta_C g_C M_\infty(V_i)(V_i - V_C) \\
 \tau_S \frac{dS_i}{dt} = \alpha_S(1 - S_i)C_i^4 - S_i \\
 \tau_R \frac{dR_i}{dt} = \alpha_R S_i(1 - R_i) - R_i \\
 \frac{dA_i}{dt} = -\mu A_i + \beta_A T_A(V_i),
 \end{array} \right.$$

~ 20 parameters per neuron
(But neurons are assumed identical)

A network model for stage II retinal waves

N neurons, 6 N equations

$$\left\{ \begin{array}{l} C_m \frac{dV_i}{dt} = -g_L(V_i - V_L) - g_C M_\infty(V_i)(V_i - V_C) - g_K N_i(V_i - V_K) \\ \quad - G_{SHP}(R_i)(V_i - V_K) - G_A(\{A_k\}_{k \in \mathcal{N}})(V_i - V_A) \\ \tau_N \frac{dN_i}{dt} = \Lambda(V_i)(N_\infty(V_i) - N_i) \\ \tau_C \frac{dC_i}{dt} = -\frac{\alpha_C}{H_X} C_i + C_0 - \delta_C g_C M_\infty(V_i)(V_i - V_C) \\ \tau_S \frac{dS_i}{dt} = \alpha_S(1 - S_i)C_i^4 - S_i \\ \tau_R \frac{dR_i}{dt} = \dots \\ \frac{dA_i}{dt} = \dots \end{array} \right.$$

~ 20 parameters per neuron

(But neurons are assumed identical)

Time scale separation

- Fast** V, N . $\tau_L = 11$ ms, $\tau_N = 5$ ms.
- Medium** C, A . $\tau_C = 2$ s, $\tau_A = 1.86$ s.
- Slow** S, R . $\tau_R = \tau_S = 44$ s.

Fast time scale

Fast time scale

Morris-Lecar model with fast dynamics, in the presence of a slow external current

$$\begin{cases} \frac{dV}{dt_f} = -\tilde{g}_L(V - V_L) - \tilde{g}_C M_\infty(V)(V - V_C) - \tilde{g}_K N(V - V_K) + I_{\text{ext}} \\ \frac{dN}{dt_f} = \frac{\tau_L}{\tau_N} \Lambda(V)(N_\infty(V) - N) \end{cases}$$

Fast time scale

Morris-Lecar model with fast dynamics, in the presence of a slow external current

$$\left\{ \begin{aligned} \frac{dV}{dt_f} &= -\tilde{g}_L(V - V_L) - \tilde{g}_C M_\infty(V)(V - V_C) - \tilde{g}_K N(V - V_K) + I_{ext} \\ \frac{dN}{dt_f} &= \frac{\tau_L}{\tau_N} \Lambda(V)(N_\infty(V) - N) \end{aligned} \right.$$

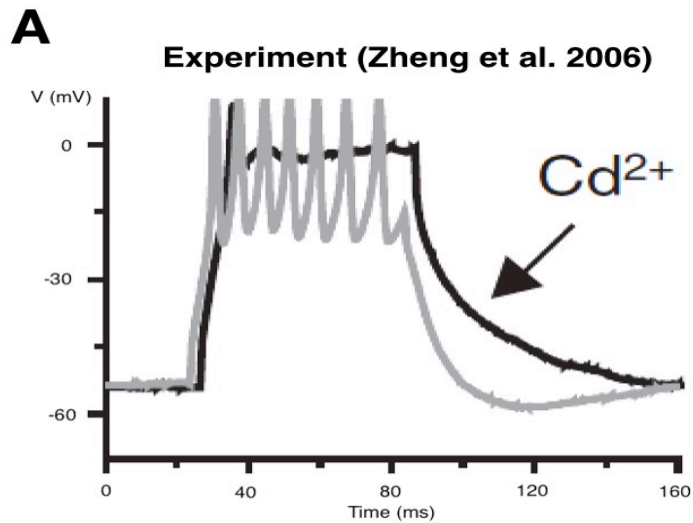

Experiment by Zheng et al. 2006,
Nature

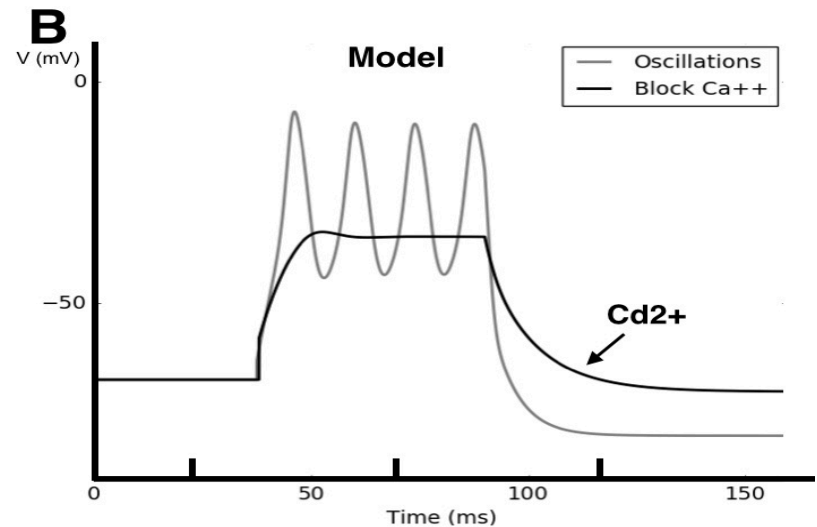

Model. Tuning parameters V_1, V_2, V_3, V_4 from ML adjusted to reproduce the experiment

Bifurcation diagram of M-L model

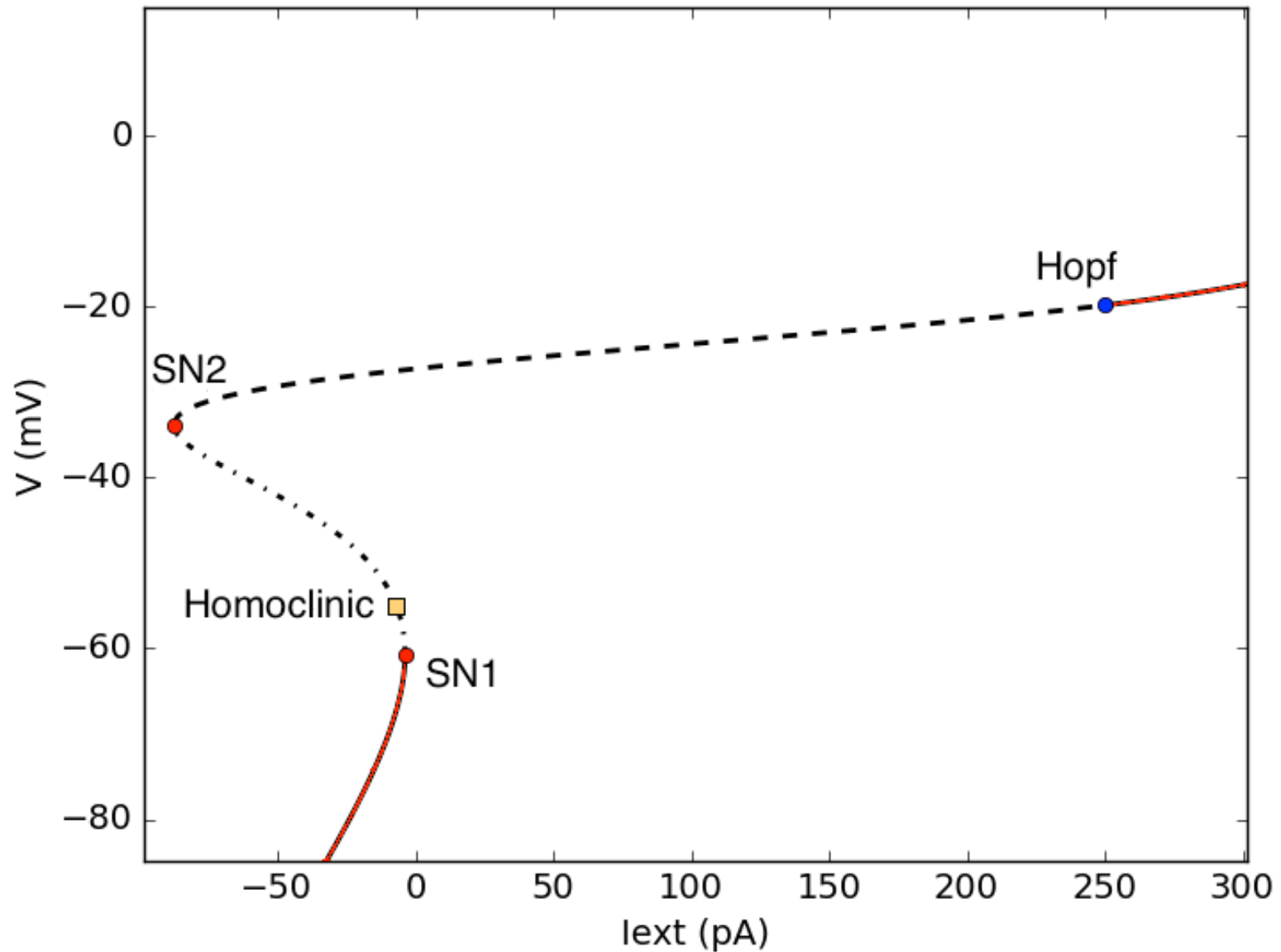

Bifurcation diagram of M-L model

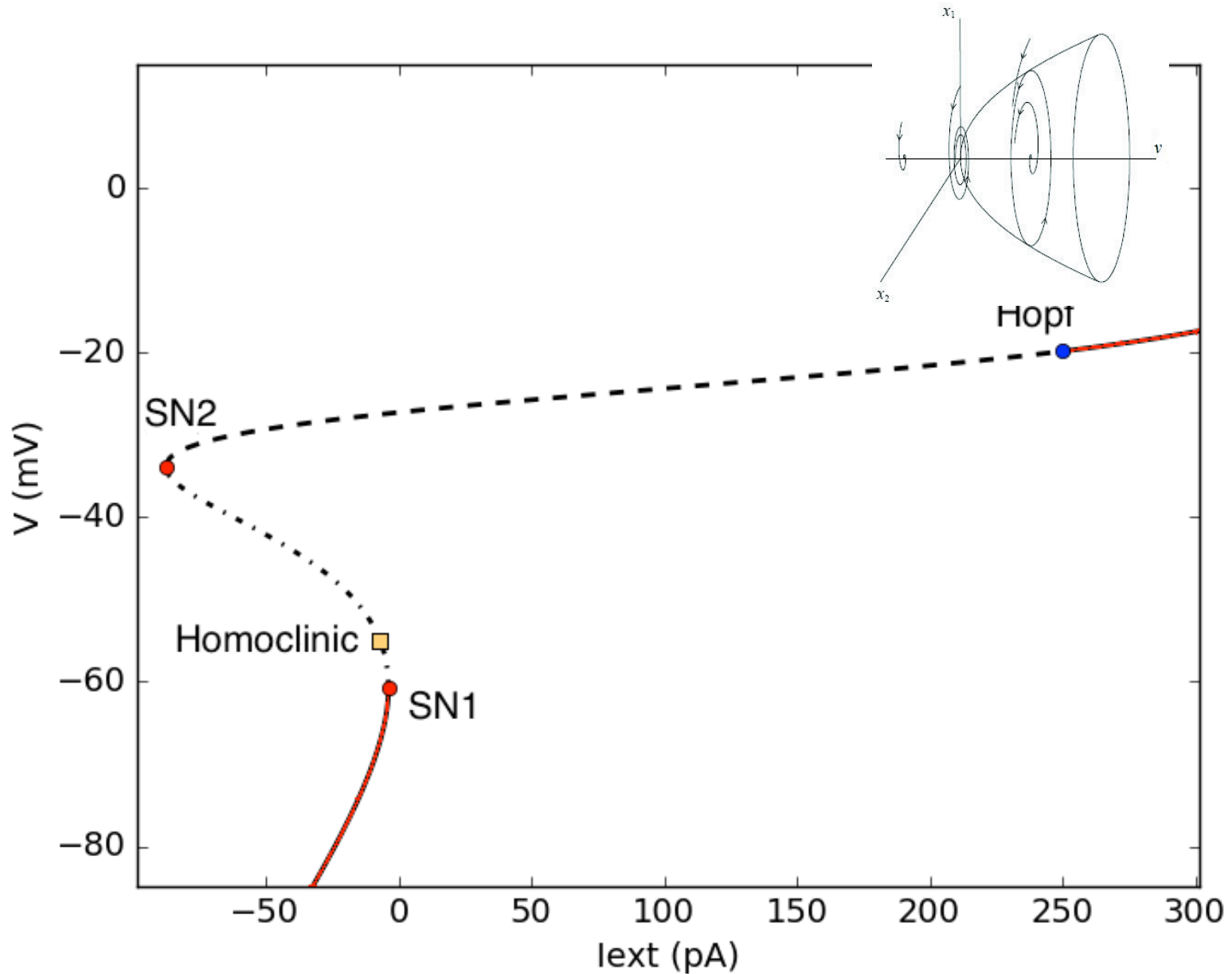

Bifurcation diagram of M-L model

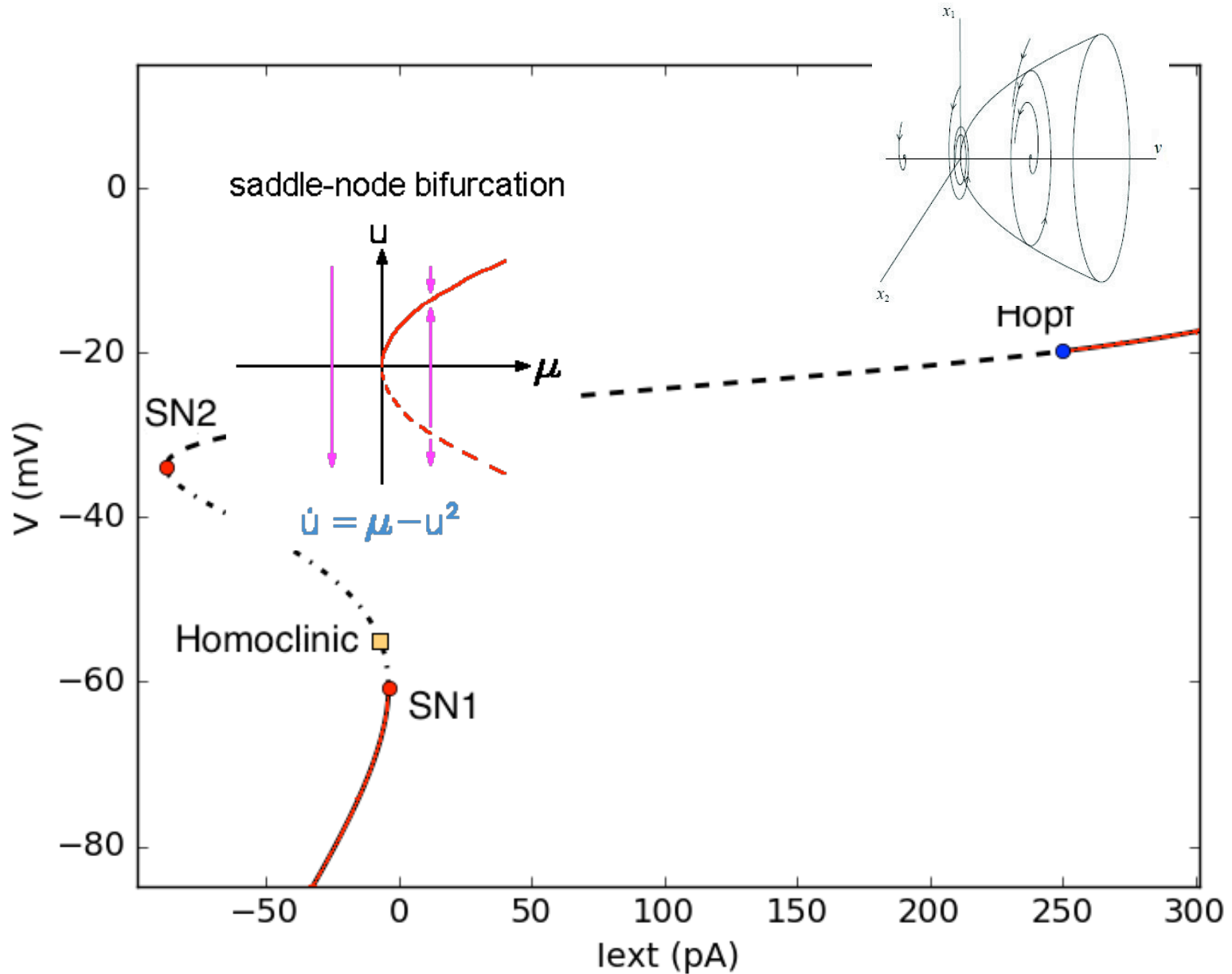

Bifurcation diagram of M-L model

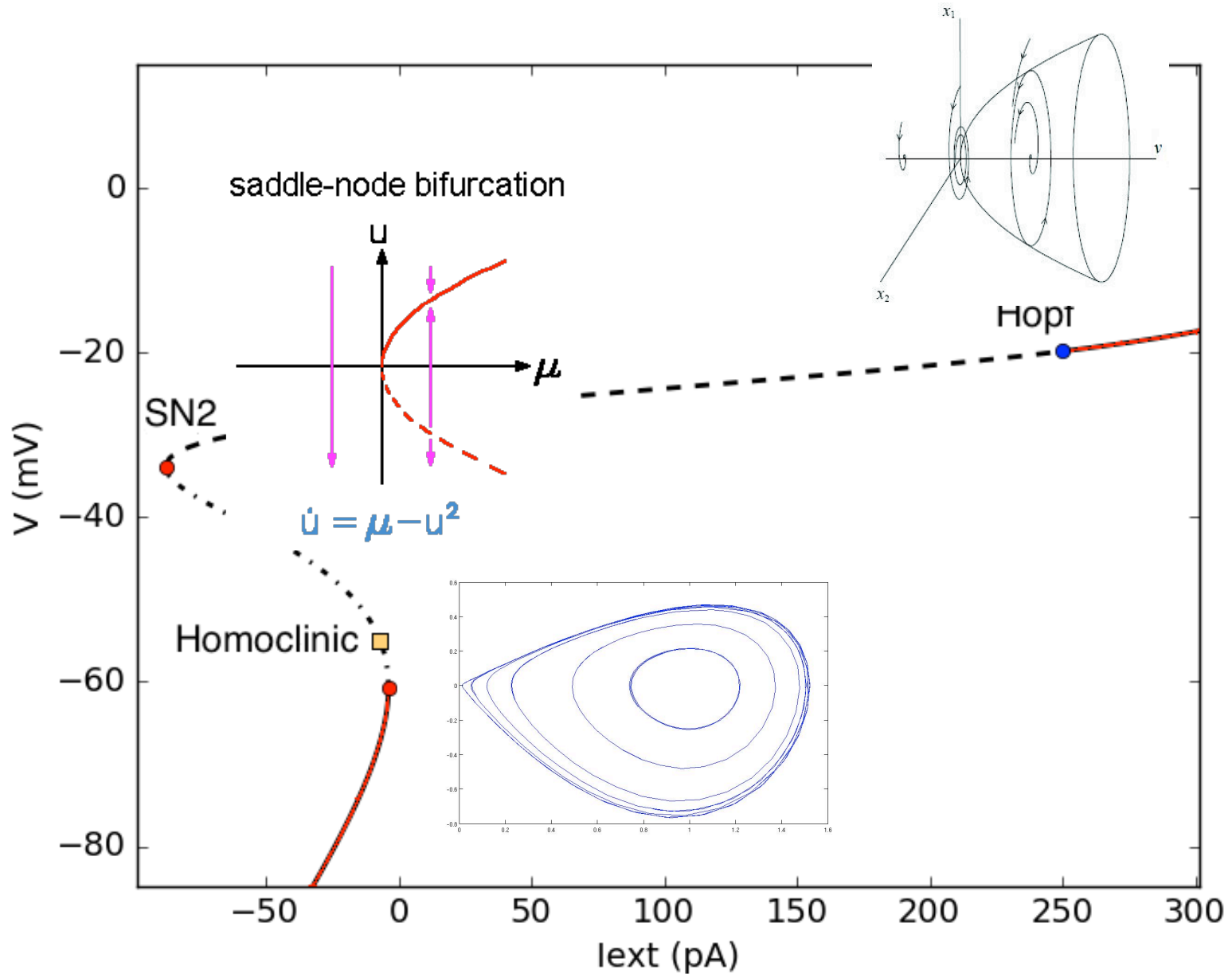

The mechanism of bursting

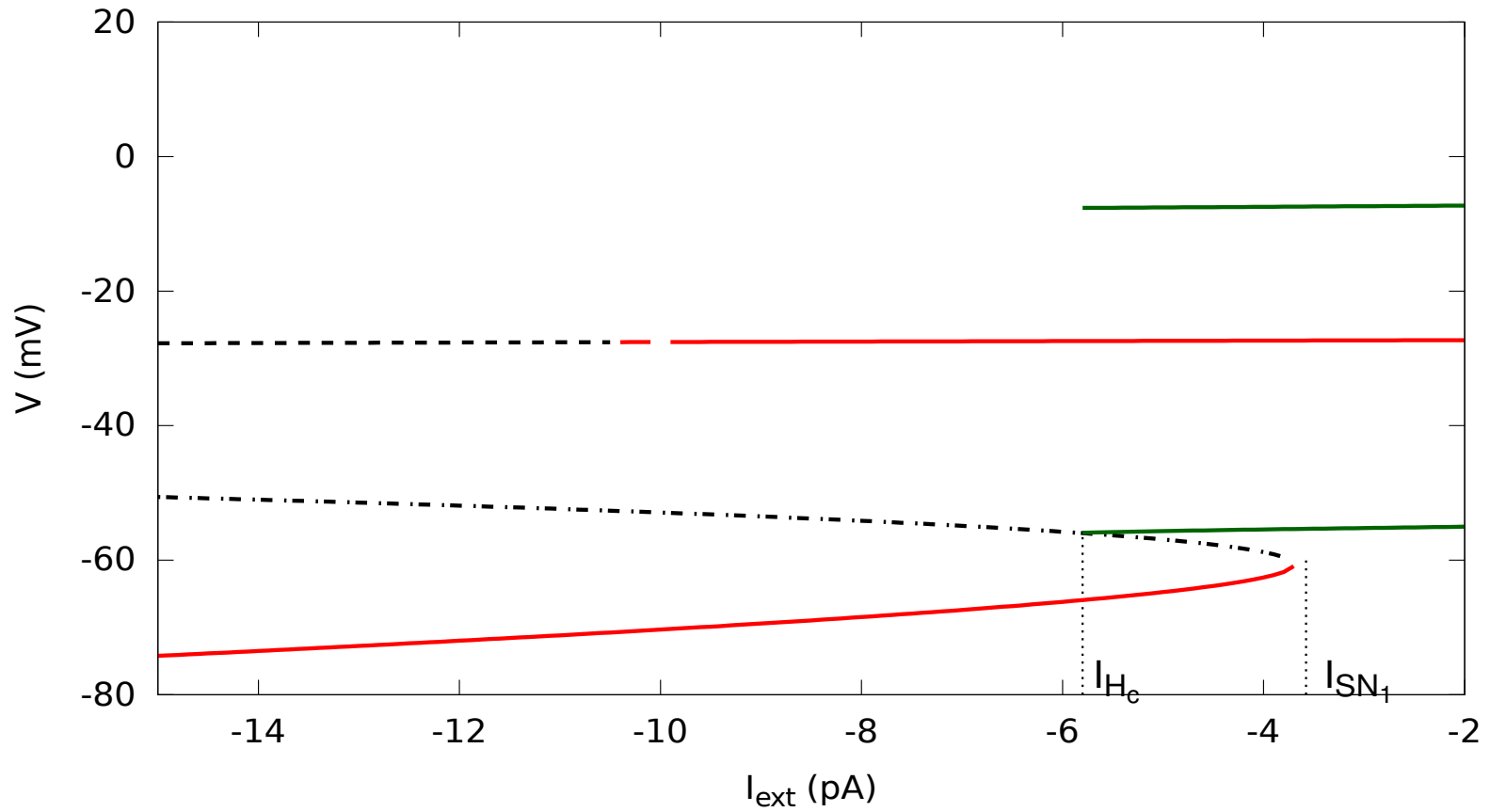

The mechanism of bursting

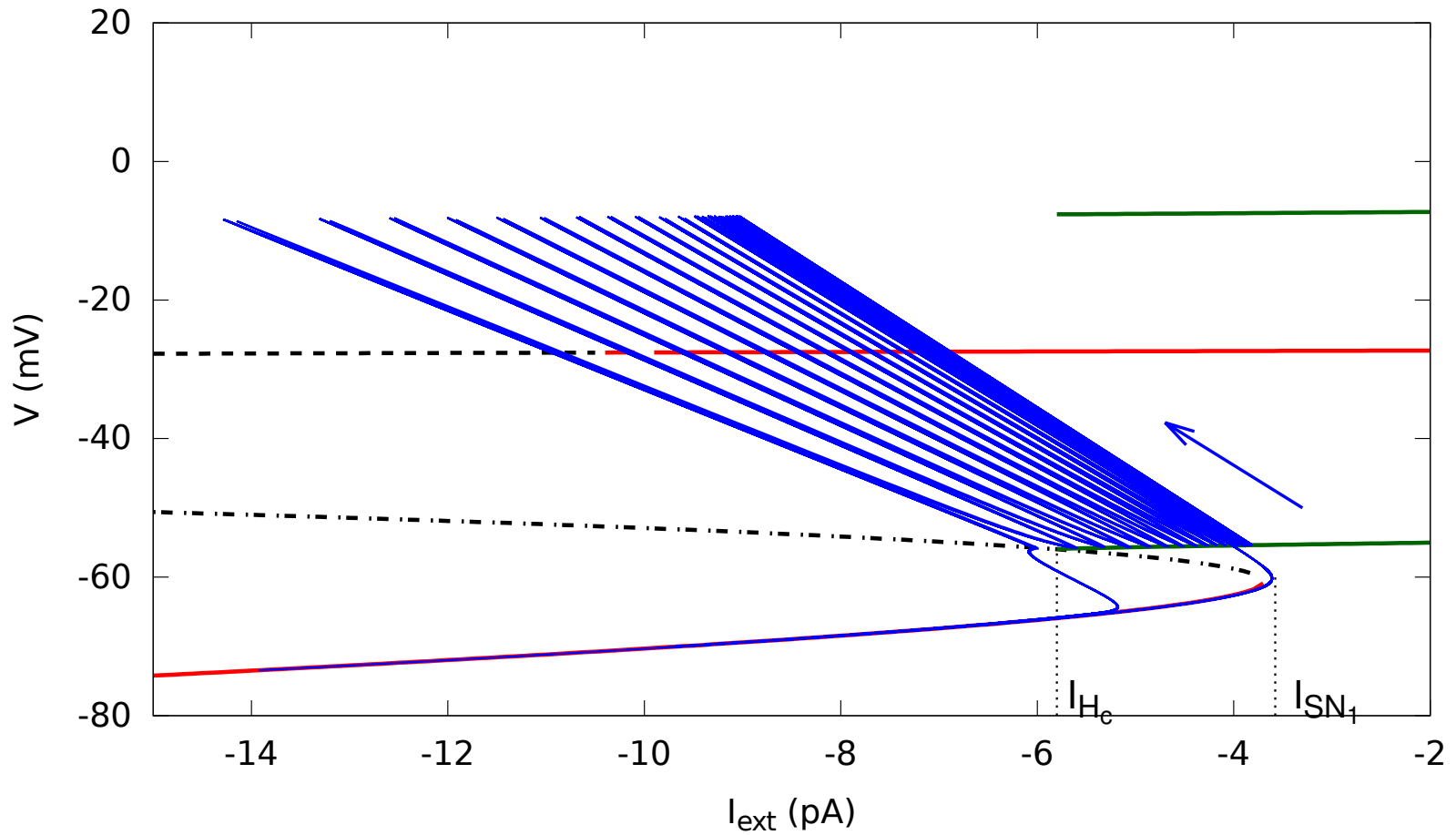

Spontaneous Bursting Mechanism of SACs

Bursting
 sAHP

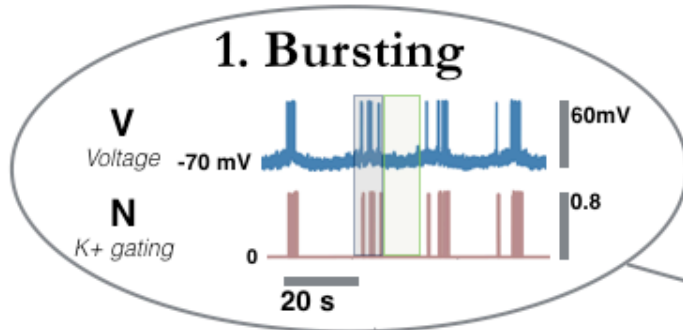

Increase of Calcium load during bursting

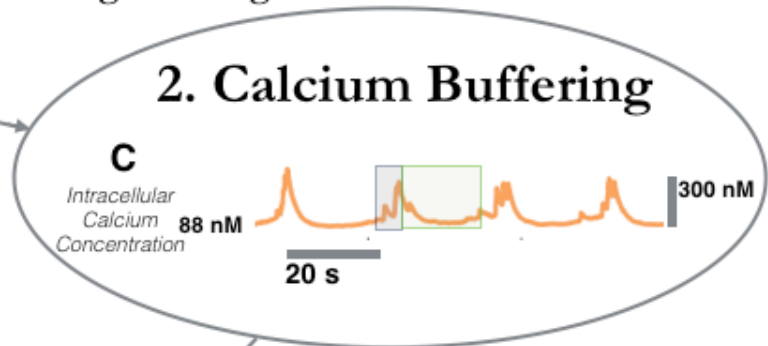

Bursting starts again when the Calcium load is low enough

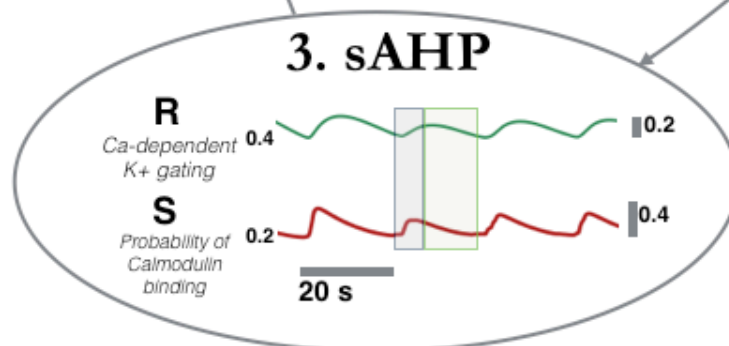

Calcium controls the sAHP phase. Voltage is low and Calcium starts offloading

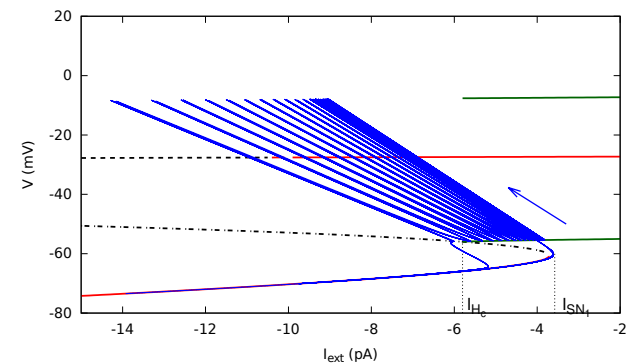

The mechanism of bursting (spontaneous)

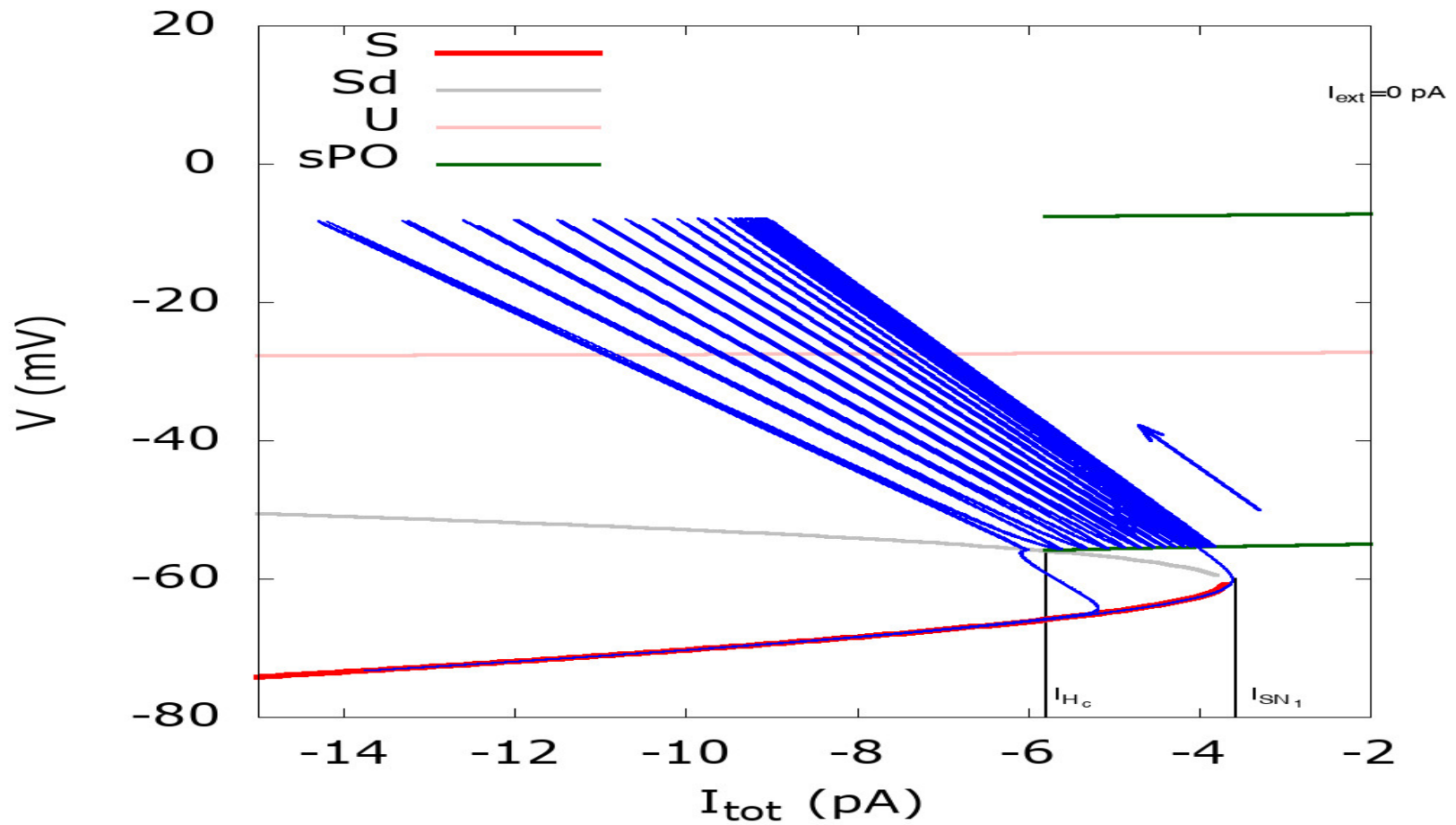

The mechanism of bursting (~~spontaneous~~)

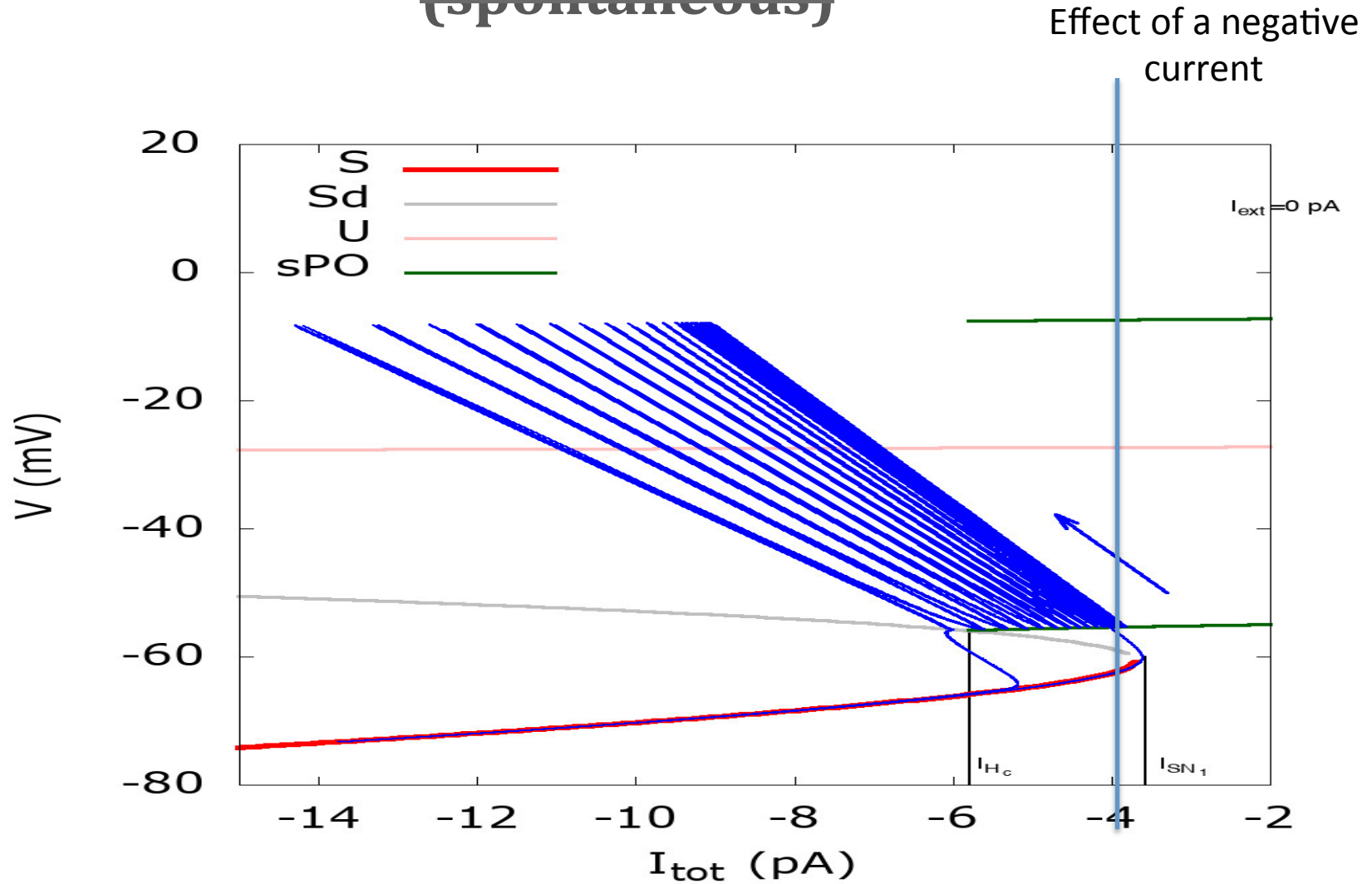

The mechanism of bursting (noise induced)

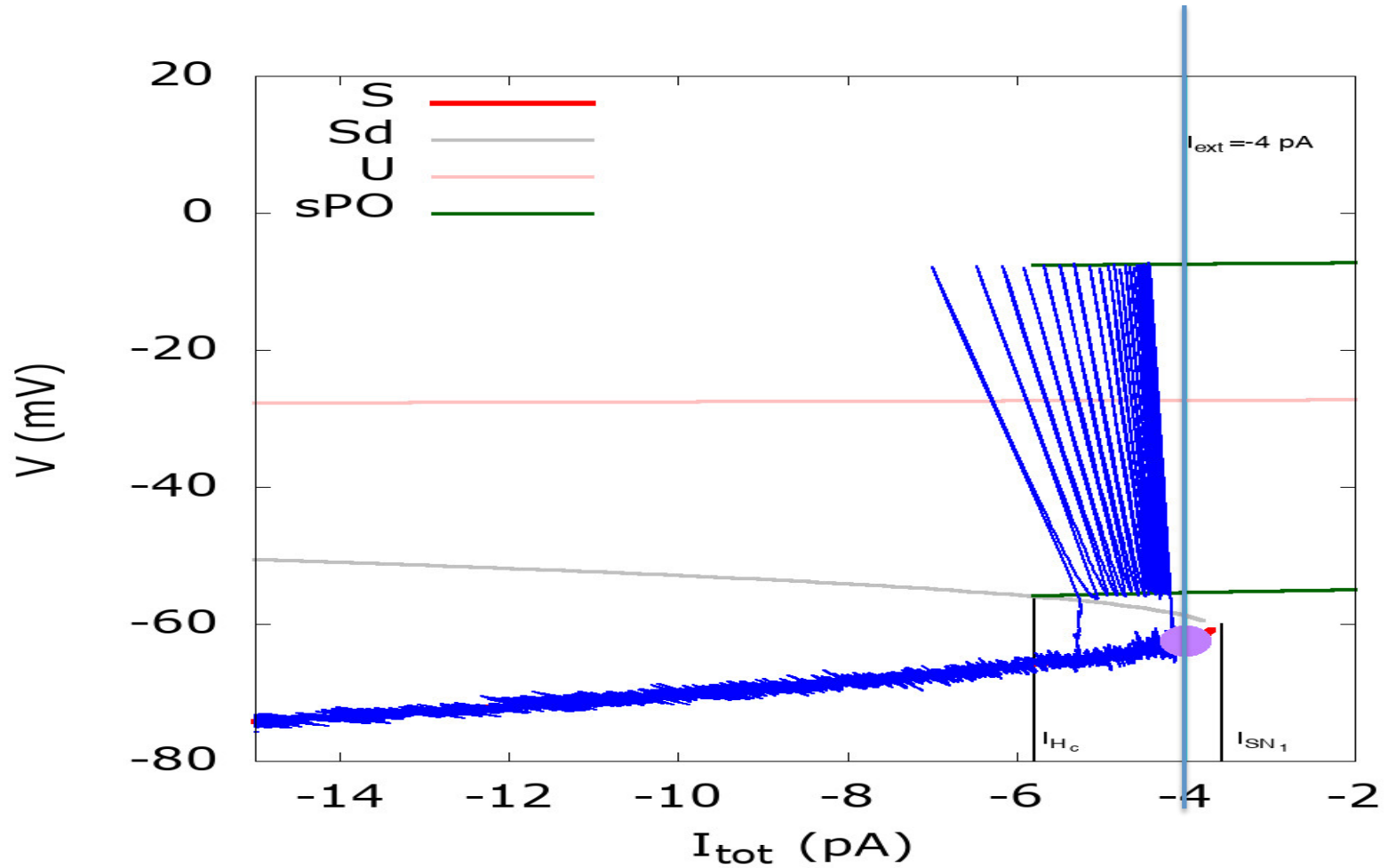

Variability within retinal waves

Variability within retinal waves

i) Across species

Godfrey et al. 2007

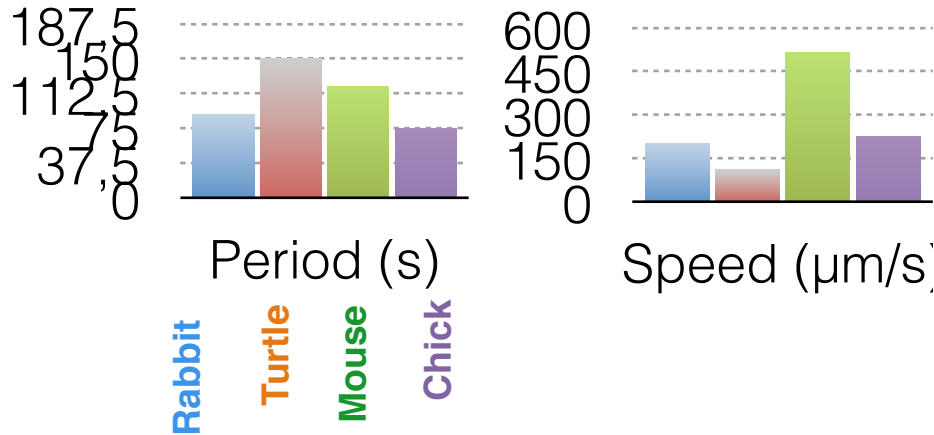

Variability within retinal waves

i) Across species

Godfrey et al. 2007

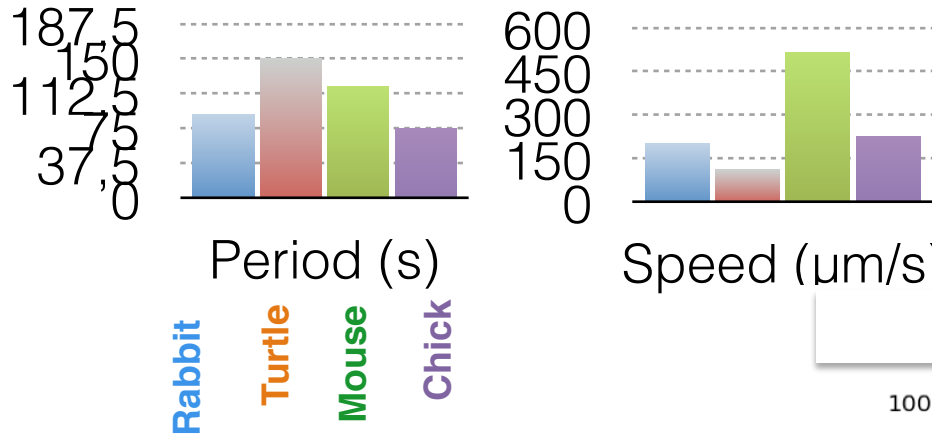

Interburst intervals

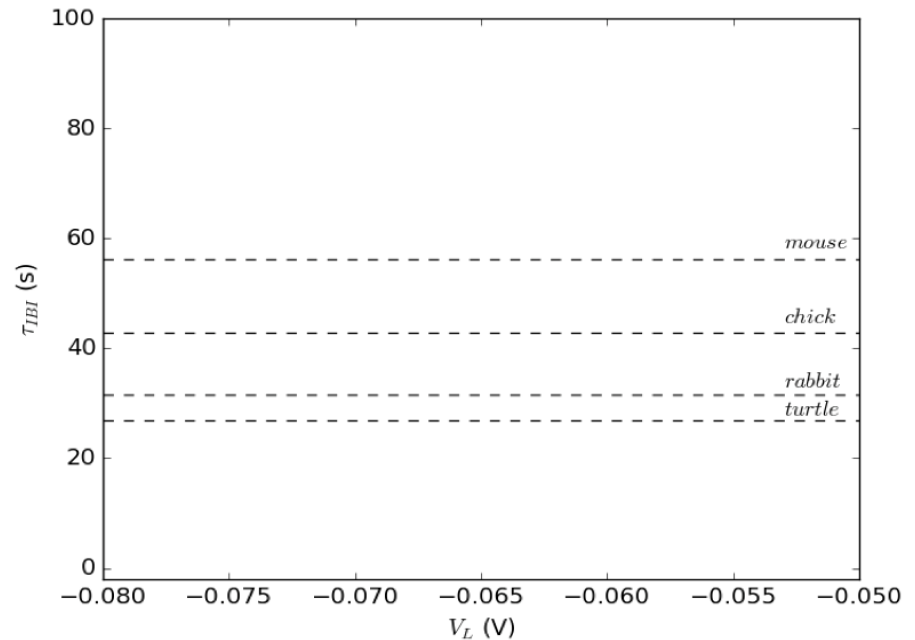

Variability within retinal waves

i) Across species

Godfrey et al. 2007

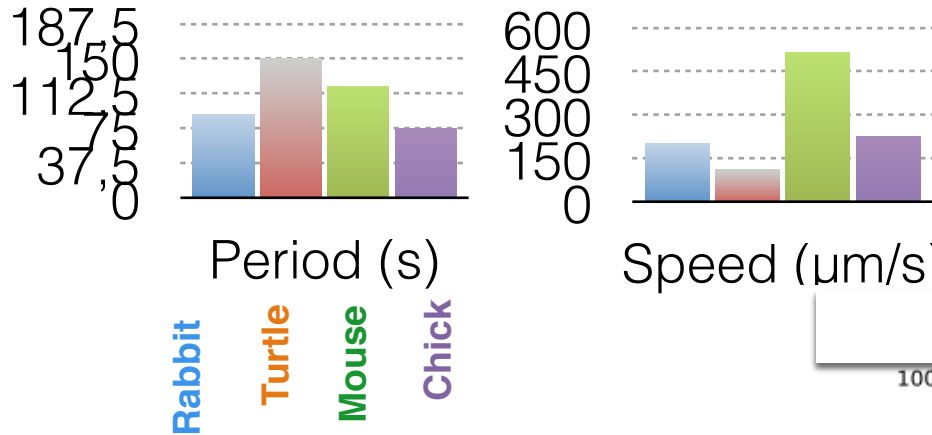

Interburst intervals

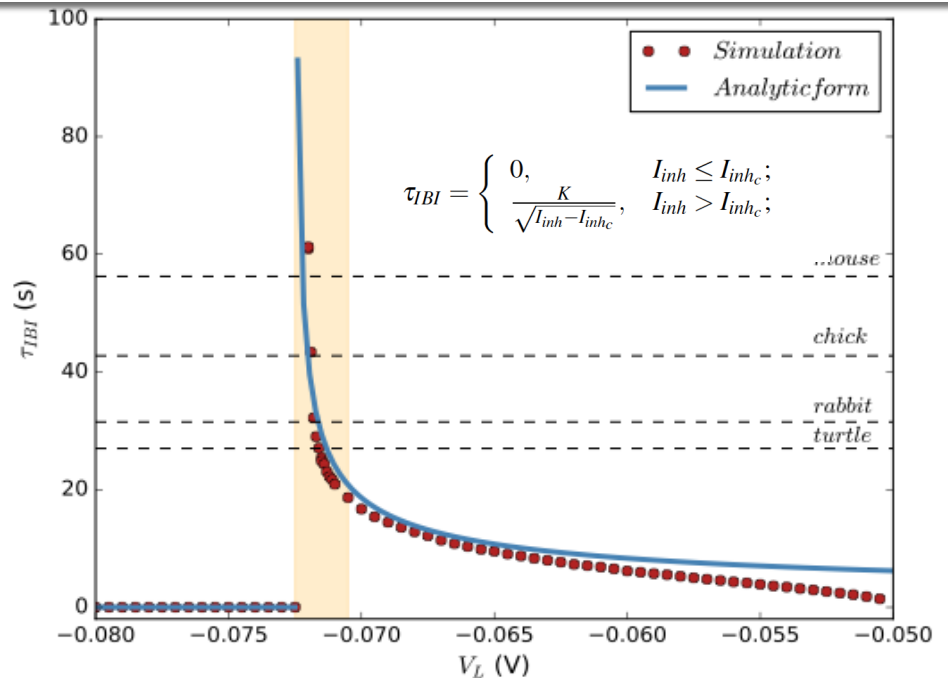

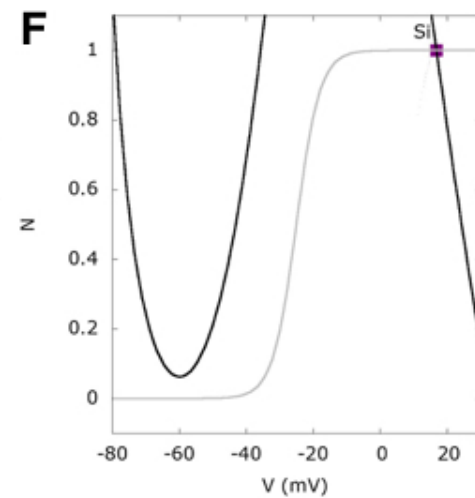
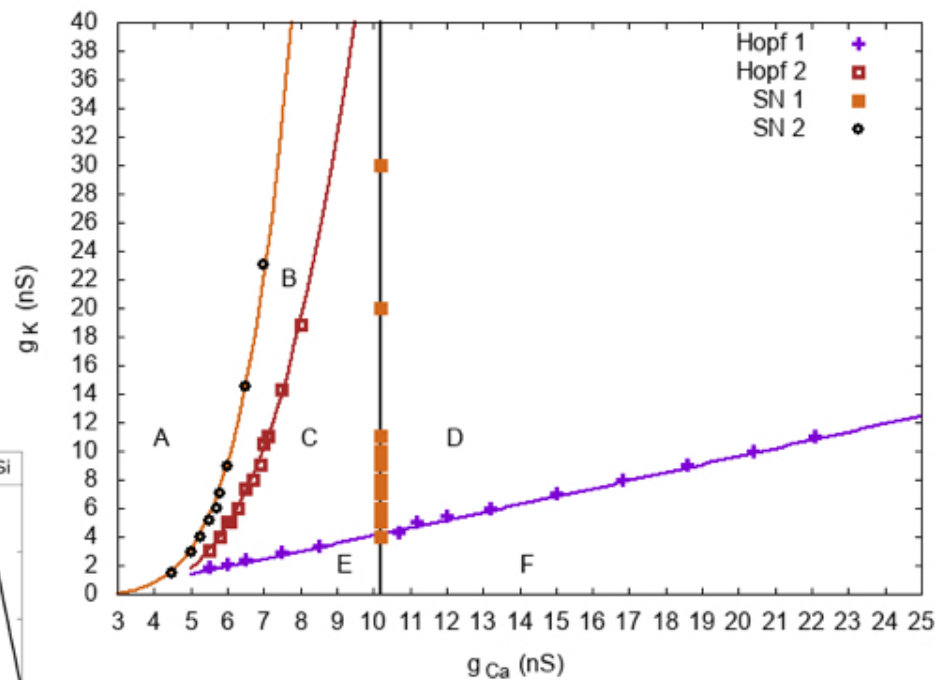
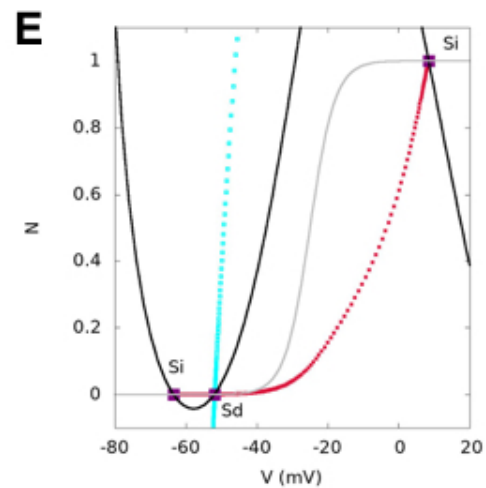
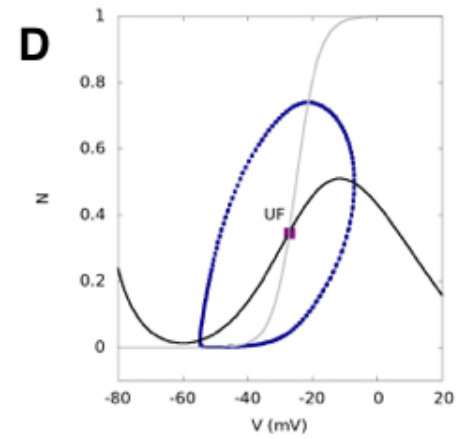
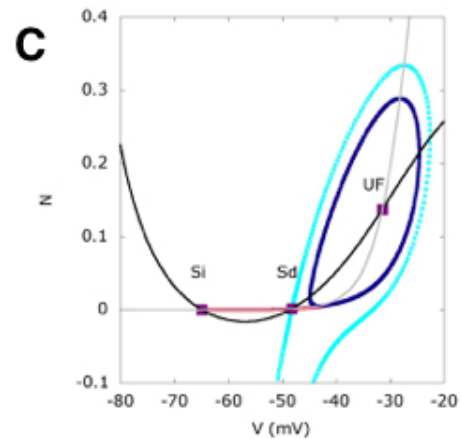
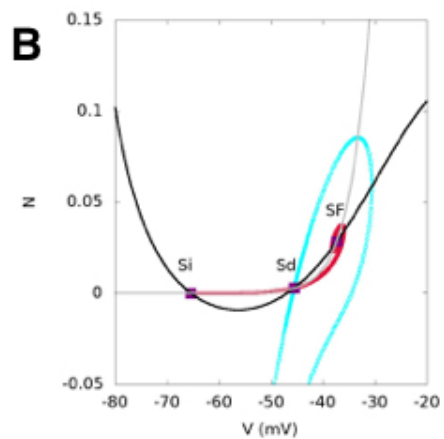
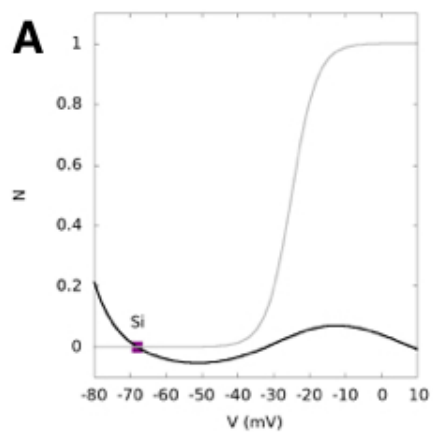

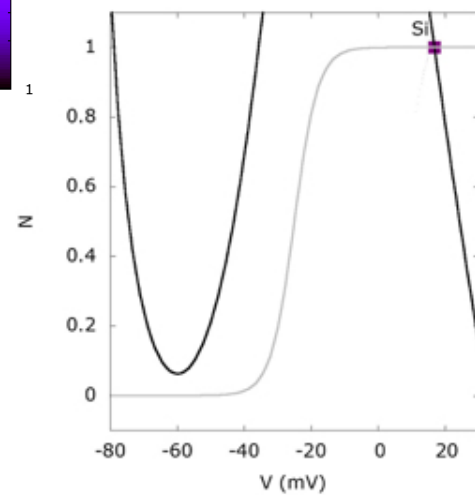
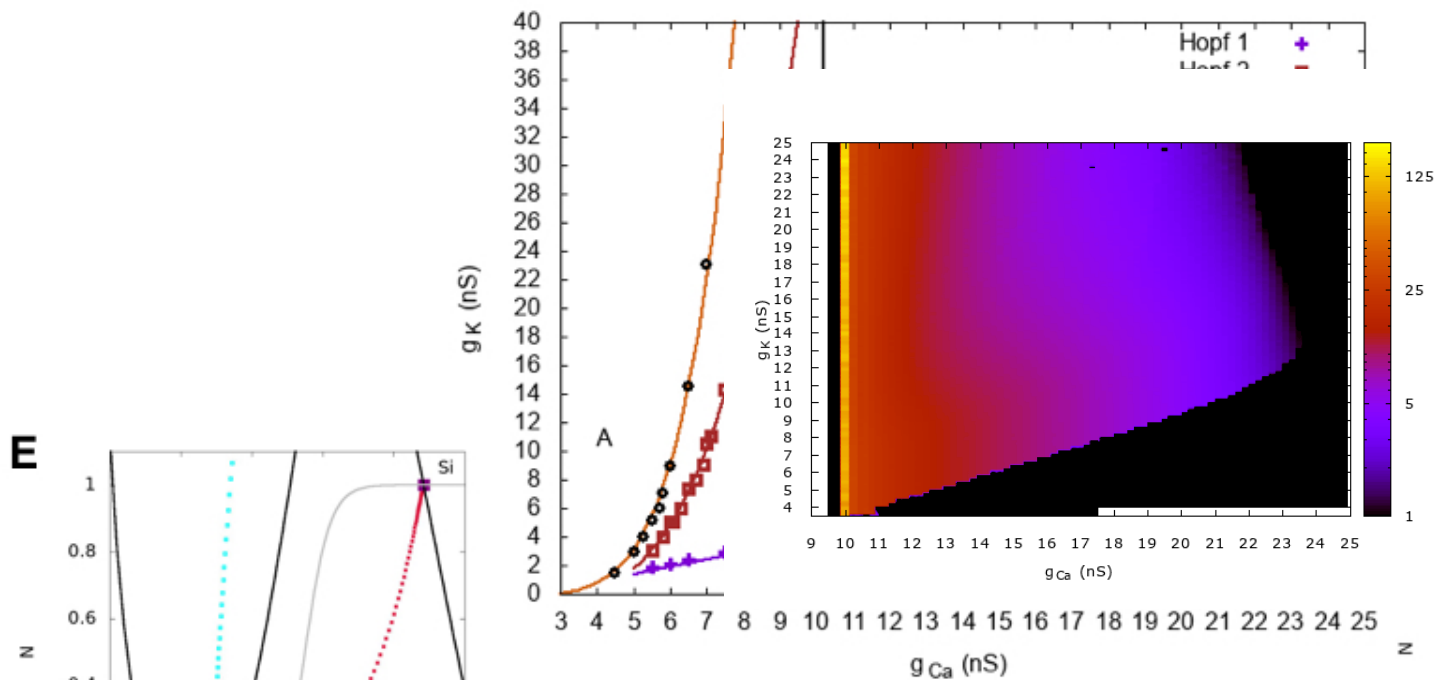
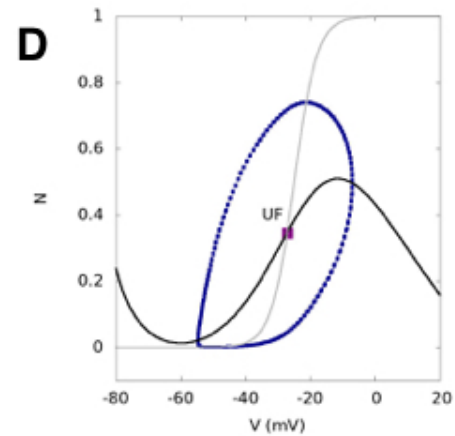
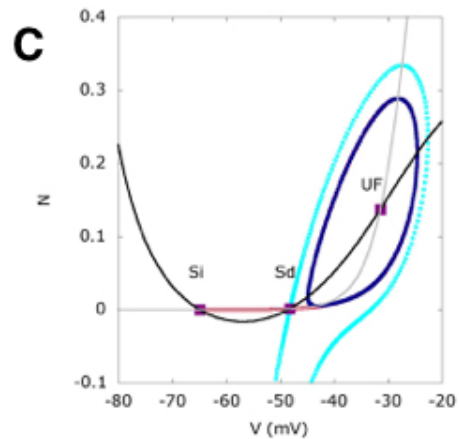
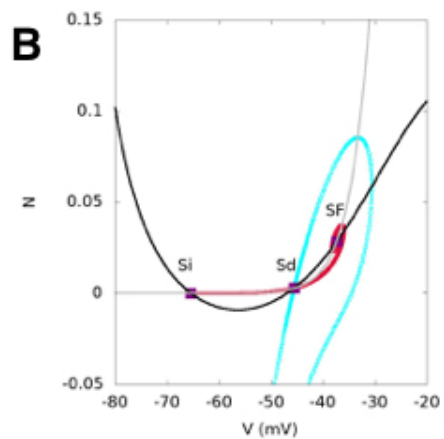
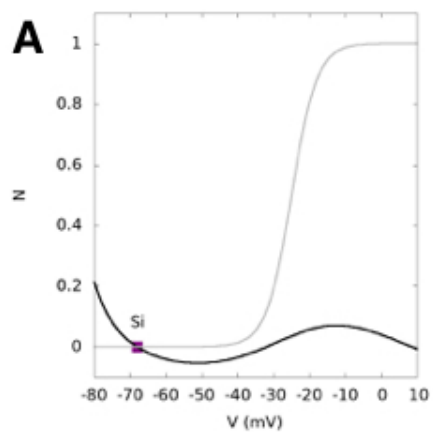

Variability within retinal waves

i) Across species

Godfrey et al. 2007

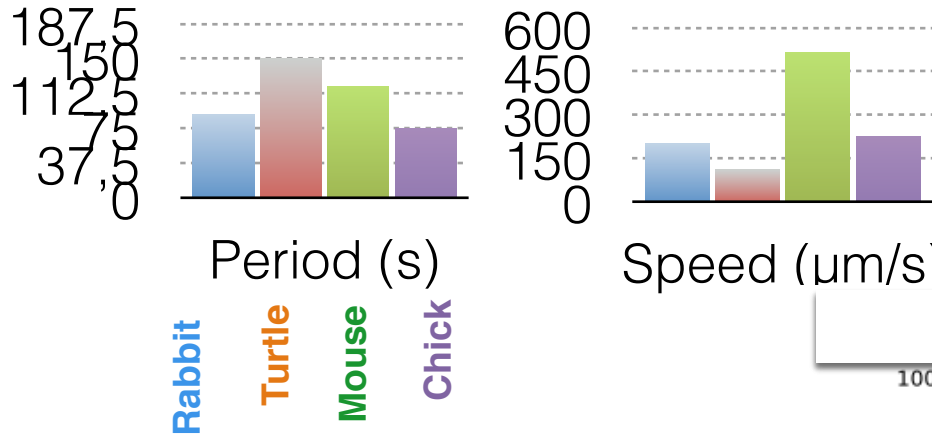

Interburst intervals

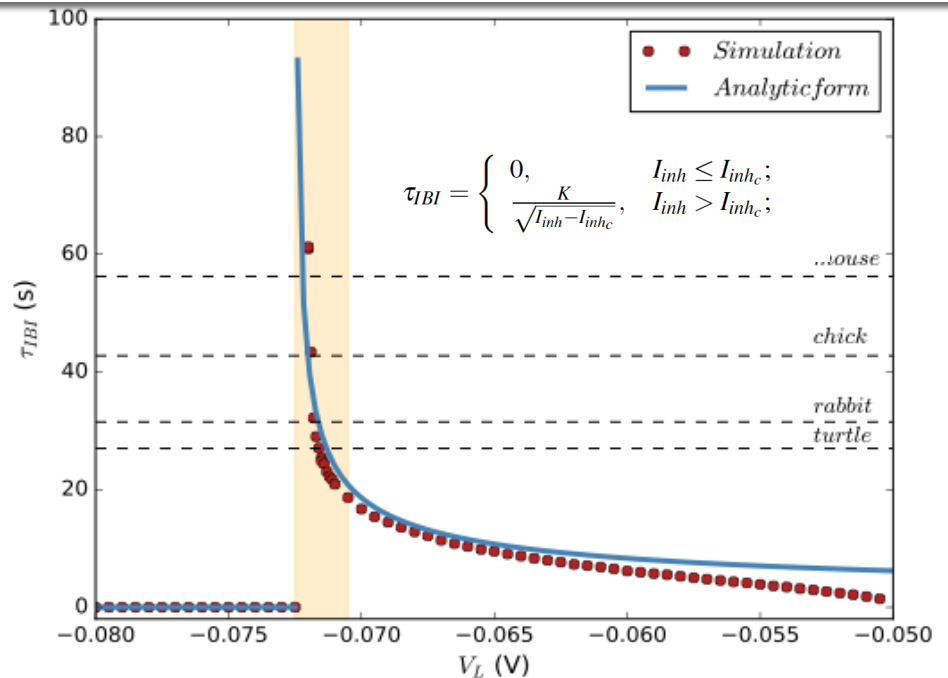

Variability within retinal waves

Pharmacological effects can be explained and predicted from bifurcations analysis (variations of physiological parameters).

A biophysical model explains the spontaneous bursting behavior in the developing retina

Dora Matzakos-Karvouniari, Lionel Gil, Elaine Orendorff, Olivier Marre, Serge Picaud, Bruno Cessac

Scientific Reports, Nature Publishing Group, 2019, 9 (1), pp. 1-23. <10.1038/s41598-018-38299-4>

iii) Pharmacology

P4

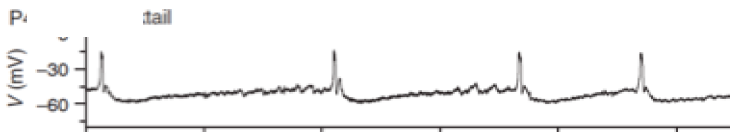

P8

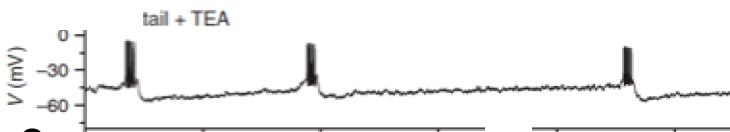
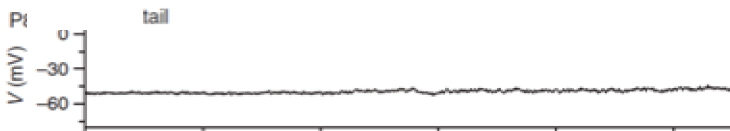

0 Time (sec) 50

Cellular mechanisms of stage II retinal waves

Cellular mechanisms of stage II retinal waves

C. Synchrony through Acetylcholine

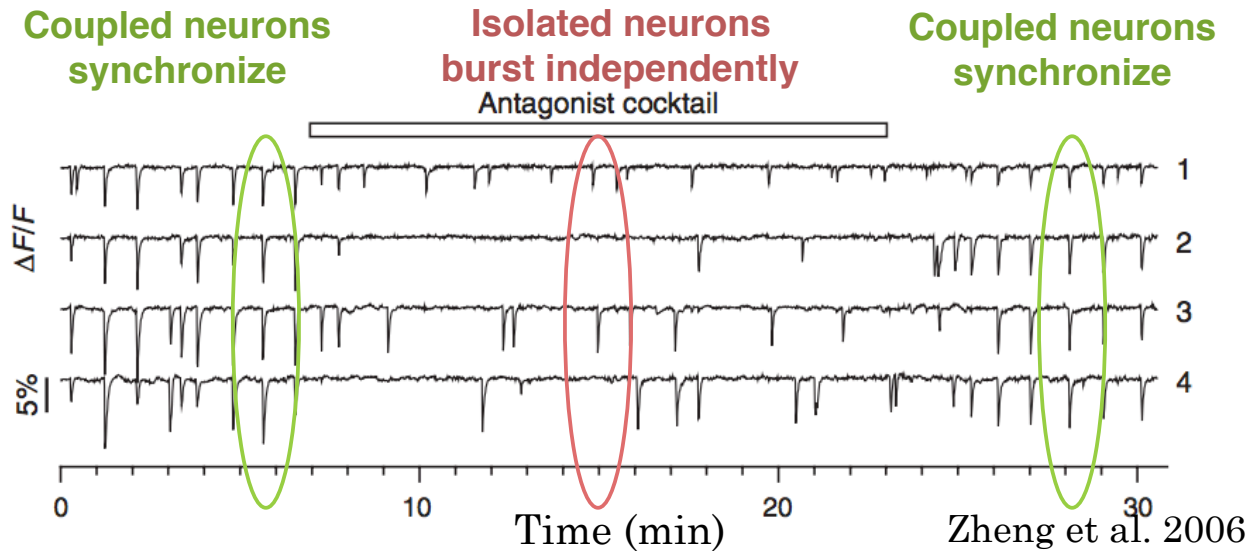

Mutual excitatory connections between SACs through Acetylcholine

A network model for stage II retinal waves

Morris-Lecar

$$C_m \frac{\partial V_i}{\partial t} = -g_L^M (V_i - V_L) - g_{Ca} (V_i) (V_i - V_{Ca}) - g_K N_i (V_i - V_K) - g_{sAHP} R_i^4 (V_i - V_K) - \sum_j g_{j,Ach} (A_j) (V_i - V_{Ach})$$

$$\tau_N \frac{\partial N}{\partial t} = \Lambda(V) (N_\infty(V) - N)$$

**Morris-Lecar &
Fast K+ channels
(kV3)**

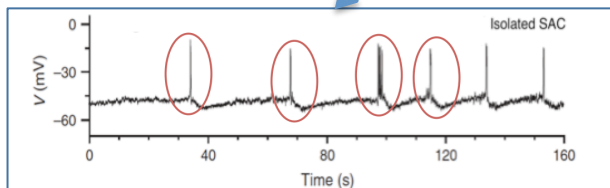

**sAHP current
Refractory
mechanism**

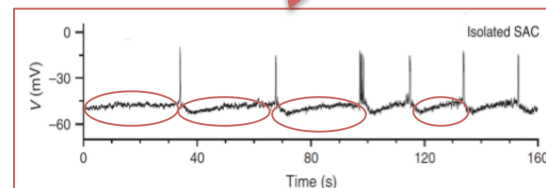

**Ach current
Network
effect**

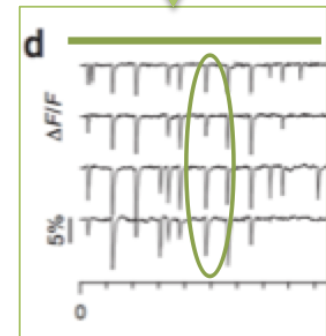

The coupled dynamics of 2 SACs

V,R,A profiles of a single SAC

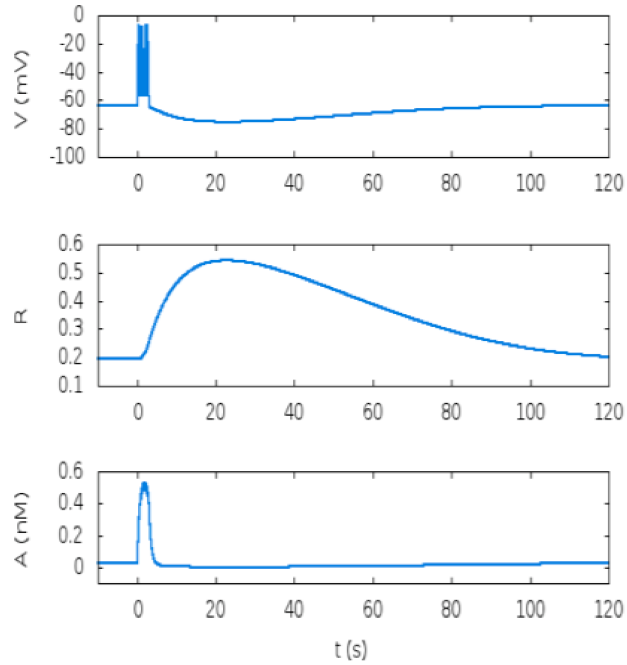

The coupled dynamics of 2 SACs

V,R,A profiles of a single SAC

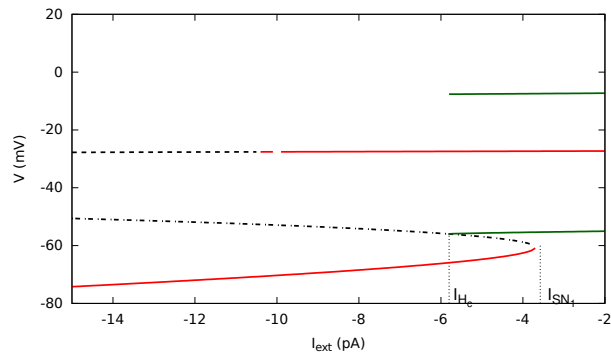
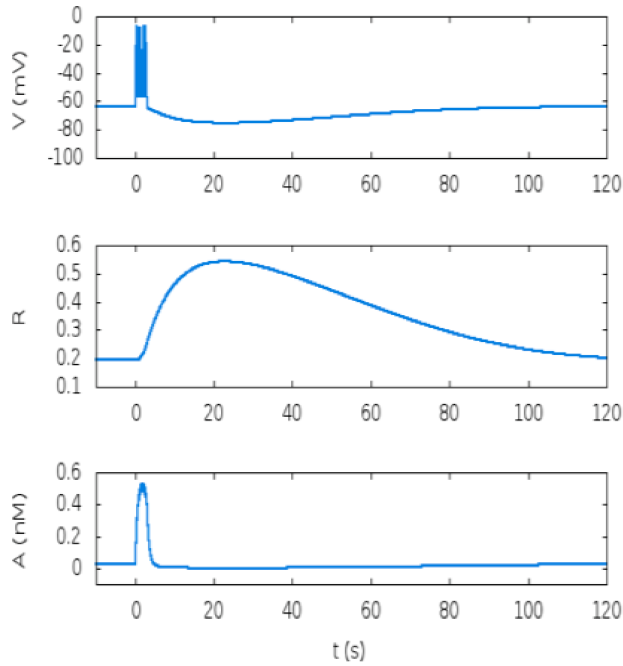

Ach profile

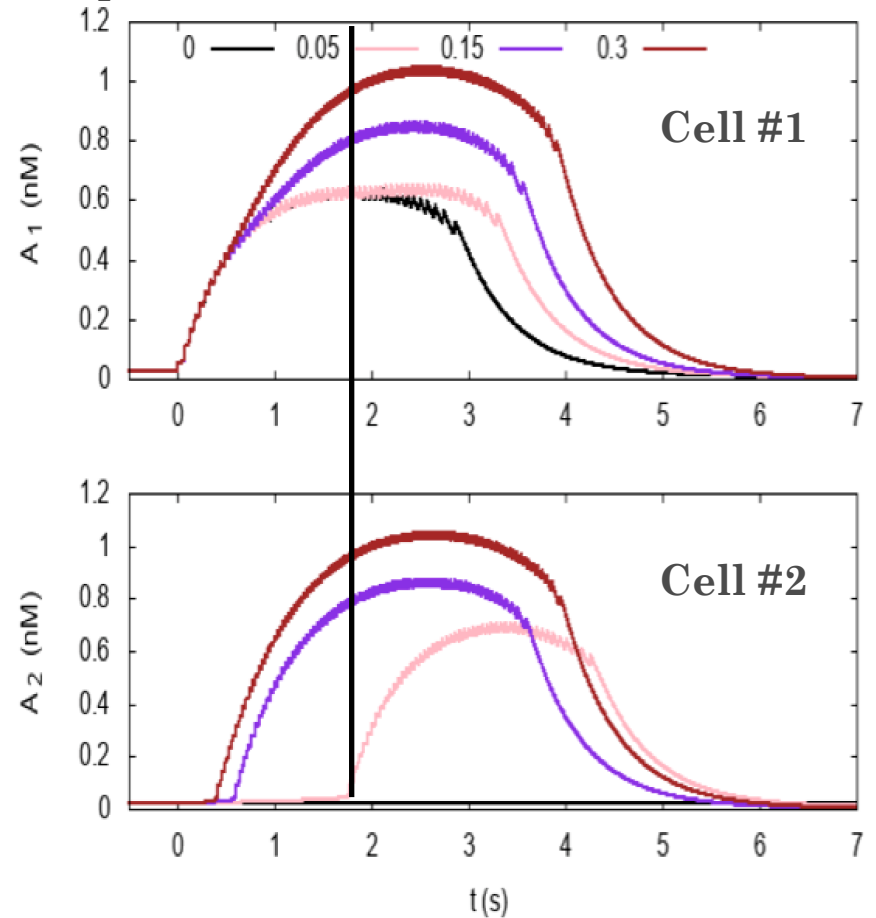

Synchrony: Arnold tongues

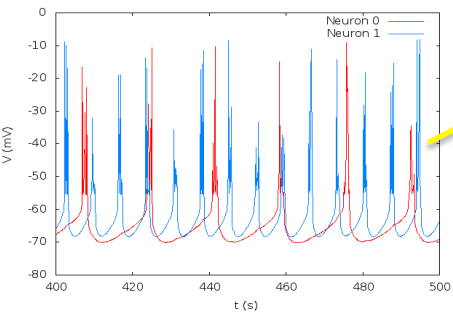
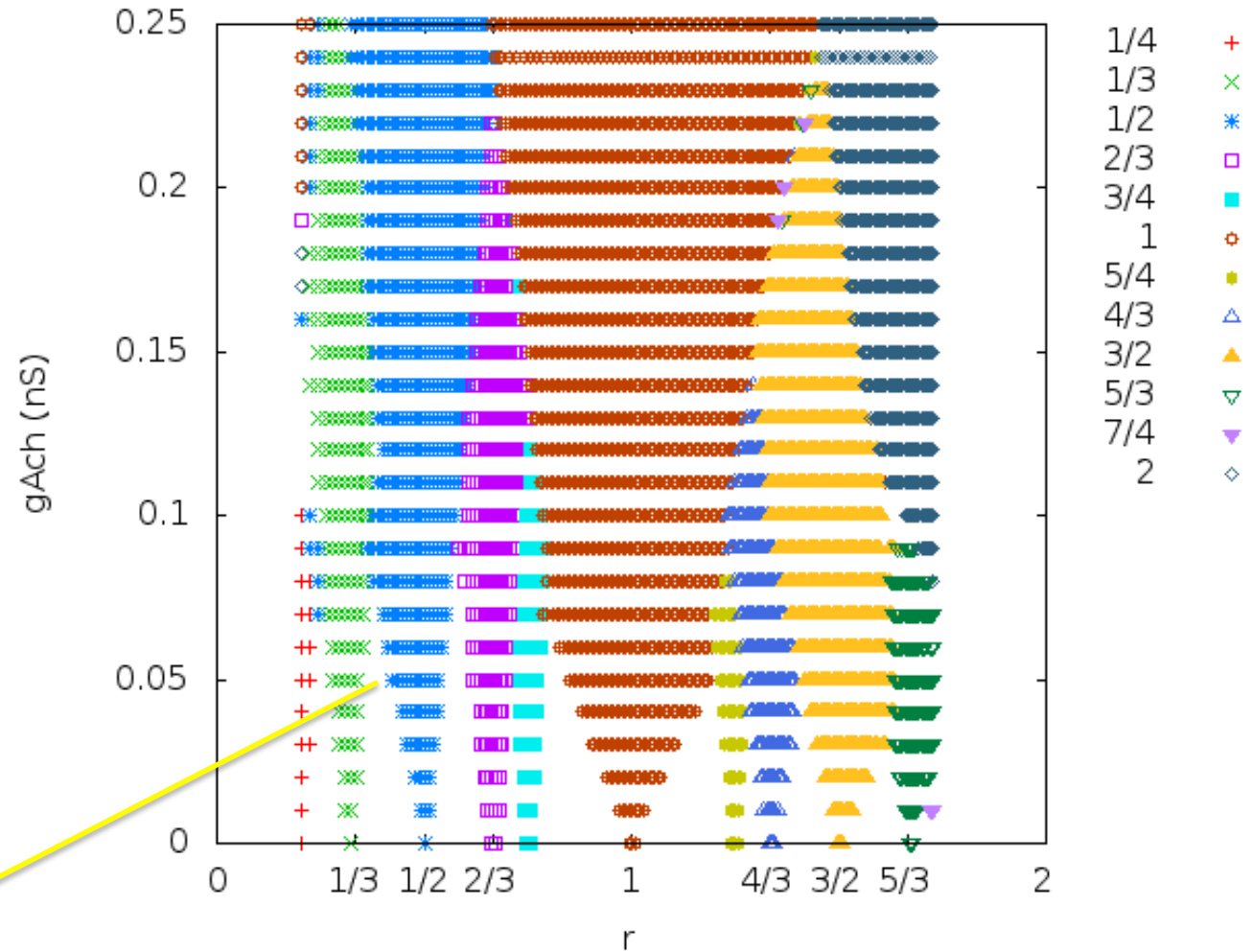

Synchrony: Arnold tongues

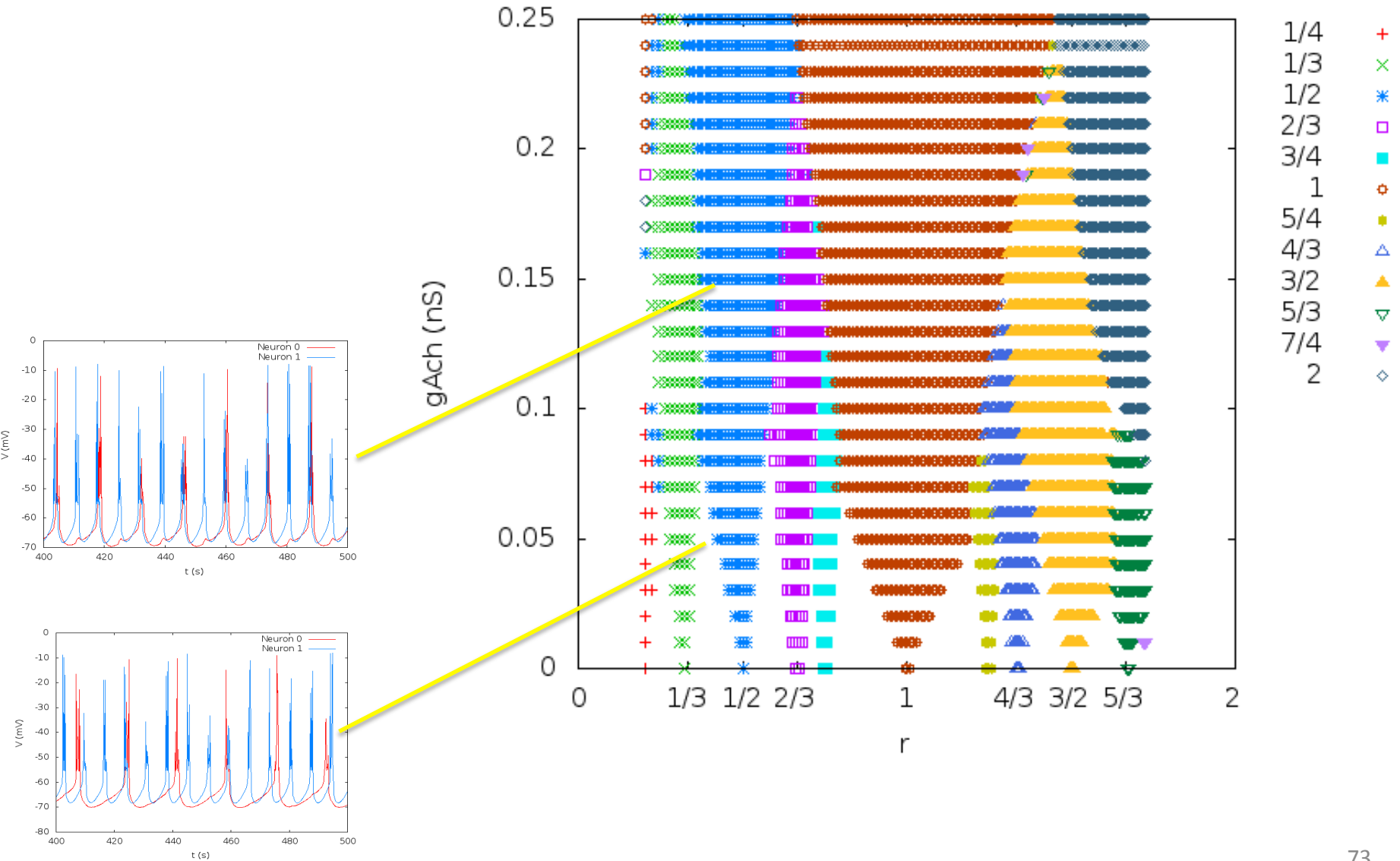

Synchrony: Arnold tongues

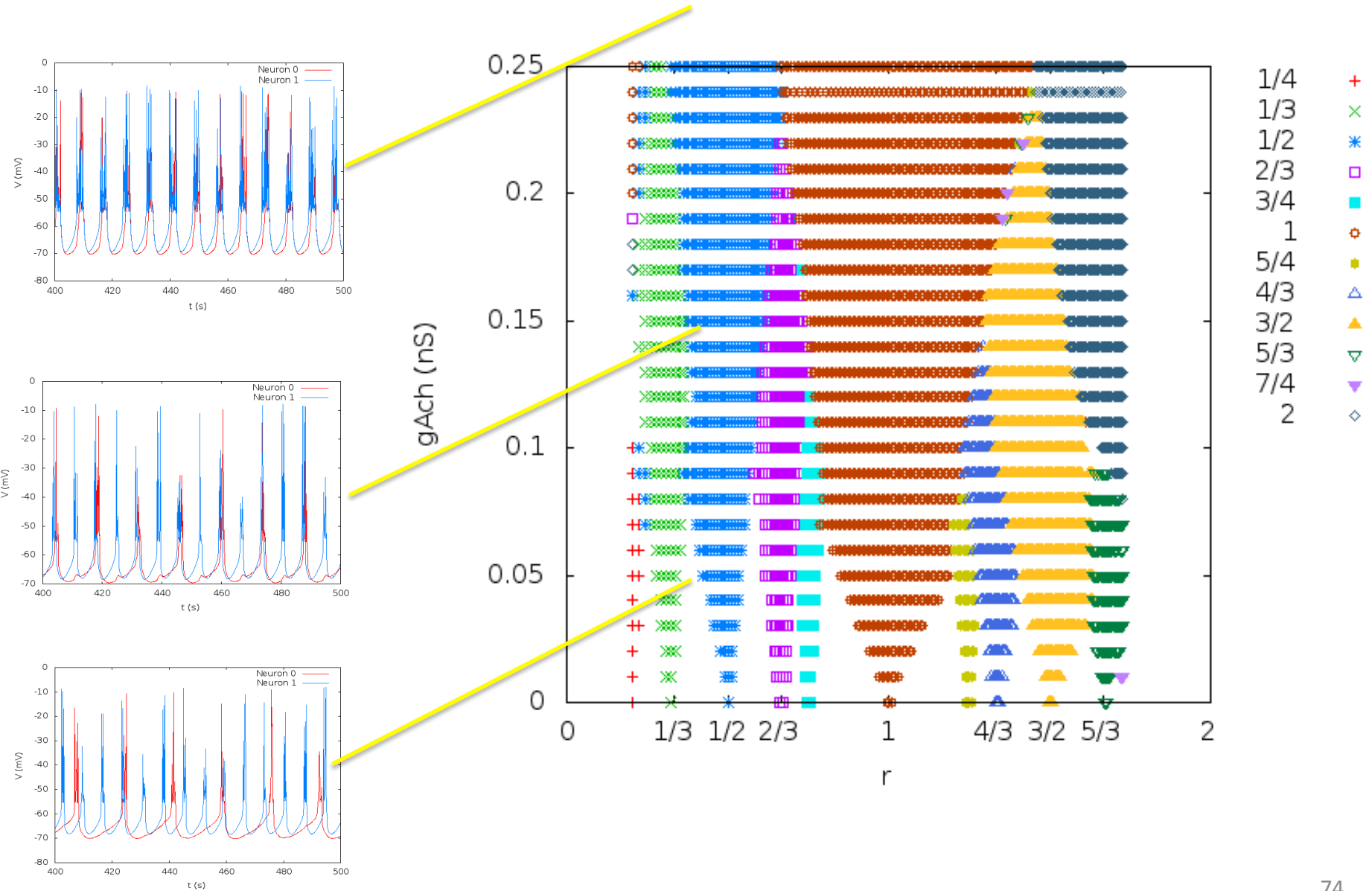

The coupled dynamics of 2 SACs

V,R,A profiles of a single SAC

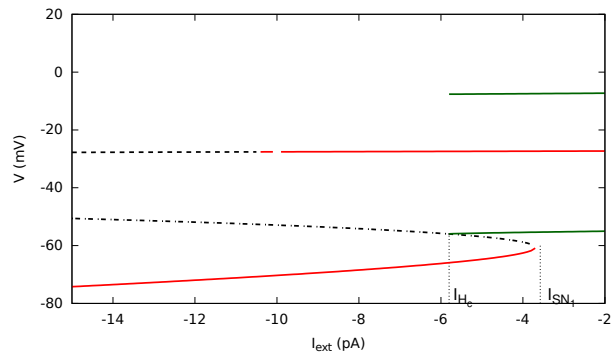
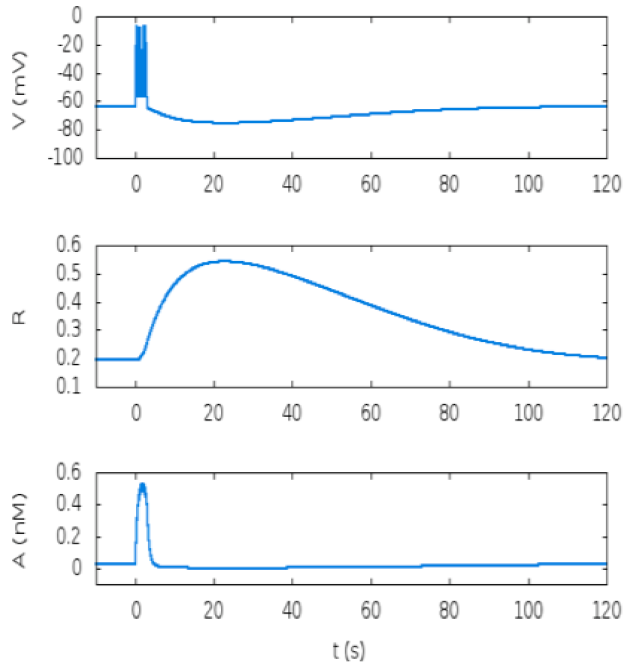

Ach profile

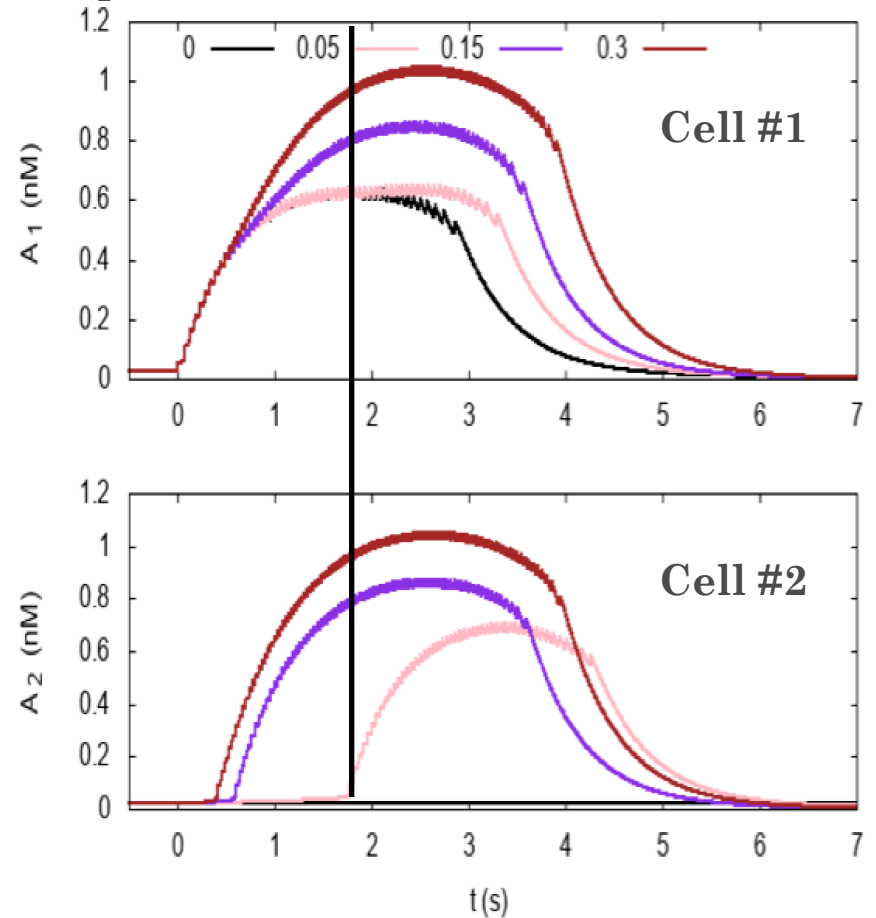

The coupled dynamics of 2 SACs

V,R,A profiles of a single SAC

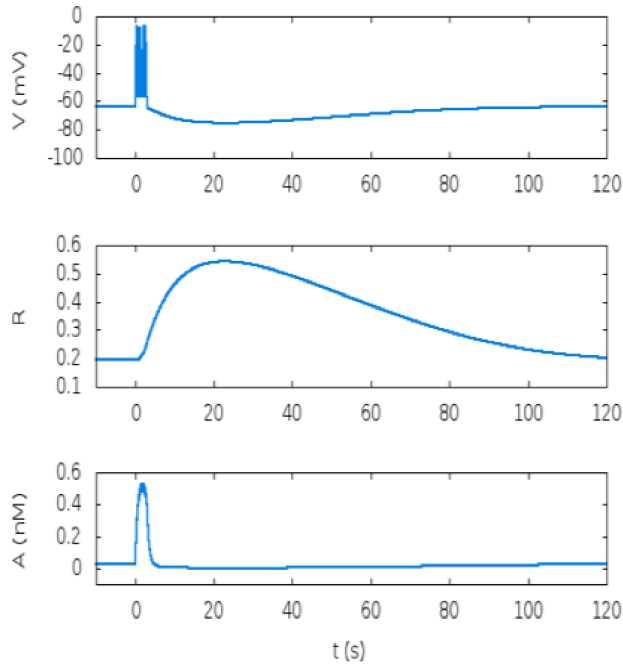

Ach profile

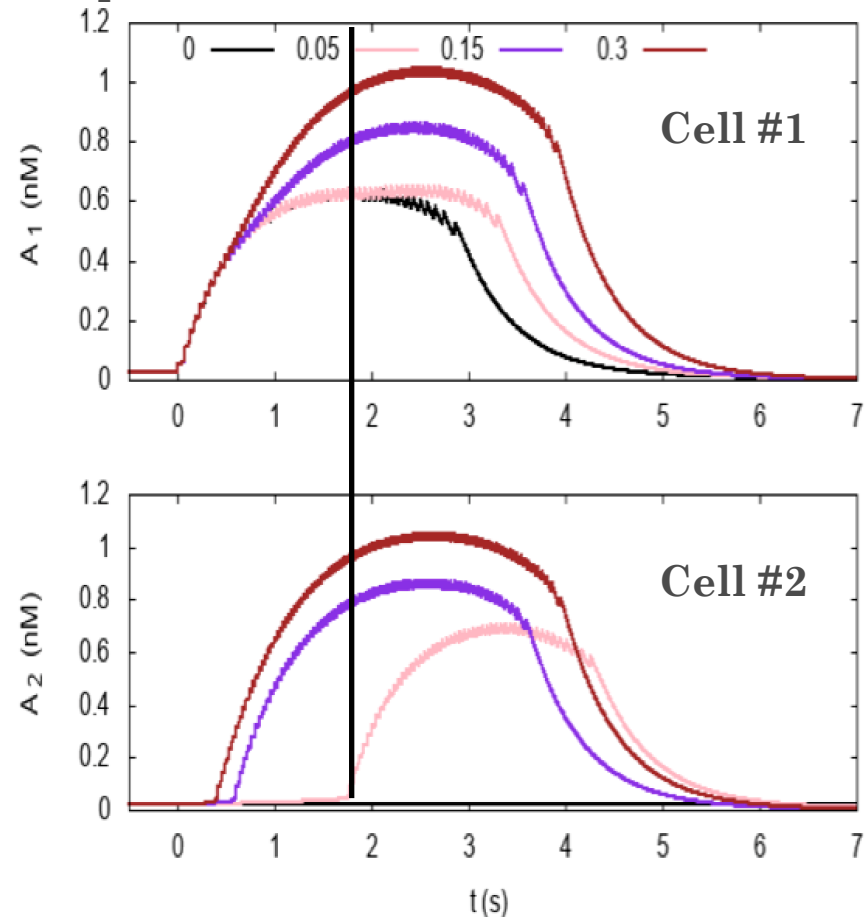

Condition for bursting to start:

$$I_{Ach} + I_{sAHP} = I_{SN}$$

Response Time

$$t_i = -\frac{1}{\mu} \log \left(1 + \frac{2\mu\sqrt{\gamma_A}}{n_i\beta\Omega} \left(\frac{I_{SN} + g_{sAHP}R^4(V_- - V_K)}{g_A(V_- - V_A)} \right) \right)$$

Waves speed in one dimensional chain

$$v_0 = \frac{1}{t_C - \frac{1}{\mu} \log \left(1 + \frac{1}{g_A} \frac{2\mu\sqrt{\gamma_A}}{d\beta\Omega} \left(\frac{I_{SN} + g_{sA}HPR^4(V_- - V_K)}{(V_- - V_A)} \right) \right)}$$

Waves speed (1D)

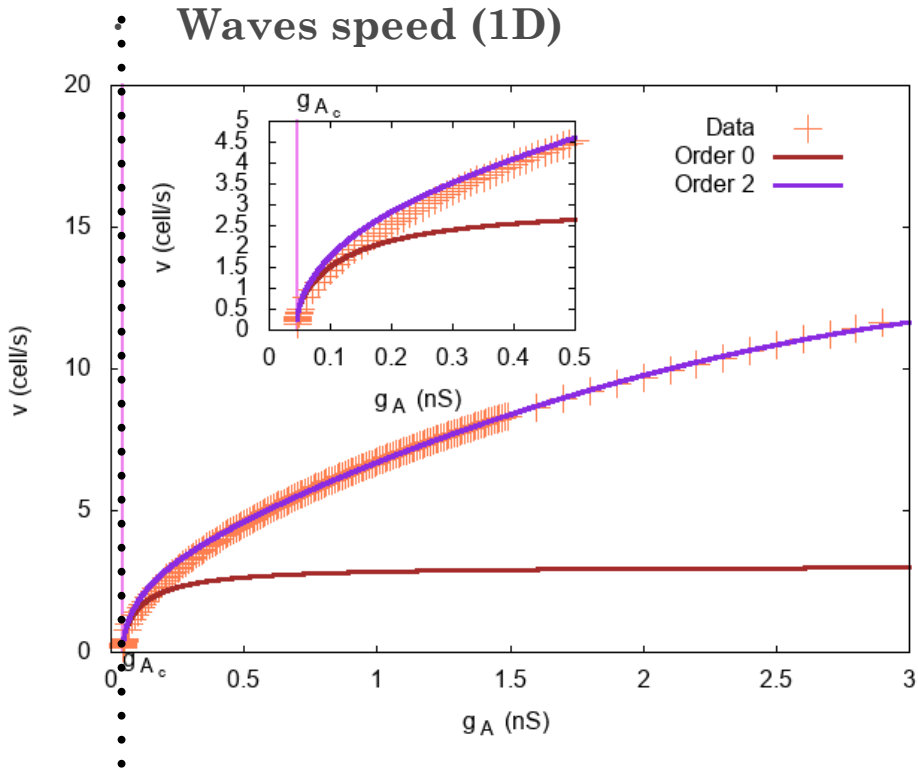

Waves speed in one dimensional chain

$$v_0 = \frac{1}{t_C - \frac{1}{\mu} \log \left(1 + \frac{1}{g_A} \frac{2\mu\sqrt{\gamma_A}}{d\beta\Omega} \left(\frac{I_{SN} + g_{sAHP}R^4(V_- - V_K)}{(V_- - V_A)} \right) \right)}$$

Waves speed (1D)

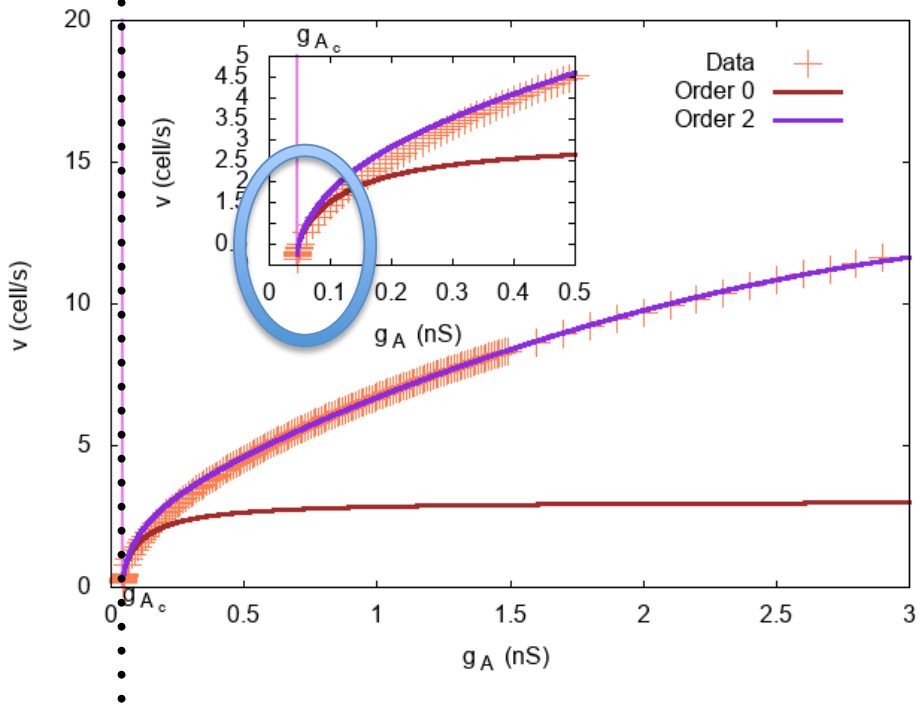

Propagation threshold

$$g_{A_c} = - \frac{2\mu\sqrt{\gamma_A}}{n_i\beta\Omega} \frac{I_{SN} + g_S R^4 (V_- - V_K)}{V_- - V_A}$$

Waves propagation

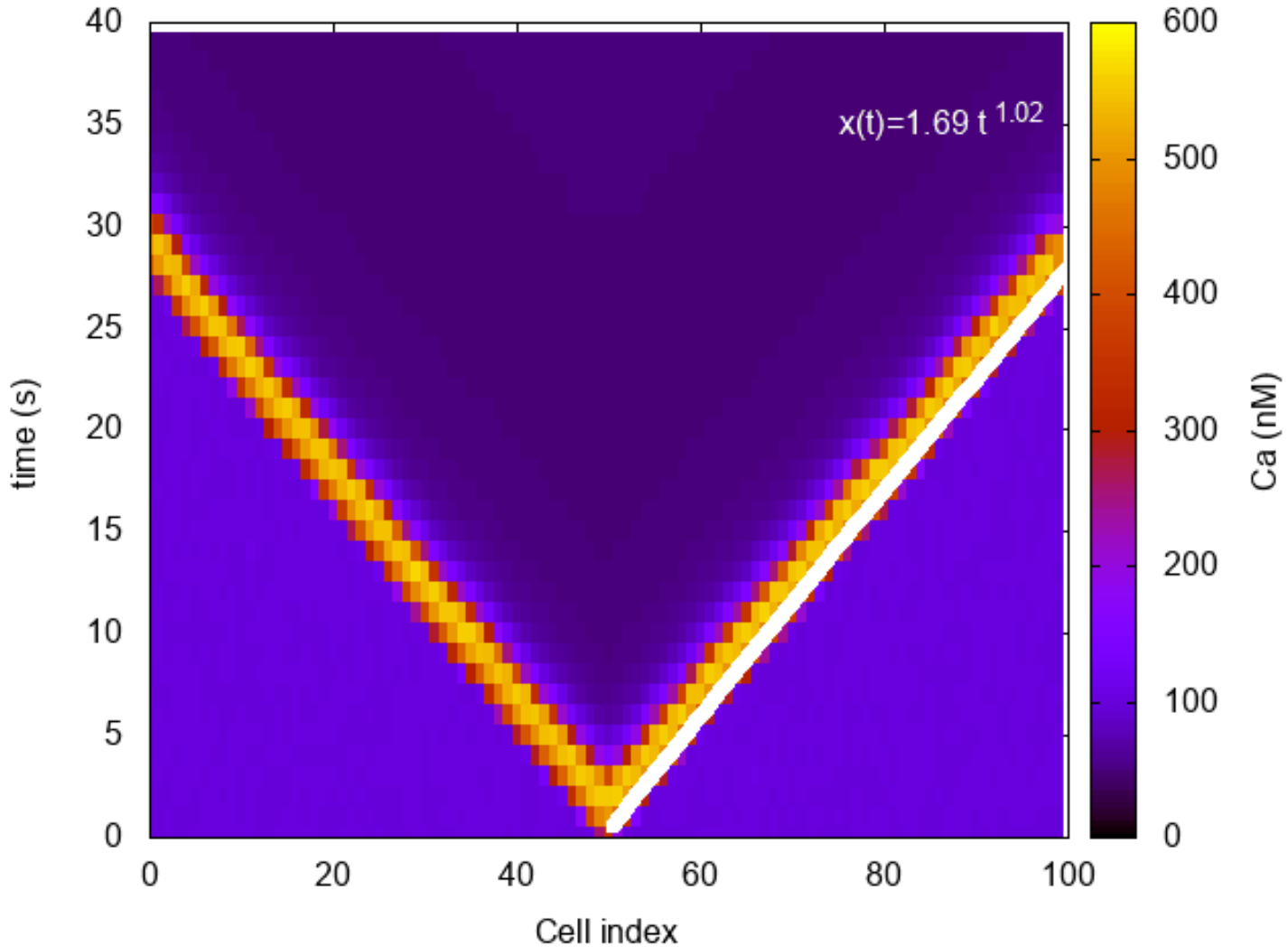

Waves propagation

$g_A = 0.03 \text{ nS}$

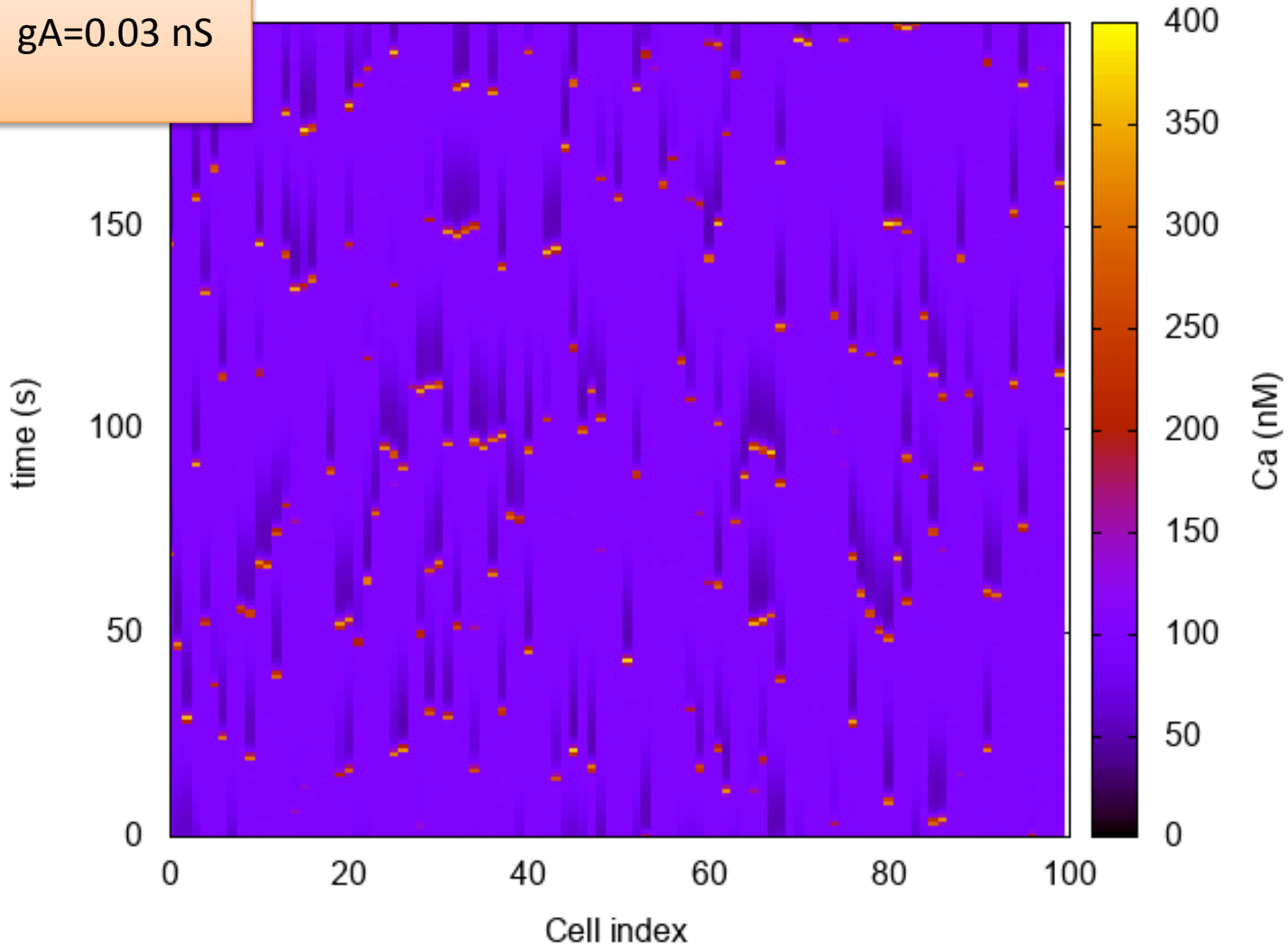

Waves propagation

$g_A = 0.045 \text{ nS}$

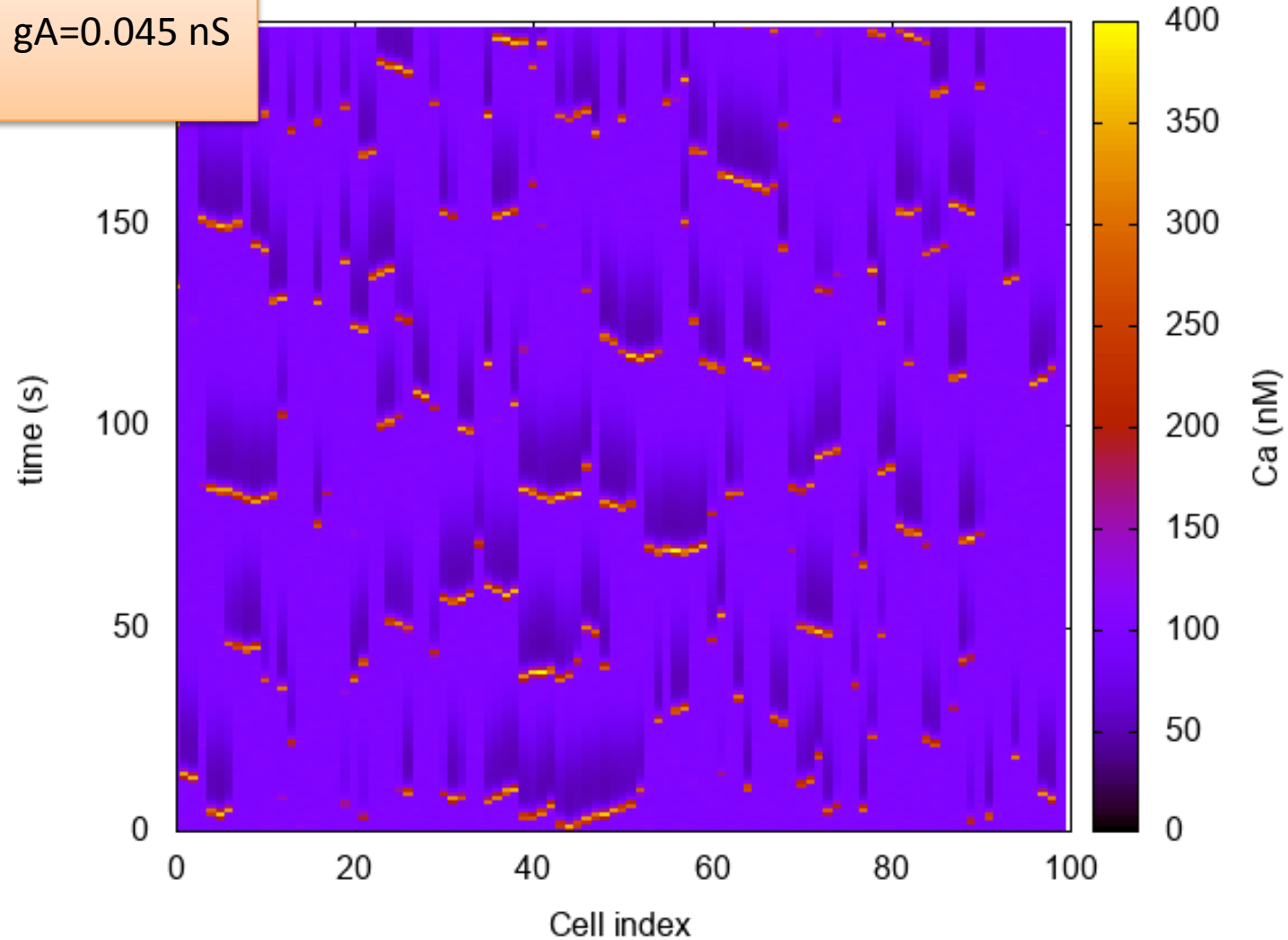

Waves propagation

$g_A = 0.07 \text{ nS}$

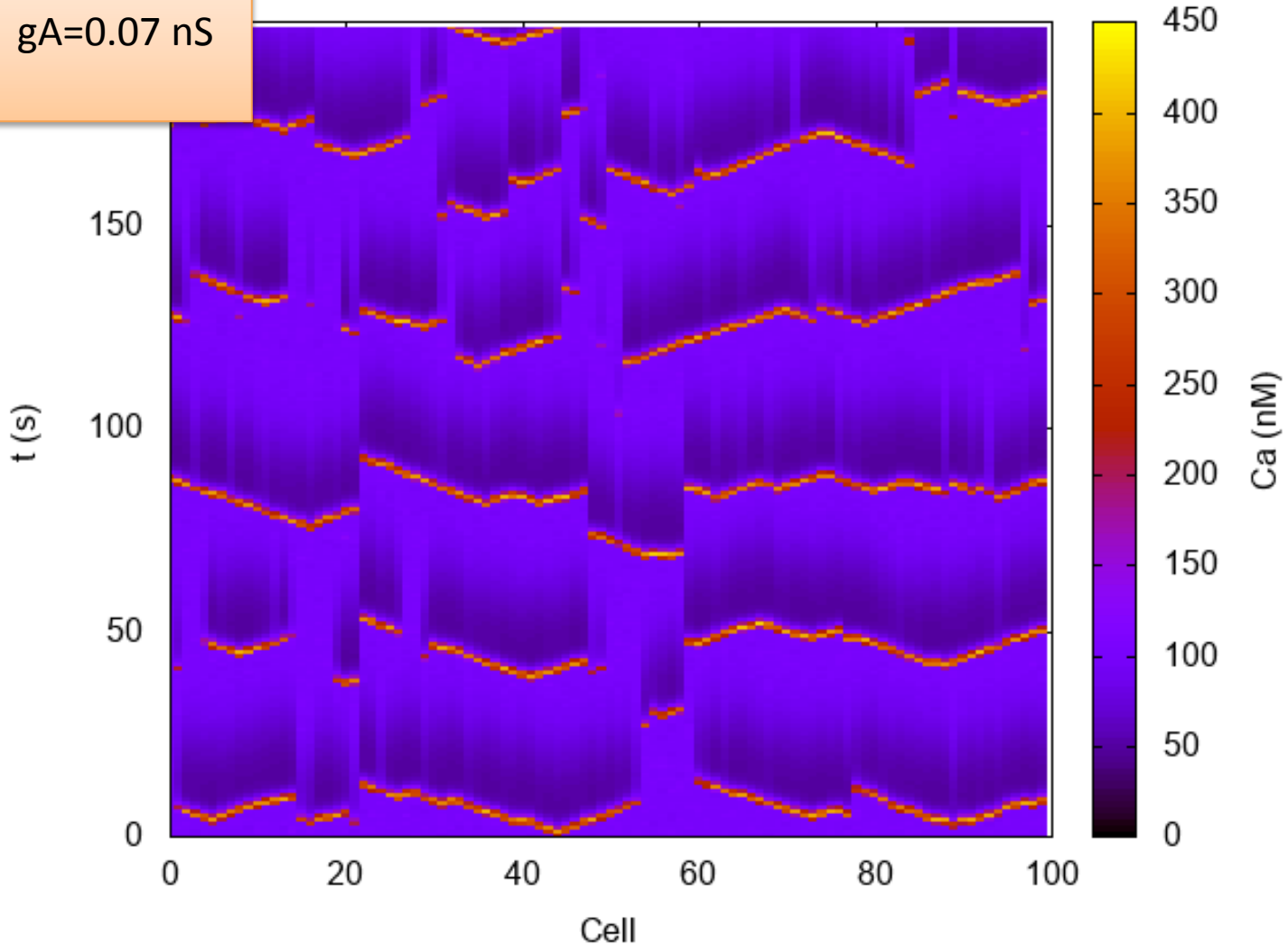

Waves propagation

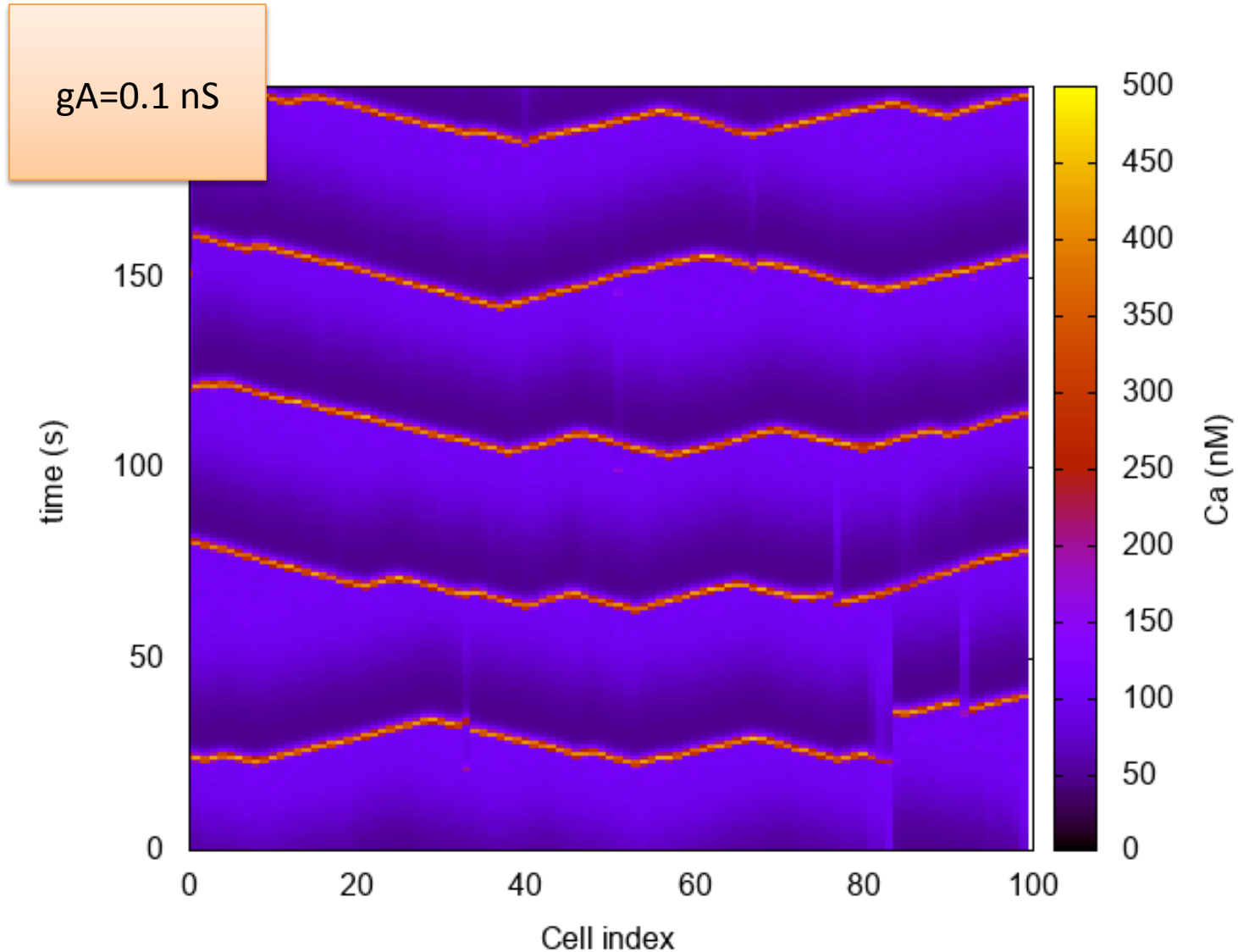

Network of SACs : Simulated Voltage

Isolated Neurons

$g_{ach}=0.126 \text{ nS}$

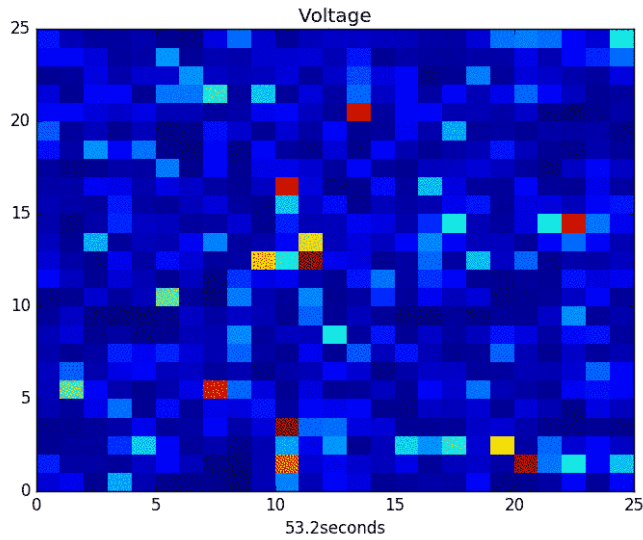

$g_{ach}=0.168 \text{ nS}$

$g_{ach}=0.21 \text{ nS}$

Network of SACs : Simulated Voltage

Isolated Neurons

$g_{ach}=0.126$ nS

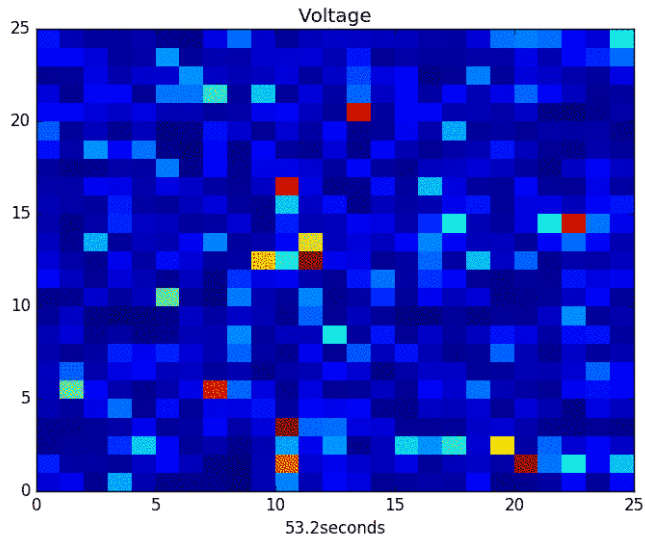

$g_{ach}=0.168$ nS

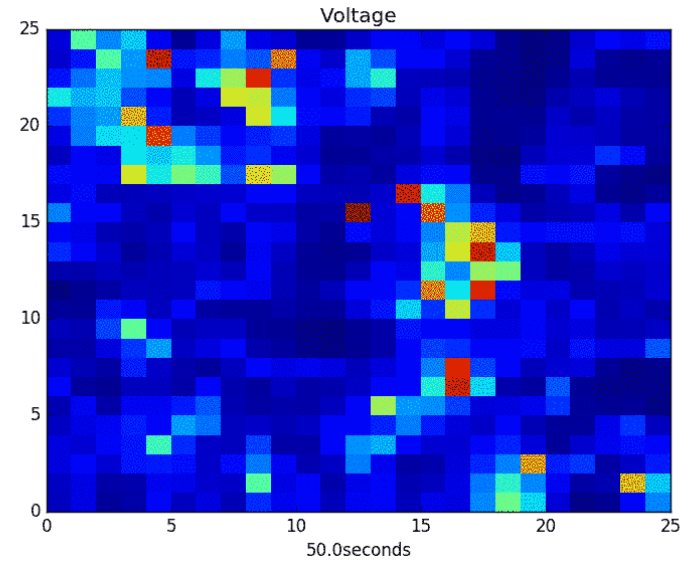
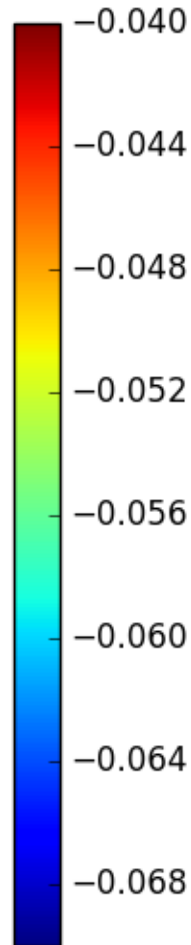

$g_{ach}=0.21$ nS

Network of SACs : Simulated Voltage

Isolated Neurons

$g_{ach}=0.126 \text{ nS}$

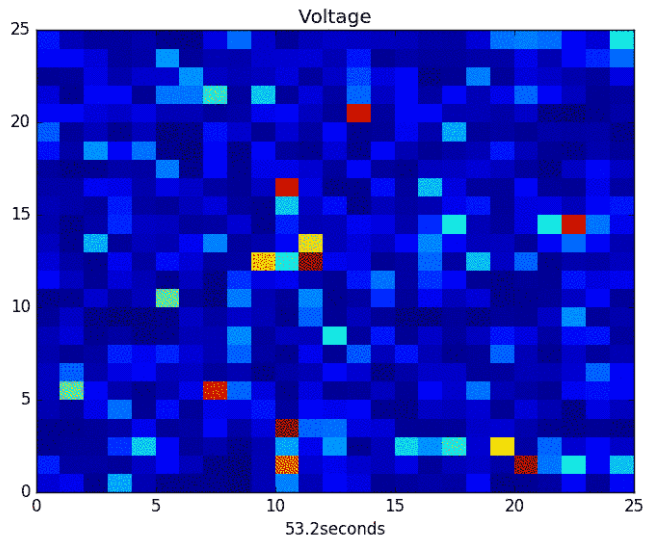

$g_{ach}=0.168 \text{ nS}$

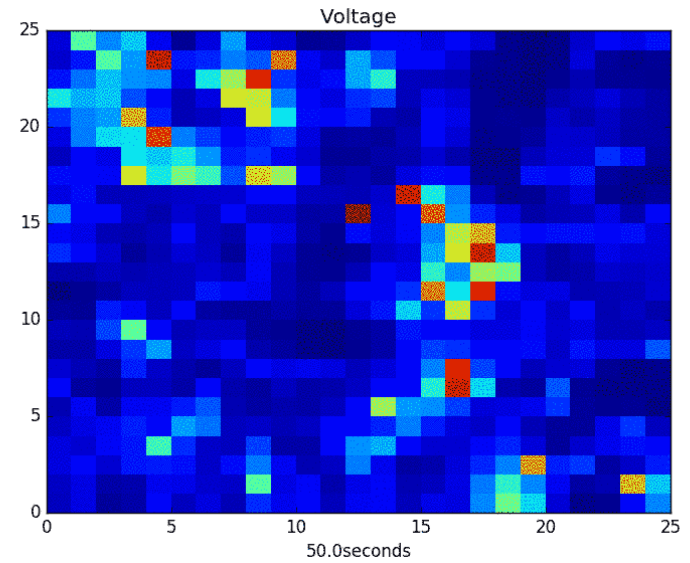
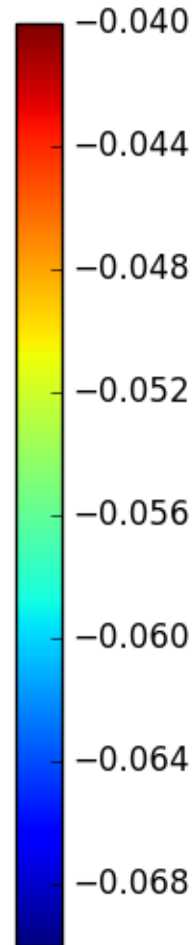
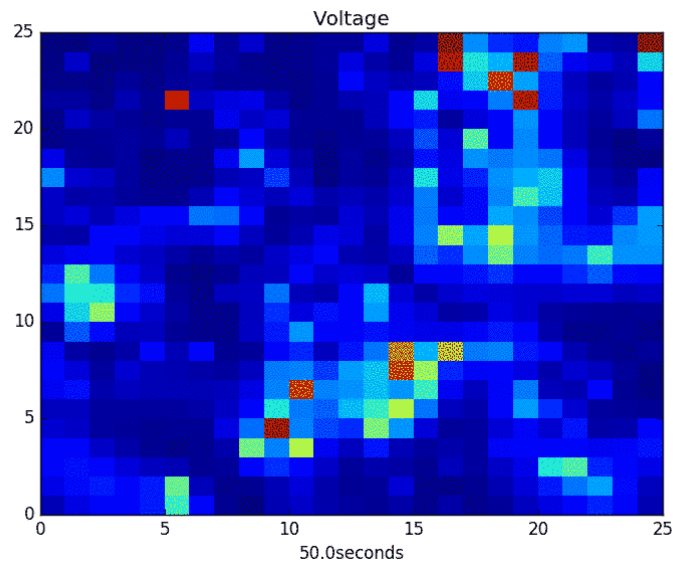

$g_{ach}=0.21 \text{ nS}$

Network of SACs : Simulated Voltage

Isolated Neurons

$g_{ach}=0.126 \text{ nS}$

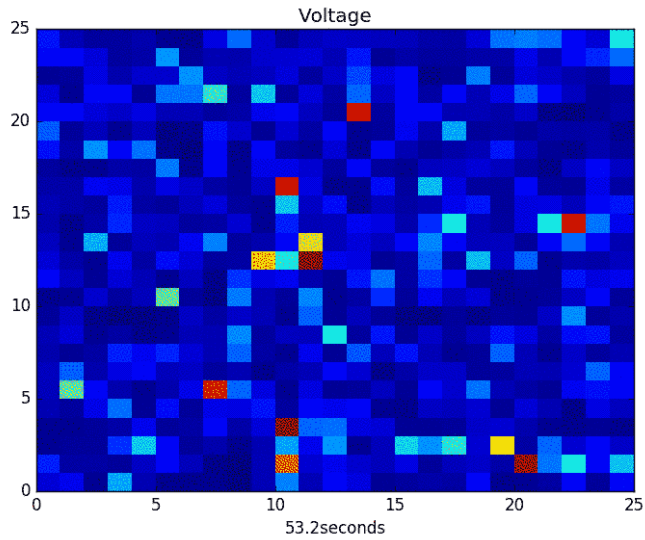

$g_{ach}=0.168 \text{ nS}$

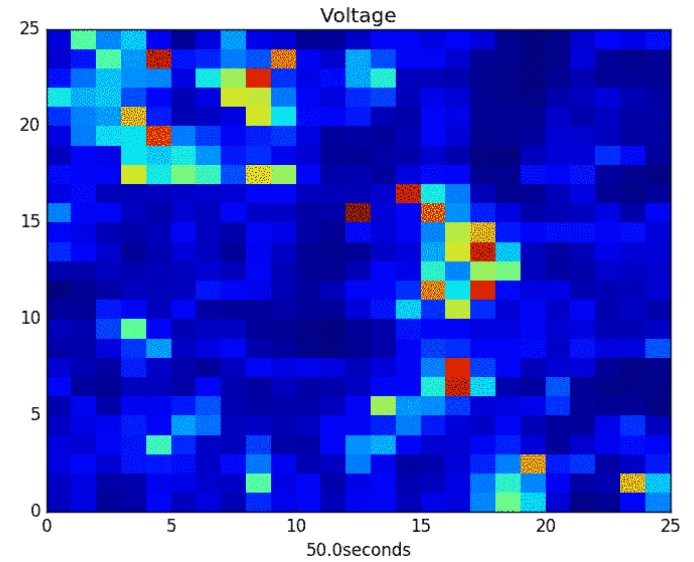
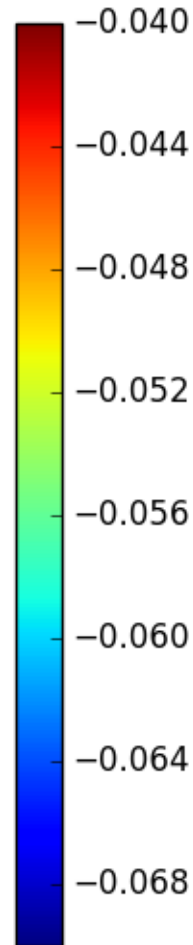

$g_{ach}=0.21 \text{ nS}$

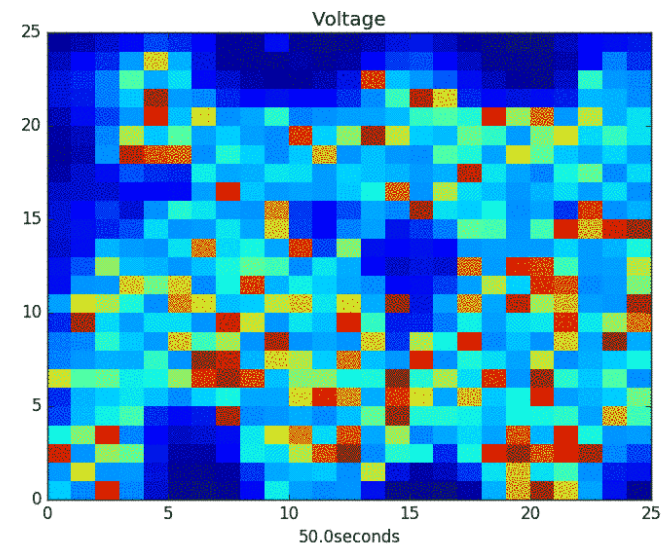
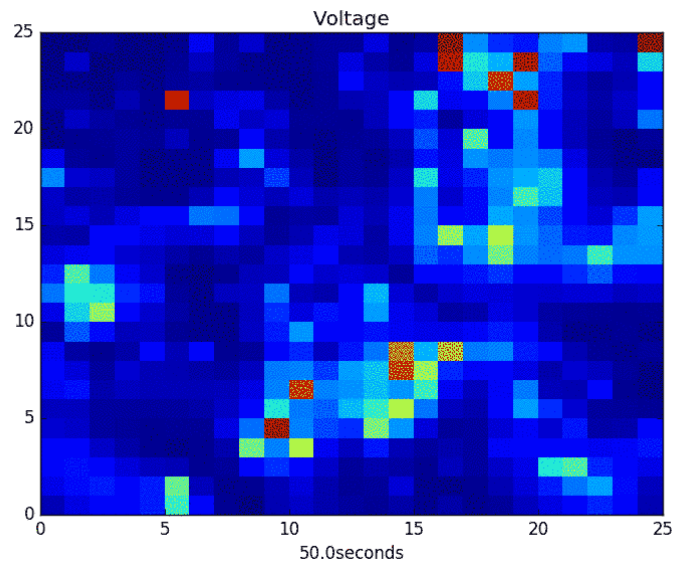

Network of SACs : Simulated Calcium Concentration

$g_{ach}=0.102$ nS

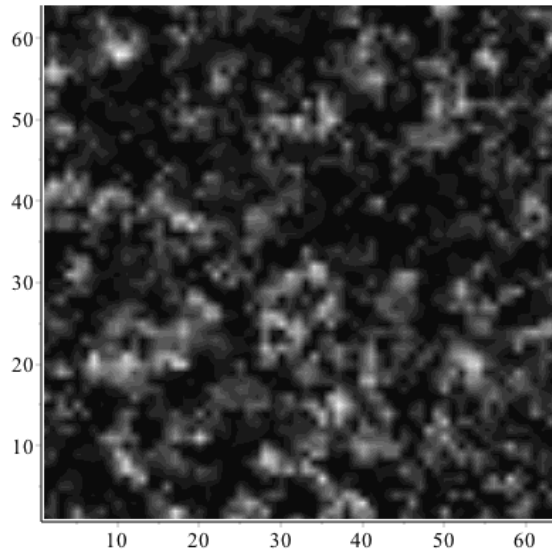

$g_{ach}=0.126$ nS

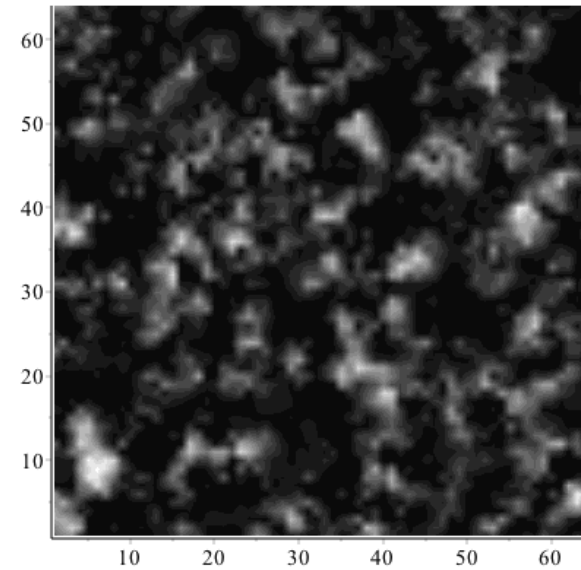

$g_{ach}=0.168$ nS

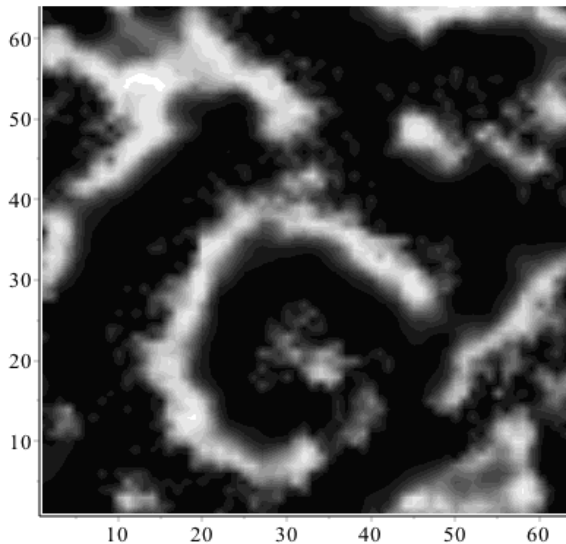

$g_{ach}=0.21$ nS

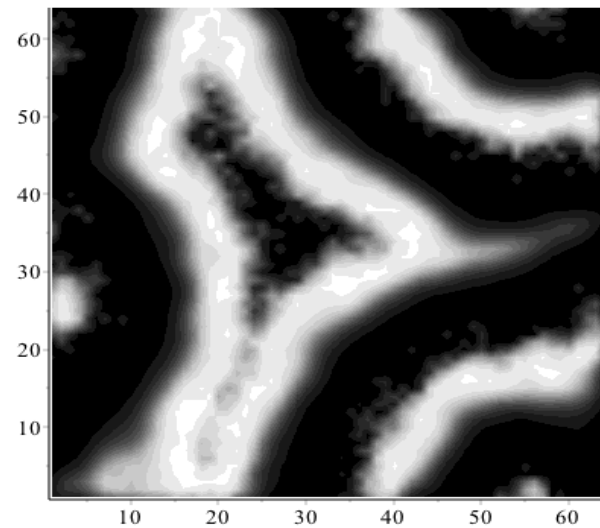

Network of SACs : Simulated Calcium Concentration

$g_{ACH} = 0.102 \text{ nS}$

$g_{ACH} = 0.126 \text{ nS}$

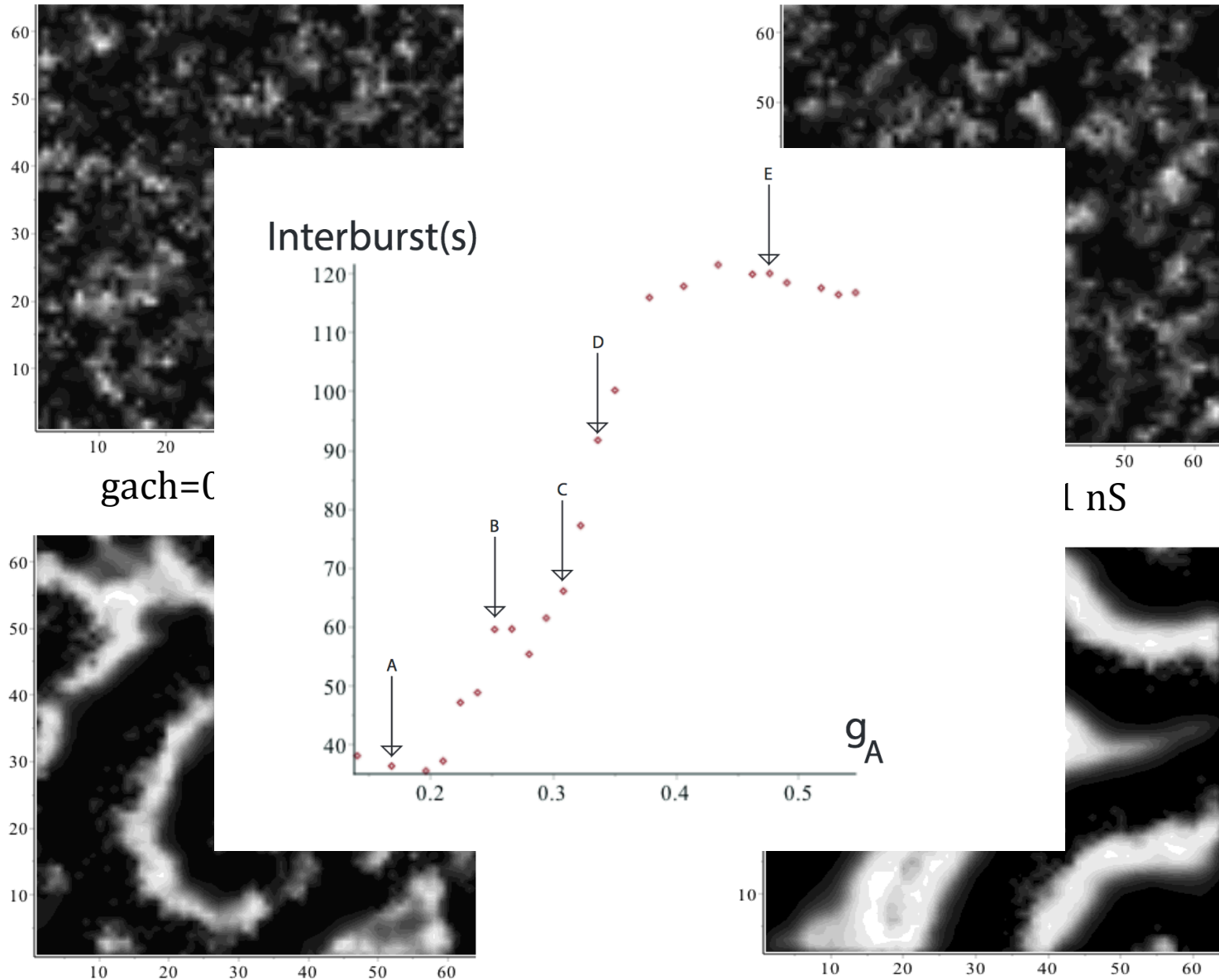

Waves size distribution

lin-log

log-log

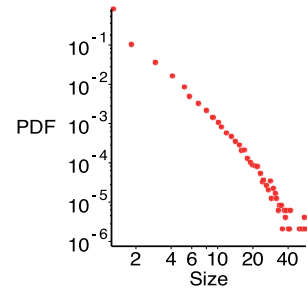
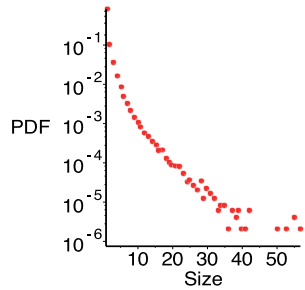
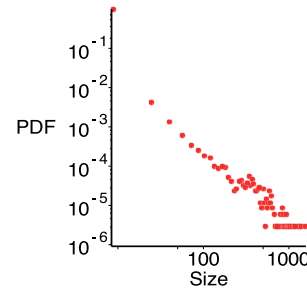
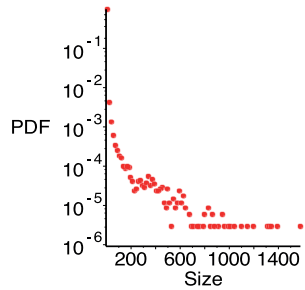
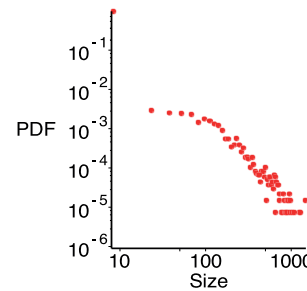
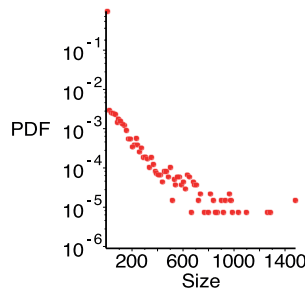
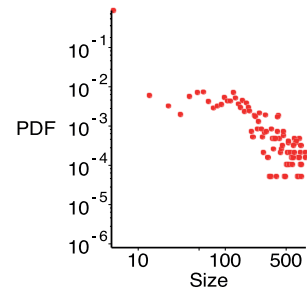
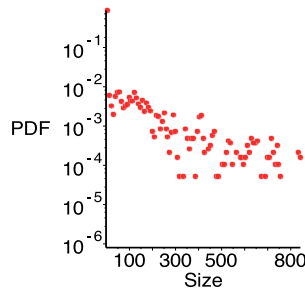
A**B****C****E**

Interburst(s)

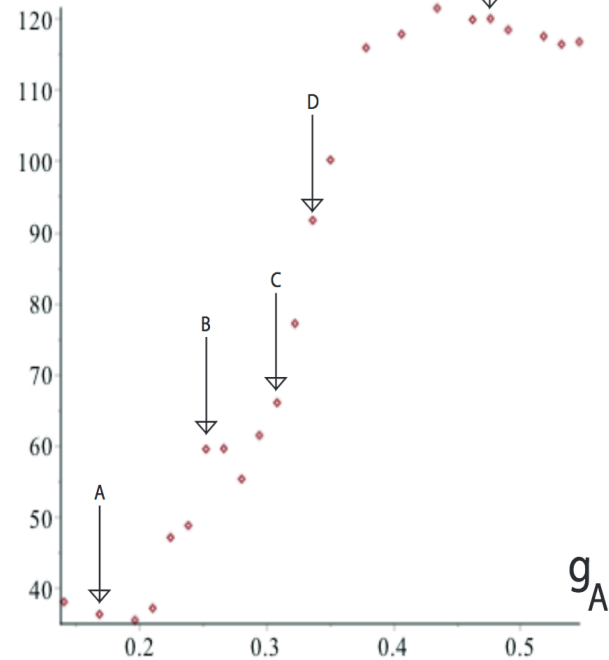

Distance Pairwise Correlations

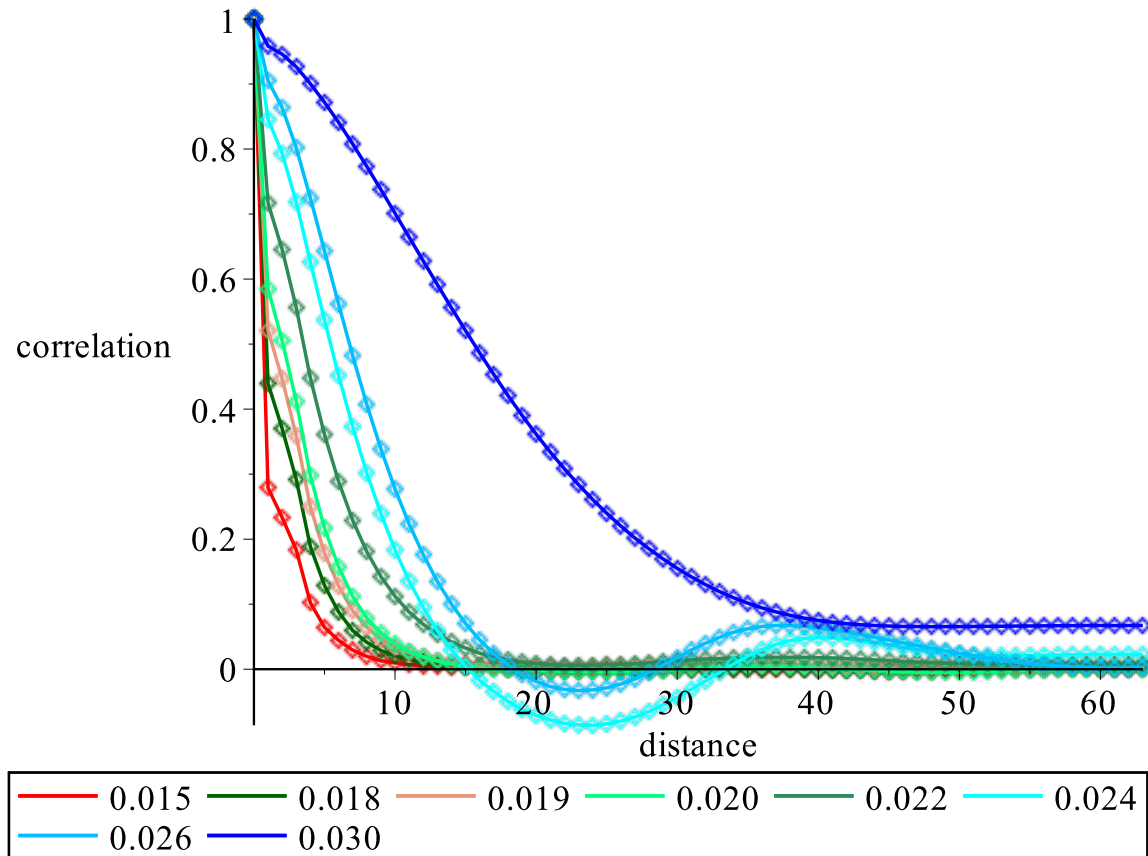

Variability within retinal waves

ii) Development

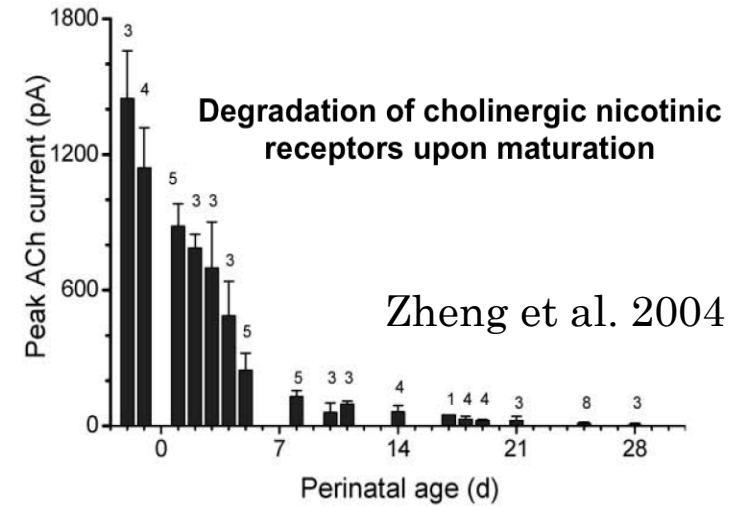

iv) Spatial Variability

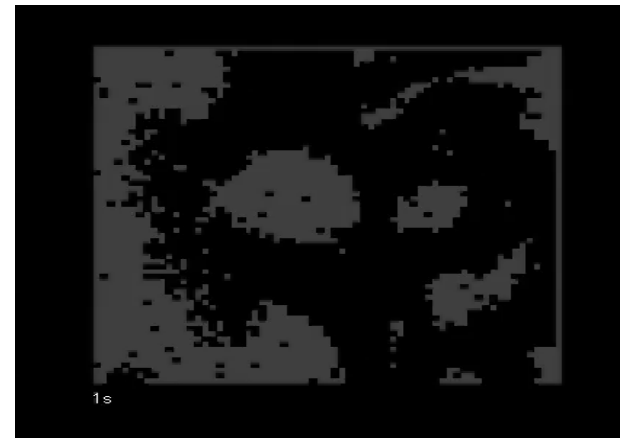

Variability within retinal waves

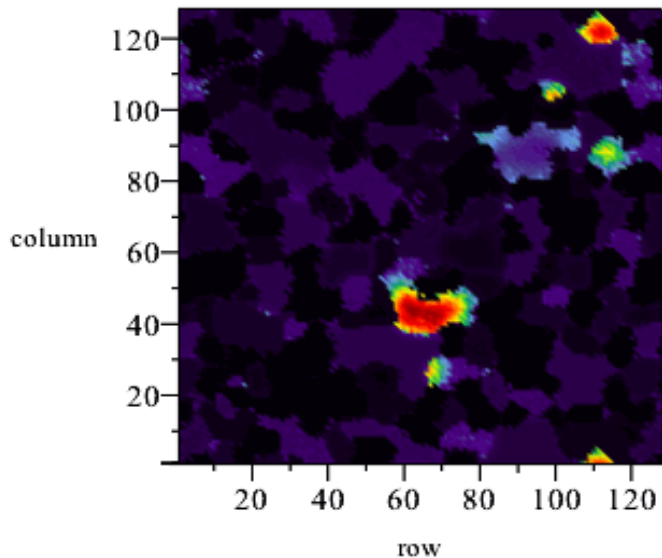

<https://www.youtube.com/watch?v=shMR3NMCBDE>

ii) Development

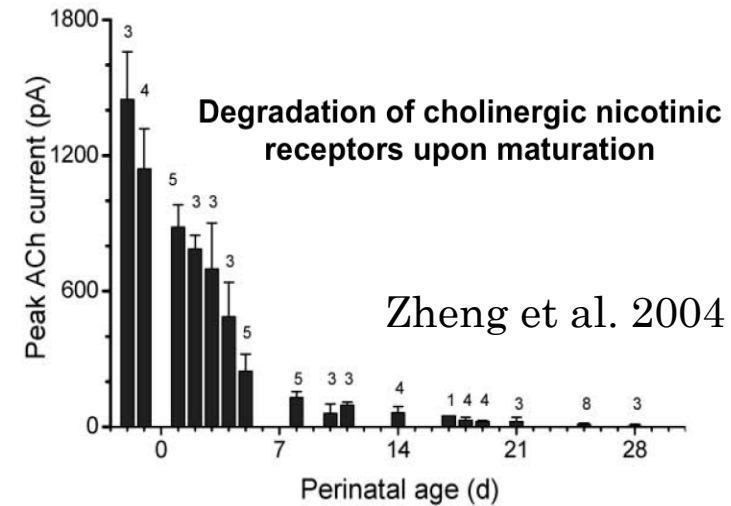

iv) Spatial Variability

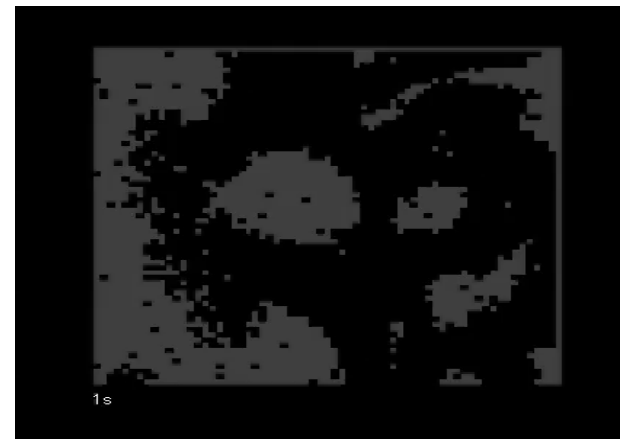

N-neuron model

- There is a **competition** between 2 mechanisms:
 - **Period variability** which tends to **desynchronise**
 - **Acetylcholine** which tends to **synchronise**
- There is an intermediate regime of coupling, where **variability** is maximum
- Therefore there is a wide repertoire of patterns
 - **Weak coupling** leads to small **localised activity**
 - **Moderate coupling** leads to **propagating patterns**
 - **Strong coupling** leads to **complete synchrony** of neurons

A transport theory of retinal waves

1. The leading parameters are the Ach conductance G_A and the sAHP conductance G_S .

C

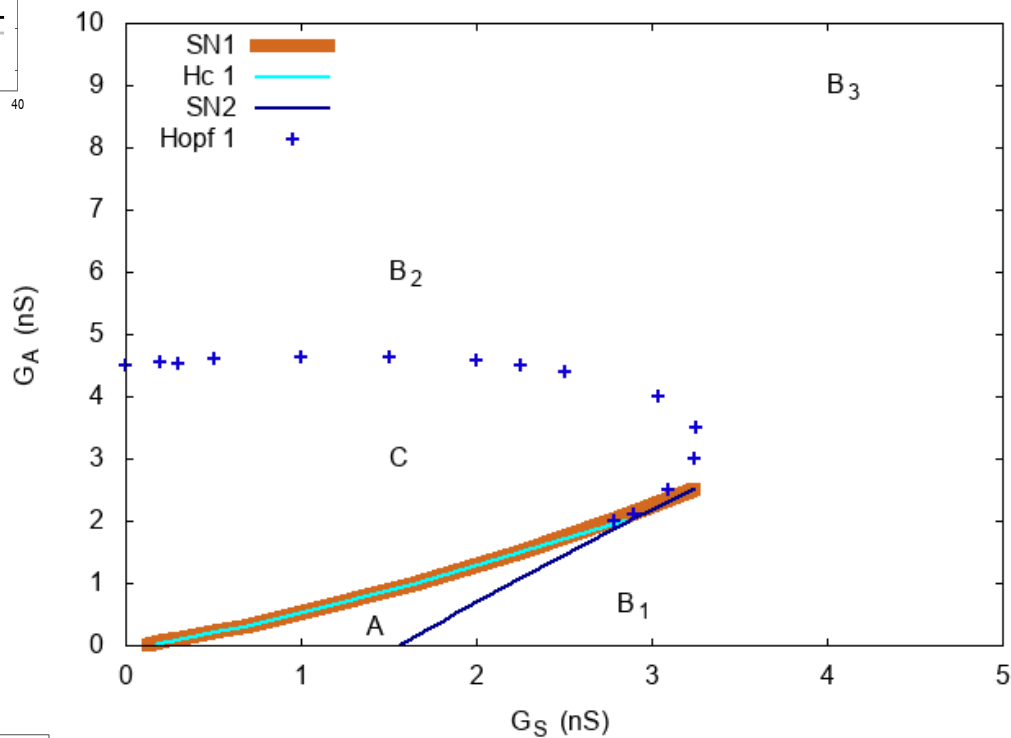
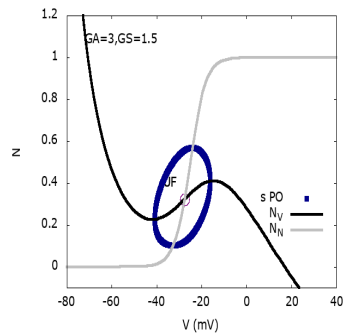

B2

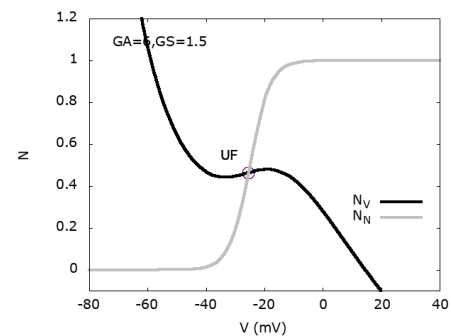

B1

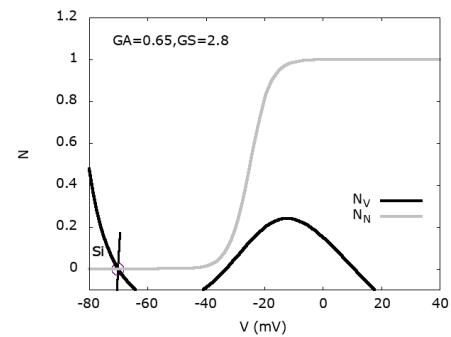

A

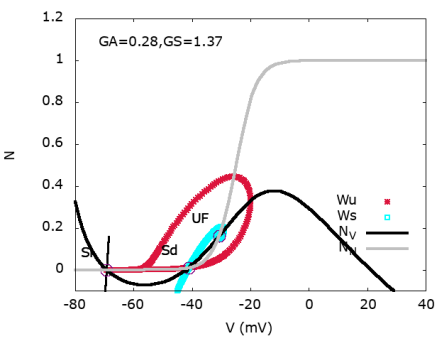

$\kappa = 200 \text{ V}^{-1}, V_0 = -40 \text{ mV}$

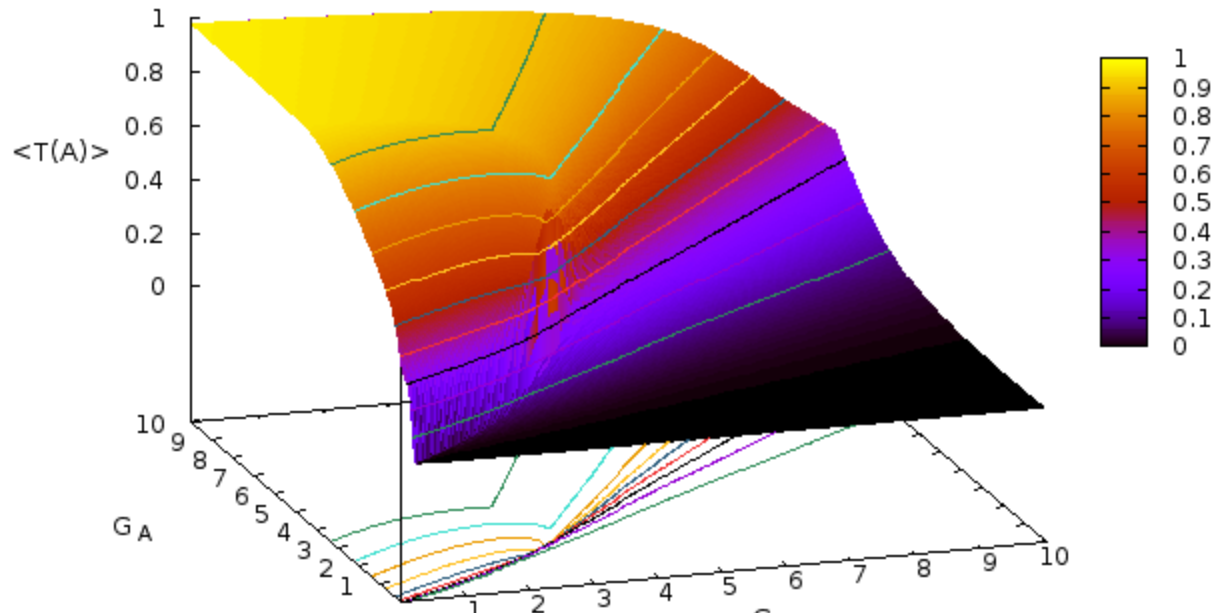

Kardar-Parisi-Zhang like equations

$$\frac{\partial G_A}{\partial t} = g_A D_M \left[(\nabla G_S, \nabla G_A) D_H^2 \left(\begin{array}{c} \nabla G_S \\ \nabla G_A \end{array} \right) + \frac{\partial H}{\partial G_S} \Delta G_S + \frac{\partial H}{\partial G_A} \Delta G_A \right] + S(G_S, G_A).$$

A transport theory of retinal waves

1. The leading parameters are the Ach conductance G_A and the sAHP conductance G_S .
2. Waves history generates transient refractory zones of sAHP which constrain the forthcoming waves propagation.

C

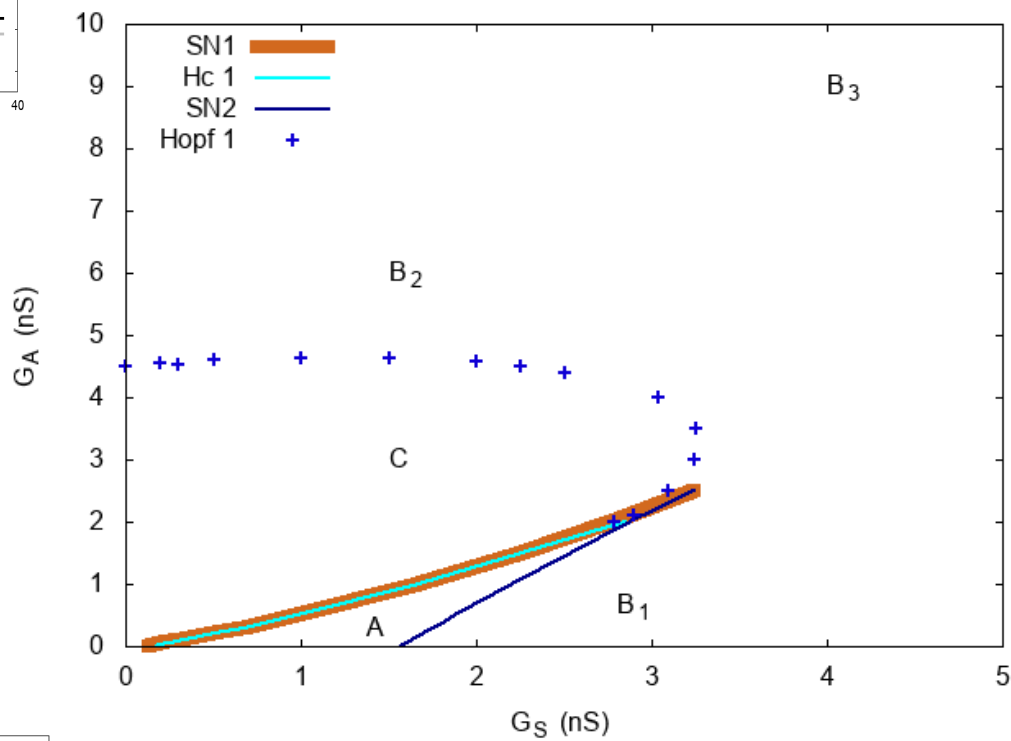
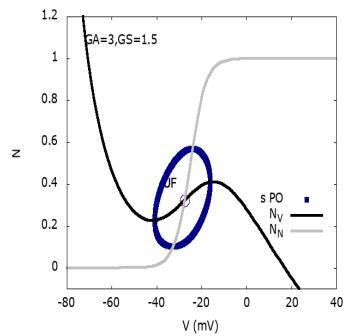

B2

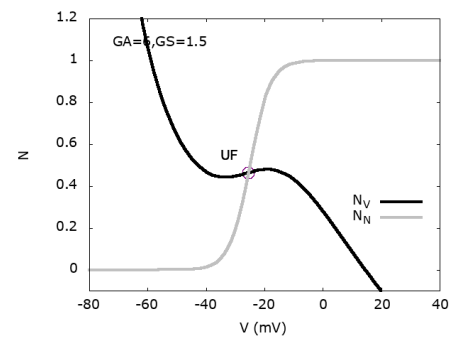

B1

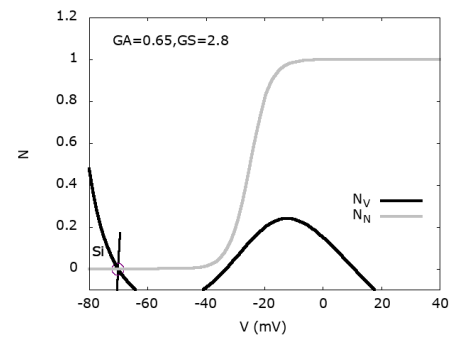

A

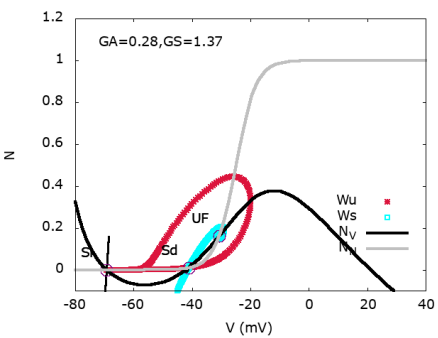

C

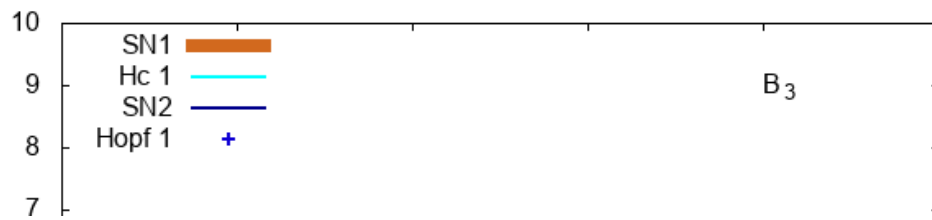
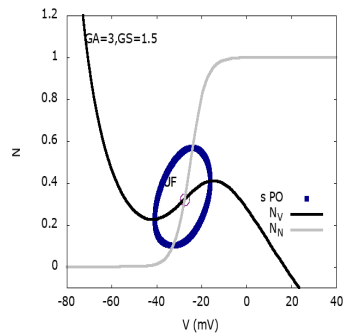

GA (nS)

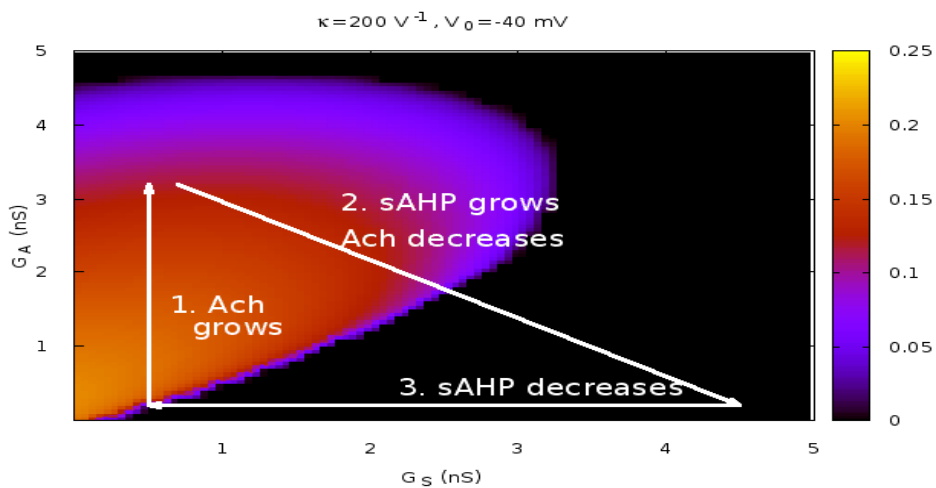

B2

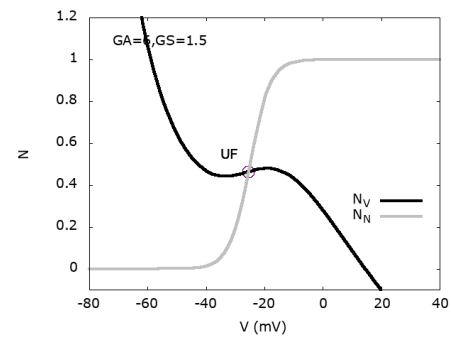

B1

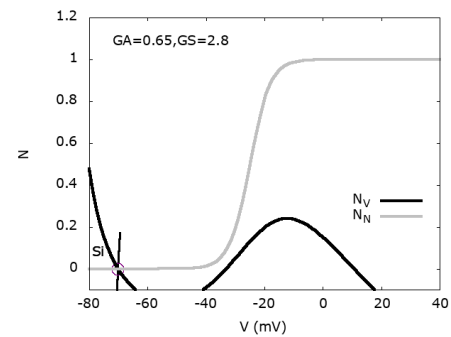

A

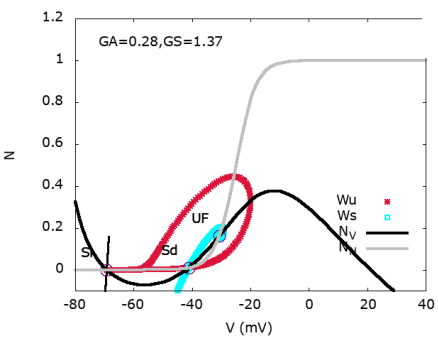

Variability within retinal waves

i) Across species

Godfrey et al. 2007

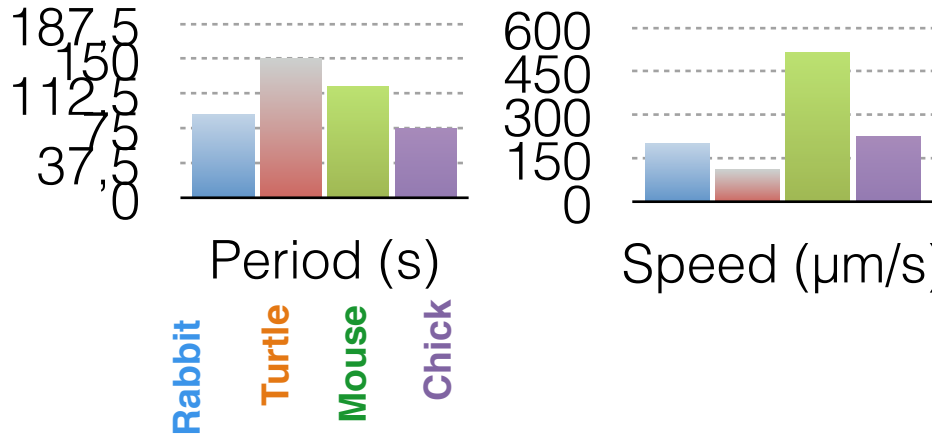

ii) Development

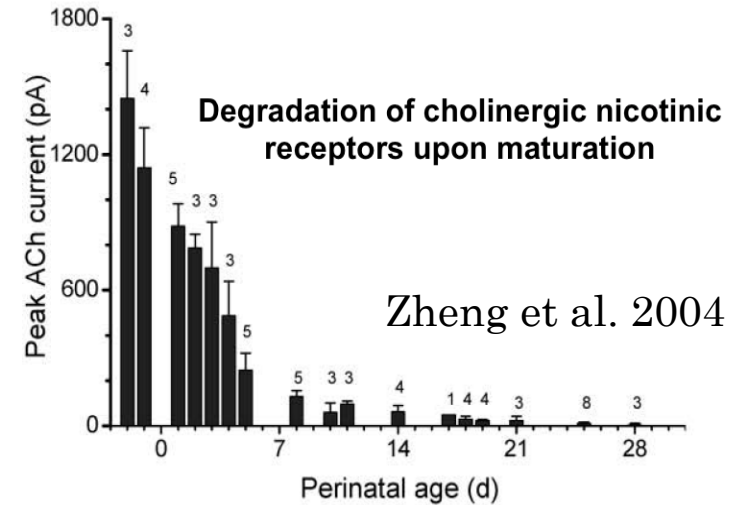

iii) Pharmacology

P4

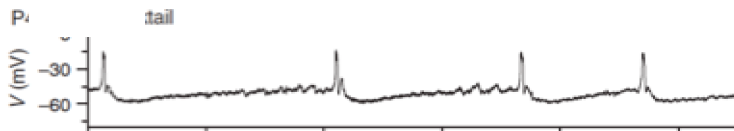

P8

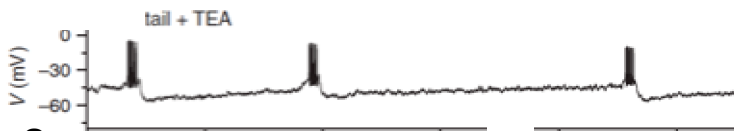
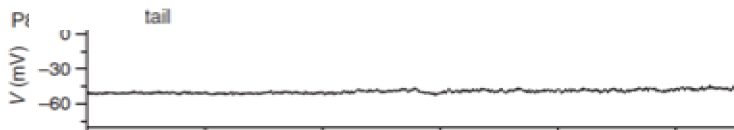

0 Time (sec) 50

iv) Spatial Variability

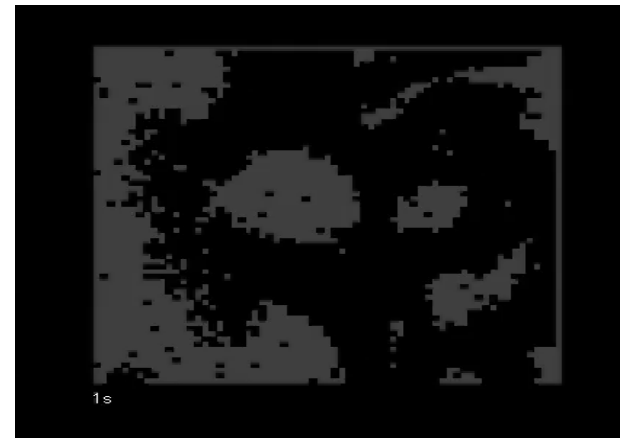

Variability within retinal waves

i) Across species

Godfrey et al. 2007

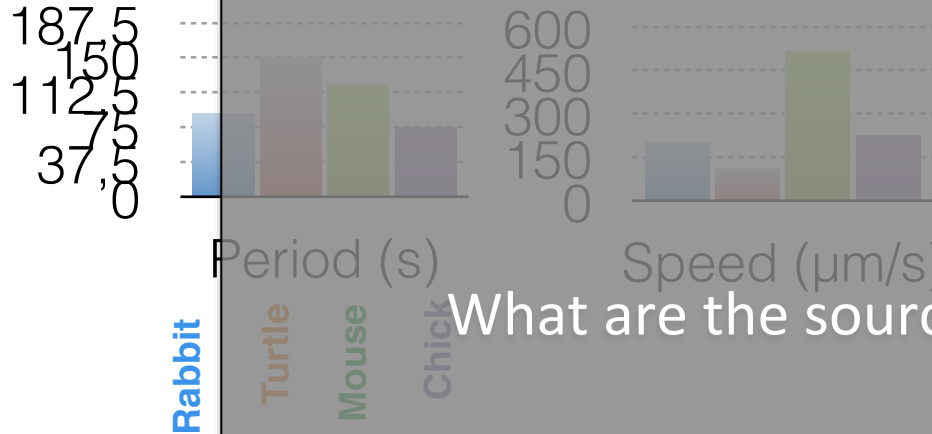

ii) Development

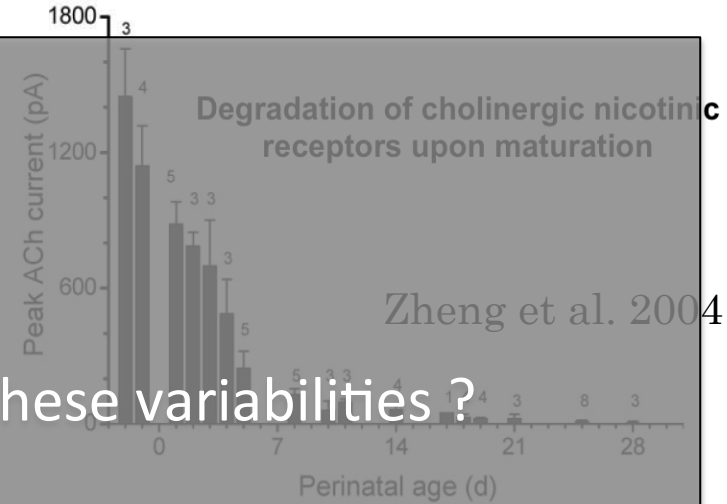

What are the sources of these variabilities?

Is there a unique, global, mechanism explaining them?

iii) Pharmacology

P4



P8

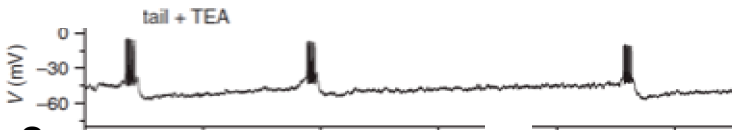

0 Time (sec) 50

iv) Spatial Variability

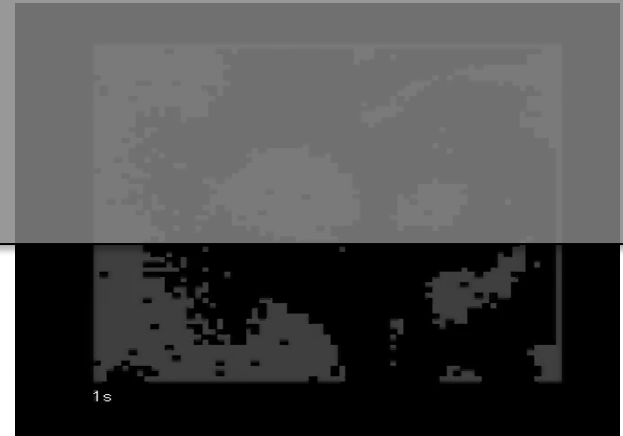

Variability within retinal waves

i) Across species

Godfrey et al. 2007

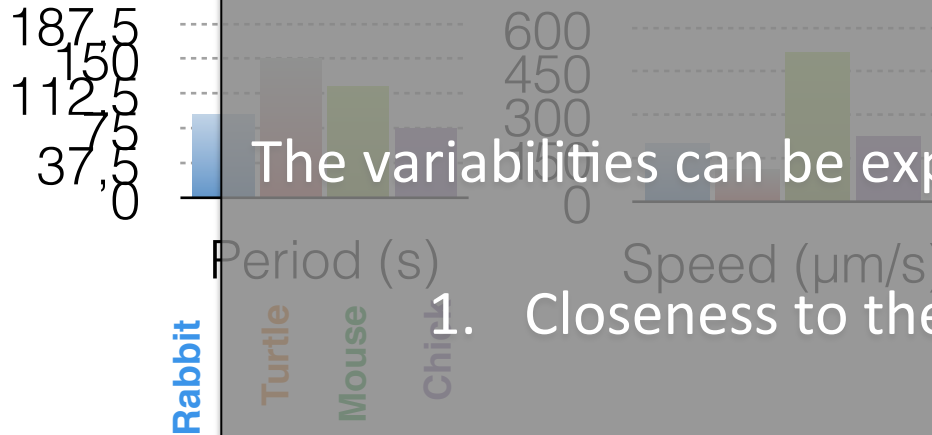

The variabilities can be explained with a unique mechanism:

1. Closeness to the saddle-node bifurcation;

2. Dynamic coupling via Ach.

3. Spatio-temporal variability of sAHP.

ii) Development

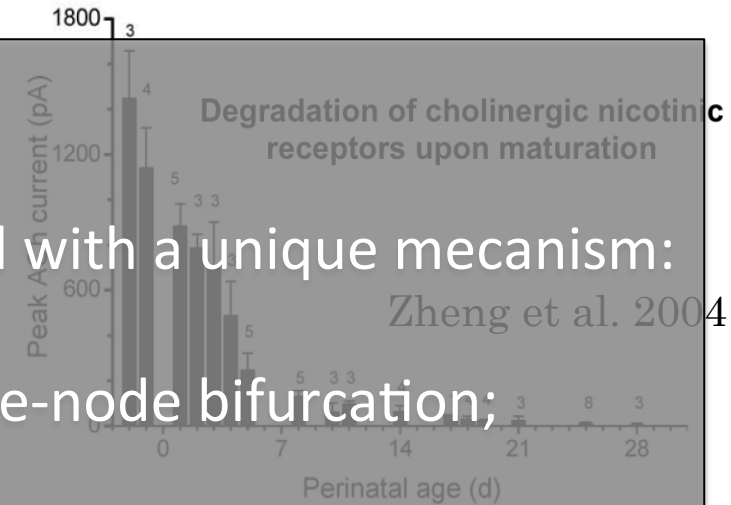

Zheng et al. 2004

iii) Pharmacology

P4



P8

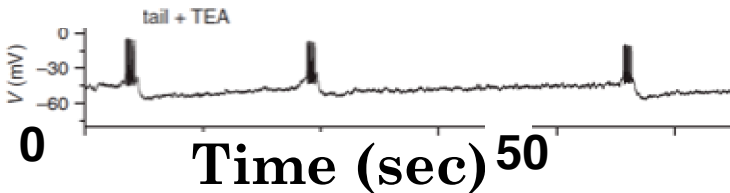

iv) Spatial Variability



Variability within retinal waves

i) Across species

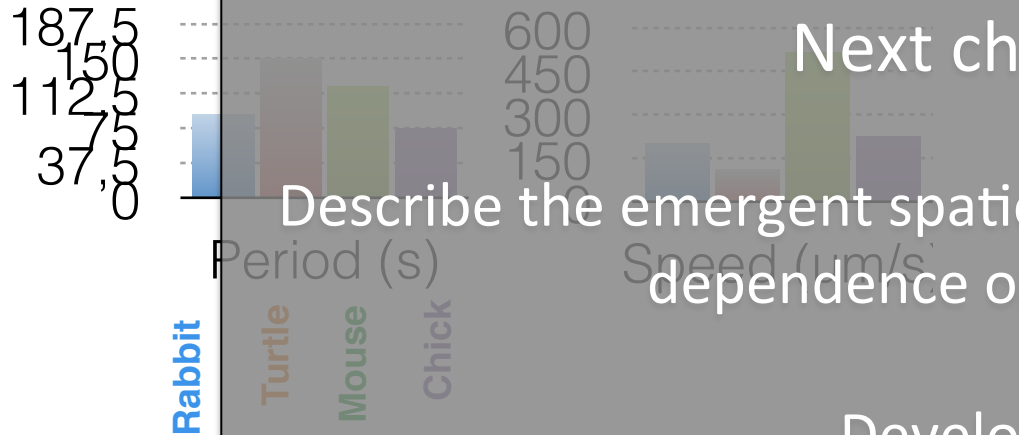

ii) Development

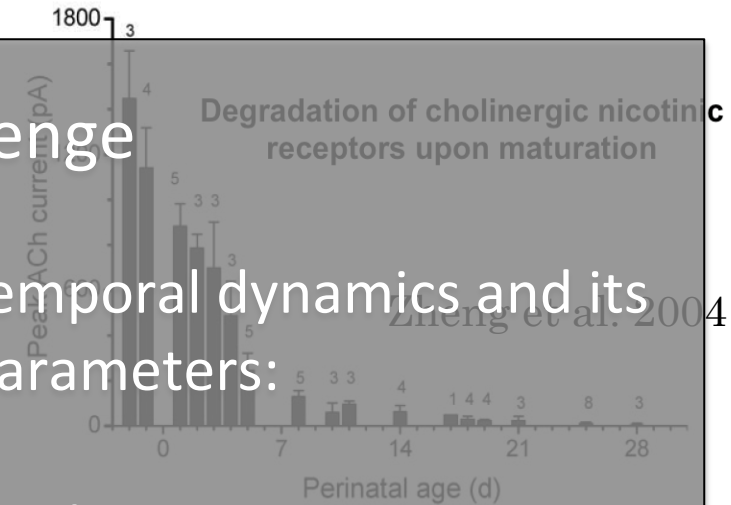

iii) Pharmacology

P4



P8

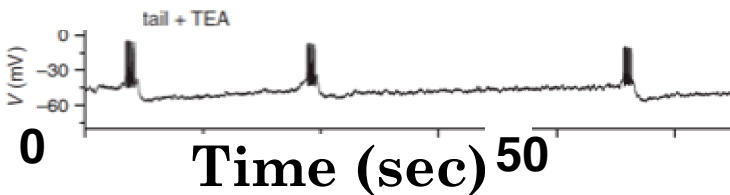

iv) Spatial Variability

Pharmacological control

Pathologies.



Next challenge

Describe the emergent spatio-temporal dynamics and its dependence on parameters:

Retinal anticipation

Random connectivity and motion
anticipation

S. Souihel (PhD 2016-2019), Biovision team,
INRIA, Sophia Antipolis

F. Chavane, INT, Marseille

A. Destexhe, UNIC, Paris

O. Marre, Institut de la Vision, Paris

B. Cessac, Biovision team, INRIA, Sophia Antipolis



Project : ANR Trajectory.

The visual flow

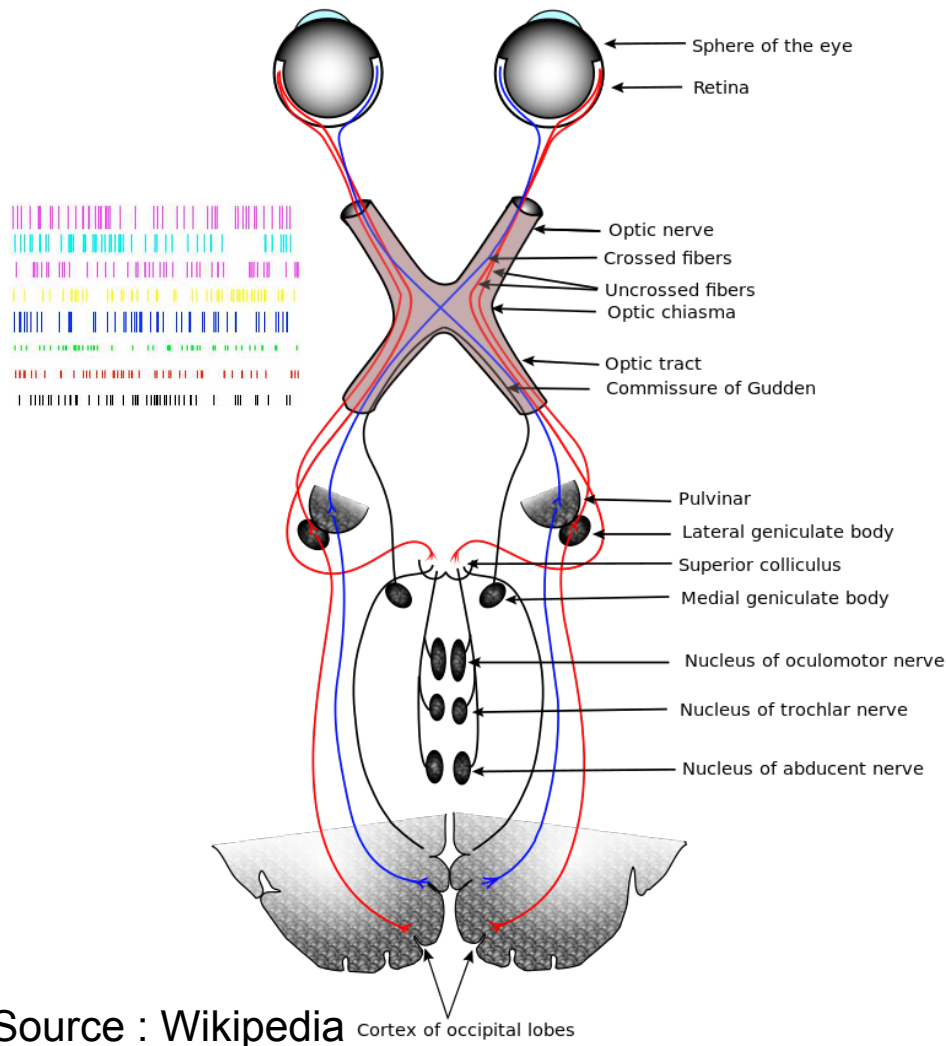

The visual flow

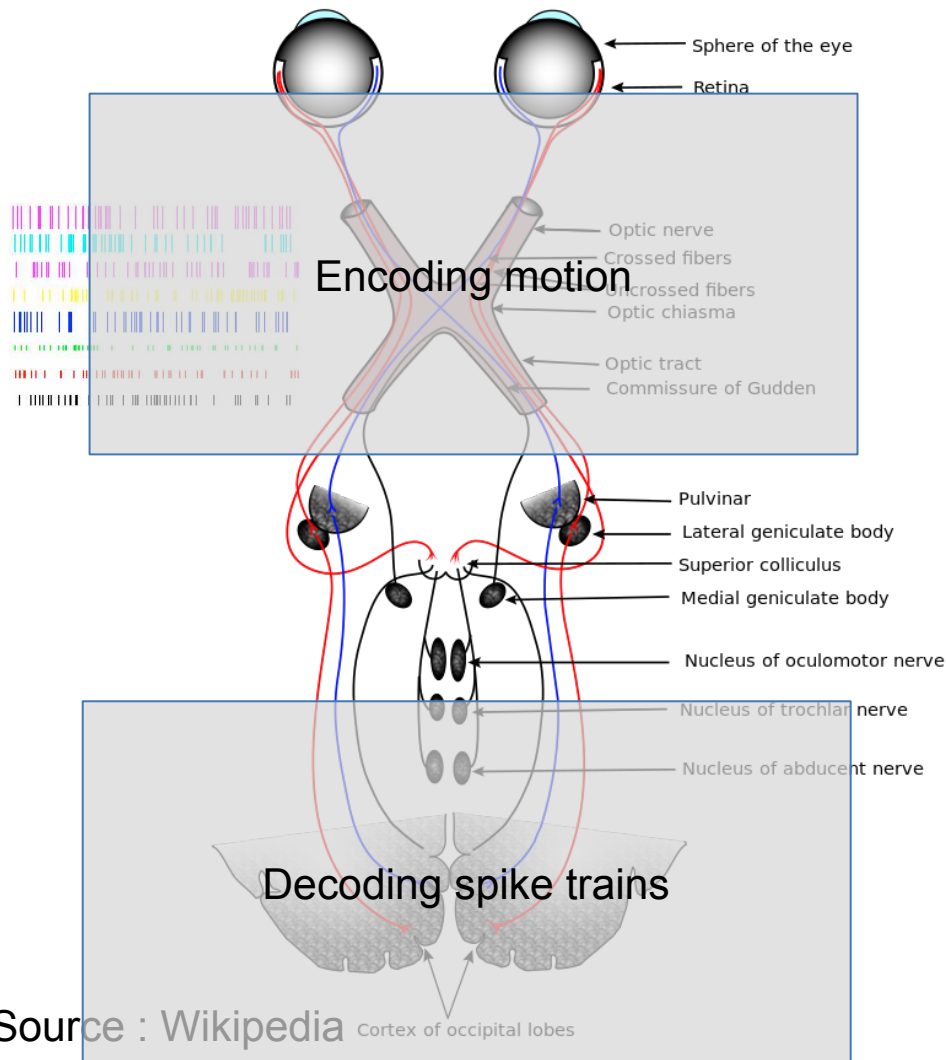

The visual flow

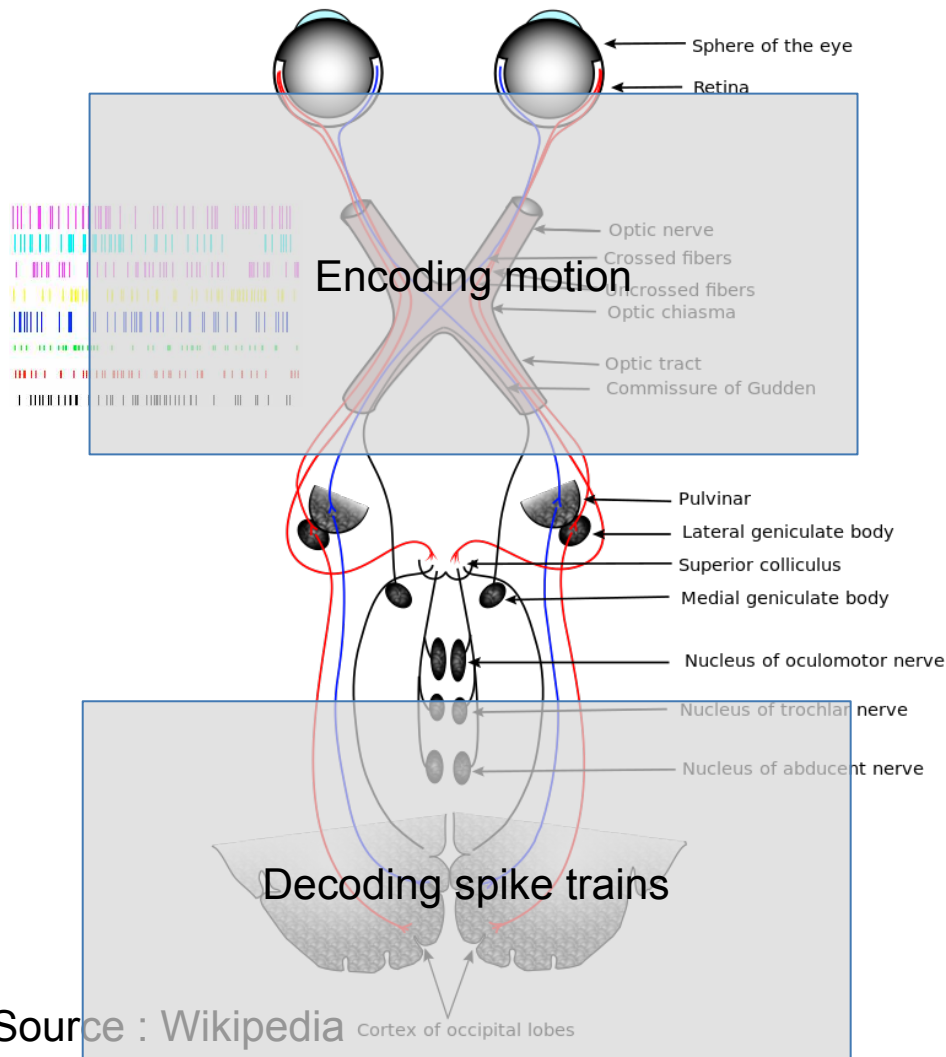

- **The retina is NOT a camera**
- High transduction rate : 1 photon can trigger a membrane voltage variation of ~1 mV
- Able to detect approaching motion
- Able to detect differential motion
- Sensitive to « surprise » in a visual scene
- Able to perform motion anticipation

The visual flow

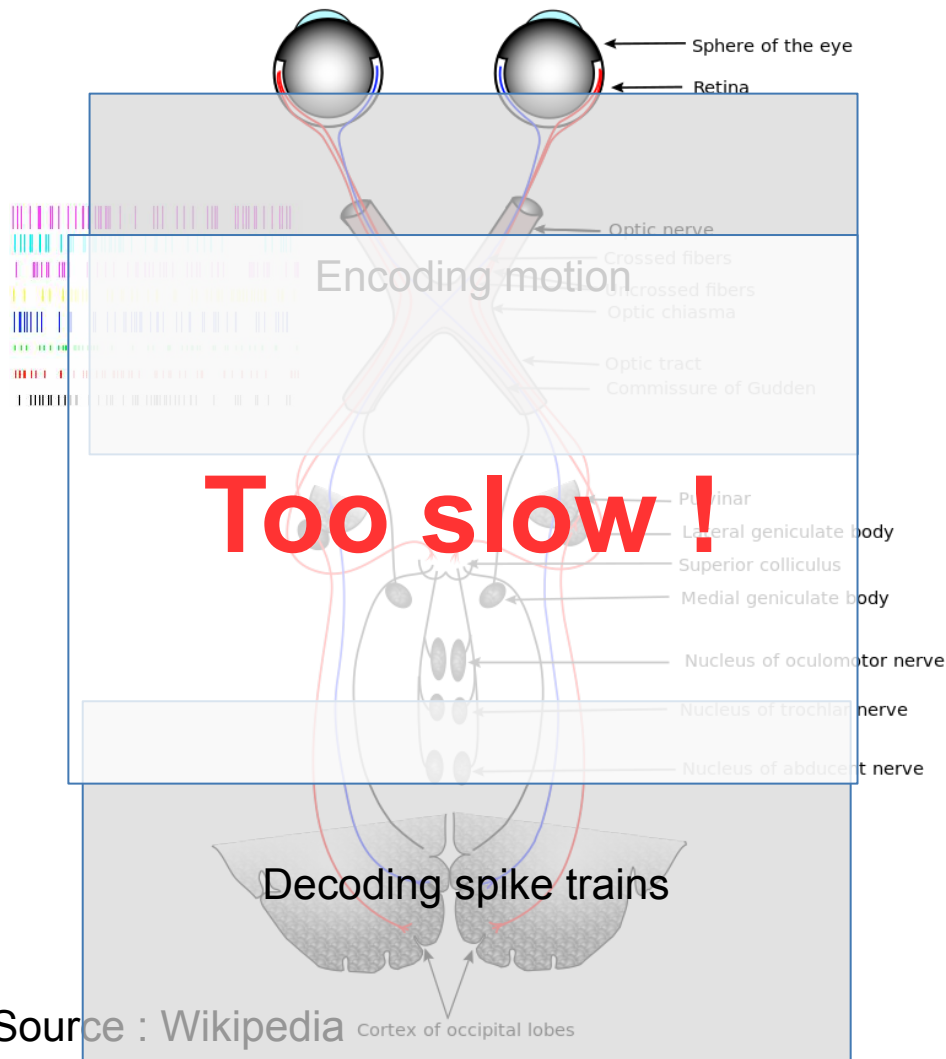

- **The retina is NOT a camera**
- High transduction rate : 1 photon can trigger a membrane voltage variation of ~1 mV
- Able to detect approaching motion
- Able to detect differential motion
- Sensitive to « surprise » in a visual scene
- Able to perform motion anticipation

Visual Anticipation

Anticipation is carried out by the primary visual cortex (V1) through an activation wave

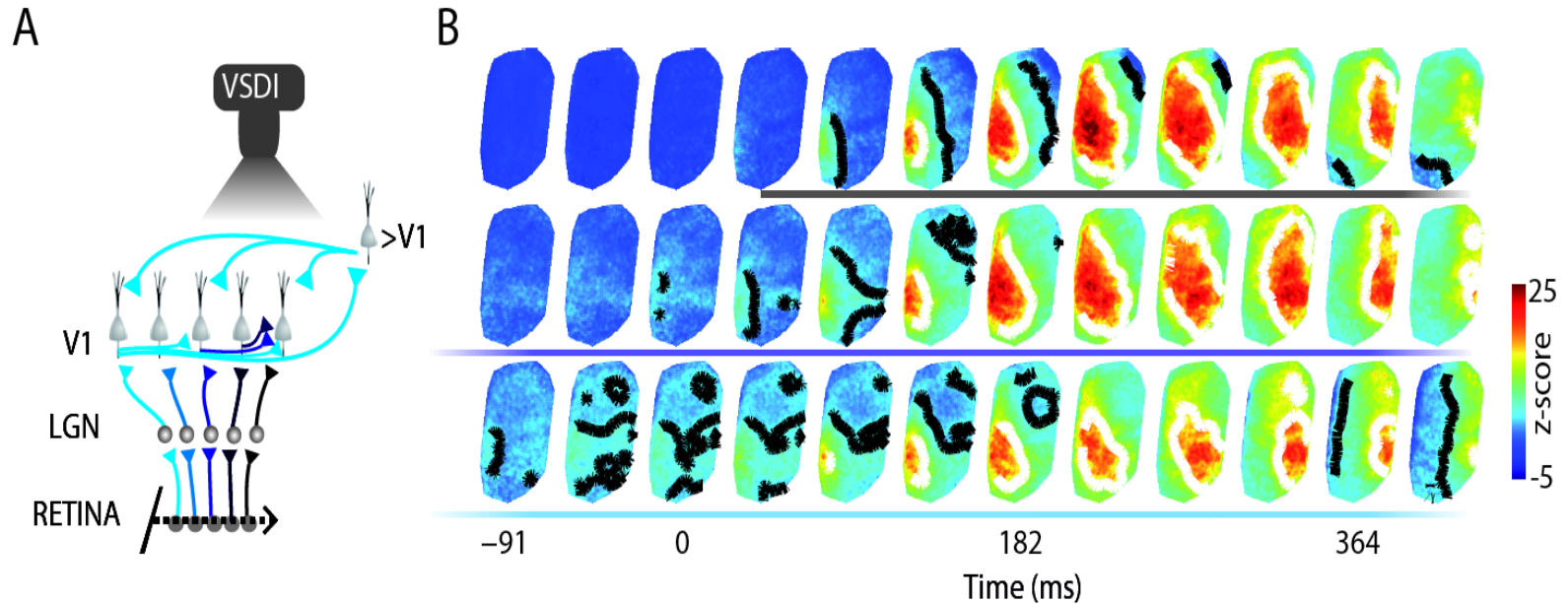

« Anticipatory responses along motion trajectories in awake
2 monkey area V1 », Benvenuti et al. 2020, submitted to Elife and [https://www.biorxiv.org/content/
10.1101/2020.03.26.010017v2.full.pdf](https://www.biorxiv.org/content/10.1101/2020.03.26.010017v2.full.pdf)

Visual Anticipation

Anticipation also takes place in the retina

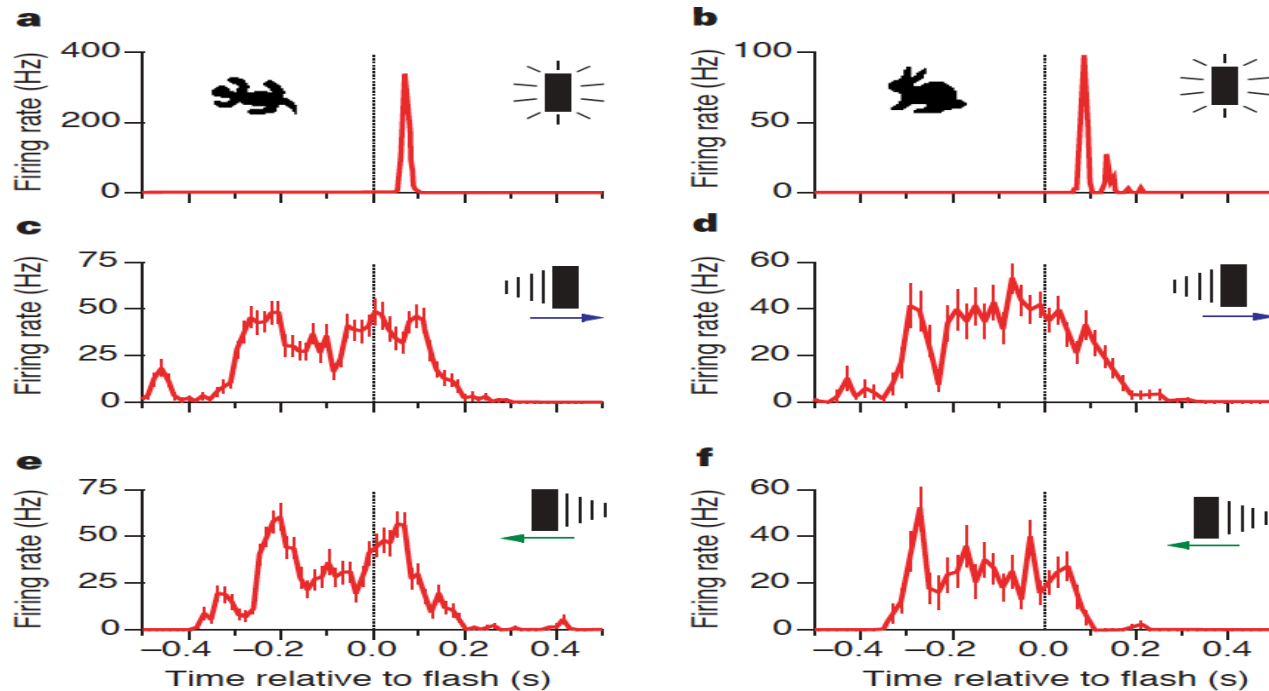

Source : M. Berry, I. Brivanlou, T. Jordan, and M. Meister. Anticipation of moving stimuli by the retina. *Nature*, 398(6725):334—338, 1999

Building a 2D retina model for motion anticipation

Souihel S., Cessac B., “On the potential role of lateral connectivity in retinal anticipation”, submitted to J. Math. Neuro.

Building a 2D retina model for motion anticipation

Souihel S., Cessac B., "On the potential role of lateral connectivity in retinal anticipation", submitted to J. Math. Neuro.

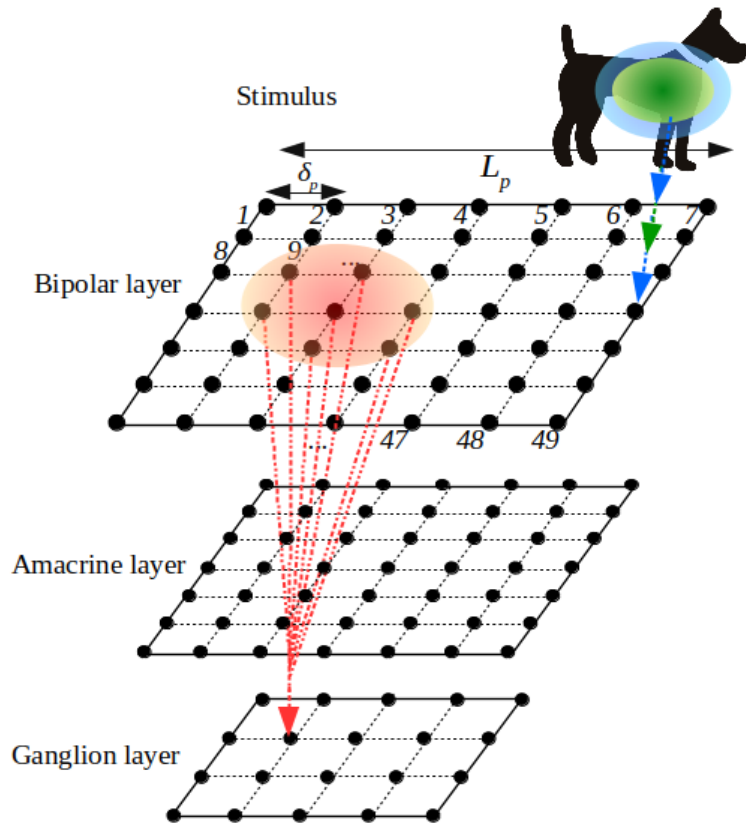

Building a 2D retina model for motion anticipation

Souihel S., Cessac B., "On the potential role of lateral connectivity in retinal anticipation", submitted to J. Math. Neuro.

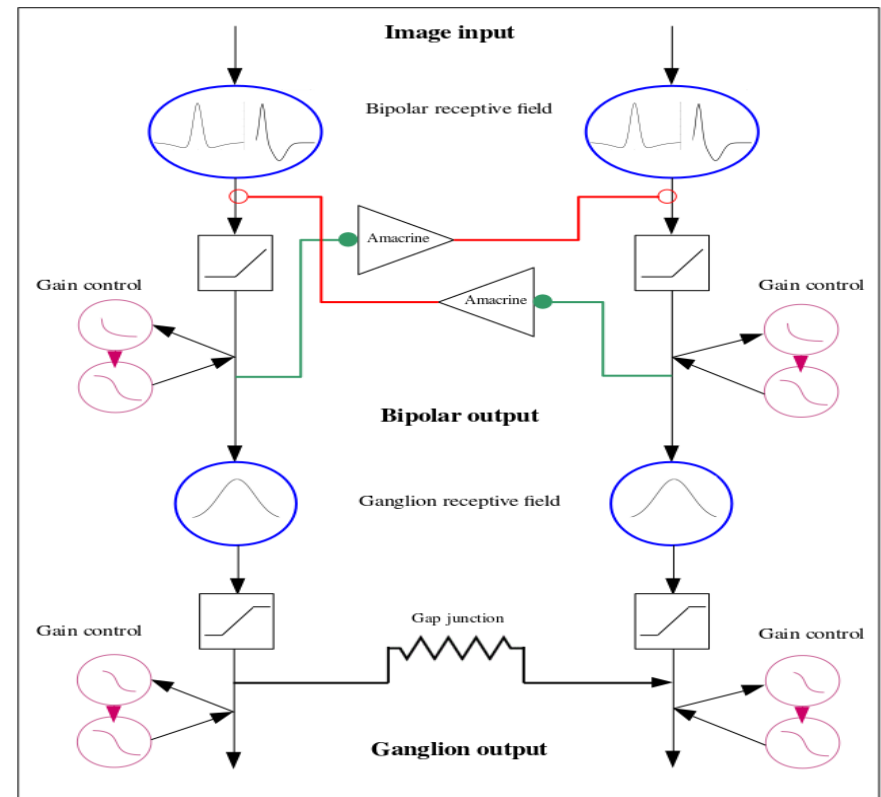
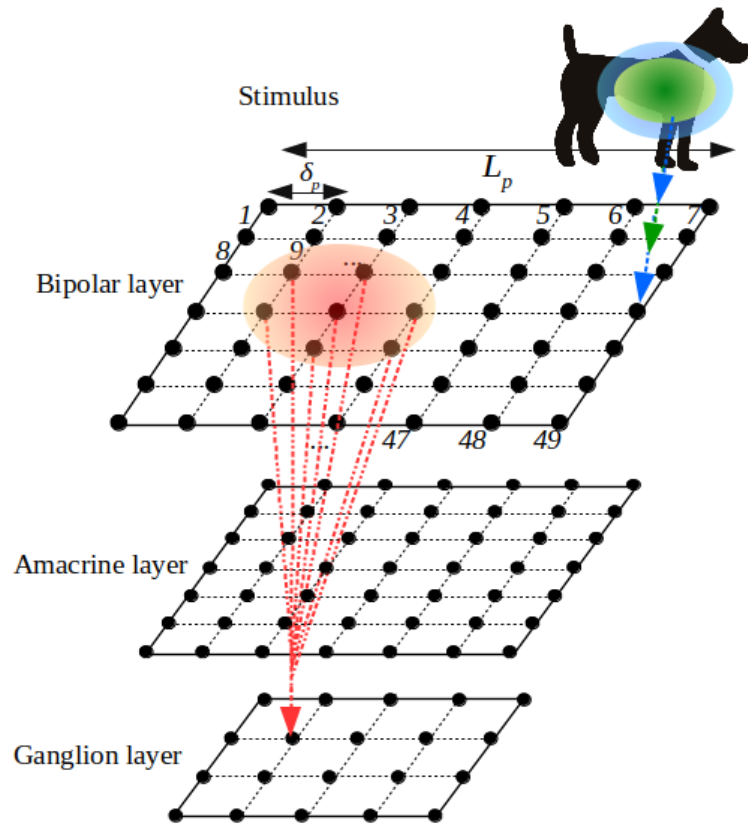

Building a 2D retina model for motion anticipation

Souihel S., Cessac B., “On the potential role of lateral connectivity in retinal anticipation”, submitted to J. Math. Neuro.

$$\begin{cases} \frac{dV_{B_i}}{dt} = -\frac{1}{\tau_B} V_{B_i} + \sum_{j=1}^{N_A} W_{B_i}^{A_j} V_{A_j} + F_{B_i}(t), \\ \frac{dV_{A_j}}{dt} = -\frac{1}{\tau_A} V_{A_j} + \sum_{i=1}^{N_B} W_{A_j}^{B_i} R_{B_i}, \\ \frac{dA_{B_i}}{dt} = -\frac{A_{B_i}}{\tau_a} + h_B \mathcal{N}(V_{B_i}). \end{cases}$$

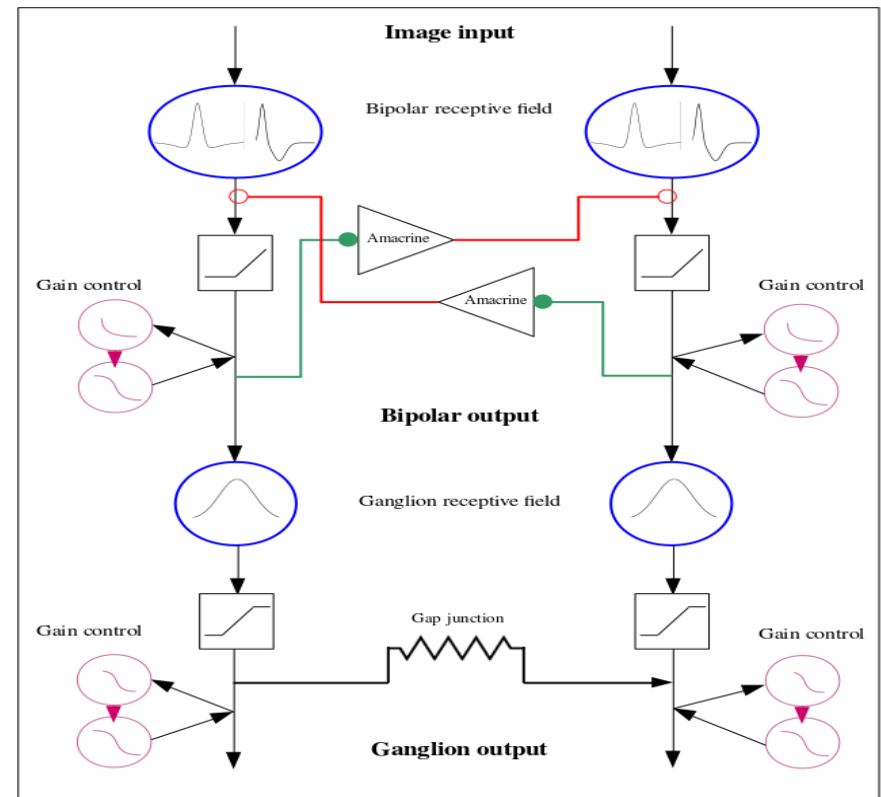

Building a 2D retina model for motion anticipation

Souihel S., Cessac B., "On the potential role of lateral connectivity in retinal anticipation", submitted to J. Math. Neuro.

Stimulus dependent drive

$$\left\{ \begin{aligned} \frac{dV_{B_i}}{dt} &= -\frac{1}{\tau_B} V_{B_i} + \sum_{j=1}^{N_A} W_{B_i}^{A_j} V_{A_j} + F_{B_i}(t), \\ \frac{dV_{A_j}}{dt} &= -\frac{1}{\tau_A} V_{A_j} + \sum_{i=1}^{N_B} W_{A_j}^{B_i} R_{B_i}, \\ \frac{dA_{B_i}}{dt} &= -\frac{A_{B_i}}{\tau_a} + h_B \mathcal{N}(V_{B_i}). \end{aligned} \right.$$

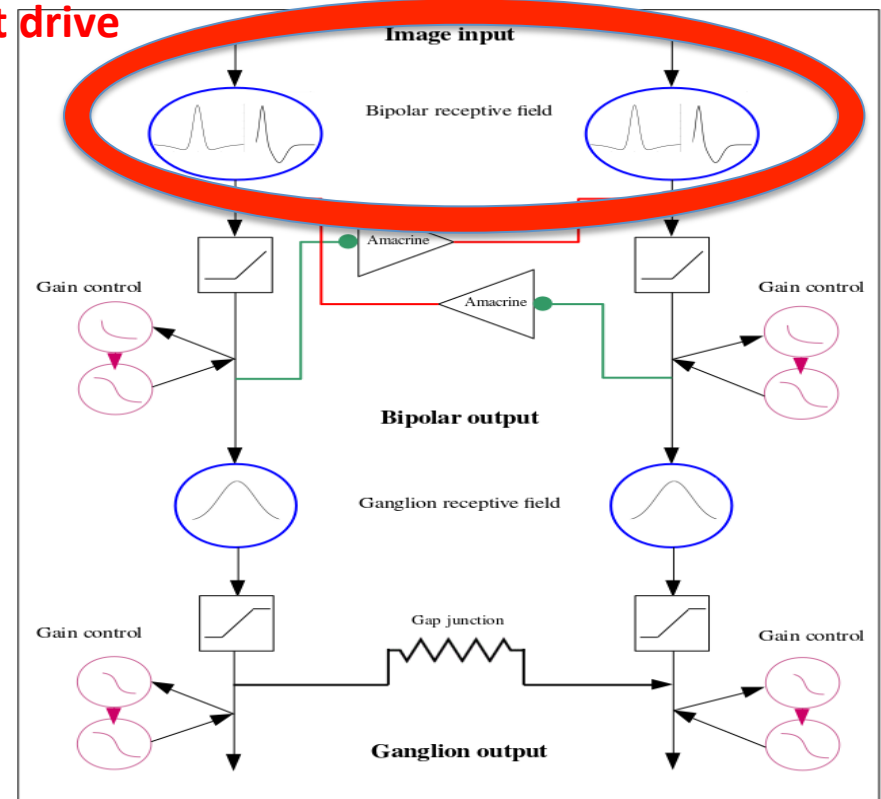

Building a 2D retina model for motion anticipation

Souihel S., Cessac B., “On the potential role of lateral connectivity in retinal anticipation”, submitted to J. Math. Neuro.

$$\left\{ \begin{aligned} \frac{dV_{B_i}}{dt} &= -\frac{1}{\tau_B} V_{B_i} + \sum_{j=1}^{N_A} W_{B_i}^{A_j} V_{A_j} + F_{B_i}(t), \\ \frac{dV_{A_j}}{dt} &= -\frac{1}{\tau_A} V_{A_j} + \sum_{i=1}^{N_B} W_{A_j}^{B_i} R_{B_i}, \\ \frac{dA_{B_i}}{dt} &= -\frac{A_{B_i}}{\tau_a} + h_B \mathcal{N}(V_{B_i}). \end{aligned} \right.$$

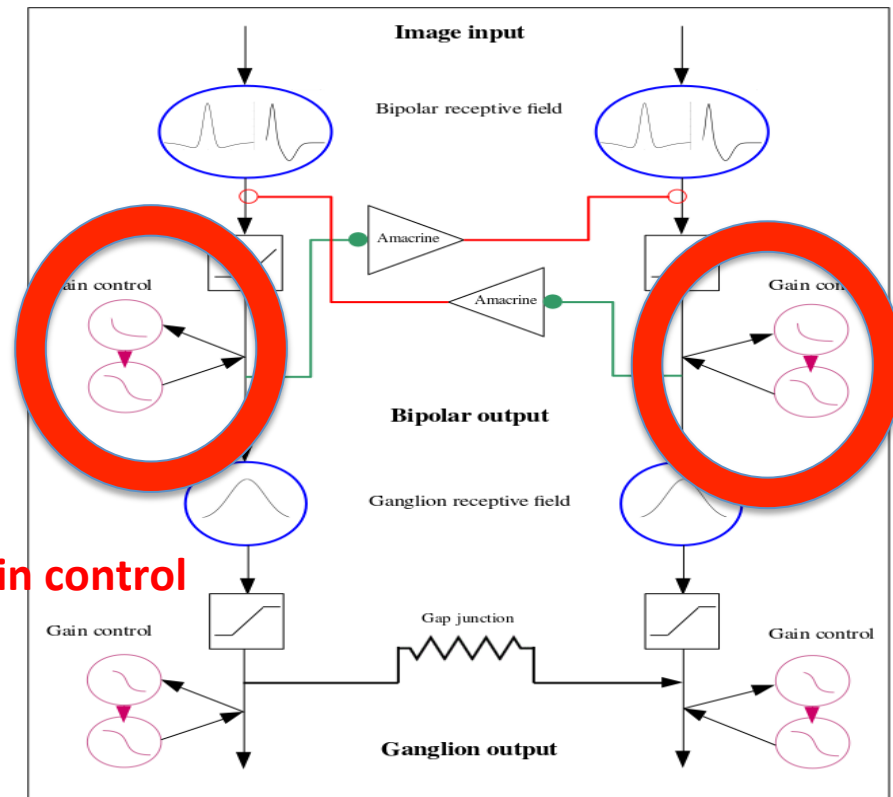

Non linear gain control

Building a 2D retina model for motion anticipation

Souihel S., Cessac B., "On the potential role of lateral connectivity in retinal anticipation", submitted to J. Math. Neuro.

$$\begin{cases} \frac{dV_{B_i}}{dt} = -\frac{1}{\tau_B} V_{B_i} + \sum_{j=1}^{N_A} W_{B_i}^{A_j} V_{A_j} + F_{B_i}(t), \\ \frac{dV_{A_j}}{dt} = -\frac{1}{\tau_A} V_{A_j} + \sum_{i=1}^{N_B} W_{A_j}^{B_i} R_{B_i}, \\ \frac{dA_{B_i}}{dt} = -\frac{A_{B_i}}{\tau_a} + h_B \mathcal{N}(V_{B_i}). \end{cases}$$



Non linear gain control

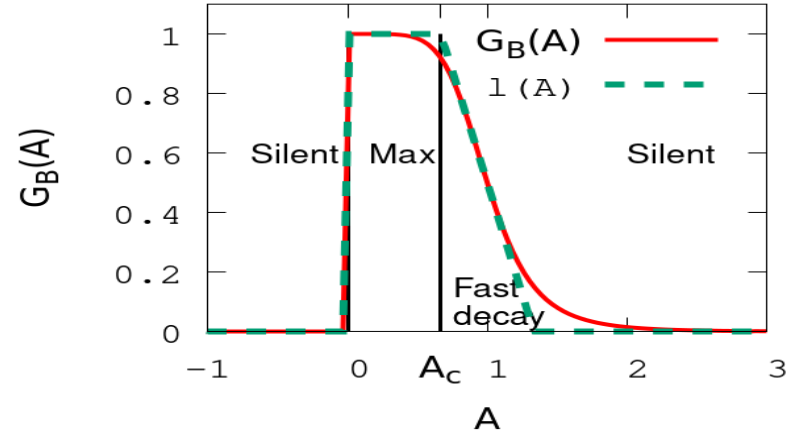

Building a 2D retina model for motion anticipation

Souihel S., Cessac B., "On the potential role of lateral connectivity in retinal anticipation", submitted to J. Math. Neuro.

$$\frac{dV_{B_i}}{dt} = -\frac{1}{\tau_B} V_{B_i} + \sum_{j=1}^{N_A} W_{B_i}^{A_j} V_{A_j} + F_{B_i}(t),$$

$$\frac{dV_{A_j}}{dt} = -\frac{1}{\tau_A} V_{A_j} + \sum_{i=1}^{N_B} W_{A_j}^{B_i} R_{B_i},$$

$$\frac{dA_{B_i}}{dt} = -\frac{A_{B_i}}{\tau_a} + h_B \mathcal{N}(V_{B_i}).$$

Non linear gain control

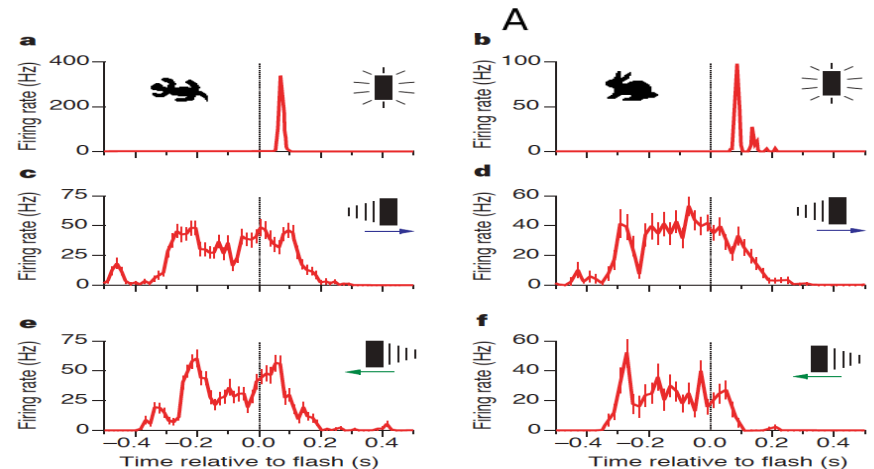
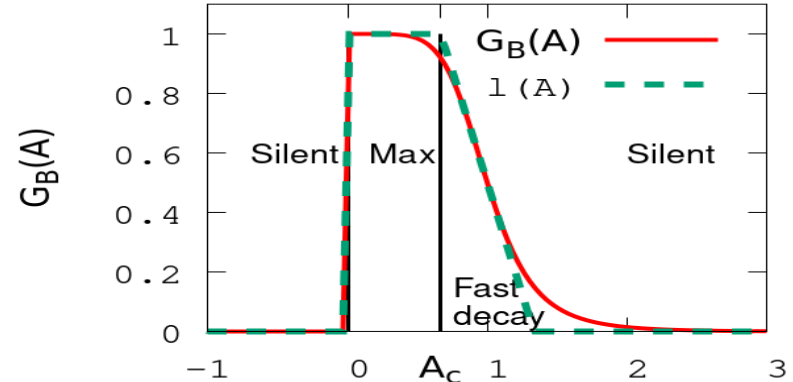

Building a 2D retina model for motion anticipation

Souihel S., Cessac B., "On the potential role of lateral connectivity in retinal anticipation", submitted to J. Math. Neuro.

Inhibition

$$\left\{ \begin{aligned} \frac{dV_{B_i}}{dt} &= -\frac{1}{\tau_B} V_{B_i} + \sum_{j=1}^N W_{B_i}^{A_j} V_{A_j} + F_{B_i}(t), \\ \frac{dV_{A_j}}{dt} &= -\frac{1}{\tau_A} V_{A_j} + \sum_{i=1}^{N_B} W_{A_j}^{B_i} R_{B_i}, \\ \frac{dA_{B_i}}{dt} &= -\frac{A_{B_i}}{\tau_a} + h_B \mathcal{N}(V_{B_i}). \end{aligned} \right.$$

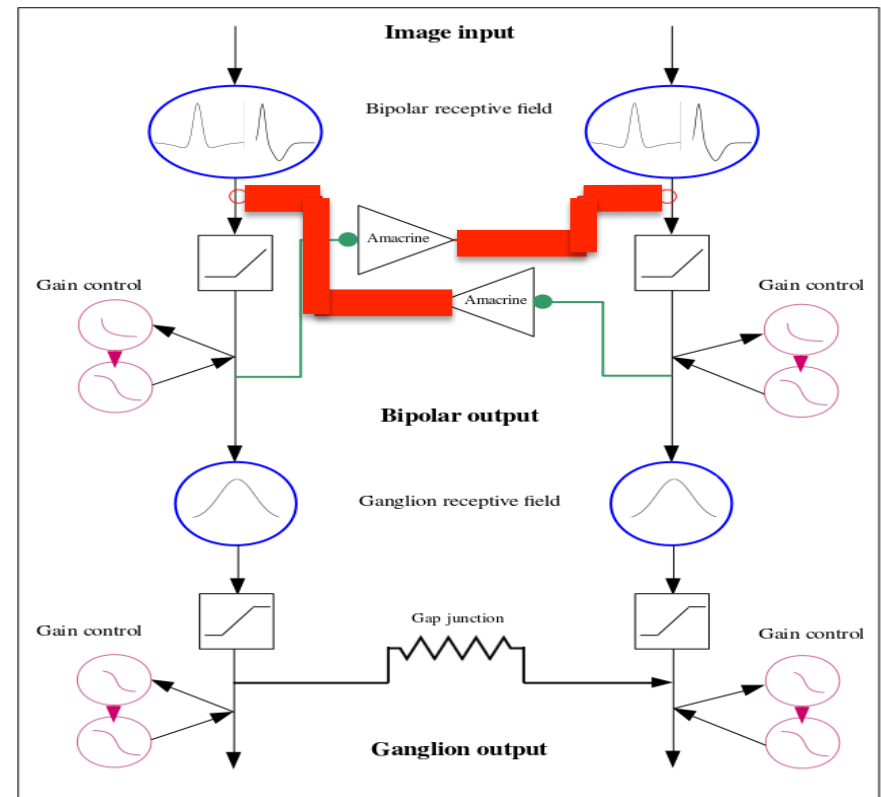

Building a 2D retina model for motion anticipation

Souihel S., Cessac B., “On the potential role of lateral connectivity in retinal anticipation”, submitted to J. Math. Neuro.

$$\left\{ \begin{aligned} \frac{dV_{B_i}}{dt} &= -\frac{1}{\tau_B} V_{B_i} + \sum_{j=1}^{N_A} W_{B_i}^{A_j} V_{A_j} + F_{B_i}(t), \\ \frac{dV_{A_j}}{dt} &= -\frac{1}{\tau_A} V_{A_j} + \sum_{i=1}^B W_{A_j}^{B_i} R_{B_i}, \\ \frac{dA_{B_i}}{dt} &= -\frac{A_{B_i}}{\tau_a} + h_B \mathcal{N}(V_{B_i}). \end{aligned} \right.$$

Excitation

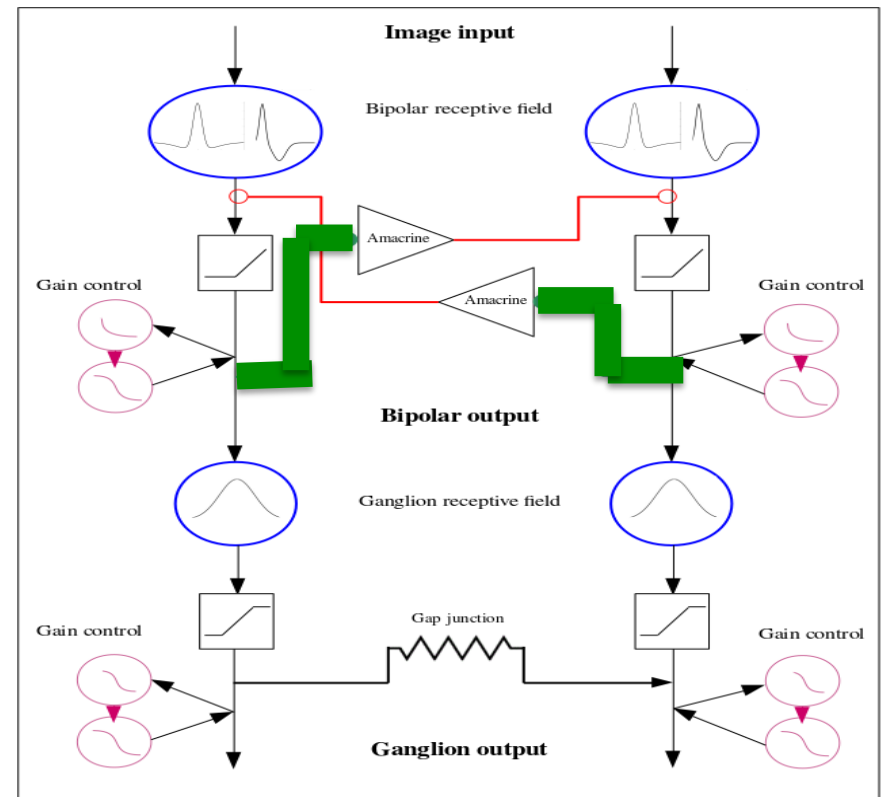

Building a 2D retina model for motion anticipation

Souihel S., Cessac B., “On the potential role of lateral connectivity in retinal anticipation”, submitted to J. Math. Neuro.

Linear regime

$$\frac{d\vec{\chi}}{dt} = \mathcal{L} \cdot \vec{\chi} + \vec{F}(t).$$

$$\mathcal{L} = \begin{pmatrix} -\frac{I_{N,N}}{\tau_B} & W_B^A & 0_{N,N} \\ W_A^B & -\frac{I_{N,N}}{\tau_A} & 0_{N,N} \\ h_B I_{N,N} & 0_{N,N} & -\frac{I_{N,N}}{\tau_a} \end{pmatrix}$$

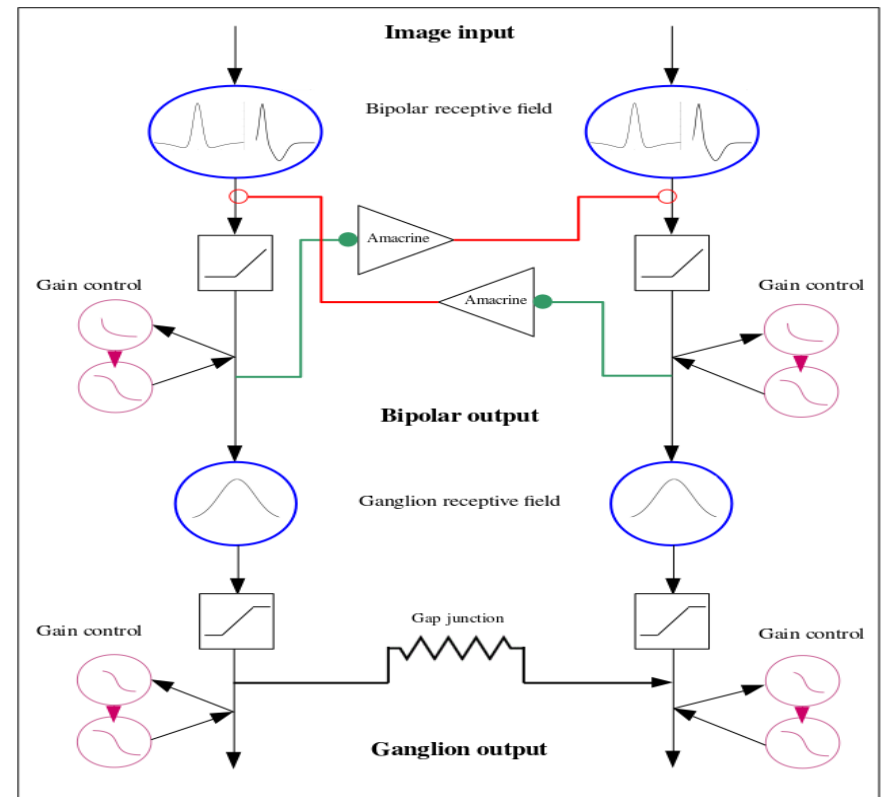

Building a 2D retina model for motion anticipation

Souihel S., Cessac B., “On the potential role of lateral connectivity in retinal anticipation”, submitted to J. Math. Neuro.

Linear regime

$$\frac{d\vec{\chi}}{dt} = \mathcal{L} \cdot \vec{\chi} + \vec{F}(t).$$

$$\mathcal{L} = \begin{pmatrix} -\frac{I_{N,N}}{\tau_B} & W_B^A & 0_{N,N} \\ W_A^B & -\frac{I_{N,N}}{\tau_A} & 0_{N,N} \\ h_B I_{N,N} & 0_{N,N} & -\frac{I_{N,N}}{\tau_a} \end{pmatrix}$$

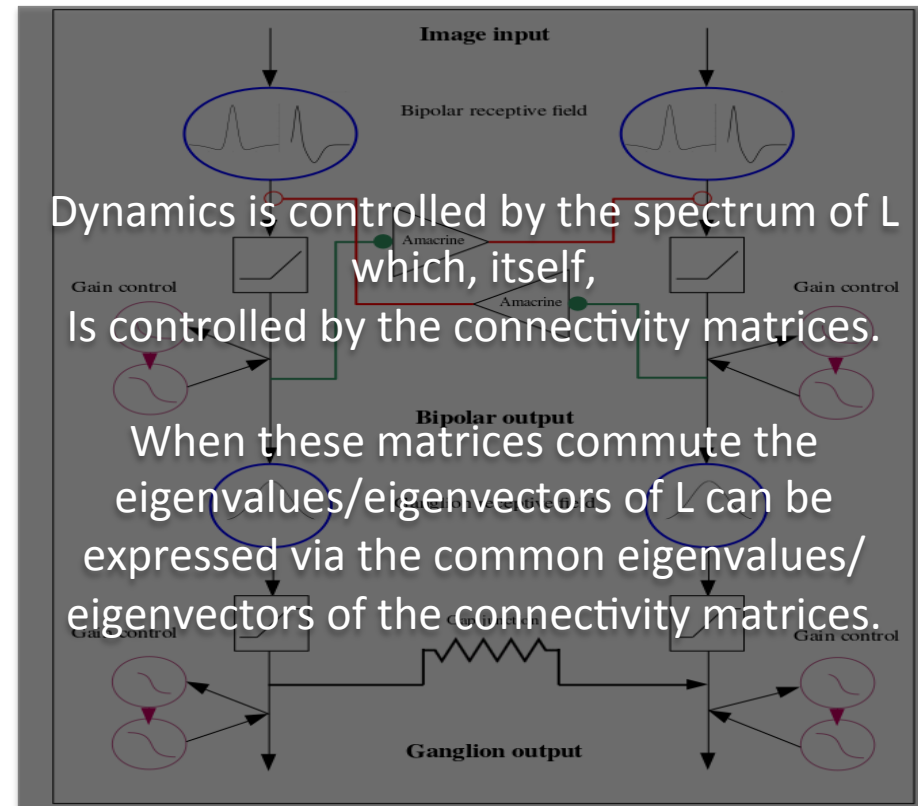

Building a 2D retina model for motion anticipation

Souihel S., Cessac B., “On the potential role of lateral connectivity in retinal anticipation”, submitted to J. Math. Neuro.

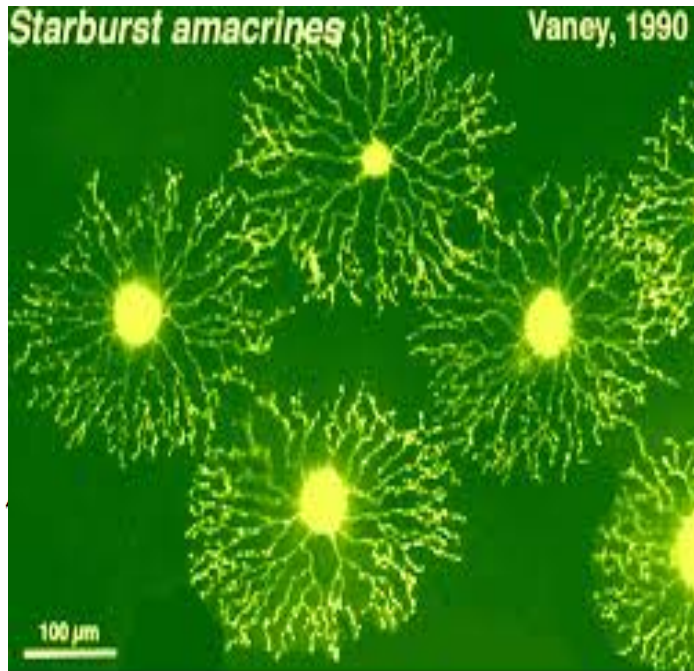
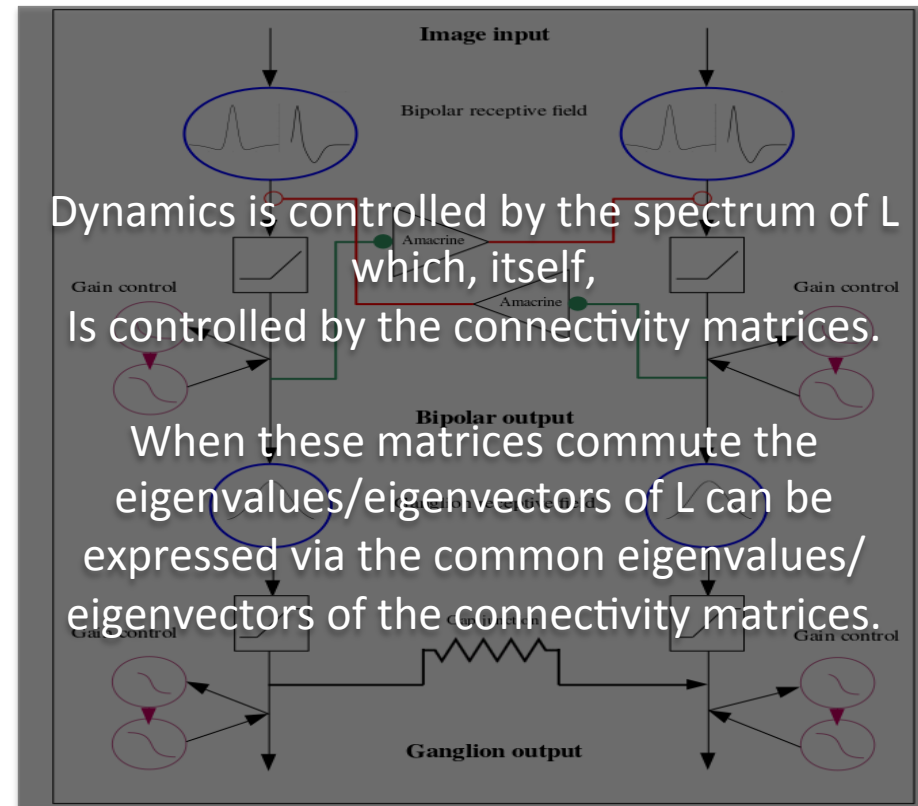
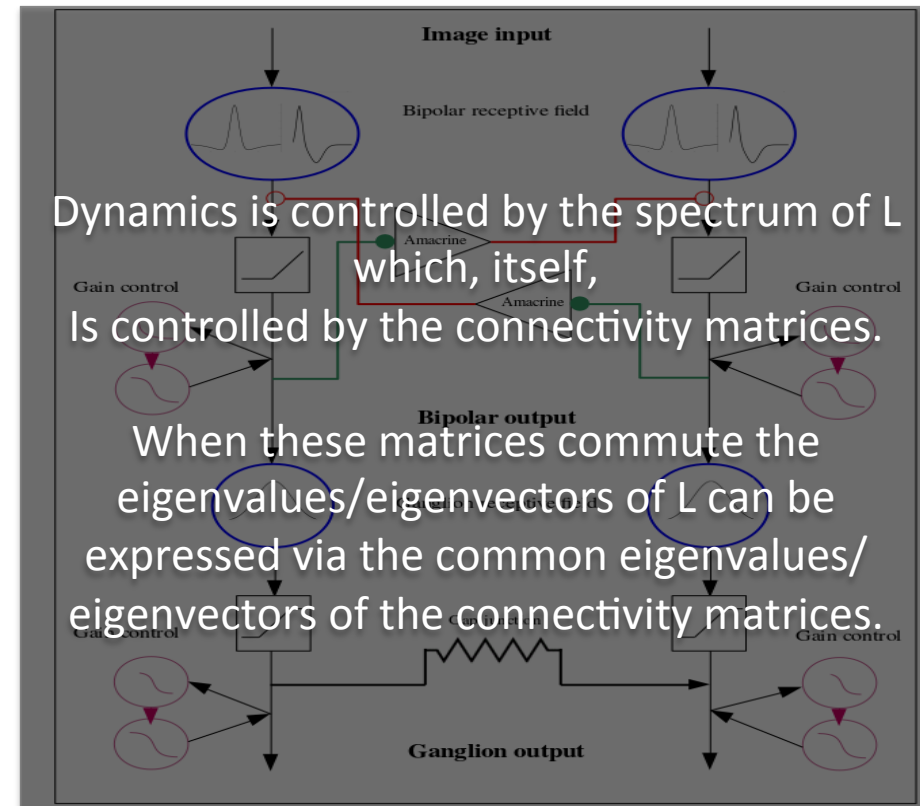
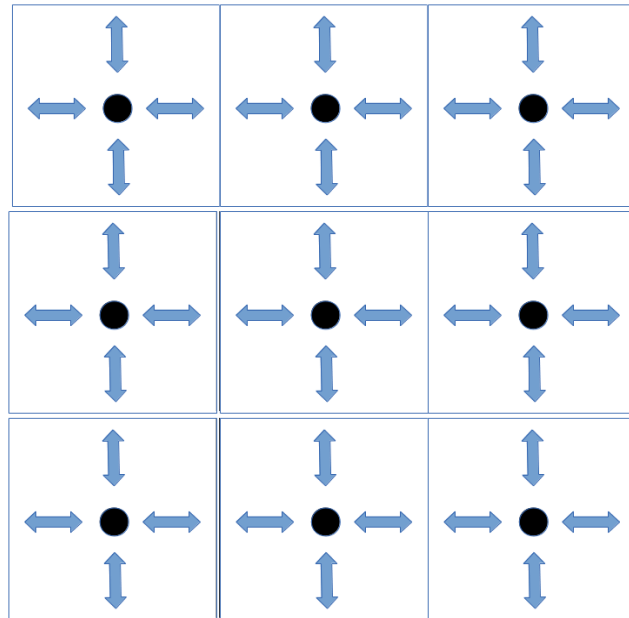

Fig. 7. Starburst amacrine cells as stained with lucifer yellow in wholemount rabbit retina.



Building a 2D retina model for motion anticipation

Souihel S., Cessac B., “On the potential role of lateral connectivity in retinal anticipation”, submitted to J. Math. Neuro.



Building a 2D retina model for motion anticipation

Souihel S., Cessac B., “On the potential role of lateral connectivity in retinal anticipation”, submitted to J. Math. Neuro.

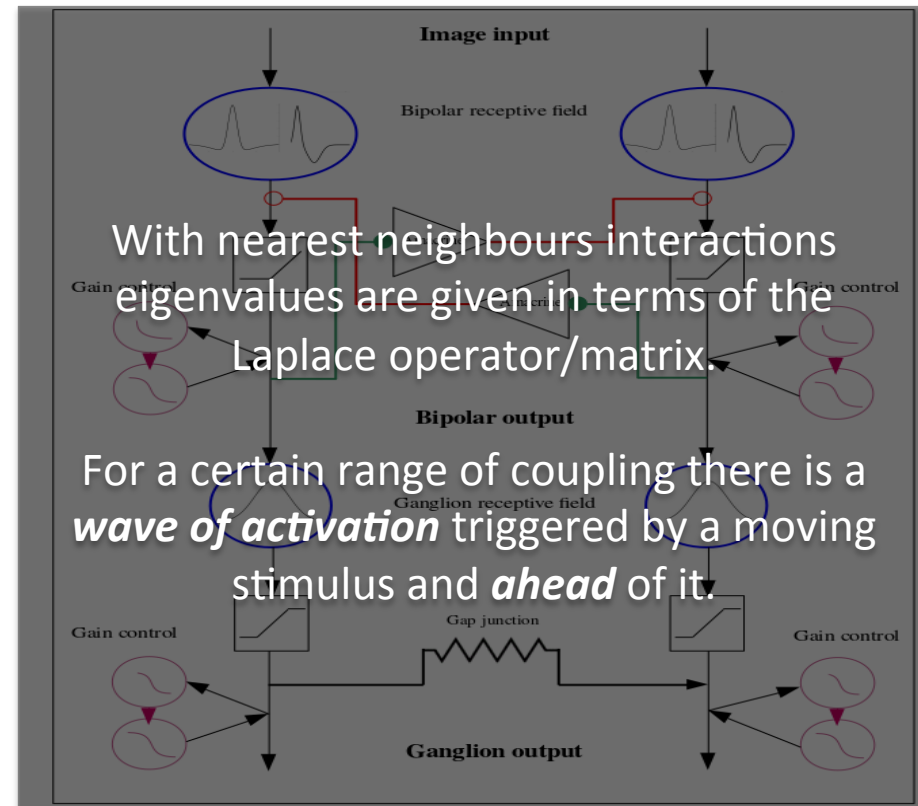
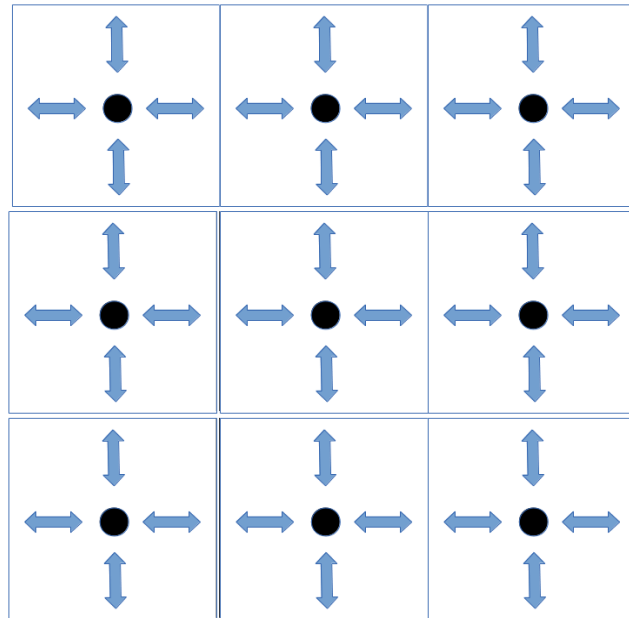

Building a 2D retina model for motion anticipation

Souihel S., Cessac B., "On the potential role of lateral connectivity in retinal anticipation", submitted to J. Math. Neuro.

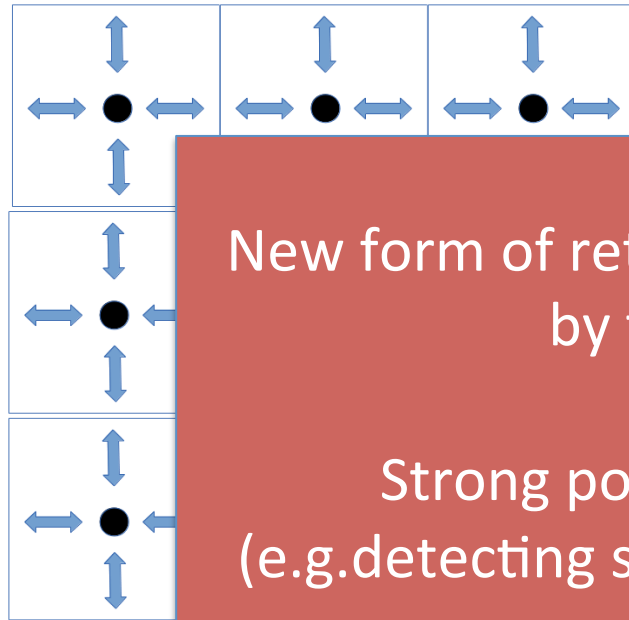

New form of retinal anticipation induced by the network.

Strong potential implications (e.g. detecting surprise in a visual scene)

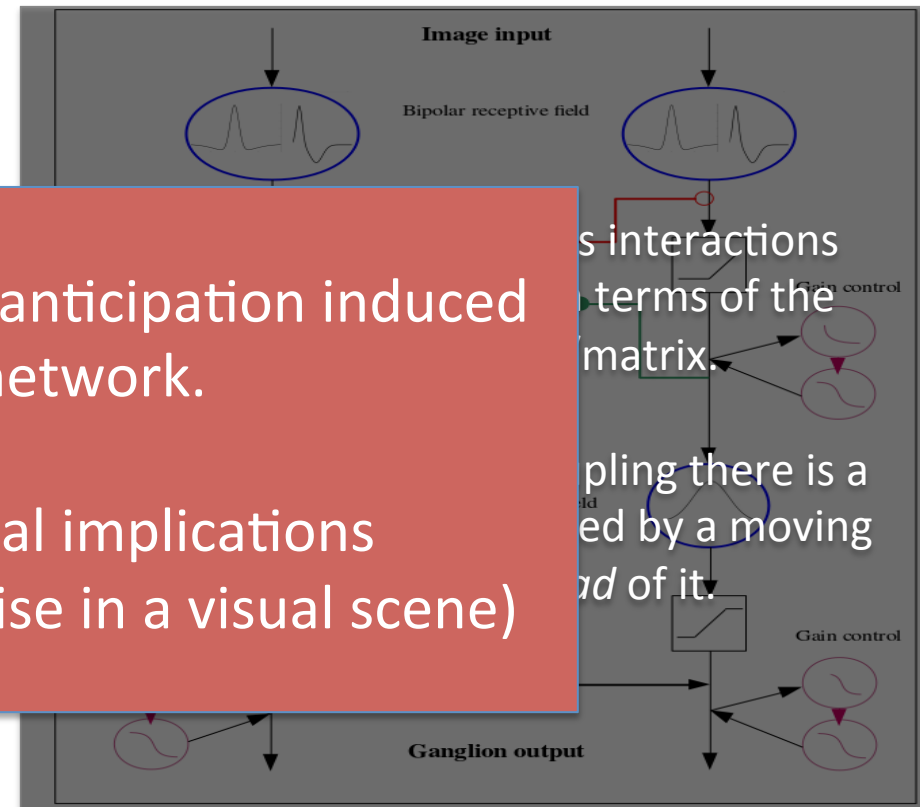

Building a 2D retina model for motion anticipation

Souihel S., Cessac B., “On the potential role of lateral connectivity in retinal anticipation”, submitted to J. Math. Neuro.

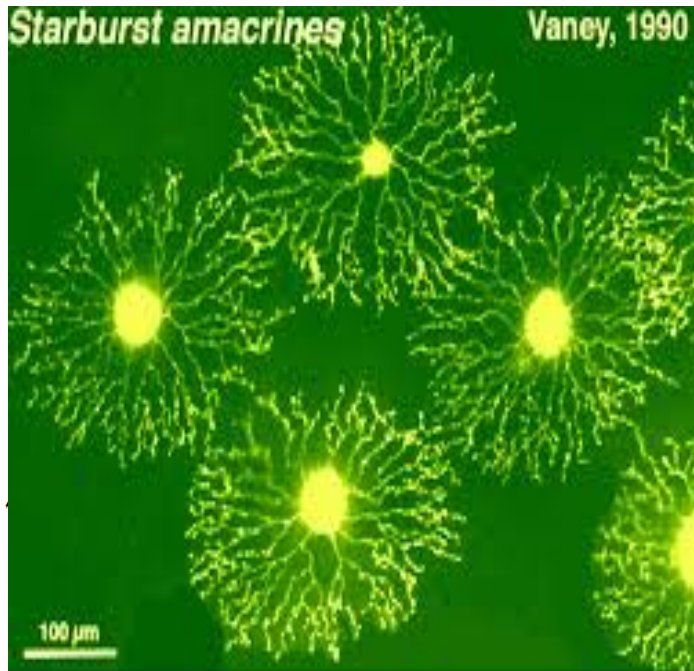
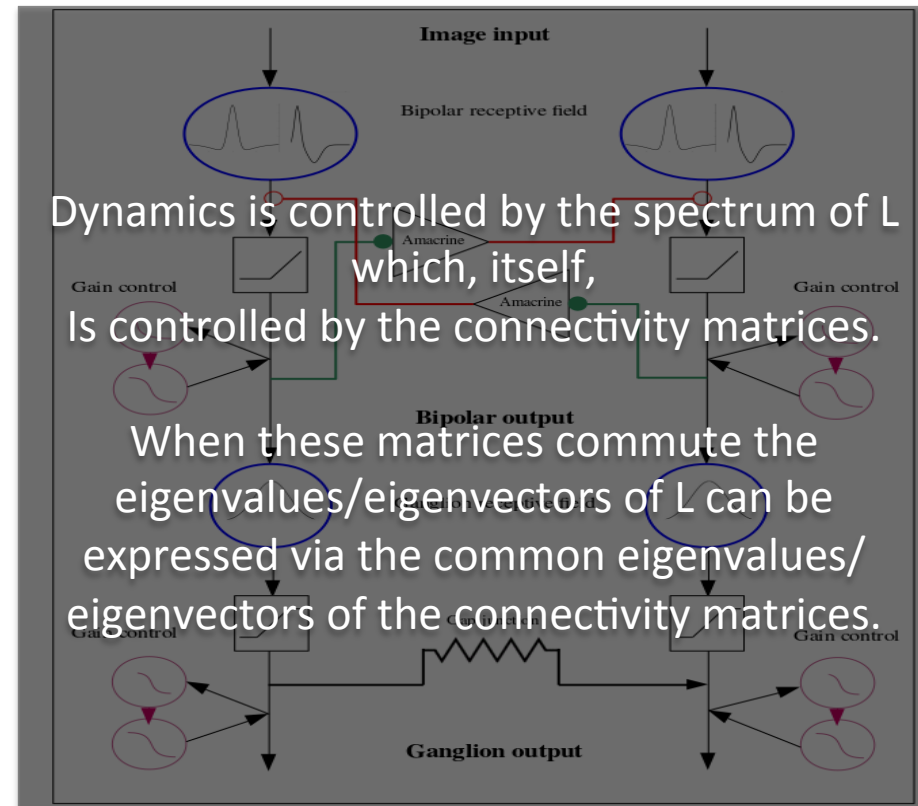

Fig. 7. Starburst amacrine cells as stained with lucifer yellow in whole-mount rabbit retina.



Building a 2D retina model for motion anticipation

Souihel S., Cessac B., "On the potential role of lateral connectivity in retinal anticipation", submitted to J. Math. Neuro.

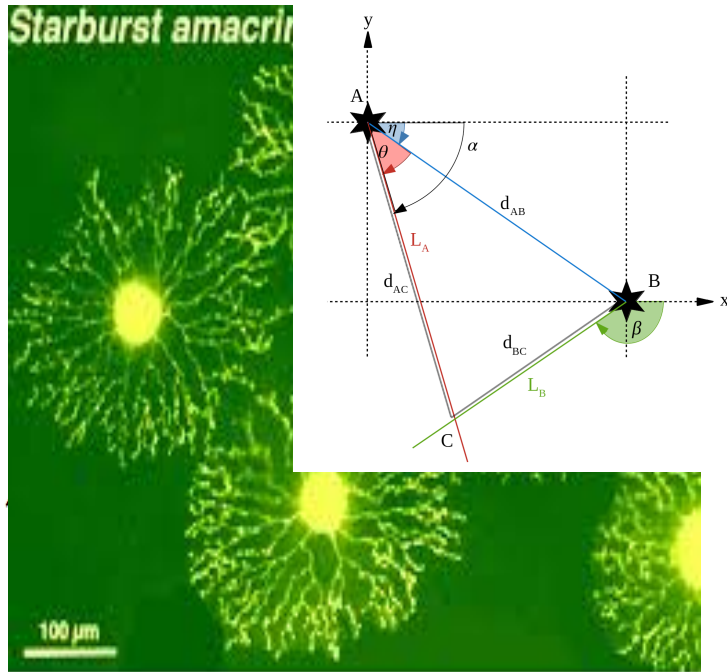
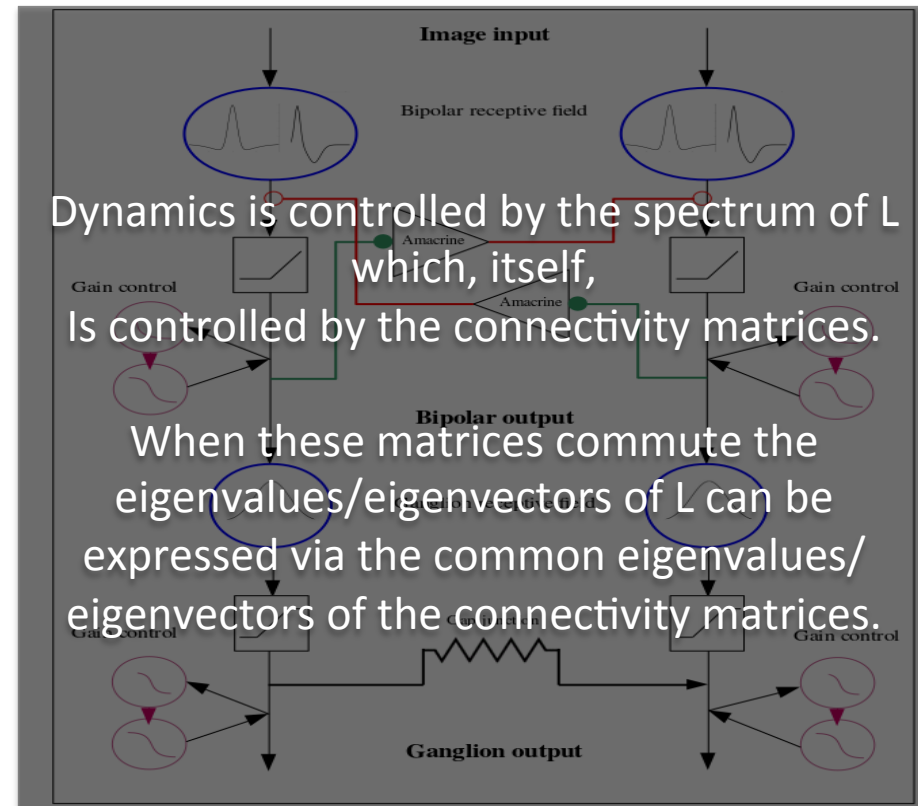

Fig. 7. Starburst amacrine cells as stained with Lucifer yellow in whole-mount rabbit retina.



Building a 2D retina model for motion anticipation

Souihel S., Cessac B., “On the potential role of lateral connectivity in retinal anticipation”, submitted to J. Math. Neuro.

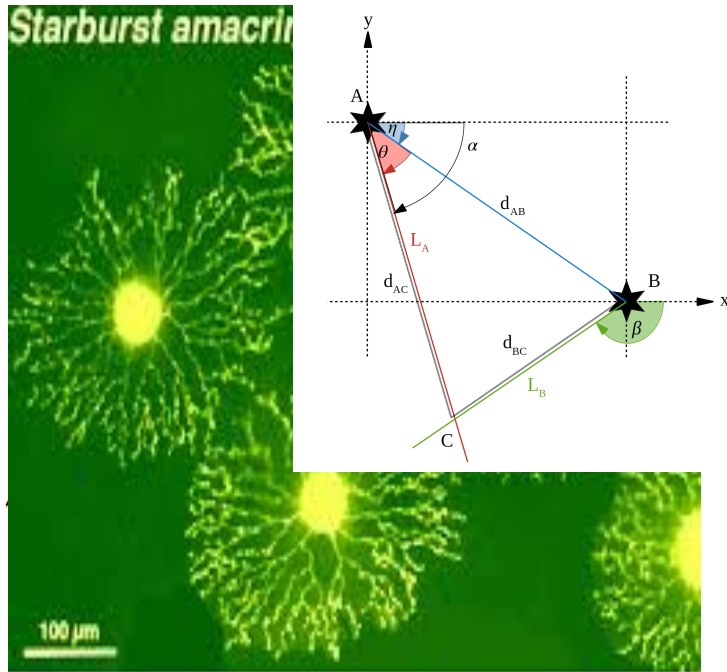
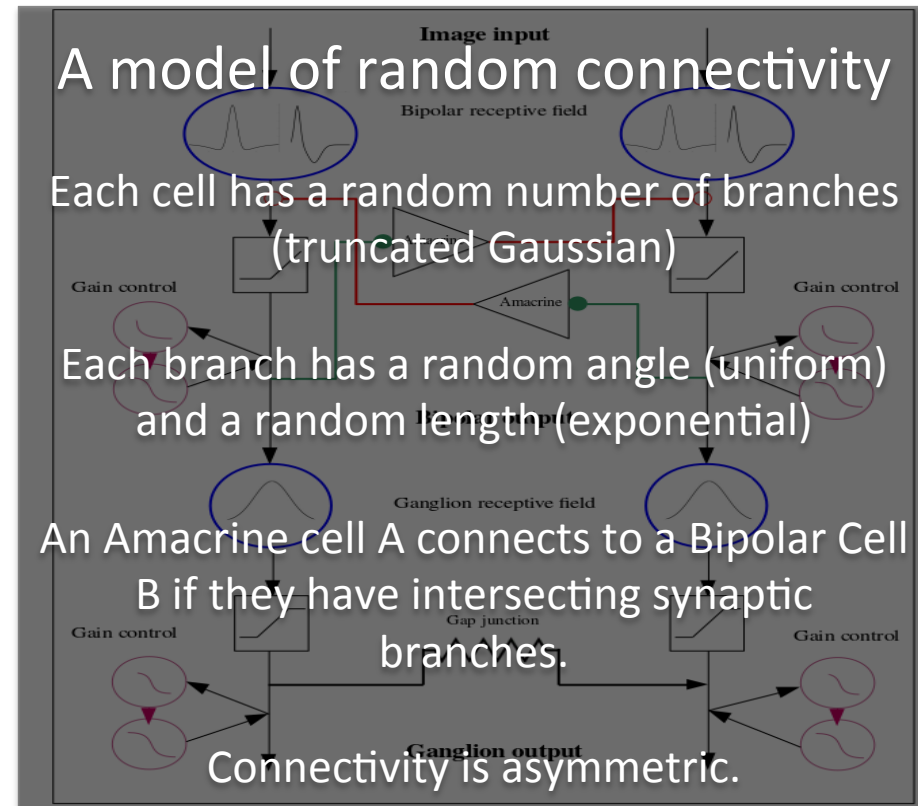

Fig. 7. Starburst amacrine cells as stained with Lucifer yellow in whole-mount rabbit retina.



Building a 2D retina model for motion anticipation

Souihel S., Cessac B., "On the potential role of lateral connectivity in retinal anticipation", submitted to J. Math. Neuro.

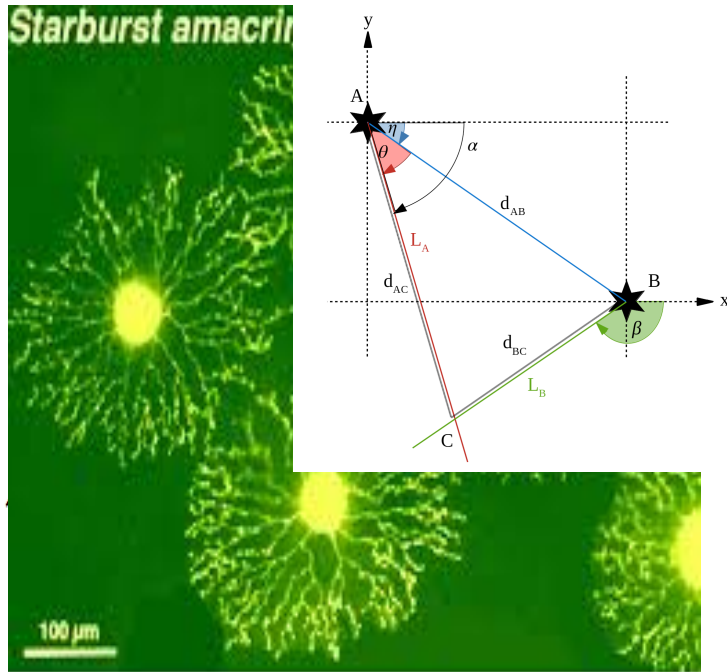
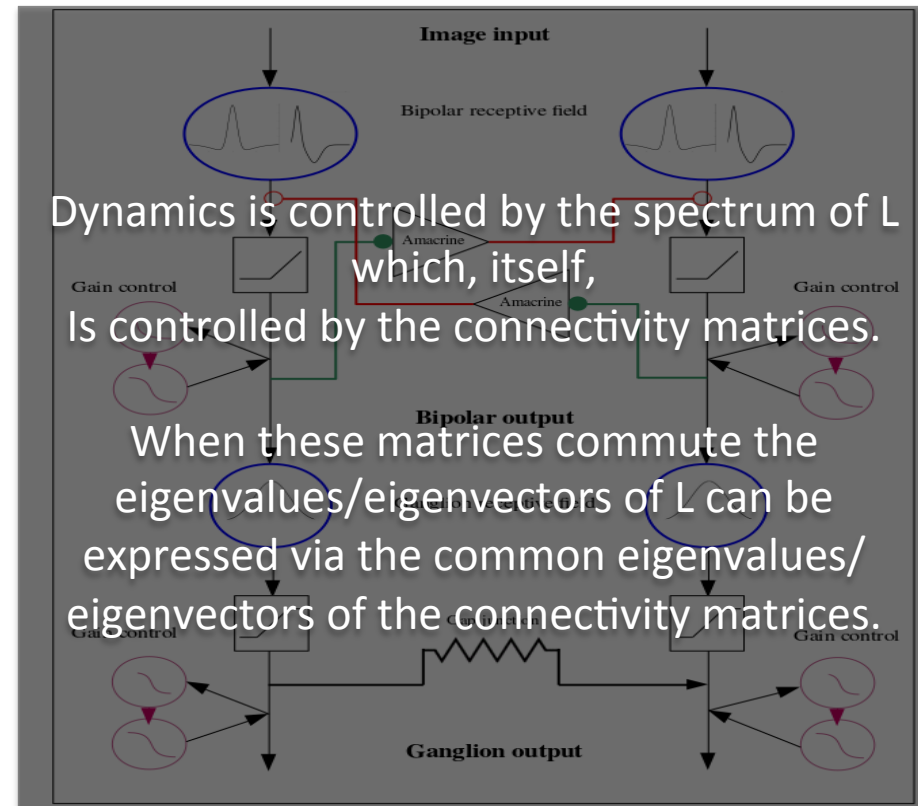
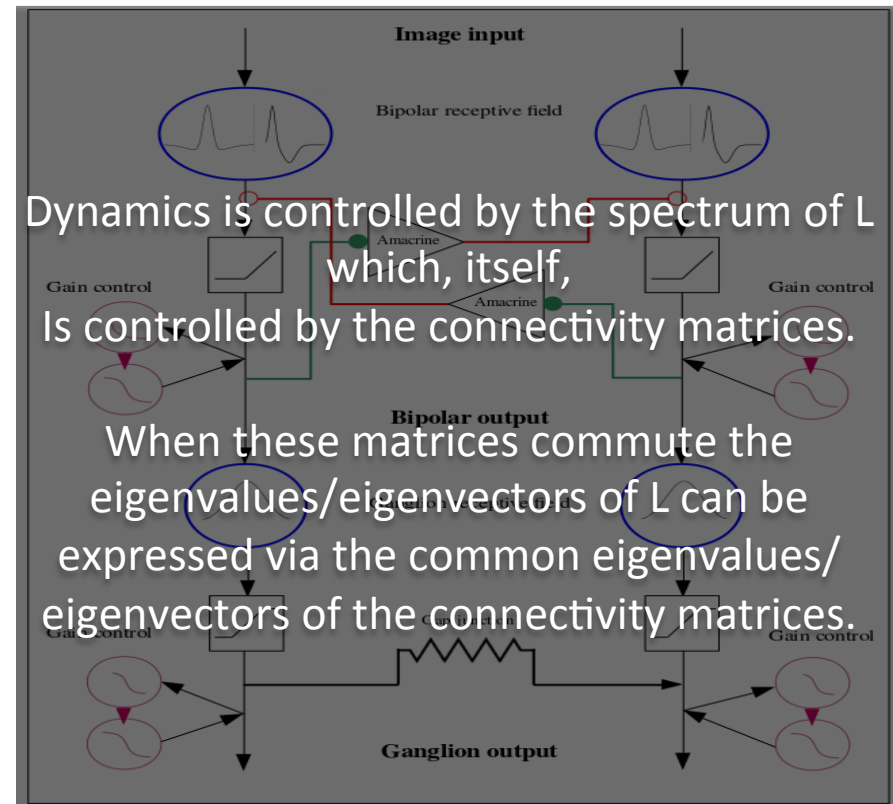
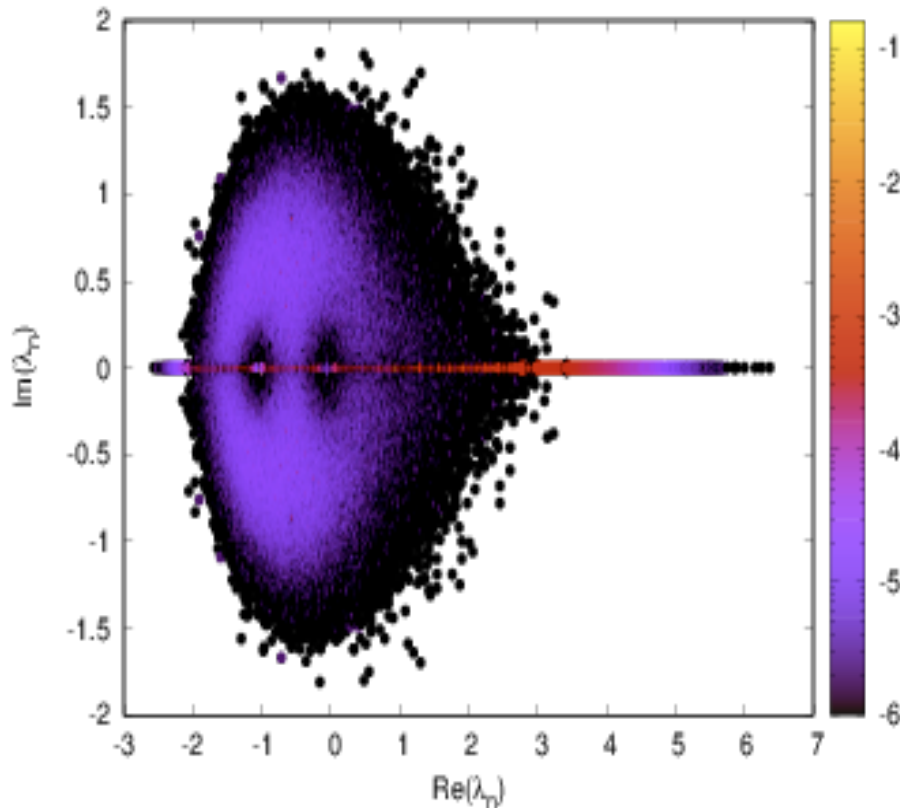

Fig. 7. Starburst amacrine cells as stained with Lucifer yellow in whole-mount rabbit retina.



Building a 2D retina model for motion anticipation

Souihel S., Cessac B., "On the potential role of lateral connectivity in retinal anticipation", submitted to J. Math. Neuro.



Building a 2D retina model for motion anticipation

Souihel S., Cessac B., “On the potential role of lateral connectivity in retinal anticipation”, submitted to J. Math. Neuro.

$$\frac{d\vec{\chi}}{dt} = \mathcal{L} \cdot \vec{\chi} + \vec{F}(t).$$

$$\mathcal{L} = \begin{pmatrix} -\frac{I_{N,N}}{\tau_B} & W_B^A & 0_{N,N} \\ W_A^B & -\frac{I_{N,N}}{\tau_A} & 0_{N,N} \\ h_B I_{N,N} & 0_{N,N} & -\frac{I_{N,N}}{\tau_a} \end{pmatrix}$$

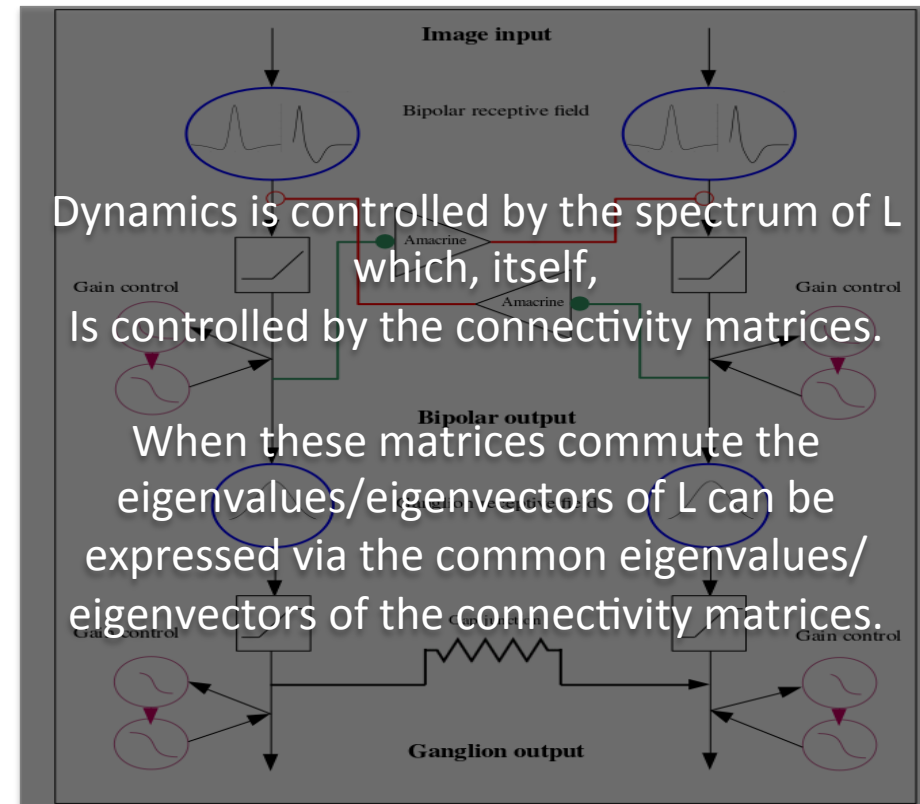

Building a 2D retina model for motion anticipation

Souihel S., Cessac B., “On the potential role of lateral connectivity in retinal anticipation”, submitted to J. Math. Neuro.

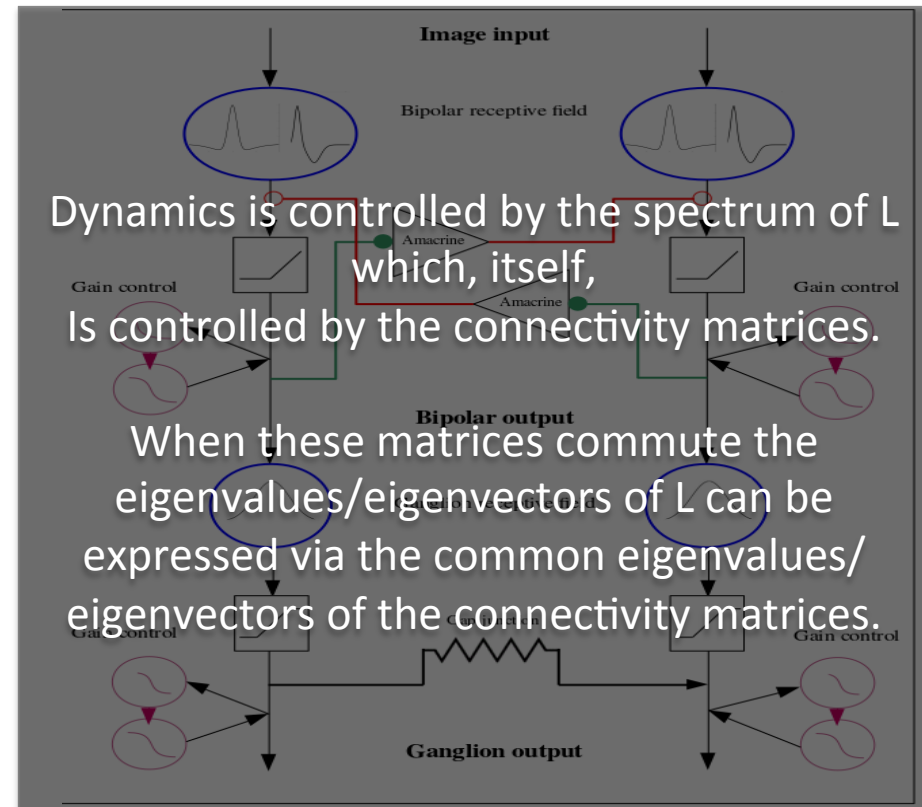
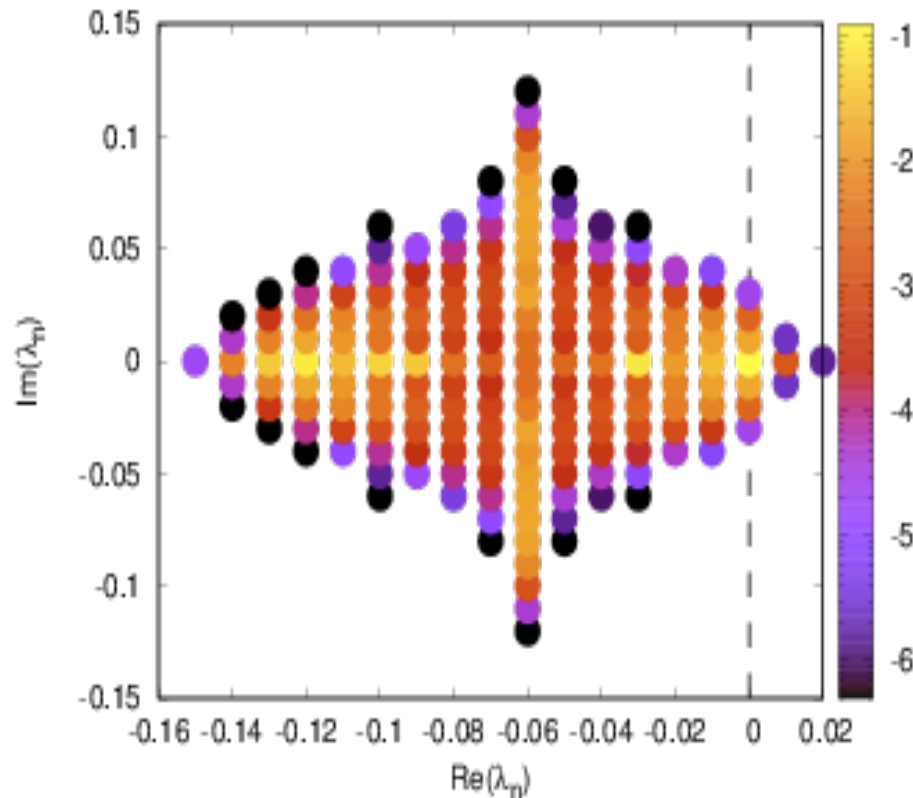

Building a 2D retina model for motion anticipation

Souihel S., Cessac B., "On the potential role of lateral connectivity in retinal anticipation", submitted to J. Math. Neuro.

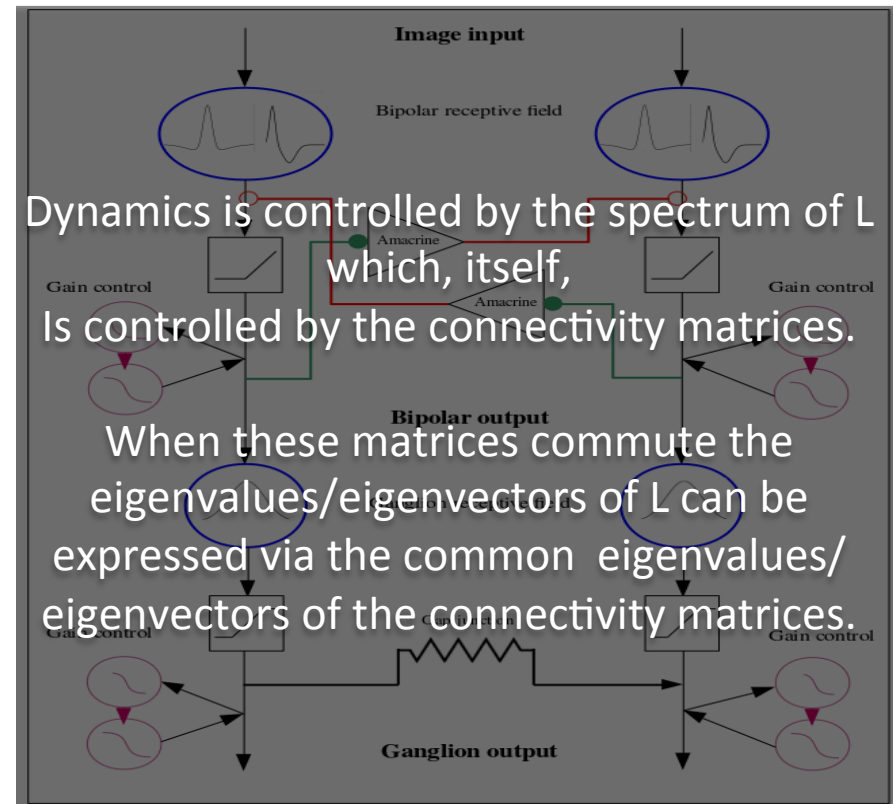
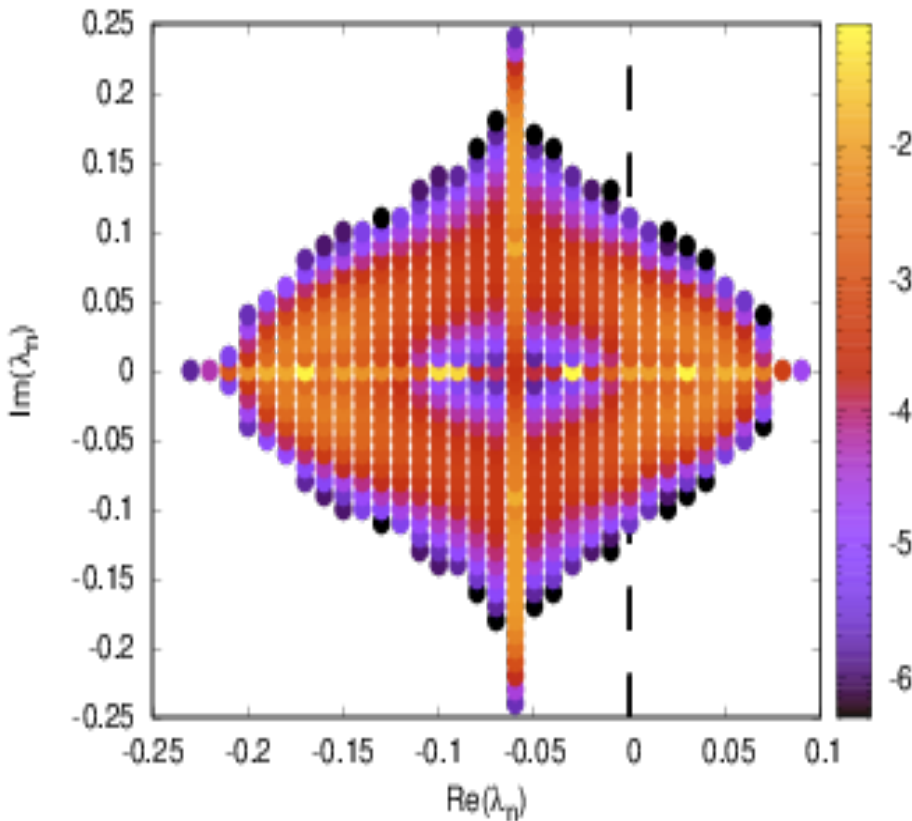

Building a 2D retina model for motion anticipation

Souihel S., Cessac B., "On the potential role of lateral connectivity in retinal anticipation", submitted to J. Math. Neuro.

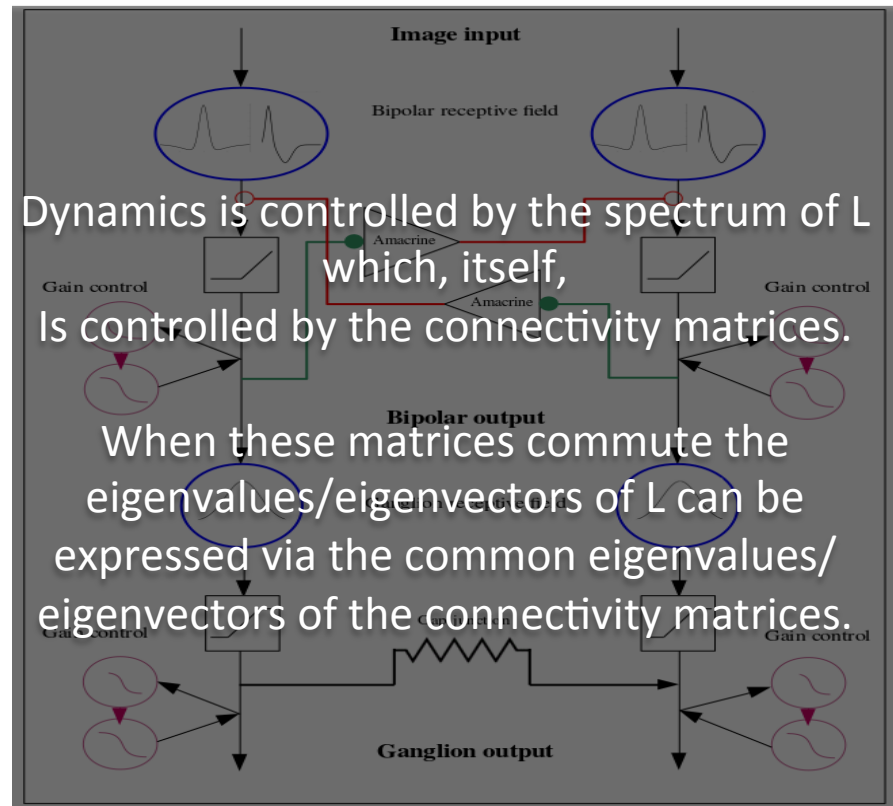
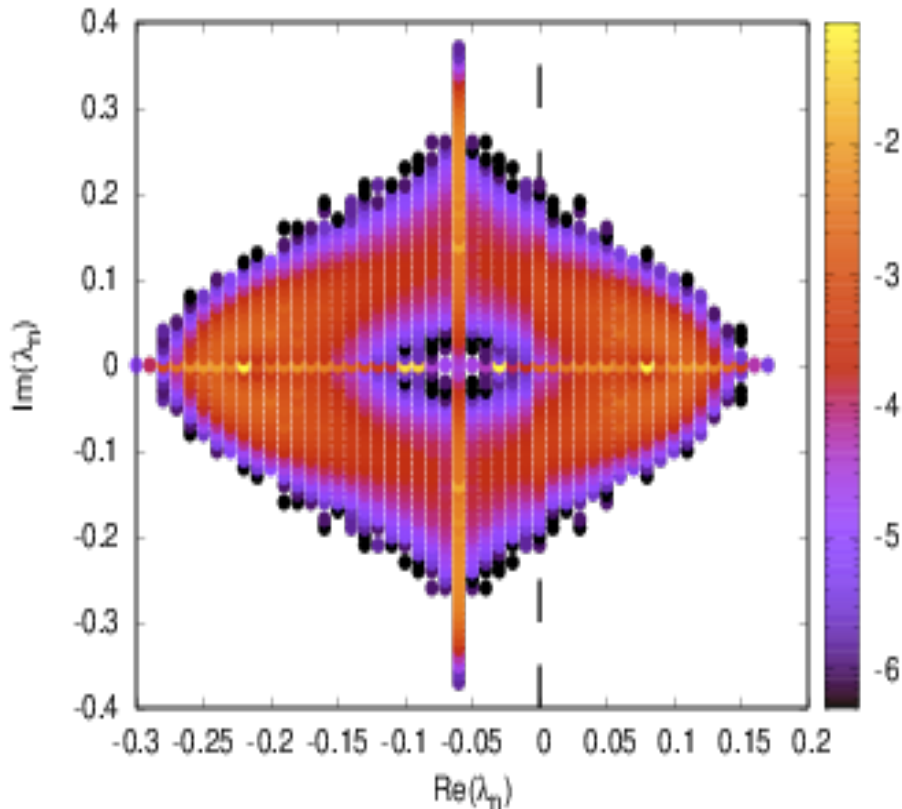

Building a 2D retina model for motion anticipation

Southern
retina

Any known mathematical results about the spectrum (complex eigenvalues/eigenvectors) of this type of random matrices ?

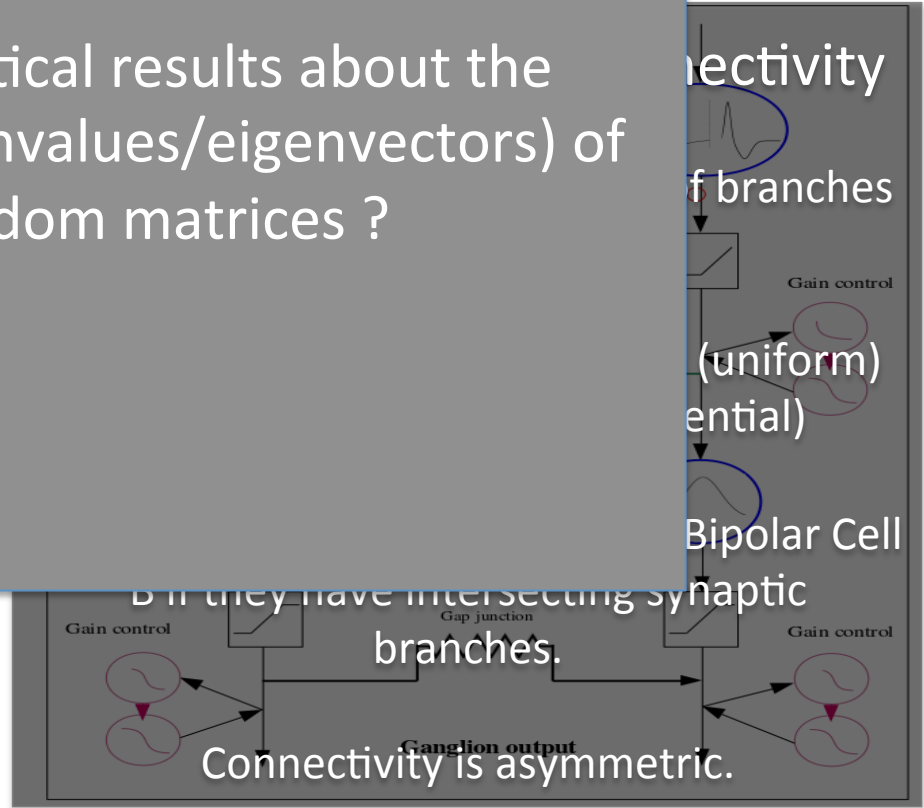
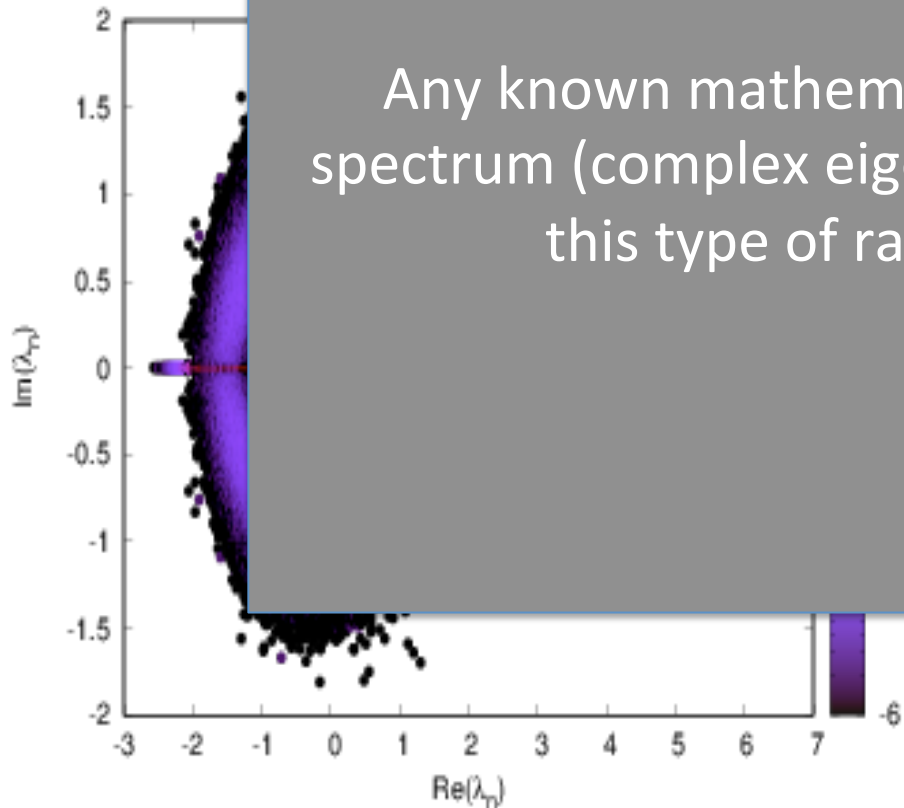

Conclusions

- How to improve object identification
 - 1) exploring the model's parameters and
 - 2) using connectivity ?
- Is our model able to anticipate more complex trajectories, with accelerations for instance ?
- How to calibrate connectivity using biology ?
- How does anticipation affect higher order correlations ?
- Would it be possible to design psycho-physical tests clearly showing the role of the retina in visual anticipation ?

Thanks 😊