



HAL
open science

Optimization of deep neural networks: a survey and unified taxonomy

El-Ghazali Talbi

► **To cite this version:**

El-Ghazali Talbi. Optimization of deep neural networks: a survey and unified taxonomy. 2020.
hal-02570804v1

HAL Id: hal-02570804

<https://inria.hal.science/hal-02570804v1>

Preprint submitted on 12 May 2020 (v1), last revised 3 Jun 2020 (v2)

HAL is a multi-disciplinary open access archive for the deposit and dissemination of scientific research documents, whether they are published or not. The documents may come from teaching and research institutions in France or abroad, or from public or private research centers.

L'archive ouverte pluridisciplinaire **HAL**, est destinée au dépôt et à la diffusion de documents scientifiques de niveau recherche, publiés ou non, émanant des établissements d'enseignement et de recherche français ou étrangers, des laboratoires publics ou privés.

Optimization of deep neural networks: a survey and unified taxonomy

EL-GHAZALI TALBI, University of Lille and INRIA

During the last years, research in applying optimization approaches in the automatic design of deep neural networks (DNNs) becomes increasingly popular. Although various approaches have been proposed, there is a lack of a comprehensive survey and taxonomy on this hot research topic. In this paper, we propose a unified way to describe the various optimization algorithms which focus on common and important search components of optimization algorithms: representation, objective function, constraints, initial solution(s) and variation operators. In addition to large scale search space, the problem is characterized by its variable mixed design space, very expensive and multiple blackbox objective functions. Hence, this unified methodology has been extended to advanced optimization approaches such as surrogate-based, multi-objective and parallel optimization.

CCS Concepts: • **Computing methodologies** → **Search methodologies**.

Additional Key Words and Phrases: Metaheuristics, Machine learning, Optimization, Deep neural networks, Hyperparameter optimization, Network architecture search

ACM Reference Format:

El-Ghazali TALBI. 2020. Optimization of deep neural networks: a survey and unified taxonomy. *ACM Comput. Surv.* 00, 00, Article 00 (2020), 36 pages. <https://doi.org/00>

1 INTRODUCTION

Over the last years, deep neural networks (DNNs) have enabled significant progress in many application domains including computer vision and natural language processing (NLP) [63]. The design of DNNs has proven to be critical. Currently employed DNN architectures have mostly been developed manually by human experts, which is a time-consuming, error-prone process, and prevent finding new architectures that go beyond the human domain knowledge. Consequently, there is a growing interest in automated neural architecture search and hyperparameters optimization (AutoDNN) [81]. It allows the design of more efficient and effective DNNs and more accessibility to non expert for solving diverse learning tasks. AutoDNN approaches outperformed handcrafted architectures for some learning tasks, such as image classification [141], object detection [203] and semantic segmentation [31].

In the last five years, a lot of effort has been dedicated to automate the design of DNNs. Among the crucial contributing aspects for this progress are the design of new deep neural architectures and tuning of their associated hyperparameters. Scaling up DNNs capacity has been known as an effective approach to improve model quality for several learning tasks. Exact optimization approaches cannot be applied to such NP-complete optimization problems. A wide variety of specific heuristics

Author's address: El-Ghazali TALBI, el-ghazali.talbi@univ-lille.fr, University of Lille and INRIA, Polytech'Lille, Cité scientifique, Villeneuve d'Ascq, France, 59655.

Permission to make digital or hard copies of all or part of this work for personal or classroom use is granted without fee provided that copies are not made or distributed for profit or commercial advantage and that copies bear this notice and the full citation on the first page. Copyrights for components of this work owned by others than ACM must be honored. Abstracting with credit is permitted. To copy otherwise, or republish, to post on servers or to redistribute to lists, requires prior specific permission and/or a fee. Request permissions from permissions@acm.org.

© 2020 Association for Computing Machinery.

0360-0300/2020/00-ART00 \$15.00

<https://doi.org/00>

and metaheuristics have been used for architecture and hyperparameter optimization: random search [148][100][15][102], grid search [167], MCST (Monte Carlo Tree Search) [130][183], reinforcement learning (RL) [7], and many families of metaheuristics such as evolutionary algorithms (EAs) and particle swarm optimization (PSO).

Some survey papers related to AutoDNN exist in the literature. Some papers focus on specific optimization problems such as hyperparameter optimization [13][56][118] and neural network architecture (NAS) [51]. In [51], the paper is structured according to three high-level dimensions: search space, search strategy and performance estimation strategy. Other survey papers focus on some families of optimization algorithms. In [40], the authors provide a survey of swarm and evolutionary computing approaches for general deep learning problems. Other surveys deal with neuroevolution [162] and reinforcement learning [85]. In [58], the authors propose a survey of metaheuristics for the training problem.

In this paper, a survey of optimization algorithms for AutoDNN is presented. A unified way to describe the optimization algorithms allow to focus on common and important search components for all AutoDNN methodologies: representation of DNNs (i.e. search space), formulation of objective function(s), handling of constraints, initialization of solution(s), and the design of variation operators (i.e. greedy such as RL, unary operators such as neighborhoods, mutation in EAs and velocity update in PSO, binary operators such as crossover in EAs, and indirect search operators). We also extend this unifying view to important optimization methodologies for AutoDNN dealing with surrogate-based optimization (i.e. Bayesian optimization), multi-objective optimization and parallel optimization. A unified taxonomy is proposed in an attempt to provide a common terminology and classification mechanisms. The goal of the general taxonomy given here is to provide a mechanism to allow comparison between different optimization methodologies. In addition, it is hoped that the categories and their relationships to each other have been chosen carefully enough to indicate areas in need of future work as well as to help classify future work.

The paper is structured as follows. In section 2, the main concepts of DNN and metaheuristics are detailed in a general and unified way. Section 3 formulates the problem and describes its main characteristics. In section 4, we present in a unified way the design of the various search components of metaheuristics: DNN representation, objective function definition, constraint handling, solution(s) initialization and variation operators design (i.e. greedy, unary, N-ary and indirect operators). In section 5 (resp. section 6, section 7) we focus on important aspects in AutoDNN dealing with surrogate-based optimization (resp. multi-objective optimization, parallel optimization). Finally, the last section presents the main conclusions and identifies some research perspectives.

2 MAIN CONCEPTS

This section provides an overview of the basic components of popular DNNs. Then, it presents in a unified way the main common search concepts of metaheuristics.

2.1 Deep neural networks

DNNs are accurate and efficient learning approaches, which represent one of the hottest research area in machine learning. DNNs are widely applied in computer vision, NLP, and robotics [63]. They are based on neural network architectures, which interconnect multiple processing layers [73]. DNNs automatically extract features from big unstructured data such as image, text and audio. They learn the mapping between the features and predicted classes, layer by layer, through a transformation of the data, from low-level features to high-level features. This deep feature hierarchy enables DNNs to perform high-performance accuracy in many learning tasks.

99 DNNs come in two major families: *feed-forward* and *recurrent*. In feed-forward DNNs all the
100 operations are carried out as a sequence of operations on the outputs of previous layers. In such
101 DNNs, there is no memory. Feed-forward neural networks process information layer by layer, while
102 recurrent neural networks have feedback loops between layers allowing them to be used in time-
103 dependent tasks, such as NLP. One of the most popular feed-forward DNN is convolutional neural
104 network (CNN). CNNs are comprised of three main types of layers: convolutional layers, pooling
105 layers and fully-connected (FC) layers. In general, the training is performed by gradient-based
106 algorithms (e.g. stochastic gradient descent). CNNs shows impressive results in computer vision
107 for image and video processing. Many handcrafted CNN architectures have been proposed such as
108 AlexNet [99], VGG [155], GoogLeNet [170], ResNet [70], and DenseNet [79]. Such DNNs could be
109 giant and include many layers of different types and millions of hyperparameters.

110
111 There are other feed-forward DNNs including but not limited to Deep Boltzmann machines
112 (DBMs), Deep Belief networks (DBNs), Auto-Encoders (AEs) and Restricted Boltzmann Machines
113 (RBMs). Various single-layer unsupervised learning models have been proposed and stacked to
114 build DNNs (e.g. sparse-response RBM (SR-RBM), autoencoder (AE), denoising AE (DAE)). RBM
115 is a two-layers undirected graph, composed of one visible layer and one hidden layer with no
116 connections allowed between nodes of the same layer [74]. An AE is a three-step DNN composed
117 of an input layer, a hidden layer, and an output layer. The number of units in the input layer is the
118 same as the output layer. The encoder is defined by the transformation from the input layer to the
119 hidden layer, and extracts the features from the input data. The decoder transforms the hidden
120 layer to the output layer, and reconstructs the input data from the features. DBN is a generative
121 model consisting of multiple stacked restricted Boltzmann machines (RBMs) trained by contrastive
122 divergence in a unsupervised way [75]. DBM is a network of symmetrically coupled stochastic
123 binary units, which contains a set of visible units. There are connections only between hidden units
124 in adjacent layers, as well as between the visible units and the hidden units in the first hidden layer.

125 Recurrent neural networks (RNNs) are specifically designed for temporal problems. They have
126 both feedback as well as feedforward connections. RNNs have internal memory to allow long-term
127 dependencies which will affect the output. Some intermediate nodes compute values that are stored
128 internally in the DNN. Those internal values are used as inputs to other operations in conjunction
129 with the processing of a later input. Long Short-Term Memory networks (LSTMs) are the most
130 popular variant of RNNs capable of capturing long-term time dependencies [77].

132 2.2 Metaheuristics

133 The AutoDNN problem consists in searching the optimal DNN a^* from a set of possible solutions
134 A which maximizes an *objective function* $f(a)$ while satisfying a set of *constraints*. The search
135 space A is derived from the representation used to encode DNNs. Metaheuristics represent a class
136 of general-purpose heuristic algorithms that can be applied to any optimization problem [172].
137 Unlike exact methods, metaheuristics allow to tackle large scale problems by delivering satisfactory
138 solutions in a reasonable time. In the design of a metaheuristic, two contradictory criteria must
139 be taken into account: *exploration* of the search space (*diversification*), and *exploitation* of the best
140 solutions found (*intensification*).

141
142 **2.2.1 Single-solution based metaheuristics.** *Single-solution based metaheuristics* (S-metaheuristics)
143 improve a single DNN. They could be seen as “walks” through neighborhoods or search trajectories
144 through the search space [172]. S-metaheuristics iteratively apply the generation and replacement
145 procedures from the current DNN. In the generation phase, a set of candidate DNNs are generated
146 from the current solution a . This set $C(a)$ is generally obtained by local transformations of the
147

148 solution. In the replacement phase¹, a selection is performed from the candidate solution set $C(s)$ to
 149 replace the current DNN, i.e. a solution $a' \in C(a)$ is selected to be the new DNN. Popular examples
 150 of such S-metaheuristics are local search (i.e. gradient), simulated annealing and tabu search. In
 151 addition to the representation of DNNs, their common search concepts are the definition of the
 152 *neighborhood* structure and the generation of the *initial solution*.

153
 154 2.2.2 *Population based metaheuristics*. *Population based metaheuristics* (P-metaheuristics) could be
 155 viewed as an iterative improvement of a population of DNNs. P-metaheuristics start from an initial
 156 population of DNNs². Then, they iteratively generate a new population of DNNs using variation
 157 operators. Popular examples of P-metaheuristics are evolutionary algorithms (EAs), ant colony
 158 optimization (ACO), particle swarm optimization (PSO), and estimation of distribution algorithms
 159 (EDA).

160 P-metaheuristics may be classified into two main categories:

- 161 • **Evolutionary-based**: in this category of P-metaheuristics, the DNNs composing the popu-
 162 lation are selected and reproduced using variation operators (e.g. mutation, crossover) acting
 163 *directly* on their representations. A new DNN is constructed from the different features of
 164 solutions belonging to the current population. Evolutionary algorithms (e.g. Differential
 165 evolution (DE), evolution strategy (ES), genetic programming (GP)) represent well-known
 166 examples of this class of P-metaheuristics.
- 167 • **Blackboard-based**³: here, the solutions of the population participate in the construction of
 168 a shared knowledge. This shared knowledge will be the main input in generating the new
 169 population of DNNs. Ant colonies and estimation distribution algorithms belong to this class
 170 of P-metaheuristics. For the former, the shared knowledge is represented by the pheromone
 171 matrix, while in the latter strategy, it is represented by a probabilistic learning model. For
 172 instance, in ant colonies, the generated DNNs by past ants will affect the generation of DNNs
 173 by future ants via the pheromone. Then, the generated DNNs participate in updating the
 174 pheromone.

175
 176 Many stopping criteria have been used for solving the AutoDNN problem. In *static procedures*,
 177 the end of the search is known a priori. For instance, one can use a fixed number of iterations
 178 (i.e. generations in EAs [188], PSO [168]), a limit on CPU resources (i.e. time budget) [203], or a
 179 maximum number of training [82]. In an *adaptive procedure*, the end of the search cannot be fixed
 180 a priori. A fixed number of iterations (generations) without improvement or when a satisfactory
 181 DNN (e.g. given accuracy) is reached.

182 3 PROBLEM FORMULATION

183
 184 Three popular formulations of the target optimization problem have been widely investigated in
 185 the literature:

- 186 • **Neural architectures search (NAS)**: the goal is to search the optimal network topology (e.g.
 187 number of layers, types of operations, connections between operations) [51]. The hyperpa-
 188 rameters are supposed to be apriori fixed and/or optimized in an independent post-processing
 189 search process.
- 190 • **Hyperparameter optimization (HPO)**: this formulation requires an apriori definition of
 191 the DNN architecture. It consists in fixing the various hyperparameters of the DNN [56].

192
 193 ¹Also named transition rule, pivoting rule and selection strategy.

194 ²Some P-metaheuristics such as ant colony optimization start from partial or empty solutions.

195 ³A blackboard system is an artificial intelligence application based on the blackboard architectural model, where a shared
 196 knowledge, the “blackboard”, is iteratively updated by a diverse group of agents [52].

There are two types of hyperparameters: (1) operations hyperparameters which characterize the features associated to operations. For instance, the features of a convolution operation can be the filter size (width, height) and the stride size (width, height); (2) global hyperparameters which characterize the global features of the DNN. An example of global features are the optimization parameters (e.g. learning rate schedules, momentum, batch size) and regularization parameters (e.g. weight decay, dropout rates).

- **Joint optimization (AutoDNN):** the NAS and HPO optimization problems interact in a way that can render this separation suboptimal. In the AutoDNN joint optimization formulation, the two problems are solved in a joint manner. Neuroevolution (e.g. NEAT [163]) was a popular approach to solve the AutoDNN problem, where both the architecture and the hyperparameters are optimized in a global way [127]. An important question is related to the level (i.e. architecture or hyperparameter) in which optimization is carried out at each iteration. Three strategies can be applied: (1) *Global optimization*: which consists in optimizing all levels at the same time [143][162]; (2) *Nested optimization*: which consists in optimizing the different levels in a hierarchical way. At each iteration, the architecture is optimized, then the hyperparameters for this given architecture are optimized [140]; (3) *Sequential optimization*: where the NAS problem is solved first. Then, the hyperparameters for the obtained final solution are optimized.

Let us formulate the general AutoDNN problem. A DNN a can be defined by the quadruplet $a = (V, E, \lambda_V, \lambda_a)$ where V is a set of nodes denoting the layers (i.e. operations) of the DNN, E is a set of edges (i.e. connections) between operations, λ_V is the feature set of operations and λ_a is the global feature set of the DNN. The induced graph $G = (V, E)$ defines the topology of the DNN. Each node has one of L labels, representing the corresponding operations. The space grows exponentially in both $|V|$ and L . Given the space of all datasets \mathbf{D} , the space of all deep learning models \mathbf{M} , and the search space of architectures \mathbf{A} , the optimal DNN consists to optimize the following objective function: $\Theta : \mathbf{A} \times \mathbf{D} \rightarrow \mathbf{M}$. Let d be a given input dataset, in which d_{train} represents the training set and d_{valid} represents the validation set. The deep learning algorithm Θ estimates the model $m_a \in \mathbf{M}_a$ by minimizing:

$$\Theta(d, a) = \arg \min_{m_a \in \mathbf{M}_a} L(m_a, d_{train})$$

where L represents the loss function. The problem consists in finding the optimal DNN a^* maximizing the objective function f using the validation data:

$$a^* = \arg \max_{a \in \mathbf{A}} f(\Theta(a, d_{train}), d_{valid}) = \arg \max_{a \in \mathbf{A}} f(a)$$

where the objective function f can be defined as the negative loss function L which measures the accuracy. The most popular loss functions are RMSE (resp. cross-entropy) for regression (resp. multi-class classification) problems [17].

The NAS and HPO can be seen as a reduced AutoDNN problem. Given an DNN topology defined by the graph G , the hyperparameter optimization problem (HPO) consists to find its optimal hyperparameter configuration: $\lambda^* = (\lambda_V, \lambda_a)^* = \arg \max_{\lambda \in \Lambda} f(a)$, where Λ represents the set of all possible values for the hyperparameters, and a is the DNN induced by G . The NAS problem can be formulated as finding an architecture x^* when all architectures are evaluated under apriori fixed hyperparameter choices: $x^* = \arg \max_{x \in \mathbf{G}} f(x, \lambda^*)$.

The AutoDNN problem is characterized by the following important properties:

- **Large-scale optimization problem:** a DNN could be composed of millions of decision variables. State-of-the-art DNNs have more than 100 layers [79] and billions of hyperparameters [80]. Moreover, the input dataset can be very large.

- 246 • **Mixed optimization problem:** three different types of decision variables arise in AutoDNN:
 247 continuous, discrete ordinal and discrete categorical. Continuous variables refer to real
 248 numbers defined within a given interval (e.g. learning rate, momentum). Discrete ordinal (i.e.
 249 quantitative) variables are related to measurable integer values. Typical examples are the size
 250 of the filter and the stride in CNN pooling operations. Categorical (i.e. qualitative) variables
 251 are non-relaxable variables defined within a finite set of choices (e.g. type of operations,
 252 training optimizer). It is important to notice that different types of variables will require
 253 different optimization approaches.
- 254 • **Variable-size design space:** the search space of the AutoDNN problem contains condi-
 255 tionality. A decision variable is relevant if another variable (or some combinations) takes
 256 a certain value. For instance, the number of layers influences the number of the per-layer
 257 hyperparameters; the type of operation will induce a different number and type of features
 258 variables. The search space of the problem and the definition of the objective and constraint
 259 functions vary dynamically during the optimization process as a function of some variables
 260 values [135].
- 261 • **Extremely expensive black-box objective function(s):** the problem has very expensive
 262 objective function(s) which consist in training the whole DNN and computing the quality of
 263 the network (e.g. loss function). When facing very large-scale datasets the learning might
 264 take several hours, days or even months. Moreover, the black-box objective function do not
 265 give access to a gradient or the Hessian, and do not have properties such as convexity and
 266 smoothness which are used in classical optimization.
- 267 • **Multi-objective optimization problem:** the AutoDNN problem can be formulated as a
 268 multi-objective problem in which many different and conflicting objectives are optimized.
 269 Indeed, in addition to maximize the accuracy, some objectives dealing with cost, size, energy
 270 consumption, inference time of a DNN may be taken into account.

271 4 SEARCH COMPONENTS

272 Our survey is based on a unifying view of optimization algorithms according to their main search
 273 components. The most important and common search components in all metaheuristics are the
 274 problem landscape and the search operators (Fig.1). The problem landscape is defined by the
 275 encodings of solutions which induces the search space, the definition of the objective function(s)
 276 and handling of the constraints. The search operators are mainly the initialization of solution(s)
 277 and the design of variation operators. The search operators are mainly the initialization of solution(s)
 278 and the design of variation operators.

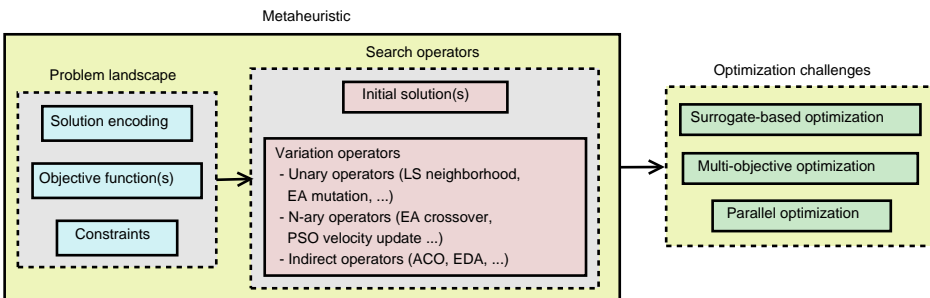

290 Fig. 1. A unified view of problem landscape and search components for AutoDNN metaheuristics, and
 291 challenging optimization issues.

4.1 Representation of DNNs

Designing any AutoDNN metaheuristic needs an encoding (i.e. representation) of a solution. The encoding plays a major role in the efficiency and effectiveness of any metaheuristic and then constitutes an essential step in designing an AutoDNN metaheuristic. This encoding defines the search space associated to the problem. It is preferable that an encoding has the following characteristics:

- **Completeness:** efficient DNNs can be represented. Indeed, many proposed encodings reduce the search space, and then they can miss efficient DNNs.
- **Connexity:** a search path must exist between any two DNNs. Any solution of the search space, especially the global optimum solution, can be attained from any initial solution.
- **Efficiency:** the encoding must be easy to manipulate by the variation operators. The time and space complexities of the operators dealing with the encoding must be reduced.

Many alternative representations have been used in the literature (Fig.2):

- **Direct representations:** the encoding specifies a complete DNN. it describes completely the topology and the hyperparameters associated to the DNN.
- **Indirect representations:** the representation does not encode a complete DNN. A decoder (e.g. rules, greedy procedure) is required to generate the DNN given by the encoding. The decoding may be deterministic or non deterministic.

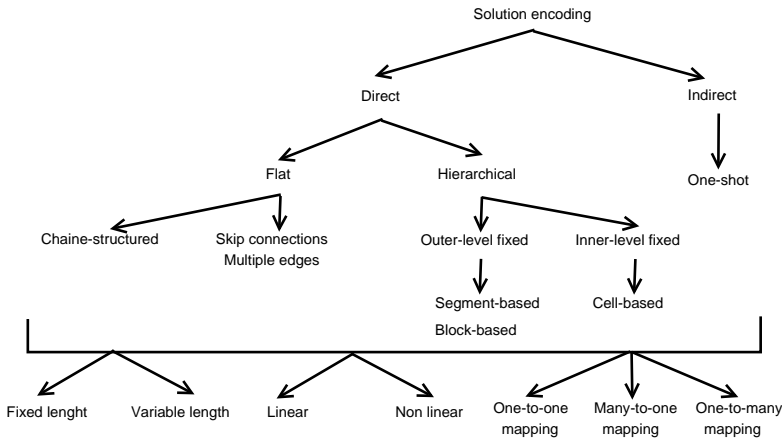

Fig. 2. Classification of the different encodings of DNNs.

4.1.1 Direct representations. Two main families of DNNs may be found in the literature: flat DNNs and hierarchical DNNs.

Flat DNNs: DNNs are generally defined as flat networks (e.g. DBN, some CNNs). The most simple and popular flat network is the *chain-structured* (Fig.3) [203]. Hence, the topology associated to DNNs can be represented by DAG (Directed Acyclic Graphs) $G = (V, E)$, where each node $v \in V$ represents an operation (i.e. layer), and each edge e represents a feature map connecting two operations. Let us notice I_i the set of input edges associated to an operation v_i . The computation of the output edge O_i is: $O_i = v_i(I_i)$. The network can be represented by a sequence of operations such that any operation v_i receives its input from operation v_{i-1} : $O_i = v_i(O_{i-1})$ [63]. An example of such popular DNNs are VGGNet [155] and AlexNet [99].

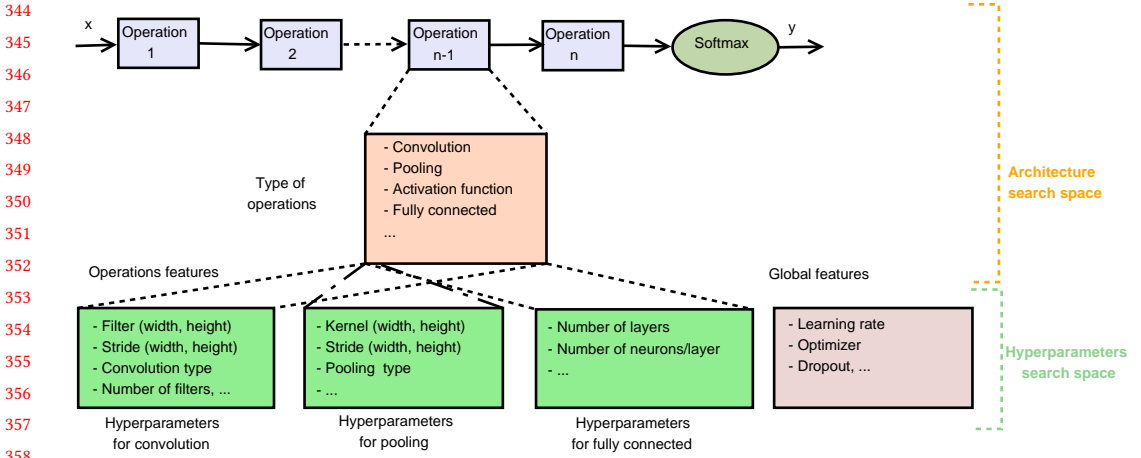

Fig. 3. Chain-structured DNNs. Different colors define different operations. For a CNN they represent unary operations such as convolutions, pooling, activation functions, or multivariate operations such as concatenation or summation.

Extended flat DNNs include skip connections, highway connections and multiple edges between operations (Fig.4) [202][20][50][142][25]. Hence, the incident edges of an operation v_i is the union of O_{i-1} and other ancestor edges: $O_{i-1} \cup O_j/j < i - 1$. Those topologies enable more flexibility in designing DNNs. *Residual networks* (ResNet) [70] (resp. *DenseNets networks* (DenseNet) [79]) belongs to this family of architectures, in which the previous operations are summed (resp. concatenated).

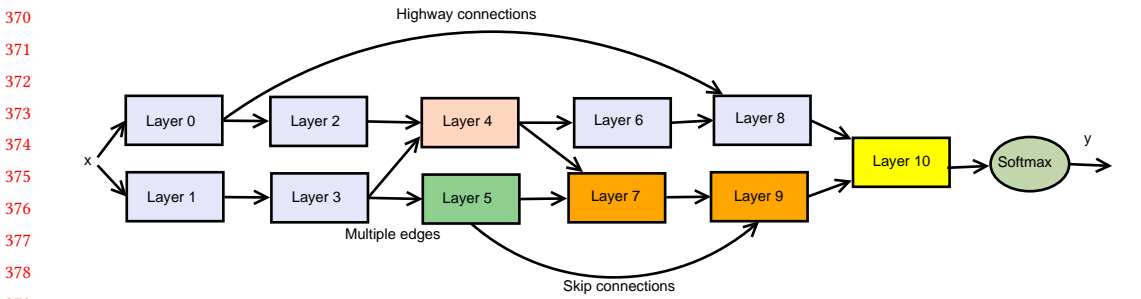

Fig. 4. Skip connected and multiple edges chain-structured DNNs.

A complete encoding must represent the whole information of a DNN a defined by $a = (V, E, \lambda_V, \lambda_a)$ (Fig.3). In one hand, the encoding must specify the architecture of the DNN which is defined by the graph $G = (V, E)$. Hence, the number of operations, type of operations (e.g. convolution for a CNN), and connections between operations must be given. A general graph G (e.g. RNNs) can be represented by its binary adjacency matrix, while a DAG (e.g. CNNs) can be represented by a lower triangular binary matrix. Indeed, a DAG can be encoded so that all the directed edges connects nodes from a lower number to a higher number [143][114]. On the other hand, the encoding must represent the features of all active operations (e.g. number of filters, size of filters and strides for a convolution), and the global features of the DNN (e.g. learning rate). The

393 main property of features encodings are their *variable and mixed nature*: continuous (e.g. learning
394 rate), ordinal discrete (e.g. number of layers) and categorical discrete (e.g. type of operations).

395
396 Many different encodings have been used to represent flat DNNs. *Linear representations* encoded
397 by string of symbols of a given alphabet are widely used. DBN networks are generally represented
398 by linear encodings, which include topological parameters such as the number of hidden layers
399 and neurons by hidden layer, and some global features for the contrastive divergence (e.g. weight
400 cost) and back-propagation (e.g. learning rates for weights and biases). For CNNs, the presence
401 of many conditioned variables makes that the encoding is intrinsically of *variable-length*. For
402 instance, the topology (resp. hyperparameters) is conditioned by the number of layers (resp. type
403 of operation). However, many authors use *fixed-length encodings* by assuming some restrictions. In
404 HPO optimization, the architecture (i.e. graph $G = (V, E)$) is a priori fixed. Then, a fixed-length
405 mixed linear encoding is mostly used to represent the operations features λ_v and global
406 features λ_a of DNNs (e.g. chain-structured architectures [57][202]). In NAS and AutoDNN
407 optimization, a fixed-length encoding is still possible when the number of operations (i.e. layers)
408 is fixed [180]. Compared to the previous encoding, it will include the set of operations and their
409 connections [120]. In [7], the type of operations (e.g. convolution, pooling, fully connected, global
410 average pooling), and hyperparameter settings (e.g. number of filters, kernel size, stride and pooling
411 size) are considered in a linear fixed-length encoding. When the number of layers is bounded
412 by a maximal value, the use of a fixed-length encoding can also be an alternative. In [113], the
413 proposed fixed-length mixed encoding includes the number of layers (ordinal discrete), learning
414 rate (continuous), type of activation function (categorical discrete) and the gradient algorithm used
415 in training (categorical discrete).

416
417 Variable-length encodings is another suited alternative to encode flat DNNs. In [168][92], a
418 variable length encoding is used to solve the AutoCNN problem. The encoding represents different
419 numbers of convolutional layers and pooling layers, and their hyperparameters. In [5], a variable-
420 length sequence of layers and their respective hyperparameters is used to solve the AutoCNN
421 problem. The encoding represents the general structure of the network (i.e. sequence of layers)
422 and the hyperparameters associated to each layer using a human-readable *context-free grammar*.
423 In [178], the encoding is inspired from IP address in computer networks to represent a variable
424 length encoding of CNNs. An IP address is represented by sequence of decimal numbers delimited
425 by full stops (e.g. 192.159.1.354). The network is encoded by k IP addresses where k is the maximum
426 number of layers. Each layer is represented by an IP address, and non used layers are disabled.

427
428 *Non linear encodings* such as grammars, CGP (Cartesian Genetic Programming) [123][176][124],
429 and tree structures [139][130] have also been used to encode flat DNNs.

430
431 **Hierarchical DNNs:** in the last years, a widely used network type to tackle the scalability
432 issue in DNNs is hierarchical networks [108]. They allow to reduce the search space, integrate
433 human knowledge in the definition of the building blocks, and can be more flexible to solve other
434 learning tasks [203]. Compared to flat networks, they have smaller degree of freedom in the
435 architecture design. In hierarchical DNNs, the main idea is to have several blocks⁴ which are used
436 as building blocks in the design of multi-level DNNs. Many popular hierarchical network have
437 been handcrafted, including ResNet [70] and DenseNet [79]. Cell-based CNN architectures [203],
438 inception and xception networks [171] represent the most popular hierarchical DNNs. Except a
439 three-level model proposed in [12], most of the hierarchical DNNs are composed of two levels.
440 The inner-level represents the set of primitive building blocks, while the outer-level contains the

441
442
443
444
445
446
447
448
449
450
451
452
453
454
455
456
457
458
459
460
461
462
463
464
465
466
467
468
469
470
471
472
473
474
475
476
477
478
479
480
481
482
483
484
485
486
487
488
489
490
491
492
493
494
495
496
497
498
499
500
501
502
503
504
505
506
507
508
509
510
511
512
513
514
515
516
517
518
519
520
521
522
523
524
525
526
527
528
529
530
531
532
533
534
535
536
537
538
539
540
541
542
543
544
545
546
547
548
549
550
551
552
553
554
555
556
557
558
559
560
561
562
563
564
565
566
567
568
569
570
571
572
573
574
575
576
577
578
579
580
581
582
583
584
585
586
587
588
589
590
591
592
593
594
595
596
597
598
599
600
601
602
603
604
605
606
607
608
609
610
611
612
613
614
615
616
617
618
619
620
621
622
623
624
625
626
627
628
629
630
631
632
633
634
635
636
637
638
639
640
641
642
643
644
645
646
647
648
649
650
651
652
653
654
655
656
657
658
659
660
661
662
663
664
665
666
667
668
669
670
671
672
673
674
675
676
677
678
679
680
681
682
683
684
685
686
687
688
689
690
691
692
693
694
695
696
697
698
699
700
701
702
703
704
705
706
707
708
709
710
711
712
713
714
715
716
717
718
719
720
721
722
723
724
725
726
727
728
729
730
731
732
733
734
735
736
737
738
739
740
741
742
743
744
745
746
747
748
749
750
751
752
753
754
755
756
757
758
759
760
761
762
763
764
765
766
767
768
769
770
771
772
773
774
775
776
777
778
779
780
781
782
783
784
785
786
787
788
789
790
791
792
793
794
795
796
797
798
799
800
801
802
803
804
805
806
807
808
809
810
811
812
813
814
815
816
817
818
819
820
821
822
823
824
825
826
827
828
829
830
831
832
833
834
835
836
837
838
839
840
841
842
843
844
845
846
847
848
849
850
851
852
853
854
855
856
857
858
859
860
861
862
863
864
865
866
867
868
869
870
871
872
873
874
875
876
877
878
879
880
881
882
883
884
885
886
887
888
889
890
891
892
893
894
895
896
897
898
899
900
901
902
903
904
905
906
907
908
909
910
911
912
913
914
915
916
917
918
919
920
921
922
923
924
925
926
927
928
929
930
931
932
933
934
935
936
937
938
939
940
941
942
943
944
945
946
947
948
949
950
951
952
953
954
955
956
957
958
959
960
961
962
963
964
965
966
967
968
969
970
971
972
973
974
975
976
977
978
979
980
981
982
983
984
985
986
987
988
989
990
991
992
993
994
995
996
997
998
999
1000

⁴Also called patterns, modules, stages, segments, motifs, and cells.

full architecture which is a composition of the building blocks. Depending on the optimized level, different encodings have been proposed:

- Inner-level optimization:** the topology of the DNN at the outer-level is apriori fixed. The problem consists in finding the optimal inner-level blocks. In [188][117][197][174], each block can be composed of a given number of layers n . Let k be the number of possible configurations for a layer. Then, the size of the search space will be $k \times (n - 1)!^b$, where b is the number of blocks. In [187], *path encoding* is proposed in which they represent the set of directed paths of a cell. The total number of paths is exponential in n : $\sum_{i=0}^n k^i$ while the adjacency matrix scales quadratically.

Many proposed encodings are *many-to-one mappings* [26], in which many encodings can represent the same DNN, and then duplicate evaluations are possible. In [188][117], a hierarchical chained structured DNN is proposed. The outer-level is considered as a sequence of a given number of S connected stages $B_s, s = 1, \dots, S$ (Fig.5). The hyperparameters of the stages are fixed. The search space is related to the configuration of inner-level segments. Each segment is defined as a set of n maximal predefined operations $B_{s,i}, s = 1, \dots, S \& i = 1, \dots, n$ such as convolution, pooling layers and batch normalization. The proposed encoding is based on a *fixed-length binary vector* (i.e. size of $n \times n - 1 \div 2$) which represents the connections between the nodes. This encoding is flexible enough that many well-known hand-crafted DNNs can be represented such as VGGnet, ResNet and DenseNet. This encoding is a *many-to-one* mapping, and induces a search space of size $\Lambda = S \times 2^{n(n-1) \div 2}$.

In [197], a DNA-based encoding is proposed. A DNN is defined as a fixed-length sequence of blocks. Each block is composed of a set of convolution layers with a given maximal number of layers. For each convolution layer, there are three kinds of hyperparameters to be encoded: number of filters, kernel size, and input layer indices. In [174], the encoding is represented by connecting segments. Each segment has repeating patterns of operations, and is parameterized by the operation type and the number of repetitions of the patterns. Each pattern is a sequence of connected operations.

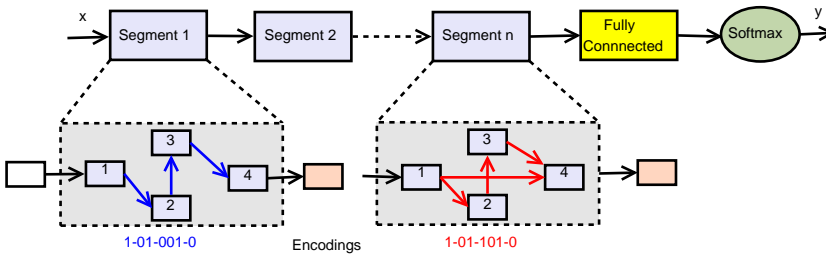

Fig. 5. Template-based hierarchical DNNs chained architectures using summation as merging operation. Only the dark orange network for each segment has to be designed. The other operations are fixed.

- Outer-level optimization:** this methodology is widely used in *cell-based architectures* [203]. Cell-based CNNs are designed by a combination of repeated cells in a predefined arrangement. A cell can be defined as a small DAG which transforms a feature using an ordered sequence of N nodes [199][171][46][186] (Fig.6). A popular example of such DNN architecture is NASNet [203]. The cells can be stacked to form a CNN or recursively connected to form a RNN. Various macro-architectures are used such as a sequence where each cell receives the outputs of the two preceding cells as input [203], or combined in a multi-branch chained network

[25]. In general, the topology of the different types of used cells is predefined. Then, the problem consists to find the optimal architecture at the outer-level. In [203], the authors consider two different types of cells: normal cell (resp. reduced cell) which preserves (resp. reduces) the dimension of the input. The architecture is optimized by finding the optimal sequence of those two types of cells.

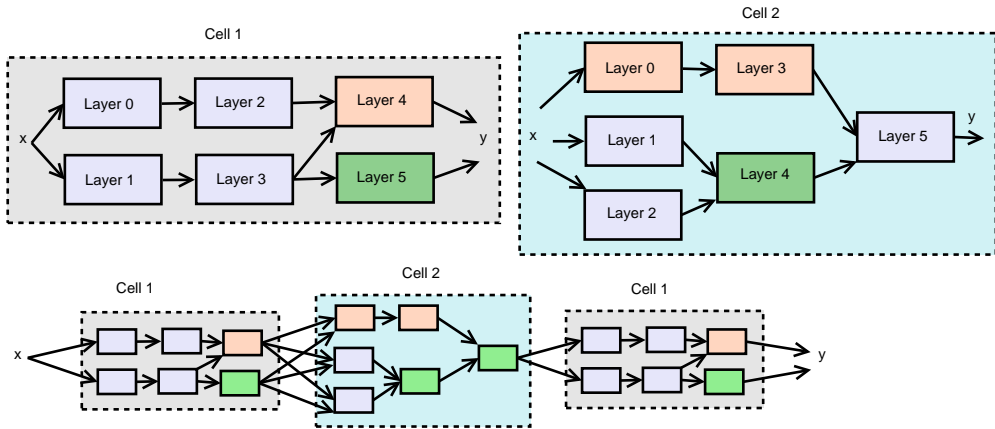

Fig. 6. Cell-based DNNs. Two different cells are illustrated: cell1 and cell2. The final architecture is built by the sequence (cell1, cell2, cell1). More sophisticated sequencing can be designed such as multi-branch spaces, by replacing layers with cells.

- All levels optimization:** some approaches perform the search in both levels: the outer-level (i.e. macro-architecture of DNN) and the inner-level (i.e. micro-architecture of blocks) [106][200]. In [106], the authors propose a trellis-like network level search space that augments the block level search space to form a hierarchical architecture search space. To reduce the complexity of the search, continuous relaxation of discrete variables is performed to be optimized by a gradient algorithm.

This idea of relaxing discrete representations into continuous ones has been explored in many flat and hierarchical DNNs allowing the application of gradient-based optimization algorithms [147][109][2][153][177][105][195]. In [109][33], each operation is encoded by a mixture of candidate operations, where the operations mixing weights are parameterized by a continuous vector. Then, the categorical choice of a given operation is reduced to a Softmax over all possible operations.

4.1.2 Indirect representations. Direct encodings represent strong specification schemes that may have a problem with scalability. They require longer encodings as DNN size increases, and search space will be increased accordingly. Indirect encoding allows a more compact representation in which the DNN is not totally specified in the representation, although they can be derived from it. Instead, a decoding strategy (e.g. greedy algorithm, set of rules) is used to decode the generated DNNs. For the sake of efficiency, we need to be sure that indirect encodings do not restrict DNNs to some suboptimal class of DNNs [66]. The most popular indirect encodings are: one-shot architectures and LSTMs.

One-shot architectures: they represent the most popular indirect encodings of DNNs. The main motivation is rather than training hundreds of different DNNs from scratch, one can train a single large network capable of generating any DNN architecture in the search space. All architectures are treated as different subgraphs of a supergraph and shares weights between architectures that have

edges of this supergraph in common [109] (Fig.7). First, the weights of a single one-shot model are trained. Then, architectures (i.e. subgraphs of the one-shot model) are generated and evaluated by weights sharing from the one-shot model. The drawback of one-shot architectures is that their associated supergraph restricts the search space to its subgraphs [149]. The one-shot architecture⁵ search consists of four steps [12]: (1) Define a search space to encode a wide variety of DNNs using a single one-shot model. (2) Train the one-shot model to find the weights. (3) Evaluate generated architectures on the validation set using the pre-trained one shot model. (4) Re-train the best found DNNs from scratch and assess their performance on the test set. Decoding one-shot architectures are generally based on sampling independently from a fixed probability distribution. In [20], a random search is applied, but it can be replaced by metaheuristics.

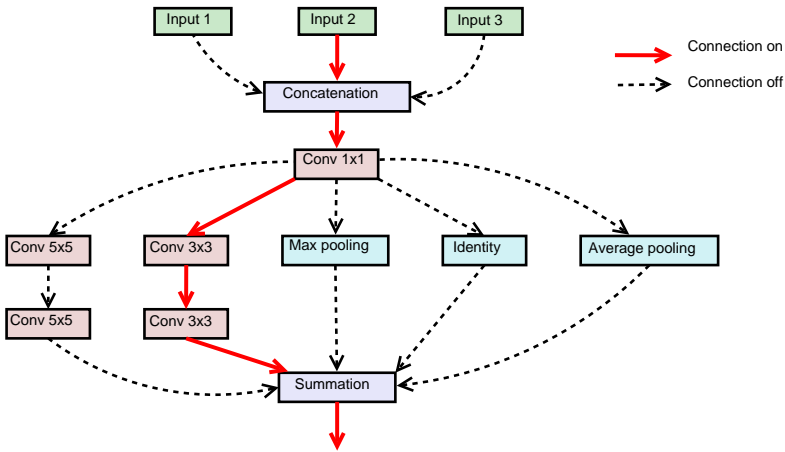

Fig. 7. Example of one-shot DNN cell architecture. It is composed of five separate operations. By sampling we can select the two conv 3x3 operations path. To be evaluated, the network will not retrain the weights.

LSTM encoding-decoding: the original DNN architecture a is mapped to continuous representation $\epsilon: E: \mathbf{A} \rightarrow \epsilon$ [119]. A single layer vanilla LSTM is the basic model of encoder and the hidden states of the LSTM are used as the continuous representation of a . Then $E(a)$ is optimized into $E(a')$ via gradient descent. Afterwards $E(a')$ is transformed into a new architecture a' using the decoder LSTM network. The decoder is responsible to decode out the string tokens in a' , taking $E(a')$ as input and in an autoregressive manner. The encoder and decoder are trained by minimizing the combination of performance prediction loss and structure reconstruction loss.

4.2 Objective function

The objective function f formulates the goal to achieve. It associates to each DNN a real value which describes its quality $f: \mathbf{A} \rightarrow \mathbb{R}$. The classical way to evaluate the performance of a DNN a is to train it on training data and compute its performance on validation data. Accuracy on unseen data is the most used metric to assess the performance of the learned model. The most time-consuming part of the optimization process is the training of the DNN. Speeding up the training process is widely used in order to reduce the computational cost. While these low-fidelity estimations reduce the computational cost, they also introduce bias in the estimate as performance will typically be under-estimated. An important property of low-fidelity procedures is that the relative ranking of

⁵Also called Hypernetworks.

architectures remain the same [149]. The main families of the approaches allowing to speedup the computation of the objective function can be classified as follows (Fig.8):

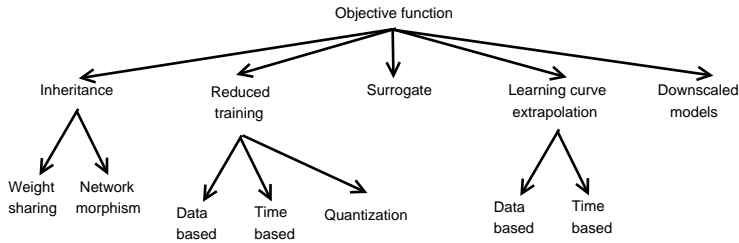

Fig. 8. Main approaches for speeding up the computation of the objective function.

- Inheritance:** this approach evites the training from scratch and thereby substantially reduce the required training time per DNN. It is based on knowledge transferring between DNNs. *Weight sharing* is a well-known approach in which we initialize the weights of the generated DNNs based on weights of already trained DNNs [137][24]. Hence, a DNN can be transformed while leaving some weights unchanged [82][184][88][49]. Instead of a random initialization of the weights, informed decisions (e.g. *Xavier* initialization) [60] have also been used. Pre-trained weights using *transfer learning* also allows to reduce the huge cost of training DNNs from scratch [185]. Another popular inheritance-based approach is *network morphisms* [184]. In the context of DNNs, network morphism refers to a parameter-transferring map from a given DNN to a generated DNN that preserves its function and outputs [50]. Morphing types are demonstrated including depth morphing [32], width morphing, kernel size morphing, and subnet morphing [184].
- Reduced training:** this low-fidelity approach in training consists in reducing the training time [193], the number of epochs [168][201], or the input dataset data [97]. For example, one can carry out search on CIFAR-10 and "transfer" the obtained DNN (with some changes, e.g. changing the number of filters) to ImageNet [104][189]. *Quantization approaches* represent weights using a small set of permitted values, reducing the number of bits required to store each weight. In [20][38], the weights takes binary values, and then the complexity of multiplications operations will be reduced during training. Existing quantization methods can be mainly divided into two categories. The first category methods seek to design more effective optimization algorithms to find better local minima for quantized weights. For instance, these works introduce *knowledge distillation* [144]. The second category approaches focus on improving the quantization function (e.g. binarization).
- Surrogate⁶:** an alternative to reduce the high-complexity of the objective function is the use of a surrogate. Surrogate models replace expensive objectives with models that provide an approximation. Section 5 details this important class of optimization approaches, named surrogate-based optimization⁷. In [59], the idea of *weight agnostic DNNs* has been proposed, where there is no use of any explicit weight training in the optimization process. They are supposed to have strong inductive biases that can already perform various tasks with random weights.

⁶Also known as meta-model and approximation.

⁷Also called Bayesian optimization.

- 638 • **Downscaled models:** many strategies consist in using downscaled models. Reduction can
639 be applied to data and network. In data reduction, a partial dataset is used instead of the whole
640 dataset [178]. Downsampling techniques (e.g. lanczos, nearest, bilinear, bicubic, hamming,
641 box) have also been used to reduce the resolution of images [34]. In network reduction, down-
642 scaled models using subset of the network in training. In [203][193], reduced architectures
643 with less filters per layer and less cells have been trained.
- 644 • **Learning curve extrapolation:** it describes two different strategies: time-based and data-
645 based. In time-based learning curve extrapolation, the performance of the training procedure
646 is learned function of its number of iterations or training time [197]. Different learning models
647 have been investigated such as logistic regression [169], neural networks [97], support vector
648 machines regression [8], linear regression [8], random forest [8], and recurrent neural network
649 (e.g. LSTM) [104]. In [45], the learning curve model is used to terminate training of DNNs
650 when it is unlikely to beat the performance of the best found DNN. In data-based learning
651 curve extrapolation, the performance of the training procedure is learned function of the
652 size of the available dataset for training. In [139], a training is carried out for a few epochs,
653 and then meta-learner network (e.g. RNN) predicts the performance a fully trained network
654 would have.

655 Low-fidelity approaches can also help to avoid *overfitting*. When using low-fidelity approaches,
656 full training are generally applied at the end of the optimization for the best found DNNs [180]. Other
657 adaptive approaches with gradual increase in fidelities during the search have been investigated
658 [101][53].
659

660 4.3 Constraints

661 Many constraints characterize the AutoDNN problem, such as the number of layers, model complex-
662 ity, computation cost, memory consumption cost, training time, prediction time, and energy usage
663 [175]. The constraints may be of any kind: linear or non linear, equality or inequality constraints.
664 The proposed constraint handling techniques can be classified as:
665

- 666 • **Reject:** reject strategies represent a simple approach, where only feasible solutions are kept
667 during the optimization process and then infeasible solutions are automatically discarded
668 [78][46]. This kind of strategies is conceivable if the portion of infeasible solutions of the
669 search space is very small. Moreover, they do not exploit any information on infeasible
670 solutions.
- 671 • **Penalizing:** in penalizing strategies, infeasible solutions are considered during the search
672 process. The objective function is extended by a penalty function which will penalizes
673 infeasible solutions using for instance linear penalization $f'(a) = f(a) + \lambda c(a)$, where c
674 represents the penalty function (e.g. number of violated constraints, amount of infeasibility)
675 and λ the weighting factor (e.g. static, dynamic, adaptive). This is the most popular approach
676 in which many alternatives have been used to define the penalties [174][202][200][177].
- 677 • **Repairing:** repairing strategies consist in heuristic algorithms transforming an infeasible
678 solution into a feasible one. A repairing procedure is applied to infeasible solutions to generate
679 feasible ones. Those strategies are applied in the case where the search operators may generate
680 infeasible solutions.
- 681 • **Preserving:** in preserving strategies, the encoding and variation operators will insure the
682 generation of feasible solutions. They incorporate problem-specific knowledge into the
683 encoding and search operators to generate only feasible solutions and then preserve the
684 feasibility of solutions. Incorporating prior knowledge about typical properties and allowable
685 structures of DNNs can reduce the size of the search space and then simplify the search. One
686

687 can find the following constraints: maximum number of layers, possible types and number of
688 operations [168], starting and ending layers [188][178][7], possible connections [191], and
689 fixed sequence of operations [117].
690

691 4.4 Initial solution(s)

692 The generation of initial solutions(s) has a great impact on the efficiency and effectiveness of
693 metaheuristics. For a single solution initialization, there is always a tradeoff between the use of
694 random and “good” initial solutions in terms of the quality of solutions and the computational time.
695 In the initialization of a population of solutions, an additional criterion to deal with is diversification.
696 If the initial population is not well diversified, a premature convergence can occur. Many approaches
697 have been developed for the AutoDNN problem:

- 698 • **Random generation:** most iterative metaheuristics approaches initialize solution(s) in a
699 random way (e.g. Gaussian distribution, uniform): EAs [188], PSO [168], DE [179], gradient
700 [109][119].
- 701 • **Heuristic generation:** initial solutions can also generated by low-cost heuristics. In general,
702 greedy algorithms (e.g. reinforcement learning) are used for their effectiveness. In [76], the
703 authors suggest using a lower-dimensional search space to quickly identify promising areas
704 (e.g. reducing the resolution of images). This information can then be used to initialize the
705 metaheuristic for the original, higher-dimensional search space.
- 706 • **Partial architectures:** the optimization process starts with reduced small architectures
707 [114][22][59], or well known skeleton architectures and tries to augment them. In [57] (resp.
708 [180]), the VGGNet (resp. DenseNet) skeleton is used. Some metaheuristics start with poor
709 trivial architectures and tries to improve them by fixing for instance the number of layers
710 and connections [158][165][202], and reducing the type of operations [143]. This approach
711 do not avoid the additional bias introduced by the skeletons.
- 712 • **Complete architectures:** some work propose initial solutions based on prior-knowledge
713 hand-crafted architectures [117] and/or best known DNNs [91]. Other works start with giant
714 DNNs to be compressed (i.e. dropout, swapout, subgraph search) for various learning tasks
715 [55][177][195][137][30]. This approach add an additional bias introduced by the used DNN.
- 716 • **Mixed initialization:** for a better compromise between diversification and quality, mixed
717 strategies may be applied. In [108], a combination between random DNNs and trivial DNNs
718 (e.g. chain of operations) is developed.
- 719 • **Diversified population:** to our knowledge there is no work dealing explicitly with diversifying
720 an initial population of DNNs using for instance sequential or parallel diversification
721 strategies [172].
722

723 4.5 Search operators

724 The role of variation operators is the generation of new DNNs during the search process. The main
725 variation operators found in optimization approaches can be classified as greedy procedures, unary,
726 n-ary and indirect.
727

728 *4.5.1 Constructive procedures.* Constructive (i.e. greedy) procedures start from an elementary or
729 null DNNs and construct a complete DNN by adding operations and connections until a DNN that
730 is capable of the solving the task emerges [133]. Very few greedy algorithms have been proposed
731 for the AutoDNN problem [114]. Sequential learning (i.e. Markov decision process) approaches
732 such as RL can be considered belonging to this family of optimization algorithms. In RL approaches,
733 an agent is trained to select the operation of a DNN in a particular order. The generation of a
734 DNN architecture is carried out by the agent’s action, in which the reward is based on an estimate
735

of the performance of the trained architecture on unseen data. The main questions in designing a RL are: how they represent the agent’s policy and how they optimize it. In [7] the MetaQNN method use ϵ -greedy Q -learning to train a policy which sequentially chooses a layer’s type (e.g convolution, pooling, and fully connected layers), connections between layers, and corresponding hyperparameters. This approach has been generalized to hierarchical DNNs, in which a block is repeated to construct a network [198]. In [202], a *policy gradient* is applied to approximate the reward function. The author use *recurrent neural network (RNN)* policy to sequentially constructs the DNN architecture. This method has been extended in the state-of-the-art NASNet approach [203], which constructs repeated blocks composed of convolution and pooling operations. *Multi-armed bandits* approaches have also been investigated [101].

In contrast, pruning procedures start from a complete DNN and at each iteration reduce the complexity of the network by removing nodes or connections [129], in the hope to improve the generalization of the DNN. A large variety of DNN pruning approaches have been proposed using different pruning criteria [18]. In the “brain damage” approach [107], the authors remove the redundant parameters using derivate-related criteria. In [19], the weights are represented as Gaussian random variables and weights with lower mean value and larger uncertainty are pruned. In [166], the Hebbian rule is used as a pruning criterion, where more connections between weekly correlated neurons are skipped. The connecting weights can also be skipped by regularization terms such as the squared l_2 norm and l_0 - norm [36].

4.5.2 Unary operators. Unary variation operators transform a single DNN into another one: $A \rightarrow A$. In general, it represent a small change (i.e. perturbation) of a DNN. Some important properties must be taken into account in the design of unary operators: ergodicity, validity and locality [172]. The most popular unary operators in metaheuristics are neighborhood in S-metaheuristics (e.g. gradient) and mutation in EAs. The design of unary operators depends on the type of representations. For graph-based encodings, it consists in adding/deleting a node or a connection of the graph. In discrete representations, it consists generally in changing the value associated to an element by another value. For continuous variables, the most used class of unary operators has the form $x' = x + M$, where M is a random variable which take different forms (e.g. uniform random, Gaussian distribution). Unary operators have been applied to all levels of DNNs encodings (Fig. 9):

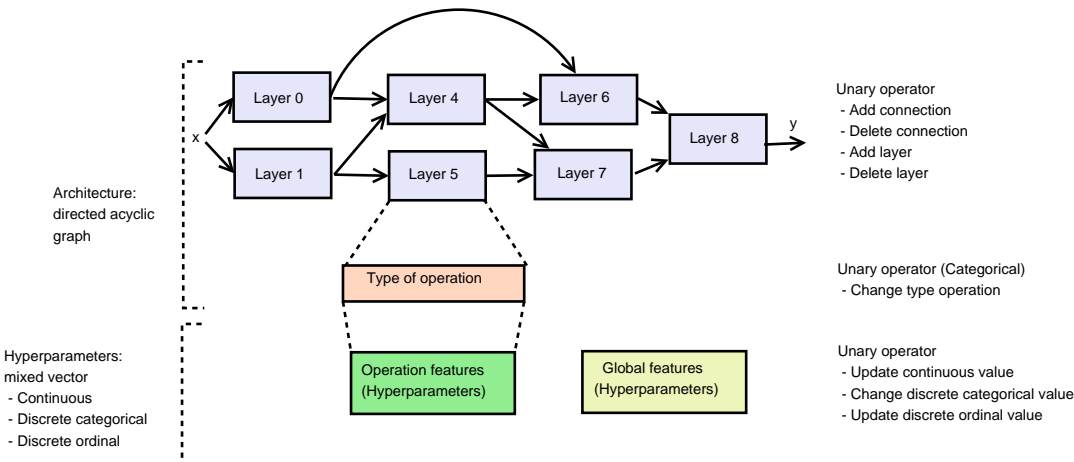

Fig. 9. Unary variation operators at different levels of a DNN.

- 885 • **Architecture:** unary operators at this level consists to update a DAG using for instance the
886 following operations: add layer, delete layer, change type of layer, add connection, and remove
887 connection. Those unary operators have been used in different optimization frameworks:
888 – **Neighborhoods in S-metaheuristics:** in some papers, the authors have relaxed the
889 discrete encoding of DNN into continuous encodings to enable gradient-based optimiza-
890 tion [153][2][108][109][119]. Hence, gradient-based optimization is applied using classical
891 neighborhoods of continuous variables.
892 – **Mutation in EAs:** in flat networks, many mutation operators have been designed. Discrete
893 mutations have been used in DAG representations of CNNs to connect or disconnect two
894 operations [117][188], to add layer, remove layer [5][162][50][120][127], replicate layer [4].
895 Continuous mutations have been applied in [154] into a CMA-ES algorithm by relaxing the
896 binary adjacency matrix into continuous matrix and using rounding operations. In [139],
897 tree-based mutations have been designed for LSTMs: (1) Mutation to randomly replace
898 an operation with an operation of the same family, (2) Mutation to randomly inserts a
899 new branch at a random position in the tree. (3) Mutation to shrink the tree by choosing a
900 branch randomly. For hierarchical DNNs, the same unary operators can be applied at any
901 level of the architecture hierarchy.
- 902 • **Hyperparameters:** global and operations features of a DNN are generally encoded by a
903 mixed vector of continuous and discrete values:
904 – **Neighborhood in S-Metaheuristics:** continuous neighborhoods [153][2], and mixed
905 neighborhoods [50][157] have been designed to be used in local search algorithms.
906 – **Mutation in EAs:** discrete mutations have been used in different EA frameworks. In [165],
907 the $(1 + \lambda)$ -ES is applied in which λ solutions are generated by discrete-based random
908 uniform mutation on hyperparameters (e.g. number of filters, size of filters). In [91], discrete
909 categorical mutations are applied in designing LSTMs, such as changing the element-
910 wise operation and the activation function. Continuous mutations have been defined in
911 a differential evolution (DE) algorithm [179] and a CMA-ES algorithm [116]. In [116], all
912 discrete and continuous variables are scaled to be in $[0, 1]$, on which samples λ candidate
913 DNNs are generated from a multivariate normal distribution. Mixed mutation operators
914 have also been defined for global (e.g. learning rate, training optimizer) and operations
915 hyperparameters (e.g. activation function, filter size) [113][143][50].

916 For hierarchical DNNs, the level in which unary operators are applied can be sampled randomly. In
917 [108], the authors sample the level k , the building block m at the level k , then a unary operator is
918 applied to an element of this building block m .
919

920 **4.5.3 N-ary operators.** Unlike unary operators, n-ary variation operators recombine a set of n
921 DNNs into another one: $\mathbf{A} \times \mathbf{A} \dots \times \mathbf{A} \rightarrow \mathbf{A}$. Their role is to inherit the building blocks of a set of
922 DNNs to generate new DNNs. The most popular n-ary operators in metaheuristics are crossover
923 in EAs and velocity update in PSO. The most used crossover operators are the *1-point crossover*
924 and its generalization the *n-point crossover*, in which n crossover cuts are randomly selected and
925 the solution is generated by interchanging the segment of each parent. In *uniform crossover*, each
926 element of the solution is selected randomly from either parent, which is more flexible for mixed
927 vectors. For continuous variables, one can add arithmetic and geometrical crossover operators. In
928 PSO, the velocity updating of any particle x_i is computed function of the global best DNN $gBest$
929 and local best DNN $pBest_i$. As for unary operators, the design of binary operators depend mainly
930 on the variables to be inherited:
931

- 932 • **Architecture:** n-ary operators have been used in different optimization frameworks:
933

- 834 – **Crossover in EAS:** in flat DNNs using linear encodings, a 1-point crossover has been
835 designed to recombine the layers [179][5][114]. Crossover operators specific to tree en-
836 codings of architectures have been also developed (e.g. Homologous crossover for LSTMs
837 [139]). In hierarchical DNNs, a uniform crossover applied at the level-1 blocks has been
838 used in [188]. Each pair of corresponding blocks are exchanged with a given probability. In
839 a binary encoding of a DAG, a crossover operator preserve the common building blocks
840 shared between both parents by inheriting the common bits from both parents [117]. Then,
841 it maintains, relatively, the same complexity between the parents and their offspring by
842 restricting the number of “1” bits in the offspring’s bit-string to lie between the number of
843 “1” bits in both parents (Fig.10). In general, all the values at lower levels are inherited in the
844 crossover operator involving higher levels [179].
 - 845 – **Velocity update in PSO:** it needs to have a fixed length for all particles. Hence, new
846 velocity updates have designed for variable-length representations. In [168], the authors
847 used truncation and padding to deal with variable-length encodings. In [178], a fixed-length
848 bounded by the maximum length in which disabled layers are encoded in the representation
849 and participate to the velocity update.
 - 850 • **Hyperparameters:** any classical n-ary operators can be applied to mixed vectors character-
851 izing the global and operations features of a DNN:
 - 852 – **Crossover in EAs:** unlike n-point crossovers, the uniform crossover is well adapted to
853 fixed-length mixed encodings [113].
 - 854 – **Velocity update in PSO:** classical velocity updates are based on fixed-length continuous
855 vectors. In [57], the discrete variables are relaxed to continuous variables, such that the
856 classical velocity update is applied. Then, a cast (i.e. rounding) operation is carried out.
- 857 Other n-ary operators have been applied in other metaheuristics. In [164] a tree growth
858 algorithm (TGA) has been developed for AutoCNN. The n-ary operator consists in moving
859 $N/2$ solutions y_i to the distance between the closest best solutions x_1 and x_2 , by producing
860 linear combinations: $y_i = \lambda x_1 + (1 - \lambda)x_2$. For discrete variables, the obtained values are
861 rounded to the closest integer value.

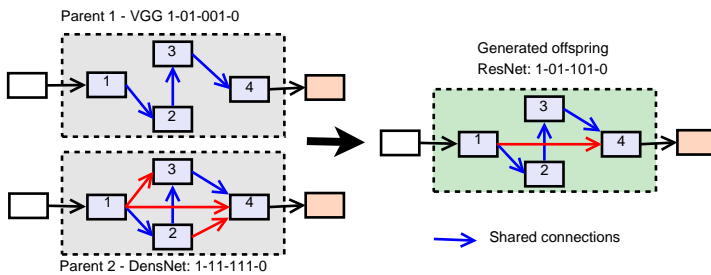

872
873 Fig. 10. An example of crossover operator inheriting and recombining building blocks [117].
874
875

876 4.5.4 *Indirect operators.* The solutions of the population participate in the construction of a shared
877 knowledge. This shared knowledge will be the main input in sampling the new population of DNNs.
878 The recombination in this class of algorithm between solutions is indirect through this shared
879 memory. ACO and EDA are the most popular algorithms belong to this class of Pmetaheuristics:

- 880 • **Ant colony optimization (ACO):** the shared knowledge is represented by the pheromone
881 matrix. ACO have been developed to design the LSTM cell structure of the network. LSTMs
882

are generated by a given number of ants, and having them choose a path through the fully connected DNN biased by the amount of pheromone on each connection. The good quality generated DNNs are used to update the pheromone, reinforcing the features (i.e. connection between operations) that provide good solutions [43][48]. The same approach has been developed for CNN [22]. For a given depth of the CNN, each ants constructs a complete CNN by selecting the next operation by using the global pheromone.

- **Estimation of distribution algorithms (EDA):** the shared knowledge is represented by a probabilistic learning model. In [117], a Bayesian optimization algorithm (BOA) has been developed to find inherent correlations between the decision variables. In AutoDNN, this translates to correlations in the blocks and paths across the different segments. Exploitation uses past information across all networks evaluated to guide the final part of the search. More specifically, say we have a network with three segments s_1 , s_2 and s_3 . By using the history of generated solutions, the operator constructs a Bayesian Network relating those variables, which consist in modeling the probability of networks beginning with a particular segment s_1 , the probability that s_2 follows s_1 , and s_3 follows s_2 . Those estimates are updated during the search, and new offsprings are generated by sampling from this Bayesian Network.

Other optimization approaches use indirect operators. A Bayes Monte Carlo procedure has been used [28]. A set of DNNs are sampled. Then, a probability distribution over high-performing DNNs is learned.

5 SURROGATE-BASED OPTIMIZATION

Surrogate-based optimization⁸ (SBO) is a popular approach to deal with the AutoDNN problem. These algorithms are iterative sampling procedures relying on surrogate models (i.e. metamodels, approximation) of the considered objective function which are generally characterized by an expensive computational cost [9][152]. They iteratively determine and explore the most promising solutions of the design space, thus simultaneously refining the surrogate model and converging towards the problem optimum [89]. First, a set of diversified observations D_n are generated using for instance Design of Experiments (DoE) or Latin Hypercube. Using this set of observations D_n , a surrogate $s(f) : A \rightarrow \mathbb{R}$ of the objective function f is constructed. Then, it consists in sampling iteratively, using the surrogate, the most promising solution $x_{n+1} \in \arg \max q_{s(f)}$ based on an *infill sampling criterion* (i.e. acquisition function) $q_{s(f)} : A \rightarrow \mathbb{R}$. Usually the acquisition function uses exploiting and exploring sampling principles. The solution x_{n+1} is evaluated using the real objective function $y_{n+1} = f(x_{n+1})$ and is added to the set of observations $D_{n+1} = D_n \cup (x_{n+1}, y_{n+1})$. The surrogate is updated $s(f/D_{n+1})$ using the new acquisition function $q_{s(f/D_{n+1})}$, and a new solution is sampled, and so on, until a given budget of evaluated solutions is finished (Fig.11). Notice that the evaluation of the acquisition function q is much cheaper than the original function f which makes that the optimization effort is reduced.

The various surrogate-based metaheuristics for AutoDNN can be characterized by:

- **Surrogate model:** there are at least two desired properties of such a surrogate: correlated with true objective and sample efficiency. The most popular surrogate model in AutoDNN is the Gaussian process [94][82][13][158][61]. A Gaussian process $G = (\mu, \sigma)$, is defined by a mean $\mu(\cdot)$ and a covariance function $\sigma^2(\cdot, \cdot)$. Gaussian processes are suited to continuous optimization problems and are characterized by poor scalability to high dimensions [160][159]. Then, other models have been investigated such as neural networks [157][160][159], radial basis functions [27][84], polynomial regression models [120], Tree Parzen Estimator (TPE)

⁸Also known as Bayesian Optimization

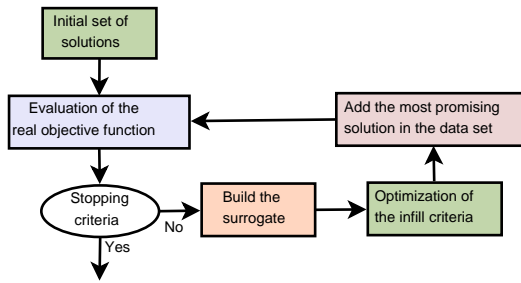

Fig. 11. The general framework of surrogate-based optimization algorithms.

[13], RNNs [27][46], graph neural networks [120] and random forest [82]. A recent trend consists to use multiple surrogates (i.e. ensembles of metamodels) to improve the accuracy of the surrogates [27].

- **Acquisition function:** the acquisition function determines the utility of different DNN candidates. They are based on a tradeoff between exploration by searching where predicted variance is high, and exploitation by searching where expected value is minimized. Different *infill criteria* have been used for updating the surrogate: lower confidence bound (LCB), upper confidence bound (UCB) [158][88], probability of improvement (PI), expected improvement (EI) [94][27][13][120], independent Thompson sampling [187], and predictive entropy search (PES) [72].

- **Target optimization problem:** several techniques exist in SBO of continuous functions. Hence, SBO has been widely used in solving the HPO problem. For instance, it has been applied to tune the number of layers and the size of hidden layers in DBNs [13] and deep neural networks [169], the size of the filter bank, and other hyperparameters (e.g. learning rate) in CNNs [86][193][14][125][158].

Although SBO has seen great success in the HPO problem, several issues arise when it comes to solve the NAS and AutoDNN problems because of the discrete variables. Only few methods have been developed for mixed continuous/discrete problems [136]. Indeed, using SBO for AutoDNN requires so far specifying a distance function between DNN architectures, in order to define a surrogate model (i.e. kernel function). The kernel function, which measures the similarity between network architectures, is fundamental for selecting the architectures to evaluate during the search process [27][94][187]. As modern DNNs can have multiple layers, multiple branches and multiple skip connections, comparing two DNNs is non-trivial. In [27], the authors propose to map a diverse range of discrete architectures to a continuous embedding space through the use of RNNs and then define the kernel function based on the learned embedding space. In [94], the authors develop a distance metric in the space of CNN architectures which is computed via an optimal transport algorithm.

- **Optimization algorithms:** there are two different optimization algorithms to be defined: (1) the algorithm which optimizes the surrogate. Many optimization algorithms have been investigated such as EAs [94][120], gradient [27], and beam search [104]; (2) the algorithm which optimizes the acquisition function. Many global optimization algorithms have been applied such as EDA [13], CMA-ES [13], random procedure [187], and simulated annealing [88].

6 MULTI-OBJECTIVE OPTIMIZATION

Most of the work on AutoDNN formulate the problem as a single-objective problem based on the accuracy. However, many applications do not only require high accuracy on unseen data but also other objectives (e.g. inference time, model size, energy consumption). A multi-objective optimization problems (MOP) can be defined as [126]: $\min_{a \in A} (f_1(a), f_2(a), \dots, f_k(a))$, where k ($k \geq 2$) is the number of objectives, and A denotes the set of feasible DNNs. Contrary to single-objective optimization, the solution of a MOP is not a single solution, but a set of solutions known as *Pareto optimal set*, which is called *Pareto front* when it is mapped in the objective space. Any solution of this set is optimal in the sense that no improvement can be made on one objective without worsening at least another objective. A solution a dominates a solution b iff:

$$\forall i \in [1..k] : f_i(a) \leq f_i(b) \quad \text{and} \quad \exists \in [1..k] : f_i(a) < f_i(b)$$

The Pareto optimal solutions are not dominated by any other solutions in the feasible space. A solution a is *Pareto optimal* iff: $\forall b \in A, \forall i \in [1..k], f_i(a) \leq f_i(b) \quad \text{and} \quad f(a) \neq f(b)$.

6.1 Multi-objective single-task learning

In classical single-task learning problems, DNNs give high accuracy at the cost of high-computational complexity (e.g. billions of FLOPs). Recently, AutoDNN approaches have been applied to applications requiring light-weight models and fast run-time. It can be infeasible to run real-time applications on resource constrained platforms such as IoT, smartphones, robots, drones, autonomous vehicles and embedded systems. Indeed, those platforms are often constrained by hardware resources in terms of power consumption, available memory, available FLOPs, and latency constraints. Optimizing those multiple objectives will enable efficient processing of DNNs to improve energy efficiency and throughput without sacrificing application accuracy or increasing hardware cost. This is a critical aspect to the wide deployment of DNNs in AI systems. Many device-related and device-agnostic objectives have been used investigated in the literature for the optimization and/or the inference steps:

- **Energy consumption:** in using DNN models in low-power mobile and embedded areas, there is a need to optimize the energy consumption (i.e. power) [134][82]. Power can be estimated via analytical models [23][145], simulation software [71] or measured on the target device (i.e. hardware-aware) [82]. It depends if the platform where the DNN is designed and the platform on which it is deployed are connected.
- **Inference speed:** the inference time is an important objective for real-time applications [96]. To measure this objective, it is necessary to deploy DNNs on the target hardware device [82][46].
- **Computational and memory cost:** this cost can be estimated by the number of floating-point operations (FLOPs) [117], and memory usage that a network performs during a forward phase [157][78][46]. This measure can concern both training and inference [180].
- **Hardware cost:** the cost of the hardware on which training and/or designing are carried out can also be taken into account [112].
- **Number of parameters:** minimizing the number of parameters of DNNs has been used in [113][174][87] as a second objective for an efficient deployment of DNNs on constrained hardware (e.g. mobile devices [49]).
- **Size of the network:** it is mainly evaluated by the number of connection in the network [59]. The connecting sparsity has been considered in designing DBNs [110] and RNNs [156]. In [67], an objective consists to minimize the number of non-zero weights. The resulting compressed

networks will have lower bandwidth requirements and require fewer multiplications due to most weights being zero.

- **Diversity:** ensemble models using diverse DNNs tends to achieve better generalization [21]. Diversity measures the discrepancy between the output of a DNN and the outputs of other DNNs. An example of such diversity which measures the total correlation between the output of one DNN and the output of each of the other DNNs is [29]:

$$\text{Min } D_m = \sum_{i=1, i \neq j}^N (o_m^i - O^i) \sum_{j=1}^M (o_j^i - O^i)$$

where M is the number of DNN models, N the number of samples, o_m^i, o_j^i represents the output of the m th and the j th DNN for the i th training sample, and O^i denotes the average output for all DNNs. In [29], the Pareto DBNs networks are combined to form an *ensemble model*, where combination weights are optimized via a single-objective DE for a given learning task.

The aim of solving MOPs is to help a DNN designer to find a Pareto DNN which copes with his preferences. One of the fundamental questions in MOPs resolution is related to the interaction between the problem solver (e.g. metaheuristic) and the designer. Indeed, the Pareto DNNs cannot be ranked globally. The role of the designer is to specify some extra information to select his favorite solution. This interaction can take one of the three following forms: *a priori* [78], *a posteriori* [29][156], and *interactive*. To our knowledge there is no work dealing with interactive design of DNNs, where there is a progressive interaction between the designer and the optimizer. Different optimization approaches have been designed for multi-objective autoDNN:

- **Scalarization approaches:** those approaches transform the MOP problem into a single-objective one or a set of such problems. Among these methods one can find the aggregation methods, weighted metrics, Tchebycheff method, goal programming methods, achievement functions, goal attainment methods and the ϵ -constraint methods [126]. In [78], a weighted sum function $\alpha f_1 + (1-\alpha)f_2$ which aggregates accuracy and energy consumption has been used to solve a bi-objective optimization problem. In [3], the authors provide a balance between the compression ratio and the accuracy using the function $f(x) = C(x)(2 - C(x)) \times \frac{A(x)}{A(ref)}$ where $C(x)$ is the compression ratio of the architecture x , $A(x)$ is the validation performance of x and $A(ref)$ is the validation performance of the reference network. The compression ratio $C(x)$ is defined as $C(x) = 1 - \frac{\#param(x)}{\#param(ref)}$.
- **Pareto approaches:** dominance-based approaches⁹ use the concept of dominance and Pareto optimality to guide the search process. Population-based metaheuristics are particularly suitable to solve MOPs, because they deal simultaneously with a set of solutions which allows to find several Pareto DNNs in a single run of the algorithm. The main differences between the various proposed approaches arise in the following search components: fitness assignment, diversity management, and elitism [173]. Pareto EAs (e.g. NSGA-II: Non-Sorting Genetic Algorithm) have mostly been used in the literature for designing CNNs [96][117][113], RNNs [156] and LSTMs [10]. Other Pareto optimization algorithms have also been considered such as PSO (e.g. diversity based on crowding and dominance based on ϵ -Pareto dominance [180]), and local search [157].
- **Decomposition-based approaches:** most of decomposition-based algorithms in solving MOPs operate in the objective space. One of the well-known frameworks for MOEAs using decomposition is MOEAO/D [194]. It uses scalarization to decompose the MOP into multiple

⁹Also named Pareto approaches.

1079 scalar optimization subproblems and solve them simultaneously by evolving a population
1080 of DNNs. Subproblems are solved using information from the neighbouring subproblems
1081 [121]. This approach has been developed using Tchebycheff scalarization in designing DBNs
1082 [110][29].
1083

1084 Most of the proposed MOP formulations are bi-objective. Very few many-objective models (i.e.
1085 more than 3 objectives) have been investigated. In [49], a 5-objective MOP has been formulated:
1086 accuracy on data set CIFAR-10, accuracy on data set CIFAR-100, number of parameters, number
1087 of add-multiply operations and inference time. Compared to accuracy, the proposed additional
1088 objectives (e.g. inference time, energy consumption) are generally cheap to evaluate. Hence, devel-
1089 oping new MOP approaches which take into account this high heterogeneity in the computational
1090 cost of the objectives is essential. An approach based on decoupled objective evaluations has
1091 been proposed to enable independent evaluations across objectives [71]. In [82][49], a sequential
1092 approach is developed in handling cheap and expensive objective functions. First, cheap objectives
1093 are used to sample new solutions. Then, in a second phase, expensive objective participate in the
1094 search process to generate Pareto DNNs for the whole MOP.

1095 In surrogate-based MOP, new acquisition functions have to be developed. To identify Pareto-
1096 optimal DNNs, an acquisition function based on the hypervolume indicator has been proposed
1097 in [82]. In [82], the authors consider surrogate-based MOP with heterogeneous cost objectives.
1098 The acquisition function selects the objective across which the configuration will be evaluated
1099 in addition to selecting the next DNN to evaluate. A trade-off is made between the additional
1100 information obtained through an evaluation with the cost of obtaining it.
1101

1102 6.2 Multi-objective multi-task learning

1103 Multi-task learning (MTL) allows to learn multiple different yet related tasks simultaneously. MTL
1104 has recently been explored in a variety of DNNs solving problems in computer vision [16] and
1105 NLP [41]. The number of parameters in a multi-task DNN would be less than in multiple DNNs
1106 optimized for their own single task. In addition, the trained DNNs for MTL should be able to
1107 synergize, enabling superior performance over learning each task independently using smaller
1108 datasets per task [93]. The MTL problem is inherently multi-objective, in which the various tasks
1109 may conflict. Hence, some trade-off models represented by Pareto solutions have to be found. In
1110 the literature MTL is mostly solved as a single objective optimization problem via hard or soft
1111 parameter sharing [146]. In hard parameter sharing, a subset of parameters is shared between tasks,
1112 while other parameters are task specific. In soft parameter sharing, all parameters are task specific,
1113 but they are jointly constrained via a Bayesian prior or a joint dictionary. In the design of a global
1114 model that shares some parameters across tasks, the parameters can be learned by solving a MOP
1115 that takes into account all uncertainties on the defined tasks.
1116

1117 Very few works in the literature investigate a multi-objective approach to solve the MTL problem.
1118 Various objectives (i.e. Loss functions for different tasks) can be handled in the formulation of
1119 the problem: $\text{Min}_{\Theta} (\mathbf{L}_1(a, \theta_c, \theta_s^1), \dots, \mathbf{L}_T(a, \theta_c, \theta_s^T))$, $t = 1, 2, \dots, T$, where \mathbf{L}_i is the loss function
1120 function of task i , T is the total number of tasks, θ_c are the shared parameters, and θ_s^t are the
1121 specific task parameters. Hence, Pareto solutions representing potential optimal architectures will
1122 be generated to solve the MTL problem. To our knowledge only scalarization approaches have been
1123 proposed. In [150][103], a weighted linear aggregation of the per-task losses has been applied and
1124 solved using gradient-based algorithms. In [62], many weighting approaches have been evaluated
1125 including uniform combination of losses, dynamic weight average (DWA) [111] and uncertainty
1126 weighting methods [95] with various sizes of datasets per-task.
1127

7 PARALLEL OPTIMIZATION

On one hand, AutoDNN problems are more and more complex (e.g. dataset and network size) and their resource requirements in terms of computation and memory are ever increasing. Although the use of metaheuristics allows to significantly reduce the computational complexity of the search process, the latter remains time-consuming. On the other hand, the rapid development of technology in hardware design (e.g. GPU, TPU) make the use of parallel computing more and more popular. State-of-the-art DNNs required 3,150 and 2,000 GPU days [143][203]. Parallel optimization can be used for the following reasons: speedup the search, improve the quality of DNNs, reduce the energy, improve the robustness, and solve large scale and/or complex learning tasks. In this paper we make a clear distinction between the parallel design aspect and the parallel implementation aspect.

7.1 Parallel design

In terms of designing parallel metaheuristics for AutoDNN, three major parallel hierarchical models are identified (Fig.12):

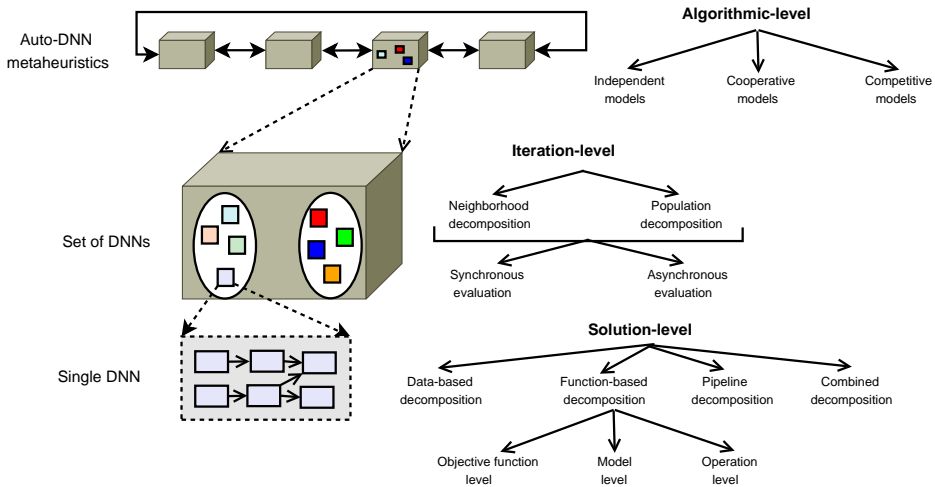

Fig. 12. Parallel models of metaheuristics for AutoDNN.

- Algorithm-level:** in this parallel model, independent, cooperating or competitive self-contained metaheuristics are used. If the different metaheuristics are independent, the search will be equivalent to the sequential execution of the metaheuristics. However, cooperative and competitive models can alter the behavior of the metaheuristics and enables the improvement of the quality of DNNs by providing better convergence and diversity. Very few algorithm-level parallel models have been investigated in the literature. A parallel independent approach has been investigated for transfer learning [55]. A set of parallel asynchronous agents learn how to reuse the architecture of an existing DNN for new learning tasks. An agent based on an EA is used to evolve a subpart (i.e. PathNets) of a giant DNN. PathNet may be thought of as a form of “evolutionary dropout” in which instead of randomly dropping out nodes and their connections, “thinned” DNNs are evolved in parallel for various learning tasks.

1177 Some parallel cooperative models has been developed for neural network design [44][127].
 1178 The algorithm is based on the popular “Island Parallel EA” in which a set of parallel EAs are co-
 1179 operating to solve the problem [172]. In [127], two populations of DNN cells and topologies are
 1180 evolved in parallel. During evaluation, the cells are combined into topologies to create a larger
 1181 assembled DNNs. An example of algorithm-level competitive parallel model can be found in
 1182 designing generative neural networks (GANs). GANs are composed of two adversarial DNNs:
 1183 a generator and a discriminator [64]. The two networks are confronted in a zero-sum game.
 1184 The generator creates fake noisy input data to deceive the discriminator, while the discrimi-
 1185 nator learns to distinguish between real and fake samples. In contrast to conventional GANs,
 1186 which alternate the update of the generator and a discriminator, some algorithm-level parallel
 1187 EA models have been proposed [37][182]. In [37], a co-evolutionary approach has been used,
 1188 in which the discriminator and generator population of networks are trained simultaneously
 1189 as adversaries. Two populations of generators and discriminators evolve in parallel following
 1190 its own optimization process. The discriminator D (resp. generator G) networks optimize the
 1191 following loss function: $L_D(D, G) = -\mathbb{E}_x \text{data}[\log D(x)] - \mathbb{E}_z \text{noisy}[\log(1 - D(G(z)))]$ (resp.)
 1192 $-\mathbb{E}_z \text{noisy}[\log(D(G(z)))]$ where *data* represents the input dataset, z (resp. *noisy*) represents
 1193 the noisy data (resp. noise distribution).

- 1194 • **Iteration-level:** in this model, an iteration of a metaheuristic is parallelized. The behavior
 1195 of the metaheuristic is not altered. The main goal is to speedup the algorithm by reducing
 1196 the search time. Indeed, the iteration cycle of metaheuristics requires a large amount of
 1197 computational resources for training. The most popular iteration-level parallel model consists
 1198 in evaluating in parallel the generated DNNs. In the synchronous mode, a master manages the
 1199 search process. At each iteration, the master distributes the set of new generated DNNs among
 1200 the workers and waits for the results to be returned back (e.g. EAs [143][122][192], $(1 + \lambda)$ ES
 1201 [123], PSO [115][180], multi-armed bandits [53]). While the results are collected, the search
 1202 process is iterated. In the asynchronous mode, the evaluation phase is not synchronized with
 1203 the other parts of the search process in EAs [108] and ACO [48]. The master does not wait
 1204 for the return back of all DNNs evaluations to start the next iteration. The steady-state EA is
 1205 a good example illustrating the asynchronous model [108].
- 1206 • **Solution-level:** in this model, the parallelization process handles the training of a single
 1207 DNN which is the most costly operation [11]. Training broadly comprises of iterations over
 1208 two dataflows steps: the forward step for training the sample data, and the backward step
 1209 for updating weights (e.g. computing gradients). Four solution-level parallel models may be
 1210 carried out for training:
 - 1211 – **Data-based decomposition:** the same DNN model is duplicated among different workers
 1212 with different portions of the training data [42]. The computations are carried out in parallel
 1213 on different data partitions. In [138], each worker stores an identical copy of the model
 1214 and computes gradients only on a partition of the training examples, and these gradients
 1215 are aggregated to update the model.
 - 1216 – **Function-based decomposition:** the DNN model is partitioned into different sub-functions.
 1217 Each sub-function is evaluated in parallel using the same training data. Then, a reduction
 1218 is performed on the results returned back by the computed sub-functions. By definition,
 1219 this model is synchronous, so one has to wait the termination of all workers calculating
 1220 the operations. Three different levels of function decomposition can be applied: (1)
 1221 Objective level in which different objective functions are evaluated in parallel such as in
 1222 multi-objective AutoDNN (2) Model level in which different sub-models (e.g. operations)
 1223 are handled in parallel. For example, in [98], different workers train different parts of the
 1224 model. A convolution with k filters can be splitted in n operations, each of which convolves
 1225

its input with $\frac{k}{n}$ filters. (3) Operation level in which a given operation (e.g. convolution) is handled in parallel. For instance, a FC layer can be modeled as matrix-matrix multiplication and is well suited to be performed in parallel [11].

- **Pipeline decomposition:** it consists in designing a pipeline of the layers composing a DNN, where one or more consecutive layers of a DNN form a chunk. The layers in a chunk are executed on one worker, and thus, different workers compute the DNN in a pipelined manner [80][69]. This parallel computing model is efficient for large DNNs and/or large datasets.
- **Combined decomposition:** the previous strategies can be combined. For instance, the function, data parallel and pipeline models can be used jointly. A combined parallelisation mixing functional and data parallelism has been proposed in [98][190]. In [98] the authors use data parallelism in the convolutional layers (i.e. compute intensive) and function parallelism in the FC layers (i.e. memory-intensive). Very few papers combine pipelining, function parallelism, and data parallelism [69].

7.2 Parallel implementation

Parallel implementation of AutoDNN metaheuristics deals with the efficient mapping of a parallel model of metaheuristics on a given parallel architecture. Computational throughput, power consumption and memory efficiency are three important indicators in parallel architectures. Parallel architectures are evolving quickly and are dominated by two types of architectures: *shared memory architectures* (e.g. multi-core CPU, accelerators such as GPU) and *distributed memory architectures* (e.g. clusters of CPUs). **Shared-memory architectures:** accelerators and multi-core CPUs represent the most popular shared-memory architectures. Accelerators are often connected with a server through PCIe bus. They can be classified as *temporal* or *spatial architectures*. Popular temporal architectures are multi-cores and GPUs. They use SIMT (Single Instruction Multiple Threads) and SIMD (Single Instruction Multiple Data) as parallel computing models. They use a centralized control for a large number of ALUs, which can only fetch data from the memory hierarchy. Due to their high throughput support and an architecture designed specifically for data parallel workflows, GPUs are well adapted for DNN computational requirements. Using CUDA API, these frameworks boost their scale-up efficiency using threads to utilize multiple GPUs in a single node (single address space). However, conventional CPUs and GPUs are energy-inefficient due to their effort for flexibility, and then they are not preferred for power constrained applications [54]. Spatial architectures use dataflow processing, where a processing sequence is composed of ALUs transfer data from one to another. FPGA and ASICS (Application-Specific integrated Circuits) are the most widely used spatial architectures. FPGA allows to implement irregular parallelism, customized data type and application-specific hardware, offering great flexibility to accommodate new DNN models. However, their drawbacks are the on-chip memory limitation, and the lack of efficient high-level APIs. A major improvement in cost-energy performance comes from domain-specific hardware such as TPUs (Tensor Processing Units). They are AI-dedicated ASIC which targets a high volume of low-precision (e.g. 8-bit) arithmetic while maintaining low power consumption. However, they have less flexibility and longer development cycle than FPGAs [181].

Distributed-memory architectures: Clusters of CPU nodes represent the most popular distributed-memory architecture. The computer nodes are connected by high speed networks such as modern Ethernet and InfiniBand. The most important metrics for the interconnection network are latency and bandwidth. MPI (Message Passing Interface) is the omnipresent programming model for distributed memory architectures. The performance of single-node multi-GPU is nearing saturation for large datasets and DNN models. Thus, scale-out efficiency with large clusters of heterogeneous

1275 nodes (e.g. CPU-GPU) is an emerging topic. Most of the top high-performance computing (HPC) sys-
1276 tems¹⁰ are composed of clusters of heterogeneous nodes (CPU and GPU) mixing shared-memory and
1277 distributd-memory models. Hence, traditional HPC applications have been successfully redesigned
1278 to scale-out using a hybrid programming model mixing MPI and CUDA.

1279
1280 Parallel implementation of AutoDNN metaheuristics on parallel hardware has to be consider
1281 maximizing accuracy and throughput, while minimizing energy and cost. The throughput of a
1282 parallel metaheuristic on a given parallel architecture depends mainly on its granularity. It computes
1283 the ratio between the computation cost and the communication cost. The three parallel models
1284 have a decreasing granularity from large-grained to fine-grained:

- 1285 • **Algorithm-level:** this model has the largest granularity. There is a relatively low communi-
1286 cation requirements. It is the most suited parallel model to conventional parallel architectures
1287 such as HPC systems and clusters of multi-cores. In terms of scalability, its degree of concu-
1288 rency is limited by the number of metaheuristics involved in solving the problem. In [55], an
1289 implementation on a cluster of CPUs using 64 asynchronous independent algorithms has been
1290 carried out.
- 1291 • **Iteration-level:** a medium granularity is associated to the iteration-level parallel model. As
1292 the objective function is very expensive, this model has been widely implemented on multi-
1293 GPUs and clusters of multi-cores. It has been deployed efficiently for EAs [180][122][192],
1294 PSO [115] on GPUs powered clusters using MPI-CUDA, and ACO on clusters of multi-core
1295 CPUs using MPI [48]. The degree of concurrency of this model is limited by the size of the
1296 neighborhood for S-metaheuristics or the size of the population for P-metaheuristics. The
1297 use of very large neighborhoods and large populations will increase the scalability of this
1298 parallel model. Introducing asynchronous communications in the model will increase the
1299 efficiency of parallel metaheuristics [122].
- 1300 • **Solution-level:** this model has the finer granularity and then is well adapted for accelerators
1301 such as GPUs, FPGAs and TPUs [187]. The degree of concurrency of this parallel model is
1302 limited by the number of objective functions, data partitions and layers of DNNs. Most of the
1303 existing parallel implementations have been carried out on single GPUs. Few parallel models
1304 have been implemented on specific hardware such as FPGAs [128] (e.g. CNNs [181][68],
1305 LSTMs [196]), and Arm processors [112]. The size of DNNs pose some problems according
1306 to the GPU memory. The system would crash because of running out of GPU memory.
1307 Many approaches have been proposed to find memory-efficient DNNs [174]. Some parallel
1308 implementation have been developed on a single server with multiple GPUs having disjoint
1309 memory spaces [190][132]. The single server implementation scales only to 8 GPUs before
1310 the host server becomes overburdened by I/O, power, cooling, and CPU compute demands.
1311 Multiple servers where each server represents a cluster of multi-core and/or multiple GPU
1312 represent a more scalable implementation [35]. As communication is the major bottleneck in
1313 large clusters of GPUs, many techniques have been proposed to overlap communication and
1314 computation [47][83][151]. Many solution-based parallel models have been investigated:
 - 1315 – **Data-based decomposition:** each node (e.g. GPU) trains on its own data partition while
1316 synchronizing weights with other nodes, using either collective communication primitives
1317 [65] or sharing memory with servers [39]. Data-based decomposition requires synchronous
1318 communication between nodes, since each node must communicate both gradients and
1319 parameter values on every update step [35]. Moreover, the mini-batch size gets multiplied
1320 by the number of used nodes.

1321
1322 ¹⁰Top500.
1323

- 1324 – **Function-based decomposition:** it has been implemented on large clusters of CPUs [42],
1325 and HPC clusters of heterogeneous nodes (i.e. multi-core CPU/GPU) using CUDA and
1326 MPI [131]. The operation level is always handled by single node accelerators. For instance,
1327 convolution in CNN and gate systems in RNNs (i.e. matrix-matrix multiplication) are
1328 generally implemented on fine grained architectures such as vector accelerators of CPUs
1329 or many-core architectures (e.g. GPU) [11]. The model level is generally implemented on
1330 clusters of GPUs and/or CPUs [35][11]. The objective level is generally implemented on
1331 heterogeneous architectures. For multi-objective AutoDNN, one can decouple the evaluation
1332 of heterogeneous objectives on different hardware platforms. For instance, one can evaluate
1333 the accuracy on non-dedicated hardware and energy consumption on specific hardware
1334 [71].
- 1335 – **Pipeline decomposition:** limited network bandwidth hardware induce high communication-
1336 to-computation ratios. By pipelining different micro-batches on sub-functions of layers
1337 allows to benefit memory utilization and thus make fitting giant models feasible. GPipe
1338 provides the flexibility of scaling a variety of different networks to gigantic sizes efficiently,
1339 and has been implemented on a single server with TPUv3s and NVIDIA P100 GPU [80].
1340 Pipelining can also be applied between training different DNNs where the optimizer gener-
1341 ates the next DNN to be trained and starts the training on GPU. Then, instead of waiting
1342 for the training to finish, it starts to generate the next DNN [88]. The idle time of nodes
1343 (e.g. GPU, CPU) are then reduced.

1344 DNN libraries (e.g. cuDNN, Cuda-convnet) and frameworks (e.g. Tensorflow, Caffe, Torch,
1345 Thenao) have been developed to facilitate parallel implementation. Most DNN frameworks are
1346 limited to a single node (e.g. GPU) and have not been designed to be efficient of large clusters
1347 of heterogeneous nodes using MPI and CUDA [6]. TensorFlow maps the nodes of a dataflow
1348 graph across many machines in a cluster, and within a machine across multiple computational
1349 devices, including multicore CPUs, general purpose GPUs, and custom-designed ASICs such
1350 as Tensor Processing Units (TPUs) and ARM-based platforms [1].

1352 8 CONCLUSIONS AND PERSPECTIVES

1353 In this paper, a survey and taxonomy for DNN optimization has been presented. A unified way to
1354 describe the optimization algorithms allowed to focus on common and important search components
1355 for all AutoDNN approaches. We have also extended this unifying view to important optimization
1356 methodologies dealing with surrogate-based, multi-objective and parallel optimization. Most of the
1357 proposed AutoDNN approaches have been applied to image classification. The proposed survey
1358 and taxonomy can help to extend the proposed taxonomy to other less explored applications in
1359 computer vision (e.g. image restoration, semantic segmentation), NLP (e.g. language translation) and
1360 Industry 4.0 (e.g. predictive maintenance). It can also be reused for other types of deep learning
1361 architectures such as spiking neural networks (SNNs).

1363 An important issue is the definition of efficient and effective encodings, objective function(s) and
1364 constraints. From a landscape analysis using measures such as FDC (i.e. fitness-distance correlation)
1365 [90], and autocorrelation (i.e. autocorrelation of the accuracies of visited DNNs in a random walk)
1366 [161], we can extract some knowledge for designing and understanding the behavior of optimization
1367 algorithms. Designing multi-fidelity surrogates for variable space mixed optimization problems
1368 represent an important research issue. The AutoDNN problem is intrinsically multi-objective. To
1369 our knowledge there is no work dealing with interactive multi-objective design of DNNs, in which
1370 there is a progressive interaction between the designer and the optimizer. Indeed, one can use his
1371 knowledge in helping the optimizer to converge towards interesting design subspaces.

1373 HPC is evolving toward Exascale supercomputers composed of millions of cores provided in
1374 heterogeneous devices mainly multi-core processors with various architectures. To our knowledge
1375 there is no work using in conjunction the three hierarchical parallel models introduced in this
1376 paper. The massively parallel implementation of the three hierarchical parallel models on Exascale
1377 supercomputers is an interesting challenge. Highly energy-efficient hardware accelerators are
1378 required for a broad spectrum of challenging applications. Future works also need to assess the
1379 performance benefits according to the energy overheads. The coupling of software frameworks
1380 dealing with optimization and deep learning is an important issue for the future. This enables
1381 to reduce the complexity of developing optimization approaches for new AutoDNN problems
1382 and makes them more and more popular. Finally, some efforts must be done in the definition of
1383 performance evaluation methodologies for the comparison of different AutoDNN methodologies.
1384 Particularly, we notice the lack of information needed to exactly reproduce the published results.
1385
1386

1387 REFERENCES

- 1388 [1] M. Abadi, P. Barham, J. Chen, Z. Chen, A. Davis, J. Dean, M. Devin, S. Ghemawat, G. Irving, and M. Isard. Tensorflow:
1389 A system for large-scale machine learning. In *12th {USENIX} Symposium*, pages 265–283, 2016.
- 1390 [2] K. Ahmed and L. Torresani. Maskconnect: Connectivity learning by gradient descent. In *Proceedings of the European
1391 Conference on Computer Vision (ECCV)*, pages 349–365, 2018.
- 1392 [3] A. Ashok, N. Rhinehart, F. Beainy, and K. M. Kitani. N2N learning: Network to network compression via policy
1393 gradient reinforcement learning. In *6th International Conference on Learning Representations, ICLR'2018, Canada*, 2018.
- 1394 [4] F. Assunção, N. Lourenço, P. Machado, and B. Ribeiro. Evolving the topology of large scale deep neural networks. In
1395 *21st European Conference on Genetic Programming EuroGP'2018, Italy*, volume 10781, pages 19–34, 2018.
- 1396 [5] F. Assunção, N. Lourenço, P. Machado, and B. Ribeiro. Denser: deep evolutionary network structured representation.
1397 *Genetic Programming and Evolvable Machines*, 20(1):5–35, 2019.
- 1398 [6] A. Awan, K. Hamidouche, J. Hashmi, and D. Panda. S-caffe: Co-designing MPI runtimes and caffe for scalable deep
1399 learning on modern GPU clusters. In *ACM SIGPLAN Symp. on Principles and Practice of Parallel Programming*, pages
1400 193–205, 2017.
- 1401 [7] B. Baker, O. Gupta, N. Naik, and R. Raskar. Designing neural network architectures using reinforcement learning. In
1402 *5th International Conference on Learning Representations ICLR'2017, France*. OpenReview.net, 2017.
- 1403 [8] B. Baker, O. Gupta, R. Raskar, and N. Naik. Accelerating neural architecture search using performance prediction. In
1404 *6th International Conference on Learning Representations ICLR'2018, Canada*, 2018.
- 1405 [9] T. Bartz-Beielstein, B. Filipic, P. Korosec, and E-G. Talbi, editors. *High-performance simulation-based optimization*,
1406 volume 833 of *Studies in Computational Intelligence*. Springer, 2020.
- 1407 [10] J. Bayer, D. Wierstra, J. Togelius, and J. Schmidhuber. Evolving memory cell structures for sequence learning. In
1408 *19th International Conference Artificial Neural Networks ICANN'2009, Cyprus*, volume 5769, pages 755–764, 2009.
- 1409 [11] T. Ben-Nun and T. Hoeffler. Demystifying parallel and distributed deep learning: An in-depth concurrency analysis.
1410 *ACM Comput. Surv.*, 52(4):65:1–65:43, 2019.
- 1411 [12] G. Bender, P-J Kindermans, W. Zoph, V. Vasudevan, and Q. V. Le. Understanding and simplifying one-shot architecture
1412 search. In *35th International Conference on Machine Learning ICML'2018, Sweden*, pages 549–558, 2018.
- 1413 [13] J. Bergstra, R. Bardenet, Y. Bengio, and B. Kégl. Algorithms for hyper-parameter optimization. In *25th Annual
1414 Conference on Neural Information Processing Systems 2011. Spain*, pages 2546–2554, 2011.
- 1415 [14] J. Bergstra, D. Yamins, and D. D. Cox. Making a science of model search: Hyperparameter optimization in hundreds
1416 of dimensions for vision architectures. 2013.
- 1417 [15] James Bergstra and Yoshua Bengio. Random search for hyper-parameter optimization. *Journal of machine learning
1418 research*, 13(Feb):281–305, 2012.
- 1419 [16] H. Bilen and A. Vedaldi. Universal representations: The missing link between faces, text, planktons, and cat breeds.
1420 *CoRR*, abs/1701.07275, 2017.
- 1421 [17] B. Bischl, O. Mersmann, H. Trautmann, and C. Weihs. Resampling methods for meta-model validation with recom-
mendations for evolutionary computation. *Evolutionary Computation*, 20(2):249–275, 2012.
- [18] D. Blalock, J. G. Ortiz, J. Frankle, and J. Guttag. What is the state of neural network pruning? *arXiv preprint
arXiv:2003.03033*, 2020.
- [19] C. Blundell, J. Cornebise, K. Kavukcuoglu, and D. Wierstra. Weight uncertainty in neural network. In *Proceedings of
the 32nd International Conference on Machine Learning ICML'2015, France*, volume 37, pages 1613–1622, 2015.

- 1422 [20] A. Brock, T. Lim, J. M. Ritchie, and N. Weston. Smash: one-shot model architecture search through hypernetworks.
 1423 In *6th International Conference on Learning Representations, ICLR'2018, Canada, 2018*.
- 1424 [21] G. Brown, J. Wyatt, R. Harris, and X. Yao. Diversity creation methods: a survey and categorisation. *Information*
 1425 *Fusion*, 6(1):5–20, 2005.
- 1426 [22] E. Byla and W. Pang. Deepswarm: optimising convolutional neural networks using swarm intelligence. In *Advances*
 1427 *in Computational Intelligence Systems, UK*, pages 119–130, 2019.
- 1428 [23] E. Cai, D-C. Juan, D. Stamoulis, and D. Marculescu. Neuralpower: Predict and deploy energy-efficient convolutional
 1429 neural networks. *arXiv preprint arXiv:1710.05420*, 2017.
- 1430 [24] H. Cai, T. Chen, W. Zhang, Y. Yu, and J. Wang. Efficient architecture search by network transformation. In *Proceedings*
 1431 *of the Thirty-Second AAAI Conference on Artificial Intelligence (AAAI-18), USA*, pages 2787–2794, 2018.
- 1432 [25] H. Cai, J. Yang, W. Zhang, S. Han, and Y. Yu. Path-level network transformation for efficient architecture search. In
 1433 *Int. Conf. on Machine Learning ICML'2018, Sweden*, pages 677–686, 2018.
- 1434 [26] A. Camero, H. Wang, E. Alba, and T. Bäck. Bayesian neural architecture search using a training-free performance
 1435 metric. *arXiv preprint arXiv:2001.10726*, 2020.
- 1436 [27] S. Cao, X. Wang, and K. M. Kitani. Learnable embedding space for efficient neural architecture compression. In *7th*
 1437 *International Conference on Learning Representations ICLR'2019, USA*, 2019.
- 1438 [28] F. P. Paolo Casale, J. Gordon, and N. Fusi. Probabilistic neural architecture search. *CoRR*, abs/1902.05116, 2019.
- 1439 [29] A. Chandra and Xin Yao. Ensemble learning using multi-objective evolutionary algorithms. *J. Math. Model. Algorithms*,
 1440 5(4):417–445, 2006.
- 1441 [30] C. Chen, F. Tung, N. Vedula, and G. Mori. Constraint-aware deep neural network compression. In *Proceedings of the*
 1442 *European Conference on Computer Vision (ECCV)*, pages 400–415, 2018.
- 1443 [31] L-C. Chen, M. Collins, Y. Zhu, G. Papandreou, B. Zoph, F. Schroff, H. Adam, and J. Shlens. Searching for efficient
 1444 multi-scale architectures for dense image prediction. In *NIPS'2018*, pages 8699–8710, 2018.
- 1445 [32] T. Chen, I. J. Goodfellow, and J. Shlens. Net2net: accelerating learning via knowledge transfer. In *4th International*
 1446 *Conference on Learning Representations, ICLR'2016, USA*, 2016.
- 1447 [33] Y. Chen, K. Zhu, L. Zhu, X. He, P. Ghamisi, and J. A. Benediktsson. Automatic design of convolutional neural network
 1448 for hyperspectral image classification. *IEEE Trans. Geoscience and Remote Sensing*, 57(9):7048–7066, 2019.
- 1449 [34] P. Chrabaszcz, I. Loshchilov, and F. Hutter. A downsampled variant of imagenet as an alternative to the cifar datasets.
 1450 *arXiv preprint arXiv:1707.08819*, 2017.
- 1451 [35] A. Coates, B. Huval, T. Wang, D. J. Wu, B. Catanzaro, and A. Y. Ng. Deep learning with COTS HPC systems. In
 1452 *Proceedings of the 30th International Conference on Machine Learning ICML'2013, USA*, pages 1337–1345, 2013.
- 1453 [36] M. D. Collins and M. Kohli. Memory bounded deep convolutional networks. *CoRR*, abs/1412.1442, 2014.
- 1454 [37] V. Costa, N. Lourenço, and P. Machado. Coevolution of generative adversarial networks. In *Evoapplications Int. Conf.*
 1455 *on Applications of Evolutionary Computation, Germany*, volume 11454, pages 473–487.
- 1456 [38] M. Courbariaux, Y. Bengio, and J-P. David. Binaryconnect: Training deep neural networks with binary weights during
 1457 propagations. In *Advances in Neural Information Processing Systems, Canada*, pages 3123–3131, 2015.
- 1458 [39] H. Cui, H. Zhang, G. R. Ganger, P. B. Gibbons, and E. P. Xing. Geeps: scalable deep learning on distributed gpus with
 1459 a gpu-specialized parameter server. In *European Conf. on Computer Systems EuroSys'2016, UK*, pages 1–16, 2016.
- 1460 [40] A. Darwish, A. E. Hassaniien, and S. Das. A survey of swarm and evolutionary computing approaches for deep
 1461 learning. *Artificial Intelligence Review*, 53(3):1767–1812, 2020.
- 1462 [41] A. Das, M. Hasegawa-Johnson, and K. Veselý. Deep auto-encoder based multi-task learning using probabilistic
 1463 transcriptions. In *18th Conf. of the International Speech Communication Association, Sweden*, pages 2073–2077, 2017.
- 1464 [42] J. Dean et al. Large scale distributed deep networks. In *Advances in neural information processing systems*, pages
 1465 1223–1231, 2012.
- 1466 [43] T. Desell, S. Clachar, J. Higgins, and B. Wild. Evolving deep recurrent neural networks using ant colony optimization.
 1467 In *15th European Conf. Evolutionary Computation in Combinatorial Optimization EvoCOP'2015, Denmark*, pages 86–98,
 1468 2015.
- 1469 [44] T. Dokeroglu and E. Sevinc. Evolutionary parallel extreme learning machines for the data classification problem.
 1470 *Computers & Industrial Engineering*, 130:237–249, 2019.
- [45] T. Domhan, J. T. Springenberg, and F. Hutter. Speeding up automatic hyperparameter optimization of deep neural
 networks by extrapolation of learning curves. In *Int. Joint Conf. on Artificial Intelligence*, 2015.
- [46] J-D Dong, A-C Cheng, D-H. Juan, W. Wei, and M. Sun. Dpp-net: device-aware progressive search for pareto-optimal
 neural architectures. In *15th European Conf. on Computer Vision ECCV'2018, Germany*, pages 540–555, 2018.
- [47] N. Dryden, N. Maruyama, T. Moon, T. Benson, A. Yoo, M. Snir, and B. Van Essen. Aluminum: An asynchronous,
 GPU-aware communication library optimized for large-scale training of deep neural networks on HPC systems.
 Technical report, Lawrence Livermore National Lab.(LLNL), Livermore, CA (United States), 2018.

- 1471 [48] A. ElSaid, F. El Jamiy, J. Higgins, B. Wild, and T. Desell. Optimizing long short-term memory recurrent neural
1472 networks using ant colony optimization to predict turbine engine vibration. *Applied Soft Computing*, 73:969–991,
1473 2018.
- 1474 [49] T. Elsken, J. Hendrik, and F. Hutter. Efficient multi-objective neural architecture search via lamarckian evolution.
1475 *arXiv preprint arXiv:1804.09081*, 2018.
- 1476 [50] T. Elsken, J.-H. Metzen, and F. Hutter. Simple and efficient architecture search for convolutional neural networks. In
1477 *6th International Conference on Learning Representations ICLR'2018, Canada*, 2018.
- 1478 [51] T. Elsken, J. H. Metzen, and F. Hutter. Neural architecture search: A survey. *J. Mach. Learn. Res.*, 20:55:1–55:21, 2019.
- 1479 [52] R. S. Engelmore and A. Morgan. *Blackboard systems*. Addison-Wesley, 1988.
- 1480 [53] S. Falkner, A. Klein, and F. Hutter. Bohb: Robust and efficient hyperparameter optimization at scale. In *Proceedings of*
1481 *the 35th International Conference on Machine Learning ICML'2018, Sweden*, pages 1436–1445, 2018.
- 1482 [54] Xin Feng, Youni Jiang, Xuejiao Yang, Ming Du, and Xin Li. Computer vision algorithms and hardware implementations:
1483 A survey. *Integration VLSI journal*, 69:309–320, 2019.
- 1484 [55] C. Fernando, D. Banarse, C. Blundell, Y. Zwols, D. Ha, A. Rusu, A. Pritzel, and D. Wierstra. Pathnet: Evolution channels
1485 gradient descent in super neural networks. *arXiv preprint arXiv:1701.08734*, 2017.
- 1486 [56] M. Feurer and F. Hutter. Hyperparameter optimization. In *Automated Machine Learning*, pages 3–33. Springer, 2019.
- 1487 [57] Ben Fielding and Li Zhang. Evolving image classification architectures with enhanced particle swarm optimisation.
1488 *IEEE Access*, 6:68560–68575, 2018.
- 1489 [58] S. Fong, S. Deb, and X.-S. Yang. How meta-heuristic algorithms contribute to deep learning in the hype of big data
1490 analytics. In *Progress in Intelligent Computing Techniques*, pages 3–25. Springer, 2018.
- 1491 [59] A. Gaier and D. Ha. Weight agnostic neural networks. In *Advances in Neural Information Processing Systems*
1492 *NeurIPS'2019*, pages 5365–5379, 2019.
- 1493 [60] X. Glorot and Y. Bengio. Understanding the difficulty of training deep feedforward neural networks. In *Proceedings of*
1494 *the thirteenth international conference on artificial intelligence and statistics*, pages 249–256, 2010.
- 1495 [61] D. Golovin, B. Solnik, S. Moitra, G. Kochanski, J. Karro, and D. Sculley. Google vizier: a service for black-box
1496 optimization. In *ACM SIGKDD Int. Conf. on Knowledge Discovery and Data Mining*, pages 1487–1495, 2017.
- 1497 [62] T. Gong, T. Lee, C. Stephenson, V. Renduchintala, S. Padhy, A. Ndirango, G. Keskin, and O. Elibol. A comparison of
1498 loss weighting strategies for multi task learning in deep neural networks. *IEEE Access*, 7:141627–141632, 2019.
- 1499 [63] I. Goodfellow, Y. Bengio, and A. Courville. *Deep learning*. MIT press, 2016.
- 1500 [64] I. J. Goodfellow, J. Pouget-Abadie, M. Mirza, B. Xu, D. Warde-Farley, S. Ozair, A. C. Courville, and Y. Bengio. Generative
1501 adversarial nets. In *Advances in Neural Information Processing Systems NIPS, Canada*, pages 2672–2680, 2014.
- 1502 [65] P. Goyal and other. Accurate, large minibatch sgd: Training imagenet in 1 hour. *arXiv preprint arXiv:1706.02677*, 2017.
- 1503 [66] F. Gruau. Genetic synthesis of modular neural networks. In *Proceedings of the 5th International Conference on Genetic*
1504 *Algorithms, Urbana-Champaign, IL, USA*, pages 318–325, 1993.
- 1505 [67] S. Han, J. Pool, J. Tran, and W. J. Dally. Learning both weights and connections for efficient neural network. In
1506 *Advances in Neural Information Processing Systems, Canada*, pages 1135–1143, 2015.
- 1507 [68] X. Han, D. Zhou, S. Wang, and S. Kimura. Cnn-merp: An FPGA-based memory-efficient reconfigurable processor
1508 for forward and backward propagation of convolutional neural networks. In *34th Int. Conf. on Computer Design*
1509 *(ICCD'2016)*, pages 320–327, 2016.
- 1510 [69] A. Harlap, D. Narayanan, A. Phanishayee, V. Seshadri, N. Devanur, G. Ganger, and P. Gibbons. Pipedream: Fast and
1511 efficient pipeline parallel dnn training. *arXiv preprint arXiv:1806.03377*, 2018.
- 1512 [70] K. He, X. Zhang, S. Ren, and J. Sun. Deep residual learning for image recognition. In *Proceedings of the IEEE conference*
1513 *on computer vision and pattern recognition*, pages 770–778, 2016.
- 1514 [71] J. M. Hernández-Lobato, M. A. Gelbart, B. Reagen, R. Adolf, D. Hernández-Lobato, P. N. Whatmough, D. Brooks, G.-Y.
1515 Wei, and R. P. Adams. Designing neural network hardware accelerators with decoupled objective evaluations. In
1516 *NIPS workshop on Bayesian Optimization*, 2016.
- 1517 [72] J. M. Hernández-Lobato, M. W. Hoffman, and Z. Ghahramani. Predictive entropy search for efficient global optimization
1518 of black-box functions. In *Advances in neural information processing systems*, pages 918–926, 2014.
- [73] G. Hinton, S. Osindero, and Y-W Teh. A fast learning algorithm for deep belief nets. *Neural computation*, 18(7):1527–
1554, 2006.
- [74] G. E. Hinton. A practical guide to training restricted boltzmann machines. In G. Montavon, G. B. Orr, and K-R Müller,
editors, *Neural networks: Tricks of the trade*, volume 7700, pages 599–619. 2012.
- [75] G. E. Hinton, S. Osindero, and Y. W. Teh. A fast learning algorithm for deep belief nets. *Neural Computation*,
18(7):1527–1554, 2006.
- [76] T. Hinz, N. Navarro-Guerrero, S. Magg, and S. Wermter. Speeding up the hyperparameter optimization of deep
convolutional neural networks. *Int. Journal of Computational Intelligence and Applications*, 17(02), 2018.
- [77] S. Hochreiter and J. Schmidhuber. Long short-term memory. *Neural Computation*, 9(8):1735–1780, 1997.

- [78] C. H. Hsu, S. H. Chang, J. H. Liang, H. P. Chou, C. H. Liu, S. C. Chang, J. Y. Pan, Y. T. Chen, W. Wei, and D. C. Juan. Monas: Multi-objective neural architecture search using reinforcement learning. *arXiv:1806.10332*, 2018.
- [79] G. Huang, Z. Liu, L. Van Der Maaten, and K. Q. Weinberger. Densely connected convolutional networks. In *IEEE Conf. on Computer Vision and Pattern Recognition*, pages 4700–4708, 2017.
- [80] Y. Huang, Y. Cheng, A. Bapna, O. Firat, D. Chen, M. Chen, H. Lee, J. Ngiam, Q. V. Le, and Y. Wu. Gpipe: Efficient training of giant neural networks using pipeline parallelism. In *Advances in Neural Information Processing Systems*, pages 103–112, 2019.
- [81] F. Hutter, L. Kotthoff, and J. Vanschoren. *Automated Machine Learning*. Springer, 2019.
- [82] Md I. M. Shahriar, J. Su, L. Kotthoff, and P. Jamshidi. Flexibo: Cost-aware multi-objective optimization of deep neural networks. *arXiv*, 2020.
- [83] F. Iandola, M. Moskewicz, K. Ashraf, and K. Keutzer. Firecaffe: near-linear acceleration of deep neural network training on compute clusters. In *IEEE Conf. on Computer Vision and Pattern Recognition*, pages 2592–2600, 2016.
- [84] I. Ilievski, T. Akhtar, J. Feng, and C. A. Shoemaker. Efficient hyperparameter optimization for deep learning algorithms using deterministic RBF surrogates. In *AAAI Conf. on Artificial Intelligence*, 2017.
- [85] Y. Jaafra, J.-L. Laurent, A. Deruyver, and M. S. Naceur. Reinforcement learning for neural architecture search: A review. *Image and Vision Computing*, 89:57–66, 2019.
- [86] R. Jenatton, C. Archambeau, J. González, and M. W. Seeger. Bayesian optimization with tree-structured dependencies. In *Proceedings of the 34th International Conference on Machine Learning ICML'2017, Australia*, pages 1655–1664, 2017.
- [87] J. Jiang, F. Han, Q. Ling, J. Wang, T. Li, and H. Han. Efficient network architecture search via multiobjective particle swarm optimization based on decomposition. *Neural Networks*, 123:305–316, 2020.
- [88] H. Jin, Q. Song, and X. Hu. Auto-keras: An efficient neural architecture search system. In *Proceedings of the 25th ACM SIGKDD International Conference on Knowledge Discovery & Data Mining*, pages 1946–1956, 2019.
- [89] Y. Jin. Surrogate-assisted evolutionary computation: Recent advances and future challenges. *Swarm and Evolutionary Computation*, 1:61–70, 06 2011.
- [90] Terry Jones et al. *Evolutionary algorithms, fitness landscapes and search*. PhD thesis, Citeseer, 1995.
- [91] R. Józefowicz, W. Zaremba, and I. Sutskever. An empirical exploration of recurrent network architectures. In *Proceedings of the 32nd International Conference on Machine Learning ICML'2015, France*, pages 2342–2350, 2015.
- [92] F. E. Junior and G. Yen. Particle swarm optimization of deep neural networks architectures for image classification. *Swarm and Evolutionary Computation*, 49:62–74, 2019.
- [93] L. Kaiser, A. N. Gomez, N. Shazeer, A. Vaswani, N. Parmar, L. Jones, and J. Uszkoreit. One model to learn them all. *CoRR*, abs/1706.05137, 2017.
- [94] K. Kandasamy, W. Neiswanger, J. Schneider, B. Póczos, and E. P. Xing. Neural architecture search with bayesian optimisation and optimal transport. In *Advances in Neural Information Processing Systems*, pages 2016–2025, 2018.
- [95] A. Kendall, Y. Gal, and R. Cipolla. Multi-task learning using uncertainty to weigh losses for scene geometry and semantics. In *IEEE Conf. on Computer Vision and Pattern Recognition CVPR'2018, USA*, pages 7482–7491, 2018.
- [96] Y. H. Kim, B. Reddy, S. Yun, and C. Seo. Nemo: Neuro-evolution with multiobjective optimization of deep neural network for speed and accuracy.
- [97] A. Klein, S. Falkner, S. Bartels, P. Hennig, and F. Hutter. Fast bayesian optimization of machine learning hyperparameters on large datasets. In *Int. Conf. on Artificial Intelligence and Statistics, USA*, pages 528–536, 2017.
- [98] A. Krizhevsky. One weird trick for parallelizing convolutional neural networks. *CoRR*, abs/1404.5997, 2014.
- [99] A. Krizhevsky, I. Sutskever, and G. E. Hinton. Imagenet classification with deep convolutional neural networks. In *Advances in Neural Information Processing Systems, USA*, pages 1106–1114, 2012.
- [100] L. Li and T. Ameet. Random search and reproducibility for neural architecture search. *arXiv:1902.07638*, 2019.
- [101] L. Li, K. Jamieson, G. DeSalvo, A. Rostamizadeh, and A. Talwalkar. Hyperband: A novel bandit-based approach to hyperparameter optimization. *Journal of Machine Learning Research*, 18(1):6765–6816, 2017.
- [102] L. Li and A. Talwalkar. Random search and reproducibility for neural architecture search. In *Conference on Uncertainty in Artificial Intelligence UAI'2019, Israel*, page 129, 2019.
- [103] X. Lin, H.-L. Zhen, Z. Li, Q.-F. Zhang, and S. Kwong. Pareto multi-task learning. In *Advances in Neural Information Processing Systems NeurIPS'2019, Canada*, pages 12037–12047, 2019.
- [104] C. Liu, Z. Barret, N. Maxim, S. Jonathon, H. Wei, L. Li-Jia, F-F. Li, Y. Alan, H. Jonathan, and M. Kevin. Progressive neural architecture search.
- [105] C. Liu, L.-C. Chen, F. Schroff, H. Adam, W. Hua, A. L. Yuille, and L. Fei-Fei. Auto-deeplab: hierarchical neural architecture search for semantic image segmentation. In *IEEE Conf. on Computer Vision and Pattern Recognition*, pages 82–92, 2019.
- [106] C. Liu, L-C Chen, F. Schroff, H. Adam, W. Hua, A. L. Yuille, and F-F. Li. Auto-deeplab: Hierarchical neural architecture search for semantic image segmentation. In *IEEE Conf. on Computer Vision and Pattern Recognition CVPR'2019, USA*, pages 82–92, 2019.

- 1569 [107] C. Liu, Z. Zhang, and D. Wang. Pruning deep neural networks by optimal brain damage. In *INTER_SPEECH 15th Conf.*
1570 *Int. Speech Communication, Singapore*, pages 1092–1095.
- 1571 [108] H. Liu, K. Simonyan, O. Vinyals, C. Fernando, and K. Kavukcuoglu. Hierarchical representations for efficient
1572 architecture search. *arXiv:1711.00436*, 2017.
- 1573 [109] H. Liu, K. Simonyan, and Y. Yang. Darts: Differentiable architecture search. *arXiv:1806.09055*, 2018.
- 1574 [110] J. Liu, M. Gong, Q. Miao, X. Wang, and H. Li. Structure learning for deep neural networks based on multiobjective
1575 optimization. *IEEE Trans. Neural Networks Learn. Syst.*, 29(6):2450–2463, 2018.
- 1576 [111] S. Liu, E. Johns, and A. J. Davison. End-to-end multi-task learning with attention. In *IEEE Conf. on Computer Vision*
1577 *and Pattern Recognition CVPR'2019, USA*, pages 1871–1880, 2019.
- 1578 [112] A. Lokhmotov, N. Chunosov, F. Vella, and G. Fursin. Multi-objective autotuning of mobilenets across the full
1579 software/hardware stack. In *Int. Conf. on Reproducible Quality-Efficient Systems Tournament on Co-designing Pareto-*
1580 *efficient Deep Learning, ReQuEST@ASPLOS'2018, USA*, pages 6–16, 2018.
- 1581 [113] M. Loni, S. Sinaei, A. Zoljodi, M. Daneshthalab, and M. Sjödin. Deepmaker: A multi-objective optimization framework
1582 for deep neural networks in embedded systems. *Microprocessors and Microsystems*, page 102989, 2020.
- 1583 [114] P. R. Lorenzo and J. Nalepa. Memetic evolution of deep neural networks. In *Genetic and Evolutionary Computation*
1584 *Conference GECCO'2018, Japan*, pages 505–512, 2018.
- 1585 [115] R. R. Lorenzo, J. Nalepa, L. S. Ramos, and J. R. Pastor. Hyperparameter selection in deep neural networks using parallel
1586 particle swarm optimization. In *Genetic and Evolutionary Computation Conference Companion*, pages 1864–1871, 2017.
- 1587 [116] I. Loshchilov and F. Hutter. CMA-ES for hyperparameter optimization of deep neural networks. *CoRR*, abs/1604.07269,
1588 2016.
- 1589 [117] Z. Lu, I. Whalen, V. Boddeti, Y. D. Dhebar, K. Deb, E. D. Goodman, and W. Banzhaf. NSGA-NET: A multi-objective
1590 genetic algorithm for neural architecture search. *CoRR*, abs/1810.03522, 2018.
- 1591 [118] G. Luo. A review of automatic selection methods for machine learning algorithms and hyper-parameter values.
1592 *Network modeling Analysis in Health Informatics and Bioinformatics*, 5(1):18, 2016.
- 1593 [119] R. Luo, T. Fei, Q. Tao Qin, C. Enhong, and L. Tie-Yan. Neural architecture optimization. In *Advances in neural*
1594 *information processing systems*, pages 7816–7827, 2018.
- 1595 [120] L. Ma, J. Cui, and B. Yang. Deep neural architecture search with deep graph bayesian optimization. In *Int. Conf. on*
1596 *Web Intelligence WI'2019, Greece*, pages 500–507, 2019.
- 1597 [121] G. Marquet, B. Derbel, A. Liefooghe, and E-G. Talbi. Shake them all! - rethinking selection and replacement in
1598 MOEA/D. In *Int. Conf. on Parallel Problem Solving from Nature PPSN XIII, Slovenia*, pages 641–651. Springer, 2014.
- 1599 [122] D. Martinez, W. Brewer, G. Behm, A. Strelzoff, A. Wilson, and D. Wade. Deep learning evolutionary optimization for
1600 regression of rotorcraft vibrational spectra. In *IEEE/ACM Machine Learning in HPC Environments*, pages 57–66, 2018.
- 1601 [123] S. Masanori, S. Shinichi, and N. Tomoharu. A genetic programming approach to designing convolutional neural
1602 network architectures. In *IJCAI'2018*, 2018.
- 1603 [124] N. M. Masood and G. M. Khan. Signal reconstruction using evolvable recurrent neural networks. In *International*
1604 *Conference on Intelligent Data Engineering and Automated Learning*, pages 594–602, 2018.
- 1605 [125] H. Mendoza, A. Klein, M. Feurer, J. T. Springenberg, and F. Hutter. Towards automatically-tuned neural networks. In
1606 *Workshop on Automatic Machine Learning*, pages 58–65, 2016.
- 1607 [126] K. Miettinen. *Nonlinear multiobjective optimization*. Springer, 1999.
- 1608 [127] R. Miikkulainen, J. Z. Liang, E. Meyerson, A. Rawal, D. Fink, O. Francon, B. Raju, H. Shahrzad, A. Navruzyan, N. Duffy,
1609 and B. Hodjat. Evolving deep neural networks. *CoRR*, abs/1703.00548, 2017.
- 1610 [128] S. Mittal. A survey of fpga-based accelerators for convolutional neural networks. *Neural computing and applications*,
1611 pages 1–31, 2018.
- 1612 [129] P. Molchanov, S. Tyree, T. Karras, T. Aila, and J. Kautz. Pruning convolutional neural networks for resource efficient
1613 transfer learning. *CoRR*, abs/1611.06440, 2016.
- 1614 [130] R. Negrinho and G. Gordon. Deeparchitect: Automatically designing and training deep architectures. *arXiv:1704.08792*,
1615 2017.
- 1616 [131] K. Ni, R. Pearce, K. Boakye, B. Van Essen, D. Borth, B. Chen, and E. Wang. Large-scale deep learning on the yfcc100m
1617 dataset. *arXiv:1502.03409*, 2015.
- 1618 [132] T. Paine, H. Jin, J. Yang, Z. Lin, and T. S. Huang. GPU asynchronous stochastic gradient descent to speed up neural
1619 network training. In *2nd Int. Conf. on Learning Representations ICLR'2014, Canada*, 2014.
- 1620 [133] R. Parekh, J. Yang, and V. G. Honavar. Constructive neural-network learning algorithms for pattern classification.
1621 *IEEE Trans. Neural Networks Learn. Syst.*, 11(2):436–451, 2000.
- 1622 [134] E. Park, D. Kim, S. Kim, Y-D Kim, G. Kim, S. Yoon, and S. Yoo. Big/little deep neural network for ultra low power
1623 inference. In G. Nicolescu and A. Gerstlauer, editors, *International Conference on Hardware/Software Codesign and*
1624 *System Synthesis, CODES+ISSS, Netherlands*, pages 124–132, 2015.

- 1618 [135] J. Pelamatti, L. Brevault, M. Balesdent, E-G. Talbi, and Y. Guerin. How to deal with mixed-variable optimization
 1619 problems: An overview of algorithms and formulations. In *World Congress of Structural and Multidisciplinary*
 1620 *Optimisation*, pages 64–82, 2017.
- 1621 [136] J. Pelamatti, L. Brevault, M. Balesdent, E-G. Talbi, and Y. Guerin. Bayesian optimization of variable-size design space
 1622 problems. *Optimization & Engineering Journal*, 2020.
- 1623 [137] H. Pham, M. Y. Guan, B. Zoph, Q. V. Le, and J. Dean. Efficient neural architecture search via parameter sharing. In *Int.*
 1624 *Conf. on Machine Learning ICML, Sweden*, volume 80, pages 4092–4101.
- 1625 [138] H. Qi, E. R. Sparks, and A. Talwalkar. Paleo: A performance model for deep neural networks. In *5th Int. Conf. on*
 1626 *Learning Representations ICLR'2017, France*, 2017.
- 1627 [139] A. Rawal and R. Miikkulainen. From nodes to networks: Evolving recurrent neural networks. *arXiv preprint*
 1628 *arXiv:1803.04439*, 2018.
- 1629 [140] W. Rawat and Z. Wang. Hybrid stochastic GA-Bayesian search for deep convolutional neural network model selection.
 1630 *Journal of Universal Computer Science*, 25(6):647–666, 2019.
- 1631 [141] E. Real, A. Aggarwal, Y. Huang, and Q. V. Le. Aging evolution for image classifier architecture search. In *AAAI Conf.*
 1632 *on Artificial Intelligence*, 2019.
- 1633 [142] E. Real, A. Aggarwal, Y. Huang, and Q. V. Le. Regularized evolution for image classifier architecture search. In *AAAI*
 1634 *conference on artificial intelligence*, volume 33, pages 4780–4789, 2019.
- 1635 [143] E. Real, S. Moore, A. Selle, S. Saxena, Y. L. Suematsu, J. Tan, Q. V. Le, and A. Kurakin. Large-scale evolution of image
 1636 classifiers. In *Int. Conf. on Machine Learning*, pages 2902–2911, 2017.
- 1637 [144] A. Romero, N. Ballas, S. E. Kahou, A. Chassang, C. Gatta, and Y. Bengio. Fitnets: hints for thin deep nets. In *Int. Conf.*
 1638 *on Learning Representations ICLR'2015, USA*, 2015.
- 1639 [145] B. B. Rouhani, A. Mirhoseini, and F. Koushanfar. Delight: Adding energy dimension to deep neural networks. In *Int.*
 1640 *Symp. on Low Power Electronics and Design ISLPED'2016, USA*, pages 112–117.
- 1641 [146] Sebastian Ruder. An overview of multi-task learning in deep neural networks. *arXiv preprint arXiv:1706.05098*, 2017.
- 1642 [147] S. Saxena and J. Verbeek. Convolutional neural fabrics. In *Advances in Neural Information Processing Systems*, pages
 1643 4053–4061, 2016.
- 1644 [148] C. Sciuto, K. Yu, M. Jaggi, C. Musat, and M. Salzmann. Evaluating the search phase of neural architecture search.
 1645 *arXiv:1902.08142*, 2019.
- 1646 [149] C. Sciuto, K. Yu, M. Jaggi, C. Musat, and M. Salzmann. Evaluating the search phase of neural architecture search.
 1647 *CoRR*, abs/1902.08142, 2019.
- 1648 [150] A. Sener and V. Koltun. Multi-task learning as multi-objective optimization. In *Advances in Neural Information*
 1649 *Processing Systems*, pages 527–538, 2018.
- 1650 [151] A. Sergeev and M. Del Balso. Horovod: fast and easy distributed deep learning in tensorflow. *arXiv:1802.05799*, 2018.
- 1651 [152] B. Shahriari, K. Swersky, Z. Wang, R. P. Adams, and N. De Freitas. Taking the human out of the loop: A review of
 1652 bayesian optimization. *Proceedings of the IEEE*, 104(1):148–175, 2015.
- 1653 [153] R. Shin, C. Packer, and D. Song. Differentiable neural network architecture search. 2018.
- 1654 [154] T. Shinozaki and S. Watanabe. Structure discovery of deep neural network based on evolutionary algorithms. In *IEEE*
 1655 *Int. Conf. on Acoustics, Speech and Signal Processing (ICASSP)*, pages 4979–4983, 2015.
- 1656 [155] K. Simonyan and A. Zisserman. Very deep convolutional networks for large-scale image recognition. In *Int. Conf. on*
 1657 *Learning Representations ICLR'2015*, 2015.
- 1658 [156] C. Smith and Y. Jin. Evolutionary multi-objective generation of recurrent neural network ensembles for time series
 1659 prediction. *Neurocomputing*, 143:302–311, 2014.
- 1660 [157] S. C. Smithson, G. Yang, W. J. Gross, and B. H. Meyer. Neural networks designing neural networks: multi-objective
 1661 hyper-parameter optimization. In *Int. Conf. on Computer-Aided Design, ICCAD'2016, USA*, page 104, 2016.
- 1662 [158] J. Snoek, H. Larochelle, and R. P. Adams. Practical bayesian optimization of machine learning algorithms. In *Advances*
 1663 *in Neural Information Processing Systems*, pages 2951–2959, 2012.
- 1664 [159] J. Snoek, O. Rippel, K. Swersky, R. Kiros, N. Satish, N. Sundaram, M. A. P. Prabhat, and R. P. Adams. Scalable bayesian
 1665 optimization using deep neural networks. In *Int. Conf. on Machine Learning, France*, pages 2171–2180, 2015.
- 1666 [160] J. T. Springenberg, A. Klein, S. Falkner, and F. Hutter. Bayesian optimization with robust bayesian neural networks.
 In *Advances in neural information processing systems*, pages 4134–4142, 2016.
- [161] P. F. Stadler. Landscapes and their correlation functions. *Journal of Mathematical chemistry*, 20(1):1–45, 1996.
- [162] K. O. Stanley, J. Clune, J. Lehman, and R. Miikkulainen. Designing neural networks through neuroevolution. *Nature*
Machine Intelligence, 1(1):24–35, 2019.
- [163] K. O. Stanley and R. Miikkulainen. Evolving neural networks through augmenting topologies. *Evolutionary computa-*
tion, 10(2):99–127, 2002.
- [164] I. Strumberger, E. Tuba, N. Bacanin, R. Jovanovic, and M. Tuba. Convolutional neural network architecture design by
 the tree growth algorithm framework. In *Int. Joint Conf. on Neural Networks IJCNN'2019, Hungary*, pages 1–8, 2019.

- 1667 [165] M. Suganuma, M. Ozay, and T. Okatani. Exploiting the potential of standard convolutional autoencoders for image
1668 restoration by evolutionary search. In *Int. Conf. on Machine Learning ICML'2018, Sweden*, pages 4778–4787, 2018.
- 1669 [166] Y. Sun, X. Wang, and X. Tang. Sparsifying neural network connections for face recognition. In *Conf on Computer
1670 Vision and Pattern Recognition CVPR'2016, USA*, pages 4856–4864, 2016.
- 1671 [167] Y. Sun, B. Xue, M. Zhang, and G. Yen. An experimental study on hyper-parameter optimization for stacked auto-
1672 encoders. In *IEEE Congress on Evolutionary Computation (CEC)*, pages 1–8, 2018.
- 1673 [168] Y. Sun, B. Xue, M. Zhang, and G. Yen. A particle swarm optimization-based flexible convolutional autoencoder for
1674 image classification. *IEEE Trans. on Neural Networks and Learning Systems*, 30(8):2295–2309, 2018.
- 1675 [169] K. Swersky, D. Duvenaud, J. Snoek, F. Hutter, and M. A. Osborne. Raiders of the lost architecture: Kernels for bayesian
1676 optimization in conditional parameter spaces. *arXiv:1409.4011*, 2014.
- 1677 [170] C. Szegedy, W. Liu, Y. Jia, P. Sermanet, S. Reed, D. Anguelov, D. Erhan, V. Vanhoucke, and A. Rabinovich. Going
1678 deeper with convolutions. In *Conf on Computer Vision and Pattern Recognition*, pages 1–9, 2015.
- 1679 [171] C. Szegedy, V. Vanhoucke, S. Ioffe, J. Shlens, and Z. Wojna. Rethinking the inception architecture for computer vision.
1680 In *Conf on computer vision and pattern recognition*, pages 2818–2826, 2016.
- 1681 [172] E-G. Talbi. Metaheuristics: from design to implementation. 2009.
- 1682 [173] E-G. Talbi. A unified view of parallel multi-objective evolutionary algorithms. *Journal of Parallel Distributed
1683 Computing*, 133:349–358, 2019.
- 1684 [174] M. Tan, B. Chen, R. Pang, V. Vasudevan, M. Sandler, A. Howard, and Q. V. Le. Mnasnet: Platform-aware neural
1685 architecture search for mobile. pages 2820–2828, 2019.
- 1686 [175] C. Thornton, F. Hutter, H. Hoos H, and K. Leyton-Brown. Auto-weka: Combined selection and hyperparameter
1687 optimization of classification algorithms. In *Int. Conf. on Knowledge Discovery and Data Mining*, pages 847–855, 2013.
- 1688 [176] A. Turner. *Evolving artificial neural networks using Cartesian genetic programming*. PhD thesis, University of York,
1689 2015.
- 1690 [177] T. Veniat and L. Denoyer. Learning time/memory-efficient deep architectures with budgeted supernetworks. In *Conf
1691 on Computer Vision and Pattern Recognition CVPR'2018, USA*, pages 3492–3500, 2018.
- 1692 [178] B. Wang, Y. Sun, B. Xue, and M. Zhang. Evolving deep convolutional neural networks by variable-length particle
1693 swarm optimization for image classification. In *Congress on Evolutionary Computation (CEC)*, pages 1–8, 2018.
- 1694 [179] B. Wang, Y. Sun, B. Xue, and M. Zhang. A hybrid differential evolution approach to designing deep convolutional
1695 neural networks for image classification. In *Australasian Joint Conf. on Artificial Intelligence*, pages 237–250, 2018.
- 1696 [180] B. Wang, Y. Sun, B. Xue, and M. Zhang. Evolving deep neural networks by multi-objective particle swarm optimization
1697 for image classification. In *Genetic and Evolutionary Computation Conference*, pages 490–498, 2019.
- 1698 [181] C. Wang, L. Gong, Q. Yu, X. Li, Y. Xie, and X. Zhou. Dlau: A scalable deep learning accelerator unit on fpga. *IEEE
1699 Transactions on Computer-Aided Design of Integrated Circuits and Systems*, 36(3):513–517, 2016.
- 1700 [182] C. Wang, C. Xu, X. Yao, and D. Tao. Evolutionary generative adversarial networks. *IEEE Transactions on Evolutionary
1701 Computation*, 23(6):921–934, 2019.
- 1702 [183] L. Wang, Y. Zhao, Y. Jinnai, Y. Tian, and R. Fonseca. Alphax: exploring neural architectures with deep neural networks
1703 and monte carlo tree search. *CoRR*, abs/1903.11059, 2019.
- 1704 [184] T. Wei, C. Wang, Y. Rui, and C.W. Chen. Network morphism. In *Int. Conf. on Machine Learning*, pages 564–572, 2016.
- 1705 [185] K. Weiss, T. Khoshgoftaar, and D. Wang. A survey of transfer learning. *Journal of Big data*, 3(1):9, 2016.
- 1706 [186] Y. Weng, T. Zhou, Y. Li, and X. Qiu. Nas-unet: Neural architecture search for medical image segmentation. *IEEE
1707 Access*, 7:44247–44257, 2019.
- 1708 [187] C. White, W. Neiswanger, and Y. Savani. Bananas: Bayesian optimization with neural architectures for neural
1709 architecture search. *arXiv:1910.11858*, 2019.
- 1710 [188] L. Xie and A. Yuille. Genetic CNN. In *IEEE Int. Conf. on Computer Vision*, pages 1379–1388, 2017.
- 1711 [189] S. Xie, H. Zheng, C. Liu, and L. Lin. SNAS: stochastic neural architecture search. In *Int. Conf. on Learning Representations,
1712 ICLR'2019, USA*, 2019.
- 1713 [190] O. Yadan, K. Adams, Y. Taigman, and M. Ranzato. Multi-gpu training of convnets. In *Int. Conf. on Learning
1714 Representations ICLR'2014, Canada*, 2014.
- 1715 [191] C. Ying, A. Klein, E. Real, E. Christiansen, K. Murphy, and F. Hutter. Nas-bench-101: Towards reproducible neural
1716 architecture search. *arXiv:1902.09635*, 2019.
- [192] S. R. Young, D. C. Rose, T. P. Karnowski, S-H Lim, and R. M. Patton. Optimizing deep learning hyper-parameters
through an evolutionary algorithm. In *Workshop on Machine Learning in HPC Environments, USA*, pages 41–45, 2015.
- [193] A. Zela, A. Klein, S. Falkner, and F. Hutter. Towards automated deep learning: efficient joint neural architecture and
hyperparameter search. *arXiv:1807.06906*, 2018.
- [194] Q. Zhang and H. Li. Moea/d: A multiobjective evolutionary algorithm based on decomposition. *IEEE Transactions on
Evolutionary Computation*, 11(6):712–731, 2007.

- 1716 [195] X. Zhang, Z. Huang, and N. Wang. You only search once: single shot neural architecture search via direct sparse
1717 optimization. *CoRR*, abs/1811.01567, 2018.
- 1718 [196] Y. Zhang, C. Wang, L. Gong, Y. Lu, F. Sun, C. Xu, X. Li, and X. Zhou. A power-efficient accelerator based on FPGAs
1719 for LSTM network. In *IEEE Int. Conf. on Cluster Computing (CLUSTER)*, pages 629–630, 2017.
- 1720 [197] G. Zhong, T. Li, W. Jiao, L-N. Wang, J. Dong, and C-L. Liu. DNA computing inspired deep networks design.
1721 *Neurocomputing*, 382:140–147, 2020.
- 1722 [198] Z. Zhong, J. Yan, and C-L Liu. Practical network blocks design with q-learning. *CoRR*, abs/1708.05552, 2017.
- 1723 [199] Z. Zhong, J. Yan, W. Wu, J. Shao, and C-H. Liu. Practical block-wise neural network architecture generation. In *IEEE*
1724 *Conf. on Computer Vision and Pattern Recognition*, pages 2423–2432, 2018.
- 1725 [200] Y. Zhou, S. Arik, H. Yu, H. Liu, and G. Diamos. Resource-efficient neural architect. *arXiv:1806.07912*, 2018.
- 1726 [201] B. Zhuang, C. Shen, M. Tan, L. Liu, and I. D. Reid. Structured binary neural networks for accurate image classification
1727 and semantic segmentation. In *IEEE Conf. on Computer Vision and Pattern Recognition, USA*, pages 413–422, 2019.
- 1728 [202] B Zoph and Q. V. Le. Neural architecture search with reinforcement learning. In *Int. Conf. on Learning Representations*
1729 *ICLR'2017, France*, 2017.
- 1730 [203] B. Zoph, V. Vasudevan, J. Shlens, and Q. V. Le. Learning transferable architectures for scalable image recognition. In
1731 *IEEE Conf. on Computer Vision and Pattern Recognition*, pages 8697–8710, 2018.
- 1732
- 1733
- 1734
- 1735
- 1736
- 1737
- 1738
- 1739
- 1740
- 1741
- 1742
- 1743
- 1744
- 1745
- 1746
- 1747
- 1748
- 1749
- 1750
- 1751
- 1752
- 1753
- 1754
- 1755
- 1756
- 1757
- 1758
- 1759
- 1760
- 1761
- 1762
- 1763
- 1764