



**HAL**  
open science

# A brief introduction to multichannel noise reduction with deep neural networks

Romain Serizel

► **To cite this version:**

Romain Serizel. A brief introduction to multichannel noise reduction with deep neural networks. SpiN 2020 - 12th Speech in Noise Workshop, Jan 2020, Toulouse, France. hal-02506387

**HAL Id: hal-02506387**

**<https://inria.hal.science/hal-02506387v1>**

Submitted on 5 Jun 2020

**HAL** is a multi-disciplinary open access archive for the deposit and dissemination of scientific research documents, whether they are published or not. The documents may come from teaching and research institutions in France or abroad, or from public or private research centers.

L'archive ouverte pluridisciplinaire **HAL**, est destinée au dépôt et à la diffusion de documents scientifiques de niveau recherche, publiés ou non, émanant des établissements d'enseignement et de recherche français ou étrangers, des laboratoires publics ou privés.

# A brief introduction to multichannel noise reduction with deep neural network.

Romain Serizel

LORIA, Université de Lorraine, Inria, CNRS (France)

Thursday 9<sup>th</sup>, January 2020



# Outline

- 1 Context and motivations
- 2 Multichannel speech enhancement
- 3 Introduction to artificial neural networks
- 4 DNN for multichannel speech enhancement
- 5 Conclusions and perspectives

# Speech in real conditions

Problem “solved”

Close-up microphones, clean speech

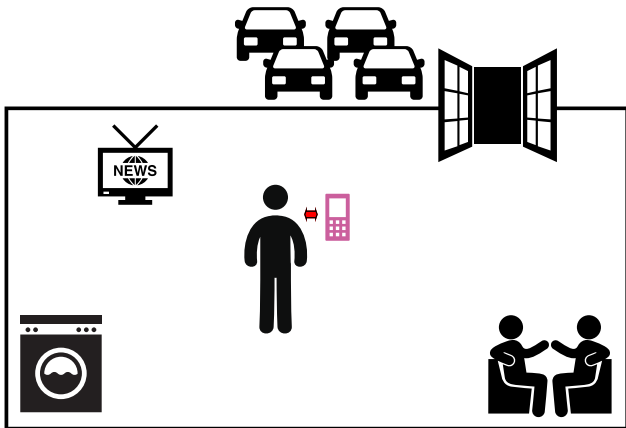

# Speech in real conditions

There is some work to do :

Moving microphones

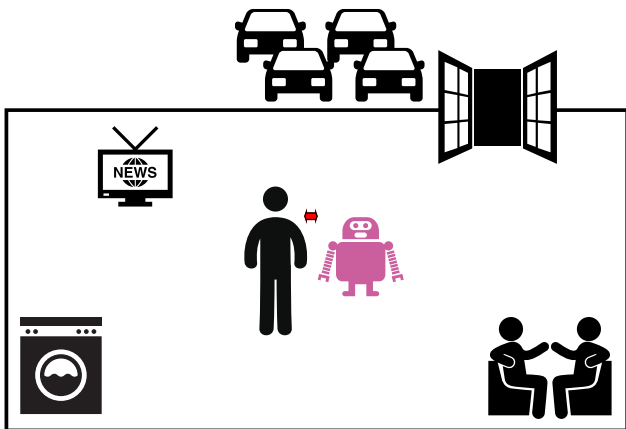

# Speech in real conditions

There is some work to do :

Distant microphones

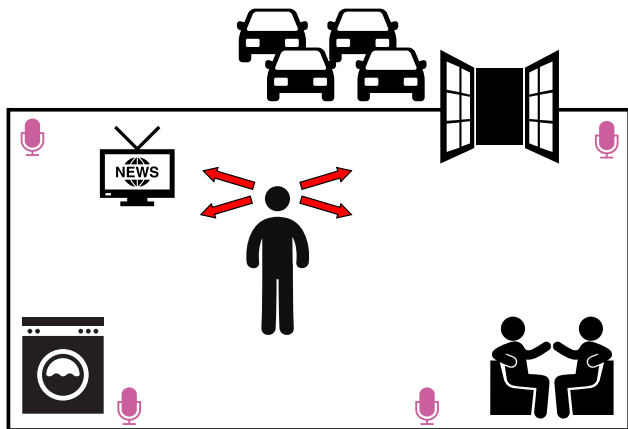

# Speech in real conditions

There is some work to do :

Distant microphones, mobile sources...

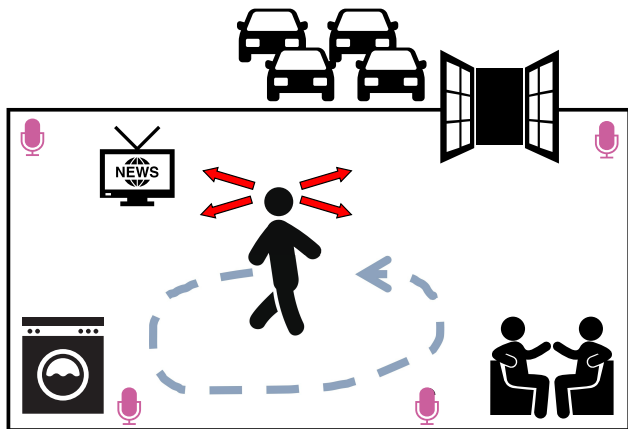

# Multichannel speech enhancement ?

## Context

- Reduce the impact of the acoustic perturbations :
  - Cleaning the signal

## In this talk

- Focus on noise removal/attenuation
  - Noise reduction
  - Noise suppression
  - De-noising
  - ...



# Outline

- 1 Context and motivations
- 2 Multichannel speech enhancement**
- 3 Introduction to artificial neural networks
- 4 DNN for multichannel speech enhancement
- 5 Conclusions and perspectives

# Signal model

Signal observed

$$\mathbf{X} = \mathbf{X}_S + \mathbf{X}_N$$

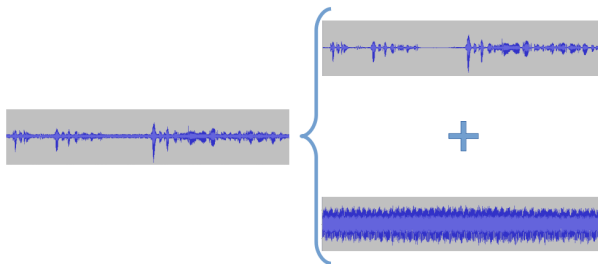

# Filtering

## Single-channel filter

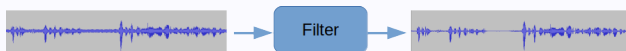

# Filtering

## Single-channel filter

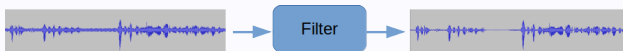

## Multichannel filter

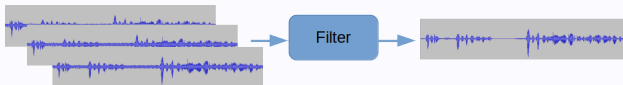

# Single-channel enhancement

On single-mic data, perform spectral filtering/masking.

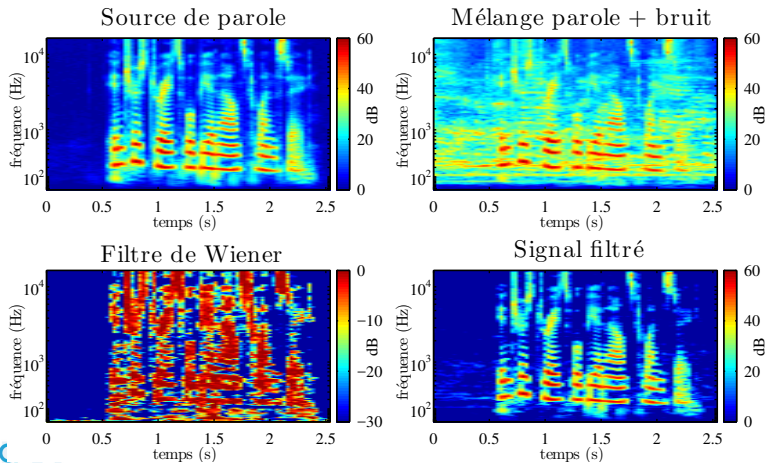

# Multichannel enhancement (1)

On multi-mic data, exploit spatial localization.

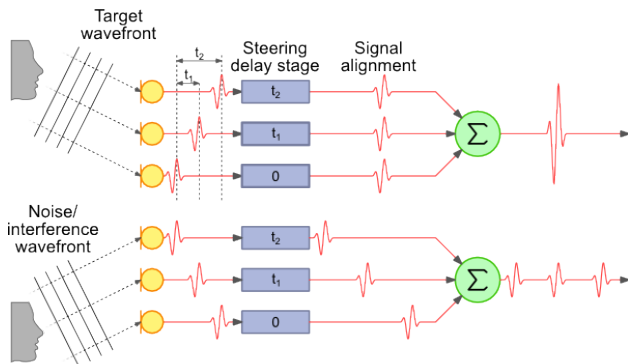
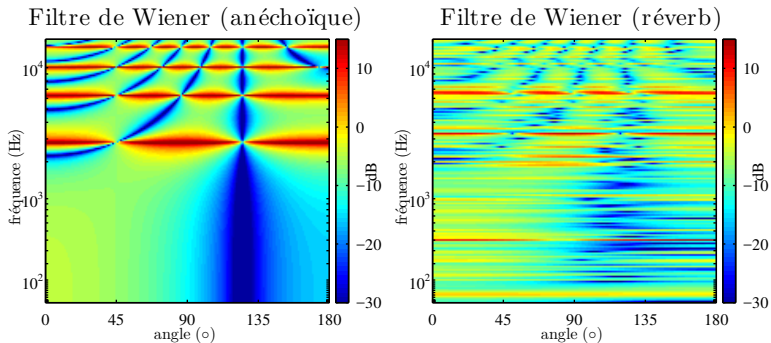

Image source : the lab book page

## Multichannel enhancement (2)

On multi-mic data, perform joint spatial and spectral masking.



# MWF-based speech enhancement (1)

## Speech distortion weighted MWF (MMSE criterion)

MMSE estimate of the (unknown) speech component :

$$\min_{\mathbf{W}} E\{|X_{\text{Ref}} - \mathbf{W}^H \mathbf{X}_s|^2\} + \mu\{\mathbf{W}^H \mathbf{X}_n|^2\}$$

## SDW-MWF

$$\mathbf{W} = (\mathbf{R}_s + \mu \mathbf{R}_n)^{-1} \mathbf{R}_s \mathbf{e}_{\text{Ref}}$$

- $\mathbf{X}_s, \mathbf{X}_n$  : speech, noise components of the microphone signals
- $\mathbf{W}^H \mathbf{X}$  : output signal of the filter  $\mathbf{W}$
- $\mathbf{R}_s$  and  $\mathbf{R}_n$  : speech and noise correlation matrices



## MWF-based speech enhancement (2)

### Estimation of the speech correlation matrix

$\mathbf{R}_s$  is estimated from speech+noise correlation matrix  $\mathbf{R}_x$

and noise correlation matrix  $\mathbf{R}_n$  :

$$\mathbf{R}_s = \mathbf{R}_x - \mathbf{R}_n$$

→ Requires a voice activity detector !

# Voice activity detector

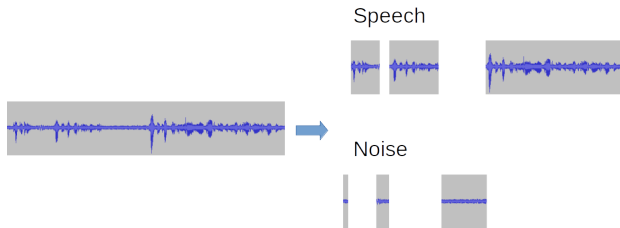

## Limitations

- Limited to full frequency band
- Energy-based VAD do not work well at low SNR

# Voice activity detector

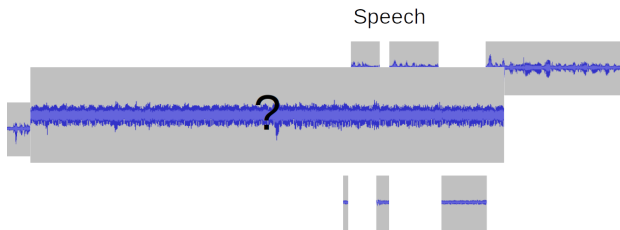

## Limitations

- Limited to full frequency band
- Energy-based VAD do not work well at low SNR

# Time-frequency masks

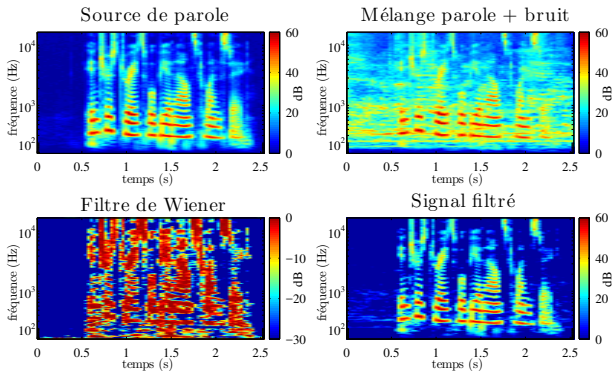

How can we obtain reliable masks ?

# Outline

- 1 Context and motivations
- 2 Multichannel speech enhancement
- 3 Introduction to artificial neural networks**
- 4 DNN for multichannel speech enhancement
- 5 Conclusions and perspectives

# The perceptron 1

## Perceptron model

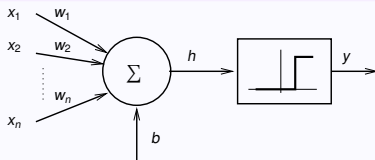

A perceptron is a linear classifier :

$$h = \mathbf{w} \cdot \mathbf{x} + b$$

$$y = f(h) \text{ e.g. } \begin{cases} 1 & \text{if } \mathbf{w} \cdot \mathbf{x} + b > 0 \\ 0 & \text{else} \end{cases}$$

## The perceptron 2

Perceptron cannot model a  
XOR [Minsky *et al.*, 1969]  
⇒ Work on perceptron stopped

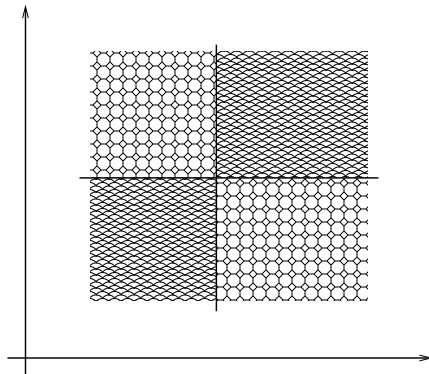

## The perceptron 2

Perceptron cannot model a  
XOR [Minsky *et al.*, 1969]  
⇒ Work on perceptron stopped

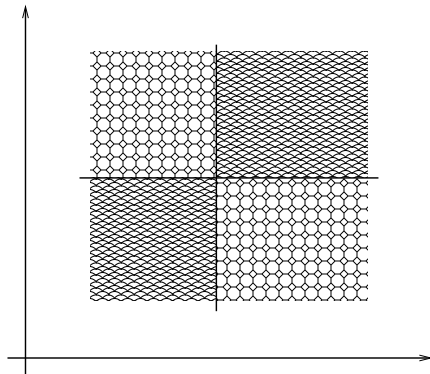

At least single perceptron cannot !



# Multilayer perceptrons

## Multilayer perceptrons (MLP) :

- Feedforward network
- Perceptrons arranged in fully-connected layers
- Well suited for pattern classification

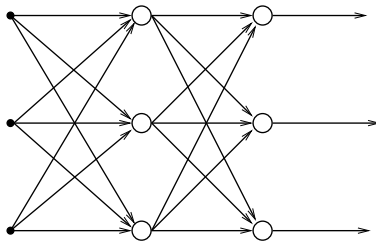

# Multilayer perceptrons

## Multilayer perceptrons (MLP) :

- Feedforward network
- Perceptrons arranged in fully-connected layers
- Well suited for pattern classification

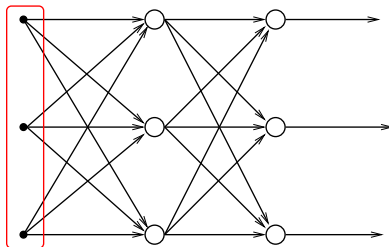

Input layer

# Multilayer perceptrons

## Multilayer perceptrons (MLP) :

- Feedforward network
- Perceptrons arranged in fully-connected layers
- Well suited for pattern classification

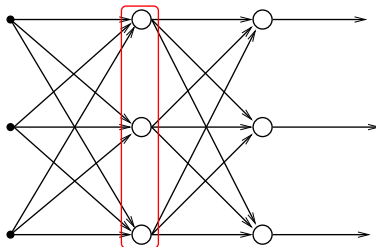

Hidden layer(s)

# Multilayer perceptrons

## Multilayer perceptrons (MLP) :

- Feedforward network
- Perceptrons arranged in fully-connected layers
- Well suited for pattern classification

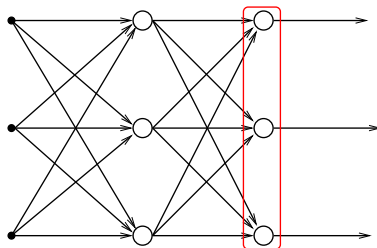

Output layer

# Multilayer perceptrons

## Multilayer perceptrons (MLP) :

- Feedforward network
- Perceptrons arranged in fully-connected layers
- Well suited for pattern classification

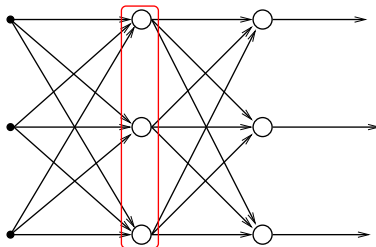

Deep neural networks have more than 1 hidden layers

# Convolutional neural networks (CNN)

## Keys ideas

- Detect patterns in images/spectrograms
- Apply sets of filters to obtain feature maps
- Subsample to control dimensionality

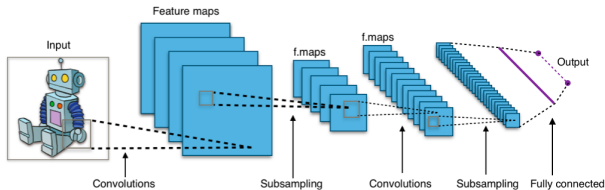

• Image source : wikimedia

# Recurrent neural networks (RNN)

## Keys idea

- Model context

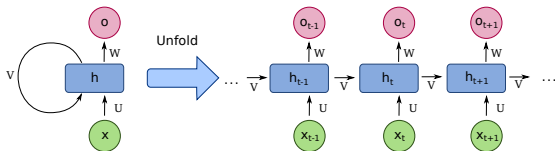

# Recurrent neural networks (RNN)

## Keys idea

- Model context

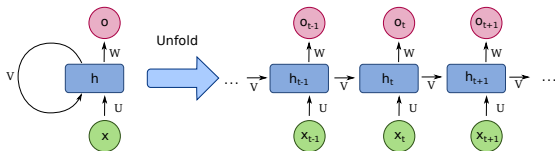

## Problems

- Hard to train
- Exploding/vanishing gradient

Image source : wikimedia



# Recurrent neural networks (RNN)

## Keys idea

- Model context

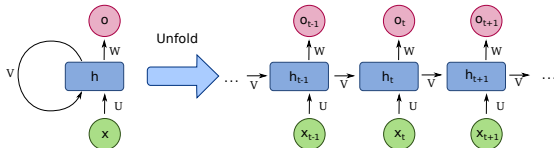

## Solutions

- LSTM, GRU...

Image source : wikimedia

# Outline

- 1 Context and motivations
- 2 Multichannel speech enhancement
- 3 Introduction to artificial neural networks
- 4 DNN for multichannel speech enhancement**
- 5 Conclusions and perspectives

# DNN-base mask estimation for multichannel filtering

Use LSTM to estimate speech/noise masks [Heymann et al.].

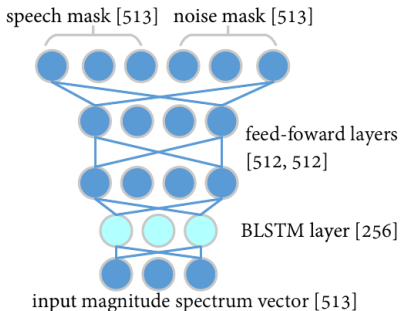

• J. Heymann, L. Drude, R. Haeb-Umbach. *Neural network based spectral mask estimation for acoustic beamforming*. Proc ICASSP 2016

# DNN-base mask estimation for MWF

[Z. Wang]

Use the masks to estimate the correlation matrices and MWF filters.

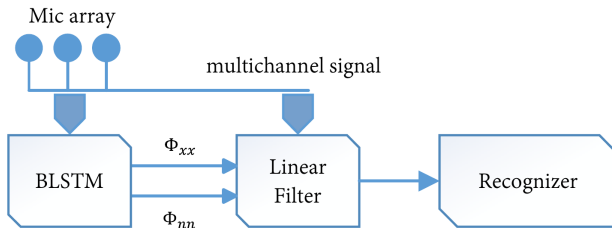

• Z. Wang, E. Vincent, R. Serizel, Y. Yan. *Rank-1 Constrained Multichannel Wiener Filter for Speech Recognition in Noisy Environments*. Computer Speech and Language

## Exemple performance

Evaluation in terms of word error rate (WER).

Noisy		WER baseline
Single-channel DNN		no WER reduc.
Delay-and-sum		21% rel. WER reduc.
DNN post-filter		20% rel. WER reduc.
Multichannel DNN		39% rel. WER reduc.

Greatly outperforms multichannel NMF (25% rel. WER reduc.)  
and DNN used to directly predict multichannel filters.

CHiME-3 : speech recorded in a bus/café. Single DNN iteration, no post-processing.

• A. A. Nugraha, A. Liutkus, E. Vincent. *Multichannel audio source separation with deep neural networks*.  
IEEE/ACM TASLP, 24 (9), pp. 1652 - 1664, 2016.



# What input should we give to the network ?

(Part of Phd work from L. Perotin)

[With E. Vincent and A. Guérin]

# Multichannel speech enhancement for HOA

Represent the sound field in a basis of spherical harmonics

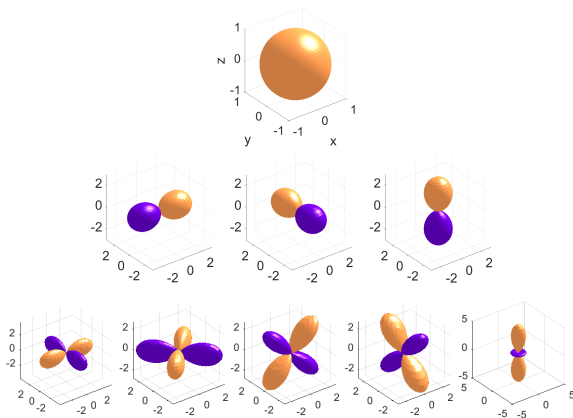

# Multichannel speech enhancement for HOA

Use only the 4 channels from the first 2 orders

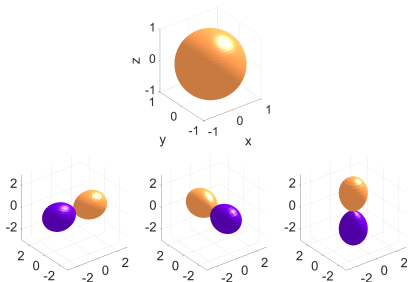

• L. Perotin, R. Serizel, E. Vincent, A. Guérin. *Multichannel speech separation with recurrent neural networks from high-order ambisonics recordings*. In proc. of ICASSP, 2018.



# Multichannel speech enhancement for HOA [L. Perotin]

- HOA beamformer
- LSTM to estimate speech/noise masks
- GEVD-MWF filter

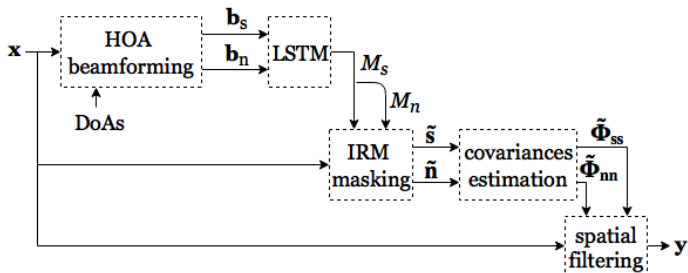

• L. Perotin, R. Serizel, E. Vincent, A. Guérin. *Multichannel speech separation with recurrent neural networks from high-order ambisonics recordings*. In proc. of ICASSP, 2018.

# Results

## Setup

- Tested on a subset of ESTER
- 20 sentences (4043 words)
- Acoustic conditions :  $TR_{60}=350\text{ms}$ , room-mic = 1.65m

## Results

Interference	noise	speaker		
		25°	45°	90°
Reverberant source	9.80	10.80	10.82	10.76
Mixture	68.25	91.96	88.56	89.00
Simple beamformer	40.80	75.42	39.06	20.54
GEVD (w/o noise est.)	21.69	78.43	18.55	12.02
GEVD (w noise est.)	21.72	23.1	16.05	12.47



# How can we deal with ad-hoc microphone arrays ? (Part of Phd work from N. Furnon) [With I. Illina and S. Essid]

# Heterogeneous unconstrained microphone arrays

## Target :

- Use the microphones already available

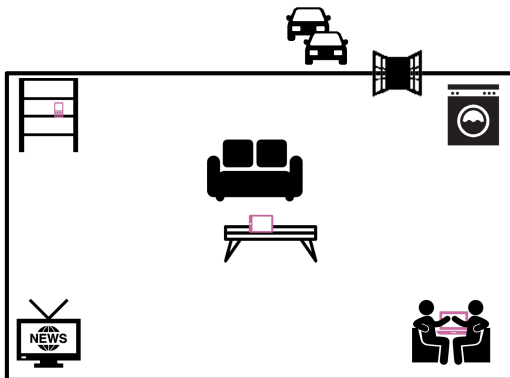

# Collaborative approach

## Targets :

- Collaboration between the nodes (common target)
- Feedback from the common target to the node level

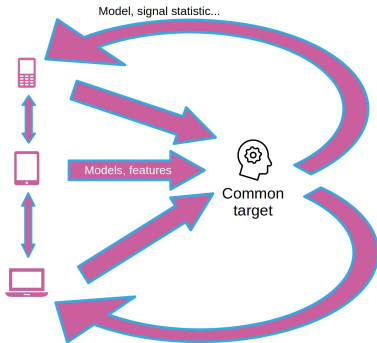

# Distributed node specific MWF

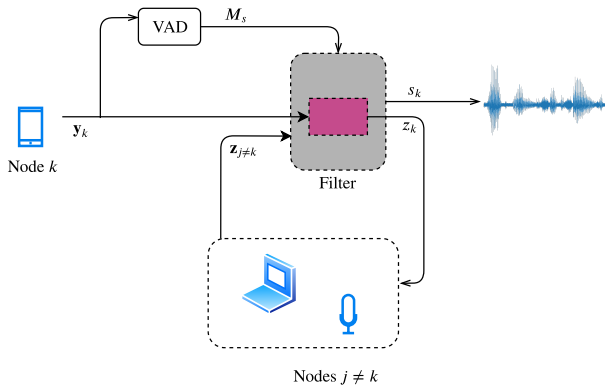

- A. Bertrand, M. Moonen. *Distributed adaptive node-specific signal estimation in fully connected sensor networks—Part I : Sequential node updating*. IEEE Transactions on Signal Processing.

# Distributed MWF with DNN [N. Furnon]

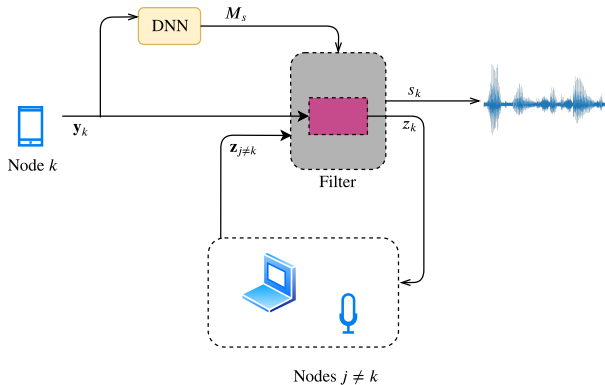

- N. Furnon, R. Serizel, I. Illina, S. Essid. *DNN-Based Distributed Multichannel Mask Estimation for Speech Enhancement in Microphone Arrays*. Submitted to ICASSP 2020.

# Distributed MWF with DNN [N. Furnon]

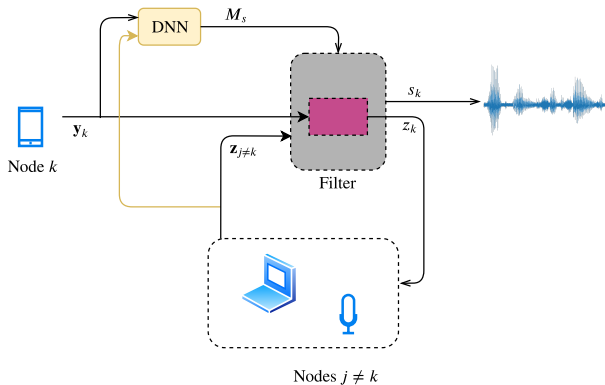

- N. Furnon, R. Serizel, I. Illina, S. Essid. *DNN-Based Distributed Multichannel Mask Estimation for Speech Enhancement in Microphone Arrays*. Submitted to ICASSP 2020.



# Distributed MWF with DNN (Results)

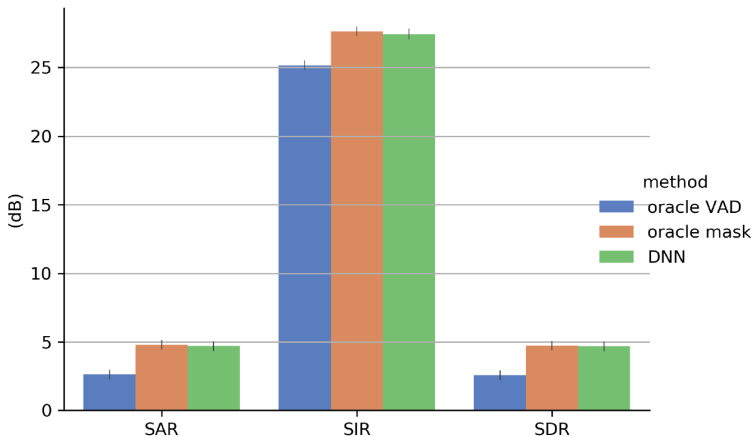

• N. Furnon, R. Serizel, I. Illina, S. Essid. *DNN-Based Distributed Multichannel Mask Estimation for Speech Enhancement in Microphone Arrays*. Submitted to ICASSP 2020.

# Outline

- 1 Context and motivations
- 2 Multichannel speech enhancement
- 3 Introduction to artificial neural networks
- 4 DNN for multichannel speech enhancement
- 5 **Conclusions and perspectives**

# Conclusions and perspectives

## Conclusions

- Deep learning is now the state-of-the-art in multichannel speech enhancement
- Important improvements compared to previous approaches

## Perspectives

- Unconstrained microphone array processing,
- Distributed learning,
- Application to real-world conditions,
- Extension to other related domains. . .