



HAL
open science

Numerical Simulation of a Battery Thermal Management System Under Uncertainty for a Racing Electric Car

Elie Solai, Heloise Beaugendre, Pietro Marco Congedo, Rémi Daccord,
Maxime Guadagnini

► **To cite this version:**

Elie Solai, Heloise Beaugendre, Pietro Marco Congedo, Rémi Daccord, Maxime Guadagnini. Numerical Simulation of a Battery Thermal Management System Under Uncertainty for a Racing Electric Car. Journée d'étude NAFEMS - La simulation pour la mobilité électrique, Nov 2019, Paris, France. hal-02477939

HAL Id: hal-02477939

<https://inria.hal.science/hal-02477939>

Submitted on 13 Feb 2020

HAL is a multi-disciplinary open access archive for the deposit and dissemination of scientific research documents, whether they are published or not. The documents may come from teaching and research institutions in France or abroad, or from public or private research centers.

L'archive ouverte pluridisciplinaire **HAL**, est destinée au dépôt et à la diffusion de documents scientifiques de niveau recherche, publiés ou non, émanant des établissements d'enseignement et de recherche français ou étrangers, des laboratoires publics ou privés.

Numerical Simulation of a Battery Thermal Management System Under Uncertainty for a Racing Electric Car

crédit : Jaguar MENA

E. Solai*, H. Beaugendre,* P-M Congedo**

R. Daccord***, M. Guadagnini***



La simulation pour la mobilité électrique, NAFEMS

November 13, 2019

* INRIA Bordeaux Sud-Ouest, Team CARDAMOM

** INRIA, Centre de Mathématiques Appliquées, Ecole Polytechnique, IPP

*** EXOES, France

Inria

EXOES

elie.solai@inria.fr

1 Industrial and Research Objectives

2 Battery Thermal Management System

3 Low-Fidelity Numerical Model

4 Numerical Simulation Under Uncertainty

- 1 Industrial and Research Objectives
- 2 Battery Thermal Management System
- 3 Low-Fidelity Numerical Model
- 4 Numerical Simulation Under Uncertainty

Battery Thermal Management for Electric Vehicles

E-racing Car requirements

- Several charge/discharge cycles in small time intervals
- High Power from the Electrical Engine and Fast recharging : increased heat loads on Battery Pack

Battery Thermal Management for Electric Vehicles

Immersion Cooling System by EXOES

- Electric Cells immersed in dielectric cooling fluid.
- Heat exchanged directly from cells to the fluid.
- Good thermal homogeneity within the Battery Pack.

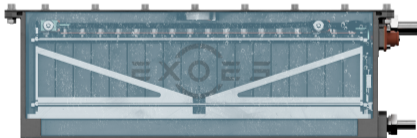

Multi-Fidelity Simulation and Uncertainty Quantification

Main PhD project overview (2018-2021)

- Numerical Simulation of Battery Thermal Management Systems (BTM) :
 - High-Fidelity Model (HF) : based on Computational Fluid Dynamics (CFD)
 - Low-Fidelity Model (LF) : "0D Model" based on energy balance equations
- Uncertainty Quantification Methods to take into account uncertainties related to BTM Systems.
- Multi-Fidelity numerical tool : coupling LF and HF models
 - Reduce computational costs
 - Perform UQ methods including High-Fidelity simulations

Multi-Fidelity Simulation and Uncertainty Quantification

Main PhD project overview (2018-2021)

- Numerical Simulation of Battery Thermal Management Systems (BTM) :
 - High-Fidelity Model (HF) : based on Computational Fluid Dynamics (CFD)
 - Low-Fidelity Model (LF) : "0D Model" based on energy balance equations
- Uncertainty Quantification Methods to take into account uncertainties related to BTM Systems.
- Multi-Fidelity numerical tool : coupling LF and HF models
 - Reduce of computational costs
 - Perform UQ methods including High-Fidelity simulations

Today's focus :
Performances Analysis of the LF Model with Uncertainty Quantification methods.

- 1 Industrial and Research Objectives
- 2 Battery Thermal Management System
- 3 Low-Fidelity Numerical Model
- 4 Numerical Simulation Under Uncertainty

The Exoes Battery Thermal Management System (BTMS)

Cooling Circuit

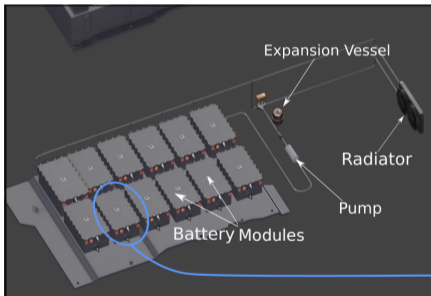

Battery Module

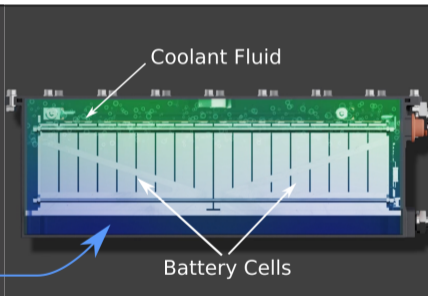

- 1 Industrial and Research Objectives
- 2 Battery Thermal Management System
- 3 Low-Fidelity Numerical Model
- 4 Numerical Simulation Under Uncertainty

The Low-Fidelity Model

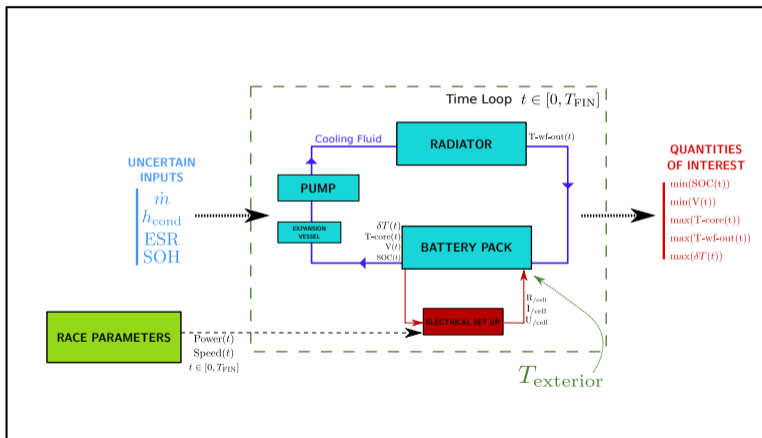

Case Study : Race

- Race duration : 20 minutes
- Maximal Power required by the electrical engine : 180 kW
- More than 70 accelerations and braking sequences.

What the LF model computes

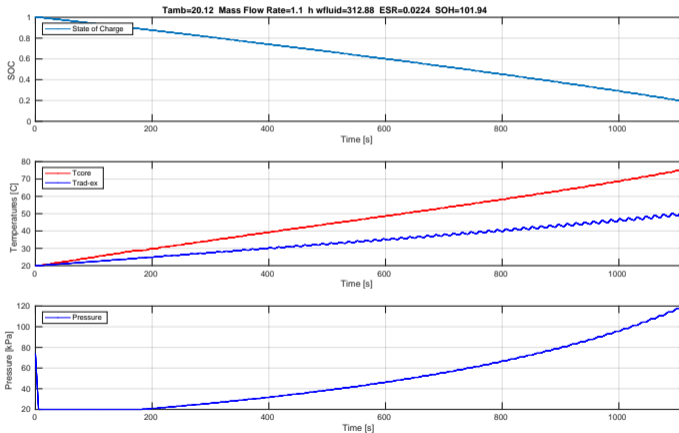

- 1 Industrial and Research Objectives
- 2 Battery Thermal Management System
- 3 Low-Fidelity Numerical Model
- 4 Numerical Simulation Under Uncertainty

Take Uncertainties Into Account

Choice of **4 uncertain parameters** : lack of knowledge to set an exact value.

x_1	Massic Flow Rate	\dot{m}	[1.08; 1.3]	$\text{kg}\cdot\text{s}^{-1}$
x_2	Heat Transfer Coefficient	h_{cond}	[250; 360]	$\text{W}\cdot\text{m}^{-2}\cdot\text{K}^{-1}$
x_3	Equivalent Serie Resistance	ESR	[0.01; 0.025]	Ω
x_4	State Of Health	SOH	[98; 102]	%

Take Uncertainties Into Account

Choice of **4 uncertain parameters** : lack of knowledge to set an exact value.

x_1	Massic Flow Rate	\dot{m}	[1.08; 1.3]	kg.s^{-1}
x_2	Heat Transfer Coefficient	h_{cond}	[250; 360]	$\text{W.m}^{-2}.\text{K}^{-1}$
x_3	Equivalent Serie Resistance	ESR	[0.01; 0.025]	Ω
x_4	State Of Health	SOH	[98; 102]	%

Goals of Uncertainty Propagation :

Estimate the **variability of the QOI** with respect to the **input parameters uncertainties**.
(Statistical moments, Quantiles, Sensitivity analysis, ...)

Uncertainty Characterization

STEP 1 : Sampling of the 4 uncertain inputs. N_S sample points following uniform distribution.

x_1	Massic Flow Rate	\dot{m}	[1.08; 1.3]	kg.s^{-1}
x_2	Heat Transfer Coefficient	h_{cond}	[250; 360]	$\text{W.m}^{-2}.\text{K}^{-1}$
x_3	Equivalent Serie Resistance	ESR	[0.01; 0.025]	Ω
x_4	State Of Health	SOH	[98; 102]	%

Uncertainty Propagation

STEP 2 : Perform N_S simulations with the Numerical Model, seen as a Black Box

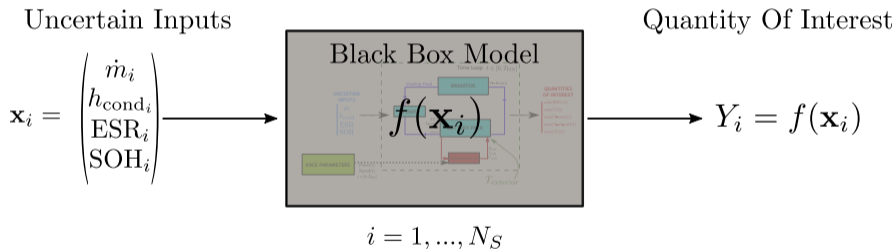

Uncertainty Propagation

STEP 3 : Compute the variability of the QOI with respect to the input uncertainties of the system

Uncertainty Propagation

STEP 3 : Compute the variability of the QOI with respect to the input uncertainties of the system

Distribution of the QOI $\max_{t \in [0, T_{FIN}]} (T_{center}(t))$, with 115 sampled points

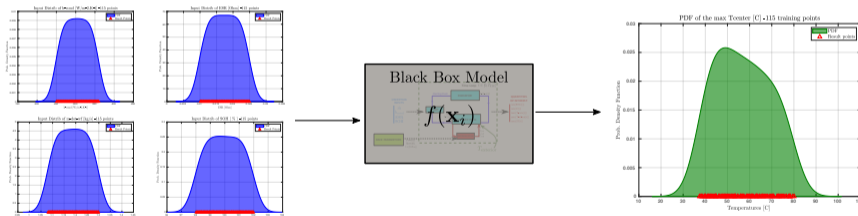

Uncertainty Propagation

STEP 3 : Compute the variability of the QOI with respect to the input uncertainties of the system

Distribution of the QOI $\max_{t \in [0, T_{FIN}]} (T_{center}(t))$, with 115 sampled points

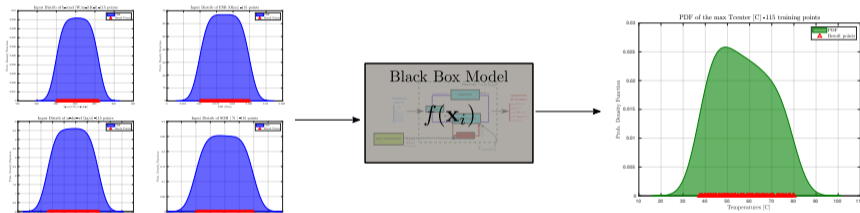

But 115 points is not enough to get accurate distribution.

Monte Carlo method too expensive with computational model $f(x)$.

Need to replace $f(x)$ by a fast-to-compute surrogate model

Kriging Surrogate Model

Need to replace $f(\mathbf{x})$ by a fast-to-compute **surrogate model**

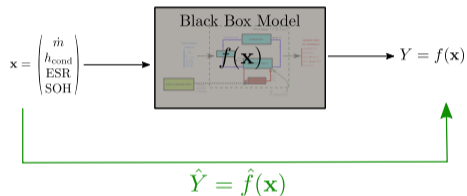

Kriging Based Surrogate Model

Based on Gaussian Process Regression

Compute an estimation $\hat{Y} = \hat{f}(\mathbf{x})$ of the QOI, **built on the 115 training samples from the numerical model $f(\mathbf{x})$**

Distributions of the QOI

Computation of the PDF for each QOI at $T_{amb} = 15^{\circ}C$
estimated with surrogate model

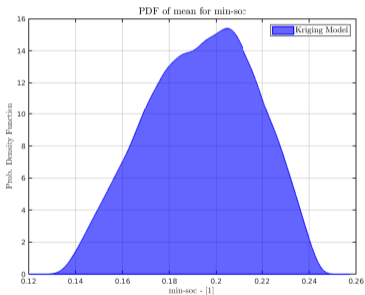

$$\min_{t \in [0, T_{FIN}]} (\text{SOC}(t))$$

COV = 11.99%

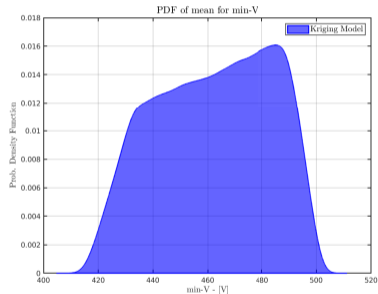

$$\min_{t \in [0, T_{FIN}]} (V(t))$$

COV = 4.54%

Distributions of the QOI

Computation of the PDF for each QOI at $T_{\text{amb}} = 15^{\circ}\text{C}$
estimated with surrogate model

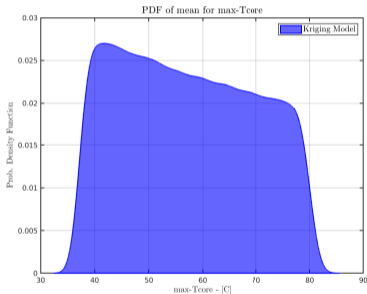

$$\max_{t \in [0, T_{\text{FIN}}]} (T_{\text{center}}(t))$$

COV = 21.49%

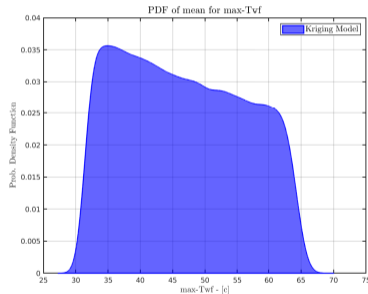

$$\max_{t \in [0, T_{\text{FIN}}]} (T_{\text{wf-out}}(t))$$

COV = 20.21%

Distributions of the QOI

Computation of the PDF for each QOI at $T_{\text{amb}} = 15^\circ\text{C}$
estimated with surrogate model

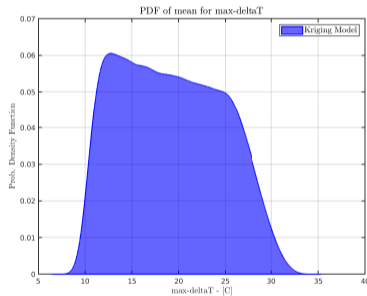

$$\max_{t \in [0, T_{\text{FIN}}]} (\delta T(t))$$

COV = 28.37%

Results for 2 different T_{exterior} scenarios

Comparison of the variability of some QOI for $T_{\text{exterior}} = 5^{\circ}\text{C}$ and $T_{\text{exterior}} = 15^{\circ}\text{C}$

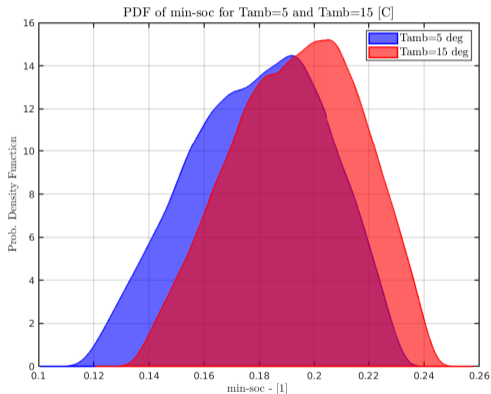

$$\min_{t \in [0, T_{\text{FIN}}]} (\text{SOC}(t))$$

Results for 2 different T_{exterior} scenarios

Comparison of the variability of some QOI for $T_{\text{exterior}} = 5^{\circ}\text{C}$ and $T_{\text{exterior}} = 15^{\circ}\text{C}$

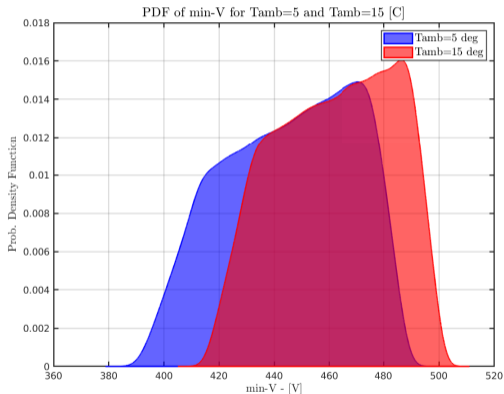

$$\min_{t \in [0, T_{\text{FIN}}]} (V(t))$$

Results for 2 different T_{exterior} scenarios

Comparison of the variability of some QOI for $T_{\text{exterior}} = 5^{\circ}\text{C}$ and $T_{\text{exterior}} = 15^{\circ}\text{C}$

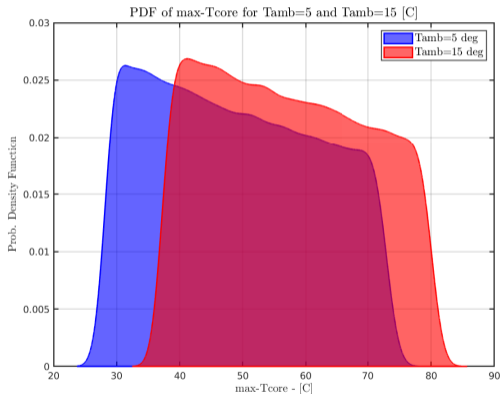

$$\max_{t \in [0, T_{\text{FIN}}]} (T_{\text{center}}(t))$$

Results for 2 different T_{exterior} scenarios

Comparison of the variability of some QOI for $T_{\text{exterior}} = 5^{\circ}\text{C}$ and $T_{\text{exterior}} = 15^{\circ}\text{C}$

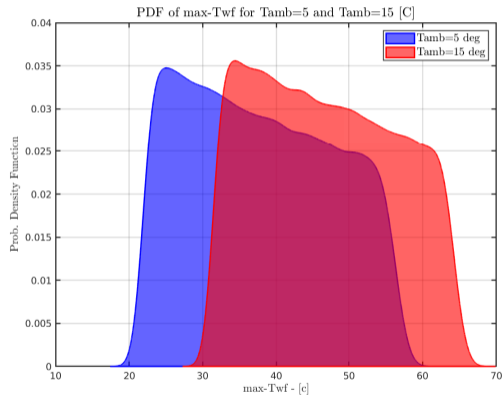

$$\max_{t \in [0, T_{\text{FIN}}]} (T_{\text{wf-out}}(t))$$

Results for 2 different T_{exterior} scenarios

Comparison of the variability of some QOI for $T_{\text{exterior}} = 5^{\circ}\text{C}$ and $T_{\text{exterior}} = 15^{\circ}\text{C}$

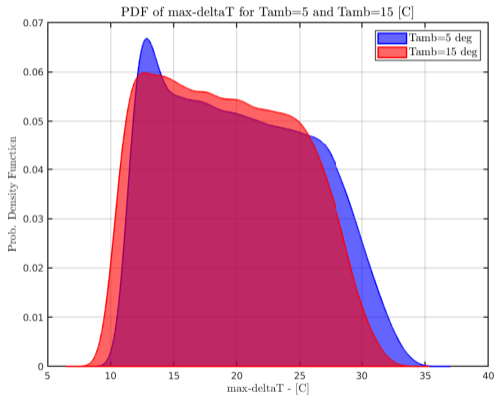

$$\max_{t \in [0, T_{\text{FIN}}]} (\delta T(t))$$

Sensitivity Analysis Study

Goal of Sensitivity Analysis :

Show which uncertain **input parameter** has the most **influence on the variability** of our quantity of interest.

→ Gain more knowledge about the behavior of a complex model.

Sensitivity Analysis Study

Show which uncertain **input parameter** has the most **influence on the variability** of our quantity of interest.

Mathematical Framework : ANOVA Decomposition

Analysis Of Variance

Input $\mathbf{x} = (x_1, x_2, x_3, x_4)$

Black-box numerical model f seen as :

$$f(\mathbf{x}) = \underbrace{f_0}_{\text{mean}} + \underbrace{\sum_{i=1}^4 f_i(x_i)}_{\text{first order}} + \underbrace{\sum_{i_1=1}^4 \sum_{i_2=i_1+1}^4 f_{i_1 i_2}(x_{i_1}, x_{i_2})}_{\text{second order}} + \dots + \underbrace{f_{1,\dots,4}(x_1, \dots, x_4)}_{\text{fourth order}}$$

Sobol Index for a QOI : $Y_{\text{QOI}} = f(\mathbf{x})$

Sensitivity Analysis Study

Show which uncertain **input parameter** has the most **influence on the variability** of our quantity of interest.

Mathematical Framework : ANOVA Decomposition

Sobol Index for a QOI : $Y_{\text{QOI}} = f(\mathbf{x})$

First Order Sobol Index for input x_i :

$$S_i = \frac{\text{Var}(\mathbb{E}[Y_{\text{QOI}} | x_i])}{\text{Var}(Y_{\text{QOI}})}$$

$\text{Var}(\mathbb{E}[Y_{\text{QOI}} | x_i])$ = variance of the mean value QOI "knowing" the input x_i

$\text{Var}(Y_{\text{QOI}})$ = main variance of the QOI

S_i quantifies the main effect of x_i on the contribution to the variance of Y_{QOI}

First Order Sobol Indices Results

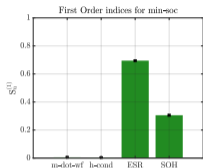

$$\min_t(\text{SOC}(t))$$

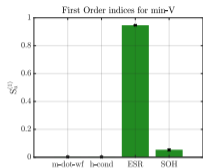

$$\min_t(V(t))$$

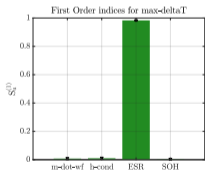

$$\max_t(\delta T_{\text{cell}}(t))$$

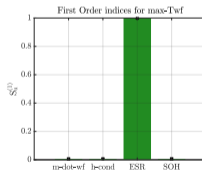

$$\max_t(T_{\text{wf-out}}(t))$$

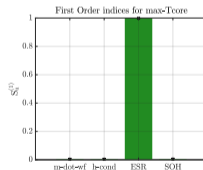

$$\max_t(T_{\text{center}}(t))$$

First Order Sobol Indices for each QOI (case $T_{\text{exterior}} = 15 \text{ } ^\circ\text{C}$)

What we learned from UQ Analysis

- Set up of a Low-Fidelity Model : gives an insight of the system behaviour with low computational costs
- Predicting the behaviour of the system while taking into account uncertainties on the physical input parameters
- Sensitivity Analysis gave robust estimation of the impact of some parameters on the Quantities Of Interest
 - ESR is the most determinant parameter for all QOI related to the temperature of the cells or the cooling fluid
 - SOH must not be neglected for minimal voltage of the cell

Perspectives

- From the results of Sensitivity Analysis : reduce the number of inputs, set-up simpler models
 - example : for $\max(T_{\text{center}}(t))$, get direct relationship between this QOI and ESR parameter
- Set up a High-Fidelity Model : based on CFD (Navier-Stokes + Energy Conservation 3D equations). Improve current simulations (influence of the geometry, find local heat spots on battery cells etc...).
- Represent the same physical case with HF model and LF model to perform multi-fidelity simulation of BTM Systems

Thank you for listening

`elie.solai@inria.fr`