



**HAL**  
open science

# Enhanced Flatbed Tow Truck Model Stable and Safe Platooning in the Presences of Lags, Communication and Sensing Delays

Alan Ali, Gaëtan Garcia, Philippe Martinet

► **To cite this version:**

Alan Ali, Gaëtan Garcia, Philippe Martinet. Enhanced Flatbed Tow Truck Model Stable and Safe Platooning in the Presences of Lags, Communication and Sensing Delays. GTAA (Groupe de Travail GdR MACS Automatique et automobile), Jun 2015, Nantes, France. hal-02459407

**HAL Id: hal-02459407**

**<https://inria.hal.science/hal-02459407v1>**

Submitted on 29 Jan 2020

**HAL** is a multi-disciplinary open access archive for the deposit and dissemination of scientific research documents, whether they are published or not. The documents may come from teaching and research institutions in France or abroad, or from public or private research centers.

L'archive ouverte pluridisciplinaire **HAL**, est destinée au dépôt et à la diffusion de documents scientifiques de niveau recherche, publiés ou non, émanant des établissements d'enseignement et de recherche français ou étrangers, des laboratoires publics ou privés.

# Enhanced Flatbed Tow Truck Model

*Stable and Safe Platooning in the Presences of Lags, Communication and Sensing Delays*

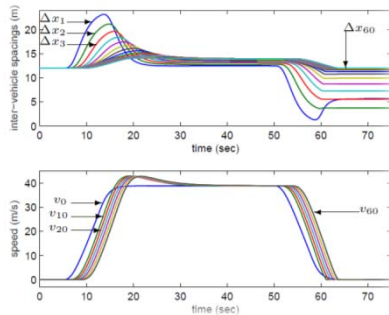

Alan ALI  
Gaëtan GARCIA  
Philippe MARTINET



GTAA 04/06/2015  
Nantes, France

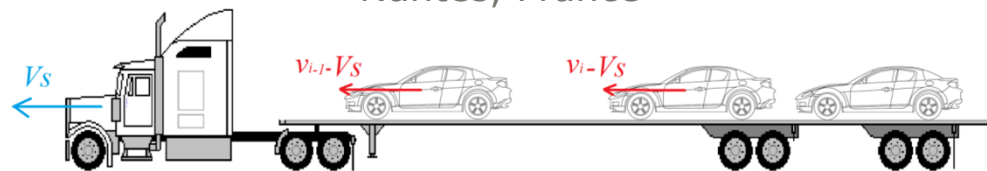

# Problematic

- Traffic congestion



## Buses:

- Not Flexible (destination).
- No privacy.
- Need wide roads.
- **Reduce congestion.**
- Cheap.



## Private cars:

- Flexible (destination).
- Full privacy.
- Small unit size.
- **Increase congestion.**
- Expansive.

## Solution



- Flexible (destination, size).
- No need for wide roads.
- Increases road density .
- Reduces congestion.
- Safer (human factor, speed)
- Reduces fuel consumption

# INDEX

- I. Introduction
- II. Modeling:
  - Vehicle,
  - Platoon
- III. Control
- IV. Stability
- V. Safety
- VI. Simulation
- VII. Conclusion

# I. Introduction

- **Platoon:**
  - Vehicles following each other.
  - The leader:
    - Real or virtual
    - Driven manually or automatically.
  - Other vehicles:
    - Following each other and moving at the same speed
    - Keeping desired distance.

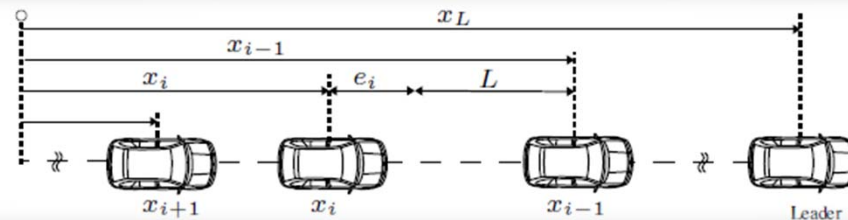

# I. Introduction

- **Why platooning:**

- Increases traffic density,
- Increases safety:
  - Weak collision (Small relative velocity),
  - No human factor,
  - Small reaction time,
- decreases fuel consumption,
- decreases driver tiredness,

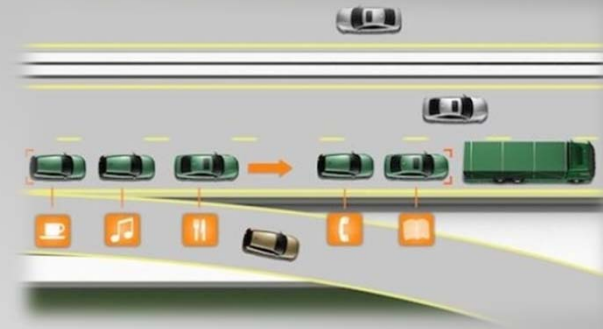

*Photo courtesy of Daimler Chrysler*



# I. Introduction

- **Global Control and Local Control :**
  - **Data** (at least from leader, adjacent vehicles)
  - **Sophisticated sensors** (needed, Not needed).
  - **Environment adaptation** (Maybe, Not needed)
  - **Communication system** (need very reliable, no)
  - **Trajectory tracking** and inter distance keeping (accurate , Not very accurate)
  - ***Autonomous (No, Yes).***



# I. Introduction

- **Variable inter-vehicle distances :**

- The distance is not fix (e.g. proportional to velocity in (CTH) Constant Time Headway policy)
- Low traffic density.
- Stable without communication.
- The cars can work autonomously.

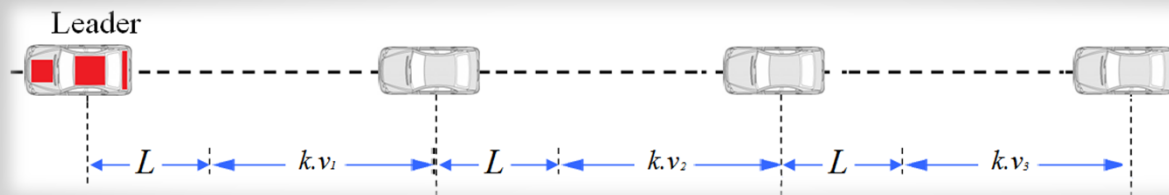

Inter-vehicle distance

$$\Delta X = L + hv_i$$

- **Constants inter-vehicle distances:**

- High traffic density.
- The communication between vehicles is mandatory.

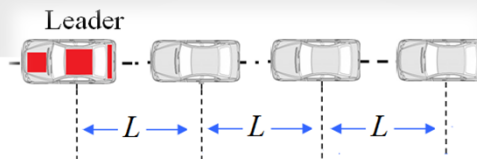

$$\Delta X = L$$



# Platooning

Constant spacing and Variable spacing

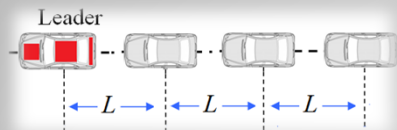

$$\Delta X = L$$

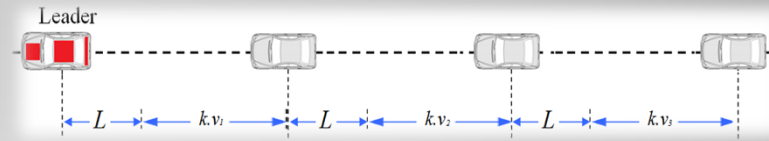

$$\Delta X = L + h v_i$$

High traffic density ← → low  
 mandatory ← → Communication ← → Not important

- Our proposition [3]:

**High** traffic density with  
**low Communication** rate

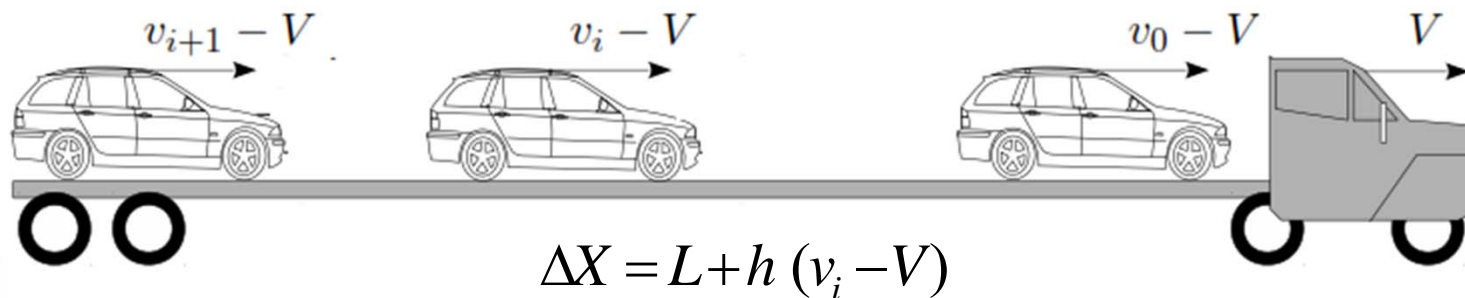

$$\Delta X = L + h (v_i - V)$$

# I. Introduction

- **The proposed model and law:**
  - We proposed in [3] the flatbed tow truck model,
  - Inter-vehicle distances become proportional to relative velocities instead of absolute velocities.
  - The inter-vehicle distances decrease **largely**,
  - Low communication rate is needed (transmit  $V$ ),

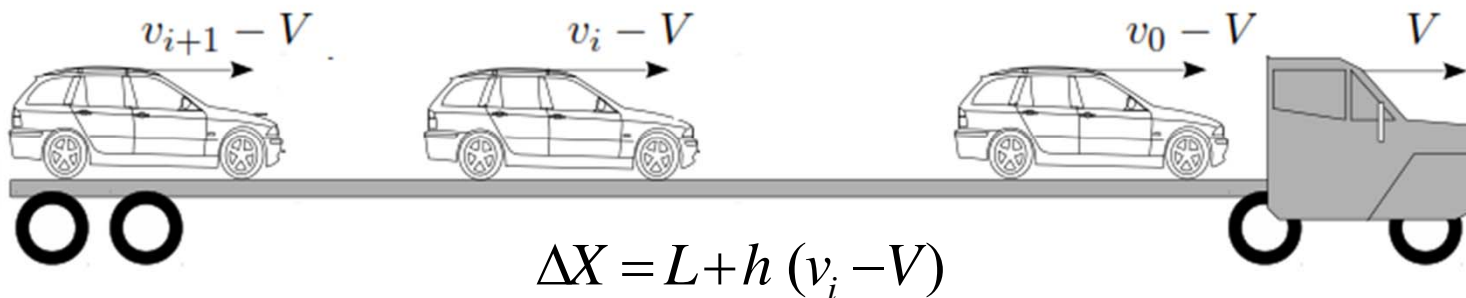

# I. Introduction

- **The proposed model and law:**
  - Actuators lags, sensing and communication delays may cause instability.

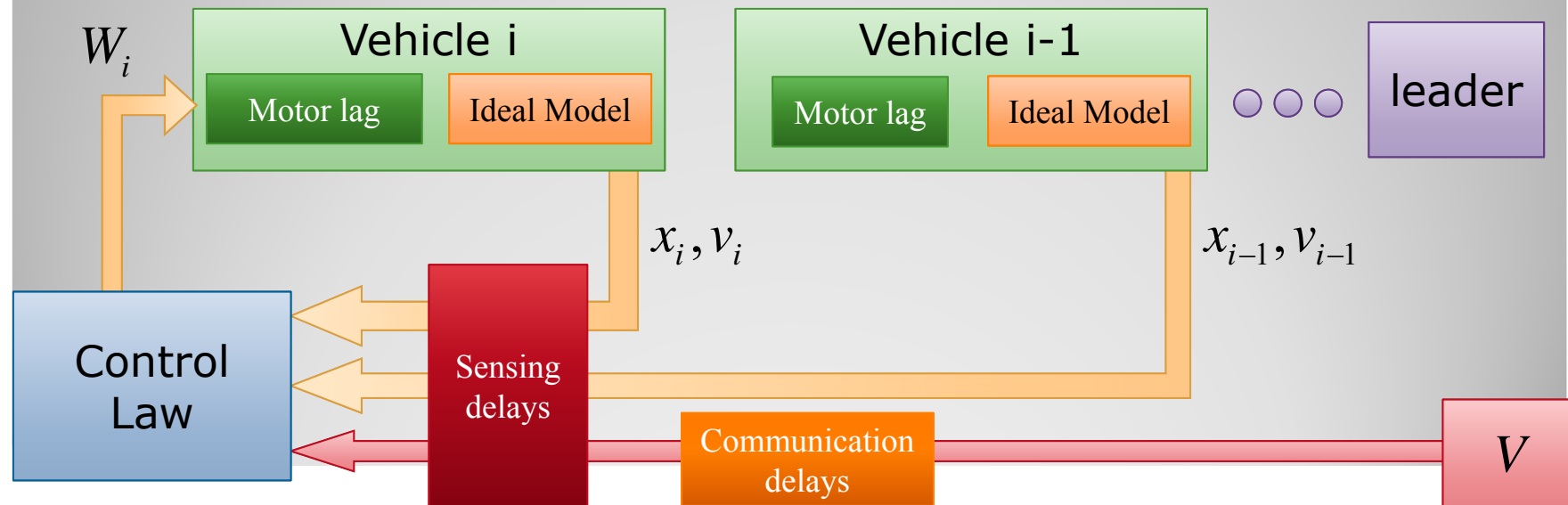

# Objective:

## • Robustness of the control law:



- In the literatures, communication delays make platoons unstable [],
- We study the effects of lags and delays on stability and safety of homogeneous platoons,

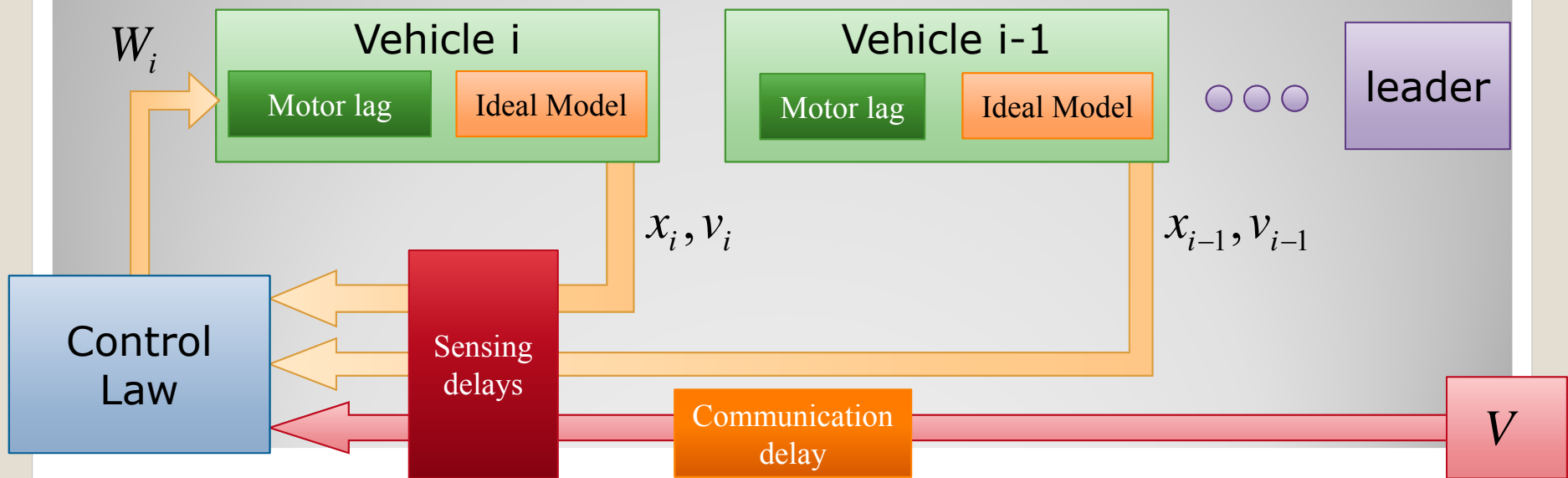

# I. Introduction

- **State of the art:**

- Platoon with actuators **lags** and **sensing delays**:

- Stability can be assured [8,9,14,17].
- The time headway policy is more robust than the constant spacing policy.

- Platoon with **communication** delays:

- platoon stability can be obtained in presence of the same communication delay for all the vehicles [8].



- **No** stability in presence of **propagation** delay in the leader information [7].

- **Practically**, previous result represents an over constrained condition (i.e. instability is only caused by applying non-eliminating positive (or negative) acceleration),

- We proved the stability in presence of all previous delays.

## II. Modeling (vehicle)

- Newton's law,

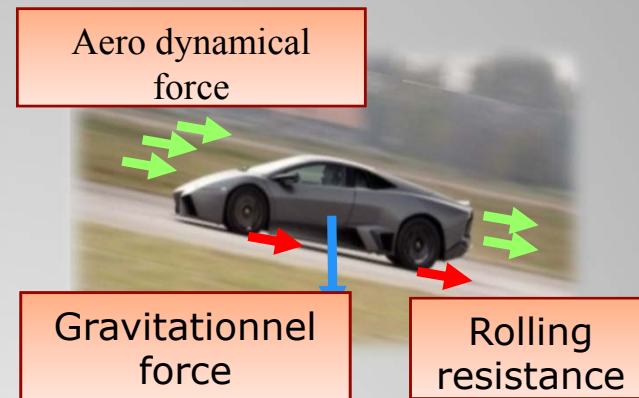

- Applying the exact linearization system,

$$\ddot{x} = W$$

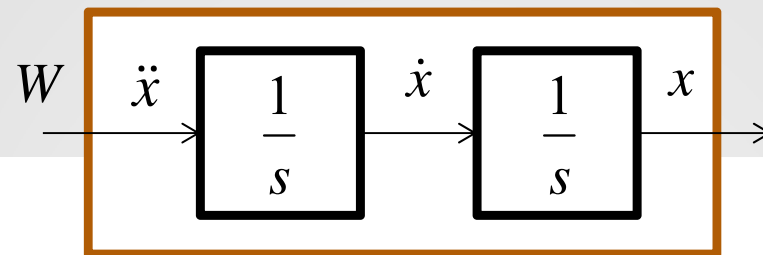

# II. Modeling (Platoon)

- **Definitions:**

- L: desired inter distance,
- V: shared velocity,
- $x_i, v_i$  Position and speed of the i-th vehicle
- $e_i = x_{i-1} - x_i - L$  the i-th spacing error,

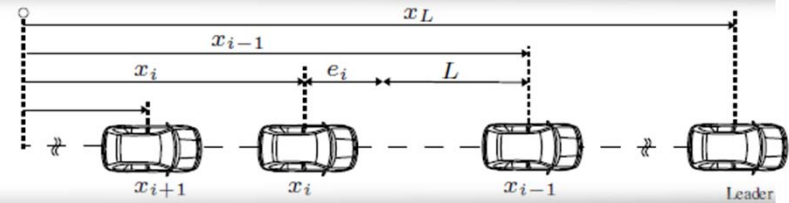

- $X_V$  the position of the virtual truck,

- **Flatbed tow truck model:**

- Unidirectional spring-damper model,
- With virtual truck running at a speed V.

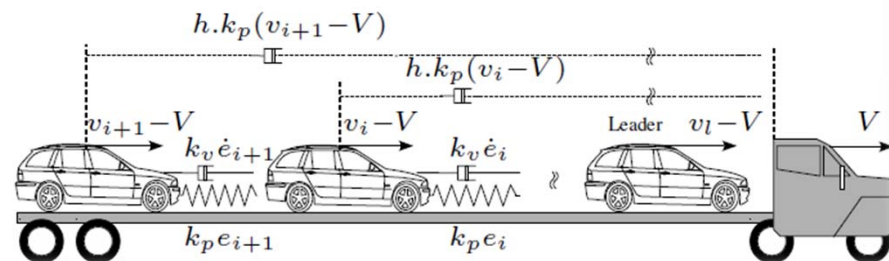



# III. Control

- **Control Objectives:**
  - Keep a desired distance between the vehicles,
  - Make the vehicles move at the same speed,
  - Ensure vehicles and platoon stability [1-3],
  - Control on highways [1,3] and in urban areas [2,5],
  - Ensure vehicles and platoon safety [3,4,5,6],
  - Increase traffic density,
  - Ensure the stability and safety even in case of:
    - Entire communication loss between vehicles [4],
    - **Existence of actuating lags, sensing and communication delays [6,current work].**
  - Study non-homogenous platoons [6],

# III. Control

- Control law (classical CTH):

$$W_i(t) = \frac{\dot{e}_i + \lambda \delta_i}{h}$$

$$\delta_i = e_i - \lambda h v_i$$

$\lambda, h$  Control parameters

- Proposed control law (enhanced CTH):

$$W_i(t) = \frac{\dot{e}_i + \lambda \delta_i + \lambda_1 e_V}{h}$$

$$\delta_i = e_i - \lambda h (v_i - V)$$

$$e_V = X_V - x_i - L_V$$

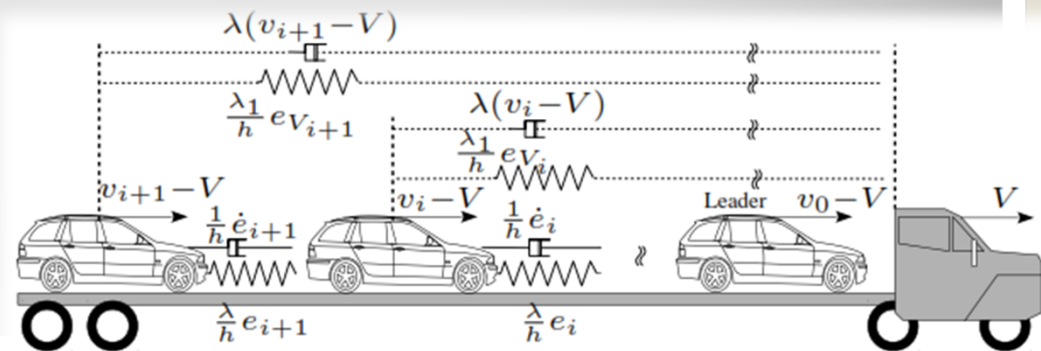
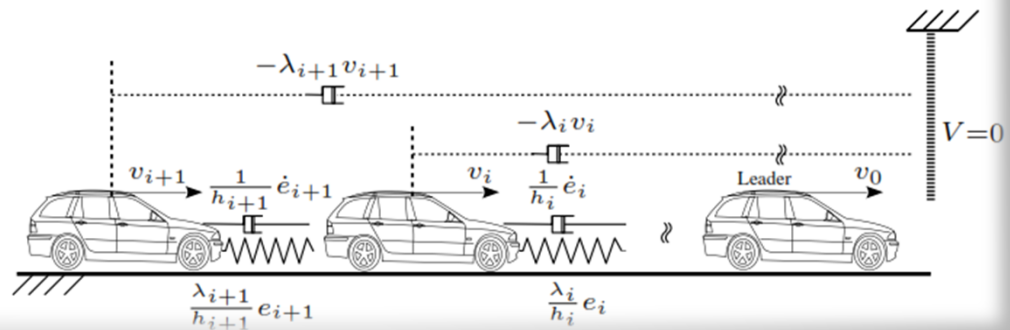

# III. Control

- Control law **without** delays:

$$W_i(t) = \ddot{x}_i(t) = \frac{\dot{e}_i(t) + \lambda \delta_i + \lambda_1 e_V(t)}{h}$$

$$\delta_i(t) = e_i(t) - \lambda h (v_i(t) - V(t))$$

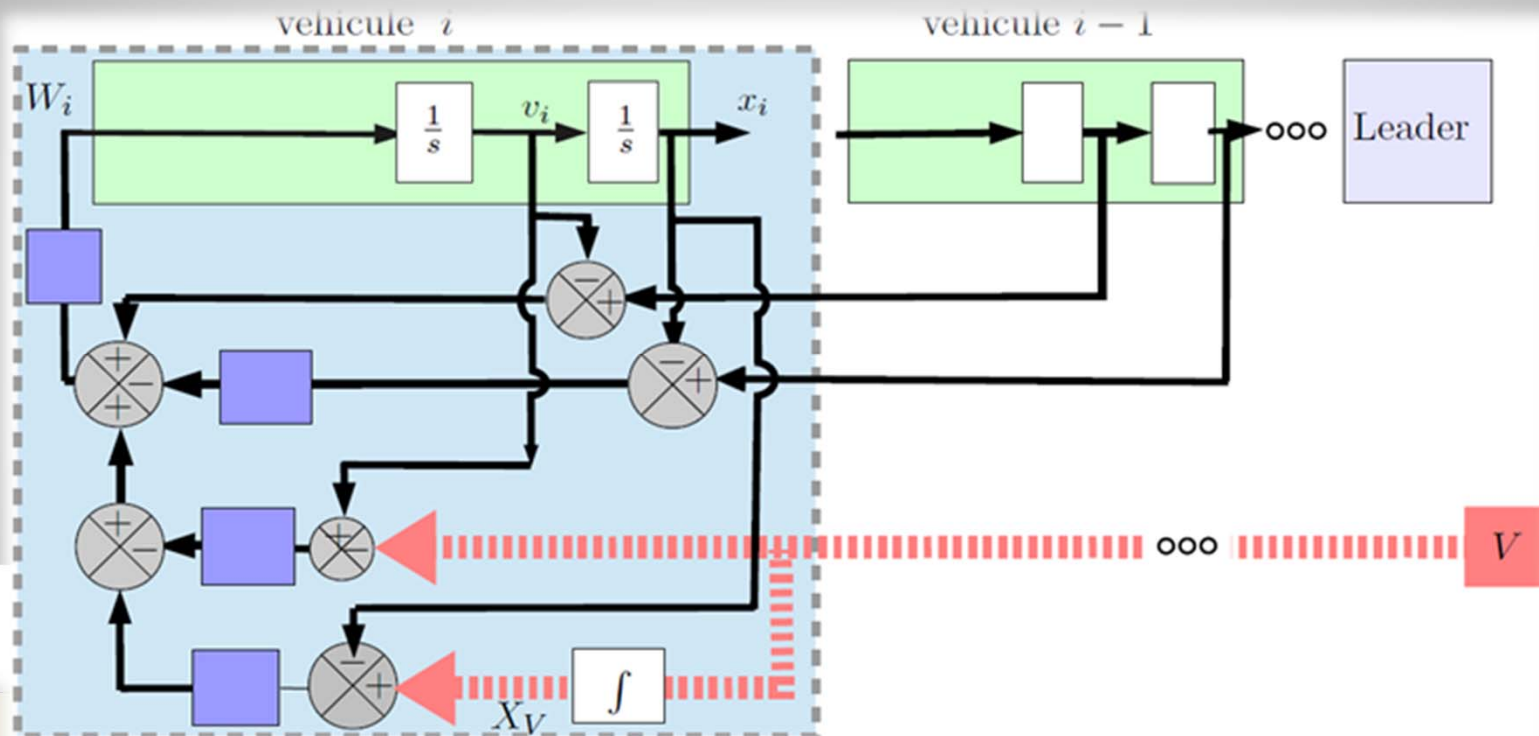

# III. Control

- Control law **with** delays (homogenous):

$$\tau \ddot{x}(t) + \dot{x}(t) = \frac{\dot{e}(t - \Delta) + \lambda \delta_i(t, \tau_{c_i}, \Delta) + \lambda_1 e_V(t, \tau_{c_i}, \Delta)}{h}$$

$$\delta_i(t, \tau_{c_i}, \Delta_i) = e_i(t - \Delta) - h [v_i(t - \Delta) - V(t - (\Delta + \tau_{c_i}))]$$

$$e_V(t, \tau_{c_i}, \Delta) = X_V(t - (\Delta + \tau_{c_i})) - x_i(t - (t - \Delta)) - L_V$$

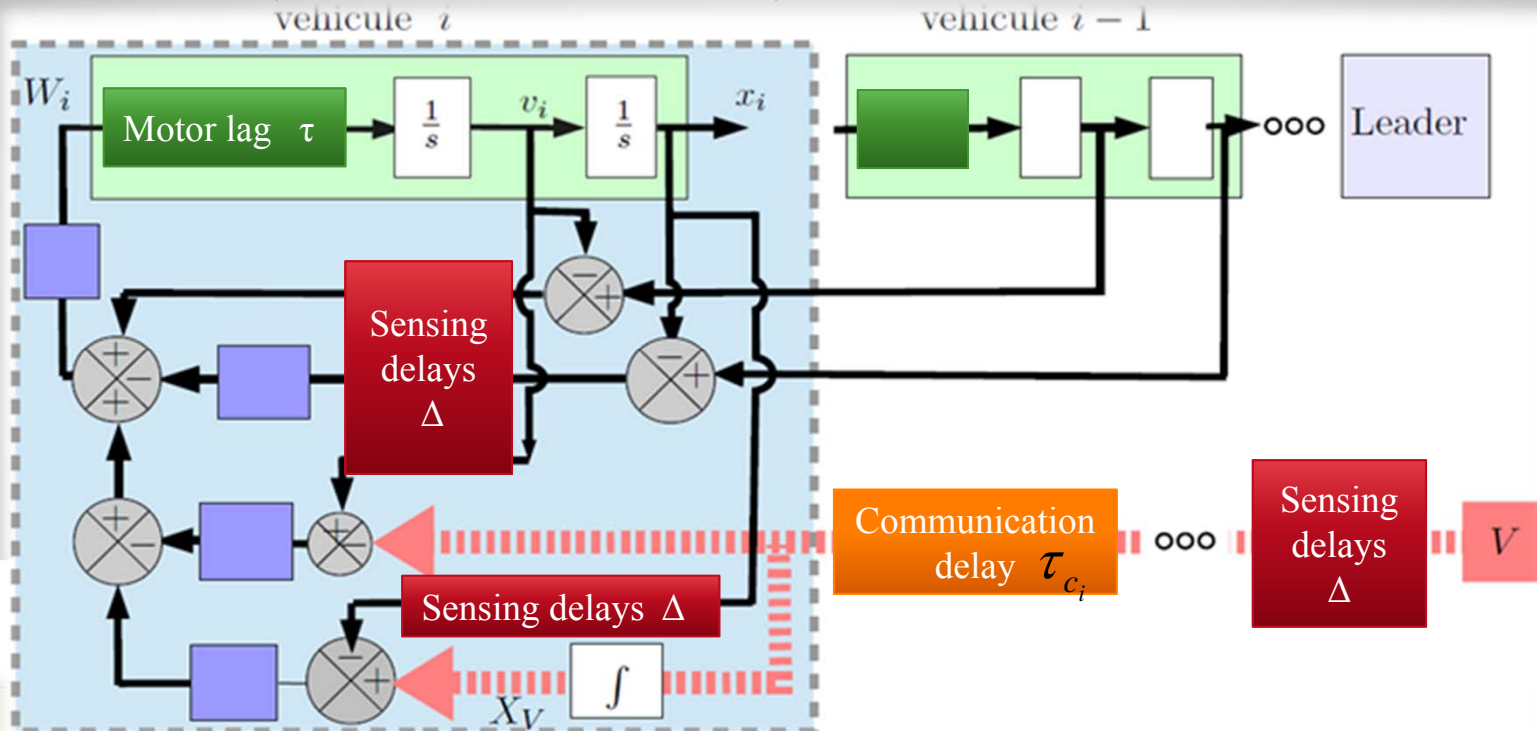

## IV. Stability

- **Platoon stability (string stability):**

- The platoon is stable when all the spacing errors are bounded if the initial states are bounded.
- We find Laplace function of the  $i$ -th error  $E_i(s)$ :

$$E_i(s) = G_e(s) E_{i-1}(s) + G_V(s) e^{-\tau_{c_i}s} V(s)$$

- $G_x(s)$  are transfer functions,
- The first error is given by:

$$E_1(s) = F_e(s) V_0(s) + F_V(s) V(s)$$

- $V_0(s), V(s)$  the Laplace function of leader and truck speed,
- We want to make the error is limited so that

$$\|e_i\|_{\infty} < \alpha, \text{ where } \alpha < \infty, \quad i = 1 \dots N$$

## IV. Stability

- We find  $E_i(s)$  as a function of the first error:

$$E_i(s) = G_e^{i-1}(s) E_1(s) + G_m(s) V(s)$$

- For any positive function  $g(t)$ , if  $G(s)$  is its Laplace function then we have:

$$\|G(\omega)\|_{\infty} = \|g(t)\|_1$$

- For any linear system  $Y(s) = G(s) U(s)$  we always have:

$$\|y(t)\|_{\infty} \leq \|g(t)\|_1 \|u(t)\|_{\infty}$$

- So for the first error we get:

$$\|e_1(t)\|_{\infty} \leq \|F_e(\omega)\|_{\infty} \|V_0(t)\|_{\infty} + \|F_V(\omega)\|_{\infty} \|V(t)\|_{\infty}$$

- Practically  $\|V_0(t)\|_{\infty}, \|V(t)\|_{\infty}$  are limited, so to make  $e_1(t)$  limited it is sufficient to make  $\|F_e(\omega)\|_{\infty}, \|F_V(\omega)\|_{\infty}$  limited

## IV. Stability

- For the  $i$ -th error we get:

$$\|e_i(t)\|_\infty \leq \|G_e(\omega)\|_\infty^{i-1} \|e_1(t)\|_\infty + \|G_m(\omega)\|_\infty \|V(t)\|_\infty$$

- We already made  $e_1$  limited, and  $\|V(t)\|_\infty$  is practically limited, so to prove that the  $i$ -th error is limited it is sufficient to prove that  $\|G_m(\omega)\|_\infty$  is limited and  $\|G_e(\omega)\|_\infty \leq 1$ .
- This give us **stability conditions** of the platoon **in presence** of actuation **lags**, sensing and communication **delays**.
- This mean that we can get stable platoon even with propagation delays (contrary to the results in [7])



## V. Safety

- The inter-vehicle distances must be always bigger than zero. This can be ensured by limiting the maximum error:

$$\|e_i(t)\|_{\infty} \leq L \quad i = 1, \dots, N$$

- $e_1$  and  $e_i$  are given by:

$$E_1(s) = K_V(s) A_V(s) + G_V(s) V(s)$$

$$E_i(s) = G_V(s) E_{i-1}(s) + G_V(s) V(s)$$

## V. Safety

- So we apply safety condition on  $e_1$  and  $e_i$  :

$$\|e_1(t)\|_\infty = \|K_V(s)\|_\infty \|a_V(t)\|_\infty + \|G_V(s)\|_\infty \|V(t)\|_\infty \leq L$$

$$\|e_i(t)\|_\infty = \|G_V(s)\|_\infty \|e_{i-1}(t)\|_\infty + \|G_V(s)\|_\infty \|V(t)\|_\infty \leq L$$

- This give us safety conditions in presence of lags and delays.

## VI .Simulation

- Simulation was done using Matlab,
- Large platoon (60 identical vehicles) is created to check error amplification for vehicle with large indexes.
- The platoon moves on straight road.
- Desired inter-vehicle distance  $L=12m$ .
- Lag  $\tau = 200 \text{ ms}$ , sensing delay  $\Delta = 200 \text{ ms}$  and propagation delay  $\tau_{c_i} - \tau_{c_{i-1}} = 50 \text{ ms}$  for  $i > 2$
- Simulation scenarios:
  - Platoon creation from stationary,
  - Increasing the speed with maximal acceleration ( $5m/s^2$ ),
  - Moving on fixed speed (140km/h),
  - Hard braking,

## VI. Simulation

- For clarity, we only show the speed of one of ten vehicles,
- The platoon is stable (the errors are decreasing),
- The platoon is safe (inter-vehicle distances are always bigger than zero),

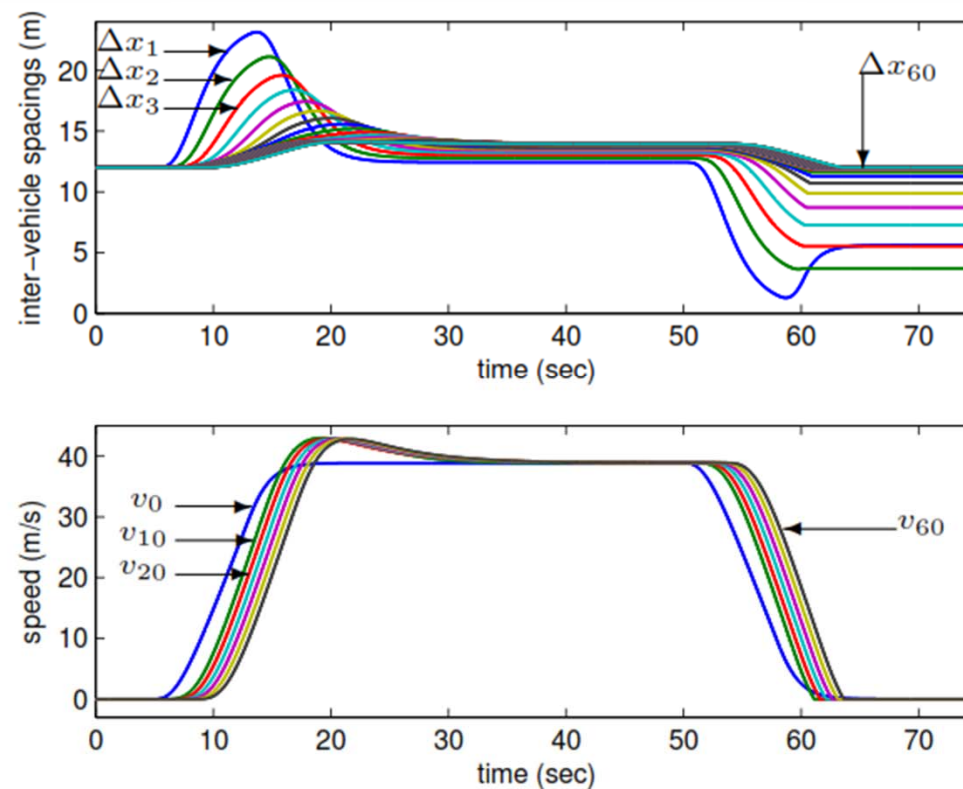

## VII. Conclusion et Perspective

- Highways platooning is addressed,
- Enhanced CTH is used,
- Stability and Safety conditions, in presence of lags and delays, were found,
- Verified by simulations in critical scenarios.

## VII. Conclusion et Perspective

- **In the coming works we will:**
  - Study non homogenous platoons [6],
  - Study more complex
    - delay's model (sensing delays different for the same vehicle)
    - and vehicle model (take motor model into account).
  - Take into account passenger comfort,
  - Make real experiments.

**Thanks for listening**



# References

- [1] A. Ali, G. Garcia, and P. Martinet, **Minimizing the inter-vehicle distances of the time headway policy for platoons control in highways**, 10<sup>th</sup> International Conference on Informatics in Control, Automation and Robotics, ICINCO, pp. 417-424. Reykjavik, Iceland, July 29-31, 2013.
- [2] A. Ali, G. Garcia, and P. Martinet, **Minimizing the inter-vehicle distances of the time headway policy for urban platoon control with decoupled longitudinal and lateral control**, 16th International IEEE Conference on Intelligent Transportation Systems - (ITSC), pp. 1805-1810, The Hague, The Netherlands, 6-9 Oct. 2013.
- [3] A. Ali, G. Garcia, and P. Martinet, **The flatbed platoon towing model for safe and dense platooning on highways**, Special issue on Perception and Planning for Autonomous Vehicles, IEEE Intelligent Transportation Systems Magazine, Vol. 7, N°1, pp. 58-68, spring 2015.
- [4] A. Ali, G. Garcia, and P. Martinet, **Safe platooning in the event of communication loss using flatbed tow truck model**, Conference on Control, Automation, Robotics and Vision, ICARCV 2014, pp. 1644-1649, Singapore, 10-12th Dec. 2014.
- [5] A. Ali, G. Garcia, P. Martinet, **Urban Platooning Using a Flatbed Tow Truck Model**, Intelligent Vehicle Symposium, IV 2015, Seoul, South Korea, June 28th - July 1st, 2015.
- [6] A. Ali, G. Garcia, P. Martinet, **String Stability of Platoons in Presences of Lags, Sensing and Communication Delays Using Flatbed Tow Truck Model**, will be submitted to IEEE transaction.

# References

- [7] Hedrick, J. K.; Chen, Y. and Mahal, S., **Optimized Vehicle Control/Communication Interaction in an Automated Highway System**, Institute of Transportation Studies, Research Reports, Working Papers, Institute of Transportation Studies, UC Berkeley.2001
- [8] Ling-yun, Xiao and Feng, Gao, **Effect of information delay on string stability of platoon of automated vehicles under typical information frameworks**, Journal of Central South University of Technology, Vol.17, no.6, pp 1271-1278, Dec.2010
- [9] Lingyun, Xiao; Darbha, S. and Feng, Gao, **Stability of String of Adaptive Cruise Control Vehicles with Parasitic Delays and Lags**, 11<sup>th</sup> International IEEE Conference on Intelligent Transportation Systems ITSC 2008, vol., no., pp.1101,1106, 12-15 Oct. 2008.
- [14] Swaroop, D. and Rajagopal, K., **A review of constant time headway policy for automatic vehicle following**. In Proceedings IEEE Intelligent Transportation Systems, pp. 65-69, 2001.
- [17] Yanakiev, D. and Kanellakopoulos, Ioannis, **Longitudinal control of automated CHVs with significant actuator delays**, IEEE Transactions on Vehicular Technology, vol.50, no.5, pp.1289,1297, Sep 2001