



HAL
open science

A Vocal Learning Model: Development And Analysis

Silvia Pagliarini, Arthur Leblois, Xavier Hinaut

► **To cite this version:**

Silvia Pagliarini, Arthur Leblois, Xavier Hinaut. A Vocal Learning Model: Development And Analysis. IMOL 2019 - Fourth International Workshop on Intrinsically Motivated Open-ended Learning, Jul 2019, Frankfurt, Germany. hal-02413140

HAL Id: hal-02413140

<https://inria.hal.science/hal-02413140>

Submitted on 16 Dec 2019

HAL is a multi-disciplinary open access archive for the deposit and dissemination of scientific research documents, whether they are published or not. The documents may come from teaching and research institutions in France or abroad, or from public or private research centers.

L'archive ouverte pluridisciplinaire **HAL**, est destinée au dépôt et à la diffusion de documents scientifiques de niveau recherche, publiés ou non, émanant des établissements d'enseignement et de recherche français ou étrangers, des laboratoires publics ou privés.



A Vocal Learning Model: Development And Analysis

Silvia Pagliarini^{1,2,3}, Arthur Leblois³, Xavier Hinaut^{1,2,3}

- 1) Mnemosyne, Inria Bordeaux Sud-Ouest, UMR 5800, CNR, Bordeaux INP, Talence, France
- 2) LaBRI, UMR 5800, CNRS, University of Bordeaux, Talence, France
- 3) IMN, UMR 5293, CNRS, University of Bordeaux, Bordeaux, France



AIM: build a vocal learning model underlying song learning in birds, and understand how to make it biologically plausible.

VOCAL LEARNING IN BIRDS

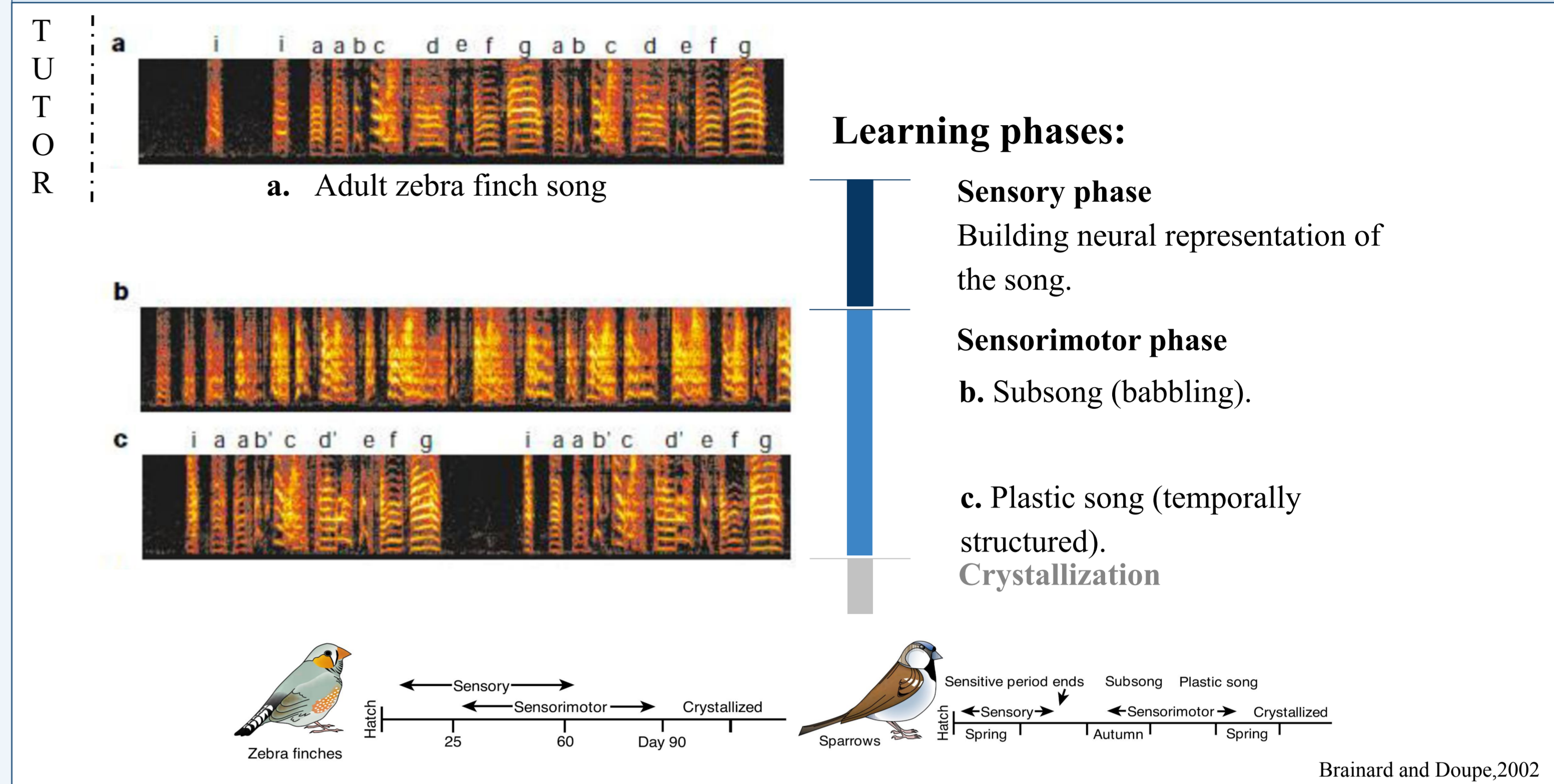

INTRODUCTION

KEYWORDS

Sensorimotor learning: control problem which maps a sensory input into a motor output.

Imitation: the ability to replicate another's behaviour, i.e. to generate an appropriate motor command to reproduce a sensory stimulus.

Inverse model learning: use the desired and actual motor configuration to estimate the motor commands needed to reach the desired configuration (to produce the appropriate sensory stimulus).

Reinforcement learning: learn an action policy to maximize the expected reward (which encode the goal of the learning).



Da Cunha et al., 2010

SENSORIMOTOR MODEL COMPONENTS [1]

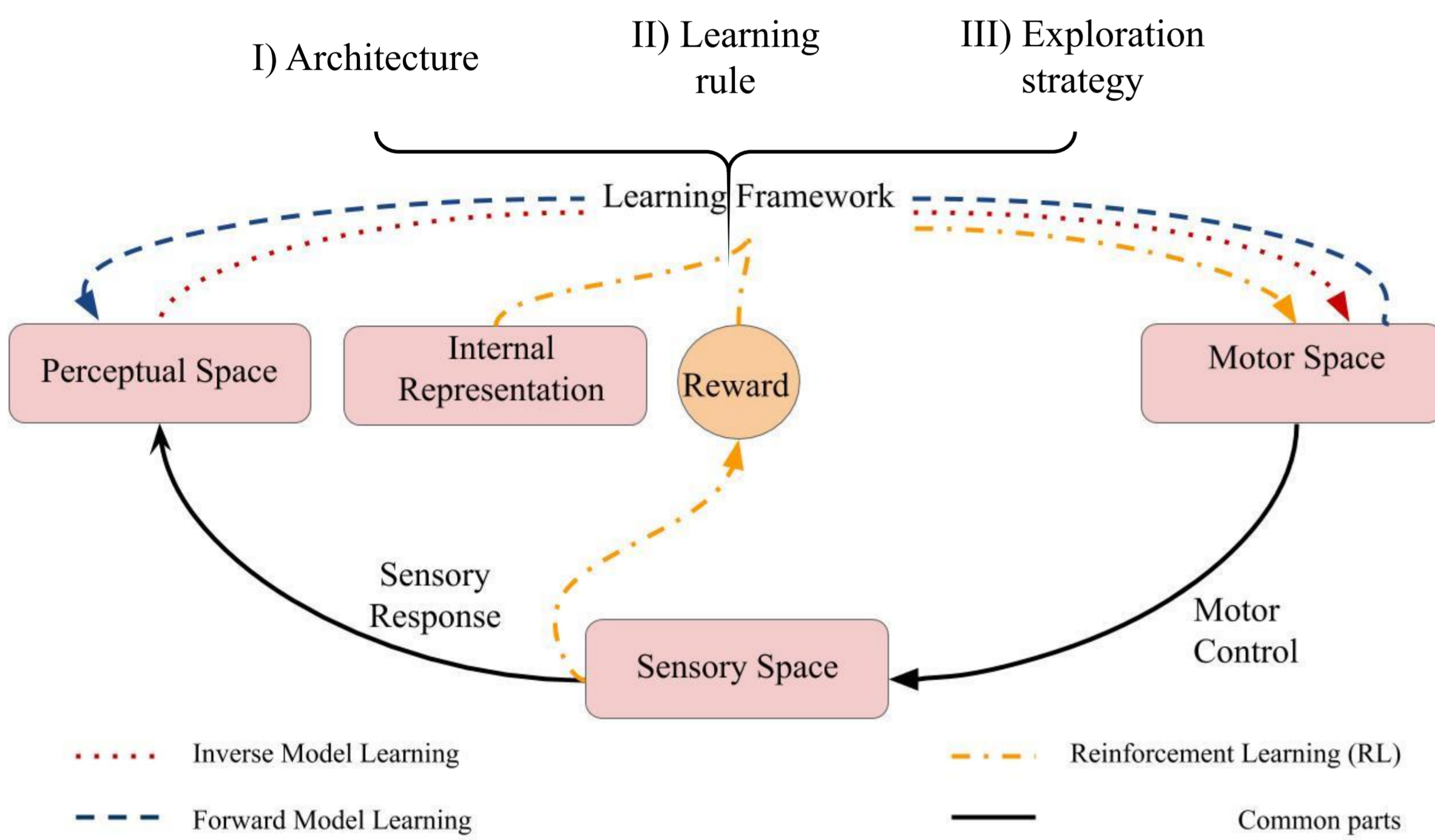

Motor control model

- Respiratory system and vocal organs.
- Anatomical properties and small size of birds make the investigation of vocal fold mechanisms difficult.
- The vocal output is driven by a complex gesture-dependent control scheme, and the brain does not control each motor control parameter independently [2].

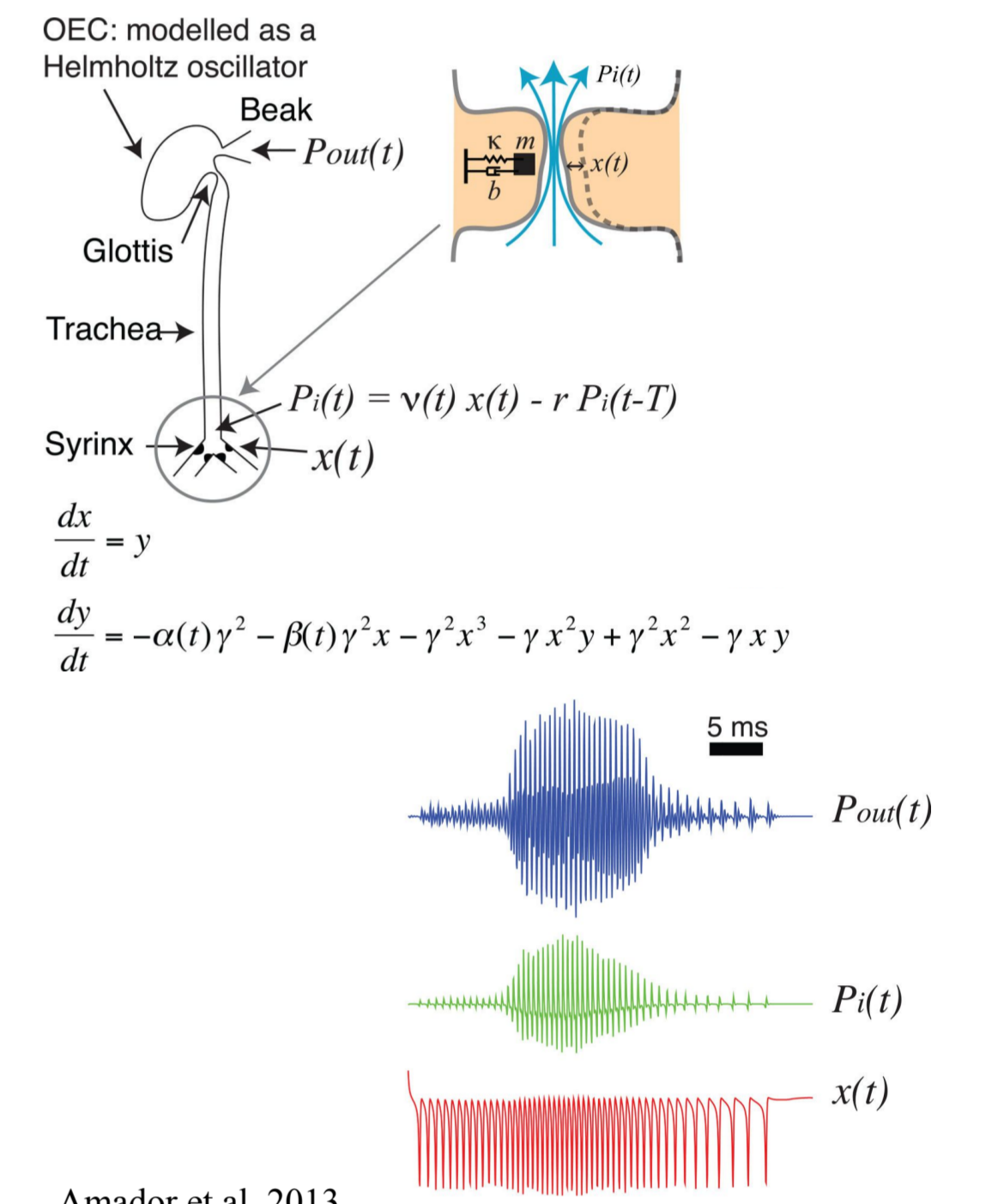

Perceptual space

- How the brain encodes sensory stimulus.
- Highly nonlinear dynamics.
- Low dimensional representation of the sensory space.

MOTOR CONTROL MODEL

AIM: learn the semantic modes in high-dimensional audio signals, and build a latent space useful for exploration. In addition, have sound production in the model.

WaveGAN [3]

- Two player minimax game: generator VS discriminator [4].
- Inspired by DCGAN architecture [5].

GENERATOR

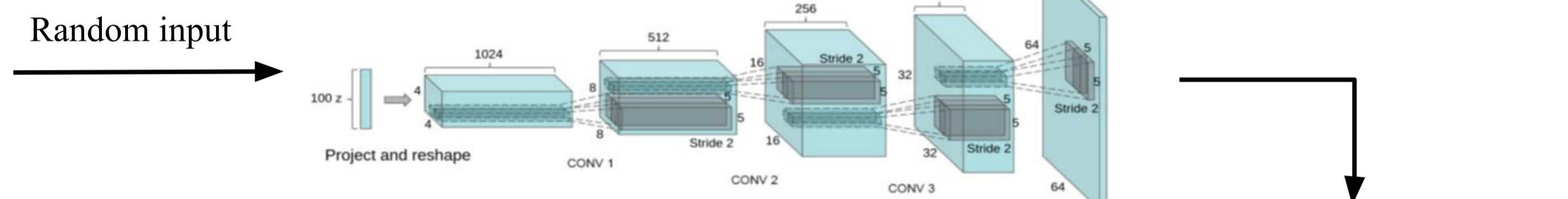

GENERATED SOUND DURING TRAINING

- Batch size = 64
- Epochs = 1662

DATASET

- Recordings from an adult zebra finch with sampling rate 44100.
- Downsampled single syllables. N = 4946 syllables.

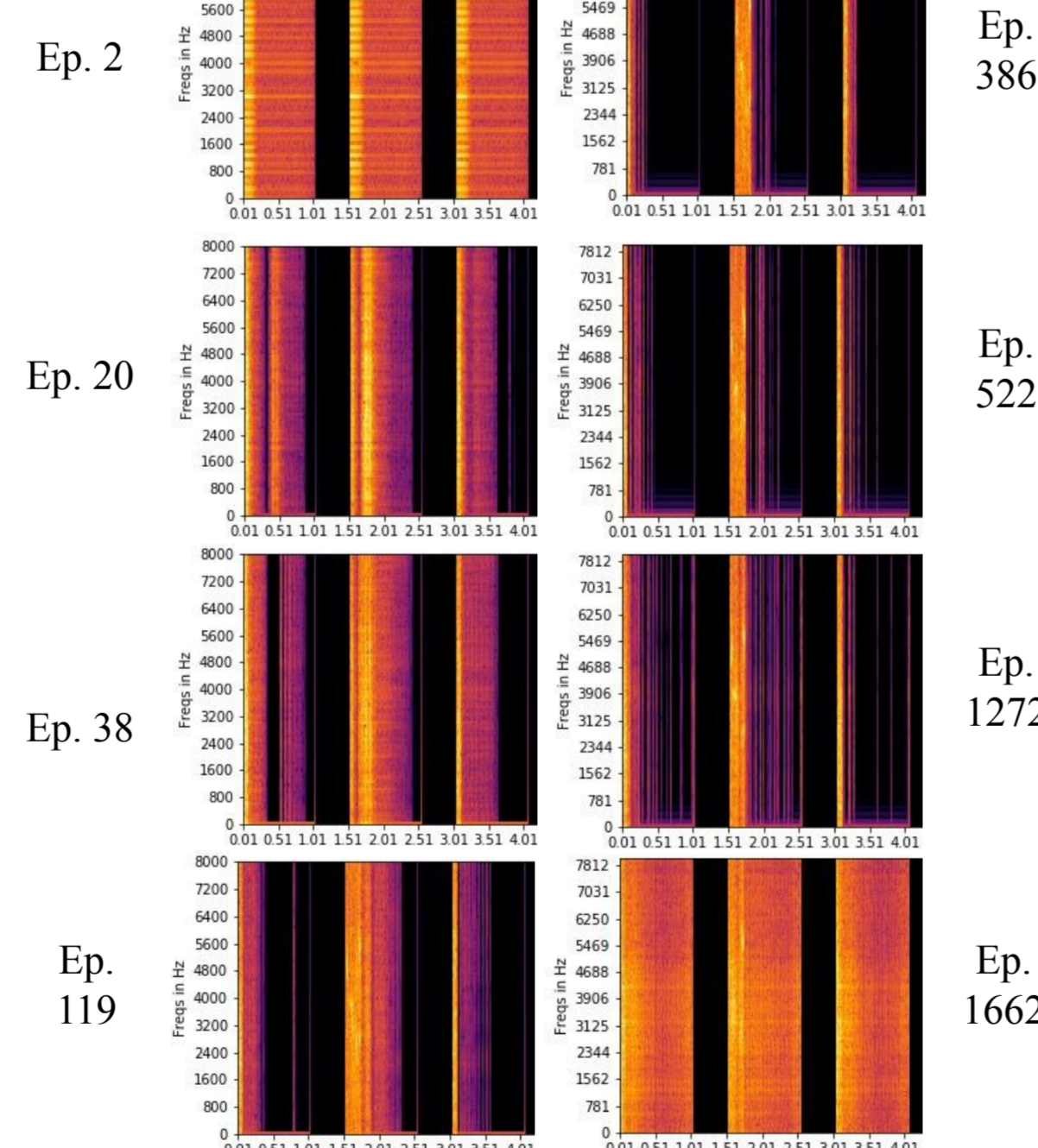
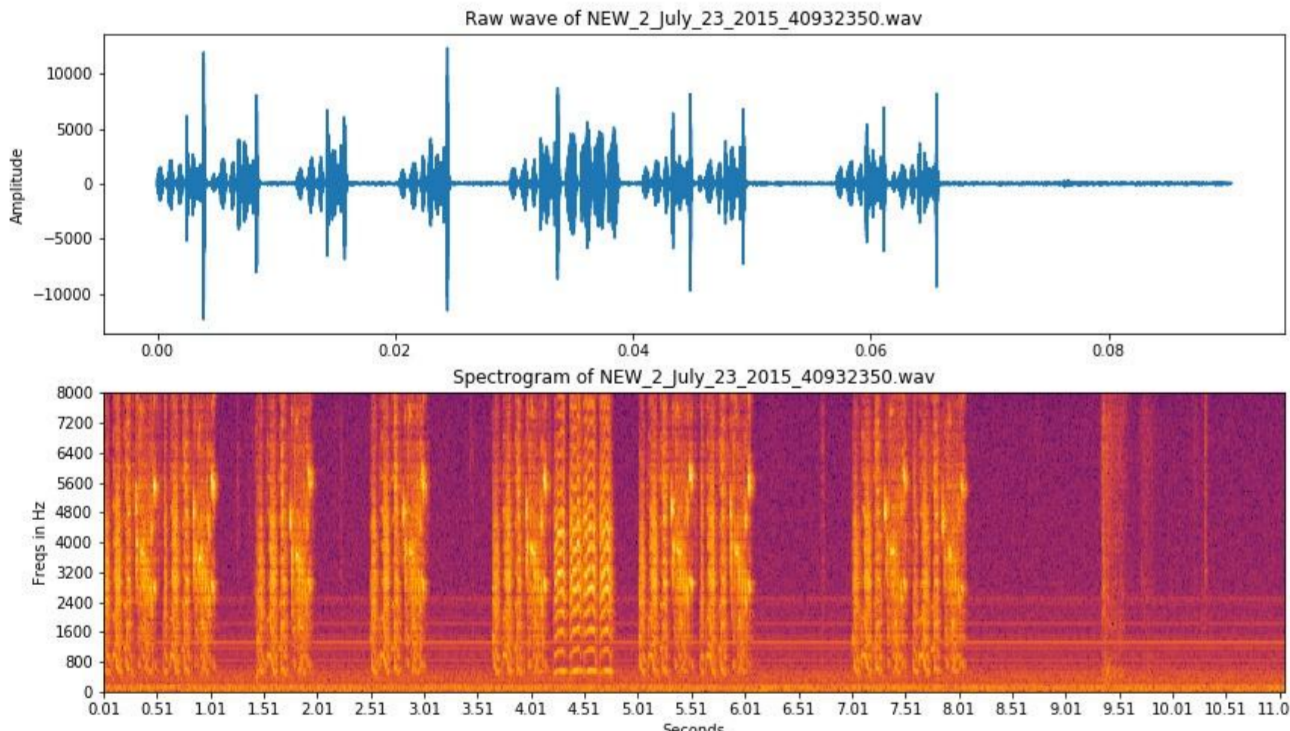

DISCRIMINATOR

- Discriminator trained 5x generator update.

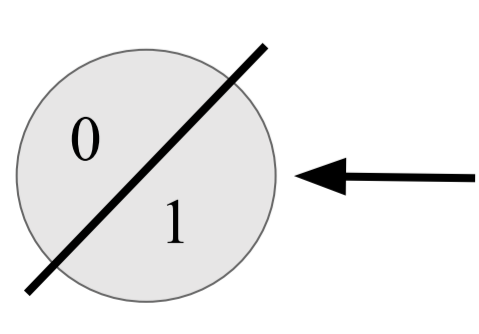

GENERATED SOUND AFTER TRAINING

- Batch size = 64
- Epochs = 517

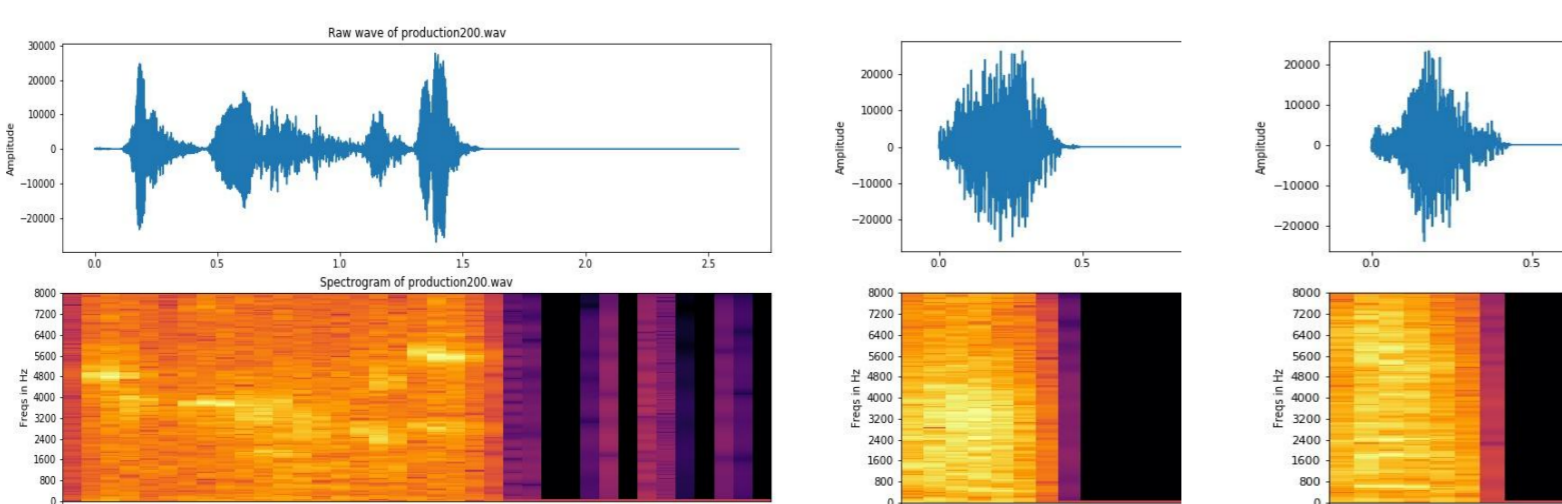

Inception Score (IS) = 1.95 ± 0.02

PERCEPTUAL SPACE

AIM: have a lower dimensional representation of the physical acoustic space, which is the sensory space (sound).

Deep scattering transform [6]

- From MFCC coefficients introducing wavelets.
- Scattering coefficients can be seen as a convolutional neural networks.

DATASET

- Recordings from an adult zebra finch with sampling rate 16000.

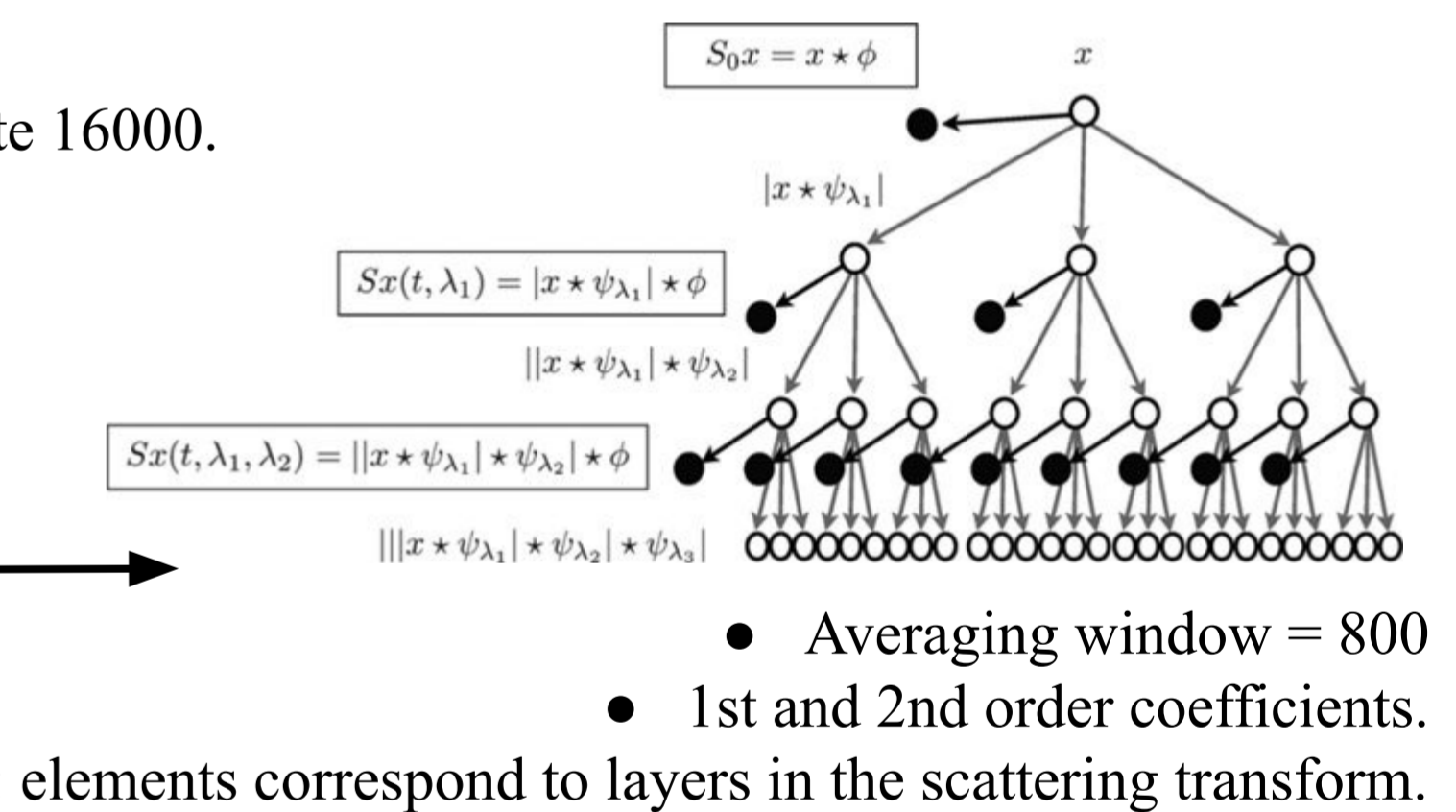
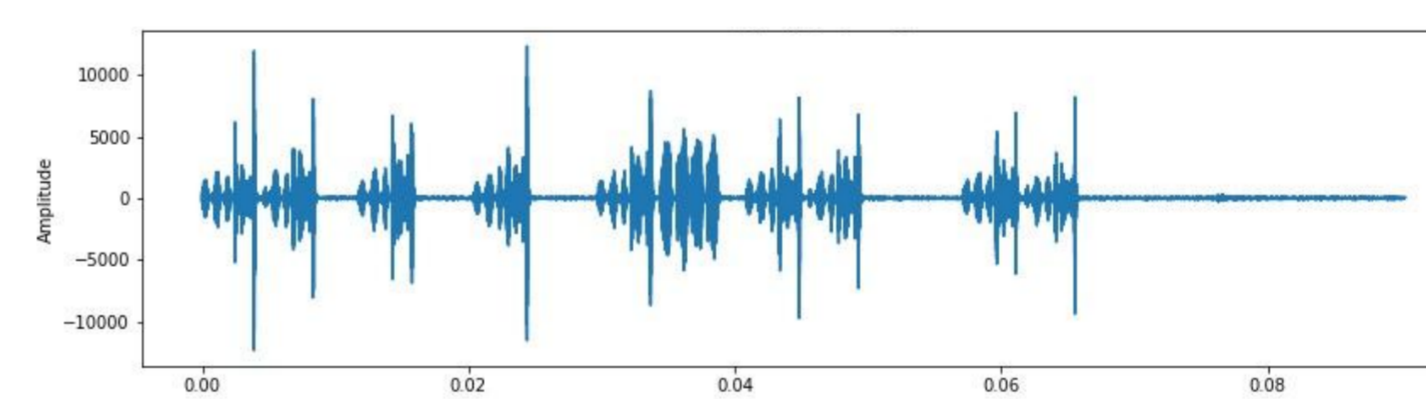

PCA analysis

- N = 52 syllables.
- PCA analysis.
- k-means algorithm.

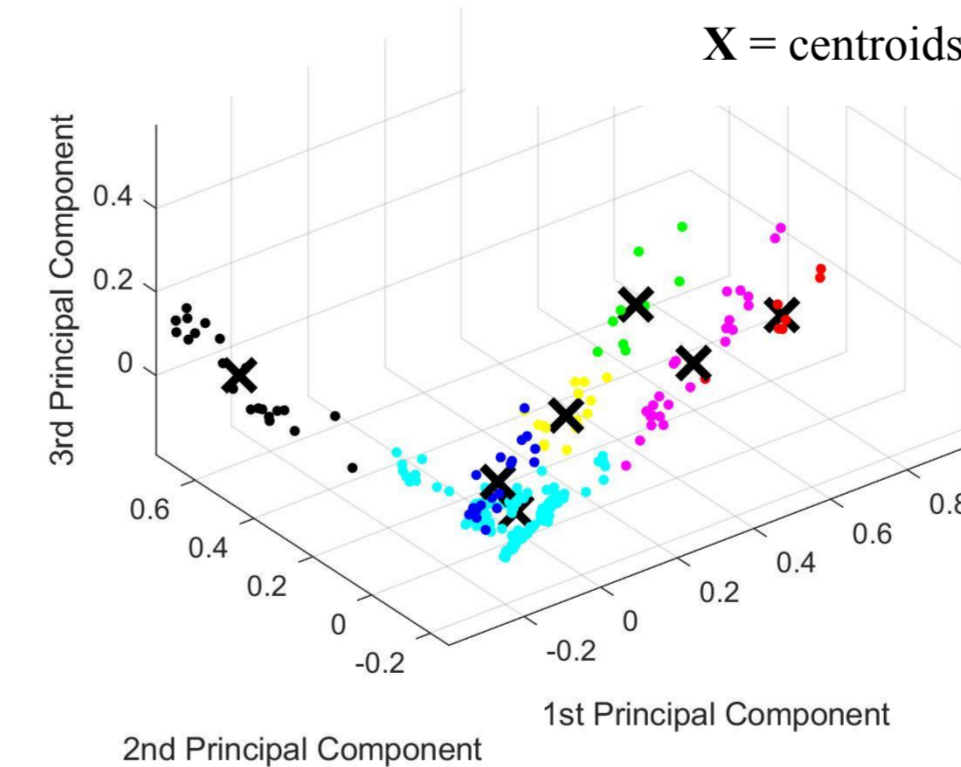

Second-order, translation-invariant scattering transform of one-dimensional signals

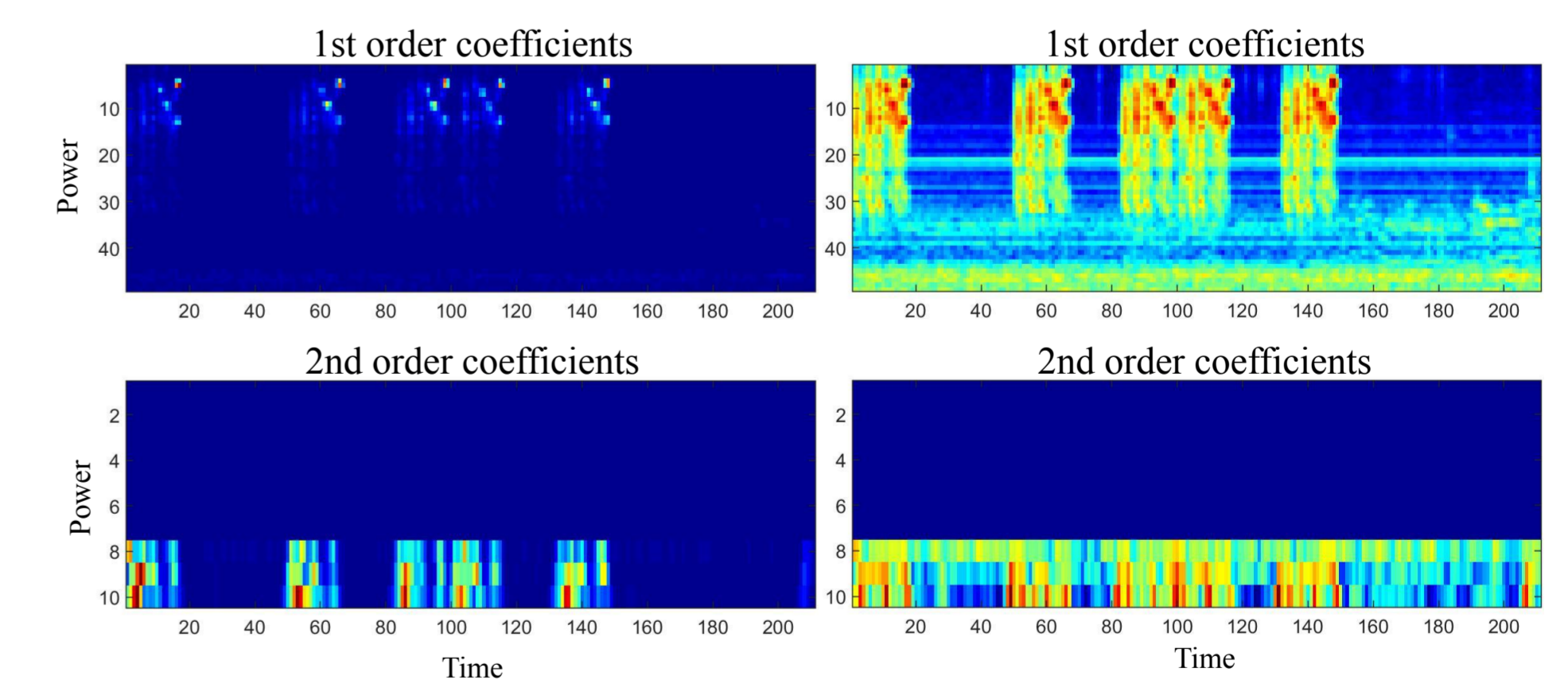

PERSPECTIVES

Motor control model

- Explore the possibility to use a dynamical system model.
- More exhaustive evaluation of the generative model.

Exploration strategy

- Intrinsic motivation to drive motor exploration.
- Investigate the geometrical properties of latent space generated with the GAN.

BIBLIOGRAPHY

- [1] Oudeyer, P. Y. (2005). The self-organization of speech sounds. *Journal of Theoretical Biology*, 233(3), 435-449.
- [2] Elemans, C. P. H., et al. Universal mechanisms of sound production and control in birds and mammals. *Nature communications*, 2015, 6: 8978.
- [3] Donahue, C., McAuley, J., & Puckette, M. (2019). Adversarial Audio Synthesis. *ICLR*.
- [4] Goodfellow, I., Pouget-Abadie, J., Mirza, M., Xu, B., Warde-Farley, D., Ozair, S., ... & Bengio, Y. (2014). Generative adversarial nets. In *Advances in neural information processing systems* (pp. 2672-2680).
- [5] Radford, A., Metz, L., & Chintala, S. (2015). Unsupervised representation learning with deep convolutional generative adversarial networks. *arXiv preprint arXiv:1511.06434*.
- [6] Adén, J., & Mallat, S. (2014). Deep scattering spectrum. *IEEE Transactions on Signal Processing*, 62(16), 4114-4128.