



HAL
open science

On Combinatorial Proofs for Modal Logic

Matteo Acclavio, Lutz Strassburger

► **To cite this version:**

Matteo Acclavio, Lutz Strassburger. On Combinatorial Proofs for Modal Logic. TABLEAUX 2019 - 28th International Conference on Automated Reasoning with Analytic Tableaux and Related Methods, Sep 2019, London, United Kingdom. pp.223-240, 10.1007/978-3-030-29026-9_13 . hal-02390400

HAL Id: hal-02390400

<https://inria.hal.science/hal-02390400>

Submitted on 10 Dec 2019

HAL is a multi-disciplinary open access archive for the deposit and dissemination of scientific research documents, whether they are published or not. The documents may come from teaching and research institutions in France or abroad, or from public or private research centers.

L'archive ouverte pluridisciplinaire **HAL**, est destinée au dépôt et à la diffusion de documents scientifiques de niveau recherche, publiés ou non, émanant des établissements d'enseignement et de recherche français ou étrangers, des laboratoires publics ou privés.

On Combinatorial Proofs for Modal Logic

Matteo Acclavio¹ and Lutz Straßburger²

¹ Università Roma Tre <http://matteoacclavio.com/Math.html>

² Inria Saclay <http://www.lix.polytechnique.fr/Labo/Lutz.Strassburger/>

Abstract. In this paper we extend Hughes’ combinatorial proofs to modal logics. The crucial ingredient for modeling the modalities is the use of a self-dual non-commutative operator that has first been observed by Retoré through pomset logic. Consequently, we had to generalize the notion of skew fibration from cographs to Guglielmi’s relation webs.

Our main result is a sound and complete system of combinatorial proofs for all normal and non-normal modal logics in the **S4**-tesseract. The proof of soundness and completeness is based on the sequent calculus with some added features from deep inference.

Keywords: Combinatorial Proofs · Modal Logic · S4-tesseract · Relation Webs · Skew Fibration.

1 Introduction

During the last three decades, the proof theory of modal logics has seen enormous progress. We have now access to a systematic treatment of modal logics in display calculus [32], calculus of structures [26,14], labeled systems [25,22], hyper sequents [3,18], and nested sequents [5,28,20]. There are focused proof systems for classical and intuitionistic modal logics [7,8], and we understand the relation between display calculus and nested sequents [10] and hyper sequents [11].

The motivation for this paper is to take the natural next step in this advancement. After having developed various proof systems, using different formalisms, we are now asking the question: *When are two proofs the same?*

We are not claiming to provide a final answer to this question, but we propose an approach based on *combinatorial proofs*, introduced by Hughes [15,16] to address the question of proof identity for classical propositional logic and Hilbert’s 24th problem [31,30]. Via combinatorial proofs, it is finally possible to ask the question of proof identity also for proofs in different proof formalisms; recent research has investigated this for syntactic proofs in sequent calculus [16,15], calculus of structures [29], resolution calculus, and analytic tableaux [1].

In classical propositional logic, a combinatorial proof is a *skew fibration* $f: \mathcal{G} \rightarrow \mathcal{F}$ from an *RB-cograph* \mathcal{G} , that can be seen as the “linear part” of the proof, to a *cograph* \mathcal{F} that encodes the conclusion of the proof. The mapping f precisely captures the information about what is duplicated and deleted in the proof. In terms of syntactic proof systems, this corresponds to the rules of *contraction* and *weakening*.

As an example we show below the combinatorial proof of Pierce’s law. On the left we show the conclusion as formula, and on the right as cograph.



There, the regular (red) R-edges are the edges of the RB-cograph \mathcal{G} , and the bold (blue) B-edges represent the *linking*, corresponding to the instances of the axiom-rule in the sequent calculus. The vertical arrows (purple) represent the mapping f .

There is a close correspondence between cographs and formulas composed from atoms via two binary (commutative and associative) connectives, \wedge (*and*) and \vee (*or*): the vertices of the cograph are the atom occurrences in the formula, and there is an (undirected) edge between two atom occurrences if their first common ancestor in the formula tree is an \wedge , and there is no edge if it is an \vee .

For this reason, the cograph-approach works very well for classical propositional logic (CPL) [15,16,27,29] and for multiplicative linear logic (MLL) [24], but it is not obvious how to extend this notion to modalities, which can be seen as unary connectives.

We solve this problem by adding a third non-commutative (self-dual) operation \triangleleft (*seq*), that has first been proposed by Retoré in *pomset logic* [23] and later been studied in the logic BV [12,13]. In the corresponding graph, we put a *directed* edge between two atoms if their first common ancestor in the formula tree is an \triangleleft . With this insight we can now represent a formula $\square A$ (resp. $\diamond A$) as graph by taking the graph of A , add a vertex labeled with \square (resp. \diamond) and add a directed edge from that vertex to every vertex in A . This is illustrated in the example below, which is a proof in the modal logic K, and which is a variation of the example in (1) above. As before, on the left the conclusion is written as formula, and on the right as graph.

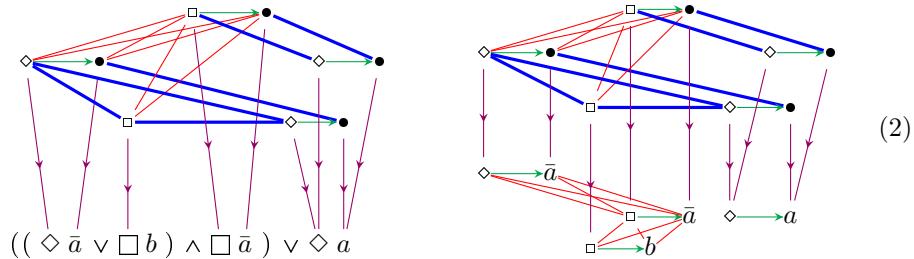

The upstairs graph is now no longer an RB-cograph but an *RGB-cograph* which additionally has directed (green) G-edges. The downstairs graph is a *relation web* which is a generalization of a cograph to more than two connectives.

The contributions of this paper can now be summarized as follows: we present a notion of combinatorial proof for the modal logics in the $S4$ -plane (shown on the

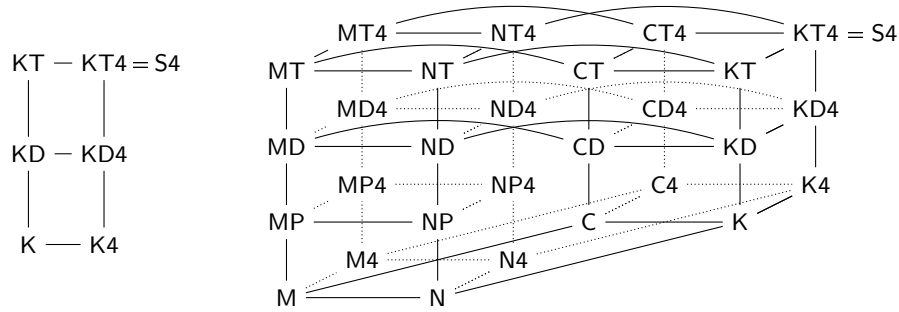

Fig. 1. On the left: the S4-plane and on the right the S4-tesseract

left in Figure 1), and we show how sequent proofs are translated to combinatorial proofs, and that this translation is polynomial in the size of the proof. We then show that these results can be extended to the non-normal modal logics of the S4-tesseract [19] (shown on the right in Figure 1).

We begin by recalling in Section 2 the sequent calculus systems for the modal logics in the S4-plane. Then, in Section 3 we recall the notion of Guglielmi’s relation webs [12]. Section 5 introduces skew fibrations on relation webs and shows that they correspond to contraction-weakening maps. In Section 4 we introduce the notion of RGB-cograph and show the relation to “linear” proofs in modal logics. The results of Sections 5 and 4 are combined in Section 6 to define combinatorial proofs for the modal logics K and KD and show their soundness and completeness. We also show that they form a proof system in the sense of Cook and Reckhow [9]. Then, Section 7 shows how to treat modal logics that include the axioms T and/or 4, and finally, in Section 8, we show how our results can be extended to all logics in the S4-tesseract.

2 Sequent calculus

We consider the class \mathcal{K} of *modal formulas* (denoted by A, B, \dots) in negation normal form, generated by a countable set $\mathcal{A} = \{a, b, \dots\}$ of *propositional variables* and their duals $\bar{\mathcal{A}} = \{\bar{a}, \bar{b}, \dots\}$ by the following grammar:

$$A, B ::= a \mid \bar{a} \mid A \vee B \mid A \wedge B \mid \Box A \mid \Diamond A \mid \Box \perp \mid \Diamond \perp$$

where \perp stands for the *empty formula*.³ An *atom* is an element of $\mathcal{A} \cup \bar{\mathcal{A}} \cup \{\Box \perp, \Diamond \perp\}$. A sequent $\Gamma = A_1, \dots, A_n$ is a non-empty multiset of formulas, written as list separated by comma.

³ Note that \perp is only allowed directly inside a \Box or \Diamond . The main purpose of avoiding \perp as proper formula is to avoid the empty relation web (to be introduced in the next section). However, we do need formulas $\Box \perp$ and $\Diamond \perp$ in order to allow weakenings inside a \Box or \Diamond , which is needed to prove the decomposition theorem (stated in Theorem 2.2 below) which in turn is the basis for combinatorial proofs.

$$\begin{array}{c}
\frac{}{a, \bar{a}} \text{ax} \quad \frac{\Gamma, A, B}{\Gamma, A \vee B} \vee \quad \frac{\Gamma, A \quad B, \Delta}{\Gamma, A \wedge B, \Delta} \wedge \quad \frac{\Gamma}{\Gamma, A} \text{w} \quad \frac{\Gamma, A, A}{\Gamma, A} \text{c} \\
\frac{A, \Gamma}{\Box A, \Diamond \Gamma} \text{k} \quad \frac{A, \Gamma}{\Diamond A, \Diamond \Gamma} \text{d} \quad \frac{\Gamma, A}{\Gamma, \Diamond A} \text{t} \quad \frac{A, \Gamma, \Diamond \Delta}{\Box A, \Diamond \Gamma, \Diamond \Delta} 4_{\text{k}} \quad \frac{A, \Gamma, \Diamond \Delta}{\Diamond A, \Diamond \Gamma, \Diamond \Delta} 4_{\text{dk}}
\end{array}$$

Fig. 2. Sequent calculus rules for the S4-plane

$$\begin{array}{c}
\frac{\Gamma}{\Box \perp, \Diamond \Gamma} \text{k}' \quad \frac{A, \Gamma}{\Box A, \Diamond \Gamma, \Diamond \perp, \dots, \Diamond \perp} \text{k}'' \quad \frac{\Gamma}{\Box \perp, \Diamond \Gamma, \Diamond \perp, \dots, \Diamond \perp} \text{k}''' \\
\frac{\Gamma, \Diamond \Delta}{\Box \perp, \Diamond \Gamma, \Diamond \Delta} 4'_{\text{k}} \quad \frac{A, \Gamma, \Diamond \Delta}{\Box A, \Diamond \Gamma, \Diamond \Delta, \Diamond \perp, \dots, \Diamond \perp} 4''_{\text{k}} \quad \frac{\Gamma, \Diamond \Delta}{\Box \perp, \Diamond \Gamma, \Diamond \Delta, \Diamond \perp, \dots, \Diamond \perp} 4'''_{\text{k}} \\
\frac{\Gamma}{\Diamond \perp, \dots, \Diamond \perp, \Diamond \Gamma} \text{d}' \quad \frac{\Gamma, \Diamond \Delta}{\Diamond \perp, \dots, \Diamond \perp, \Diamond \Gamma, \Diamond \Delta} 4'_{\text{dk}}
\end{array}$$

Fig. 3. Extended modal rules incorporating weakening on \perp .

$$\begin{array}{c}
\frac{\Gamma\{A\}}{\Gamma\{A \vee B\}} \text{w}_{\vee 1}^{\downarrow} \quad \frac{\Gamma\{A\}}{\Gamma\{B \vee A\}} \text{w}_{\vee 2}^{\downarrow} \quad \frac{\Gamma\{\Box \perp\}}{\Gamma\{\Box A\}} \text{w}_{\Box}^{\downarrow} \quad \frac{\Gamma\{\Diamond \perp\}}{\Gamma\{\Diamond A\}} \text{w}_{\Diamond}^{\downarrow} \\
\frac{\Gamma\{A \vee A\}}{\Gamma\{A\}} \text{c}^{\downarrow} \quad \frac{\Gamma\{A\}}{\Gamma\{\Diamond A\}} \text{t}^{\downarrow} \quad \frac{\Gamma\{\Diamond \Diamond A\}}{\Gamma\{\Diamond A\}} 4^{\downarrow}
\end{array}$$

Fig. 4. Deep inference rules for weakening, contraction, and the t- and 4-axioms

$$\frac{\Gamma\{a \vee a\}}{\Gamma\{a\}} \text{ac}^{\downarrow} \quad \frac{\Gamma\{(A \wedge B) \vee (C \wedge D)\}}{\Gamma\{(A \vee C) \wedge (B \vee D)\}} \text{m} \quad \frac{\Gamma\{\Box A \vee \Box B\}}{\Gamma\{\Box(A \vee B)\}} \text{m}_{\Box}^{\downarrow} \quad \frac{\Gamma\{\Diamond A \vee \Diamond B\}}{\Gamma\{\Diamond(A \vee B)\}} \text{m}_{\Diamond}^{\downarrow}$$

Fig. 5. The atomic contraction rule (where a stands for any atom) and the medial rules

$$\frac{\Gamma\{A \wedge (B \wedge C)\}}{\Gamma\{(A \wedge B) \wedge C\}} \equiv \frac{\Gamma\{A \vee (B \vee C)\}}{\Gamma\{(A \vee B) \vee C\}} \equiv \frac{\Gamma\{B \wedge A\}}{\Gamma\{A \wedge B\}} \equiv \frac{\Gamma\{B \vee A\}}{\Gamma\{A \vee B\}} \equiv$$

Fig. 6. Equality rules

X	K	KD	KT	K4	KD4	KT4 = S4
X^{seq}	$\{k\}$	$\{k, d\}$	$\{k, t\}$	$\{k, 4_k\}$	$\{k, d, 4_k, 4_{\text{dk}}\}$	$\{k, t, 4_k\}$
X^{LL}	$\{k^+\}$	$\{k^+, d^+\}$	$\{k^+\}$	$\{k^+\}$	$\{k^+, d^+\}$	$\{k^+\}$
X^{\downarrow}	\emptyset	\emptyset	$\{t^{\downarrow}\}$	$\{4^{\downarrow}\}$	$\{4^{\downarrow}\}$	$\{t^{\downarrow}, 4^{\downarrow}\}$

Fig. 7. Rule sets from logics

We begin our presentation with the six modal logics in the S4-plane shown on the left of Figure 1. In Figure 2 we show the inference rules for the sequent systems for these logics. We use $\Diamond \Gamma$ as abbreviation for $\Diamond B_1, \dots, \Diamond B_n$ where $\Gamma = B_1, \dots, B_n$. Then, Figure 3 shows variations of the modal rules that are

needed to obtain our decomposition theorem (Theorem 2.2 below) that will play a crucial role in the proof of soundness and completeness for combinatorial proofs. We write k^+ (resp. d^+ , 4_k^+ , 4_{dk}^+) for any instance in $\{k, k', k'', k'''\}$ (resp. $\{d, d'\}$, $\{4_k, 4'_k, 4''_k, 4'''_k\}$, $\{4_{dk}, 4'_{dk}\}$).

In this paper we also make use of some *deep inference* [12,13,6] rules that are shown in Figure 4, where $\Gamma\{\}$ stands for a *context*, which is a sequent or a formula with a hole that takes the place of an atom. We write $\Gamma\{A\}$ when we replace the hole in $\Gamma\{\}$ by the formula A . We write w^\downarrow for the set $\{w, w_{\vee 1}^\downarrow, w_{\vee 2}^\downarrow, w_\square^\downarrow, w_\diamond^\downarrow\}$.

For each X among the six logics K , KD , KT , $K4$, $KD4$, and $KT4$, we define three sets X^{seq} , X^{LL} , and X^\downarrow of inference rules as shown in Figure 7.

We now define the following sequent systems: $\text{MLL} = \{\text{ax}, \vee, \wedge\}$ and $\text{LK} = \text{MLL} \cup \{w, c\}$; if X is one of the six logics in the $S4$ -plane, then $\text{MLL-X} = \text{MLL} \cup X^{\text{LL}}$ and $\text{LK-X} = \text{LK} \cup X^{\text{seq}}$. The following theorem is well-known [33].

Theorem 2.1 *If $X \in \{K, KD, KT, K4, KD4, KT4\}$ then LK-X is a sound and complete sequent system for the modal logic X .*

If Γ is a sequent and S a sequent system, we write $\vdash^S \Gamma$ if there is a derivation of Γ in S . If S is a set of inference rules that all have exactly one premise, we can write $\Gamma' \xrightarrow{S} \Gamma$ if there is a derivation from Γ' to Γ using only rules from S .

Theorem 2.2 *Let $X \in \{K, KD, KT, K4, KD4, KT4\}$ and Γ be a sequent. Then*

$$\frac{\text{LK-X}}{\vdash \Gamma} \iff \frac{\text{MLL-X}}{\vdash \Gamma'} \frac{X^\downarrow}{\vdash \Gamma''} \frac{w^\downarrow, c^\downarrow}{\vdash \Gamma} \text{ for some } \Gamma' \text{ and } \Gamma''.$$

Proof This is proved by a straightforward permutation argument. First, all instances of w (resp. c) are replaced by instances of w^\downarrow (resp. \vee and c^\downarrow), and then all w^\downarrow - and c^\downarrow -instances can be permuted down in the proof. Observe that this step introduces the rules shown in Figure 3. Then, all t instances are also t^\downarrow -instances, and all instances of 4_k^+ (resp. 4_{dk}^+) are replaced by instances of k^+ (resp. d^+) and 4^\downarrow -instances. Then all t^\downarrow - and 4^\downarrow -instances can be permuted down. Conversely, we can first permute the instances of t^\downarrow and 4^\downarrow up and then the instances of w^\downarrow and c^\downarrow until they are not deep anymore. \square

There are two reasons to use a deep contraction rule. The first is the decomposition theorem proved above, and the second is that deep contraction can be reduced to atomic form (shown on the left in Figure 5) via the so-called (deep) *medial rules* (shown on the right in Figure 5). We write m^\downarrow for the set $\{m, m_\square^\downarrow, m_\diamond^\downarrow\}$. Additionally we make use of the *equivalence rules* shown in Figure 6.

Theorem 2.3 *Let Γ' and Γ be sequents. Then*

$$\Gamma' \frac{c^\downarrow, w^\downarrow, \equiv}{\vdash \Gamma} \iff \Gamma' \frac{m^\downarrow, \equiv}{\vdash \Delta'} \frac{ac^\downarrow, \equiv}{\vdash \Delta} \frac{w^\downarrow, \equiv}{\vdash \Gamma} \text{ for some sequents } \Delta, \Delta'.$$

Proof For the case without modalities, this is a standard result in the calculus of structures, first proved in [6] (see also [27]). In the presence of the modalities, the proof is similar: For \Rightarrow direction, we first reduce c^\downarrow to ac^\downarrow using the medial

$$\begin{array}{ccc}
\frac{(A \vee B) \vee (A \vee B)}{A \vee B} \mathbf{c} \rightsquigarrow \frac{(A \vee B) \vee (A \vee B)}{\frac{\{A \vee A\} \vee \{B \vee B\}}{A \vee B}} \mathbf{c}^\downarrow \equiv & \frac{\Box A \vee \Box A}{\Box A} \mathbf{c} \rightsquigarrow \frac{\Box A \vee \Box A}{\frac{\Box\{A \vee A\}}{\Box A}} \mathbf{m}_\Box^\downarrow \mathbf{c}^\downarrow \\
\frac{(A \wedge B) \vee (A \wedge B)}{A \wedge B} \mathbf{c} \rightsquigarrow \frac{(A \wedge B) \vee (A \wedge B)}{\frac{\{A \vee A\} \wedge \{B \vee B\}}{A \vee B}} \mathbf{m} \mathbf{c}^\downarrow & \frac{\Diamond A \vee \Diamond A}{\Diamond A} \mathbf{c} \rightsquigarrow \frac{\Diamond A \vee \Diamond A}{\frac{\Diamond\{A \vee A\}}{\Diamond A}} \mathbf{m}_\Diamond^\downarrow \mathbf{c}^\downarrow
\end{array}$$

Fig. 8. Reducing contraction to atomic contraction via medial rules.

and equivalence rules, proceeding by induction on the contraction formula, as shown in Figure 8. Note that a contraction on $\Box\perp$ (resp. $\Diamond\perp$) is already atomic. In the next step we permute the w^\downarrow down, and finally we permute all instances of \mathbf{ac}^\downarrow down. For the \Leftarrow direction, observe that \mathbf{ac}^\downarrow is already a special case of \mathbf{c}^\downarrow and that all rules in $\{\mathbf{m}, \mathbf{m}_\Box^\downarrow, \mathbf{m}_\Diamond^\downarrow\}$ are derivable using \mathbf{c}^\downarrow and w^\downarrow . \square

3 Relation Webs

A *directed graph* $\mathcal{G} = \langle V_{\mathcal{G}}, \overset{\mathcal{G}}{\rightarrow} \rangle$ is a set $V_{\mathcal{G}}$ of *vertices* equipped with a binary *edge relation* $\overset{\mathcal{G}}{\rightarrow} \subseteq V_{\mathcal{G}} \times V_{\mathcal{G}}$. We speak of an *undirected graph* $\mathcal{G} = \langle V_{\mathcal{G}}, \overset{\mathcal{G}}{\rightarrow} \rangle$ if the edge relation $\overset{\mathcal{G}}{\rightarrow} \subseteq V_{\mathcal{G}} \times V_{\mathcal{G}}$ is irreflexive and symmetric. A *mixed graph* is a triple $\mathcal{G} = \langle V_{\mathcal{G}}, \overset{\mathcal{G}}{\rightarrow}, \overset{\mathcal{G}}{\rightarrow} \rangle$ where $\langle V_{\mathcal{G}}, \overset{\mathcal{G}}{\rightarrow} \rangle$ is an undirected graph and $\langle V_{\mathcal{G}}, \overset{\mathcal{G}}{\rightarrow} \rangle$ is a directed graph, such that $\overset{\mathcal{G}}{\rightarrow} \cap \overset{\mathcal{G}}{\rightarrow} = \emptyset$ and $\overset{\mathcal{G}}{\rightarrow}$ is irreflexive. From now on, we omit the index/superscript \mathcal{G} when it is clear from the context. For two distinct vertices v and w in a mixed graph we use the following abbreviations:

$$\begin{array}{l}
v \overset{\leftarrow}{\leftarrow} w \iff w \overset{\rightarrow}{\rightarrow} v \\
v \overset{\rightarrow}{\rightarrow} w \iff v \overset{\rightarrow}{\rightarrow} w \text{ or } v \overset{\leftarrow}{\leftarrow} w \text{ or } v \overset{\leftarrow}{\leftarrow} w \\
v \overset{\cup}{\cup} w \iff v \overset{\rightarrow}{\rightarrow} w \text{ and } v \overset{\leftarrow}{\leftarrow} w \text{ and } v \overset{\leftarrow}{\leftarrow} w
\end{array} \tag{3}$$

Note that for any two vertices we have that $v \overset{\rightarrow}{\rightarrow} w$ iff $v \overset{\cup}{\cup} w$ or $v = w$. Furthermore, in a mixed graph, for any two vertices v and w , exactly one of the following five statements is true:

$$v = w \quad \text{or} \quad v \overset{\cup}{\cup} w \quad \text{or} \quad v \overset{\leftarrow}{\leftarrow} w \quad \text{or} \quad v \overset{\rightarrow}{\rightarrow} w \quad \text{or} \quad v \overset{\leftarrow}{\leftarrow} w$$

When drawing a graph we use $v \overset{\leftarrow}{\leftarrow} w$ for $v \overset{\leftarrow}{\leftarrow} w$, and $v \overset{\rightarrow}{\rightarrow} w$ for $v \overset{\rightarrow}{\rightarrow} w$, and for $v \overset{\cup}{\cup} w$ we either use $v \cdots w$ or draw no edge at all.

A *series-parallel order* is a directed graph $\mathcal{G} = \langle V_{\mathcal{G}}, \overset{\mathcal{G}}{\rightarrow} \rangle$ where $\overset{\mathcal{G}}{\rightarrow}$ is transitive, irreflexive, and Z-free, i.e., \mathcal{G} does not contain an induced subgraph of the shape shown on the left below:

$$\text{Forbidden configurations for Z-freeness:} \quad \begin{array}{cc} u \overset{\rightarrow}{\rightarrow} v & u \overset{\leftarrow}{\leftarrow} v \\ y \overset{\rightarrow}{\rightarrow} z & y \overset{\leftarrow}{\leftarrow} z \end{array} \tag{4}$$

A *cograph* is an undirected graph that is Z-free, i.e., it does not contain an induced subgraph of the shape shown on the right above.

Definition 3.1 A *relation web* is a mixed graph $\mathcal{G} = \langle V_{\mathcal{G}}, \overrightarrow{\mathcal{G}}, \overleftarrow{\mathcal{G}} \rangle$ where $\langle V_{\mathcal{G}}, \overrightarrow{\mathcal{G}} \rangle$ is a cograph and $\langle V_{\mathcal{G}}, \overleftarrow{\mathcal{G}} \rangle$ is a series-parallel order, and the following two configurations do not occur:

Forbidden configurations for relation webs:  (5)

Observation 3.2 It is easy to see that in a relation web, the undirected graph determined by the relation \smile (which is symmetric and irreflexive) is also a cograph.

Let \mathcal{G} and \mathcal{H} be two disjoint mixed graphs. We define the following operations:

$$\begin{aligned} \mathcal{G} \wp \mathcal{H} &= \langle V_{\mathcal{G}} \cup V_{\mathcal{H}}, \overrightarrow{\mathcal{G}} \cup \overrightarrow{\mathcal{H}}, \overleftarrow{\mathcal{G}} \cup \overleftarrow{\mathcal{H}} \rangle \\ \mathcal{G} \triangleleft \mathcal{H} &= \langle V_{\mathcal{G}} \cup V_{\mathcal{H}}, \overrightarrow{\mathcal{G}} \cup \overrightarrow{\mathcal{H}}, \overleftarrow{\mathcal{G}} \cup \overleftarrow{\mathcal{H}} \cup \{(u, v) \mid u \in V_{\mathcal{G}}, v \in V_{\mathcal{H}}\} \rangle \\ \mathcal{G} \otimes \mathcal{H} &= \langle V_{\mathcal{G}} \cup V_{\mathcal{H}}, \overrightarrow{\mathcal{G}} \cup \overrightarrow{\mathcal{H}} \cup \{(u, v), (v, u) \mid u \in V_{\mathcal{G}}, v \in V_{\mathcal{H}}\}, \overleftarrow{\mathcal{G}} \cup \overleftarrow{\mathcal{H}} \rangle \end{aligned} \quad (6)$$

which can be visualized as follows:

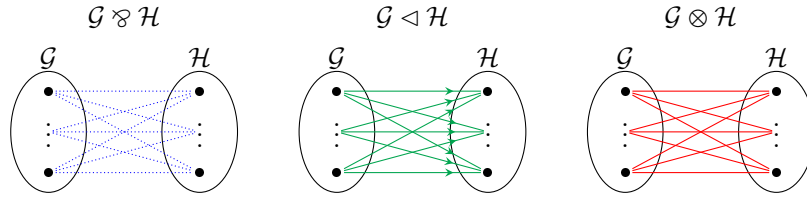

Theorem 3.3 A mixed graph is a relation web if and only if it can be constructed from single vertices using the three operations defined in (6) above.

Proof This follows from the corresponding results on cographs and series-parallel orders, e.g. [21]. A direct proof can be found in [12]. \square

A relation web is *labeled* if all its vertices carry a label selected from a label set \mathcal{L} . We write $l(v)$ for the label of v . We are now defining for a formula F the labeled relation web $\llbracket F \rrbracket$ where the label set $\mathcal{L} = \mathcal{A} \cup \bar{\mathcal{A}} \cup \{\square, \diamond\}$. We write \emptyset for the empty graph and we use the notations $\bullet_a, \bullet_{\bar{a}}, \diamond, \square$ for the graph consisting of a single vertex that is labeled with $a, \bar{a}, \diamond, \square$, respectively.

$$\begin{aligned} \llbracket a \rrbracket &= \bullet_a & \llbracket A \wedge B \rrbracket &= \llbracket A \rrbracket \otimes \llbracket B \rrbracket & \llbracket \square A \rrbracket &= \square \triangleleft \llbracket A \rrbracket & \llbracket \square \perp \rrbracket &= \square \\ \llbracket \bar{a} \rrbracket &= \bullet_{\bar{a}} & \llbracket A \vee B \rrbracket &= \llbracket A \rrbracket \wp \llbracket B \rrbracket & \llbracket \diamond A \rrbracket &= \diamond \triangleleft \llbracket A \rrbracket & \llbracket \diamond \perp \rrbracket &= \diamond \end{aligned} \quad (7)$$

For a sequent $\Gamma = A_1, \dots, A_n$ we define $\llbracket \Gamma \rrbracket = \llbracket A_1, \dots, A_n \rrbracket = \llbracket A_1 \rrbracket \wp \dots \wp \llbracket A_n \rrbracket$.

Definition 3.4 A relation web \mathcal{G} is *modalic* if for any vertices u, v, w with $u \rightsquigarrow w$ and $v \rightsquigarrow w$ we have $u \rightsquigarrow v$ or $v \rightsquigarrow u$ or $u = v$, i.e., \mathcal{G} does not contain the two configurations below.

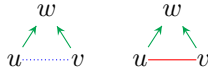
Forbidden configurations for modalic relation webs:  (8)

A labeled modalic relation web \mathcal{G} is *properly labeled* if its label set is $\mathcal{L} = \mathcal{A} \cup \bar{\mathcal{A}} \cup \{\square, \diamond\}$, such that whenever there are v, w with $v \rightsquigarrow w$ then $l(v) \in \{\square, \diamond\}$.

Theorem 3.5 *A relation web is the translation of a modal formula if and only if it is modalic and properly labeled.*

Proof If $\mathcal{G} = \llbracket F \rrbracket$ for some formula F , then the only vertices in \mathcal{G} with outgoing \rightsquigarrow -edge are the ones created in the encoding of a modal subformula and labeled with \square or \diamond . If we have two distinct such vertices u and v with an \rightsquigarrow -edge to some vertex w , then one of the corresponding modal operators is in the scope of the other and we have $u \rightsquigarrow v$ or $v \rightsquigarrow u$. The converse follows from Theorem 3.3 and the fact that the operation \triangleleft in (7) is associative. In fact, if $l(v) = \square$ (resp. $l(v) = \diamond$) and there is no w such that $v \rightsquigarrow w$ then we interpret the vertex v as the subformula $\square \perp$ (resp. $\diamond \perp$). \square

Proposition 3.6 *For two formulas F and F' , we have $\llbracket F \rrbracket = \llbracket F' \rrbracket$ iff F and F' are equivalent modulo associativity and commutativity of \wedge and \vee .*

Proof By a straightforward induction, observing that the operations \wp, \otimes and \triangleleft in (7) are associative, and that \wp and \otimes are also commutative. \square

Proposition 3.7 *Given a set $V_{\mathcal{G}}$ and two binary relations $\overset{\mathcal{G}}{\rightsquigarrow}, \overset{\mathcal{G}}{\rightsquigarrow} \subseteq V_{\mathcal{G}} \times V_{\mathcal{G}}$, it can be checked in time polynomial in $|V_{\mathcal{G}}|$, whether $\mathcal{G} = \langle V_{\mathcal{G}}, \overset{\mathcal{G}}{\rightsquigarrow}, \overset{\mathcal{G}}{\rightsquigarrow} \rangle$ is a modalic relation web.*

Proof Checking the transitivity, irreflexivity, and symmetry for verifying that \mathcal{G} is a mixed graph is trivially polynomial. Then, for checking the absence of the forbidden configurations in (4), (5), and (8) we can loop over all triples and quadruples of vertices, which is $O(|V_{\mathcal{G}}|^4)$. \square

4 RGB-cographs and linear proofs for K and KD

In this section we investigate when a modalic relation web does represent a proof. For this, we equip a relation web with a *linking* which is an equivalence class on its vertices. In the special case where each such equivalence class contains exactly two elements, and there are no \rightsquigarrow -edges, we have Retoré’s RB-cographs [24] that with an additional correctness criterion correspond to proofs in MLL.

Here we generalize the notion of RB-cographs to the one of RGB-cographs and we give a correspondence with *linear derivations* in MLL-K and MLL-KD.⁴

⁴ The logics defined by these systems can be seen as the “linear logic variants” of the standard modal logics K and KD.

$$\begin{array}{c}
 \frac{}{\bullet \text{---} \bullet} \text{ax} \qquad \frac{\langle \mathcal{G}', \mathcal{A}, \mathcal{B} \mid \overset{\mathcal{G}}{\mathcal{V}} \rangle}{\langle \mathcal{G}', \mathcal{A} \wp \mathcal{B} \mid \overset{\mathcal{G}}{\mathcal{V}} \rangle} \vee \qquad \frac{\langle \mathcal{G}', \mathcal{A} \mid \overset{\mathcal{G}}{\mathcal{V}} \rangle \quad \langle \mathcal{B}, \mathcal{H}' \mid \overset{\mathcal{H}}{\mathcal{V}} \rangle}{\langle \mathcal{G}', \mathcal{A} \otimes \mathcal{B}, \mathcal{H}' \mid \overset{\mathcal{G}}{\mathcal{V}} \cup \overset{\mathcal{H}}{\mathcal{V}} \rangle} \wedge \\
 \frac{\langle \mathcal{G}_{i_1}, \mathcal{G}_{i_2}, \dots, \mathcal{G}_{i_m} \mid \overset{\mathcal{G}}{\mathcal{V}} \rangle}{\langle \diamond \triangleleft \mathcal{G}_1, \diamond \triangleleft \mathcal{G}_2, \dots, \diamond \triangleleft \mathcal{G}_n \mid \overset{\mathcal{G}}{\mathcal{V}} \cup \overset{*}{\mathcal{V}} \rangle} \mathbf{k}^+ \qquad \frac{\langle \mathcal{G}_{i_1}, \dots, \mathcal{G}_{i_m} \mid \overset{\mathcal{G}}{\mathcal{V}} \rangle}{\langle \diamond \triangleleft \mathcal{G}_1, \dots, \diamond \triangleleft \mathcal{G}_n \mid \overset{\mathcal{G}}{\mathcal{V}} \cup \overset{*}{\mathcal{V}} \rangle} \mathbf{d}^+ \\
 \overset{*}{\mathcal{V}} = \{(v, w) \mid v, w \in V^\square \uplus V^\diamond \text{ and } v, w \notin V_{\mathcal{G}_1} \cup \dots \cup V_{\mathcal{G}_n}\} \\
 i_1, \dots, i_m \in \{1, \dots, n\} \text{ and pairwise distinct} \\
 \text{if } j \in \{1, \dots, n\} \setminus \{i_1, \dots, i_m\} \text{ then } \mathcal{G}_j = \emptyset
 \end{array}$$

Fig. 9. Translating MLL-K and MLL-KD sequent proofs into RGB-cographs

Definition 4.1 An *RGB-cograph* is a tuple $\mathcal{G} = \langle V_{\mathcal{G}}, \overset{\mathcal{G}}{\mathcal{R}}, \overset{\mathcal{G}}{\mathcal{L}}, \overset{\mathcal{G}}{\mathcal{V}} \rangle$, where $\langle V_{\mathcal{G}}, \overset{\mathcal{G}}{\mathcal{R}}, \overset{\mathcal{G}}{\mathcal{L}} \rangle$ is a modalic relation web, $V_{\mathcal{G}}$ is the disjoint union of three sets $V_{\mathcal{G}}^\bullet \uplus V_{\mathcal{G}}^\square \uplus V_{\mathcal{G}}^\diamond$, and $\overset{\mathcal{G}}{\mathcal{V}}$ is an equivalence relation, called the *linking*, such that

- if $v \in V_{\mathcal{G}}^\bullet$ then for all $w \in V_{\mathcal{G}}$ we have $v \not\curvearrowright w$;
- if $v \curvearrowright w$ then either $v, w \in V^\bullet$ or $v, w \in V_{\mathcal{G}}^\square \uplus V_{\mathcal{G}}^\diamond$;
- if $v \in V_{\mathcal{G}}^\bullet$ then there is exactly one $w \in V_{\mathcal{G}}^\bullet$ with $v \curvearrowright w$ and $v \neq w$.

An equivalence class of $\overset{\mathcal{G}}{\mathcal{V}}$ is called a *link*. The vertices in $V_{\mathcal{G}}^\bullet$ are called *atomic* vertices, and the vertices in $V_{\mathcal{G}}^\square \uplus V_{\mathcal{G}}^\diamond$ are called *modalic* vertices. An *RB-cograph* is an RGB-cograph \mathcal{G} with $V_{\mathcal{G}}^\square \uplus V_{\mathcal{G}}^\diamond = \emptyset$.

The first condition in this definition says that if a vertex has an outgoing \curvearrowright -edge then it has to be in $V_{\mathcal{G}}^\square \uplus V_{\mathcal{G}}^\diamond$, the second condition says that vertices from $V_{\mathcal{G}}^\bullet$ and $V_{\mathcal{G}}^\square \uplus V_{\mathcal{G}}^\diamond$ cannot be linked, and the third condition says that each link on $V_{\mathcal{G}}^\bullet$ has exactly two elements. In an RB-cograph [24] only the last condition makes sense since \curvearrowright is empty. When drawing an RGB-cograph we use bold (blue) edges $v \text{---} w$ when $v \neq w$ and $v \curvearrowright w$.

Figure 9 shows how proofs in MLL-K and MLL-KD are translated into RGB-cographs. There, the notation $\langle \mathcal{G}_1, \mathcal{G}_2, \dots, \mathcal{G}_n \mid \overset{\mathcal{G}}{\mathcal{V}} \rangle$ is used to denote the RGB-cograph whose underlying relation web is $\mathcal{G} = \mathcal{G}_1 \wp \mathcal{G}_2 \wp \dots \wp \mathcal{G}_n$ and whose linking is $\overset{\mathcal{G}}{\mathcal{V}}$. The **ax**-rule simply produces a graph with two vertices that are linked, and \curvearrowright and \curvearrowleft being empty. In the \vee -rule, premise and conclusion are the same RGB-cograph. In the \wedge -rule, the linking in the conclusion is the union of the linkings in the premises. These three rules behave exactly the same as in proof nets for MLL. More interesting are the rules \mathbf{k}^+ and \mathbf{d}^+ , where the linking of the conclusion is the linking of the premise together with an additional equivalence class containing all the new \square - and \diamond -vertices. The purpose of this section is to give a combinatorial characterization of the RGB-cographs that can be obtained via this sequent calculus translation.

Definition 4.2 An *alternating elementary path* (*a-path*) of length n in an RGB-cograph is a sequence of pairwise distinct vertices x_0, x_1, \dots, x_n such that we have either $x_0 \vee x_1 R_1 x_2 \vee x_3 R_3 x_4 \dots x_n$ or $x_0 R_0 x_1 \vee x_2 R_2 x_3 \vee x_4 \dots x_n$ with

$R_i \in \{\curvearrowright, \curvearrowleft\}$, i.e., an \mathfrak{a} -path is an elementary path whose edges are alternating in \curlyvee and $\curvearrowright \cup \curvearrowleft$. A *chord* in an \mathfrak{a} -path is an edge $x_i \curvearrowright x_j$ or $x_i \curvearrowleft x_j$ for $i, j \in \{0, \dots, n\}$ and $i + 2 \leq j$. A *chordless \mathfrak{a} -path* is an \mathfrak{a} -path without chord. An *\mathfrak{a} -cycle* is an \mathfrak{a} -path of even length such that $x_0 = x_n$. An RGB-cograph \mathcal{G} is *\mathfrak{a} -connected* if any two vertices are connected by a chordless \mathfrak{a} -path, and \mathcal{G} is *\mathfrak{a} -acyclic* if it contains no chordless \mathfrak{a} -cycle.

Definition 4.3 An RGB-cograph \mathcal{G} is *K-correct* (or $\{\mathfrak{k}^+\}$ -correct) if

1. \mathcal{G} is \mathfrak{a} -connected and \mathfrak{a} -acyclic;
2. $V_{\mathcal{G}} \neq \emptyset$ and every \curlyvee -equivalence class in $V^{\square} \uplus V^{\diamond}$ contains at least one vertex v such that there is a vertex $w \in V^{\bullet}$ with $v \curvearrowright w$;
3. if $w \xrightarrow{\mathcal{G}} v$ and $v \curlyvee v'$, then there is $w' \curlyvee w$ such that $w' \xrightarrow{\mathcal{G}} v'$; and
4. every \curlyvee -equivalence class in $V^{\square} \uplus V^{\diamond}$ contains exactly one vertex $v \in V^{\square}$.

We say that \mathcal{G} is *KD-correct* (or $\{\mathfrak{k}^+, \mathfrak{d}^+\}$ -correct) if Condition 4 is replaced by:

4. every \curlyvee -equivalence class in $V^{\square} \uplus V^{\diamond}$ contains at most one vertex $v \in V^{\square}$.

Theorem 4.4 Let $X \in \{\text{K}, \text{KD}\}$. An RGB-cograph \mathcal{G} is the translation of an MLL- X sequent proof iff it is X^{LL} -correct.

Proof (Sketch) For the left-to-right direction, observe that all rules in Figure 9 preserve correctness. For the right-to-left direction, we will reuse the MLL sequentialization result for RB-cographs [24]. For this we will define for an RGB-cograph \mathcal{G} an RB-cograph $\partial(\mathcal{G})$ that is \mathfrak{a} -connected and \mathfrak{a} -acyclic if and only if \mathcal{G} is. We define a vertex set $V^* = \{v', \bar{v}' \mid v \in V_{\mathcal{G}}^{\square} \uplus V_{\mathcal{G}}^{\diamond}\}$ and let $V_{\partial(\mathcal{G})} = V_{\mathcal{G}}^{\bullet} \uplus V^*$, i.e., we take the atomic vertices of \mathcal{G} , and each modalic vertex is replaced by a dual pair of atomic vertices, that are linked by \curlyvee . Then we use Theorem 3.3 and Proposition 3.6 so that we can write \mathcal{G} and $\partial(\mathcal{G})$ as BV-formulas [12]. Let $v_1, \dots, v_n \in V_{\mathcal{G}}^{\square} \uplus V_{\mathcal{G}}^{\diamond}$ form an \curlyvee -equivalence class. Then the formula for \mathcal{G} is of shape $F\{v_1 \triangleleft B_1\} \cdots \{v_n \triangleleft B_n\}$ for some n -ary context $F\{ \} \cdots \{ \}$ (because \mathcal{G} is modalic). We transform $F\{v_1 \triangleleft B_1\} \cdots \{v_n \triangleleft B_n\}$ into $(\bar{v}'_1 \otimes \cdots \otimes \bar{v}'_n \otimes \partial(B_1 \wp \cdots \wp B_n)) \wp \partial(F\{v'_1\} \cdots \{v'_n\})$ and proceed inductively for all \curlyvee -equivalence classes. From Retoré's proof [24] we get an MLL sequentialization for $\partial(\mathcal{G})$, which we then transform back into an MLL-K or MLL-KD sequent proof for \mathcal{G} . \square

5 Skew Fibrations

Definition 5.1 Let \mathcal{G} and \mathcal{H} be mixed graphs. A *skew fibration* $f: \mathcal{G} \rightarrow \mathcal{H}$ is a function from $V_{\mathcal{G}}$ to $V_{\mathcal{H}}$ that preserves \curvearrowright and \curvearrowleft , i.e.,

$$v \xrightarrow{\mathcal{G}} w \implies f(v) \xrightarrow{\mathcal{H}} f(w) \quad \text{and} \quad v \curvearrowright w \implies f(v) \curvearrowright f(w) \quad , \quad (9)$$

and has the *skew lifting* property, i.e.,

$$\begin{aligned} &\text{for every } v \in V_{\mathcal{G}} \text{ and } w \in V_{\mathcal{H}} \text{ and } R \in \{\curvearrowleft, \curvearrowright\} \text{ with } w R_{\mathcal{H}} f(v) \text{ ,} \\ &\text{there is a } u \in V_{\mathcal{G}} \text{ such that } u R_{\mathcal{G}} v \text{ and } w \xrightarrow{\mathcal{H}} f(u) \text{ and } w \xrightarrow{\mathcal{H}} f(u) \text{ .} \end{aligned} \quad (10)$$

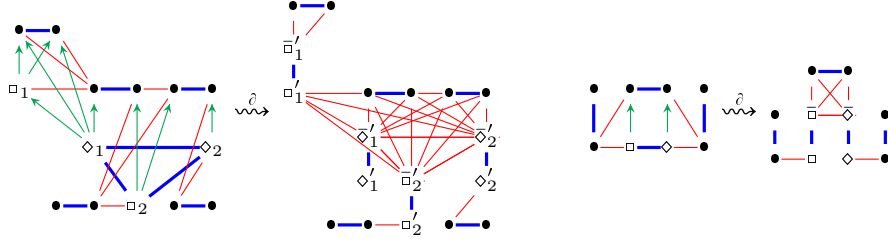

Fig. 10. The RGB-cographs for $F_1 = \bar{d} \vee (d \wedge \square(\bar{b} \wedge c)) \vee \bar{e} \vee (e \wedge \diamond \bar{c}) \vee \diamond(b \wedge \square(a \vee \bar{a}))$ and $F_2 = b \vee (\bar{b} \wedge \square a) \vee (\diamond \bar{a} \wedge c) \vee \bar{c}$, and the corresponding RB-cographs $\partial(F_1)$ and $\partial(F_2)$.

A skew fibration $f: \mathcal{G} \rightarrow \mathcal{H}$ is *modalic* if it satisfies the following condition:

$$\begin{aligned} & \text{if } u \xrightarrow{\mathcal{G}} v \text{ and } f(u) \xrightarrow{\mathcal{H}} f(v), \text{ then there is a } w \in V_{\mathcal{G}} \text{ such that} \\ & w \xrightarrow{\mathcal{G}} v \text{ and } f(u) = f(w), \text{ or } u \xrightarrow{\mathcal{G}} w \text{ and } f(v) = f(w). \end{aligned} \quad (11)$$

The main purpose of this definition is Theorem 5.2 which says that skew fibrations are precisely the contraction-weakening maps. This is crucial for the soundness and completeness of combinatorial proofs, to be defined in the next section.

Theorem 5.2 *There is a modalic skew fibration $f: \llbracket \Gamma' \rrbracket \rightarrow \llbracket \Gamma \rrbracket$ iff $\Gamma' \stackrel{c^\downarrow, w^\downarrow, \equiv}{\vdash} \Gamma$.*

Proof (Sketch) To prove this theorem, we proceed via Theorem 2.3 and make heavy use of results from [27] and the fact that $\Gamma' \stackrel{m^\downarrow, \equiv}{\vdash} \Gamma$ iff there is a surjective modalic skew fibration $f: \llbracket \Gamma' \rrbracket \rightarrow \llbracket \Gamma \rrbracket$ that is bijective on atomic vertices, which is a variant of [27, Theorem 5.1] and proved in a similar way. Then we can characterize derivations $\stackrel{ac^\downarrow, \equiv}{\vdash}$ and $\stackrel{w^\downarrow, \equiv}{\vdash}$ as in [27, Proposition 7.6], so that we can apply Theorem 2.3 (See also [2] and [4]). \square

6 Combinatorial proofs for the modal logics K and D

Definition 6.1 A map $f: \mathcal{G} \rightarrow \mathcal{F}$ from an RGB-cograph \mathcal{G} to a modalic and properly labeled relation web \mathcal{F} is *allegiant* if the following conditions hold:

- if $v, w \in V_{\mathcal{G}}^\circ$ and $v \xrightarrow{\mathcal{G}} w$ then $f(v)$ and $f(w)$ are labeled by dual atoms;
- if $v \in V_{\mathcal{G}}^\square$ then $l(f(v)) = \square$;
- if $v \in V_{\mathcal{G}}^\diamond$ then $l(f(v)) = \diamond$;

Definition 6.2 For $X \in \{K, KD\}$, an *X-combinatorial proof* of a sequent Γ is an allegiant skew-fibration $f: \mathcal{G} \rightarrow \llbracket \Gamma \rrbracket$ from an X-correct RGB-cograph \mathcal{G} to the relation web of Γ .

The *size* $|f|$ of a combinatorial proof $f: \mathcal{G} \rightarrow \llbracket \Gamma \rrbracket$ is $|V_{\mathcal{G}}| + |\Gamma|$, where $|\Gamma|$ is the number of symbols in Γ , and the *size* $|\pi|$ of a sequent proof π is the number of symbols in π .

Theorem 6.3 (Completeness) *Let $X \in \{K, KD\}$. If $\vdash^{LK-X} \Gamma$ then there is an X -combinatorial proof $f: \mathcal{G} \rightarrow \llbracket \Gamma \rrbracket$. Furthermore, the sizes of the sequent proof and the combinatorial proof differ only by a polynomial factor.*

Proof Let π be a proof of Γ in $LK-X$. By Theorem 2.2, π can be rewritten as $\vdash^{MLL-X} \Gamma' \vdash^{w^\downarrow, c^\downarrow} \Gamma$ for some Γ' . By Theorem 4.4, we have an X -correct RGB-cograph \mathcal{G} whose underlying relation web is $\llbracket \Gamma' \rrbracket$. By Theorem 5.2, we have a skew-fibration $f: \llbracket \Gamma' \rrbracket \rightarrow \llbracket \Gamma \rrbracket$, and therefore also $f: \mathcal{G} \rightarrow \llbracket \Gamma \rrbracket$, which is allegiant by construction. The size restrictions follow immediately: sequent proof and combinatorial proof are bound by the number of ax , k^+ , and d^+ instances. \square

Theorem 6.4 (Soundness) *Let $X \in \{K, KD\}$, and let $f: \mathcal{G} \rightarrow \llbracket A \rrbracket$ be an X -combinatorial proof. Then A is a theorem in the modal logic X .*

Proof We have an $MLL-X$ proof of a formula A' with $\llbracket A' \rrbracket = \mathcal{G}$. Hence A' is a theorem of X . By Theorem 5.2 we have a derivation $A' \vdash^{c^\downarrow, w^\downarrow, \equiv} A$ in which all inferences are sound for X , we can conclude that A is also a theorem of X . \square

Theorem 6.5 *Let Γ be a sequent, \mathcal{G} be a mixed graph together with a linking, and let f be a map from \mathcal{G} to $\llbracket \Gamma \rrbracket$. It can be decided in polynomial time in $|V_{\mathcal{G}}| + |\Gamma|$ whether $f: \mathcal{G} \rightarrow \llbracket \Gamma \rrbracket$ is an X -combinatorial proof for $X \in \{K, KD\}$.*

Proof All necessary properties (forbidden configurations (4), (5), (8) for \mathcal{G} being a modalic relation web, X -correctness conditions in Definition 4.3, preservation of \curvearrowright and \curvearrowleft (9) and skew lifting (10)) can be checked in polynomial time. \square

These three results, together with Theorem 2.1, imply that X -combinatorial proofs (for $X = K$ and $X = KD$) form a sound and complete proof system (in the sense of [9]) for the modal logic X . In the remaining sections of this paper we extend this result to all logics in the **S4**-tesseract.

7 Combinatorial proofs for the logics in the **S4**-plane

We call two vertices v and w in a relation web \mathcal{G} *clones* if for all u with $u \neq v$ and $u \neq w$ we have uRv iff uRw for all $R \in \{\curvearrowright, \curvearrowleft, \leftarrow, \rightarrow\}$. If $v = w$ then they are trivially clones.

Definition 7.1 Let \mathcal{G} and \mathcal{H} be modalic and properly labeled relation webs. A map $f: \mathcal{G} \rightarrow \mathcal{H}$ is a $\{4^\downarrow, \mathfrak{t}^\downarrow\}$ -map if the following conditions are fulfilled:

- if $f(v) = f(w)$ then v and w are clones in \mathcal{G} , and if also $v \neq w$ then $v \xrightarrow{\mathcal{G}} w$ and $l(f(v)) = l(f(w)) = \diamond$;
- if $f(v) \neq f(w)$ then $vR_{\mathcal{G}}w$ implies $f(v)R_{\mathcal{H}}f(w)$ for any $R \in \{\curvearrowright, \curvearrowleft, \leftarrow, \rightarrow\}$;
- if $v \in V_{\mathcal{H}}$ is not in the image of f then $l(v) = \diamond$ and $v \curvearrowright w$ for some $w \in V_{\mathcal{H}}$.

A $\{4^\downarrow, \mathfrak{t}^\downarrow\}$ -map is a $\{\mathfrak{t}^\downarrow\}$ -map if it is injective, and a $\{4^\downarrow\}$ -map if it is surjective.

Proposition 7.2 *The composition of $\{4^\downarrow, \mathfrak{t}^\downarrow\}$ -maps is a $\{4^\downarrow, \mathfrak{t}^\downarrow\}$ -map, and every $\{4^\downarrow, \mathfrak{t}^\downarrow\}$ -map can be written as a composition of a $\{4^\downarrow\}$ -map and a $\{\mathfrak{t}^\downarrow\}$ -map.*

Lemma 7.3 For all sequents Γ and Γ' , we have:

- $\Gamma' \stackrel{4^\downarrow, \mathfrak{t}^\downarrow, \equiv}{\vdash} \Gamma$ iff there is a $\{4^\downarrow, \mathfrak{t}^\downarrow\}$ -map $f: \llbracket \Gamma' \rrbracket \rightarrow \llbracket \Gamma \rrbracket$;
- $\Gamma' \stackrel{4^\downarrow, \equiv}{\vdash} \Gamma$ iff there is a $\{4^\downarrow\}$ -map $f: \llbracket \Gamma' \rrbracket \rightarrow \llbracket \Gamma \rrbracket$;
- $\Gamma' \stackrel{\mathfrak{t}^\downarrow, \equiv}{\vdash} \Gamma$ iff there is a $\{\mathfrak{t}^\downarrow\}$ -map $f: \llbracket \Gamma' \rrbracket \rightarrow \llbracket \Gamma \rrbracket$;

Proof The second and the third statement follow immediately from the definitions, and for the first statement, observe that $\Gamma' \stackrel{4^\downarrow, \mathfrak{t}^\downarrow, \equiv}{\vdash} \Gamma$ iff $\Gamma' \stackrel{4^\downarrow, \equiv}{\vdash} \Gamma'' \stackrel{\mathfrak{t}^\downarrow, \equiv}{\vdash} \Gamma$, and apply Proposition 7.2. \square

Definition 7.4 Let $X \in \{K, KD, KT, K4, KD4, KT4\}$. A map $f: \mathcal{G} \rightarrow \mathcal{H}$ is an X^\downarrow -skew fibration if $f = f'' \circ f'$ for some $f': \mathcal{G} \rightarrow \mathcal{G}'$ and $f'': \mathcal{G}' \rightarrow \mathcal{H}$, where f' is an X^\downarrow -map and f'' is a modalic skew fibration (if $X^\downarrow = \emptyset$ then f' is the identity).

Proposition 7.5 Given $f: \mathcal{G} \rightarrow \mathcal{H}$ and $X^\downarrow \subseteq \{\mathfrak{t}^\downarrow, 4^\downarrow\}$, it can be decided in time polynomial in $|\mathcal{G}| + |\mathcal{H}|$ whether f is an X^\downarrow -skew fibration.

Below are three examples, a $\{\mathfrak{t}^\downarrow\}$ -skew fibration, a $\{4^\downarrow\}$ -skew fibration, and a $\{4^\downarrow, \mathfrak{t}^\downarrow\}$ -skew fibration:

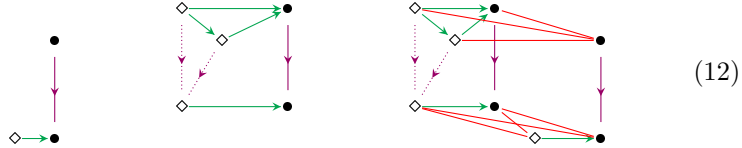

We can now easily generalize Theorem 5.2:

Theorem 7.6 Let $X^\downarrow \subseteq \{\mathfrak{t}^\downarrow, 4^\downarrow\}$. There is a derivation $\Gamma' \stackrel{X^\downarrow, \equiv}{\vdash} \Gamma'' \stackrel{c^\downarrow, w^\downarrow, \equiv}{\vdash} \Gamma$ iff there is an X^\downarrow -skew fibration $f: \llbracket \Gamma' \rrbracket \rightarrow \llbracket \Gamma \rrbracket$.

Proof This follows immediately from Definition 7.4, Lemma 7.3 and Theorem 5.2. \square

Definition 7.7 For $X \in \{K, KD, KT, K4, KD4, KT4\}$, an X -combinatorial proof of a sequent Γ is an allegiant X^\downarrow -skew-fibration $f: \mathcal{G} \rightarrow \llbracket \Gamma \rrbracket$ from an X^{LL} -correct RGB-cograph \mathcal{G} to the relation web of Γ .

With this definition, it now follows immediately from Proposition 7.5, Theorem 7.6 and Theorem 2.2, that Theorems 6.3, 6.4 and 6.5 hold for all $X \in \{K, KD, KT, K4, KD4, KT4\}$.

$$\begin{array}{c}
\frac{A, B}{\Box A, \Diamond B} m \quad \frac{A, B}{\Diamond A, \Diamond B} d_m \quad \frac{A, \Diamond B}{\Box A, \Diamond B} 4_m \quad \frac{A, \Diamond B}{\Diamond A, \Diamond B} 4_{dm} \quad \frac{A}{\Box A} n \quad \frac{A}{\Diamond A} p \\
\frac{A, \Gamma}{\Box A, \Diamond \Gamma} k_c \quad \frac{A, \Gamma}{\Diamond A, \Diamond \Gamma} d_c \quad \frac{A, \Gamma, \Diamond \Delta}{\Box A, \Diamond \Gamma, \Diamond \Delta} 4_c \quad \frac{A, \Gamma, \Diamond \Delta}{\Diamond A, \Diamond \Gamma, \Diamond \Delta} 4_{dc} \quad |\Gamma, \Delta| > 0
\end{array}$$

Fig. 11. Sequent calculus rules for **S4**-tesseract logics.

$$\begin{array}{c}
\frac{B}{\Box \perp, \Diamond B} m' \quad \frac{A}{\Box A, \Diamond \perp} m'' \quad \frac{A}{\Diamond \perp, \Diamond A} d'_m \quad \frac{\Diamond A}{\Box \perp, \Diamond A} 4'_m \quad \frac{\Diamond A}{\Diamond \perp, \Diamond A} 4'_{dm} \\
\frac{\Gamma}{\Box \perp, \Diamond \Gamma} k'_c \quad \frac{A, \Gamma}{\Box A, \Diamond \Gamma, \Diamond \perp, \dots, \Diamond \perp} k''_c \quad \frac{\Gamma}{\Box \perp, \Diamond \Gamma, \Diamond \perp, \dots, \Diamond \perp} k'''_c \\
\frac{\Gamma, \Diamond \Delta}{\Box \perp, \Diamond \Gamma, \Diamond \Delta} 4'_c \quad \frac{A, \Gamma, \Diamond \Delta}{\Box A, \Diamond \Gamma, \Diamond \Delta, \Diamond \perp, \dots, \Diamond \perp} 4''_c \quad \frac{\Gamma, \Diamond \Delta}{\Box \perp, \Diamond \Gamma, \Diamond \Delta, \Diamond \perp, \dots, \Diamond \perp} 4'''_c \\
\frac{\Gamma}{\Box \perp, \dots, \Diamond \perp, \Diamond \Gamma} d'_c \quad \frac{\Gamma, \Diamond \Delta}{\Diamond \perp, \dots, \Diamond \perp, \Diamond \Gamma, \Diamond \Delta} 4_{dc}' \quad |\Gamma, \Delta| > 0 \\
m^+ = \{m, m', m''\} \quad d_m^+ = \{d_m, d'_m\} \quad 4_m^+ = \{4_m, 4'_m\} \quad 4_{dm}^+ = \{4_{dm}, 4'_{dm}\} \\
k_c^+ = \{k_c, k'_c, k''_c, k'''_c\} \quad d_c^+ = \{d_c, d'_c\} \quad 4_c^+ = \{4_c, 4'_c, 4''_c, 4'''_c\} \quad 4_{dc}^+ = \{4_{dc}, 4_{dc}'\}
\end{array}$$

Fig. 12. Extended non-normal modal logic rules incorporating weakening on \perp .

8 Non-normal modal logics

In this section, we show how to extend the results for the logics of the **S4**-plane to the non-normal modal logics of the **S4**-tesseract⁵ in Figure 1. Figure 11 shows the additional sequent rules that are needed for these logics, Figure 12 shows the variations of these rules that are needed for obtaining the decomposition in Theorem 2.2, and Figure 13 shows the extension of the table in Figure 7, defining a sound and complete sequent system for each logic. We state here only the Theorem 8.1 below, and refer the reader to the exposition in [19] for more details, references, and proofs.

Theorem 8.1 *For all modal logics X of the **S4**-tesseract, $LK\text{-}X$ is a sound and complete sequent system for the modal logic X .*

For our purpose, the most important observation is that the Decomposition Theorem 2.2 holds for all of these logics. This means that for defining combinatorial proofs for these logics, it suffices to define for RGB-cographs what it means to be X^{LL} -correct.

⁵ Observe that all the logics in the **S4**-tesseract are monotone. In fact, our methods can not be applied in presence of the rule $\frac{A, \bar{B} \quad \bar{A}, B}{\Box A, \Diamond B} E$. We therefore have to leave the investigation of combinatorial proofs for non-monotonic non-normal modal logics as an open problem for future research.

X	M	M4	MP	MP4	MD	MD4	MT	MT4
X^{seq}	$\{m\}$	$\{m, 4_m\}$	$\{m, p\}$	$\{m, p, 4_m\}$	$\{m, d_m\}$	$\{m, d_m, 4_m\}$	$\{m, t\}$	$\{m, t, 4_m\}$
X^{LL}	$\{m^+\}$	$\{m^+, 4_m^+\}$	$\{m^+, p\}$	$\{m^+, p\}$	$\{m^+, d_m^+\}$	$\{m^+, d_m^+\}$	$\{m^+\}$	$\{m^+\}$
X^\downarrow	\emptyset	$\{4^\downarrow\}$	\emptyset	$\{4^\downarrow\}$	\emptyset	$\{4^\downarrow\}$	$\{t^\downarrow\}$	$\{t^\downarrow, 4^\downarrow\}$

X	N	N4	NP	NP4	ND	ND4
X^{seq}	$\{m, n\}$	$\{m, n, 4_m\}$	$\{m, n, p\}$	$\{m, n, p, 4_m\}$	$\{m, n, d_m\}$	$\{m, n, d_m, 4_m, 4_{dm}\}$
X^{LL}	$\{m^+, n\}$	$\{m^+, n\}$	$\{m^+, n, p\}$	$\{m^+, n, p\}$	$\{m^+, n, d_m^+\}$	$\{m^+, n, d_m^+\}$
X^\downarrow	\emptyset	$\{4^\downarrow\}$	\emptyset	$\{4^\downarrow\}$	\emptyset	$\{4^\downarrow\}$

X	NT	NT4	C	C4	CD	CD4	CT	CT4
X^{seq}	$\{m, n, t\}$	$\{m, n, t, 4_m\}$	$\{k_c\}$	$\{k_c, 4_c\}$	$\{k_c, d_c\}$	$\{k_c, d_c, 4_c, 4_{dc}\}$	$\{k_c, t\}$	$\{k_c, t, 4_c\}$
X^{LL}	$\{m^+, n\}$	$\{m^+, n\}$	$\{k_c^+\}$	$\{k_c^+\}$	$\{k_c^+, d_c^+\}$	$\{k_c^+, d_c^+\}$	$\{k_c^+\}$	$\{k_c^+\}$
X^\downarrow	$\{t^\downarrow\}$	$\{t^\downarrow, 4^\downarrow\}$	\emptyset	$\{4^\downarrow\}$	\emptyset	$\{4^\downarrow\}$	$\{t^\downarrow\}$	$\{t^\downarrow, 4^\downarrow\}$

Fig. 13. Rule sets for the S4-tesseract logics not given in Figure 7

X	X^{LL}	for each \sphericalangle -equivalence class ρ in $V^\square \uplus V^\diamond$
M, MT, M4, MT4	$\{m^+\}$	$\rho = \{u, v\}$ with $u \in V^\square$ and $v \in V^\diamond$
MP, MP4	$\{m^+, p\}$	$\rho = \{u, v\}$ or $\rho = \{v\}$ with $u \in V^\square$ and $v \in V^\diamond$
MD, MD4	$\{m^+, d_m^+\}$	$\rho = \{u, v\}$ with $v \in V^\diamond$
N, NT, N4, NT4	$\{m^+, n\}$	$\rho = \{u, v\}$ or $\rho = \{u\}$ with $u \in V^\square$
NP, NP4	$\{m^+, n, p\}$	$\rho = \{u, v\}$ or $\rho = \{w\}$ with $u \in V^\square$ and $v \in V^\diamond$
ND, ND4	$\{m^+, n, d_m^+\}$	$\rho = \{u, v\}$ or $\rho = \{w\}$ with $v \in V^\diamond$ and $w \in V^\square$
C, CT, C4, CT4	$\{k_c^+\}$	$\rho = \{u, v, w_1, \dots, w_n\}$ with $u \in V^\square$ and $v, w_1, \dots, w_n \in V^\diamond$
CD, CD4	$\{k_c^+, d_c^+\}$	$\rho = \{u, v, w_1, \dots, w_n\}$ with $v, w_1, \dots, w_n \in V^\diamond$
K, KT, K4, KT4	$\{k^+\}$	$\rho = \{u, v_1, \dots, v_n\}$ with $u \in V^\square$ and $v_1, \dots, v_n \in V^\diamond$
KD, KD4	$\{k^+, d^+\}$	$\rho = \{u, v_1, \dots, v_n\}$ with $v_1, \dots, v_n \in V^\diamond$

 Fig. 14. The fourth condition an RGB-cograph has to satisfy in order to be X^{LL} -correct.

Definition 8.2 Let X be a logic in the S4-tesseract. An RGB-cograph is X^{LL} -correct, if it obeys Conditions 1–3 of Definition 4.3, together with the corresponding version of Condition 4 shown in the table in Figure 14.

Intuitively, the corresponding conditions in the table in Figure 14 verify if the number of \square - and \diamond -vertices in an \sphericalangle -equivalence class is compatible with the number of \square - and \diamond -occurrences introduced in a sequent by a single application of a sequent rule of X^{LL} .

With this we can show Theorem 4.4 for all logics in the S4-tesseract shown in Figure 1. Therefore, X -combinatorial proofs, as defined in Definition 7.7 form a sound and complete proofs system for the modal logic X , as stated in Theorems 6.3, 6.4, and 6.5, for all logics X in the S4-tesseract shown in Figure 1.

9 Conclusion and Future Work

In this paper we presented combinatorial proofs for all logics in the **S4**-tesseract. Since checking correctness of a combinatorial proof is polynomial in its size, they form a proof system in the sense of Cook and Reckhow [9]. Due to their combinatorial nature, they abstract away from the syntactic bureaucracy of more standard formalisms like sequent calculus or analytic tableaux. This leads naturally to the following notion of proof identity:

Two proofs are the same iff they have the same combinatorial proof. (13)

We conjecture that this notion of proof identity is in close correspondence to the notion of proof identity that is induced by sequent rule permutations. However, investigating the relation between the two would go beyond the scope of this paper, and we consider this to be future work. Furthermore, in order to support (13) it is necessary, not only to show how sequent proofs are related to combinatorial proofs, but also how analytic tableaux or resolution proofs or other syntactic formalisms are related to combinatorial proofs [1].

Further topics for future work include the extensions to all logics in the classical modal **S5**-cube, and also to intuitionistic modal logics. Another question is how our work relates to the recent development of combinatorial proofs for first-order logic [17].

Finally, from the proof theoretical perspective, the most interesting question for future research is the study of normalization of combinatorial proofs, as it has been done for propositional logic in [16,29].

References

1. Acclavio, M., Straßburger, L.: From syntactic proofs to combinatorial proofs. In: International Joint Conference on Automated Reasoning. pp. 481–497. Springer (2018)
2. Acclavio, M., Straßburger, L.: On combinatorial proofs for logics of relevance and entailment. In: International Workshop on Logic, Language, Information, and Computation. pp. 1–16. Springer (2019)
3. Avron, A.: The method of hypersequents in the proof theory of propositional non-classical logics. In: Logic: from foundations to applications, European Logic Colloquium. pp. 1–32. Oxford University Press (1994)
4. Benjamin, R., Straßburger, L.: Towards a combinatorial proof theory. In: Tableaux 2019. Springer (2019)
5. Brünnler, K.: Deep sequent systems for modal logic. *Archive for Mathematical Logic* **48**(6), 551–577 (2009)
6. Brünnler, K., Tiu, A.F.: A local system for classical logic. In: Nieuwenhuis, R., Voronkov, A. (eds.) LPAR 2001. LNAI, vol. 2250, pp. 347–361. Springer (2001)
7. Chaudhuri, K., Marin, S., Straßburger, L.: Focused and synthetic nested sequents. In: FoSSaCS’16. pp. 390–407. Springer (2016)
8. Chaudhuri, K., Marin, S., Straßburger, L.: Modular Focused Proof Systems for Intuitionistic Modal Logics. In: Kesner, D., Pientka, B. (eds.) FSCD’16. LIPIcs, vol. 52, pp. 16:1–16:18. Schloss Dagstuhl–Leibniz-Zentrum fuer Informatik (2016)

9. Cook, S.A., Reckhow, R.A.: The relative efficiency of propositional proof systems. *J. of Symb. Logic* **44**(1), 36–50 (1979)
10. Goré, R., Postniece, L., Tiu, A.: On the correspondence between display postulates and deep inference in nested sequent calculi for tense logics. *Logical Methods in Computer Science* **7**(2) (2011)
11. Goré, R., Ramanayake, R., et al.: Labelled tree sequents, tree hypersequents and nested (deep) sequents. *Advances in modal logic* **9**, 279–299 (2012)
12. Guglielmi, A.: A system of interaction and structure. *ACM Transactions on Computational Logic* **8**(1), 1–64 (2007)
13. Guglielmi, A., Straßburger, L.: Non-commutativity and MELL in the calculus of structures. In: *CSL 2001. LNCS*, vol. 2142, pp. 54–68. Springer (2001)
14. Hein, R., Stewart, C.: Purity through unravelling. *Structures and Deduction* pp. 126–143 (2005)
15. Hughes, D.: Proofs Without Syntax. *Annals of Math.* **164**(3), 1065–1076 (2006)
16. Hughes, D.: Towards Hilbert’s 24th problem: Combinatorial proof invariants: (preliminary version). *Electr. Notes Theor. Comput. Sci.* **165**, 37–63 (2006)
17. Hughes, D.J.D.: First-order proofs without syntax (Jun 2019)
18. Lellmann, B.: Hypersequent rules with restricted contexts for propositional modal logics. *Theoretical Computer Science* **656**, 76–105 (2016)
19. Lellmann, B., Pimentel, E.: Modularisation of sequent calculi for normal and non-normal modalities. *ACM Transactions on Computational Logic (TOCL)* **20**(2), 7 (2019)
20. Marin, S., Straßburger, L.: Label-free Modular Systems for Classical and Intuitionistic Modal Logics. In: *Advances in Modal Logic* 10 (2014)
21. Möhring, R.H.: Computationally tractable classes of ordered sets. In: Rival, I. (ed.) *Algorithms and Order*, pp. 105–194. Kluwer (1989)
22. Negri, S.: Proof analysis in modal logic. *Journal of Philosophical Logic* **34**(5-6), 507 (2005)
23. Retoré, C.: Pomset logic: a non-commutative extension of classical linear logic. In: *TLCA 1997*. pp. 300–318. Springer (1997)
24. Retoré, C.: Handsome proof-nets: perfect matchings and cographs. *Theor. Comput. Sci.* **294**(3), 473–488 (2003)
25. Simpson, A.K.: The proof theory and semantics of intuitionistic modal logic. Ph.D. thesis, University of Edinburgh. College of Science and Engineering (1994)
26. Stewart, C., Stouppa, P.: A systematic proof theory for several modal logics. *Advances in modal logic* **5**, 309–333 (2004)
27. Straßburger, L.: A characterization of medial as rewriting rule. In: *RTA’07*. vol. 4533, pp. 344–358. Springer (2007)
28. Straßburger, L.: Cut elimination in nested sequents for intuitionistic modal logics. In: Pfenning, F. (ed.) *FoSSaCS’13. LNCS*, vol. 7794, pp. 209–224. Springer (2013)
29. Straßburger, L.: Combinatorial flows and their normalisation. In: Miller, D. (ed.) *FSCD’17. LIPIcs*, vol. 84, pp. 31:1–31:17. Schloss Dagstuhl (2017)
30. Straßburger, L.: The problem of proof identity, and why computer scientists should care about Hilbert’s 24th problem. *Philosophical Transactions of the Royal Society A* **377**(2140), 20180038 (2019)
31. Thiele, R.: Hilbert’s twenty-fourth problem. *American Math. Monthly* **110**, 1–24 (2003)
32. Wansing, H.: Sequent calculi for normal modal propositional logics. *Journal of Logic and Computation* **4**(2), 125–142 (1994)
33. Wansing, H.: Sequent systems for modal logics. In: *Handbook of philosophical logic*, pp. 61–145. Springer (2002)