



HAL
open science

Output Global Oscillatory Synchronization of Heterogeneous Systems

Hafiz Ahmed, Rosane Ushirobira, Denis Efimov, Leonid Fridman, Yongqiang
Wang

► **To cite this version:**

Hafiz Ahmed, Rosane Ushirobira, Denis Efimov, Leonid Fridman, Yongqiang Wang. Output Global Oscillatory Synchronization of Heterogeneous Systems. International Journal of Control, 2019, 10.1080/00207179.2019.1690689 . hal-02344850

HAL Id: hal-02344850

<https://inria.hal.science/hal-02344850>

Submitted on 4 Nov 2019

HAL is a multi-disciplinary open access archive for the deposit and dissemination of scientific research documents, whether they are published or not. The documents may come from teaching and research institutions in France or abroad, or from public or private research centers.

L'archive ouverte pluridisciplinaire **HAL**, est destinée au dépôt et à la diffusion de documents scientifiques de niveau recherche, publiés ou non, émanant des établissements d'enseignement et de recherche français ou étrangers, des laboratoires publics ou privés.

ARTICLE TEMPLATE

Output Global Oscillatory Synchronization of Heterogeneous Systems

Hafiz Ahmed^a, Rosane Ushirobira^b, Denis Efimov^b, Leonid Fridman^c and Yongqiang Wang^d

^aSchool of Mechanical, Aerospace & Automotive Engineering, Coventry University, Coventry CV1 2TL, United Kingdom.

^bInria, Univ. Lille, CNRS, UMR 9189 – CRISAL - Centre de Recherche en Informatique Signal et Automatique de Lille, F-59000 Lille, France.

^cDepartamento de Ingeniería de Control y Robótica, Universidad Nacional Autónoma de México (UNAM), 04510, México D.F., Mexico.

^dDepartment of Electrical and Computer Engineering, Clemson University, Clemson, SC 29634, USA.

ARTICLE HISTORY

Compiled November 4, 2019

Abstract

The global output synchronization problem for heterogeneous nonlinear systems having relative degree 2 or higher is studied. The proposed approach consists in two steps. First, a partial projection of individual subsystems into the Brockett oscillators is performed using a sliding-mode control. Second, the network of these oscillators is synchronized using the global synchronization results of a particular second order nonlinear oscillator model from Ahmed et al. (2019). Our approach is based on output feedback and uses a higher order sliding mode observer to estimate the states and perturbations of the synchronized nonlinear systems. Along with numerical simulations, the performance of the proposed synchronization scheme is experimentally verified on a network of Van der Pol oscillators.

KEYWORDS

Output synchronization, Sliding mode observation, Van der Pol oscillator, Real-time control

1. Introduction

Over the last decade, the synchronization of complex dynamical systems and/or network of systems has attracted a great deal of attention from multidisciplinary research communities due to their pervasive presence in nature, technology and human society [Blekhman (1988); Pikovsky et al. (2003); Strogatz (2003); Osipov et al. (2007)]. Among potential application domains of synchronization, it is worth to mention the smooth operations of microgrid [Efimov et al. (2016); Schiffer et al. (2014)], secure communication [Martínez-Guerra et al. (2016); Fradkov & Markov (1997)], deployment of mobile sensor networks [Wang et al. (2012)], formation control [Ren & Beard (2008)], chaos synchronization [Rodriguez et al. (2009)], genetic oscillators [Efimov (2015)], *etc.*

Significant progress have been made in the past decade in the area of control design for synchronization, consensus or motion coordination, the existing literature is huge and covers a wide area of topics [Gazi & Passino (2011); Olfati-Saber et al. (2007); Panteley & Loría (2017)]. Until now, a large number of works are available on the problem of synchronization of networks with identical nodes, particularly when the nodes are linear time-invariant systems [Scardovi & Sepulchre (2009); Olfati-Saber et al. (2007)]. However, most physical systems are often not identical and frequently they are nonlinear in nature. The behavior of dynamical networks with heterogeneous nodes is much more complicated than the identical-node case. Usually, no common equilibrium for all nodes exists even if each isolated system has an equilibrium, the same for other invariant solutions, which can be destroyed or created by synchronization protocols.

The study of synchronization of dynamical networks with heterogeneous nodes is complicated and very few results have been reported by now. Some attempts have been made recently to propose output synchronization of heterogeneous systems and most of them employ the *internal model principle* [Wieland et al. (2011); Isidori et al. (2014); De Persis & Jayawardhana (2014); Liu et al. (2015); Bidram et al. (2014)]. The main idea is to assign each agent a (identical) local reference generator. The control algorithm then consists of two layers: a protocol, synchronizing the (identical) reference generators and local model-matching controllers, synchronizing the agents to their generators. Since agents share the same internal model, global network information is needed to implement the distributed controllers. Some other results are also available in the literature for particular classes of systems. For example, in Ahmed et al. (2016), the authors have proposed robust synchronization for homogeneous/heterogeneous multi-stable systems. However, the systems are assumed to admit a decomposition without cycles (neither homoclinic nor heteroclinic orbits). Recently, the results of Ahmed et al. (2016) have been applied to a multi-stable oscillator model [Ahmed et al. (2019)].

The goal of this work is to address the issue of synchronization of heterogeneous nonlinear systems using output feedback only, and an additional sub-goal is to have an oscillatory behavior in the synchronized state. Since many engineering systems have relative degree 2 or higher (*e.g.*, pendulum systems, oscillators, robot manipulators, DC motor), the particular focus is put on this class of systems. Studying heterogeneous systems in general setting, we will assume that neither an equilibrium for each isolated node nor a synchronization manifold exists, so to synchronize them it is necessary to apply a feedback transformation [Khalil (2014)] that projects all subsystems to a common (not necessarily identical) dynamics that can be synchronized next (the internal model principle). In this paper, the Brockett oscillator model is selected for this purpose. This is motivated by a global synchronization control recently proposed for such systems in Ahmed et al. (2019). Then higher order sliding mode (HOSM) observer is applied to estimate the unmeasurable states and perturbations using the idea presented in Fridman et al. (2008). In short, the main idea is to compensate the nonlinearities of individual systems followed by a nonlinear injection converting some parts of the systems into the Brockett oscillator form. The only restriction is that the individual systems should have relative degree 2 or higher (see Appendix for the definition), but most popular nonlinear benchmarks satisfy this criteria provided that the output signal is properly selected.

In this work, we have considered the output oscillatory synchronization of heterogeneous nonlinear systems. Potential applications for such a kind of synchronization include grid synchronization and load-sharing among DC/AC Inverters, to name a few. Grid current controllers working in synchronous reference frame require the phase of the grid voltage signal. This signal cannot be measured but can only be estimated.

Using the idea of master-slave output synchronization of oscillatory system, [Ahmed et al. (2019); Pay & Ahmed (2019); Ahmed et al. (2019)] estimated the phase of the grid voltage signal. In this approach, the grid voltage is considered as the output of the master oscillator while the slave oscillator tracks the master oscillator to estimate the parameters with oscillating dynamics. Similarly in the context of multiple oscillators, Virtual Oscillator Control (VOC) [Sinha et al. (2017)] for load sharing among multiple inverters can be considered as another potential application of the class of synchronization studied in this paper.

Main contribution: this paper studies the global output synchronization problem of nonlinear SISO (affine in control) heterogeneous multi-agent systems in a general setting. The proposed distributed synchronizing control law does not require any global network (or leader) information and uses the coupling with neighboring agents only. It can be applied to a network of systems having different orders. Moreover, precise information about the system parameters, uncertainties/disturbances *etc.*, are also not needed as they are locally estimated using HOSM observer.

A preliminary conference version of this article has been presented in Ahmed et al. (2017) where the authors consider only the case when all the agents have same relative degree. In this article, the results are extended for systems having different relative degrees and dimensions. All the omitted technical proofs of Ahmed et al. (2017) are included in the current manuscript. Moreover, experimental results are provided to demonstrate the feasibility of the proposed controllers for real-time application. The results presented in this work use feedback transformation to project the subsystems dynamics to a common dynamics of Brockett oscillator [Ahmed et al. (2019)]. The results of Ahmed et al. (2019) are only applicable to the Brockett oscillator model which is of second order. However, the current work considers the global output synchronization problem of nonlinear SISO (affine in control) heterogeneous multi-agent systems in a general setting. This is a significant development with respect to Ahmed et al. (2019).

The rest of the article is organized as follows: Section 2 gives the problem statement followed by the synchronizing control design in Section 3. In Section 4, simulation and experimental studies are given, and finally Section 5 concludes this article. Preliminaries on relative degree and a summary of the result of Ahmed et al. (2019) can be found in the Appendix.

2. Problem Statement

The following family of nonlinear SISO systems (affine in control) is considered in this work for $i = \overline{1, N} = 1, \dots, N$ with $N > 1$:

$$\begin{aligned}\dot{x}_i &= f_i(x_i) + g_i(x_i)u_i, \\ y_i &= h_i(x_i),\end{aligned}\tag{1}$$

where $x_i \in \mathbb{R}^{n_i}$ is the state, $u_i \in \mathbb{R}$ ($u_i : \mathbb{R}_+ \rightarrow \mathbb{R}$ is locally essentially bounded and measurable signal) is the input, $y_i \in \mathbb{R}$ is the output; $f_i : \mathbb{R}^{n_i} \rightarrow \mathbb{R}^{n_i}$, $h_i : \mathbb{R}^{n_i} \rightarrow \mathbb{R}$ and $g_i : \mathbb{R}^{n_i} \rightarrow \mathbb{R}^{n_i}$ are sufficiently smooth functions. Denote the common state vector of (1) as $x = [x_1^T, \dots, x_N^T]^T \in \mathbb{R}^n$ with $n = \sum_{i=1}^N n_i$, $y = [y_1, \dots, y_N]^T \in \mathbb{R}^N$ as the common output, and $u = [u_1, \dots, u_N]^T \in \mathbb{R}^N$ as the common input. The relative degree condition (see Appendix) imposed on system (1) is summarized by the following assumptions:

Assumption 1. For all $i = \overline{1, N}$, the systems in (1) have global uniform relative degree $r_i \in [2, n_i]$ and a globally defined normal form [Marino & Tomei (1996)].

Under this assumption, for each subsystem in (1) there is a diffeomorphic transformation of coordinates $T_i : \mathbb{R}^n \rightarrow \mathbb{R}^n$ such that [Marino & Tomei (1996); Khalil (2014)]:

$$\begin{bmatrix} \eta_i \\ \xi_i \end{bmatrix} = T_i(x_i),$$

where $\xi_i \in \mathbb{R}^{r_i}$ and $\eta_i \in \mathbb{R}^{n_i - r_i}$ are new components of the state, and for all $i = \overline{1, N}$ the i^{th} subsystem of (1) can be represented in the normal form:

$$\dot{\eta}_i = \varphi_i(\eta_i, \xi_i), \quad (2)$$

$$\dot{\xi}_i = A_{r_i}\xi_i + b_{r_i}[\alpha_i(\xi_i) + \beta_i(\xi_i)u_i], \quad (3)$$

$$y_i = c_{r_i}\xi_i,$$

where $\varphi_i : \mathbb{R}^{n_i} \rightarrow \mathbb{R}^{n_i - r_i}$, $\alpha_i : \mathbb{R}^{r_i} \rightarrow \mathbb{R}$ and $\beta_i : \mathbb{R}^{r_i} \rightarrow \mathbb{R}$ are smooth functions, β_i is separated from zero, and

$$A_{r_i} = \begin{bmatrix} 0 & 1 & 0 \dots 0 & 0 \\ 0 & 0 & 1 \dots 0 & 0 \\ \vdots & \vdots & \ddots & \vdots \\ 0 & 0 & 0 \dots 0 & 1 \\ 0 & 0 & 0 \dots 0 & 0 \end{bmatrix}, \quad b_{r_i} = \begin{bmatrix} 0 \\ 0 \\ \vdots \\ 0 \\ 1 \end{bmatrix},$$

$$c_{r_i} = [1 \quad 0 \dots 0]$$

are in the canonical form. The subsystem (2) is called the *zero dynamics* of i^{th} subsystem in (1), which we assume to be robustly stable:

Assumption 2. For all $i = \overline{1, N}$, the systems in (2) are input-to-state stable (ISS) with respect to the inputs ξ_i [Sontag (1989); Dashkovskiy et al. (2011); Angeli & Efimov (2015)].

Concerning the definitions of ISS property used in this work, we will not distinguish ISS with respect to a set in the conventional sense [Dashkovskiy et al. (2011)] or for a multistable system [Angeli & Efimov (2015)], the only property we need here is the boundedness of the variables η_i for bounded ξ_i . More detailed analysis of the possible asymptotic behavior in (2) for the latter scenario is presented in Forni & Angeli (2015).

Then the synchronization problem consists in finding a control u such that the members of the family (1) perform synchronous (in phase) oscillations. Since the states of the subsystems in (1) may have different dimensions n_i , a state synchronization error $x_i - x_j$ cannot be defined in general (*i.e.* the states of the subsystems in (1) cannot follow their neighbors), but an output synchronization can be formulated:

Definition 1. The family (1) exhibits a *global output synchronization* if

$$\lim_{t \rightarrow \infty} (y_i(t) - y_j(t)) = 0, \quad \forall i, j = \overline{1, N}$$

for any initial conditions $x_i(0) \in \mathbb{R}^{n_i}$, $i = \overline{1, N}$.

Note that under Assumption 1 an additional requirement can be imposed on synchronization of derivatives:

$$\lim_{t \rightarrow \infty} \{\dot{y}_i(t) - \dot{y}_j(t)\} = 0 \quad \forall i, j = \overline{1, N},$$

and an auxiliary restriction for synchronization is

$$y_i(t) \neq \text{constant} \quad \forall i = \overline{1, N},$$

i.e. the systems perform a kind of oscillations in the synchronous mode.

An output feedback controller has to be designed to achieve the global output synchronization for (1).

3. Synchronization control design

The idea of this work is to design a feedback controller that will convert a part of subsystems (3) into the form of the Brockett oscillator [Brockett (2013)] through non-linearity injection. Then global synchronization results can be easily obtained using the control proposed in Ahmed et al. (2019) (a summary is given in Appendix). However, this controller requires all components of the state vector to be available, which limits its implementation. Therefore, to overcome this difficulty, a high-order sliding-mode observer is used.

To simplify the presentation of the forthcoming synchronization protocol design, let us assume that

$$u_i + d_i = \alpha_i(\xi_i) + \beta_i(\xi_i)u_i,$$

where $d_i \in \mathbb{R}$ is a new disturbance signal in (3) for each $i = \overline{1, N}$ (since β_i is not singular, such a representation always exists), and it may represent a parametric mismatch in the functions $\alpha_i(\xi_i)$ and $\beta_i(\xi_i)$, but mainly it is introduced to model the estimation errors for the unmeasured state components ξ_i . In such a case, if the further proposed observer for ξ_i ensures its estimation, d_i is always bounded and converging to zero or its vicinity. Finite-time convergence of d_i using observer structure similar to the proposed one can also be found in the literature, *cf.* Ríos et al. (2018). These useful properties are reflected in the following assumption:

Assumption 3. *For all $i = \overline{1, N}$, the unknown input $d_i : \mathbb{R}_+ \rightarrow \mathbb{R}$ is continuously differentiable for almost all $t \geq 0$, and there is a constant $0 < \nu^+ < +\infty$ such that $\text{ess sup}_{t \geq 0} |\dot{d}_i(t)| \leq \nu^+$.*

The condition imposed by Assumption 3 is also satisfied by many engineering systems, e.g. stepper motor [Defoort et al. (2009), Assumption 1], DC/AC power inverter [Gadelovits et al. (2019), Eq. (2)], hydraulic actuators [Ruderman et al. (2019), Eq. (12)], to name a few. In many applications the disturbances are harmonic signals (coming from vibration of a part of the plant), Assumption 3 is also valid in those cases.

3.1. Observer design

Following the ideas presented in Fridman et al. (2008) and Levant (2003), let us first consider decoupling the input and disturbance. For that purpose, let us consider first, for all $i = \overline{1, N}$ a Luenberger observer [Luenberger (1964)] for (3):

$$\dot{\zeta}_i = A_{r_i} \zeta_i + b_{r_i} u_i + l_i (y_i - c_{r_i} \zeta_i), \quad (4)$$

where $\zeta_i \in \mathbb{R}^{r_i}$ is an auxiliary variable (an estimate of ξ_i through a Luenberger observer), and $l_i \in \mathbb{R}^{r_i}$ is the observer gain designed such that the matrix $A_{r_i} - l_i c_{r_i}$ is Hurwitz. The estimation error $e_i = \xi_i - \zeta_i$ yields the following differential equation:

$$\dot{e}_i = (A_{r_i} - l_i c_{r_i}) e_i + b_{r_i} d_i,$$

and to estimate also the unknown input d_i , we consider an extended error vector:

$$\tilde{e}_i = [e_i^T \ d_i]^T.$$

Then from the available measurement output signal $\psi_i = c_{r_i} e_i$, we obtain:

$$\dot{\tilde{e}}_i = A_{r_i+1} \tilde{e}_i - \tilde{l}_i \psi_i + b_{r_i+1} \dot{d}_i,$$

where $\tilde{l}_i = [l_i^T \ 0]^T$. Based on Levant (2003), the following high order sliding mode differentiator can be applied to estimate the error \tilde{e}_i :

$$\begin{aligned} \dot{z}_{i,1} = \nu_{i,1} &= -\lambda_{i,1} |z_{i,1} - \psi_i|^{\frac{r_i}{r_i+1}} \text{sign}(z_{i,1} - \psi_i) \\ &\quad + z_{i,2} - \tilde{l}_{i,1} \psi_i, \\ \dot{z}_{i,j} = \nu_{i,j} &= -\lambda_{i,j} |z_{i,j} - \nu_{i,j-1}|^{\frac{r_i-j+1}{r_i-j+2}} \text{sign}(z_{i,j} - \nu_{i,j-1}) \\ &\quad + z_{i,j+1} - \tilde{l}_{i,j} \psi_i, \quad j = \overline{2, r_i}, \\ \dot{z}_{i,r_i+1} &= -\lambda_{i,r_i+1} \text{sign}(z_{i,r_i+1} - \nu_{i,r_i}), \end{aligned} \quad (5)$$

where $\lambda_i = [\lambda_{i,1} \dots \lambda_{i,r_i+1}]^T \in \mathbb{R}^{r_i+1}$ is the vector of tuning parameters. The system (1) equipped with the observer (4), (5) is discontinuous due to the presence of sign function. The classical theory of differential equations is now not applicable since Lipschitz assumptions are employed to guarantee the existence of unique solutions. The solutions of the system (1) equipped with the observer (4), (5) are to be understood in the Filippov sense [Filippov (2013)]. The solution concept proposed by Filippov for a differential equation with discontinuous right-hand-side is constructed as the ‘‘average’’ of the solutions obtained from approaching the point of discontinuity from different directions.

Denote by

$$\widehat{\xi}_i = \zeta_i + \begin{bmatrix} z_{i,1} \\ \vdots \\ z_{i,r_i} \end{bmatrix}, \quad \widehat{d}_i = z_{i,r_i+1}$$

the estimates of ξ_i and d_i , respectively, provided by the observers (4) and (5). Then the following result can be proven:

Proposition 2. *Let assumptions 1 and 3 be satisfied, the matrices $A_{r_i} - l_i c_{r_i}$ be Hurwitz. Then there exist $\lambda_i \in \mathbb{R}^{r_i+1}$ ($\lambda_{i,r_i+1} > \nu^+$ for all $i = \overline{1, N}$) and $\mathcal{T}_i > 0$ such that for the system in (1) (or in (3)) and the observer in (4), (5) for all $t \geq \mathcal{T}_i$:*

$$\begin{aligned} y_i^{(j)}(t) &= \widehat{\xi}_{i,j}(t), \quad j = \overline{1, r_i}, \\ d_i(t) &= \widehat{d}_i(t). \end{aligned}$$

Proof. Under the introduced assumptions, the system (1) can be transformed to the form (2), (3). In addition, the disturbance d_i can be introduced with a bounded derivative for almost all instants of time. Next, for a properly selected λ_i the result follows Lemma 8 in Levant (2003), where the finite-time convergence and boundedness of the estimation error for (5) was proven, while the linear observer (4) serves to decouple the external disturbance d_i and the control u_i , which appear in the same equation. \square

The designed observers (4), (5) only use local input-output information u_i and y_i for each node $i = \overline{1, N}$, thus the proposed estimator is completely decentralized.

3.2. Control design

Once we have the estimates of ξ_i and d_i for all $i = \overline{1, N}$, *i.e.* the estimates for the states and the disturbances of the system (3), we are in position to design the synchronization control law.

3.2.1. The relative degree 2 case

First, assume that $r_i = 2$. Then the following synchronizing control law can be proposed for all $i = \overline{1, N}$:

$$\begin{aligned} u_i = & \underbrace{-\widehat{d}_i}_{\text{part 1}} \underbrace{-\widehat{\xi}_{i,1} - b_i \widehat{\xi}_{i,2} \left(\widehat{\xi}_{i,1}^2 + \widehat{\xi}_{i,2}^2 - 1 \right)}_{\text{part 2}} \\ & + a_i k \underbrace{\left(\widehat{\xi}_{i-1,2} - 2\widehat{\xi}_{i,2} + \widehat{\xi}_{i+1,2} \right)}_{\text{part 3}}, \end{aligned} \quad (6)$$

where $a_i > 0$, $b_i > 0$ and $k_i > 0$ are tuning parameters. The control law (6) has three parts: part 1 annihilates the nonlinearity of the original system (d_i is dependent on α_i and β_i); while part 2 injects additional nonlinearities to convert the system (3) into the form of the Brockett oscillator; finally, part 3 guarantees synchronization, since it contains the information of the left and right neighbors in the form of (17) (given in Appendix). In (6), part 1 and part 2 use only local information about the estimates calculated into the node ($\widehat{\xi}_i$ and \widehat{d}_i), and only part 3 is based on signals sent over the network in (1). Thus, the control (6) is also decentralized, as in the observer (4), (5), and just the variables $\widehat{\xi}_{i,2}(t)$ have to be communicated.

Theorem 3. *Let assumptions 1, 2 and 3 be satisfied, the matrices $A_{r_i} - l_i c_{r_i}$ be Hurwitz, $r_i = 2$ and $\lambda_i \in \mathbb{R}^{r_i+1}$ for all $i = \overline{1, N}$ be selected as in Proposition 2. Consider the system (1) with the observers (4), (5) and the synchronizing feedback control (6). If there is an index $1 \leq i \leq N$ such that $2a_i k < b_i$, then all trajectories in the closed-loop*

system are bounded, and for almost all initial conditions they converge to the largest invariant set, where the following restrictions are satisfied for all $i = \overline{1, N}$:

$$\begin{aligned} \dot{y}_{i-1} + \dot{y}_{i+1} &= (2 + \frac{b_i}{a_i k} (y_i^2 + \dot{y}_i^2 - 1)) \dot{y}_i, \\ y_i^2 + \dot{y}_i^2 &= \text{constant} \neq 0, \\ (y_i - y_{i+1})^2 + (\dot{y}_i - \dot{y}_{i+1})^2 &= \text{constant}. \end{aligned} \quad (7)$$

Proof. Since all conditions of Proposition 2 are satisfied, the observer (4), (5) is finite-time convergent and for $t \geq \mathcal{T} = \max_{1 \leq i \leq N} \mathcal{T}_i$ the estimates $y_i^{(j)}(t) = \widehat{\xi}_{i,j}(t)$ for $j = \overline{1, r_i}$ and $d_i(t) = \widehat{d}_i(t)$ are valid for all $i = \overline{1, N}$. Therefore, due to the structure of the control (6), for $t \geq \mathcal{T}$ the family (3) become a family of Brockett oscillators which implies the synchronization result stated in Theorem 9 thanks to part 3 of the controller (6). Let us prove that there is no finite-time escape of trajectories on the interval $[0, \mathcal{T}]$. The convergence of observers is independent of the form of control and the estimation errors $\xi_i - \widehat{\xi}_i$ and $d_i - \widehat{d}_i$ stay bounded for all $t \geq 0$. Then the system (3) with the control (6) can be presented in the following form:

$$\begin{aligned} \dot{\xi}_{i,1} &= \xi_{i,2} \\ \dot{\xi}_{i,2} &= \sum_{s=1}^3 \delta_{i,s} - \xi_{i,1} + b_i \xi_{i,2}, \end{aligned}$$

where

$$\begin{aligned} \delta_{i,1} &= a_i k (\xi_{i-1,2} - 2\xi_{i,2} + \xi_{i+1,2}), \\ \delta_{i,2} &= \xi_{i,1} - \widehat{\xi}_{i,1} + d_i - \widehat{d}_i - b_i (\xi_{i,2} - \widehat{\xi}_{i,2}) \\ &\quad + a_i k \{ \widehat{\xi}_{i-1,2} - \xi_{i-1,2} - 2(\widehat{\xi}_{i,2} - \xi_{i,2}) \\ &\quad \quad + \widehat{\xi}_{i+1,2} - \xi_{i+1,2} \}, \\ \delta_{i,3} &= b_i (\xi_{i,2} - \widehat{\xi}_{i,2}) |\widehat{\xi}_i|^2 - b_i \xi_{i,2} |\widehat{\xi}_i|^2 \end{aligned}$$

are auxiliary inputs, $\delta_{i,1}$ contains coupling signals, $\delta_{i,2}$ is bounded since it is composed by the observer estimation errors, and $\delta_{i,3}$ contains all nonlinear terms. Let us consider a Lyapunov function $U_i(\xi_i) = 0.5|\xi_i|^2$ for this subsystem, whose derivative takes the form (in the calculations below we will use convention for the indexes as $N + 1 = 1$):

$$\dot{U}_i = \xi_{i,2} \sum_{s=1}^3 \delta_{i,s} + b_i \xi_{i,2}^2 \leq \xi_{i,2} \sum_{s=1}^3 \delta_{i,s} + b_i U_i,$$

and the following upper estimates can be calculated using Young's inequality [Khalil

(2014)]:

$$\begin{aligned}
\xi_{i,2}\delta_{i,1} &\leq 0.5a_ik(\xi_{i-1,2}^2 + \xi_{i+1,2}^2) \leq a_ik(U_{i-1} + U_{i+1}), \\
\xi_{i,2}\delta_{i,2} &\leq 0.5(\xi_{i,2}^2 + \delta_{i,2}^2) \leq U_i + 0.5\delta_{i,2}^2, \\
\xi_{i,2}\delta_{i,3} &= b_i(\xi_{i,2} - \widehat{\xi}_{i,2})\xi_{i,2}|\widehat{\xi}_i|^2 - b_i\xi_{i,2}^2|\widehat{\xi}_i|^2 \\
&\leq b_i|\widehat{\xi}_{i,2} - \xi_{i,2}||\xi_{i,2}||\widehat{\xi}_i|^2 - b_i\xi_{i,2}^2|\widehat{\xi}_i|^2 \\
&= b_i\left(|\widehat{\xi}_{i,2} - \xi_{i,2}| - |\xi_{i,2}|\right)|\xi_{i,2}||\widehat{\xi}_i|^2 \\
&\leq b_i \begin{cases} 0 & |\widehat{\xi}_{i,2} - \xi_{i,2}| \leq |\xi_{i,2}| \\ |\widehat{\xi}_{i,2} - \xi_{i,2}|^2|\widehat{\xi}_i|^2 & |\widehat{\xi}_{i,2} - \xi_{i,2}| > |\xi_{i,2}| \end{cases}.
\end{aligned}$$

Note that

$$|\widehat{\xi}_i|^2 = |\widehat{\xi}_i - \xi_i + \xi_i|^2 \leq 2|\widehat{\xi}_i - \xi_i|^2 + 2|\xi_i|^2,$$

then finally we obtain:

$$\xi_{i,2}\delta_{i,3} \leq 2b_i|\widehat{\xi}_{i,2} - \xi_{i,2}|^2[|\widehat{\xi}_i - \xi_i|^2 + 2U_i]$$

Therefore

$$\begin{aligned}
\dot{U}_i &\leq a_ik(U_{i-1} + U_{i+1}) + (4b_i|\widehat{\xi}_{i,2} - \xi_{i,2}|^2 + b_i + 1)U_i \\
&\quad + 0.5\delta_{i,2}^2 + 2b_i|\widehat{\xi}_{i,2} - \xi_{i,2}|^2|\widehat{\xi}_i - \xi_i|^2
\end{aligned}$$

There are constants $\varrho_i > 0$ and $\varpi_i > 0$ (dependent on initial conditions) such that

$$\begin{aligned}
4b_i|\widehat{\xi}_{i,2} - \xi_{i,2}|^2 + b_i + 1 &\leq \varrho_i, \\
|\widehat{\xi}_{i,2} - \xi_{i,2}|^2|\widehat{\xi}_i - \xi_i|^2 &\leq \varpi_i,
\end{aligned}$$

consequently,

$$\dot{U}_i < a_ik(U_{i-1} + U_{i+1}) + \varrho_i U_i + 0.5\delta_{i,2}^2 + 2b_i\varpi_i$$

and considering a common Lyapunov function for (3)

$$U(\xi_1, \dots, \xi_N) = \sum_{i=1}^N U_i(\xi_i)$$

we obtain that

$$\begin{aligned}
\dot{U} &< \sum_{i=1}^N [a_ik(U_{i-1} + U_{i+1}) + \varrho_i U_i + 0.5\delta_{i,2}^2 + 2b_i\varpi_i] \\
&= \sigma U + 0.5 \sum_{i=1}^N \delta_{i,2}^2 + 4b_i\varpi_i,
\end{aligned}$$

where $\sigma = \max_{1 \leq i \leq N} \varrho_i + \max_{1 \leq i \leq N} a_i k$. Since $\delta_{i,2}$ is bounded for all $i = \overline{1, N}$ according to Proposition 2, then the above inequality implies that U admits an upper estimate exponential in time and the system is forward complete (Angeli & Sontag, 1999, Corollary 2.11). \square

Remark 4. In control (6), it is assumed that the agents are connected through a N -cycle graph¹[Pemmaraju & Skiena (2003)] similar to Ahmed et al. (2019). Other network topology may also be considered.

3.2.2. The higher relative degree case

Now, consider the general case with $r_i \geq 2$, then the parts 2 and 3 of the control (6) form a reference signal $\xi_{i,3}^d$ for the variable $\xi_{i,3}$:

$$\begin{aligned} \xi_{i,3}^d &= -\widehat{\xi}_{i,1} - b_i \widehat{\xi}_{i,2} \left(\widehat{\xi}_{i,1}^2 + \widehat{\xi}_{i,2}^2 - 1 \right) \\ &\quad + a_i k \left(\widehat{\xi}_{i-1,2} - 2\widehat{\xi}_{i,2} + \widehat{\xi}_{i+1,2} \right), \end{aligned}$$

where the parameters $a_i > 0$, $b_i > 0$ and $k_i > 0$ save their meaning, and next this reference signal has to be propagated over chain of integrators, and the part 1 of the control (6) has to be applied on the last step to annihilate d_i . Let us denote

$$\tilde{\xi}_{i,s} = \xi_{i,s} - \xi_{i,s}^d$$

as the error or realization of a desired signal $\widehat{\xi}_{i,s}^d$ by $\xi_{i,s}$ for $s = \overline{3, r_i}$. For $t \geq \mathcal{T} = \max_{1 \leq i \leq N} \mathcal{T}_i$ (the time when the estimates $y_i^{(j)}(t) = \widehat{\xi}_{i,j}(t)$ for $j = \overline{1, r_i}$ and $d_i(t) = \widehat{d}_i(t)$ are valid for all $i = \overline{1, N}$) consider the Lyapunov function from Ahmed et al. (2019):

$$\begin{aligned} V(\xi) &= \sum_{i=1}^N \frac{\alpha_i}{4} (\xi_{i,1}^2 + \xi_{i,2}^2 - 1)^2 \\ &\quad + \frac{1}{2} \sum_{i=1}^N (\xi_{i,1} - \xi_{i+1,1})^2 + (\xi_{i,2} - \xi_{i+1,2})^2, \end{aligned}$$

where $\alpha_i = \frac{b_i}{ka_i}$, then

$$\dot{V} = \sum_{i=1}^N -b_i \alpha_i^{-0.5} z^2(\xi, i) - a_i z(\xi, i) \tilde{\xi}_{i,3}$$

and $z(\xi, i) = \xi_{i-1,2} + \xi_{i+1,2} - \xi_{i,2} \{2 + \alpha_i (\xi_{i,1}^2 + \xi_{i,2}^2 - 1)\}$. Next, applying the backstepping approach [Krstic et al. (1995)], we can derive:

$$\begin{aligned} \xi_{i,4}^d &= \dot{\xi}_{i,3}^d - \kappa \tilde{\xi}_{i,3} + a_i z(\xi, i), \\ \xi_{i,s+1}^d &= \dot{\xi}_{i,s}^d - \kappa \tilde{\xi}_{i,s} - \tilde{\xi}_{i,s-1}, \quad s = \overline{4, r_i - 1}, \\ u_i &= -\widehat{d}_i + \dot{\xi}_{i,r_i}^d - \kappa \tilde{\xi}_{i,r_i} - \tilde{\xi}_{i,r_i-1}. \end{aligned} \tag{8}$$

¹A cycle graph C_N is a graph on N nodes containing a single cycle through all nodes, or in other words, N number of vertices connected in a closed chain.

With such a control algorithm, the Lyapunov function

$$W(\xi) = V(\xi) + 0.5 \sum_{i=1}^N \sum_{s=3}^{r_i} \tilde{\xi}_{i,s}^2$$

admits the time derivative

$$\dot{W} = - \sum_{i=1}^N b_i \alpha_i^{-0.5} z^2(\xi, i) + \kappa \sum_{s=3}^{r_i} \tilde{\xi}_{i,s}^2 \leq 0.$$

In order to implement the control u_i given in (8) it is necessary to calculate the derivatives $\frac{d^j \hat{\xi}_{i-1,2}(t)}{dt^j}$ and $\frac{d^j \hat{\xi}_{i+1,2}(t)}{dt^j}$ for $j = \overline{1, r_i - 3}$. Therefore, they have to be either transmitted by the network or reconstructed on-line by additional differentiators of a kind presented in (5). The latter solution is more preferable for a distributed synchronization protocol, *i.e.* for $a = -1, +1$:

$$\begin{aligned} \dot{\varrho}_{i,0}^a &= \nu_{i,0} = -\mu_{i,0} |\varrho_{i,0}^a - \hat{\xi}_{i+a,2}|^{\frac{r_i-3}{r_i-2}} \text{sign}(\varrho_{i,0}^a - \hat{\xi}_{i+a,2}) + \varrho_{i,1}^a, \\ \dot{\varrho}_{i,j}^a &= \nu_{i,j} = -\mu_{i,j} |\varrho_{i,j}^a - \nu_{i,j-1}|^{\frac{r_i-j-3}{r_i-j-2}} \text{sign}(\varrho_{i,j}^a - \nu_{i,j-1}) \\ &\quad + \varrho_{i,j+1}^a, \quad j = \overline{1, r_i - 4}, \\ \dot{\varrho}_{i,r_i-3}^a &= -\mu_{i,r_i-3} \text{sign}(\varrho_{i,r_i-3}^a - \nu_{i,r_i}), \end{aligned} \tag{9}$$

then by Lemma 8 in Levant (2003) for a proper selection of $\mu_i = [\mu_{i,0}, \dots, \mu_{i,r_i-3}]^T > 0$ there is $\mathbb{T}_i > 0$ such that

$$\varrho_{i,j}^a(t) = \hat{\xi}_{i+a,2}^{(j)}(t) \quad \forall t \geq \mathbb{T}_i$$

for all $j = \overline{0, r_i - 3}$ and $a = -1, +1$. Note that from (5), $\hat{\xi}_{i+a,2}$ has only $r_{i+a} - 1$ continuous derivatives, consequently

$$r_i \leq r_{i+a} + 2 \quad \forall i = \overline{1, N}, \quad a = -1, +1. \tag{10}$$

The following result has been proven:

Theorem 5. *Let assumptions 1, 2 and 3 be satisfied, the matrices $A_{r_i} - l_i c_{r_i}$ be Hurwitz, $r_i \geq 2$ under (10), and $\lambda_i \in \mathbb{R}^{r_i+1}$, $\mu_i \in \mathbb{R}^{r_i-2}$ be properly selected for all $i = \overline{1, N}$. Consider the system (1) with the observers (4), (5), (9) and the synchronizing feedback control (8). If there is an index $1 \leq i \leq N$ such that $2a_i k < b_i$, then all trajectories in the closed-loop system are bounded, and for almost all initial conditions they converge to the largest invariant set, where the restrictions (7) are satisfied.*

Proof. For $t \geq \max_{1 \leq i \leq N} \mathcal{T}_i + \max_{1 \leq i \leq N} \mathbb{T}_i$ all arguments presented above are valid, and the forward completeness can be proven similarly to the case of Theorem 3. \square

Remark 6. Theorem 5 doesn't assume that the relative degrees of the individual systems in a network are same. It shows that global oscillatory synchronization is possible even when the individual systems in a network have different relative degrees (see Sec. 4.1 for numerical example).

Instead of the conventional backstepping [Krstic et al. (1995)], the command filtered backstepping [Farrell et al. (2009)] can also be applied, and since it does not need derivatives of the virtual controls, the observers (9) can be avoided in this case. A drawback in this case is that exact synchronization becomes impossible.

4. Results and discussions

4.1. Numerical simulation results

In this Section, numerical simulations are considered to show the effectiveness of the proposed synchronization scheme. For this purpose, let us consider the synchronization of three heterogeneous nonlinear oscillatory systems composed of two Van der Pol oscillators and one oscillator with dynamics like Van der Pol oscillator. The dynamics of Van der Pol oscillator is given by

$$\begin{aligned}\dot{x}_{1i} &= x_{2i}, i = 1, 2 \\ \dot{x}_{2i} &= -x_{1i} + \varsigma_i \{1 - x_{1i}\} x_{2i} + u_i \\ y_i &= x_{1i}\end{aligned}\tag{11}$$

where i represents the oscillator number, x_{1i}, x_{2i} are the states, y_i is the output, ς_i is the model parameter and u_i is the control input of oscillator i . The dynamics of the third system is given by

$$\begin{aligned}\dot{x}_{1i} &= x_{2i}, \\ \dot{x}_{2i} &= x_{3i} \\ \dot{x}_{3i} &= -x_{2i} + \varsigma_i \{1 - (x_{2i})^2\} x_{3i} + u_i \\ y_i &= x_{1i}\end{aligned}\tag{12}$$

where $i = 3$ represents the oscillator number and the rest of the variables retain the same meaning as used for eq. (11). Although (12) represents one oscillator but we have used the notation i for uniformity. The parameters ς_i are selected as $\varsigma_i = 0.1 \times i$ for simulation. So, here the synchronization of systems with different relative degree and order is considered. With the output y_i , the system (11) has relative degree $r_i = n = 2$, while with the output y_i , the system (12) has relative degree $r_i = n = 3$. Then the family (11), (12) can be written in the form (3) as for $i = 1, 2$

$$\begin{bmatrix} \dot{x}_{1i} \\ \dot{x}_{2i} \end{bmatrix} = \begin{bmatrix} 0 & 1 \\ 0 & 0 \end{bmatrix} \begin{bmatrix} x_{1i} \\ x_{2i} \end{bmatrix} + \begin{bmatrix} 0 \\ 1 \end{bmatrix} \underbrace{\left[u_i + -x_{1i} + \varsigma_i \{1 - (x_{1i})^2\} x_{2i} \right]}_{d_i}\tag{13}$$

and

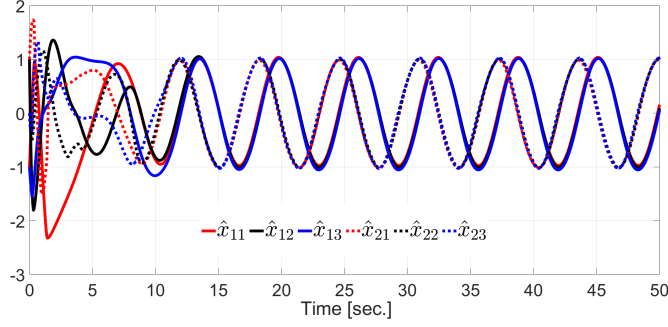

Figure 1. Evolution of the oscillator states with control (6) and (8).

$$\begin{aligned}
 \begin{bmatrix} \dot{x}_{1i} \\ x_{2i} \\ x_{3i} \end{bmatrix} &= \begin{bmatrix} 0 & 1 & 0 \\ 0 & 0 & 1 \\ 0 & 0 & 0 \end{bmatrix} \begin{bmatrix} x_{1i} \\ x_{2i} \\ x_{3i} \end{bmatrix} \\
 &+ \begin{bmatrix} 0 \\ 0 \\ 1 \end{bmatrix} \left[\underbrace{u_i + -x_{2i} + \varsigma_i \{1 - (x_{2i})^2\}}_{d_i} x_{3i} \right] \quad (14)
 \end{aligned}$$

Since the states of Van der Pol oscillators are bounded, then the disturbances d_i in (13) and (14) satisfy Assumption 3. Then, for systems (13) and (14), the design of observers (4) and (5) is straightforward. For the Van der Pol oscillators, the observer parameters are selected as $L = [20.2 \ 102]^T$, $\lambda_1 = 3M$, $\lambda_2 = 1.5M$ and $\lambda_3 = 1.1M$ for $M = 50$ while for Van der Pol like oscillator, the observer parameters are selected as $L = [30.6 \ 312.1 \ 1061.1]^T$, $\lambda_1 = 5M$, $\lambda_2 = 3M$, $\lambda_3 = 1.5M$ and $\lambda_4 = 1.1M$ for $M = 70$. With the estimated states, the synchronizing controller (6) can be easily designed for Van der Pol oscillators represented by (11). System (12) is of relative degree 3. So, the controller (8) is to be designed for (14). The parameters of the controllers are selected as: $a_1 k_1 = 0.4$, $a_2 k_2 = 0.8$, $a_3 k_3 = 1.2$, $b_1 = 1$, $b_2 = 2$, $b_3 = 3$ and $\kappa = 10$. With these values of the parameters, the conditions of Theorem 5 are satisfied.

The evolution of the oscillator states with controls (6) and (8) is given in Fig. 1. For this simulation, the oscillators were initialized as $(2, -2)$, $(0, 2)$ and $(-2, 0, 2)$. From Fig. 1, it is clear that the control (6) successfully converted the Van der Pol oscillators in a finite-time to Brockett oscillators through nonlinearity injection while the control (8) converted part of system (14) into the form of Brockett oscillator. Then the result of global synchronization follows directly from Theorem 5. The phase plot of the individual systems and the the graph of $(y_i - y_{i+1})^2 + (\dot{y}_i - \dot{y}_{i+1})^2$ as mentioned in Theorem 3 are given in figures 2 and 3 respectively. Numerical simulation results demonstrate the effectiveness the of the proposed synchronization scheme. The impact of perturbations are studied in detail in the experimental study section and skipped here to avoid repetition.

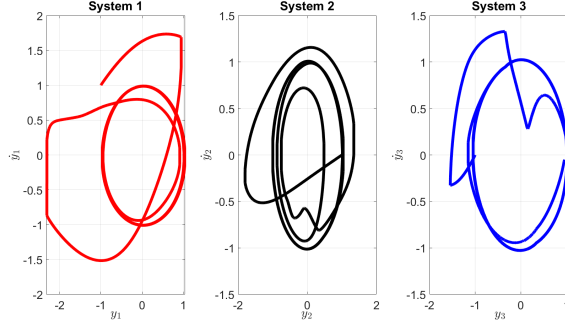

Figure 2. Phase plot i.e. y_i vs \dot{y}_i of the three systems.

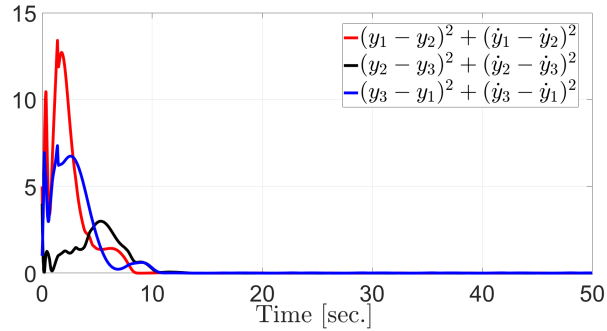

Figure 3. Graph of $(y_i - y_{i+1})^2 + (\dot{y}_i - \dot{y}_{i+1})^2$ for the three systems.

4.2. Experimental Study

To verify the practical feasibility and performance of the synchronization scheme developed in Section 3, let us consider the synchronization of a network of the Van der Pol oscillators with $N = 3$ as given by eq. (13). To implement the proposed synchronizing control, a dSPACE 1104 controller board was used. The control algorithms were implemented using Simulink. The solver was the fixed-step fourth-order Runge-Kutta and the time-step was 0.2 milliseconds. An overview of the experimental setup and the circuit diagram of an autonomous Van der Pol oscillator can be seen in Fig. 4. For experiments $\zeta_i = 0.1$ was selected in (11), and the circuit parameters of Fig. 4 are chosen accordingly (the values of the circuit parameters are skipped here for brevity). We have selected identical values of circuit parameters for the experimental realization of the network of Van der Pol oscillators. However, nonidealities and nonlinearities of the practical devices, make the oscillators heterogeneous in a practical settings. For example the resistors that are used in this experiment have a tolerance limit of $\pm 10\%$. So, even if we take the resistors of the same nominal values for individual oscillators, the final values are different due to the tolerance limit.

Van der Pol oscillator is a benchmark model for second order nonlinear system. Global synchronization of model (13) is a very interesting problem. However, it is difficult to prove analytically the global synchronization of model (13) with heterogeneous nodes. As an alternative way, it is possible to globally synchronize family (13) by transforming individual oscillators into Brockett form as mentioned in Section 3.

For system (13), the design of observers (4) and (5) are straightforward. The parameters of observers used in the experiments are $L = [20.2 \quad 102]^T$, $\lambda_1 = 3M$,

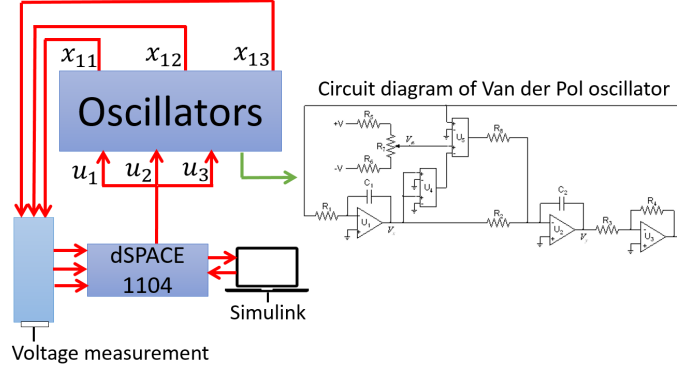

Figure 4. Schematic overview of the practical implementation and circuit diagram of an autonomous Van der Pol oscillator.

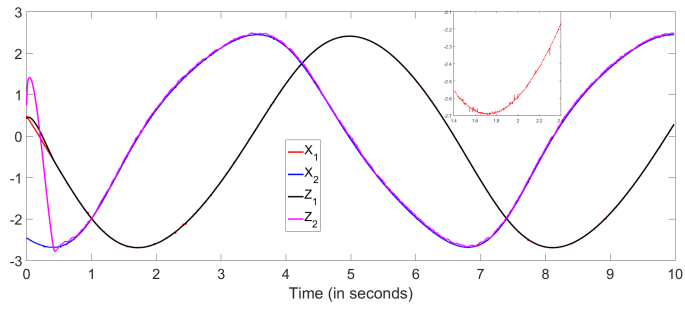

Figure 5. Convergence of the observer. A zoomed version of the the measured state variable (after analog to digital conversion) can be seen in the inset.

$\lambda_2 = 1.5M$ and $\lambda_3 = 1.1M$ for $M = 100$. With these values of the parameters, the convergence of the observed states to actual states is shown in Fig. 5, where the estimation errors converge in finite-time. Parameters of the controllers are $a_1k_1 = 1$, $a_2k_2 = 2$, $a_3k_3 = 2.5$, $b_1 = 10$, $b_2 = 20$ and $b_3 = 30$. With these values of the parameters, the conditions of Theorem 3 are satisfied. The evolution of the oscillator states with control (6) is given in Fig. 6 where it is clear that the control (6) successfully converted the family of Van der Pol oscillators in a finite-time to a family of Brockett oscillators through nonlinearity injection. Then for the family of Brockett oscillators, the result of global synchronization follows from Theorem 3. The oscillators in this case converge approximately to the unit circle in the (x_{1i}, x_{2i}) - space which is similar to the simulation results of Ahmed et al. (2019). The unit circle is inside the set Ω'_∞ where the oscillators are supposed to converge from Theorem 9. This demonstrates the effectiveness of the proposed control.

To check the robustness of the proposed control strategy, two tests were done. In the first case, successive perturbations (in the form of additional DC voltage inputs) were added to x_{23} . The evolution of the state variables and the control inputs in this case is given in Fig. 7. It is evident from Fig. 7 that the proposed control strategy is very robust with respect to perturbations. Although the oscillators lose synchrony at the beginning, they return to the synchronous state in a very short period of time due to global nature of the control (6). To further check the robustness, large amplitude perturbations were added to state x_{12} (note that the control influences directly x_{2i} , but not x_{1i} , which is why it is an interesting case to consider). The results in this case

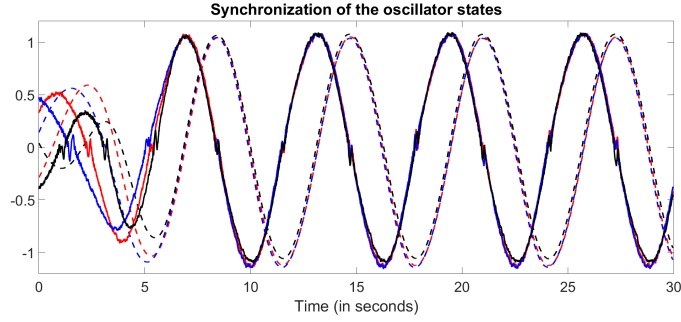

Figure 6. Evolution of the oscillator states. Solid lines - x_{2i} and dashed lines - x_{1i} .

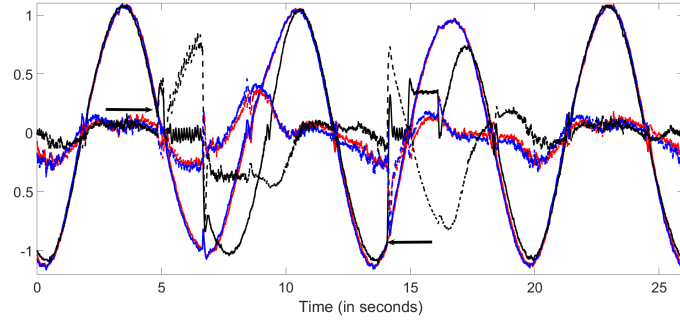

Figure 7. Evolution of the oscillator states and control inputs in the case of perturbations added to x_{23} . Solid lines - x_{2i} and dashed lines - u_i . Arrow indicates the time when perturbations were added.

are shown in Fig. 8. The experimental results again demonstrate the robustness of the proposed control. However, in this case, the oscillators need more time to synchronize because of large amplitude of perturbations and also due to the fact that x_{1i} do not depend directly on u_i .

5. Conclusion

This paper studied the problem of global synchronization of nonlinear systems with relative degree 2 and higher using an output feedback. The nonlinear systems were

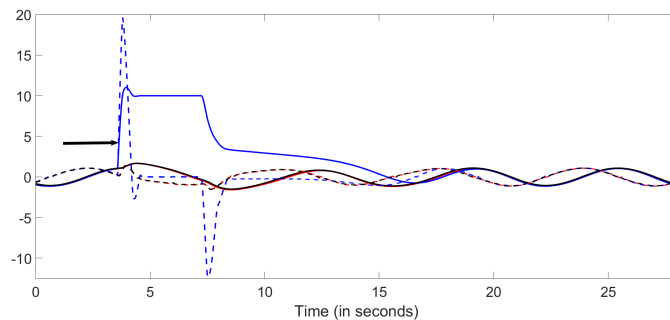

Figure 8. Evolution of the oscillator states and control inputs in the case of large amplitude perturbations added to x_{12} . Solid lines - x_{2i} and dashed lines - x_{1i} . Arrow indicates the time when the first perturbation was added.

first converted to a normal canonical form. Then higher order sliding mode observers were used to reconstruct the states and the perturbations in a finite time. Using these information, individual systems were projected to Brockett oscillator dynamics through dynamic output feedback control. The synchronization result was obtained by applying the results of Ahmed et al. (2019). Experimental study demonstrated the effectiveness of our method using a network of heterogeneous Van der Pol oscillators.

Funding

This work was partially supported by Consejo Nacional de Ciencia y Tecnologia, Mexico [grant no. 282013]; Government Council on Grants, Russian Federation [Grant 08-08]; Ministry of Education and Science of the Russian Federation [Project 14.Z50.31.0031]; Programa de Apoyo a Proyectos de Investigación e Innovación Tecnológica (UNAM), Mexico 115419; HoTSMoCE INRIA associate team program.

References

- Ahmed, H., Amamra, S.-A., & Bierhoff, M. H. (2019). Frequency-locked loop-based estimation of single-phase grid voltage parameters. *IEEE Transactions on Industrial Electronics*, *66*(11), 8856–8859.
- Ahmed, H., Bierhoff, M., & Benbouzid, M. (2019). Multiple nonlinear harmonic oscillator-based frequency estimation for distorted grid voltage. *IEEE Transactions on Instrumentation and Measurement*, 1-1. Retrieved from <https://doi.org/10.1109/TIM.2019.2931065>
- Ahmed, H., Ushirobira, R., & Efimov, D. (2019). Robust global synchronization of brockett oscillators. *IEEE Transactions on Control of Network Systems*, *6*(1), 289–298.
- Ahmed, H., Ushirobira, R., Efimov, D., Fridman, L., & Wang, Y. (2017). Oscillatory global output synchronization of nonidentical nonlinear systems. *IFAC-PapersOnLine*, *50*(1), 2708–2713.
- Ahmed, H., Ushirobira, R., Efimov, D., & Perruquetti, W. (2016). Robust synchronization for multistable systems. *IEEE Transactions on Automatic Control*, *61*(6), 1625–1630.
- Angeli, D., & Efimov, D. (2015). Characterizations of input-to-state stability for systems with multiple invariant sets. *Automatic Control, IEEE Transactions on*, *60*(12), 3242–3256.
- Angeli, D., & Sontag, E. (1999). Forward completeness, unboundedness observability, and their Lyapunov characterizations. *Systems & Control Letters*, *38*(4–5), 209–217.
- Bidram, A., Lewis, F. L., & Davoudi, A. (2014). Synchronization of nonlinear heterogeneous cooperative systems using input–output feedback linearization. *Automatica*, *50*(10), 2578–2585.
- Blekhman, I. I. (1988). *Synchronization in science and technology*. American Society of Mechanical Engineers.
- Brockett, R. (2013). Synchronization without periodicity. In K. Huper & J. Trumppf (Eds.), *Mathematical systems theory, a volume in honor of U. Helmke* (pp. 65–74). CreateSpace.
- Dashkovskiy, S., Efimov, D., & Sontag, E. (2011). Input to state stability and allied system properties. *Automation and Remote Control*, *72*(8), 1579–1614.
- Defoort, M., Nollet, F., Floquet, T., & Perruquetti, W. (2009). A third-order sliding-mode controller for a stepper motor. *IEEE Transactions on Industrial Electronics*, *56*(9), 3337–3346.
- De Persis, C., & Jayawardhana, B. (2014). On the internal model principle in the coordination of nonlinear systems. *IEEE Transactions on Control of Network Systems*, *1*(3), 272–282.
- Efimov, D. (2015). Phase resetting for a network of oscillators via phase response curve approach. *Biological cybernetics*, *109*(1), 95–108.

- Efimov, D., Schiffer, J., & Ortega, R. (2016). Robustness of delayed multistable systems with application to droop-controlled inverter-based microgrids. *International Journal of Control*, 89(5), 909–918.
- Farrell, J. A., Polycarpou, M., Sharma, M., & Dong, W. (2009). Command filtered backstepping. *IEEE Transactions on Automatic Control*, 54(6), 1391–1395.
- Filippov, A. F. (2013). *Differential equations with discontinuous righthand sides: control systems* (Vol. 18). Springer Science & Business Media.
- Forni, P., & Angeli, D. (2015). Input-to-state stability for cascade systems with decomposable invariant sets. In *Proc. IEEE 54th annual conference on decision and control (cdc)* (pp. 3742–3747).
- Fradkov, A. L., & Markov, A. Y. (1997). Adaptive synchronization of chaotic systems based on speed gradient method and passification. *IEEE Transactions on Circuits and Systems I: Fundamental Theory and Applications*, 44(10), 905–912.
- Fridman, L., Shtessel, Y., Edwards, C., & Yan, X.-G. (2008). Higher-order sliding-mode observer for state estimation and input reconstruction in nonlinear systems. *International Journal of Robust and Nonlinear Control*, 18(4-5), 399–412.
- Gadelovits, S. Y., Insepov, D., Kadirkamanathan, V., Zhong, Q., & Kuperman, A. (2019, Nov). Uncertainty and disturbance estimator based controller equipped with a multiple-time-delayed filter to improve the voltage quality of inverters. *IEEE Transactions on Industrial Electronics*, 66(11), 8947–8957. doi:
- Gazi, V., & Passino, K. M. (2011). *Swarm stability and optimization*. Springer Science & Business Media.
- Isidori, A., Marconi, L., & Casadei, G. (2014). Robust output synchronization of a network of heterogeneous nonlinear agents via nonlinear regulation theory. *IEEE Transactions on Automatic Control*, 59(10), 2680–2691.
- Khalil, H. K. (2014). *Nonlinear control*. Prentice Hall.
- Krstic, M., Kanellakopoulos, I., & Kokotovic, P. (1995). *Nonlinear and adaptive control design*. Wiley.
- Levant, A. (2003). Higher-order sliding modes, differentiation and output-feedback control. *International journal of Control*, 76(9-10), 924–941.
- Liu, H., De Persis, C., & Cao, M. (2015). Robust decentralized output regulation with single or multiple reference signals for uncertain heterogeneous systems. *International Journal of Robust and Nonlinear Control*, 25(9), 1399–1422.
- Luenberger, D. G. (1964). Observing the state of a linear system. *IEEE transactions on Military Electronics*, 8(2), 74–80.
- Marino, R., & Tomei, P. (1996). *Nonlinear control design: geometric, adaptive and robust*. Prentice Hall International (UK) Ltd.
- Martínez-Guerra, R., García, J. J. M., & Prieto, S. M. D. (2016). Secure communications via synchronization of liouvillian chaotic systems. *Journal of the Franklin Institute*, 353(17), 4384–4399.
- Olfati-Saber, R., Fax, J. A., & Murray, R. M. (2007). Consensus and cooperation in networked multi-agent systems. *Proceedings of the IEEE*, 95(1), 215–233.
- Osipov, G. V., Kurths, J., & Zhou, C. (2007). *Synchronization in oscillatory networks*. Springer Science & Business Media.
- Panteley, E., & Loria, A. (2017). Synchronisation and emergent behaviour in networks of heterogeneous systems: A control theory perspective. In *Nonlinear systems* (pp. 81–102). Springer.
- Pay, M. L., & Ahmed, H. (2019). Modeling and tuning of circular limit cycle oscillator fil with pre-loop filter. *IEEE Transactions on Industrial Electronics*, 66(12), 9632–9635.
- Pemmaraju, S., & Skiena, S. (2003). Cycles, stars, and wheels. *Computational Discrete Mathematics Combinatorics and Graph Theory in Mathematica*, 284–249.
- Pikovsky, A., Rosenblum, M., & Kurths, J. (2003). *Synchronization: a universal concept in nonlinear sciences* (Vol. 12). Cambridge university press.
- Ren, W., & Beard, R. W. (2008). *Distributed consensus in multi-vehicle cooperative control*.

- Springer.
- Ríos, H., Efimov, D., & Perruquetti, W. (2018). An adaptive sliding-mode observer for a class of uncertain nonlinear systems. *International Journal of Adaptive Control and Signal Processing*, 32(3), 511–527.
- Rodriguez, A., De Leon, J., & Fridman, L. (2009). Synchronization in reduced-order of chaotic systems via control approaches based on high-order sliding-mode observer. *Chaos, Solitons & Fractals*, 42(5), 3219–3233.
- Ruderman, M., Fridman, L., & Pasolli, P. (2019). Virtual sensing of load forces in hydraulic actuators using second-and higher-order sliding modes. *Control Engineering Practice*, 92, 104151.
- Scardovi, L., & Sepulchre, R. (2009). Synchronization in networks of identical linear systems. *Automatica*, 45(11), 2557–2562.
- Schiffer, J., Seel, T., Raisch, J., & Sezi, T. (2014). A consensus-based distributed voltage control for reactive power sharing in microgrids. In *Control conference (ecc), 2014 european* (pp. 1299–1305).
- Sinha, M., Dörfler, F., Johnson, B. B., & Dhople, S. V. (2017). Uncovering droop control laws embedded within the nonlinear dynamics of van der pol oscillators. *IEEE Transactions on Control of Network Systems*, 4(2), 347–358.
- Sontag, E. D. (1989). Smooth stabilization implies coprime factorization. *IEEE transactions on automatic control*, 34(4), 435–443.
- Strogatz, S. H. (2003). *Sync: How order emerges from chaos in the universe, nature, and daily life*. Hyperion.
- Wang, Y., Nunez, F., & Doyle, F. J. (2012). Energy-efficient pulse-coupled synchronization strategy design for wireless sensor networks through reduced idle listening. *IEEE Transactions on Signal Processing*, 60(10), 5293–5306.
- Wieland, P., Sepulchre, R., & Allgöwer, F. (2011). An internal model principle is necessary and sufficient for linear output synchronization. *Automatica*, 47(5), 1068–1074.

Appendix

A. Relative Degree

Consider the following nonlinear system

$$\begin{aligned} \dot{x} &= f(x) + g(x)u, \\ y &= h(x), \end{aligned} \tag{15}$$

where $x \in \mathbb{R}^n$ is the state vector, $u \in \mathbb{R}$ is the input, $y \in \mathbb{R}$ is the output variable of the system, f and g are smooth vector fields. A vector field is said to be *forward complete* if all solutions to $\dot{x} = f(x)$ are defined for all $t \geq 0$ [Khalil (2014)].

Definition 7. (Global Uniform Relative Degree [Marino & Tomei (1996)]) The *global uniform relative degree* r of (15) is defined as the integer such that

$$\begin{aligned} L_g L_f^i h(x) &= 0, \quad \forall x \in \mathbb{R}^n, \quad 0 \leq i \leq r - 2, \\ L_g L_f^{r-1} h(x) &\neq 0, \quad \forall x \in \mathbb{R}^n. \end{aligned}$$

We say that $r = \infty$ if

$$L_g L_f^i h(x) = 0, \quad \forall x \in \mathbb{R}^n, \quad \forall i \geq 0.$$

B. Synchronization of Brockett oscillators

The following family of Brockett oscillators [Brockett (2013)] is considered in this section for some $N > 1$:

$$\begin{aligned}\dot{x}_{1i} &= x_{2i}, \\ \dot{x}_{2i} &= a_i u_i - x_{1i} - b_i x_{2i} (|x_i|^2 - 1), i = \overline{1, N},\end{aligned}\quad (16)$$

where $a_i, b_i > 0$ are the parameters of an individual oscillator, the state $x_i = [x_{1i} \ x_{2i}]^T \in \mathbb{R}^2$ and the control $u_i \in \mathbb{R}$ ($u_i : \mathbb{R}_+ \rightarrow \mathbb{R}$ is locally essentially bounded and measurable signal). Denote the common state vector of (16) by $x = [x_1^T, \dots, x_N^T]^T \in \mathbb{R}^{2N}$ and the common input by $u = [u_1, \dots, u_N]^T \in \mathbb{R}^N$.

The following synchronizing control is selected for family (16):

$$u = kM \begin{bmatrix} x_{21} \\ \vdots \\ x_{2(N-1)} \\ x_{2N} \end{bmatrix}, \quad (17)$$

where $k > 0$ is the coupling strength and

$$M = \begin{bmatrix} -2 & 1 & 0 & \cdots & 1 \\ 1 & -2 & 1 & \cdots & 0 \\ 0 & 1 & -2 & \cdots & 0 \\ \vdots & & \vdots & \ddots & 0 \\ 1 & \cdots & 0 & 1 & -2 \end{bmatrix}$$

is the interconnection matrix. From a graph theory point of view, the oscillators are connected through a N -cycle graph [Pemmaraju & Skiena (2003)] (each oscillator needs only the information of its left and right neighbors). Define the synchronization error among the various states of the oscillators as

$$e_{2i-1} = x_{1i} - x_{1(i+1)}, \quad \dot{e}_{2i-1} = x_{2i} - x_{2(i+1)} = e_{2i}$$

and $e_{2N-1} = x_{1N} - x_{11}$, $\dot{e}_{2N-1} = x_{2N} - x_{21} = e_{2N}$. Then the main results of Ahmed et al. (2019) can be summarized as below:

Proposition 8. [Ahmed et al. (2019)] For any $k > 0$ in the system (16), (17) all trajectories are bounded and converge to the largest invariant set in

$$\Omega_\infty = \left\{ x \in \mathbb{R}^{2N} : |x_i| = \text{const}, \quad e_{2i-1}^2 + e_{2i}^2 = \text{const}, \right. \\ \left. x_{2(i-1)} + x_{2(i+1)} = \left(2 + \frac{b_i}{a_i k} (|x_i|^2 - 1)\right) x_{2i}, i = \overline{1, N} \right\}.$$

Theorem 9. [Ahmed et al. (2019)] For any $k > 0$, if there is an index $1 \leq i \leq N$ such that $2a_i k < b_i$, then in the system (16), (17) all trajectories are bounded and almost

all of them converge to the largest invariant set in

$$\Omega'_\infty = \left\{ x \in \mathbb{R}^{2N} : |x_i| = \text{const} \neq 0, e_{2i-1}^2 + e_{2i}^2 = \text{const}, \right. \\ \left. x_{2(i-1)} + x_{2(i+1)} = \left(2 + \frac{b_i}{a_i k} (|x_i|^2 - 1)\right) x_{2i}, i = \overline{1, N} \right\}.$$

In the set Ω_∞ we have for all $i = \overline{1, N}$:

$$x_{1i}^2 + x_{2i}^2 = r_i^2, \\ \rho_i^2 = e_{2i-1}^2 + e_{2i}^2 = r_i^2 + r_{i+1}^2 - 2(x_{1i}x_{1(i+1)} + x_{2i}x_{2(i+1)})$$

for some $r_i \in \mathbb{R}_+$ and $\rho_i \in \mathbb{R}_+$, and

$$x_{2(i-1)} + x_{2(i+1)} = \beta_i x_{2i}, \quad x_{1(i-1)} + x_{1(i+1)} = \beta_i x_{1i} + c_i \quad (18)$$

for $\beta_i = 2 + \alpha_i(r_i^2 - 1)$, $\alpha_i = \frac{b_i}{ka_i}$ and some $c_i \in \mathbb{R}$.

Corollary 10. [Ahmed et al. (2019)] *Let all conditions of Theorem 9 be satisfied, and all solutions of the following equations*

$$\rho_i^2 = \frac{1 + \alpha_i(r_i^2 - 1)}{2 + \alpha_i(r_i^2 - 1)} r_{i+1}^2 - (1 + \alpha_i(r_i^2 - 1)) r_i^2 \\ + \frac{1}{2 + \alpha_i(r_i^2 - 1)} r_{i-1}^2, \quad i = \overline{1, N}, \quad (19)$$

$$0 = \sum_{i=1}^N (\rho_i^2 - r_i^2 - r_{i+1}^2) k(a_i + a_{i+1}) \\ + 2r_i^2 (b_i(r_i^2 - 1) + 2ka_i), \quad (20)$$

with $r_i \neq 1$ admit the restriction:

$$r_i^2 < \frac{1}{3} \left(1 - 2 \frac{ka_i}{b_i} \right) \quad (21)$$

for some $1 \leq i \leq N$. Then for almost all initial conditions the system (16), (17) is synchronized.