



HAL
open science

Motion anticipation in the retina

Bruno Cessac, Selma Souihel

► **To cite this version:**

Bruno Cessac, Selma Souihel. Motion anticipation in the retina. NeuroSTIC 2019 - 7e édition des journées NeuroSTIC, Oct 2019, Sophia-Antipolis, France. hal-02316888

HAL Id: hal-02316888

<https://inria.hal.science/hal-02316888>

Submitted on 15 Oct 2019

HAL is a multi-disciplinary open access archive for the deposit and dissemination of scientific research documents, whether they are published or not. The documents may come from teaching and research institutions in France or abroad, or from public or private research centers.

L'archive ouverte pluridisciplinaire **HAL**, est destinée au dépôt et à la diffusion de documents scientifiques de niveau recherche, publiés ou non, émanant des établissements d'enseignement et de recherche français ou étrangers, des laboratoires publics ou privés.

Motion anticipation in the retina

Bruno Cessac, Selma Souihel

Biovision INRIA team



Motion anticipation in the retina

Bruno Cessac, **Selma Souihel**

Biovision INRIA team





Motion anticipation in the retina

Bruno Cessac, **Selma Souihel**

Biovision INRIA team



In collaboration with :

Matteo Di Volo
Alain Destexhe



Frédéric Chavane
Sandrine Chemla



Olivier Marre



The visual flow

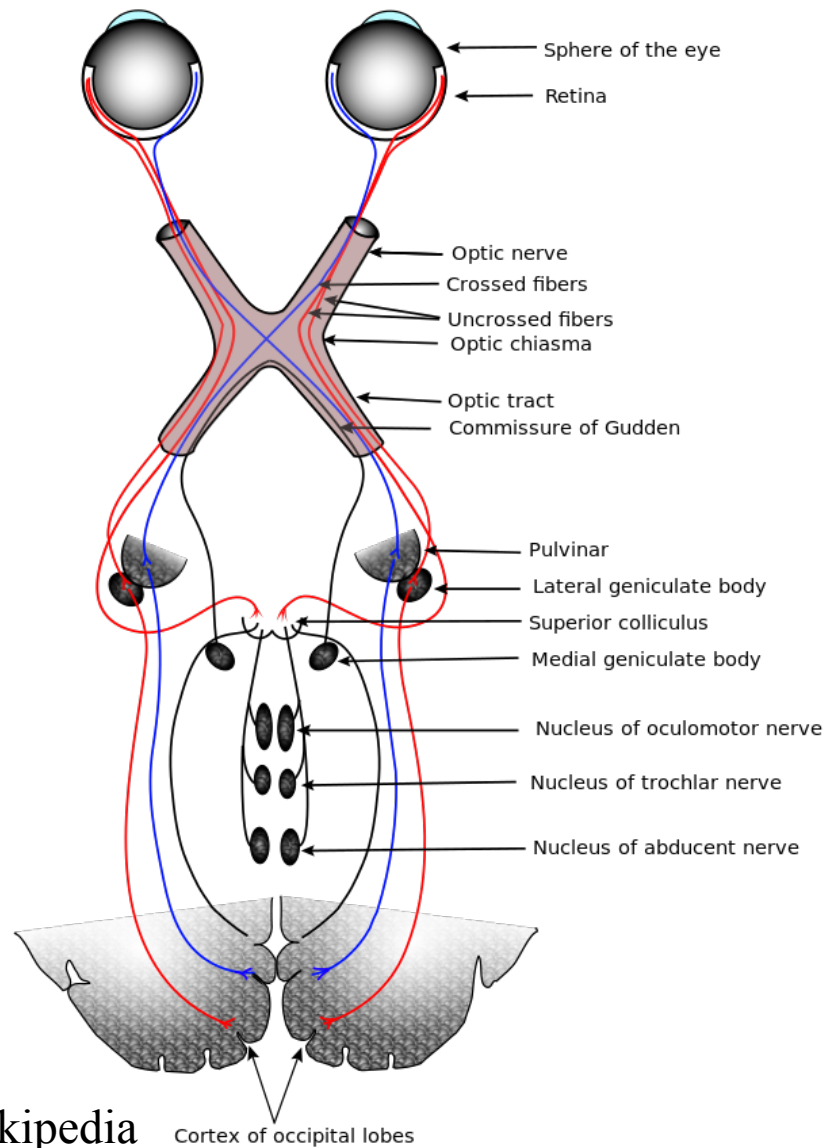

The visual flow

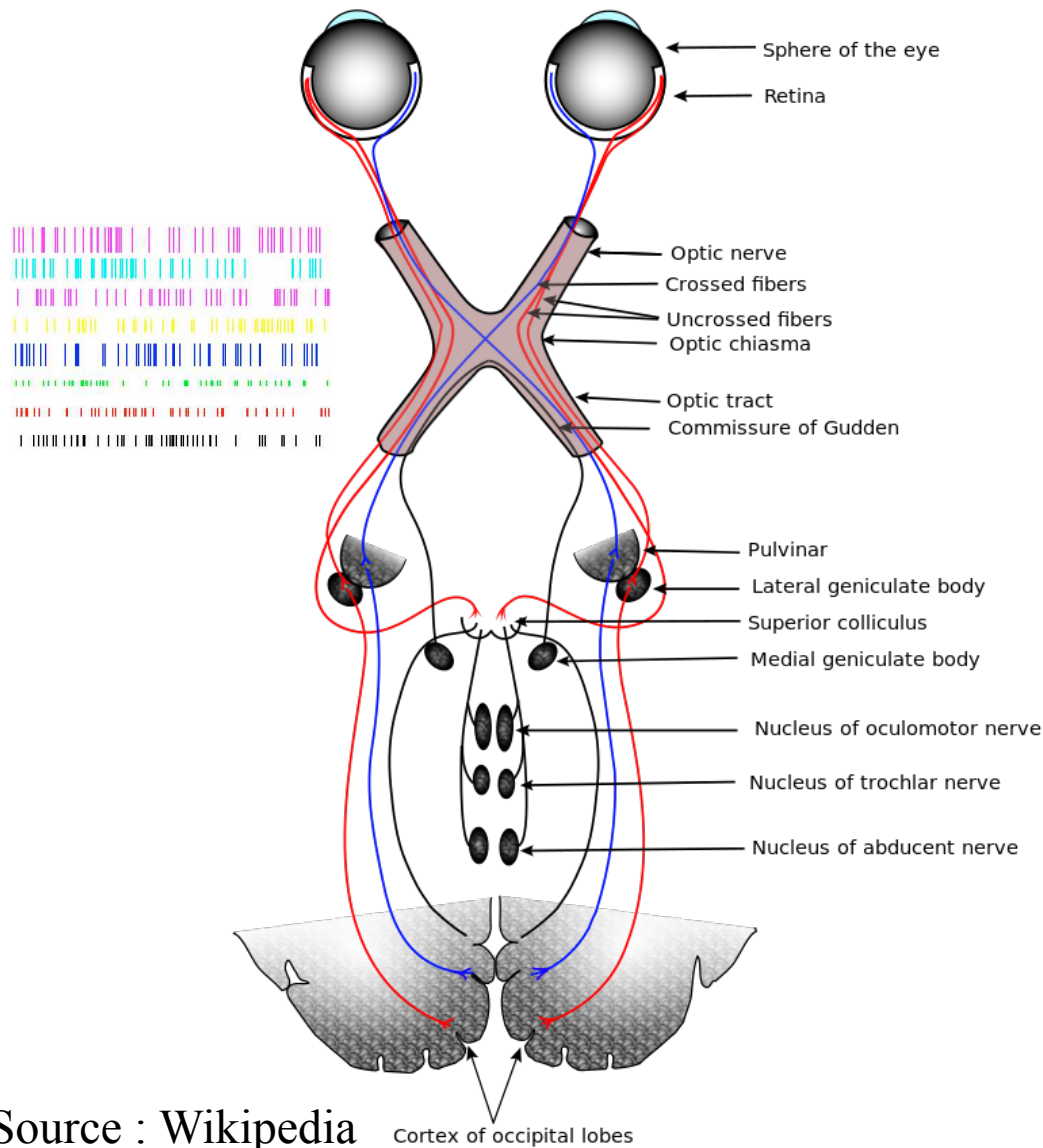

The visual flow

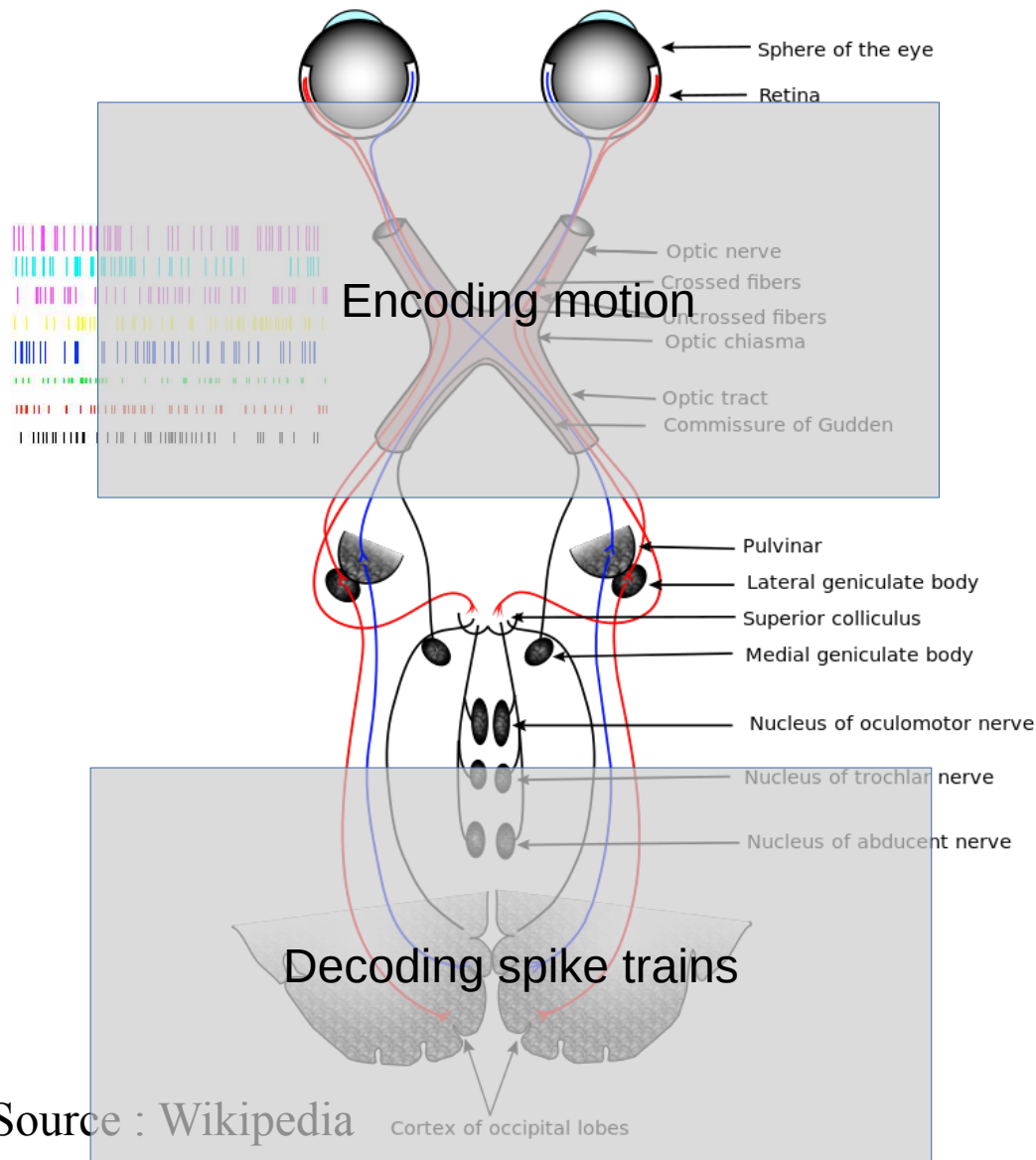

The visual flow

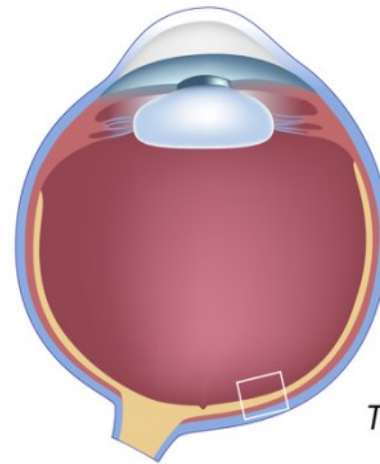
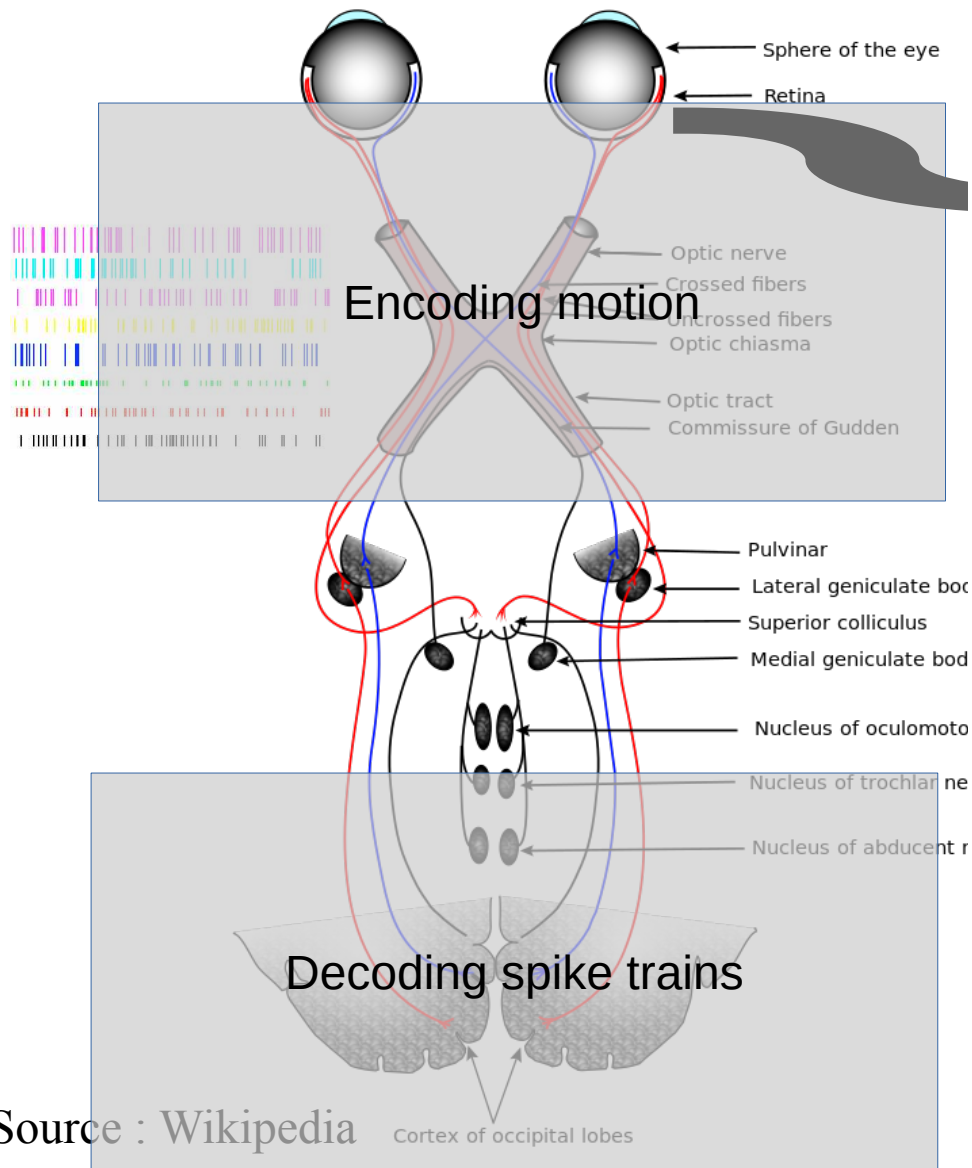

Structure of the Retina

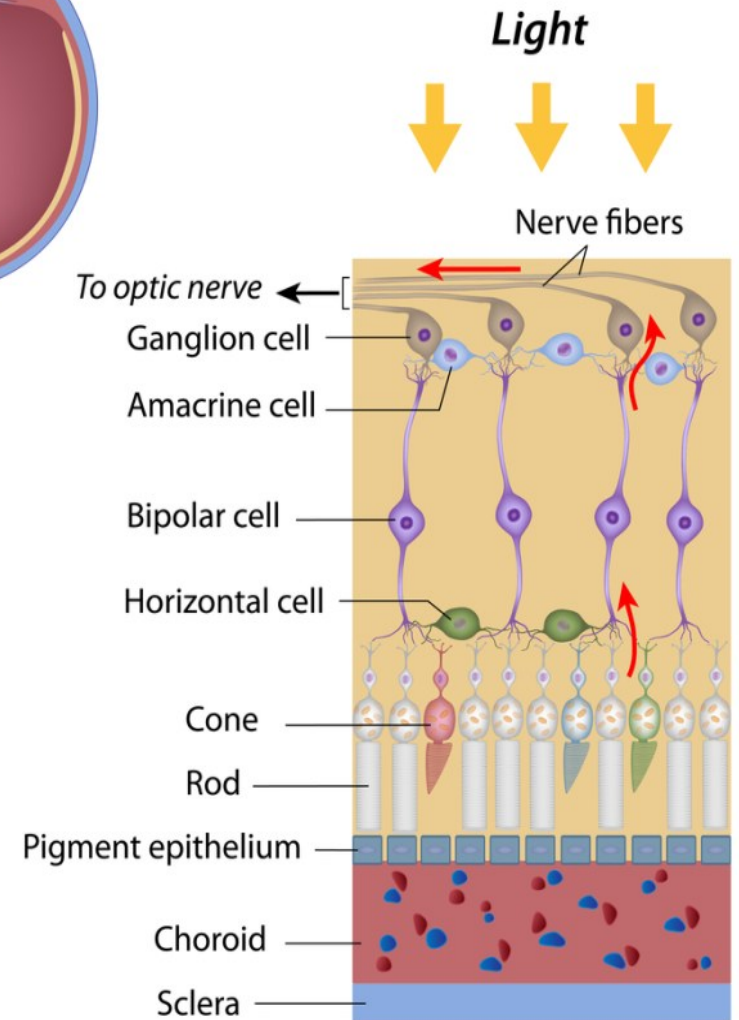

The visual flow

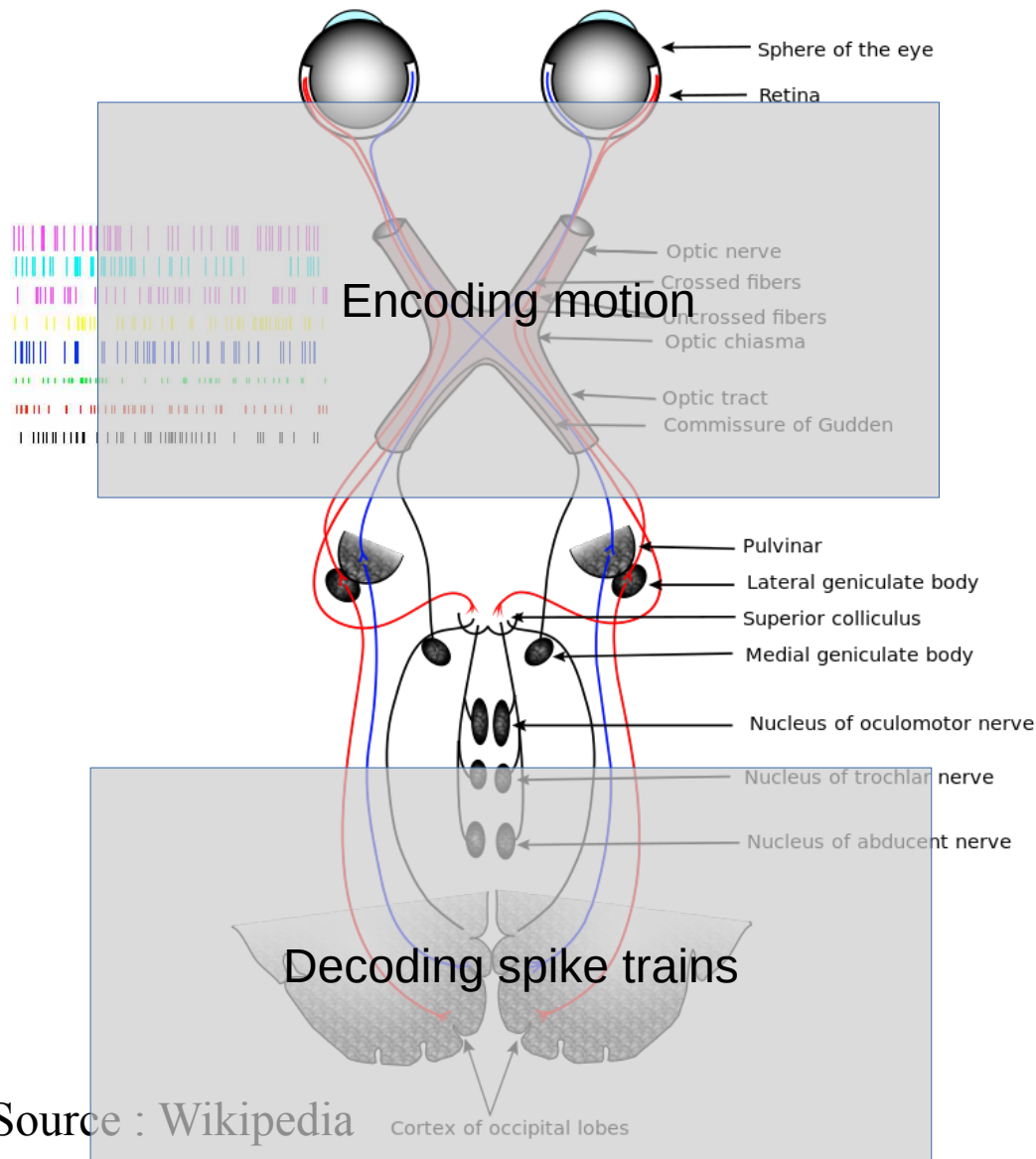

- High transduction rate : 1 photon can trigger a membrane voltage variation of ~1 mV

The visual flow

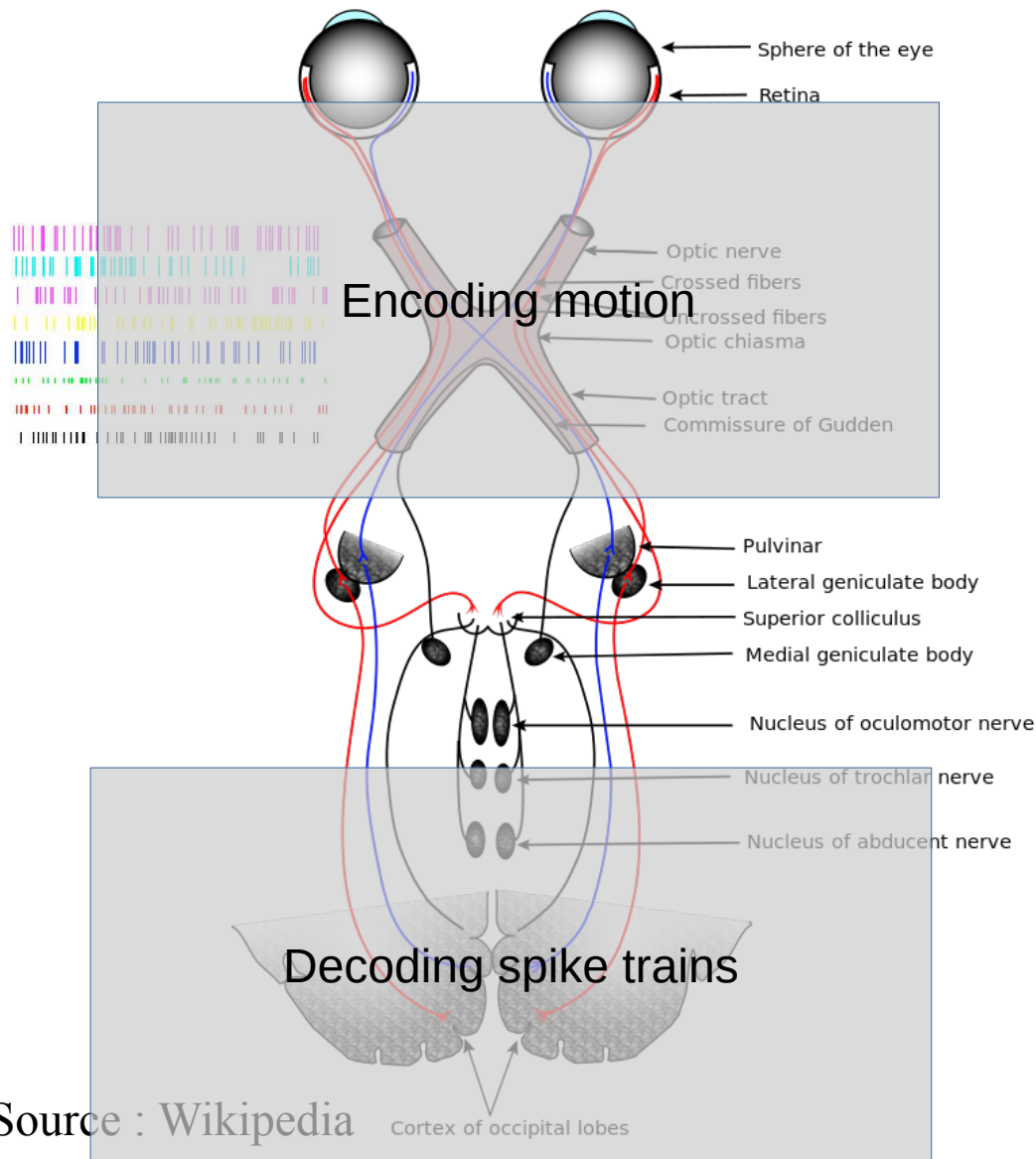

- High transduction rate : 1 photon can trigger a membrane voltage variation of ~1 mV
- Able to detect approaching motion

The visual flow

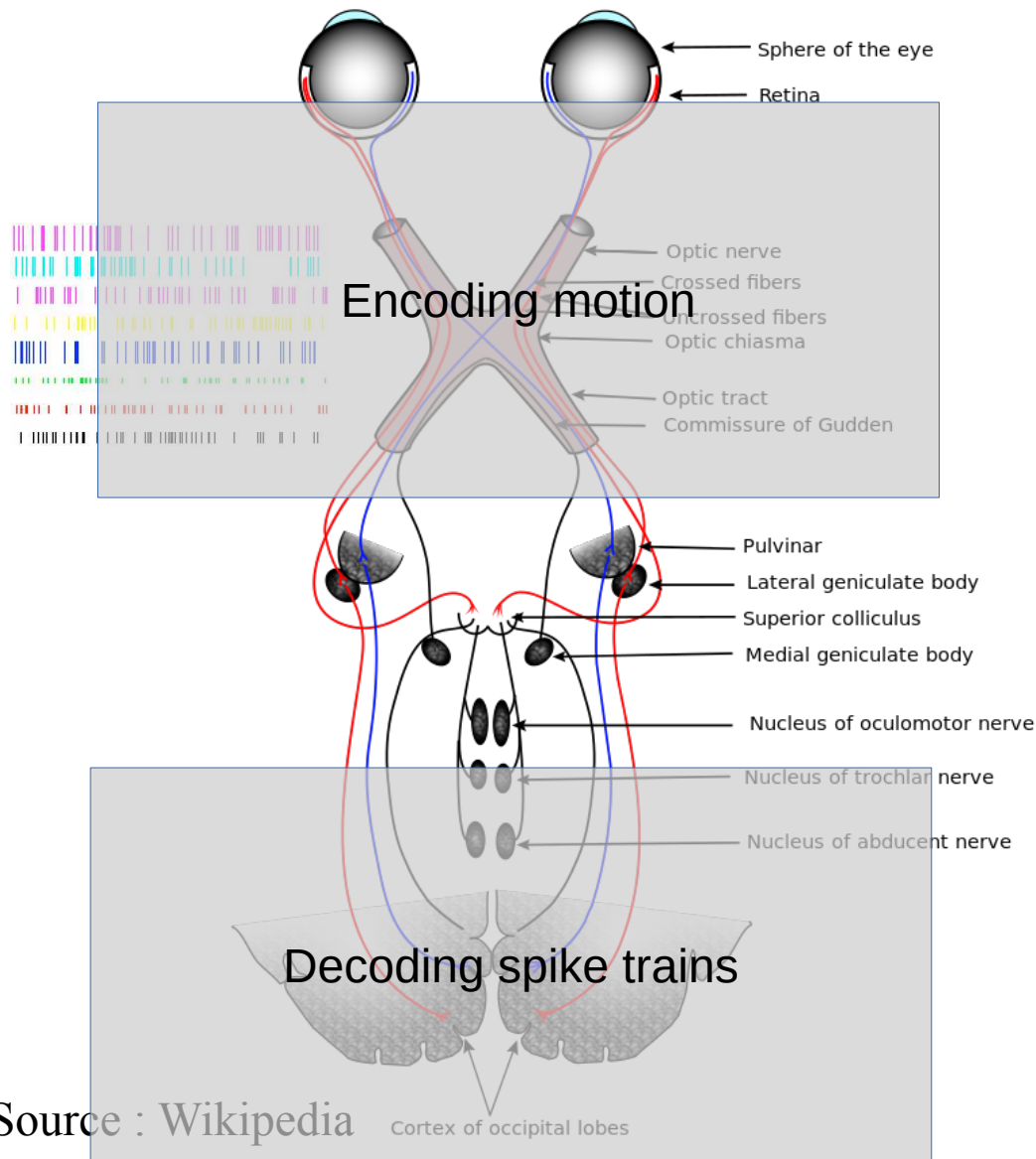

- High transduction rate : 1 photon can trigger a membrane voltage variation of ~1 mV
- Able to detect approaching motion
- Able to detect differential motion

The visual flow

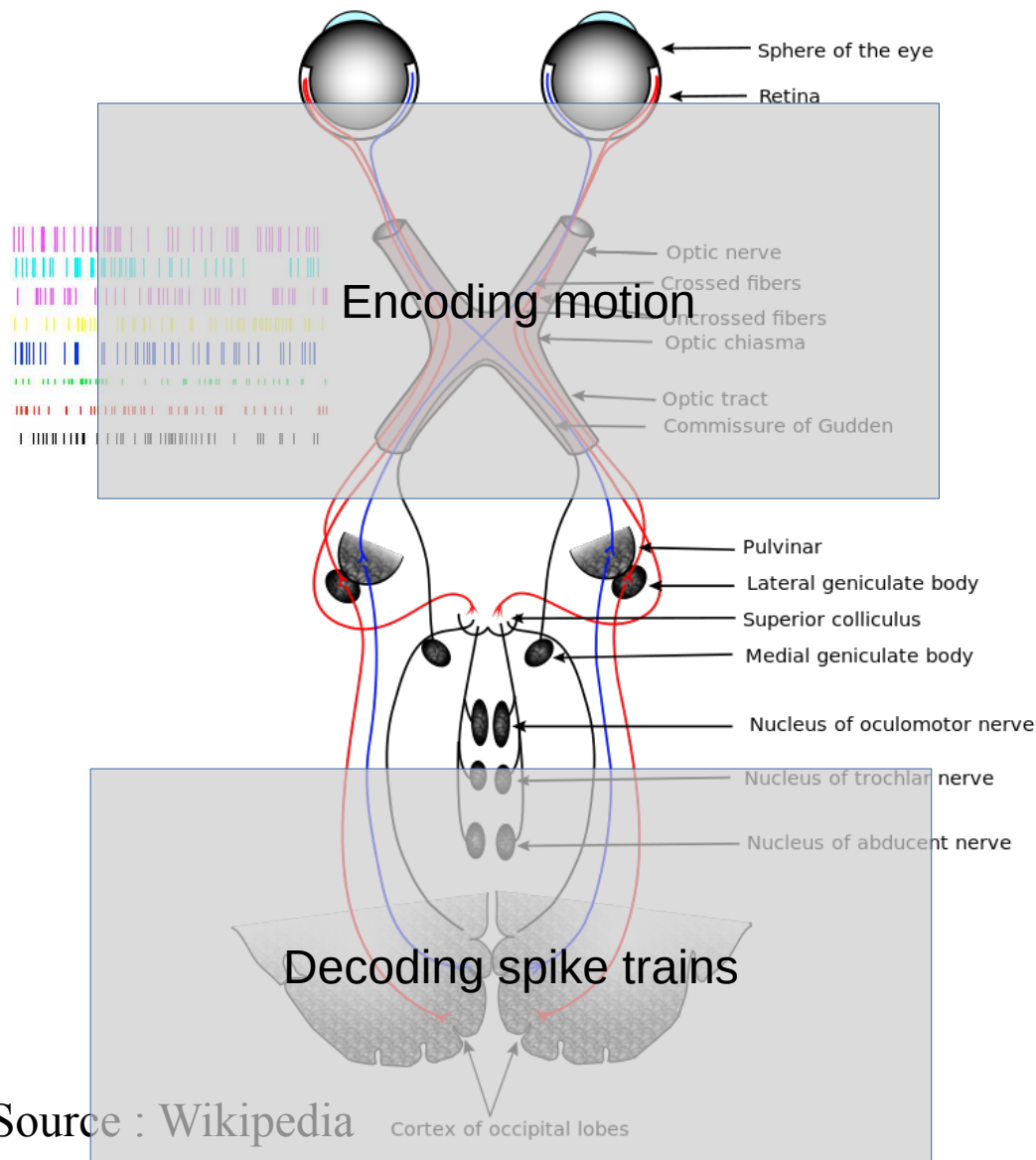

- High transduction rate : 1 photon can trigger a membrane voltage variation of ~1 mV
- Able to detect approaching motion
- Able to detect differential motion
- Sensitive to « surprise » in a visual scene

The visual flow

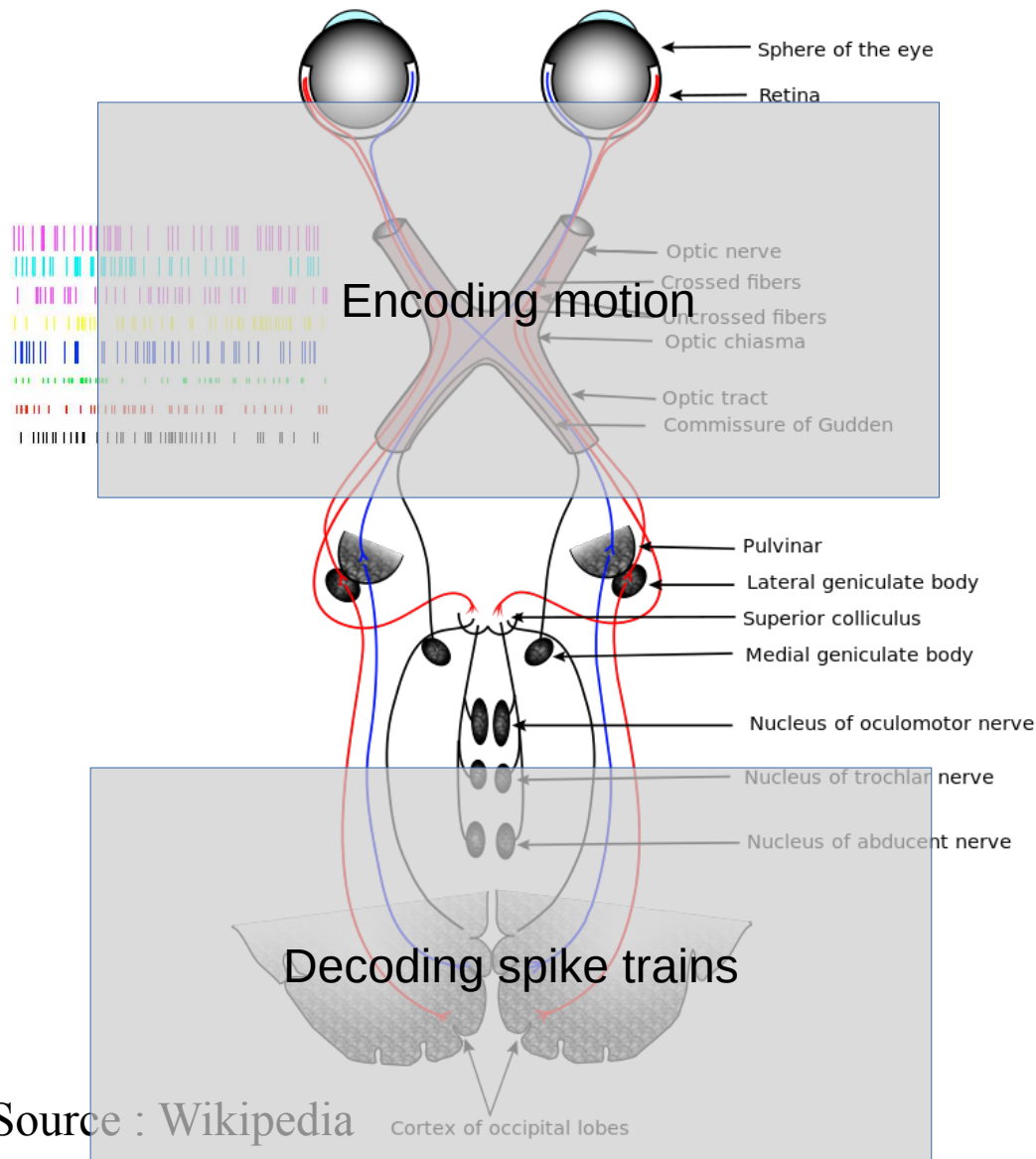

- High transduction rate : 1 photon can trigger a membrane voltage variation of ~ 1 mV
- Able to detect approaching motion
- Able to detect differential motion
- Sensitive to « surprise » in a visual scene
- Able to perform motion anticipation

The visual flow

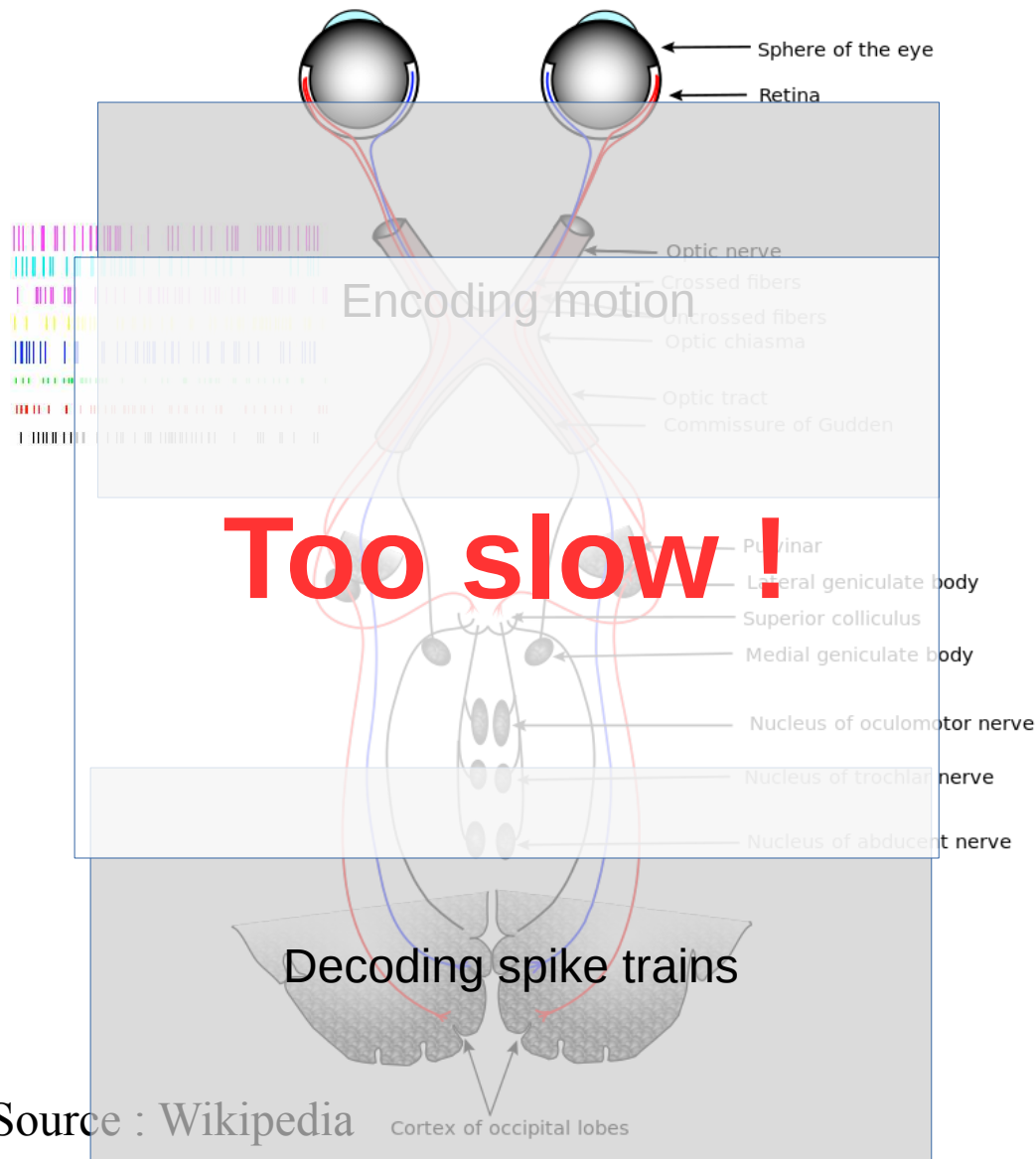

- High transduction rate : 1 photon can trigger a membrane voltage variation of ~1 mV
- Able to detect approaching motion
- Able to detect differential motion
- Sensitive to « surprise » in a visual scene
- Able to perform motion anticipation

Visual Anticipation

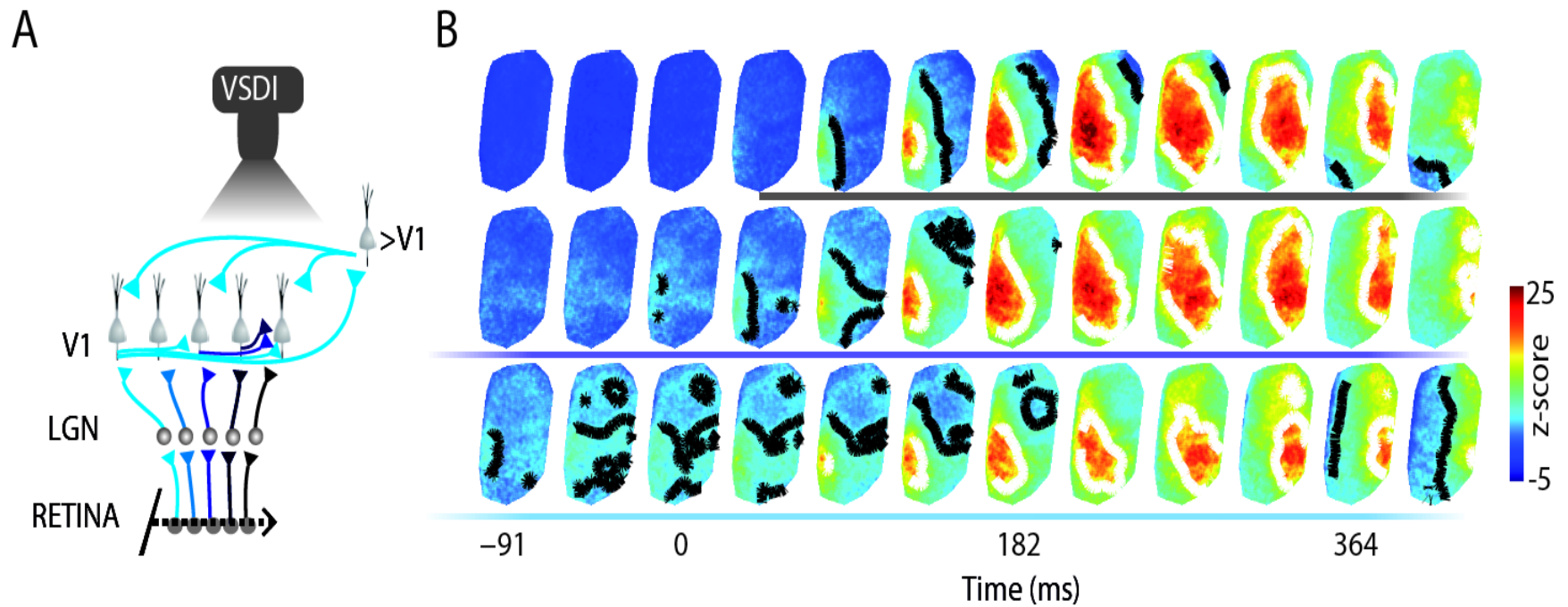

Source : Benvenuti et al. 2015

Visual Anticipation

Anticipation is carried out by the primary visual cortex (V1) through an activation wave

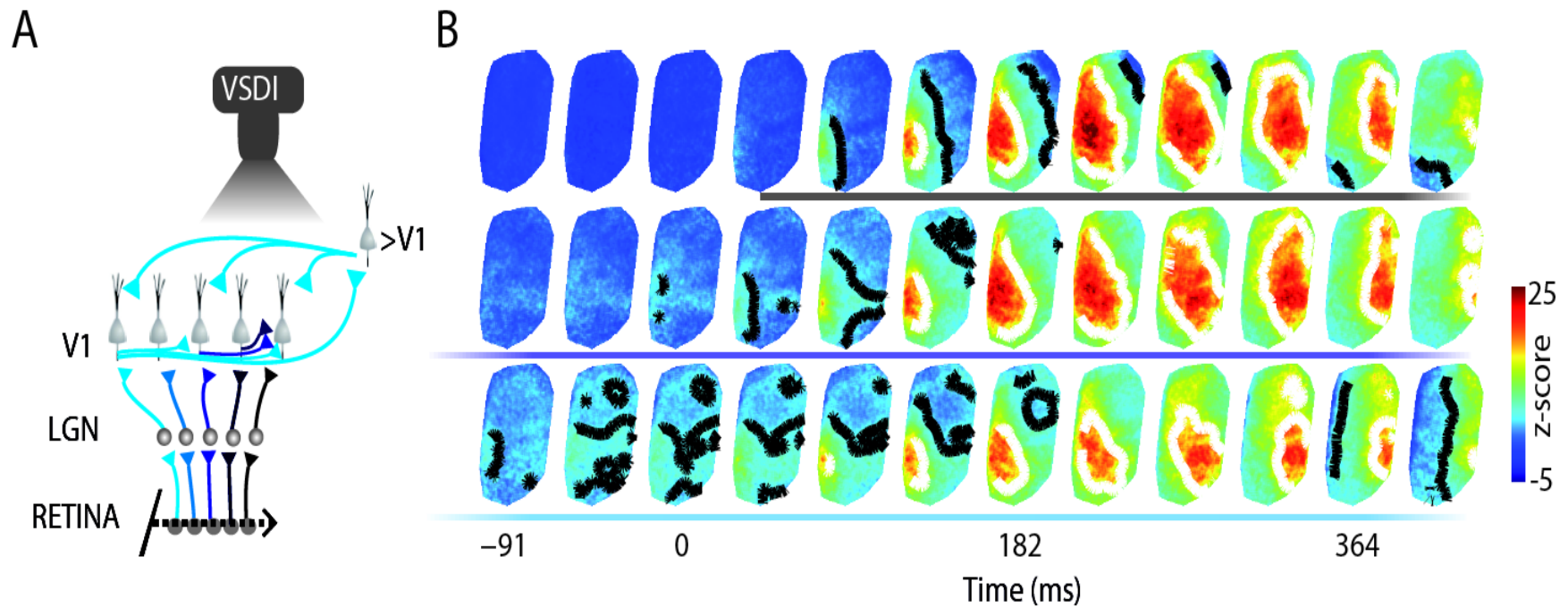

Source : Benvenuti et al. 2015

Visual Anticipation

Anticipation also takes place in the retina

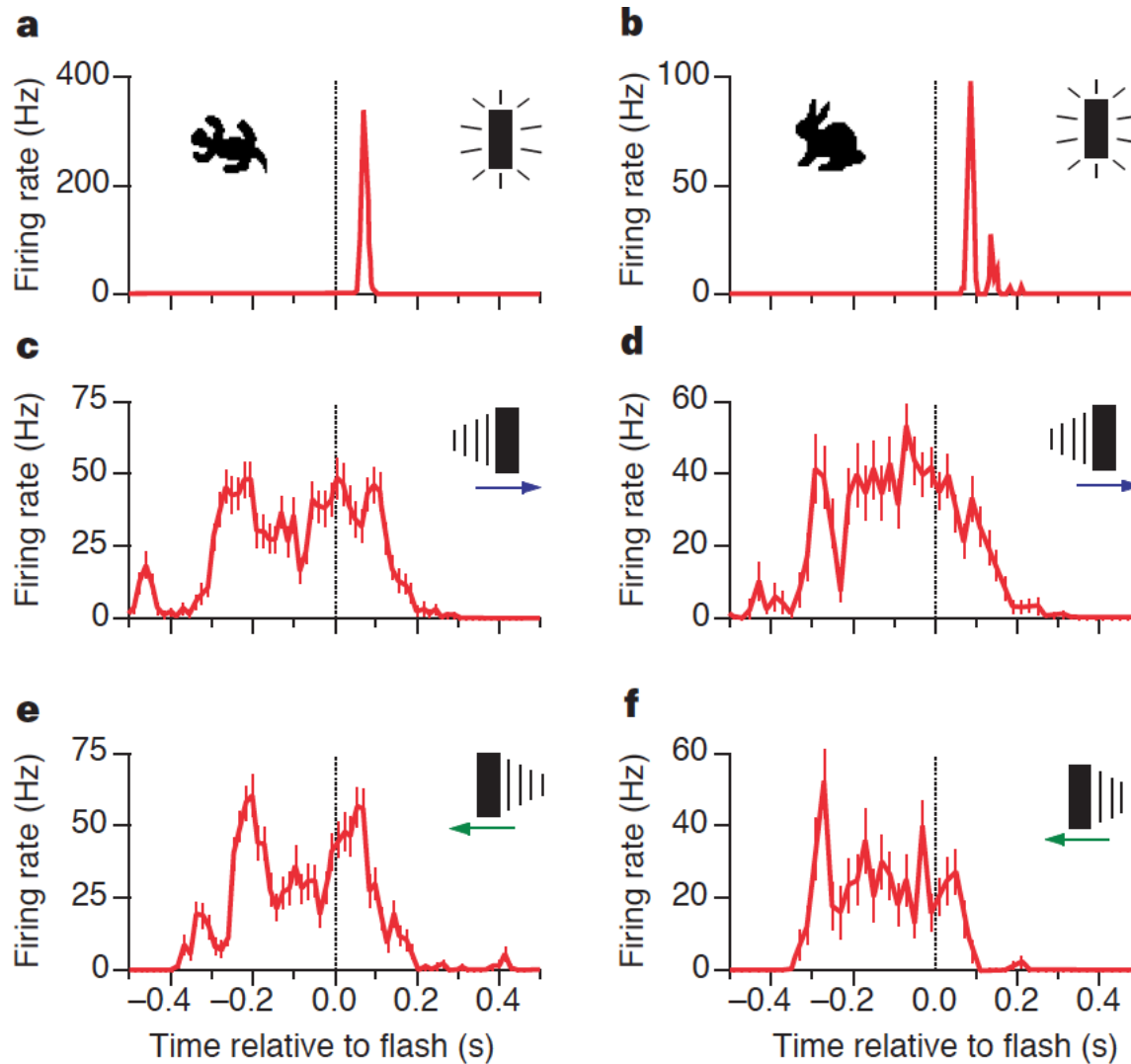

Source :
Berry et al.
1999

Visual Anticipation



Trajectory

What are the respective mechanisms underlying retinal and cortical anticipation?

The visual flow

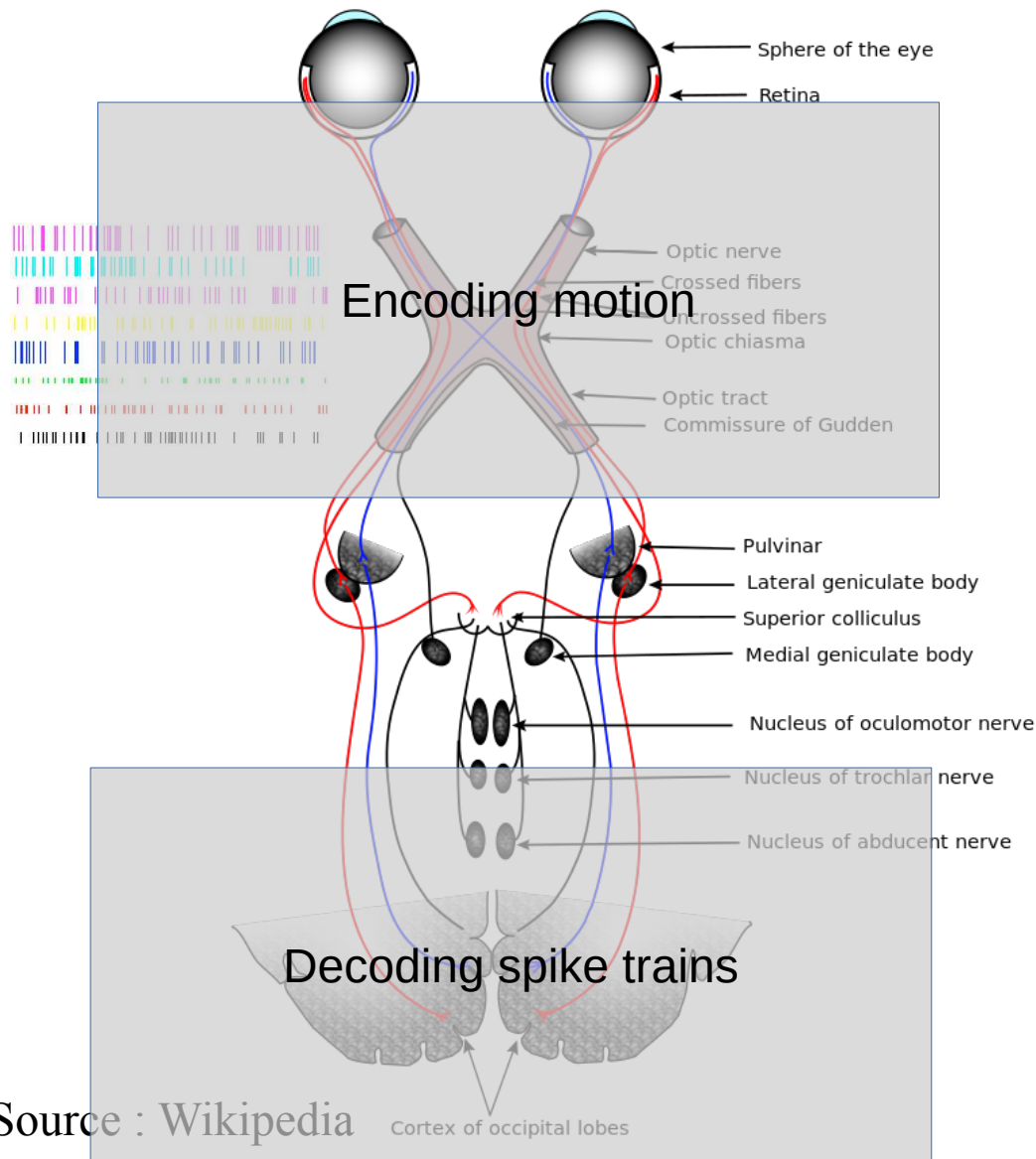

The retina is NOT a camera

- High transduction rate : 1 photon can trigger a membrane voltage variation of ~ 1 mV
- Able to detect approaching motion
- Able to detect differential motion
- Sensitive to « surprise » in a visual scene
- Able to perform motion anticipation

The visual flow

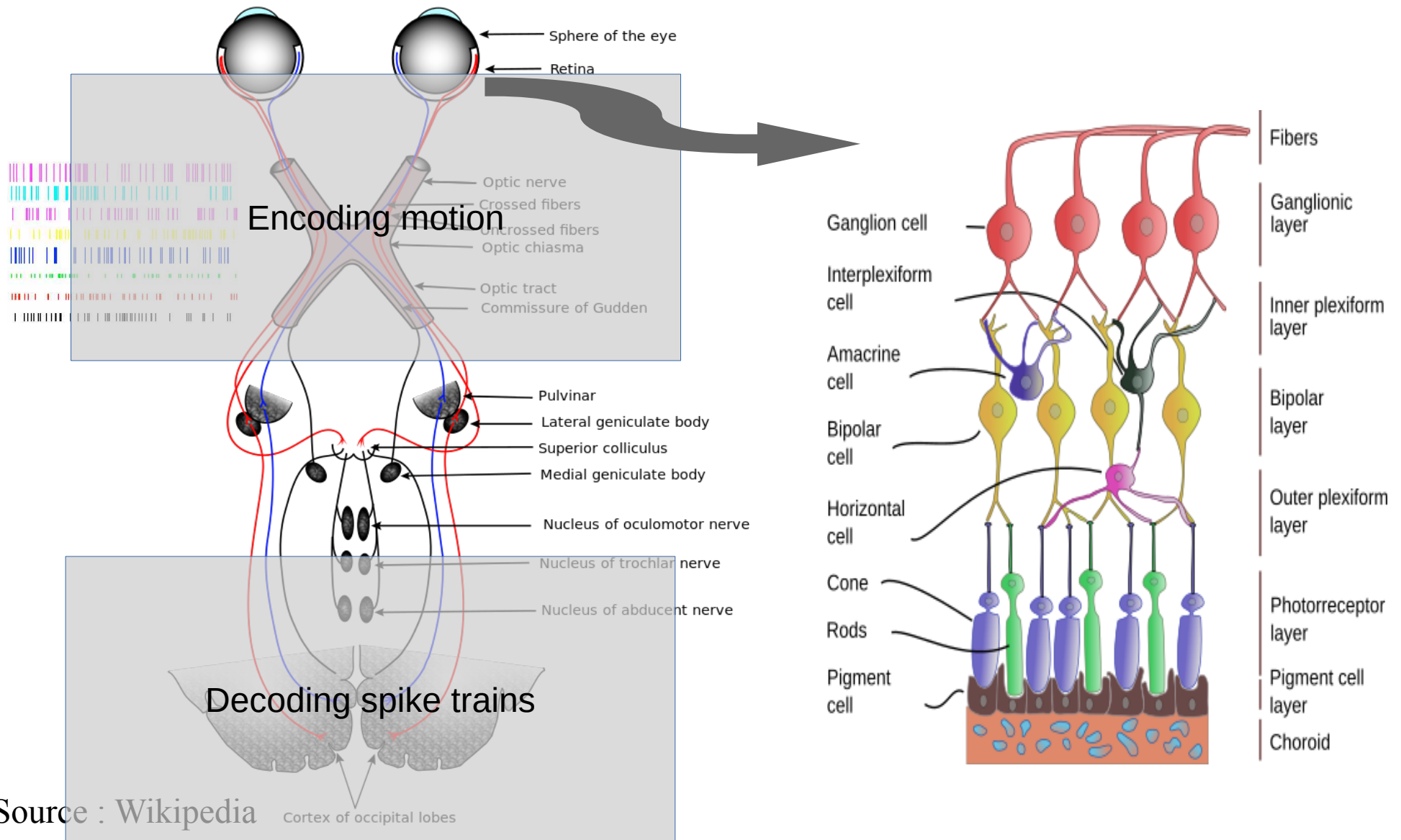

The visual flow

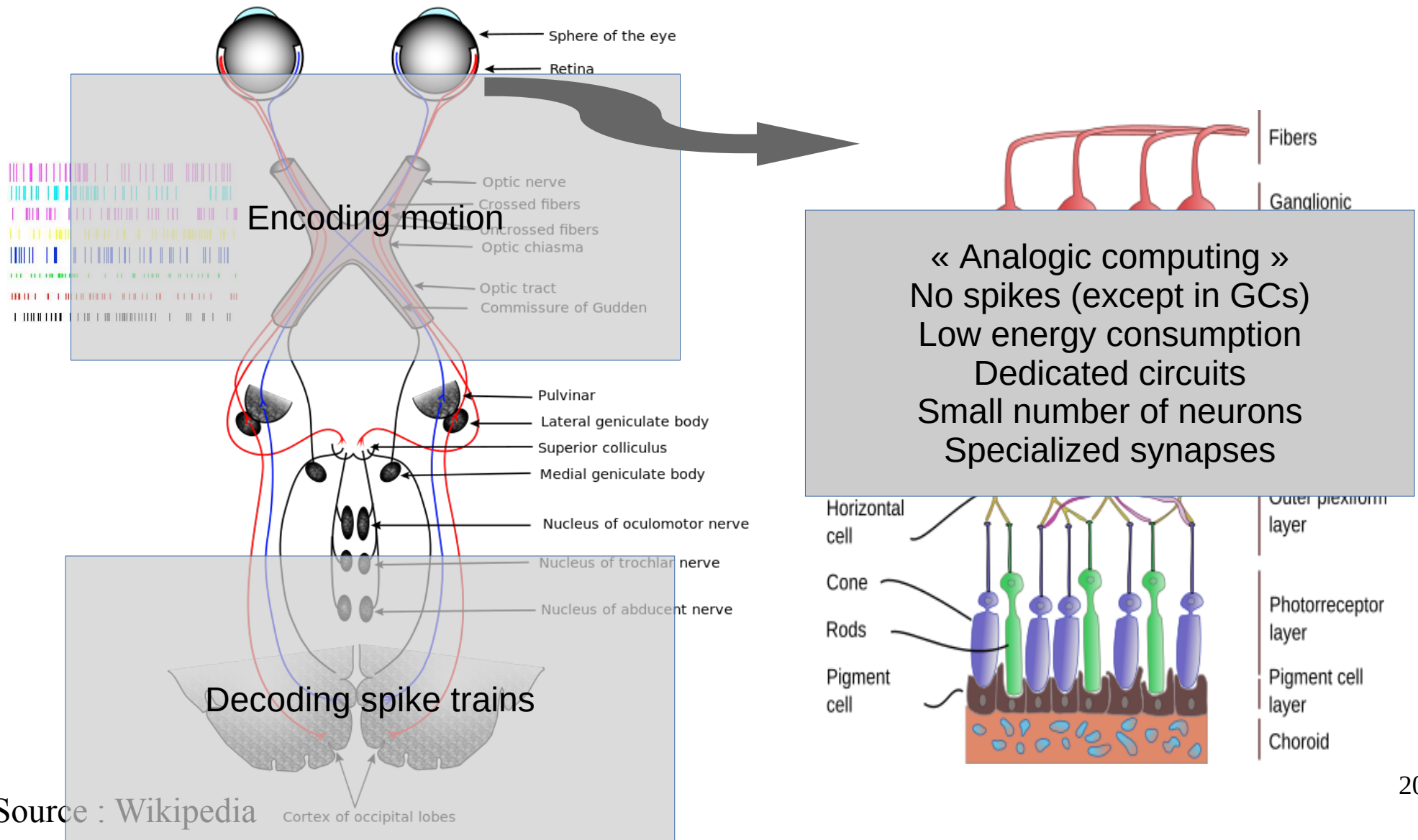

The visual flow

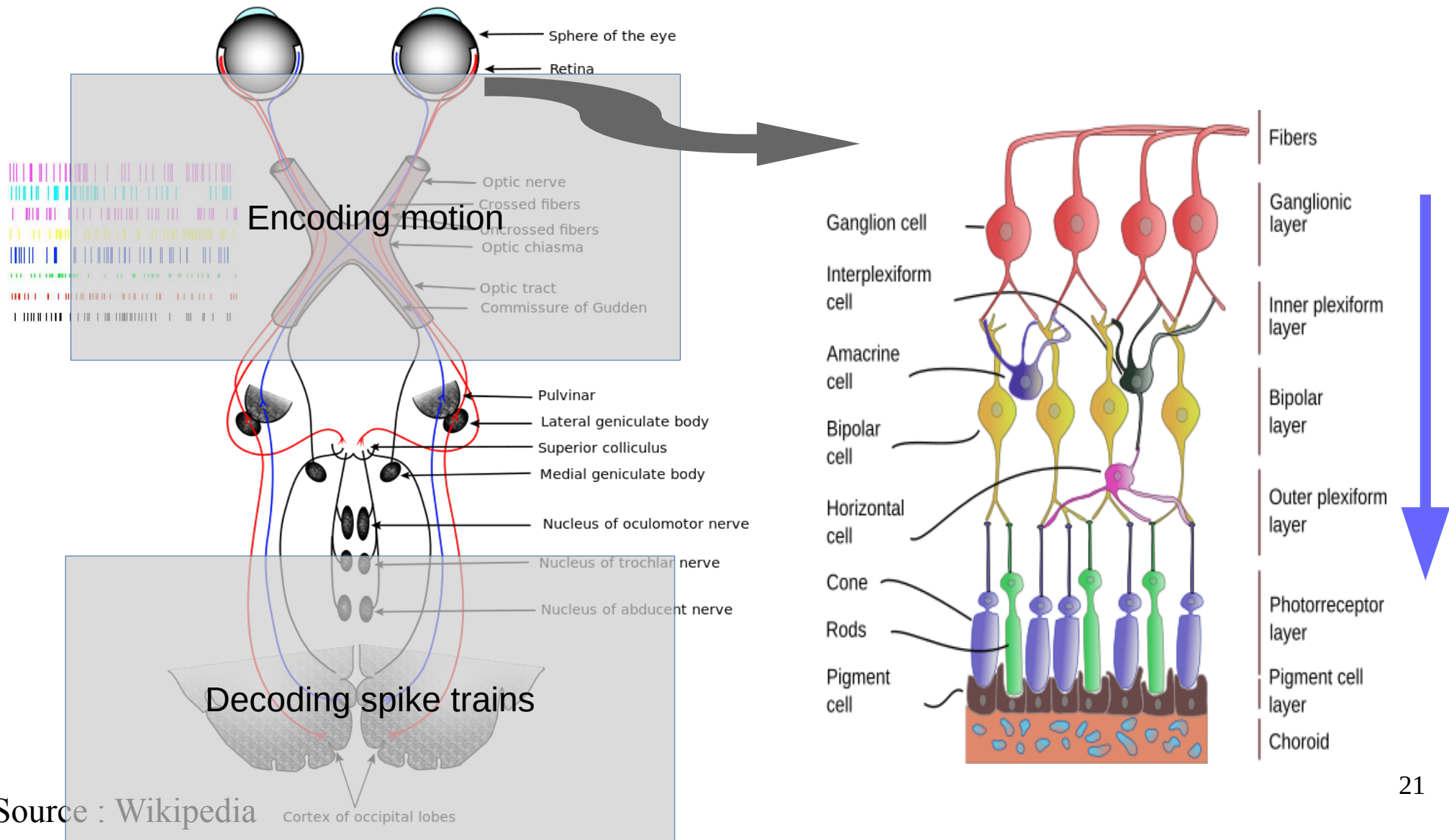

The visual flow

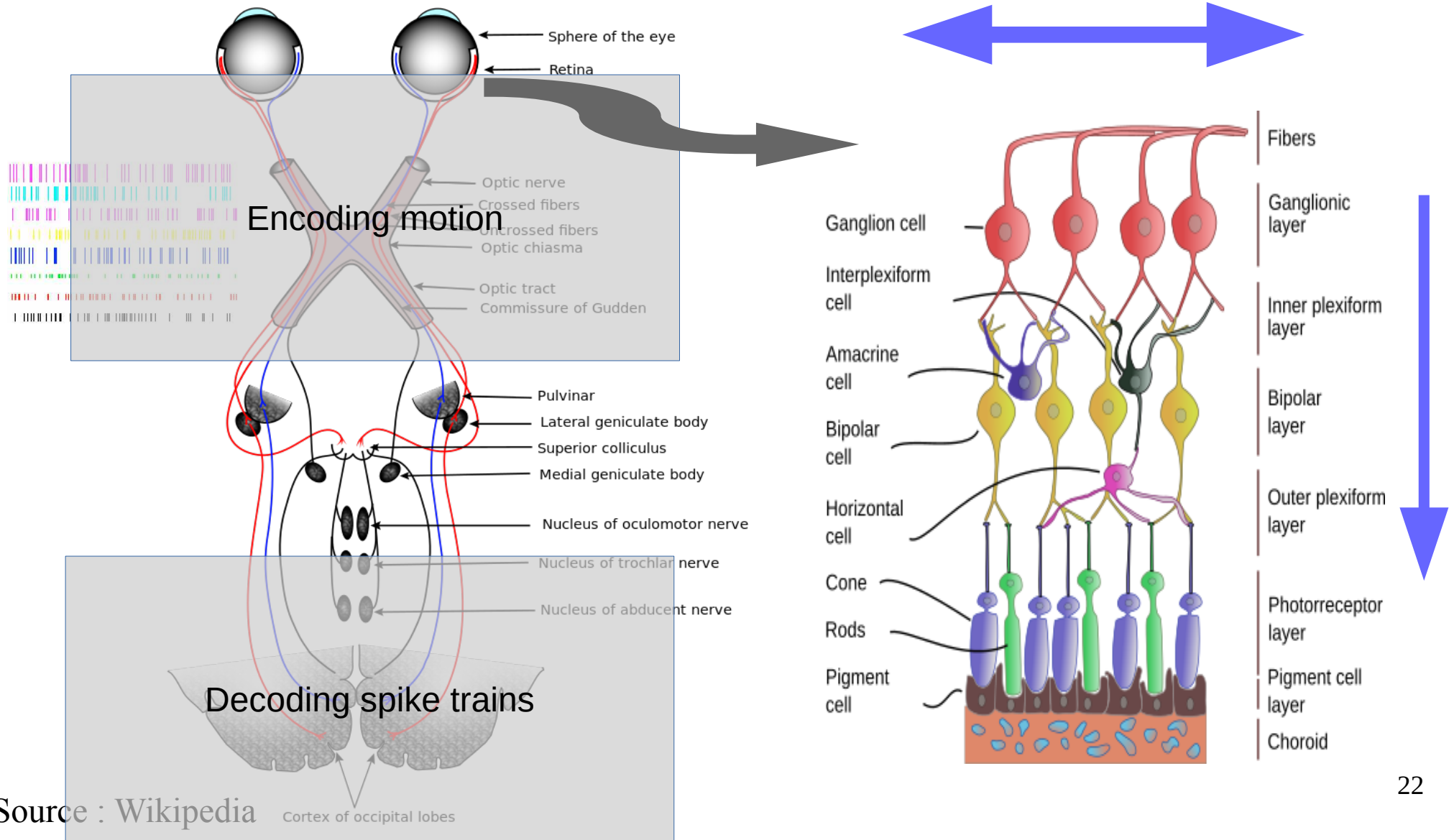

The visual flow

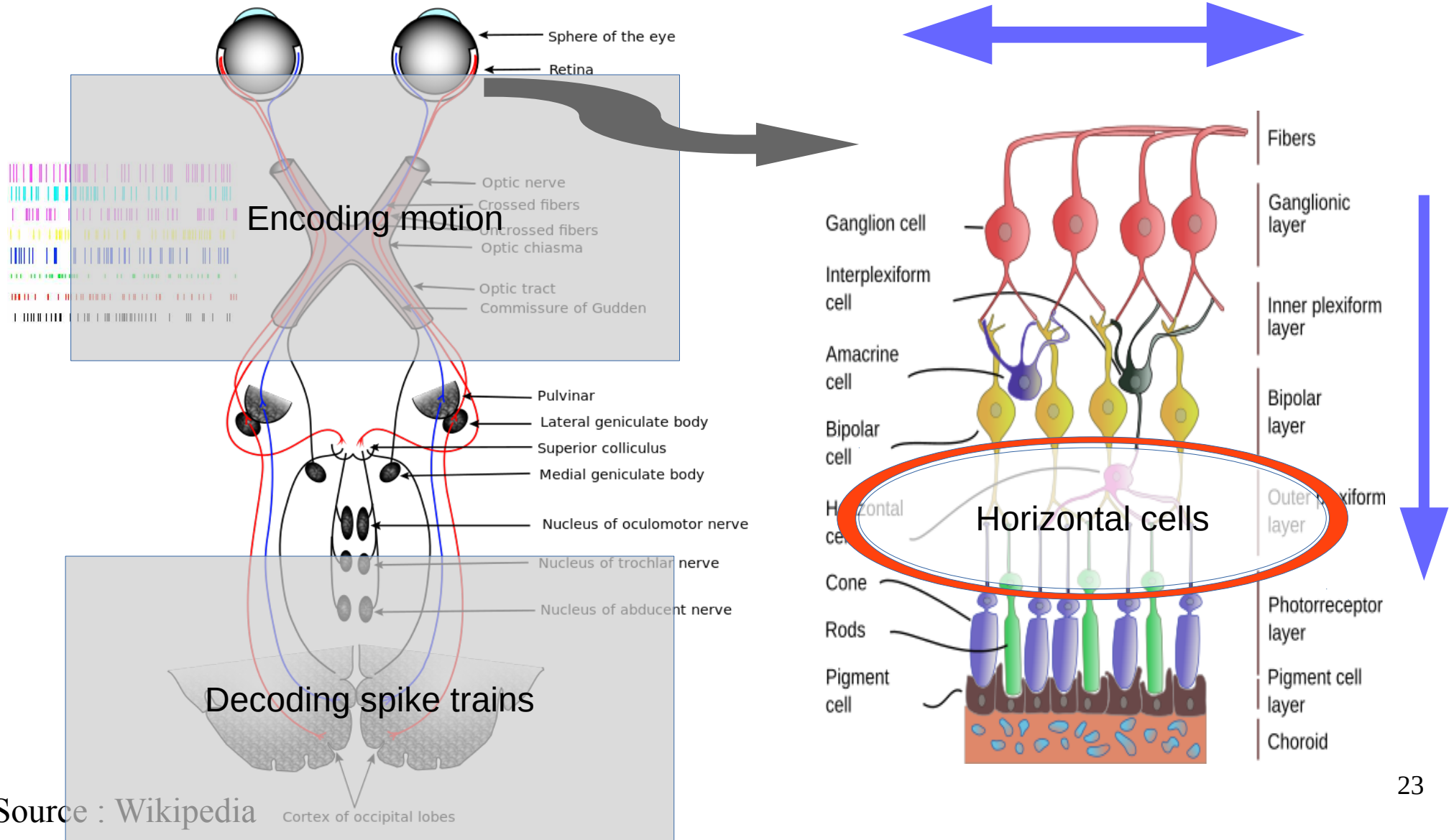

The visual flow

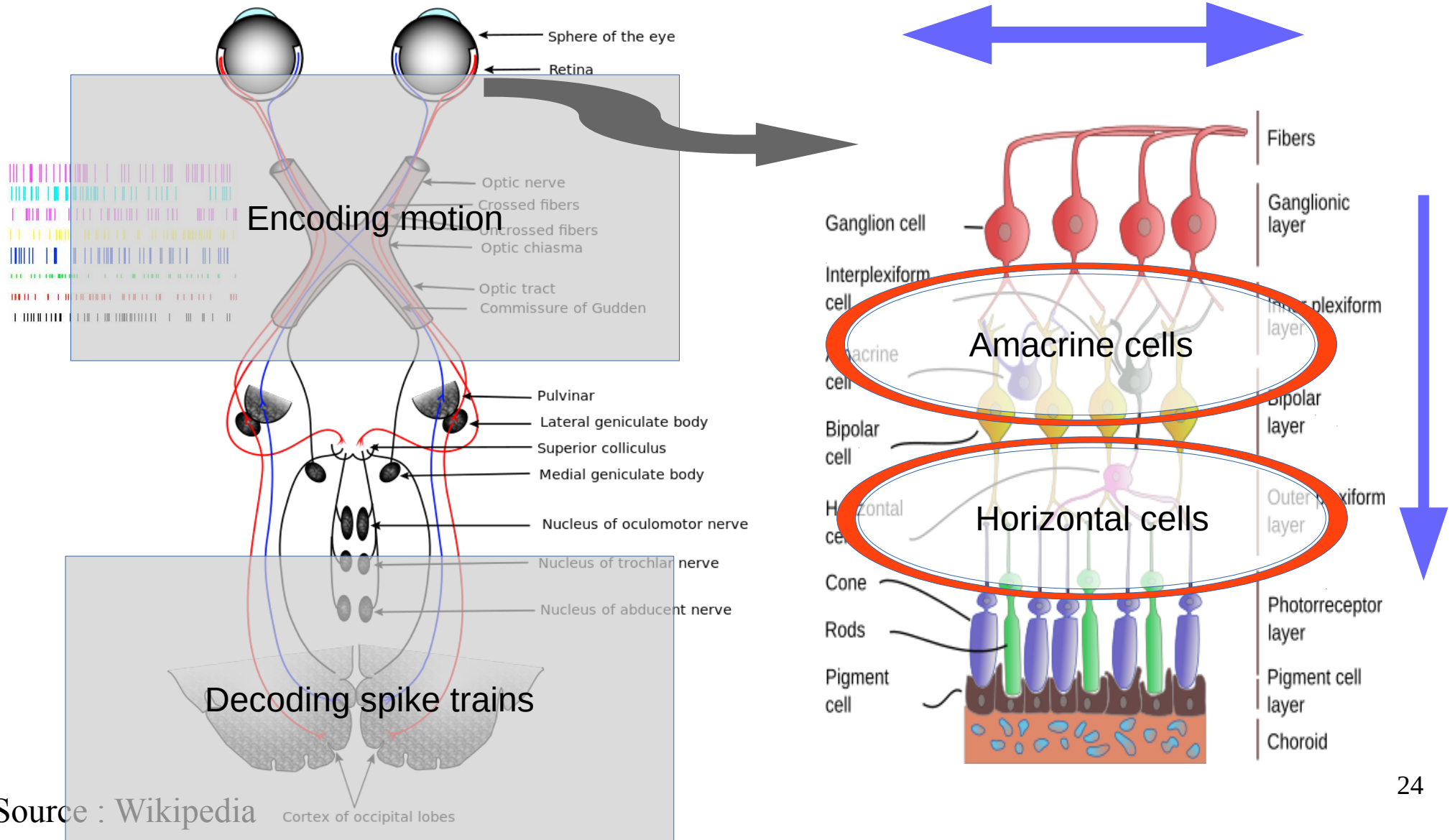

The visual flow

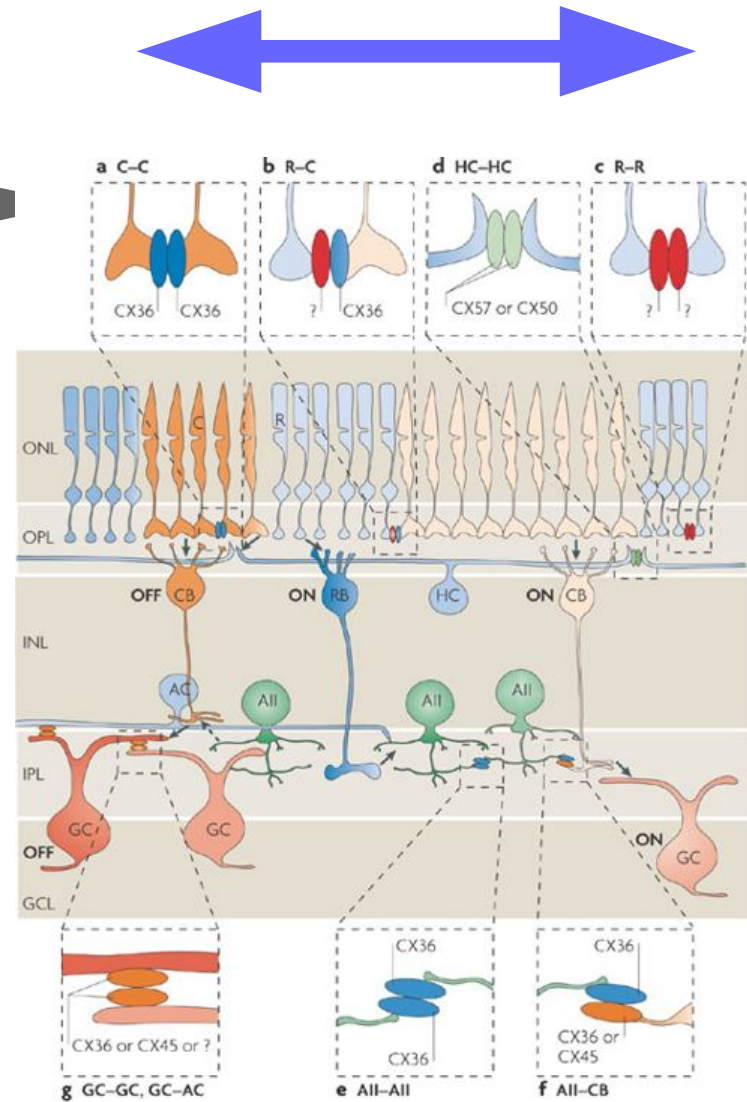
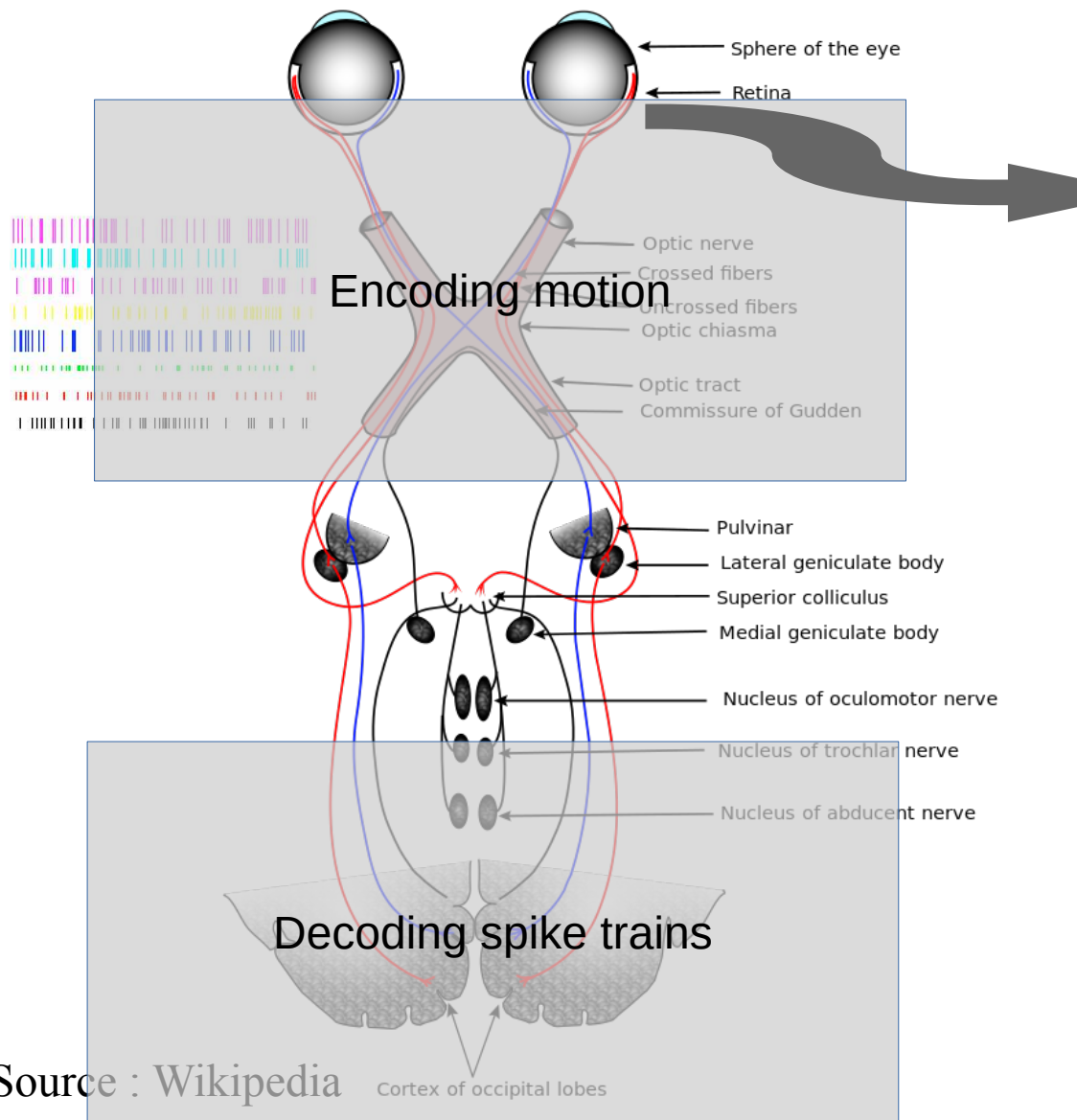

The visual flow

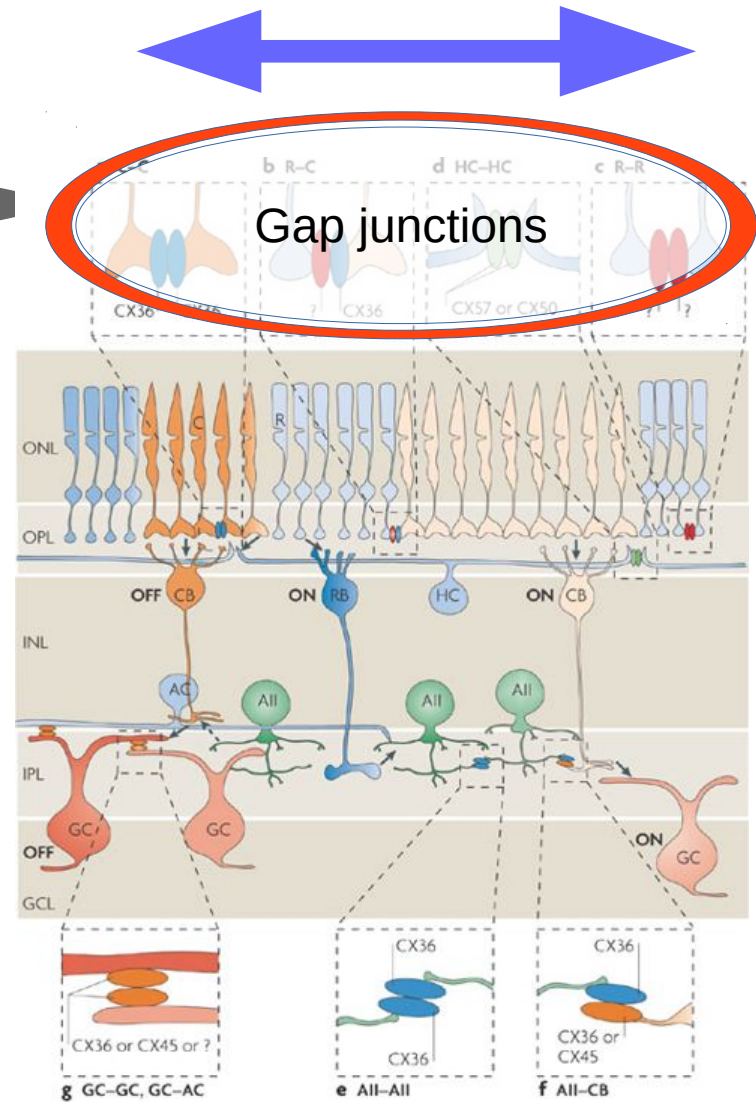
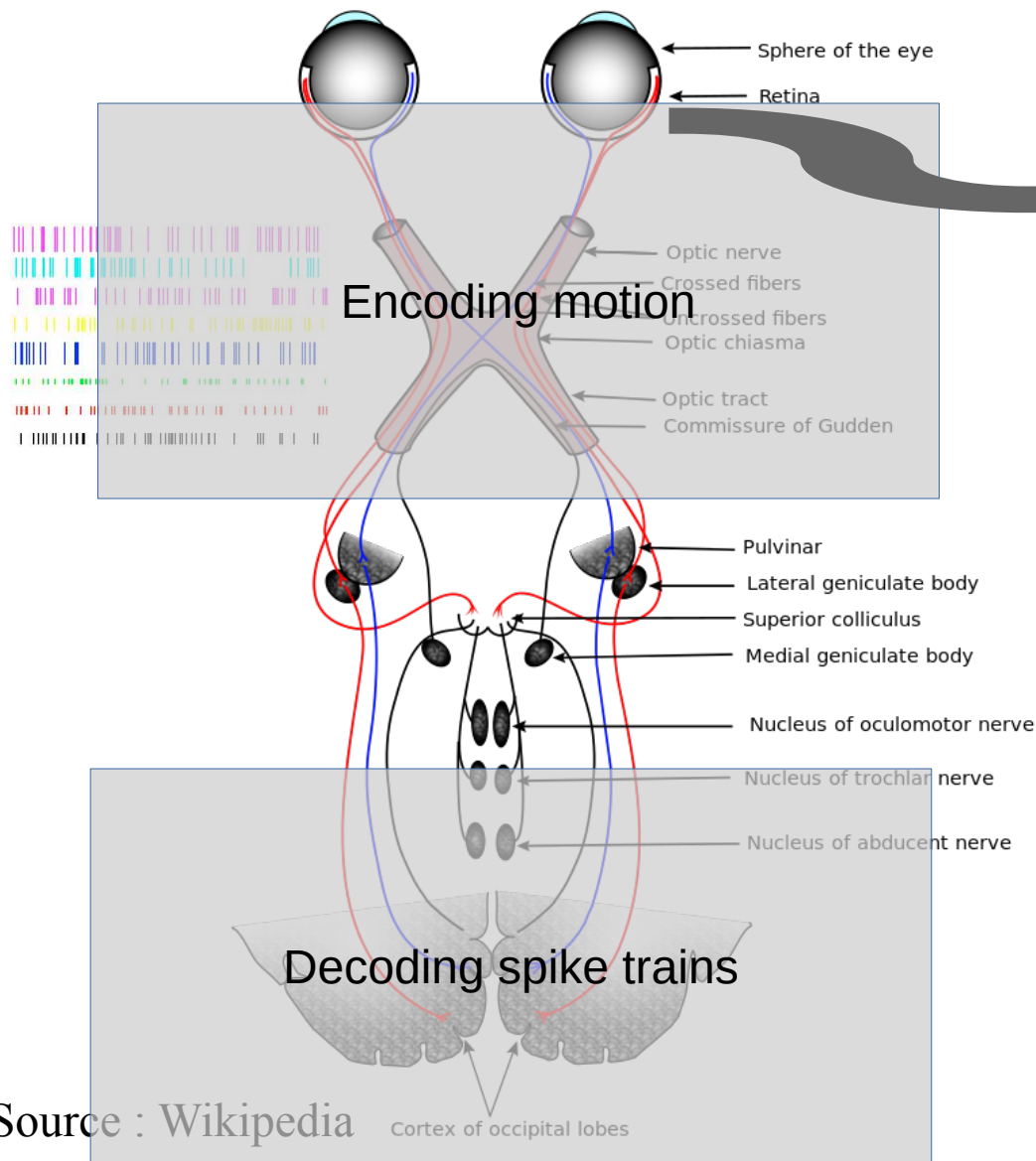

The visual flow

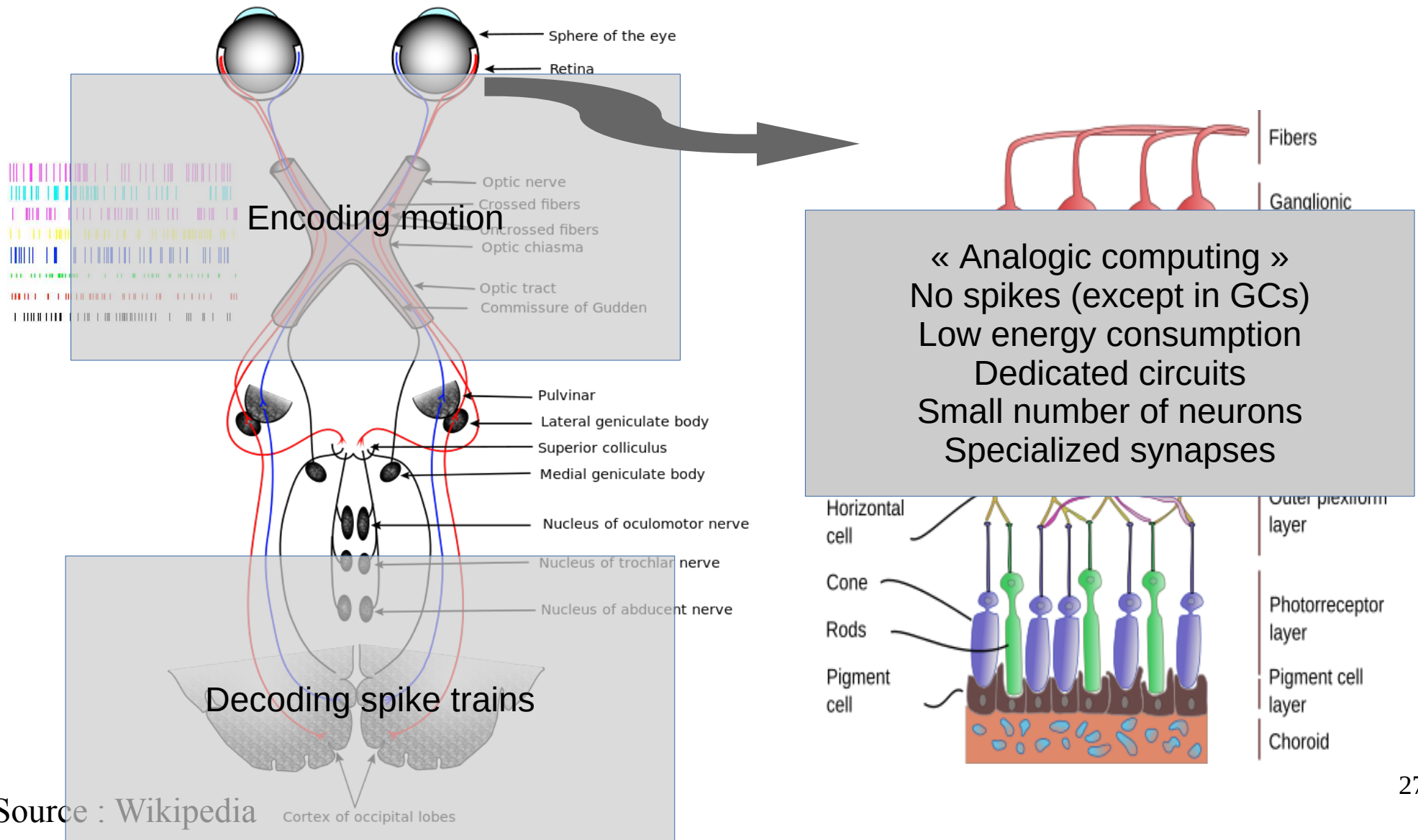

Which generic computational paradigms are at work in the retina ?

Visual Anticipation

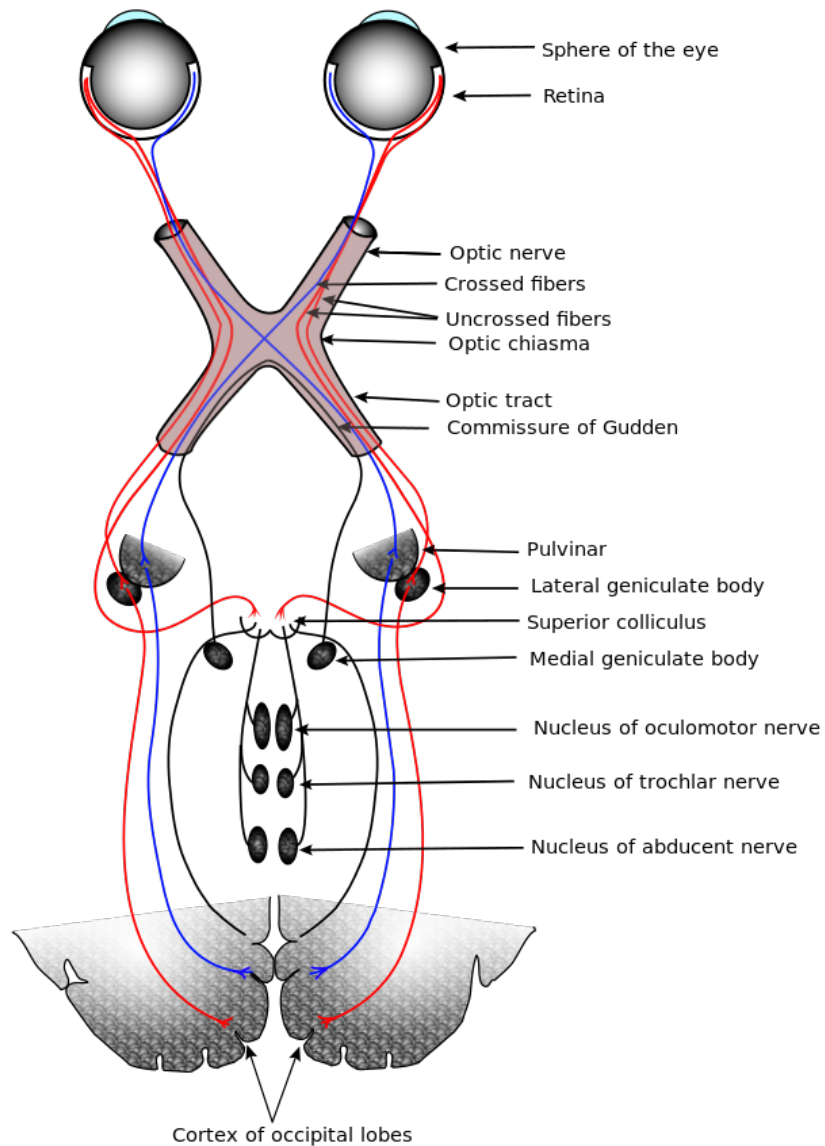

Visual Anticipation

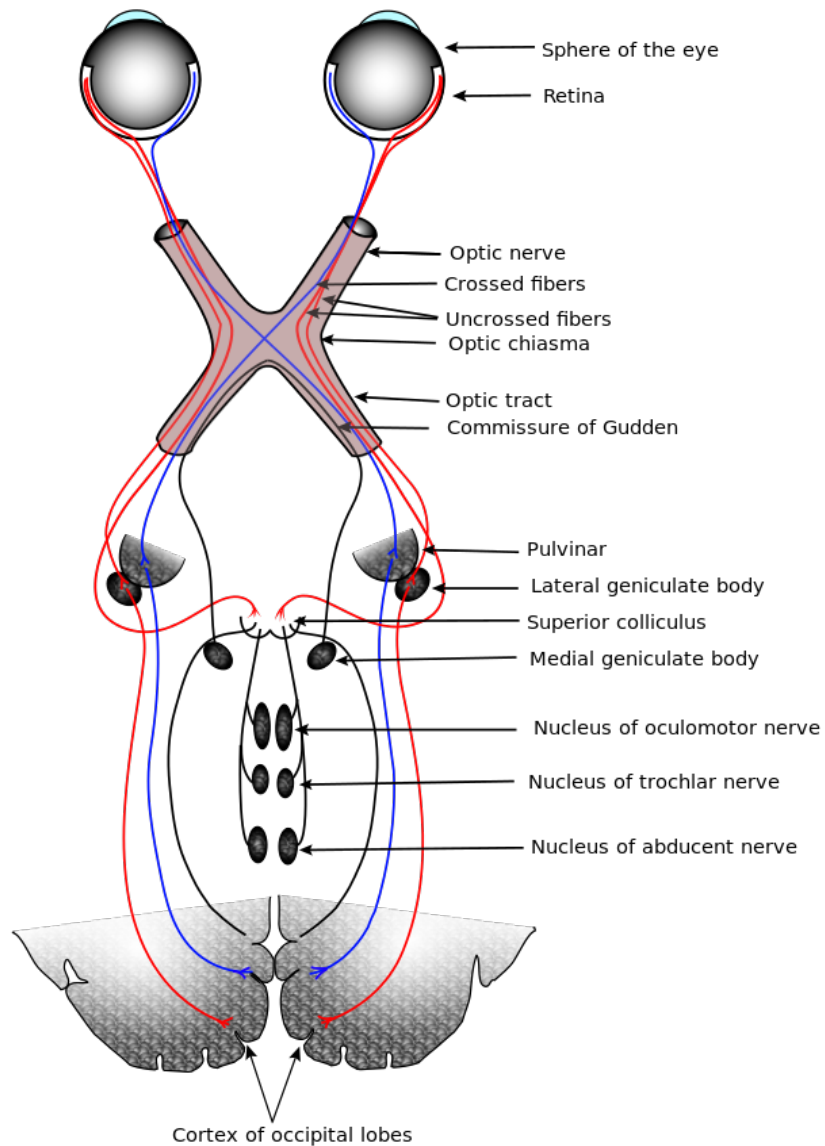

Which animal ?

Visual Anticipation

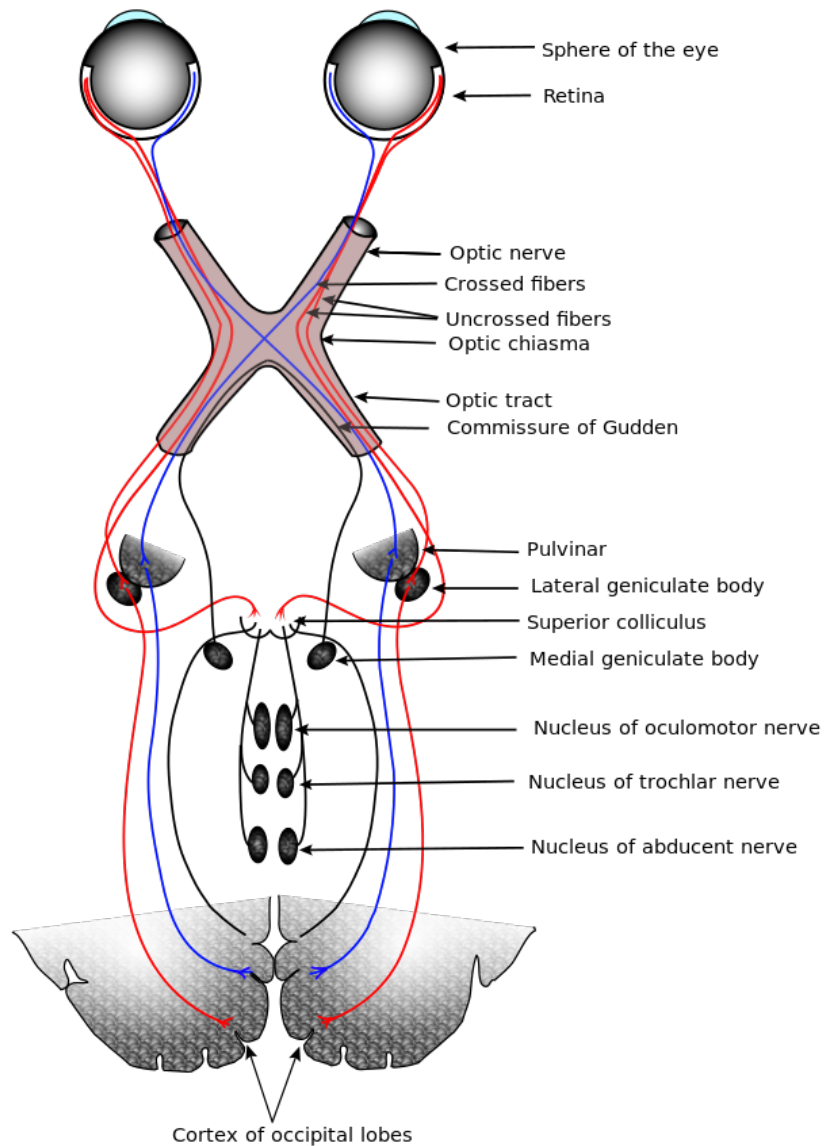

Which animal ?

Visual Anticipation

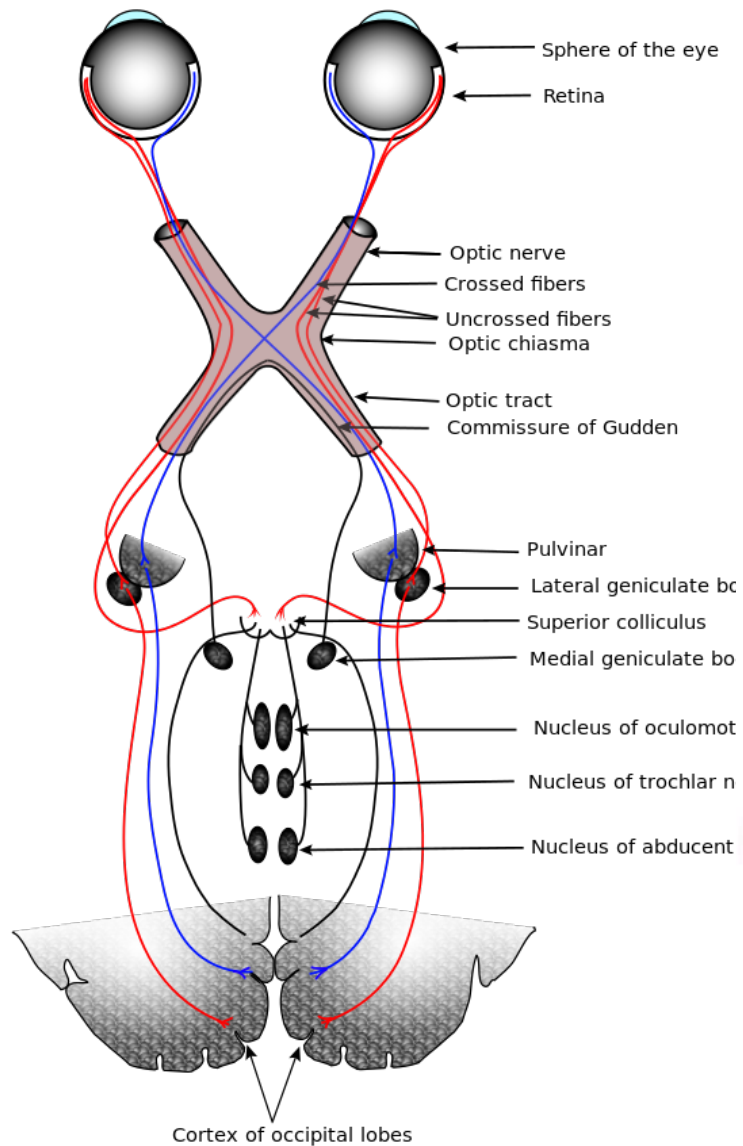

Which animal ?

Visual Anticipation

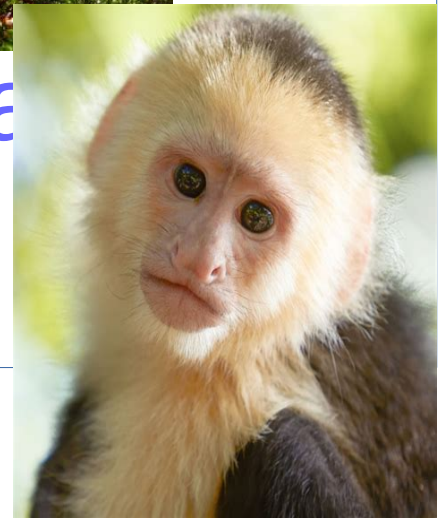
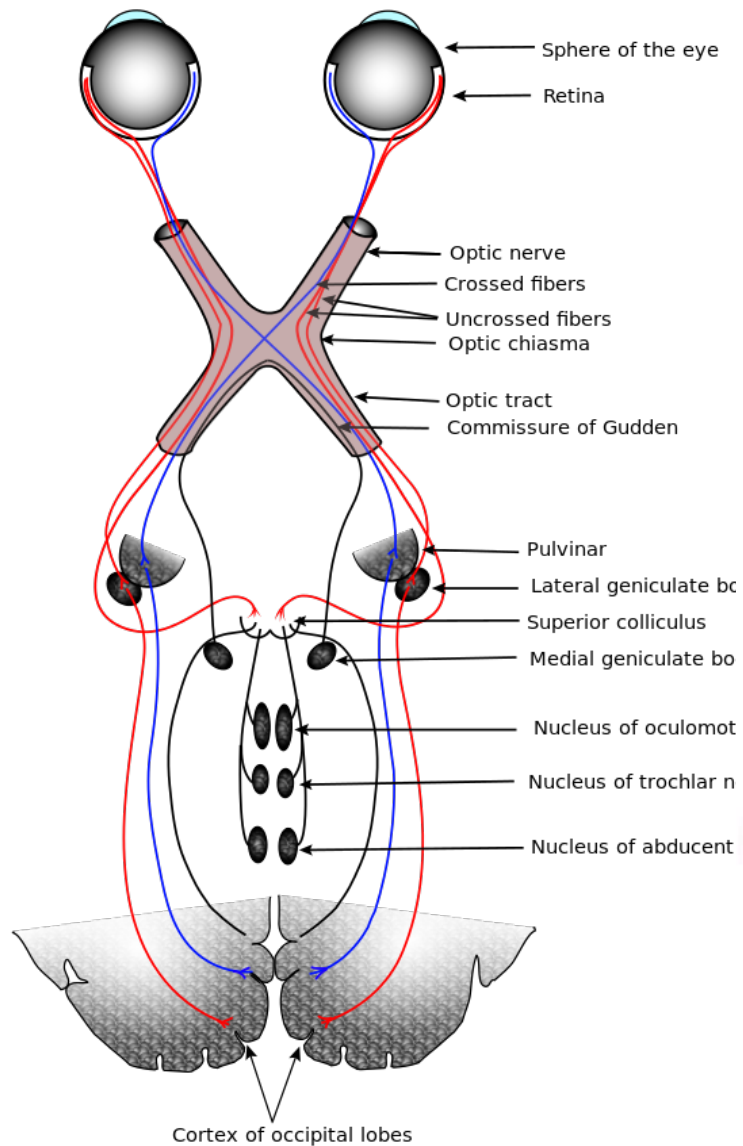

Visual Anticipation

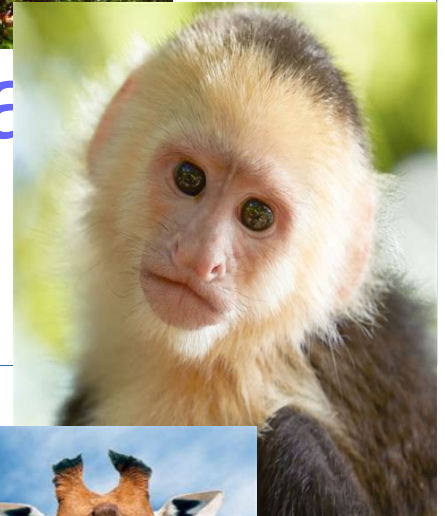
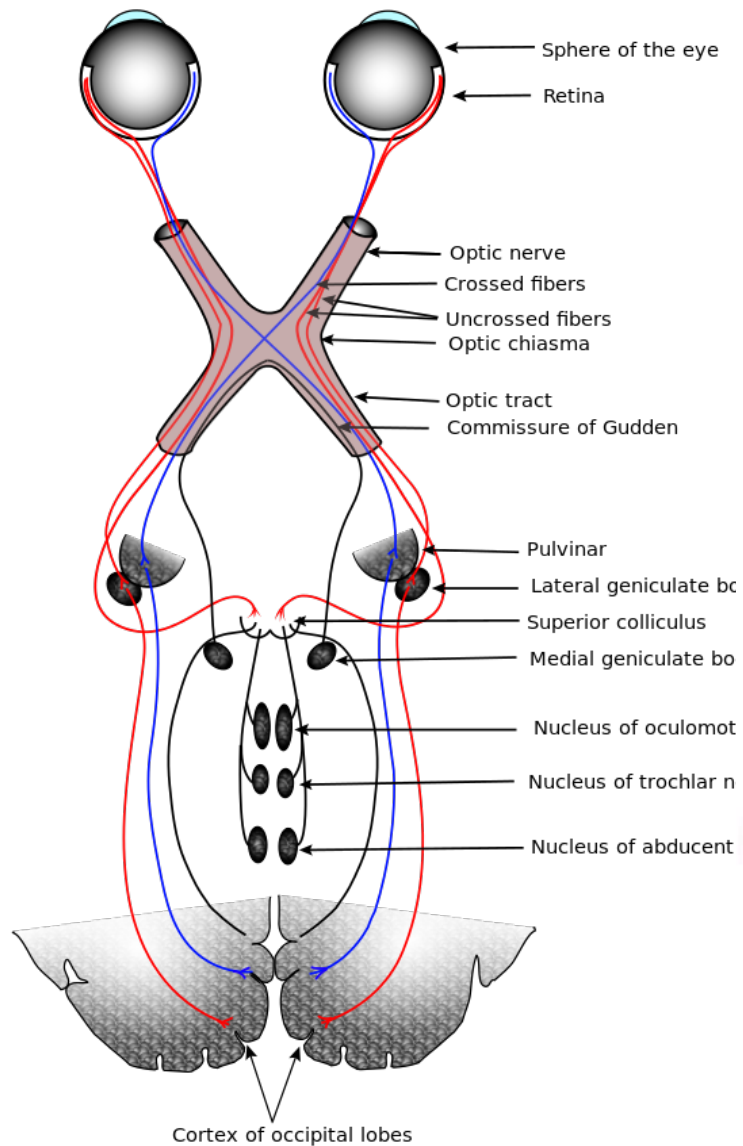

Visual Anticipation

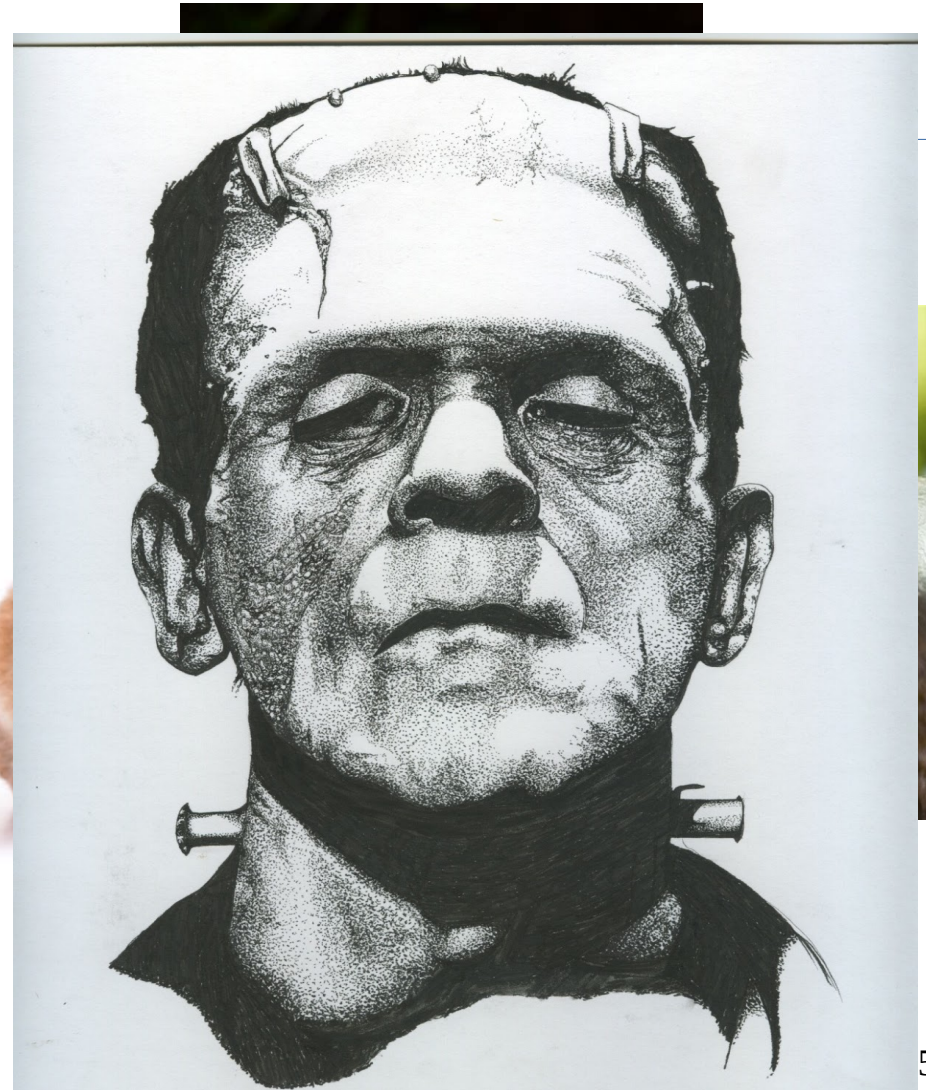
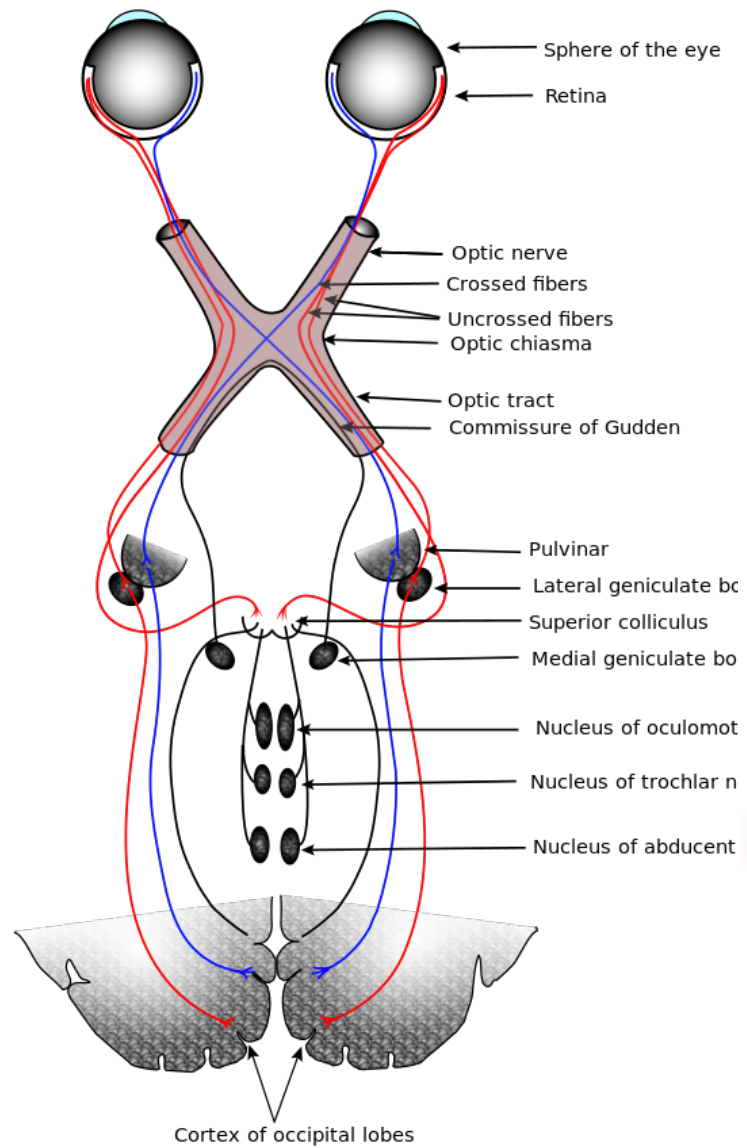

Visual Anticipation

Developing a retino-cortical model of anticipation so as to

understand / propose

possible generic mechanisms for anticipation in the retina and in the cortex.

Anticipation in the retina

The Hubel-Wiesel view of vision

Nobel prize 1981

Ganglion cells response is the convolution of the stimulus with a spatio-temporal receptive field followed by a non linearity

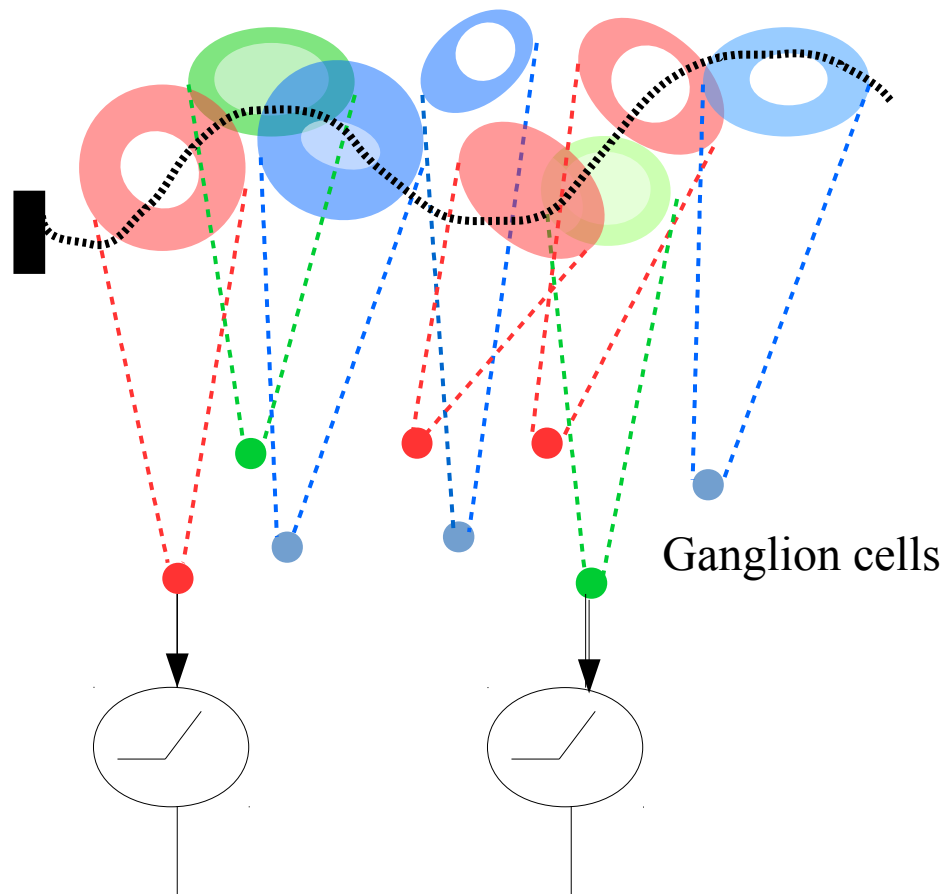

Ganglion cells are independent encoders

The Hubel-Wiesel view of vision

Nobel prize 1981

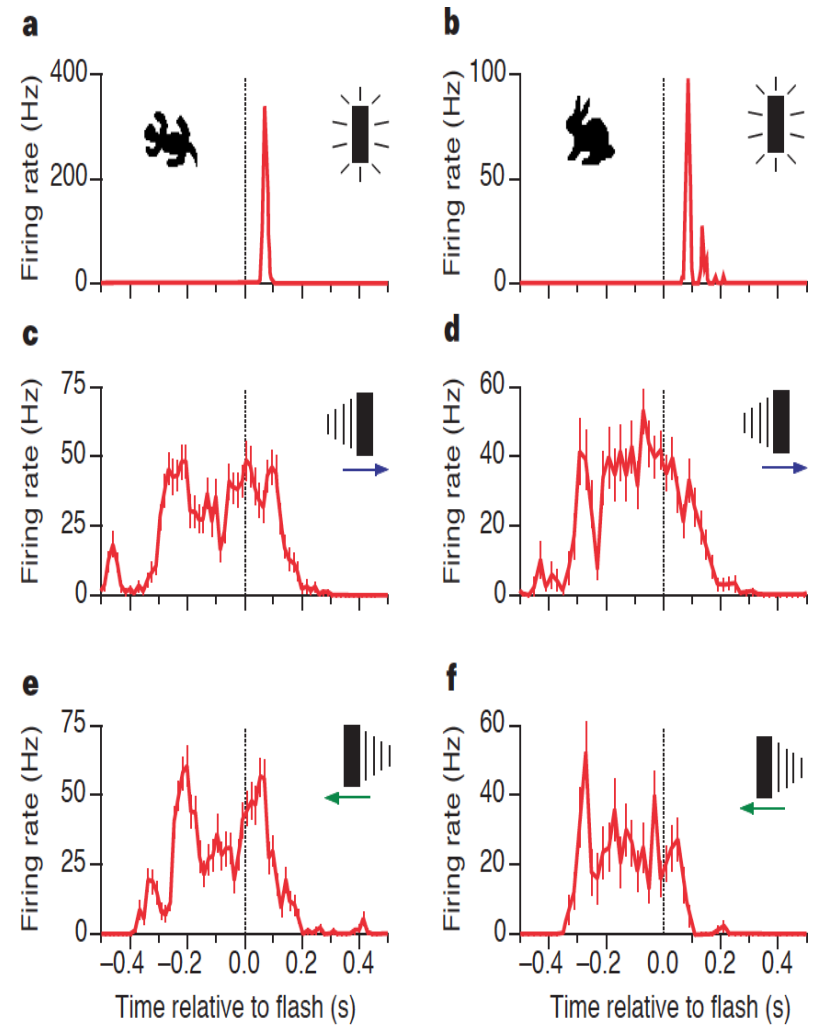
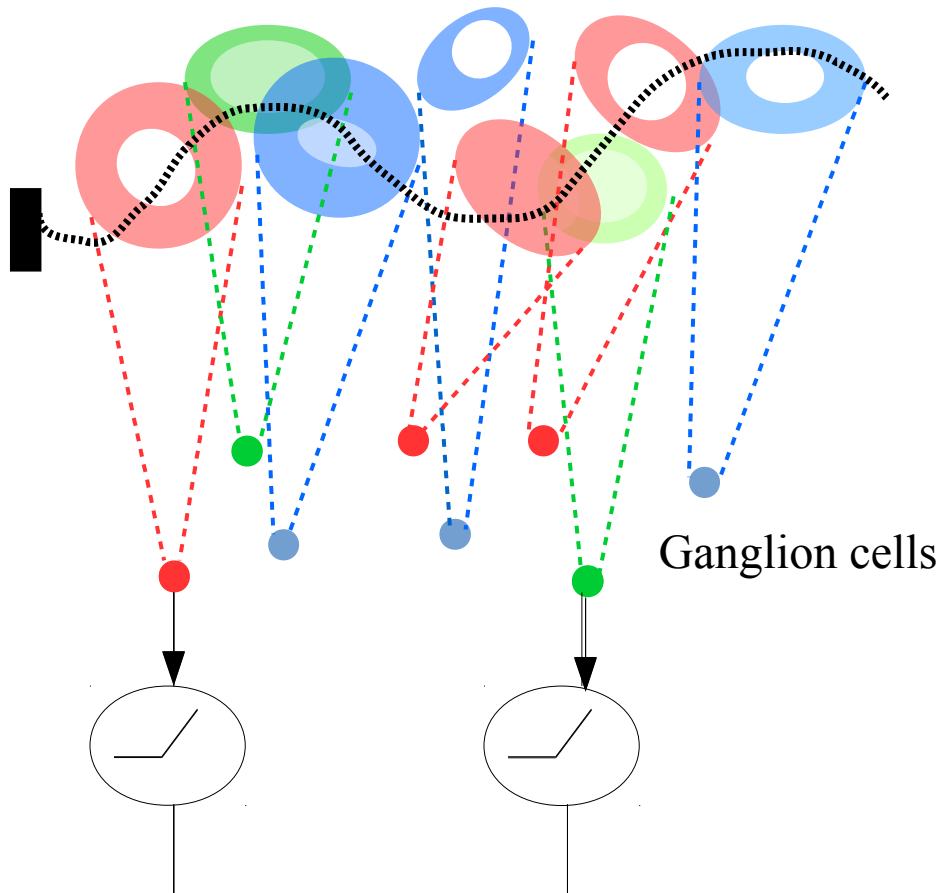

Source : Berry et al. 1999

Building a 2D retina model for motion anticipation

Gain control (Berry et al, 1999, Chen et al. 2013)

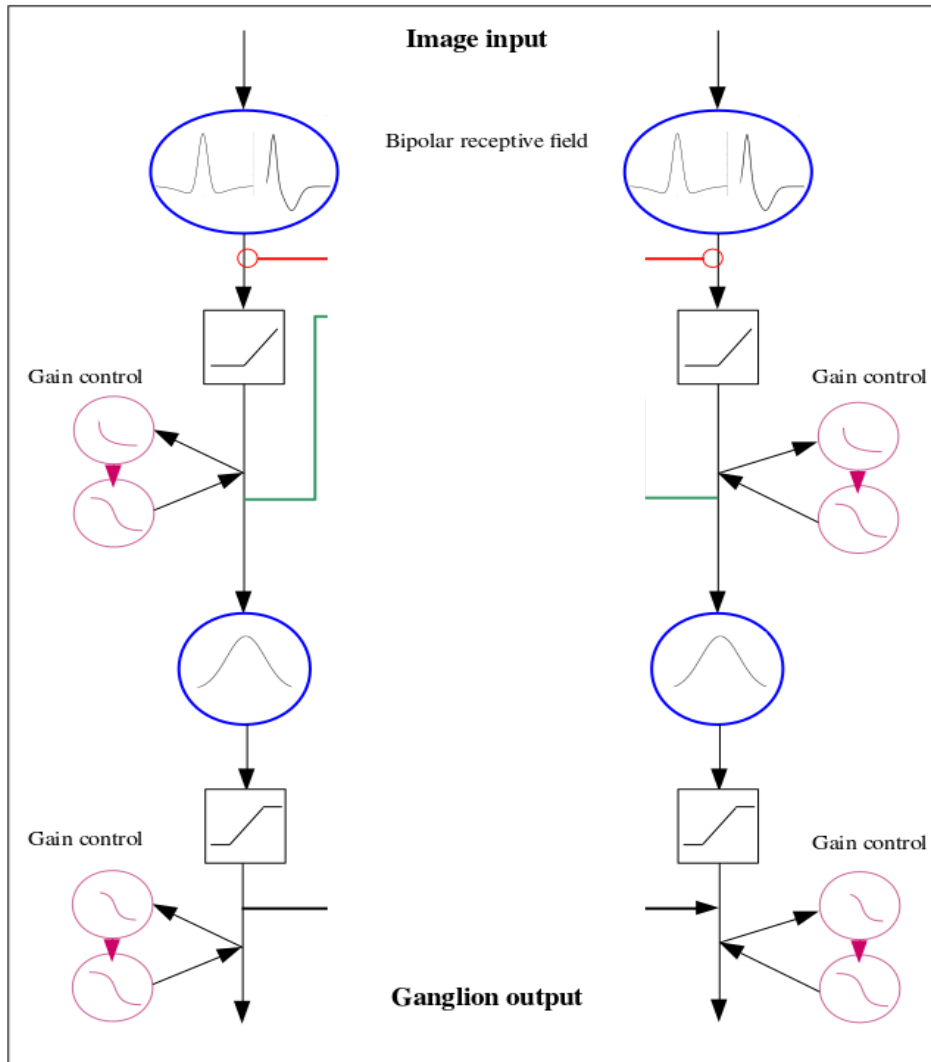

Building a 2D retina model for motion anticipation

Gain control (Berry et al, 1999, Chen et al. 2013)

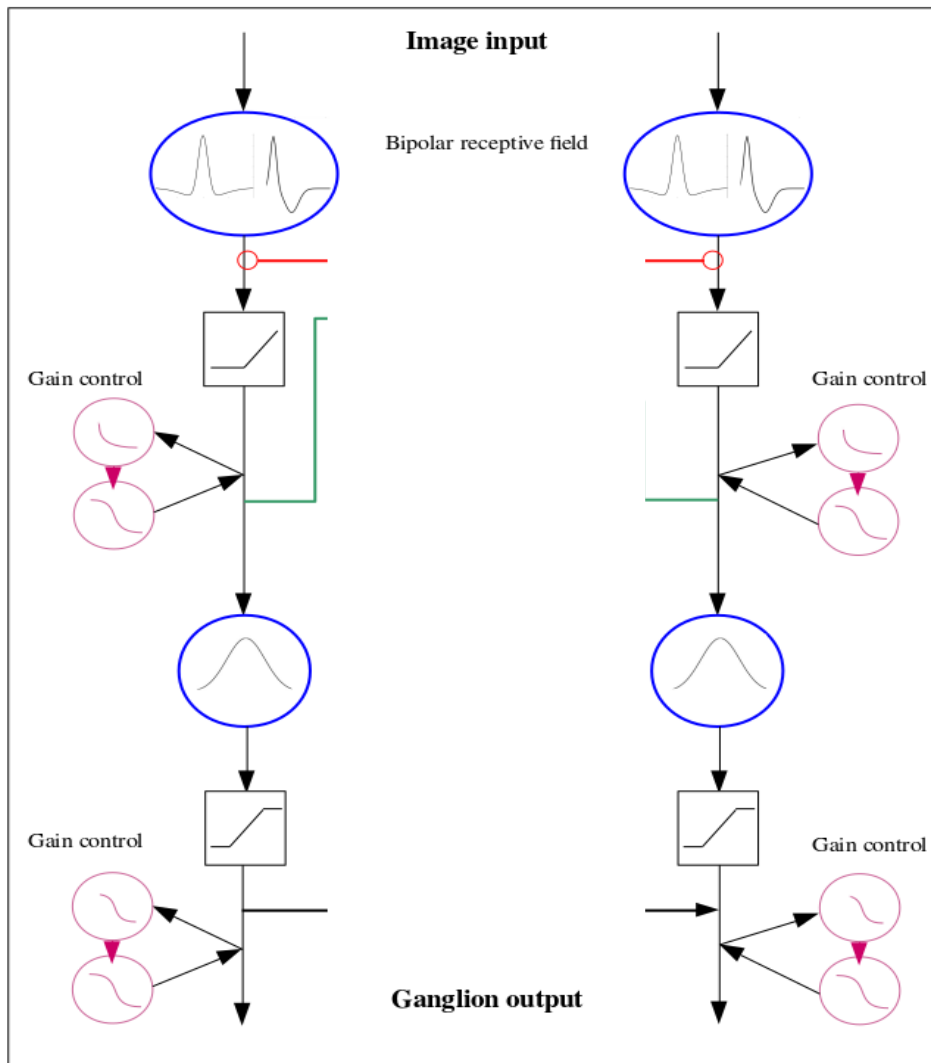

- Bipolar voltage :

$$V_{B_i}(t) = V_{i_{drive}}(t).$$

- Non-linear function :

$$\mathcal{N}_B(V_{B_i}) = \begin{cases} 0, & \text{if } V_{B_i} \leq \theta_B; \\ V_{B_i} - \theta_B, & \text{else.} \end{cases}$$

- Activation function :

$$\frac{dA_{B_i}}{dt} = -\frac{A_{B_i}}{\tau_a} + h\mathcal{N}(V_{B_i}(t)).$$

- Gain Control function :

$$\mathcal{G}_B(A) = \begin{cases} 0, & \text{if } A \leq 0; \\ \frac{1}{1+A^6}, & \text{else.} \end{cases}$$

- Output :

$$R_{B_i} = \mathcal{N}_B(V_{B_i}) \mathcal{G}_B(A_{B_i}).$$

Building a 2D retina model for motion anticipation

Gain control (Chen et al. 2013)

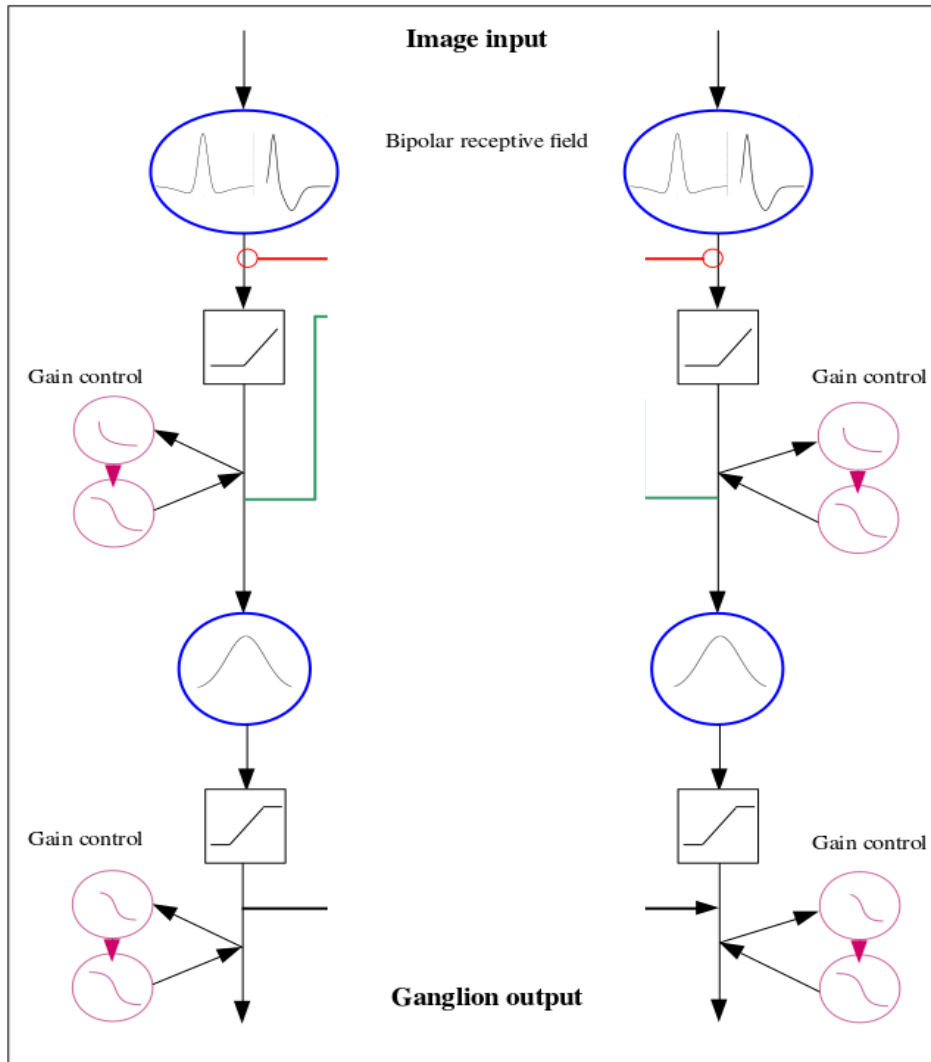

- Ganglion voltage

$$V_{G_k} = \sum_i W_{G_k}^{B_i} R_{B_i}$$

- Non-linear function :

$$N_{G_F}(V) = \begin{cases} 0, & \text{if } V \leq 0; \\ \alpha_{G_F}(V - \theta_{G_F}), & \text{if } \theta_{G_F} \leq V \leq N_{G_F}^{max}/\alpha_{G_F} + \theta_{G_F}; \\ N_{G_F}^{max}, & \text{else.} \end{cases}$$

- Activation function :

$$\frac{dA_{G_F k_F}}{dt} = -\frac{A_{G_F k_F}}{\tau_{G_F}} + h_{G_F} N_{G_F}(V_{G_F k_F})$$

- Gain Control function :

$$G_{G_F}(A) = \begin{cases} 0, & \text{if } A \leq 0; \\ \frac{1}{1+A}, & \text{else.} \end{cases}$$

- Output :

$$R_{G_F k_F}(V_{G_F k_F}, A_{G_F k_F}) = N_{G_F}(V_{G_F k_F}) G_{G_F}(A_{G_F k_F}).$$

Building a 2D retina model for motion anticipation

1) Gain control

How does it work ?

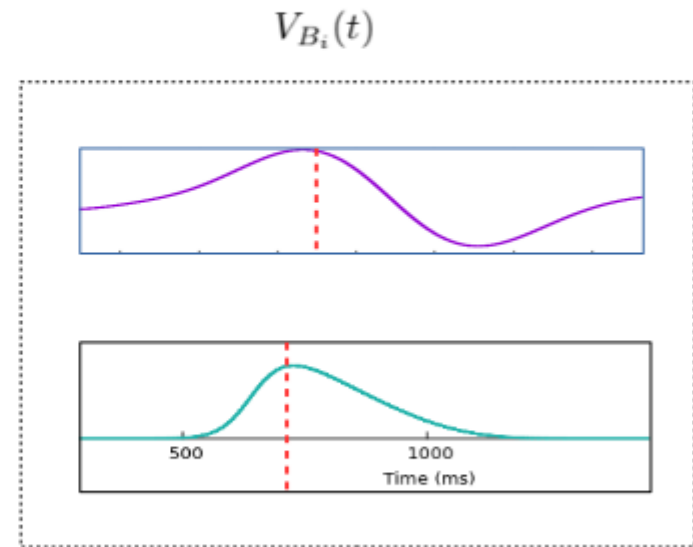
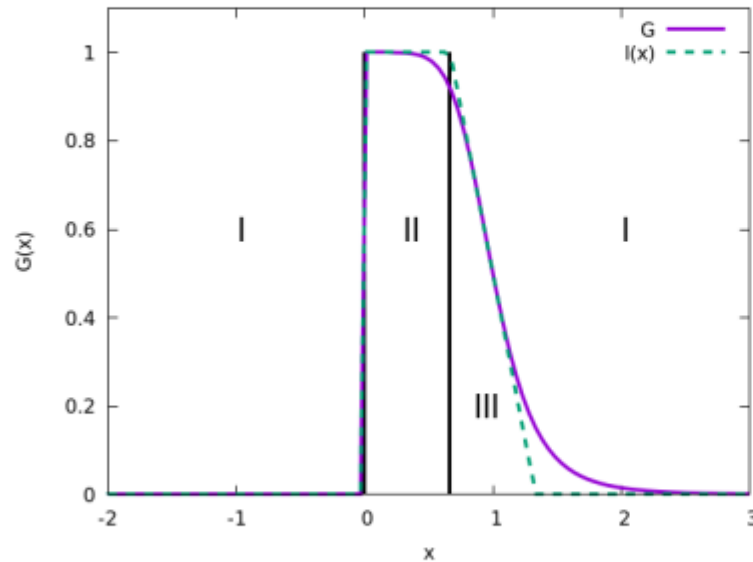

$$\mathcal{G}_B(A) = \begin{cases} 0, & \text{if } A \leq 0; \\ \frac{1}{1+A^6}, & \text{else.} \end{cases}$$

$$R_{B_i} = \mathcal{N}_B(V_{B_i}) \mathcal{G}_B(A_{B_i}).$$

1D results : smooth motion anticipation with gain control

Bipolar layer

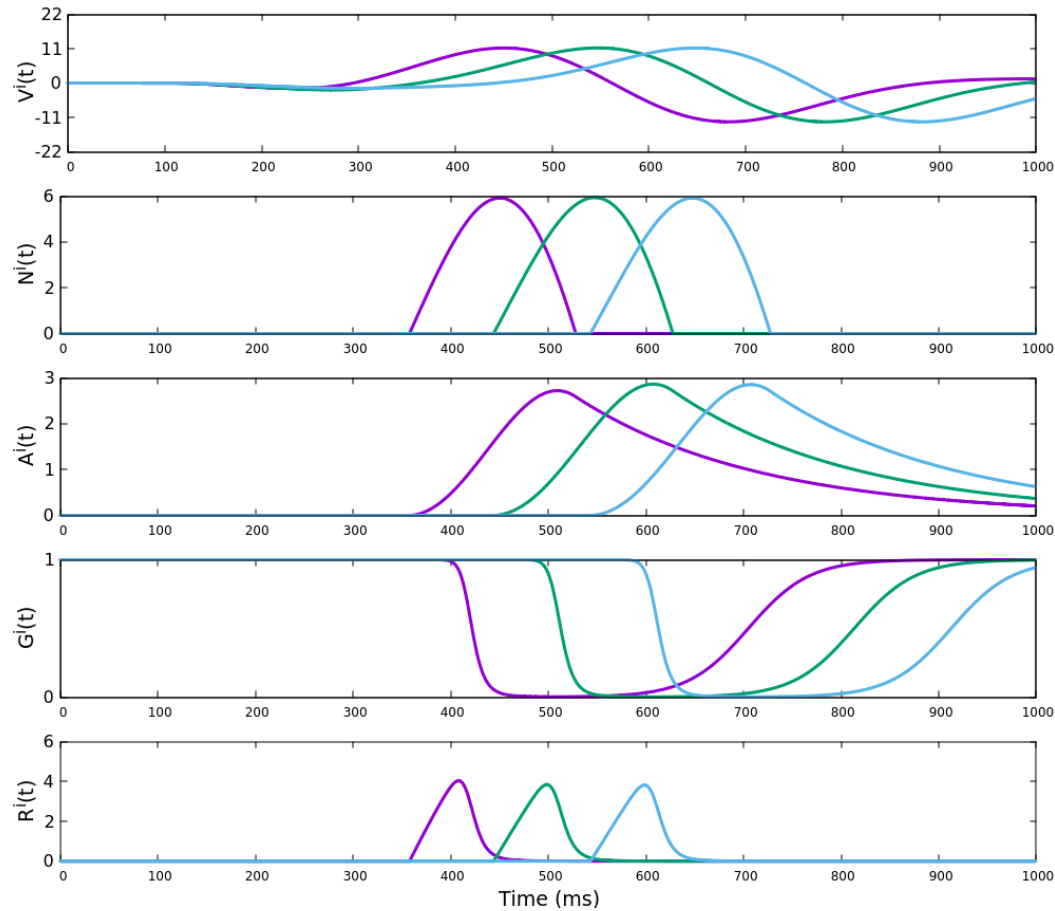

Ganglion layer

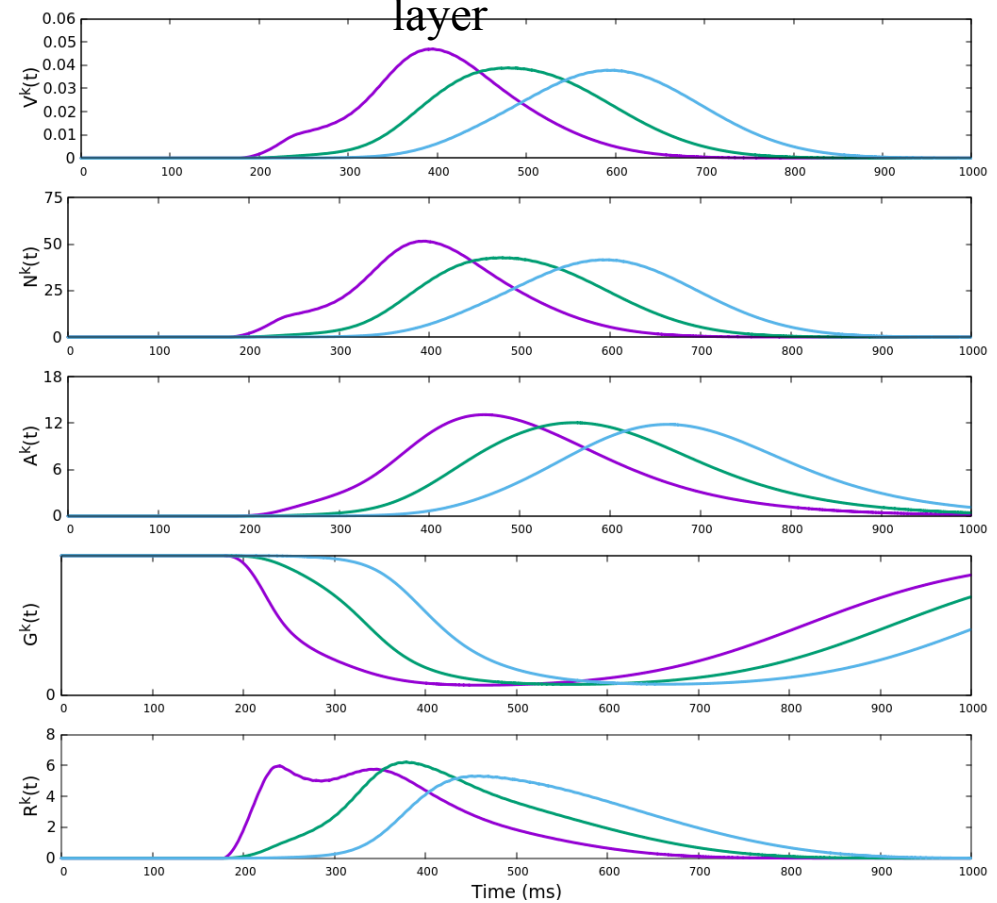

1D results : smooth motion anticipation with gain control

Anticipation variability with stimulus
parameters

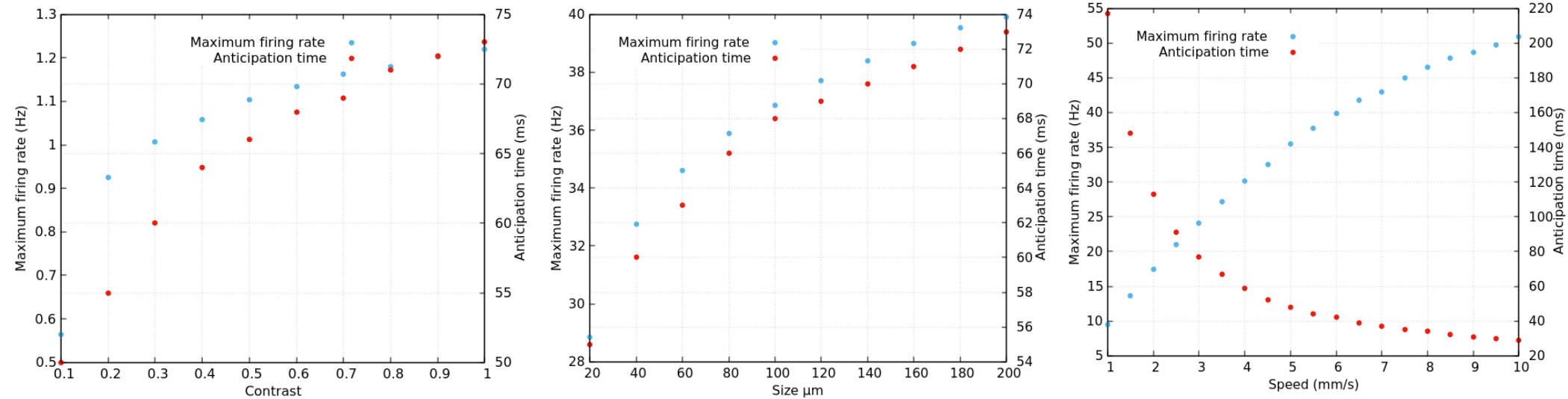

Building a 2D retina model for motion anticipation

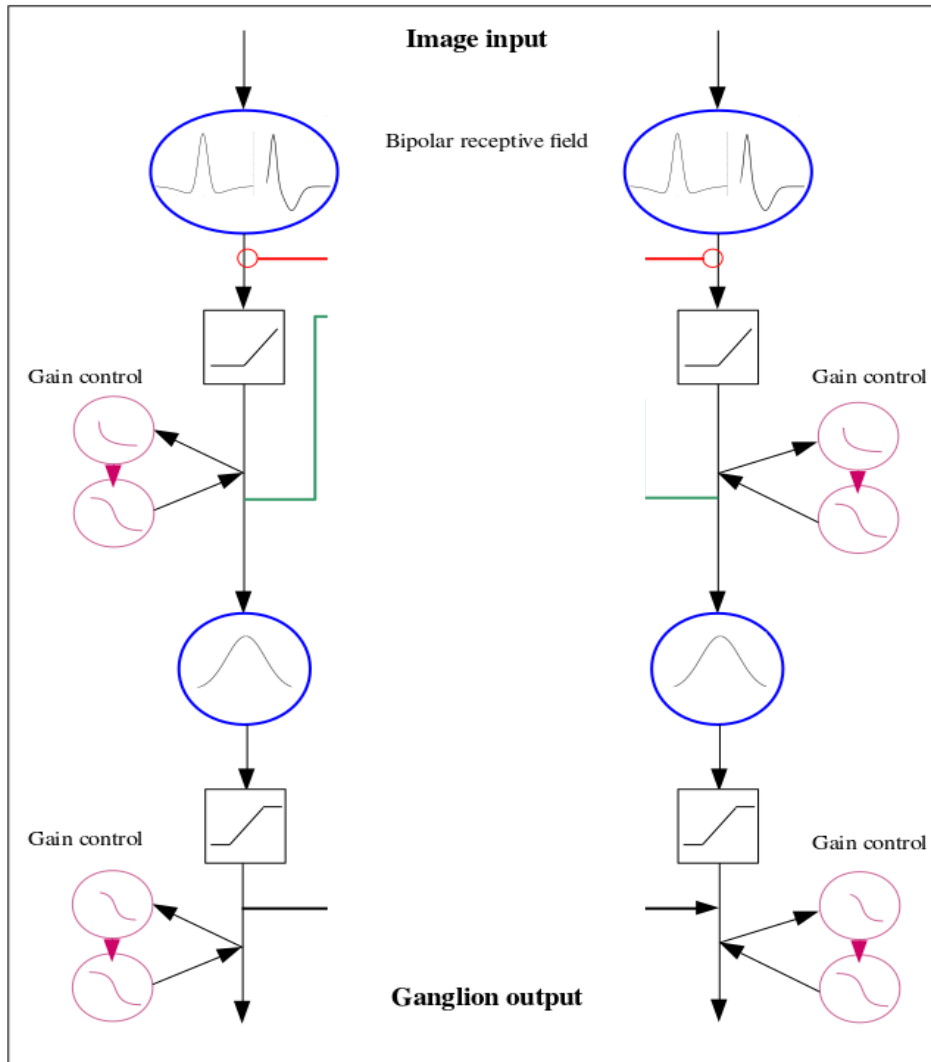

Ganglion cells are independent encoders

Building a 2D retina model for motion anticipation

Gap junctions connectivity

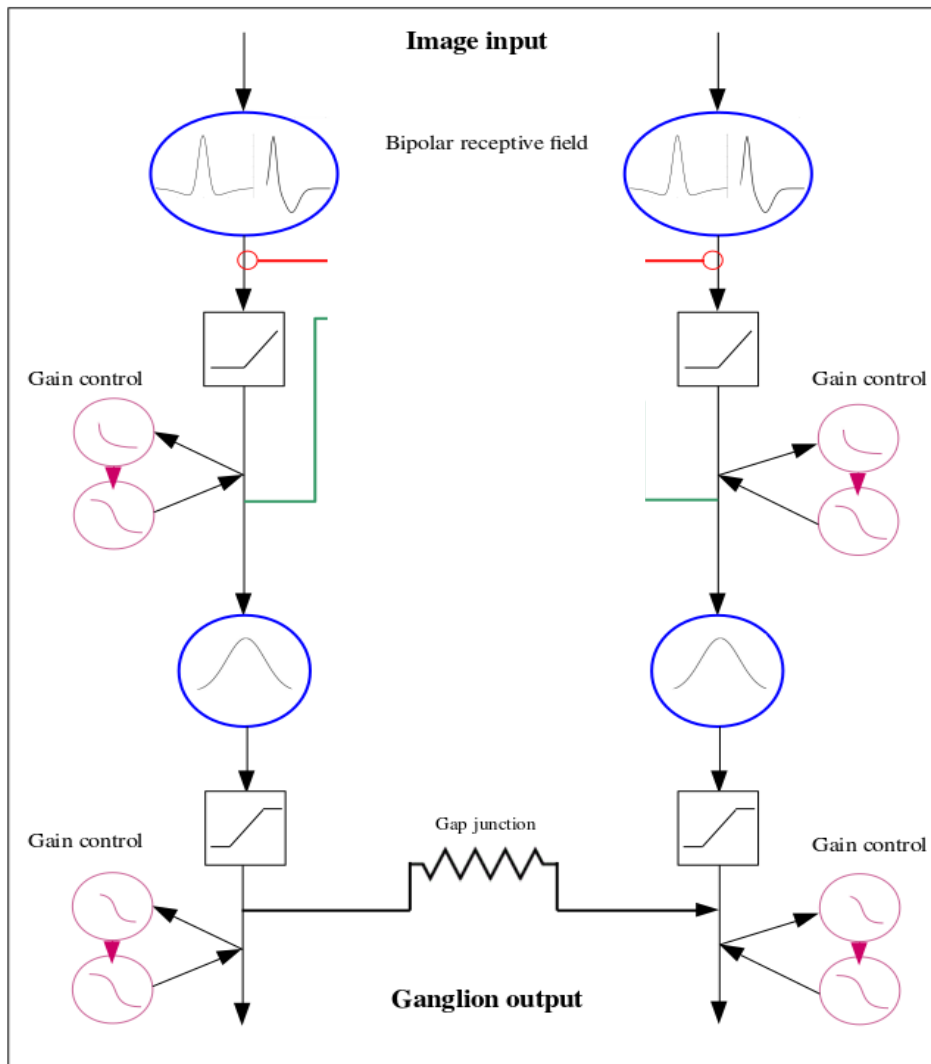

Ganglion cells are **not** independent encoders

Building a 2D retina model for motion anticipation

Gap junctions connectivity

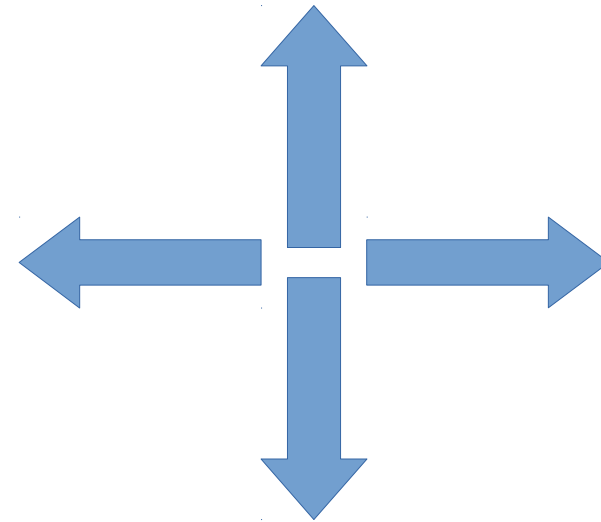
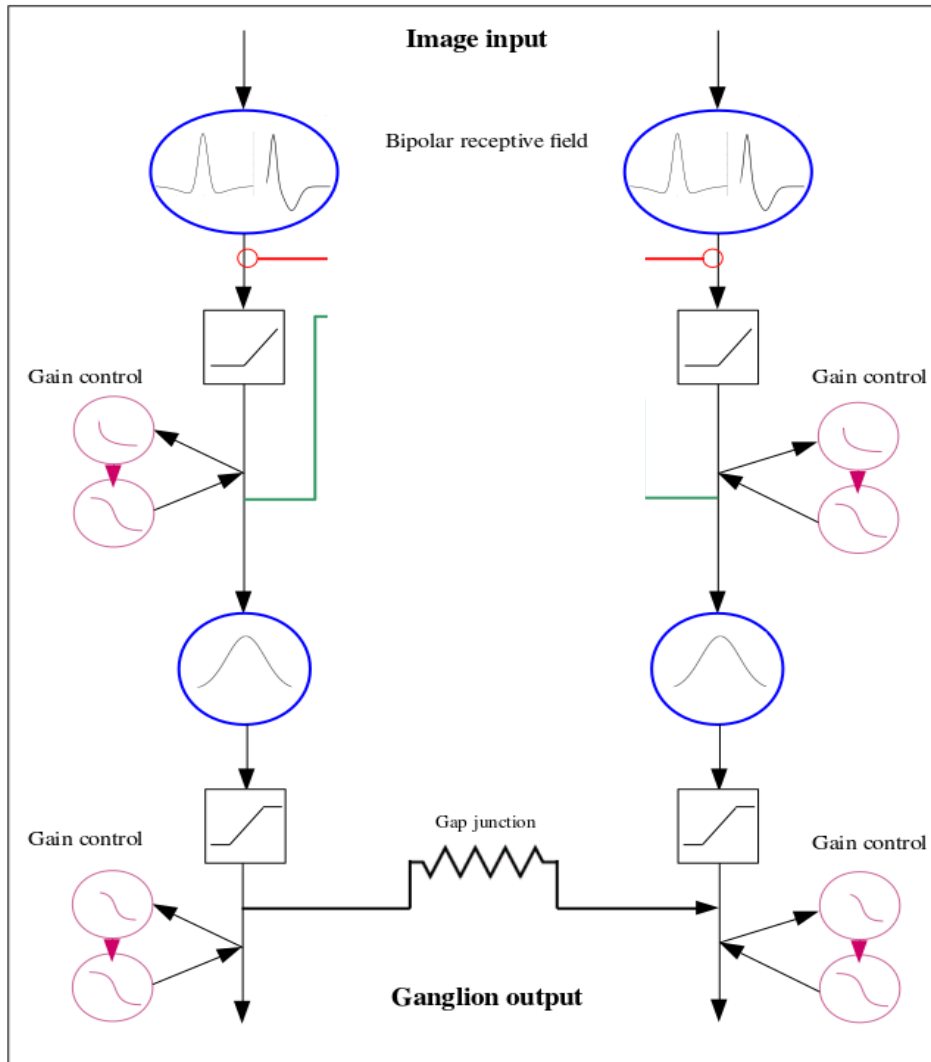

Building a 2D retina model for motion anticipation

Gap junctions connectivity

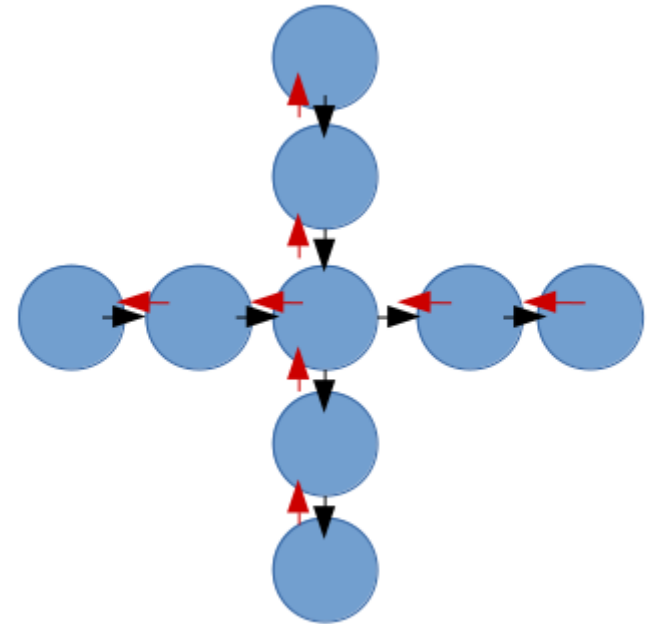
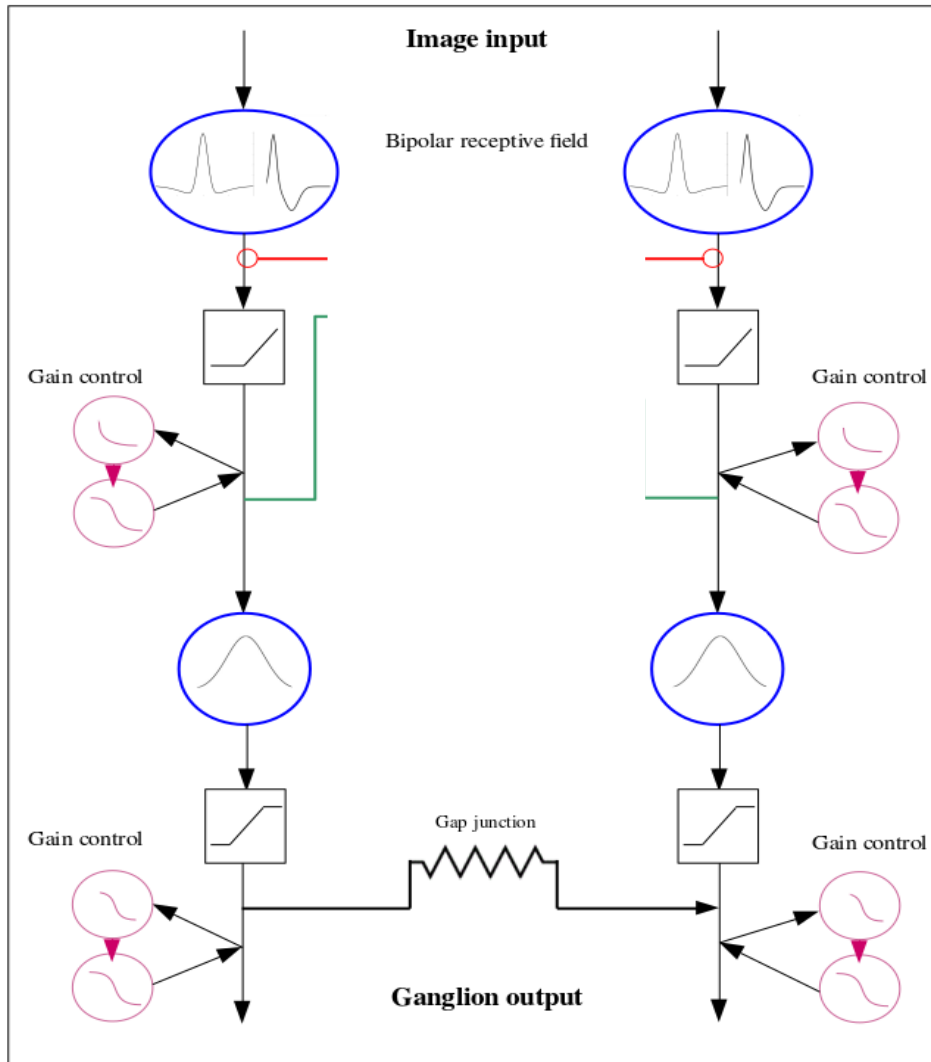

Building a 2D retina model for motion anticipation

Gap junctions connectivity

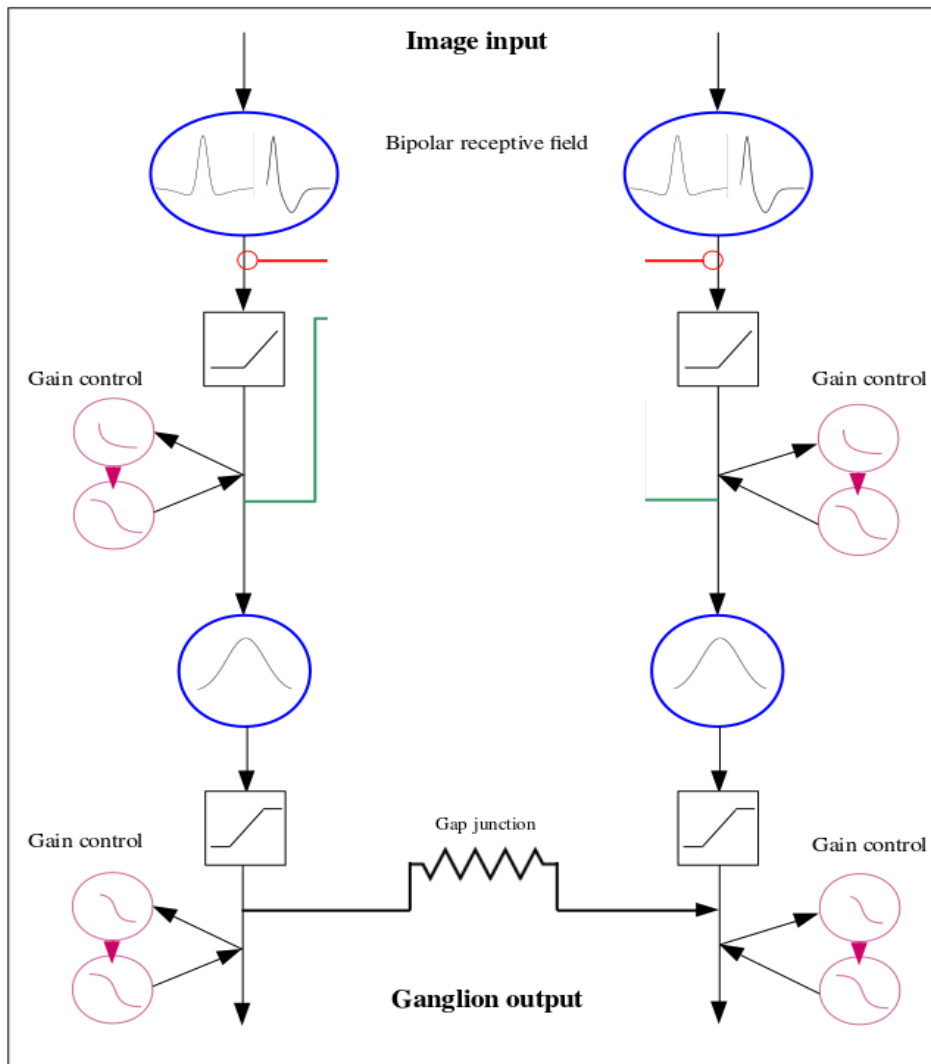

- A class of direction selective RGCs are connected through gap junctions
- Their activity comprises the activity pooled from bipolar cells and the activity coming from the downstream RGCs, in the direction of motion

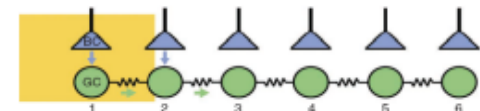

$$R_{GDkD} = V_{GDkD} + \beta R_{GDkD-1}$$

Building a 2D retina model for motion anticipation

Gap junctions connectivity

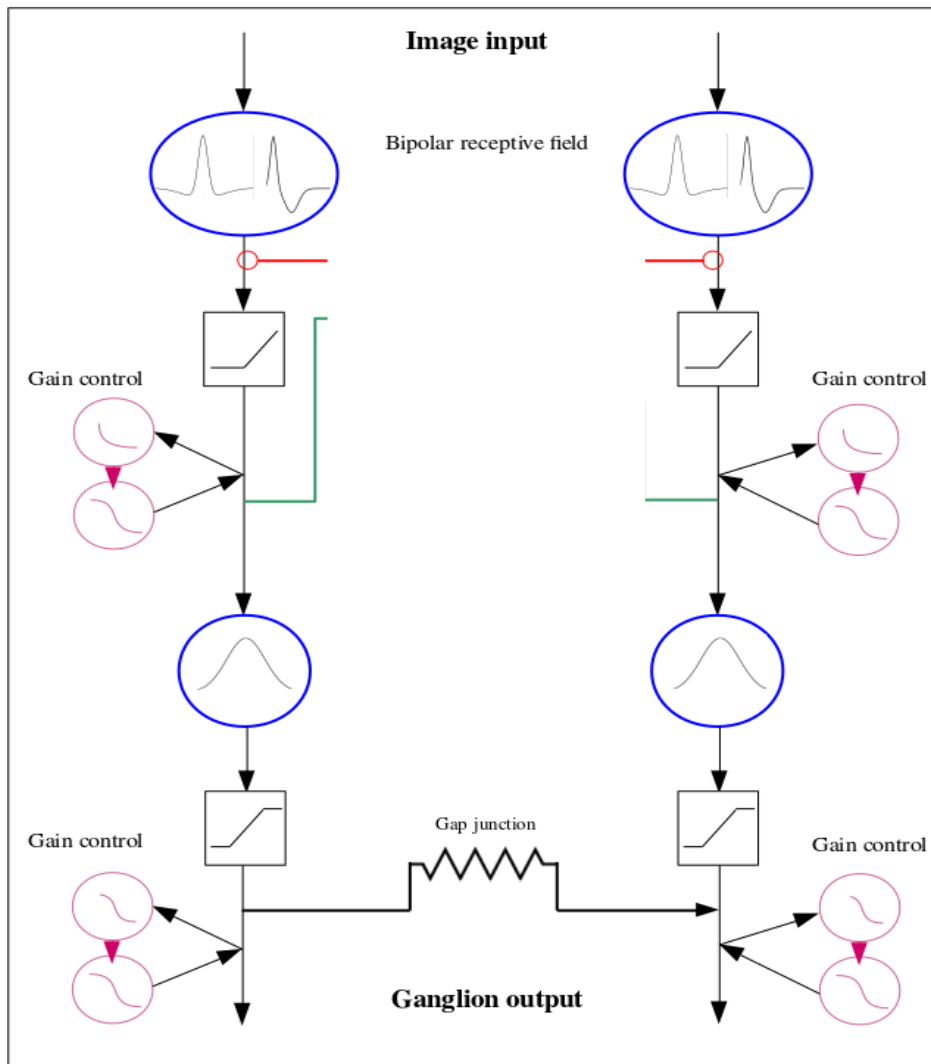

- A class of direction selective RGCs are connected through gap junctions
- Their activity comprises the activity pooled from bipolar cells and the activity coming from the downstream RGCs, in the direction of motion

Diffusive wave of activity ahead of the motion

$$R_{GDkD} = V_{GDkD} + \beta R_{GDkD-1}$$

Smooth motion anticipation with gap junctions

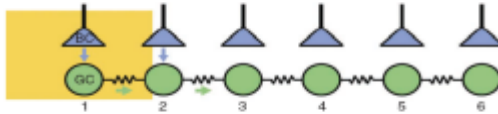

Smooth motion anticipation with gap junctions

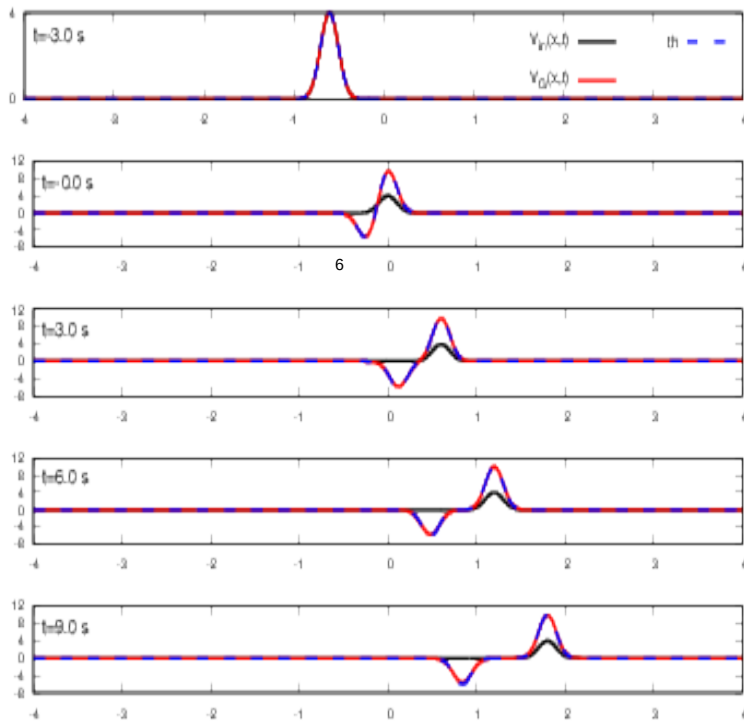
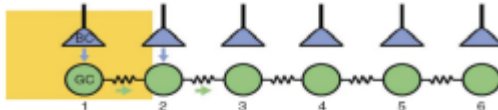

Low gap junction conductance

Smooth motion anticipation with gap junctions

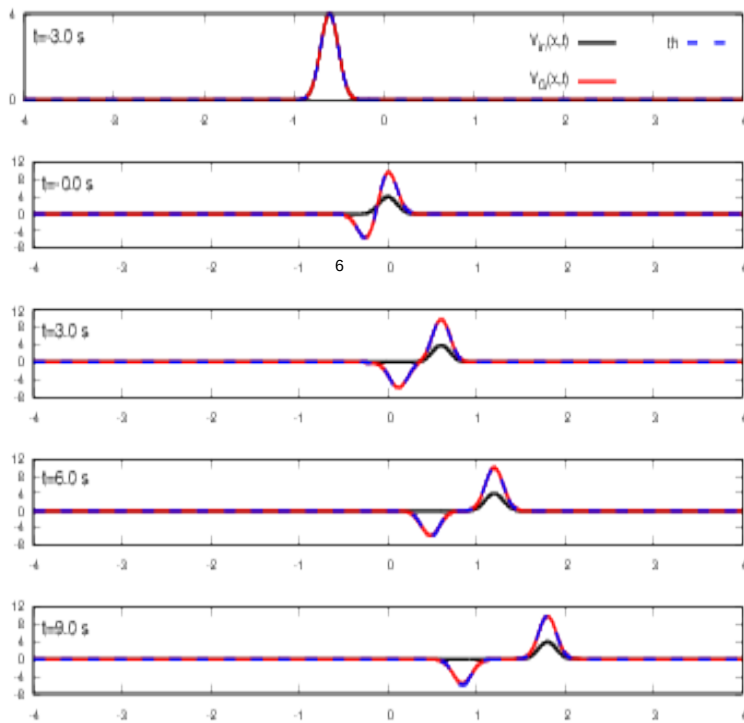
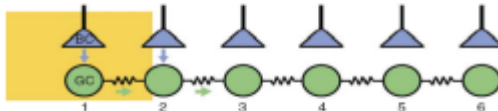

Low gap junction conductance

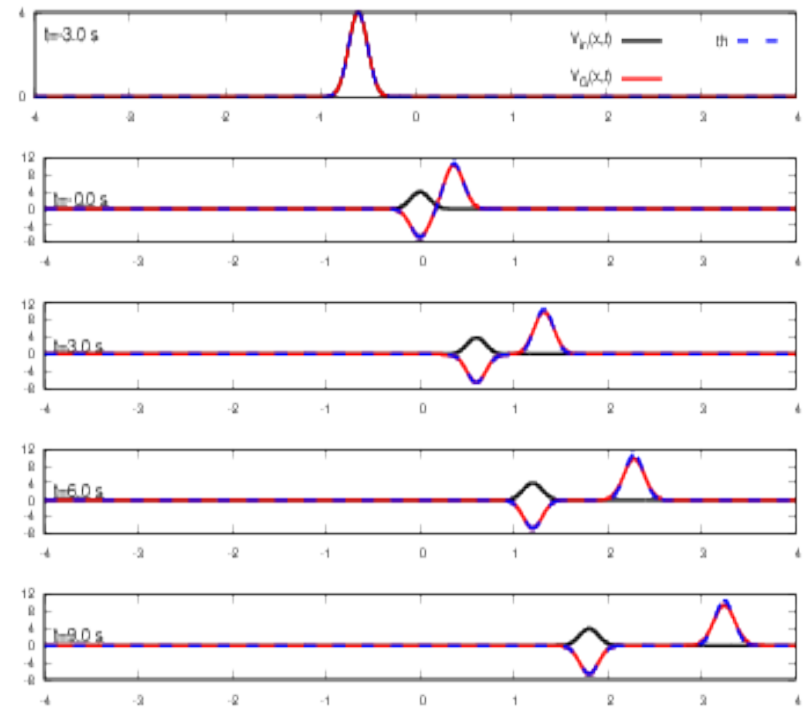

High gap junction conductance

Smooth motion anticipation with gap junctions

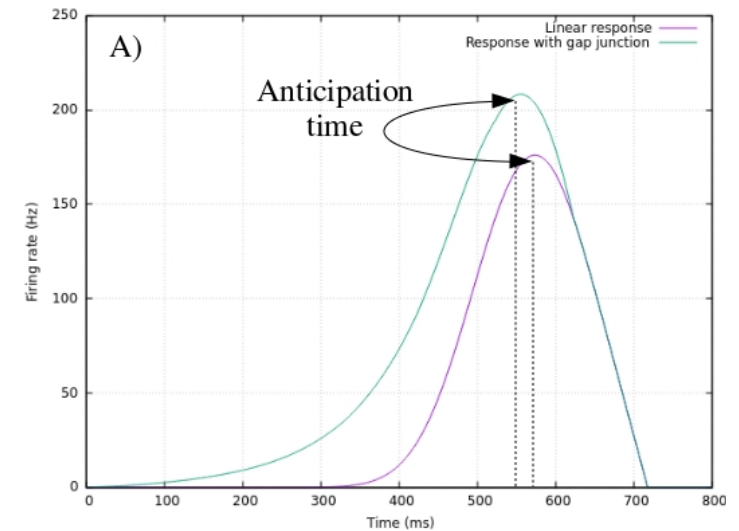
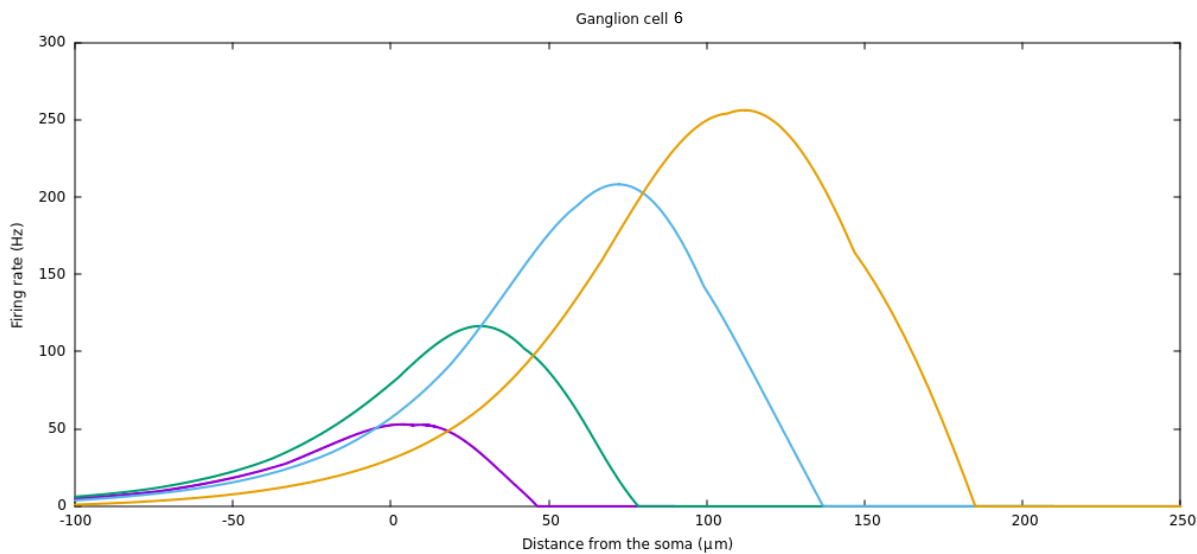
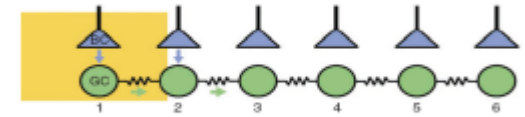

Smooth motion anticipation with gap junctions

Anticipation variability with stimulus parameters

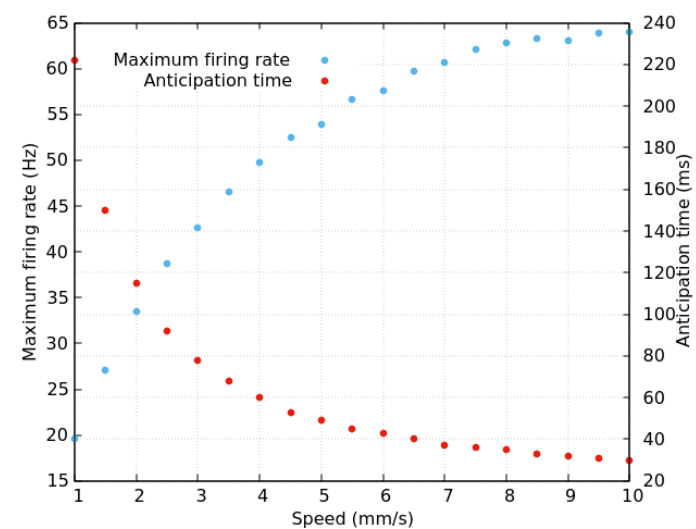
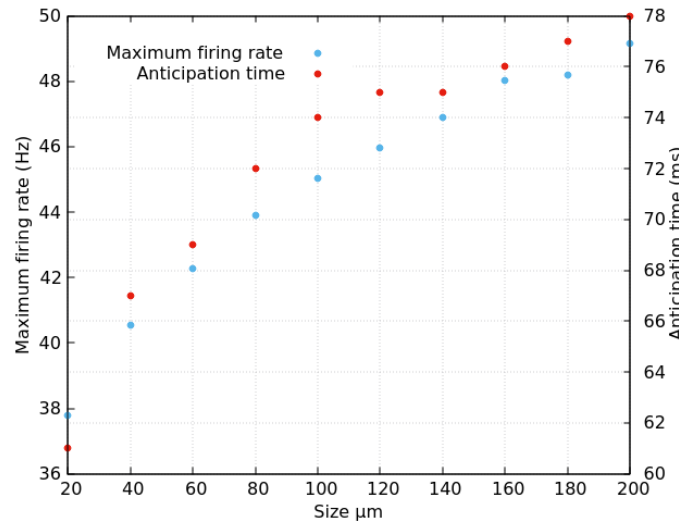
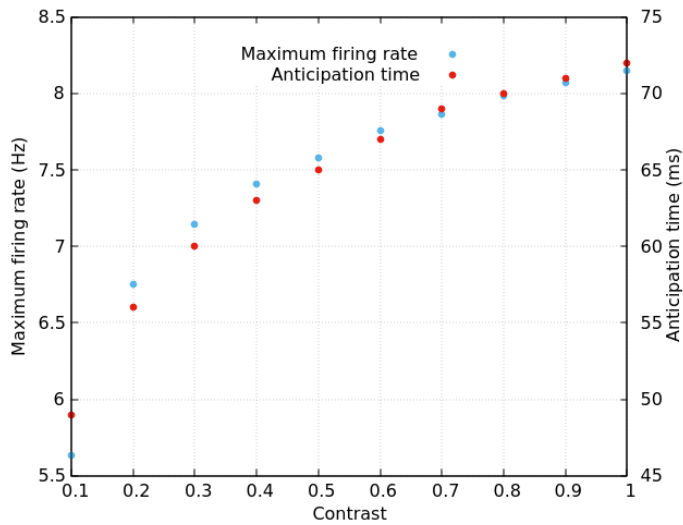

Building a 2D retina model for motion anticipation

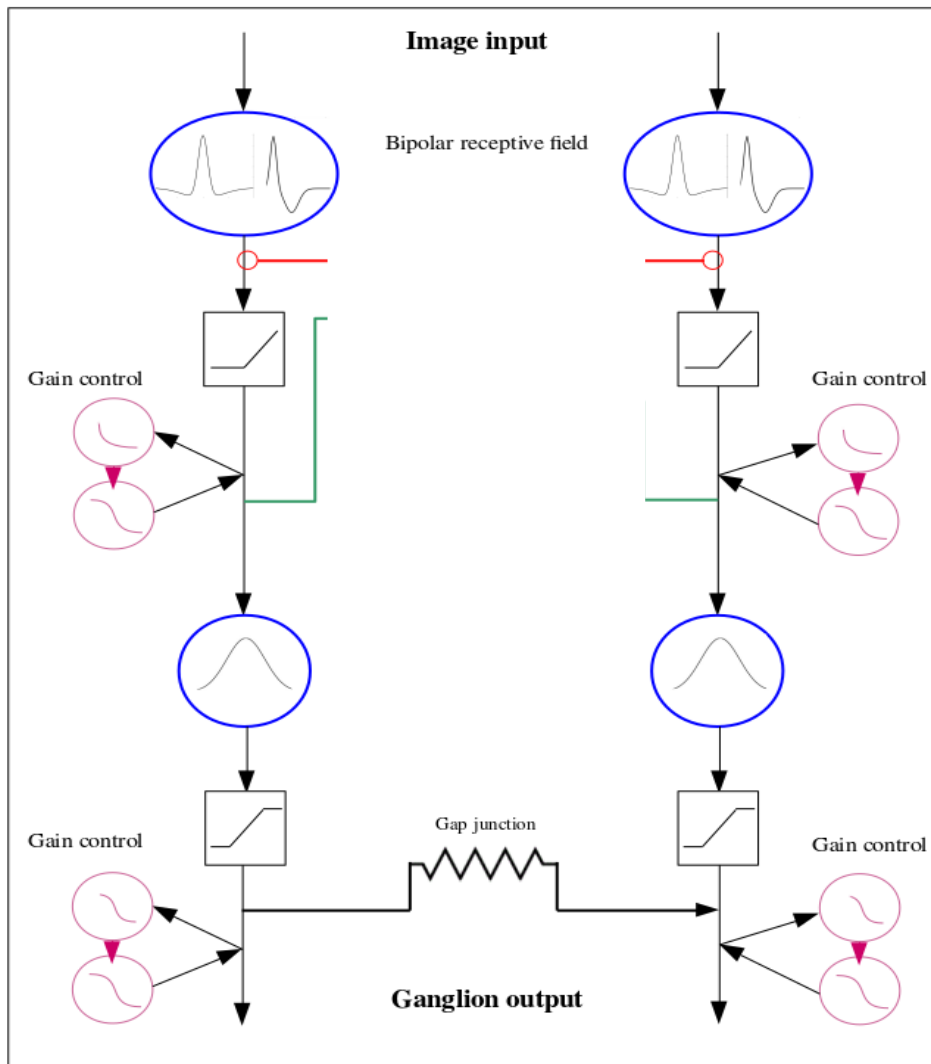

Building a 2D retina model for motion anticipation

Amacrine cells connectivity

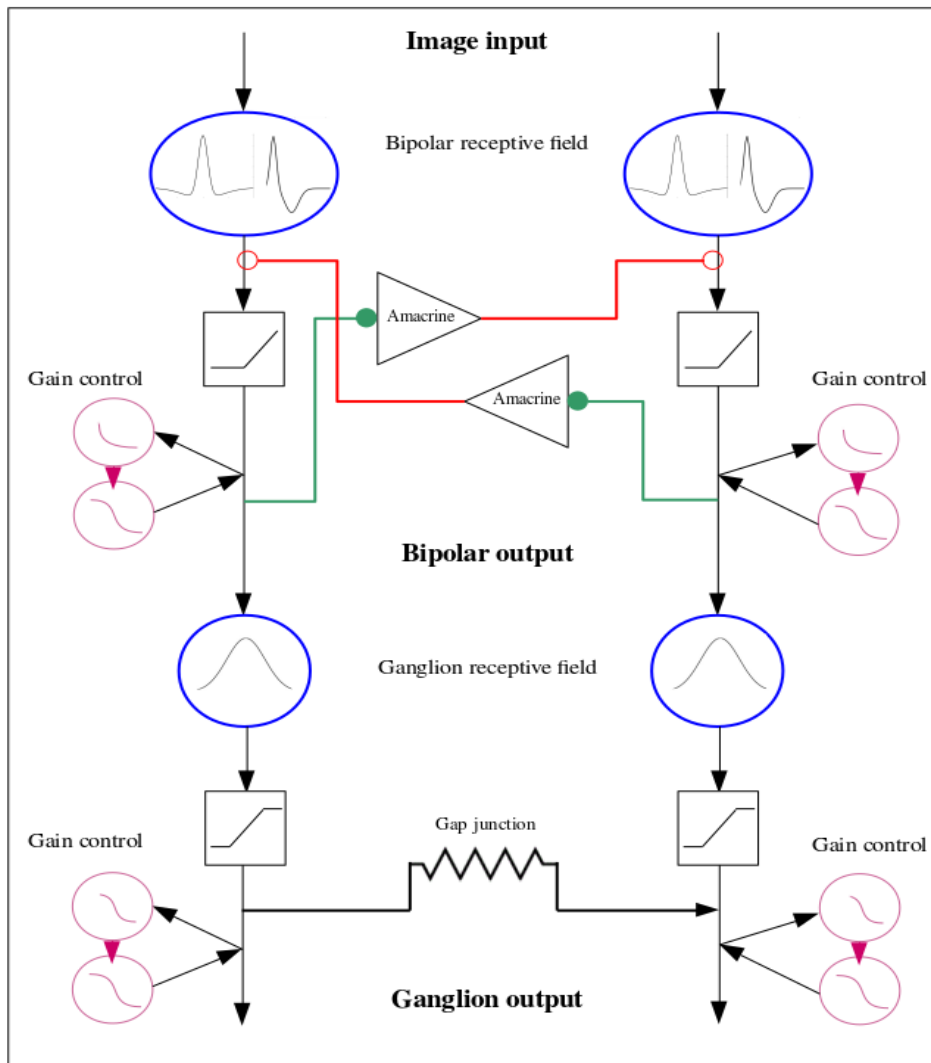

Ganglion cells are **not** independent encoders

Building a 2D retina model for motion anticipation

Amacrine cells connectivity

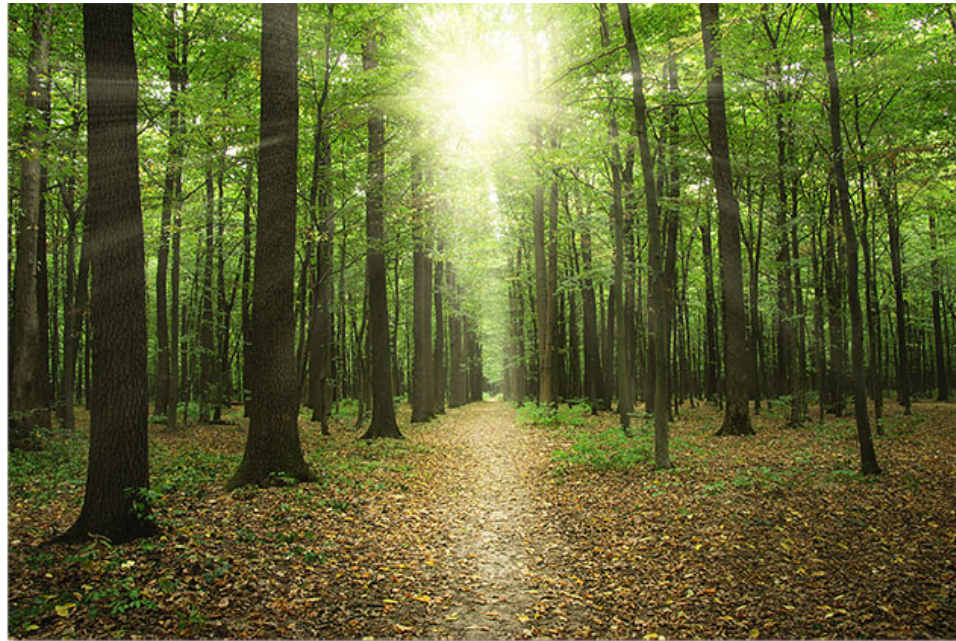

Building a 2D retina model for motion anticipation

Amacrine cells connectivity

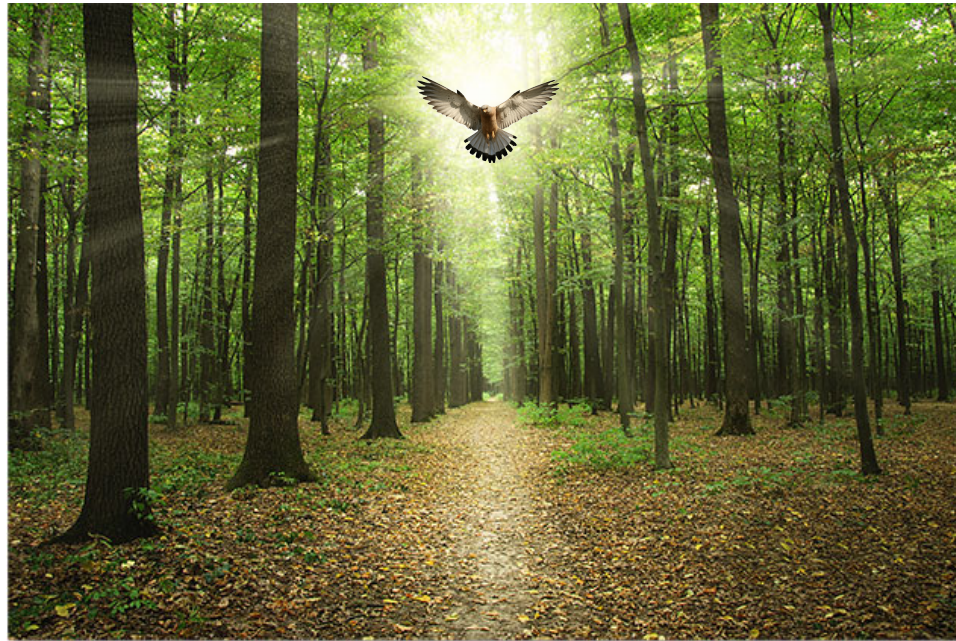

Building a 2D retina model for motion anticipation

Amacrine cells connectivity

- A class of RGCs are selective to differential motion



- The circuitry involves amacrine cells connectivity upstream of ganglion cells

Building a 2D retina model for motion anticipation

Amacrine cells connectivity

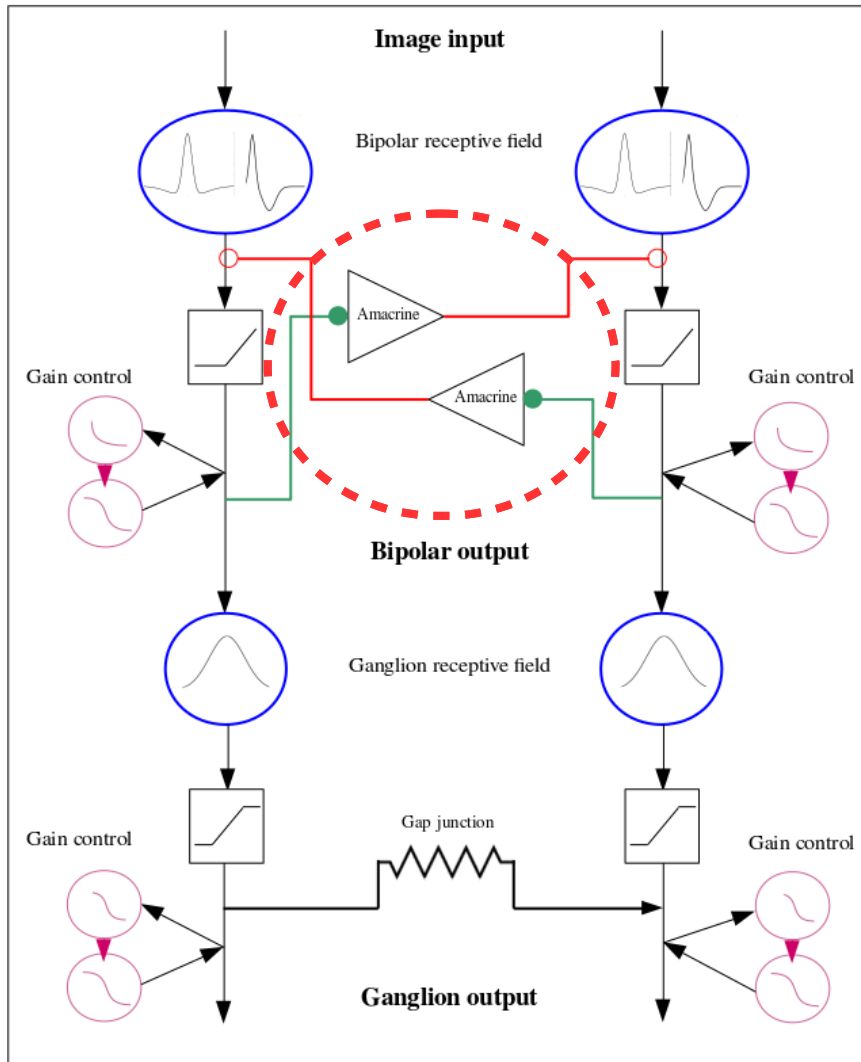

Building a 2D retina model for motion anticipation

Amacrine cells connectivity

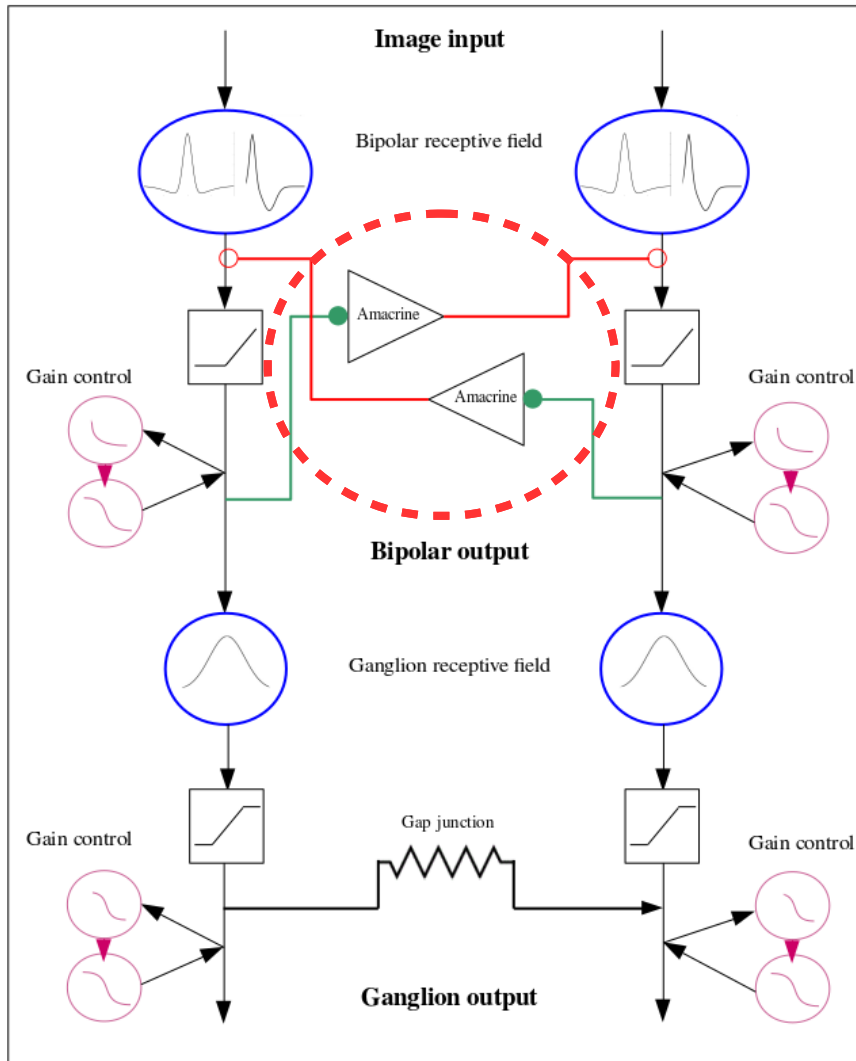

- Bipolar voltage :

$$\frac{dV_{B_i}}{dt} = -\frac{1}{\tau_B} V_{B_i} + \sum_{j=1}^{N_A} W_{B_i}^{A_j} V_{A_j} + F_{B_i}(t).$$

- External drive :

$$F_{B_i}(t) = \left[K_i^{S,t} * \left(\frac{S}{\tau_B} + \frac{dS}{dt} \right) \right] (t)$$

- Amacrine voltage :

$$\frac{dV_{A_j}}{dt} = -\frac{1}{\tau_A} V_{A_j}(t) + \sum_{i=1}^{N_A} W_{A_j}^{B_i} R_{B_i}(t).$$

- Coupled dynamics :

$$\begin{cases} \frac{dV_{B_i}}{dt} = -\frac{1}{\tau_B} V_{B_i} + \sum_{j=1}^{N_A} W_{B_i}^{A_j} V_{A_j} + F_{B_i}(t) \\ \frac{dA_{B_i}}{dt} = -\frac{A_{B_i}}{\tau_a} + h \mathcal{N}(V_{B_i}(t)), \\ \frac{dV_{A_j}}{dt} = -\frac{1}{\tau_A} V_{A_j}(t) + \sum_{i=1}^{N_A} W_{A_j}^{B_i} R_{B_i}(t). \end{cases}$$

Building a 2D retina model for motion anticipation

Amacrine cells connectivity

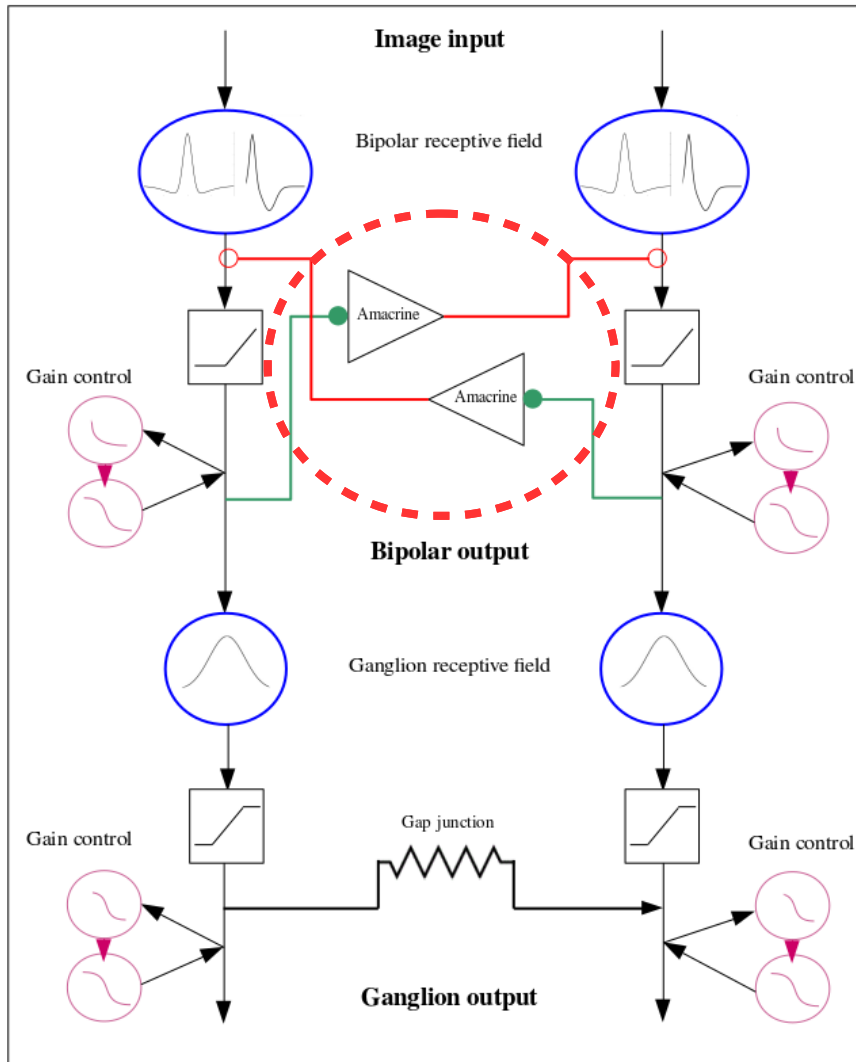

- Bipolar voltage :

$$\frac{dV_{B_i}}{dt} = -\frac{1}{\tau_B} V_{B_i} + \sum_{j=1}^{N_A} W_{B_i}^{A_j} V_{A_j} + F_{B_i}(t).$$

- External drive :

$$F_{B_i}(t) = \left[K_i \frac{s_i}{s_i + 1} \left(\frac{S}{\tau_B} + \frac{dS}{dt} \right) \right] (t)$$

- Amacrine voltage :

$$\frac{dV_{A_j}}{dt} = -\frac{1}{\tau_A} V_{A_j} + \sum_{i=1}^{N_B} W_{A_j}^{B_i} R_{B_i}(t).$$

Diffusive wave of activity ahead of the bar

- Coupled dynamics :

$$\begin{cases} \frac{dV_{B_i}}{dt} = -\frac{1}{\tau_B} V_{B_i} + \sum_{j=1}^{N_A} W_{B_i}^{A_j} V_{A_j} + F_{B_i}(t) \\ \frac{dA_{B_i}}{dt} = -\frac{A_{B_i}}{\tau_a} + h \mathcal{N}(V_{B_i}(t)), \\ \frac{dV_{A_j}}{dt} = -\frac{1}{\tau_A} V_{A_j}(t) + \sum_{i=1}^{N_B} W_{A_j}^{B_i} R_{B_i}(t). \end{cases}$$

Building a 2D retina model for motion anticipation

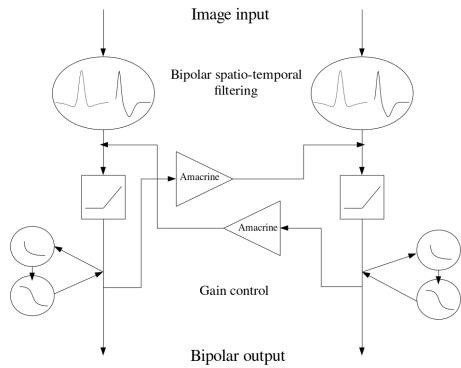

Building a 2D retina model for motion anticipation

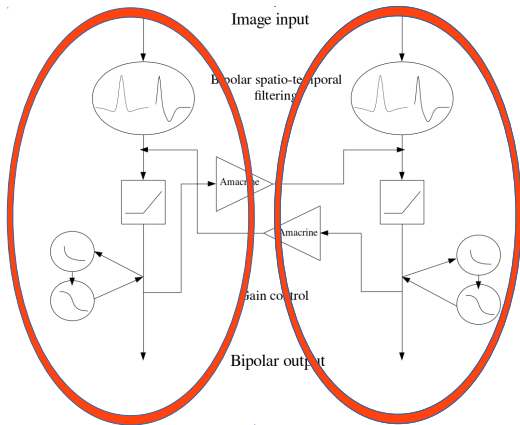

Building a 2D retina model for motion anticipation

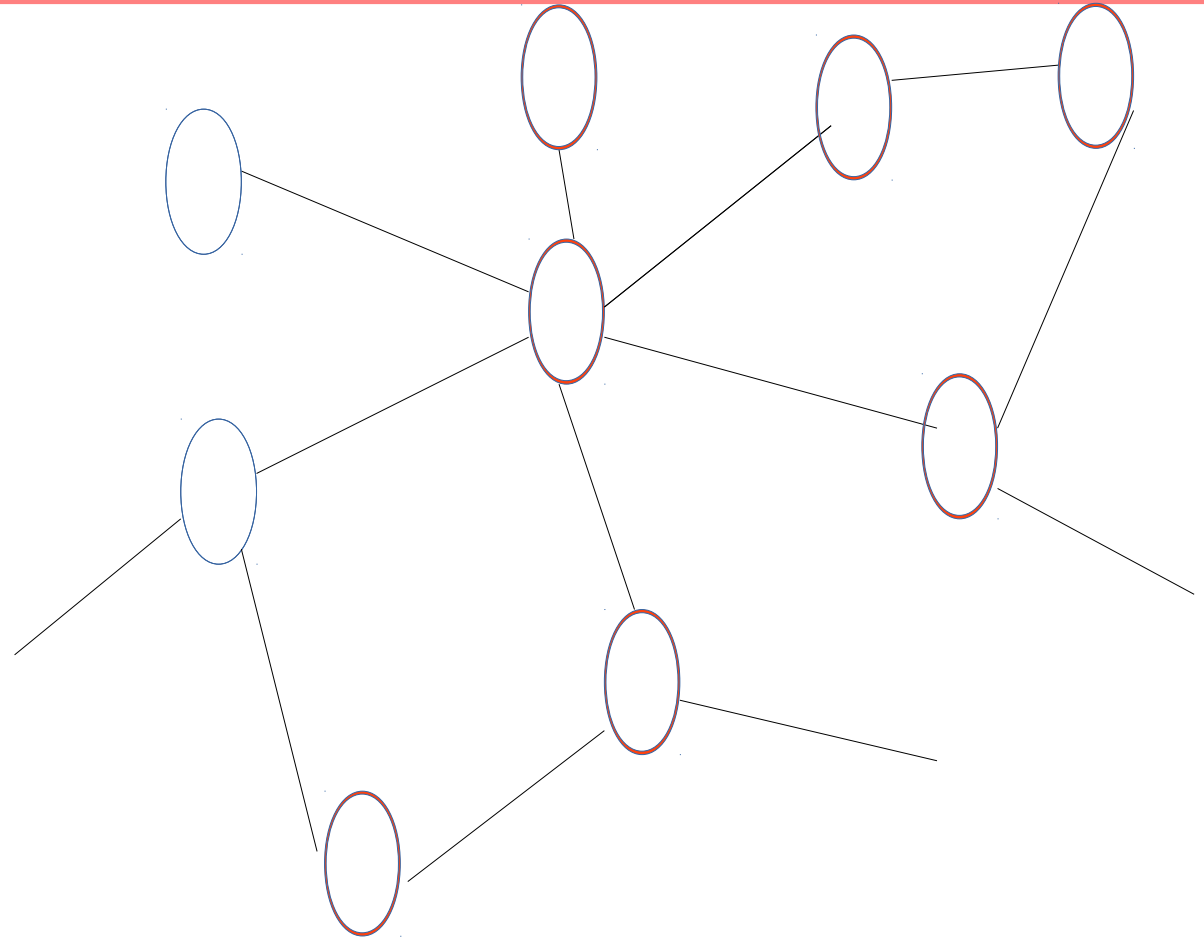
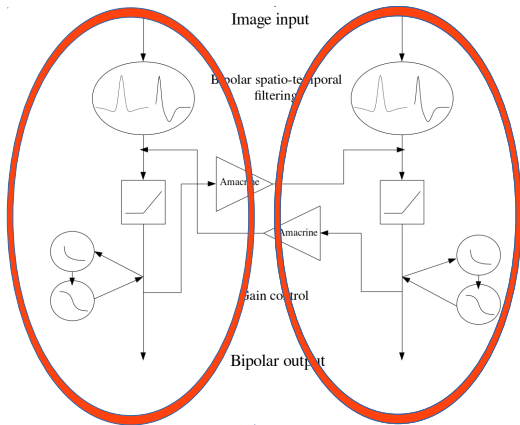

Building a 2D retina model for motion anticipation

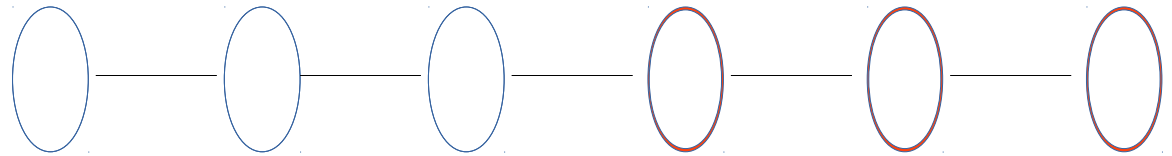
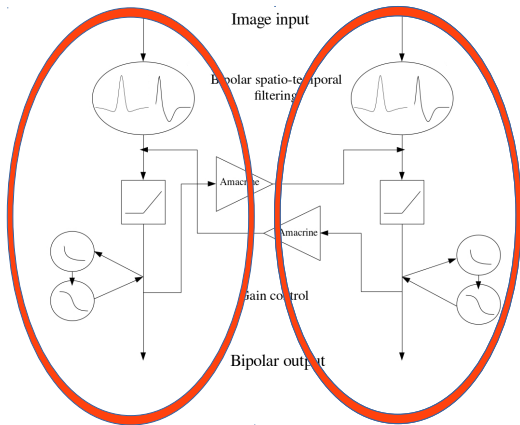

Building a 2D retina model for motion anticipation

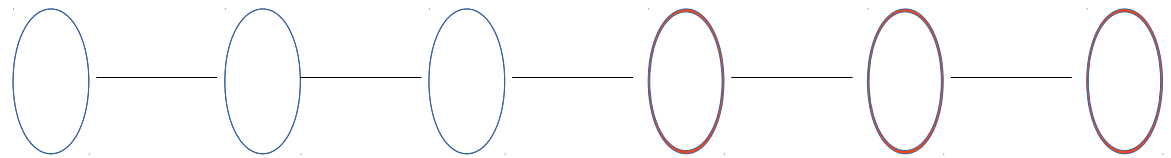
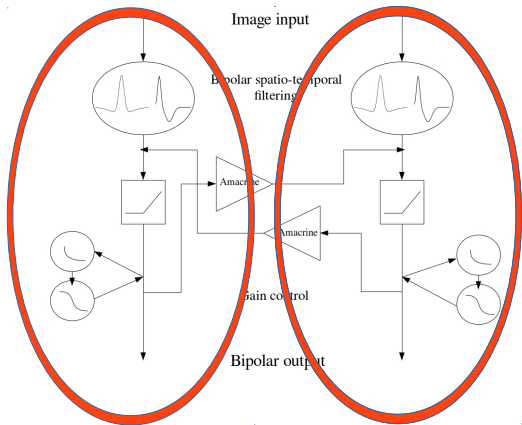

Spatial profiles $w=1$

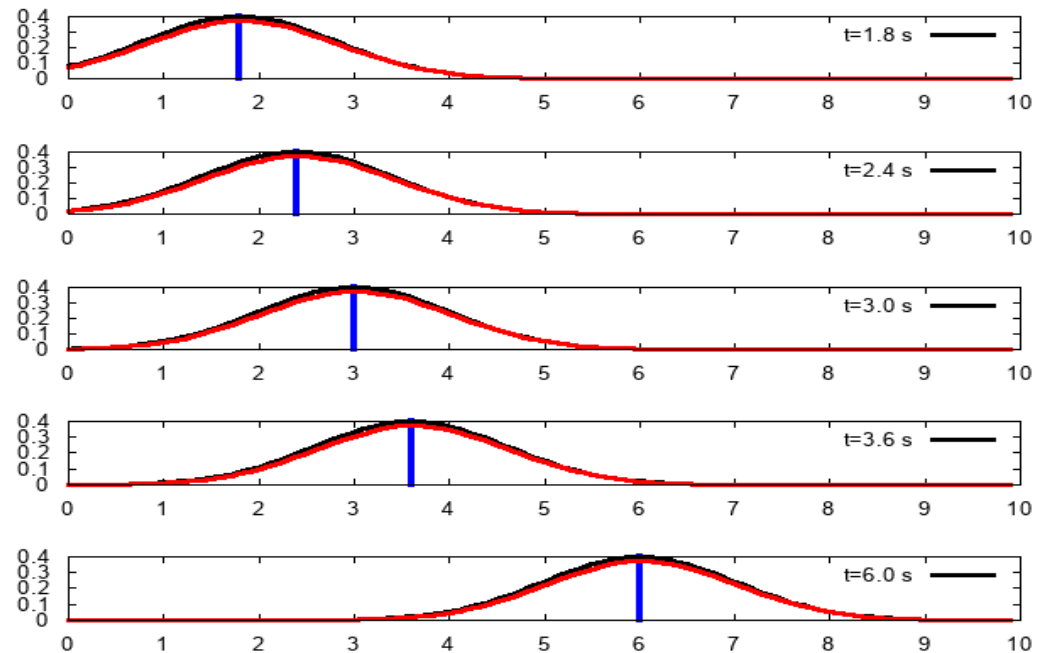

X

Building a 2D retina model for motion anticipation

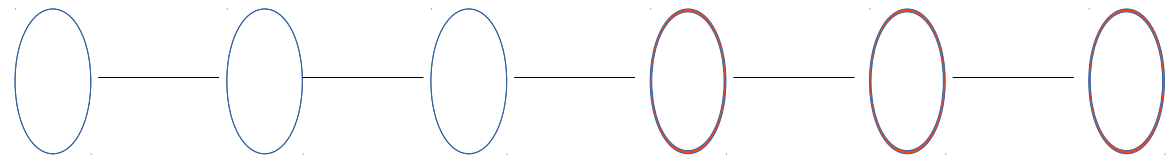
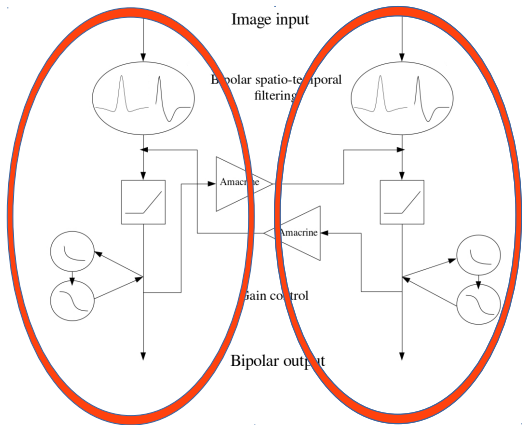

Spatial profiles $w=3$

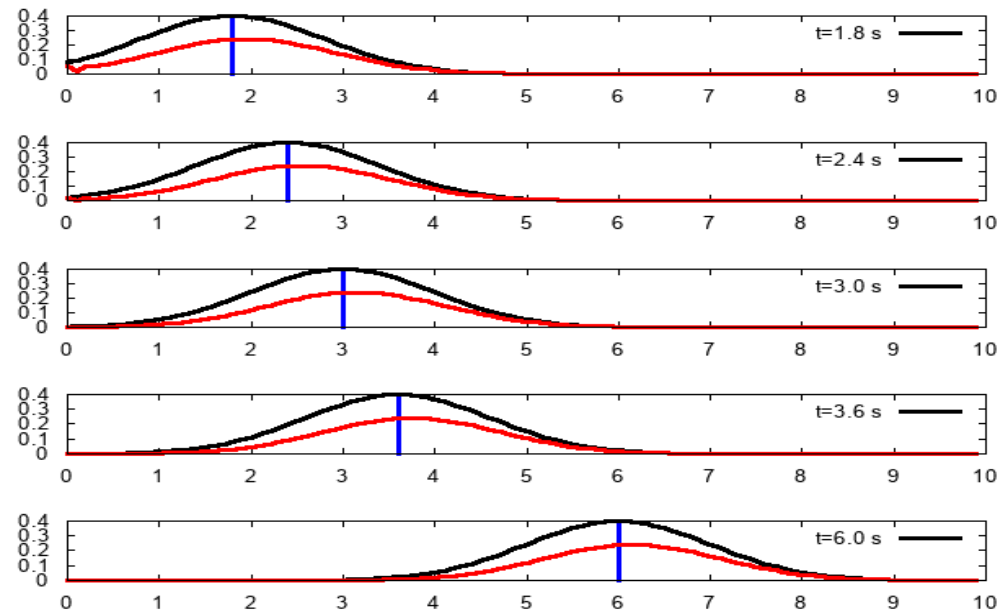

Building a 2D retina model for motion anticipation

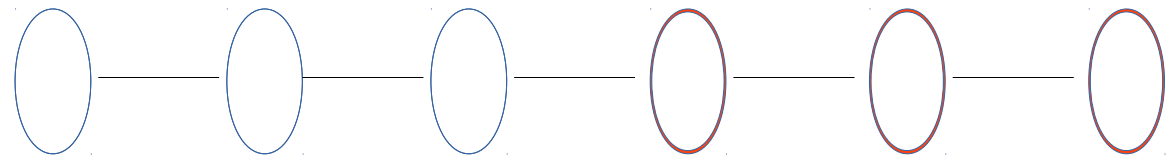
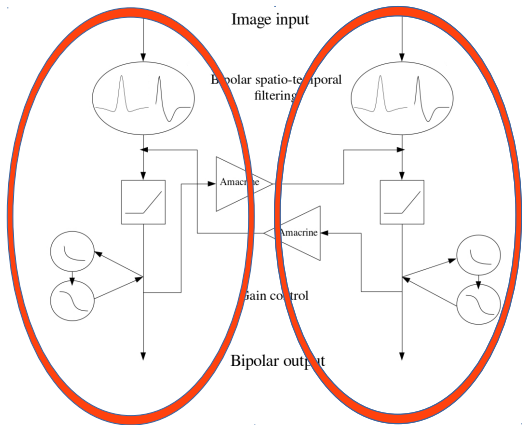

Spatial profiles $w=5$

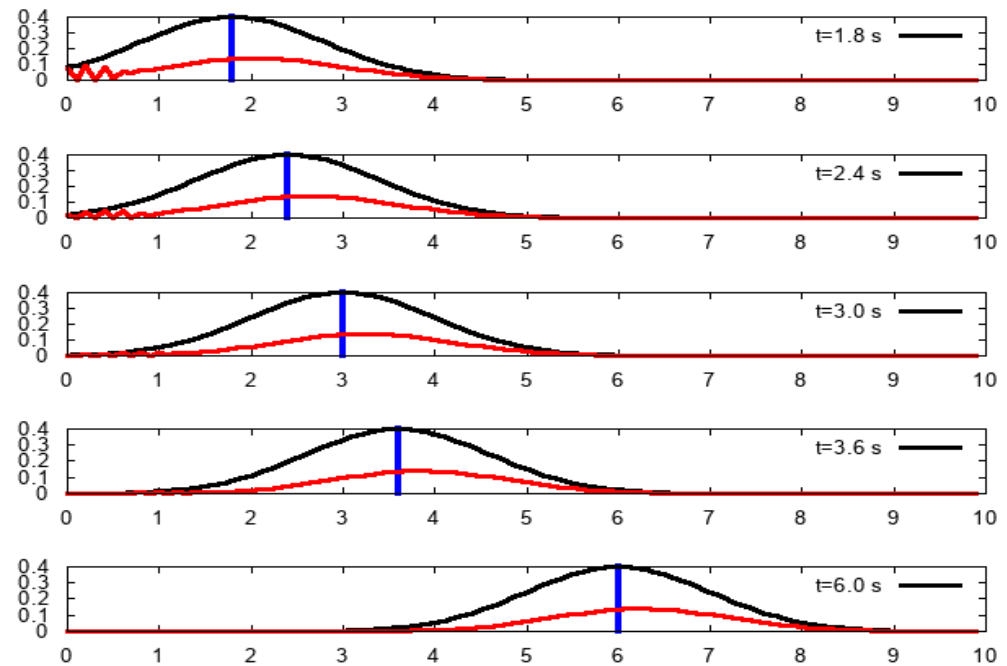

X

Building a 2D retina model for motion anticipation

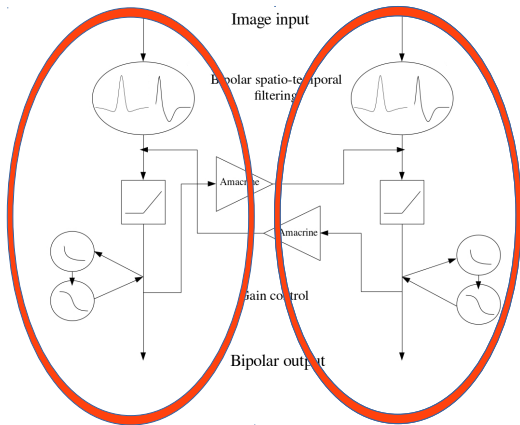

Temporal profile of the middle cell

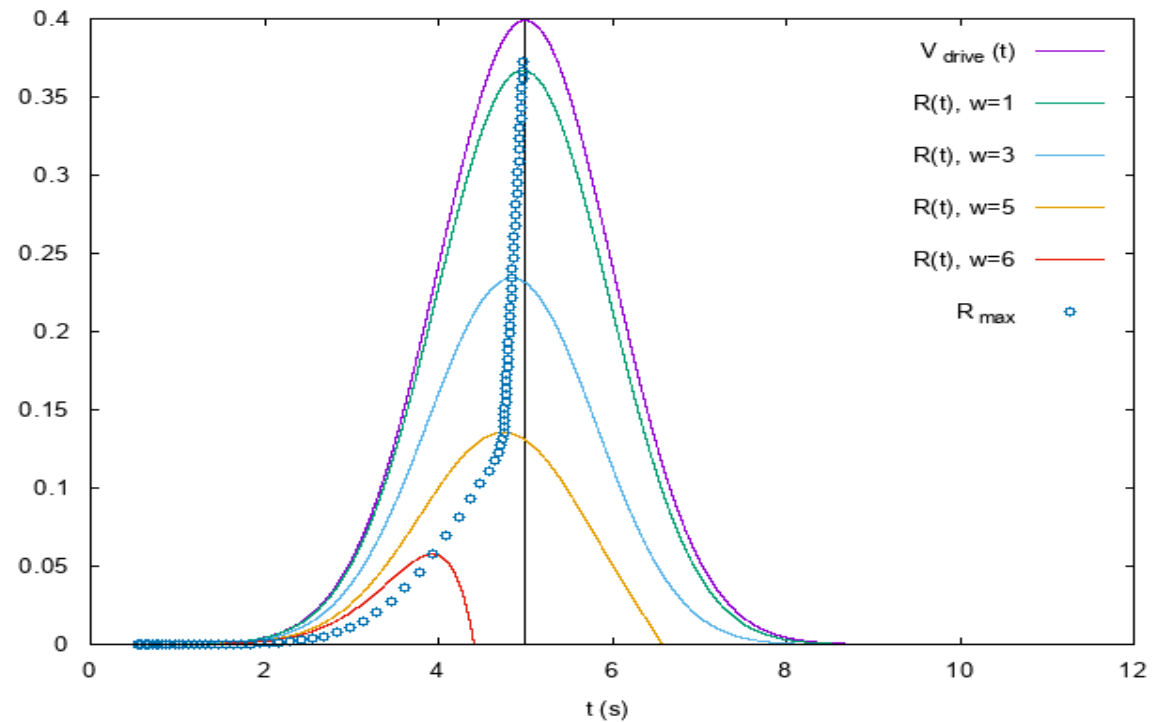

1D results : smooth motion anticipation with amacrine connectivity

Bipolar layer

Ganglion layer

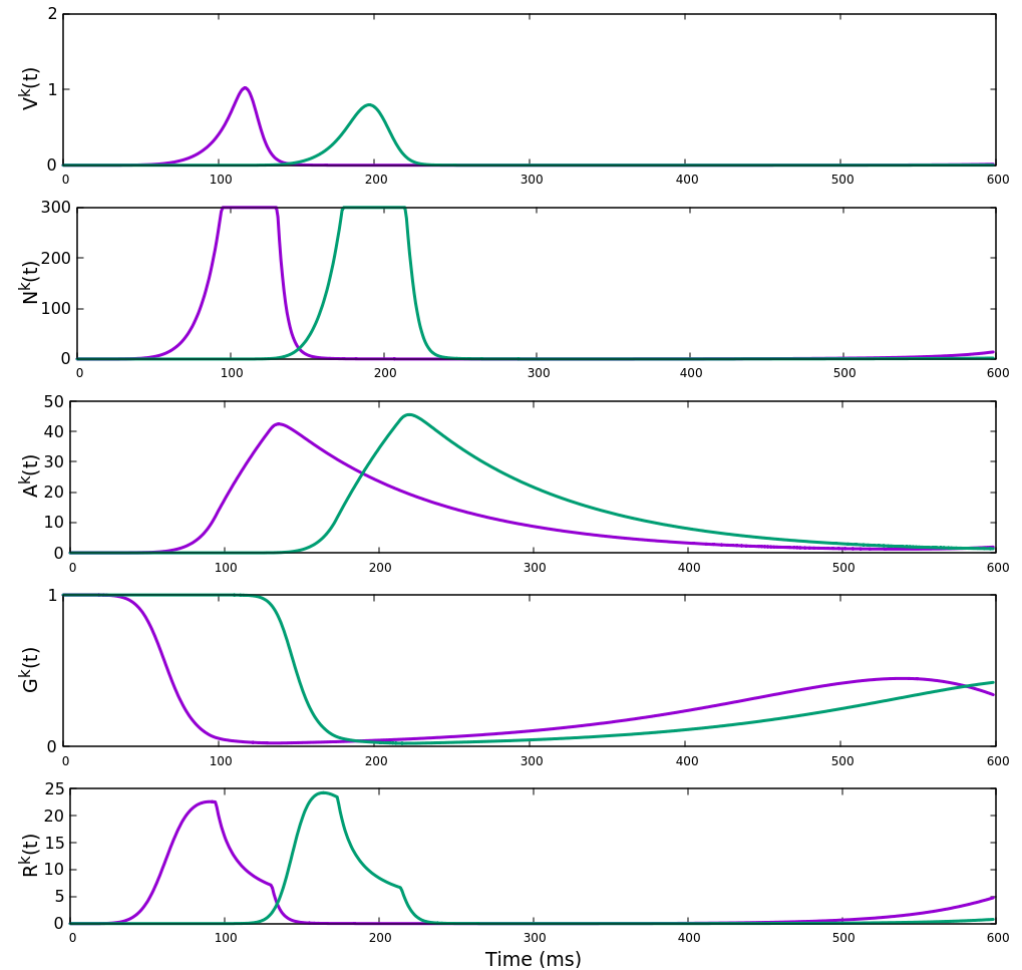
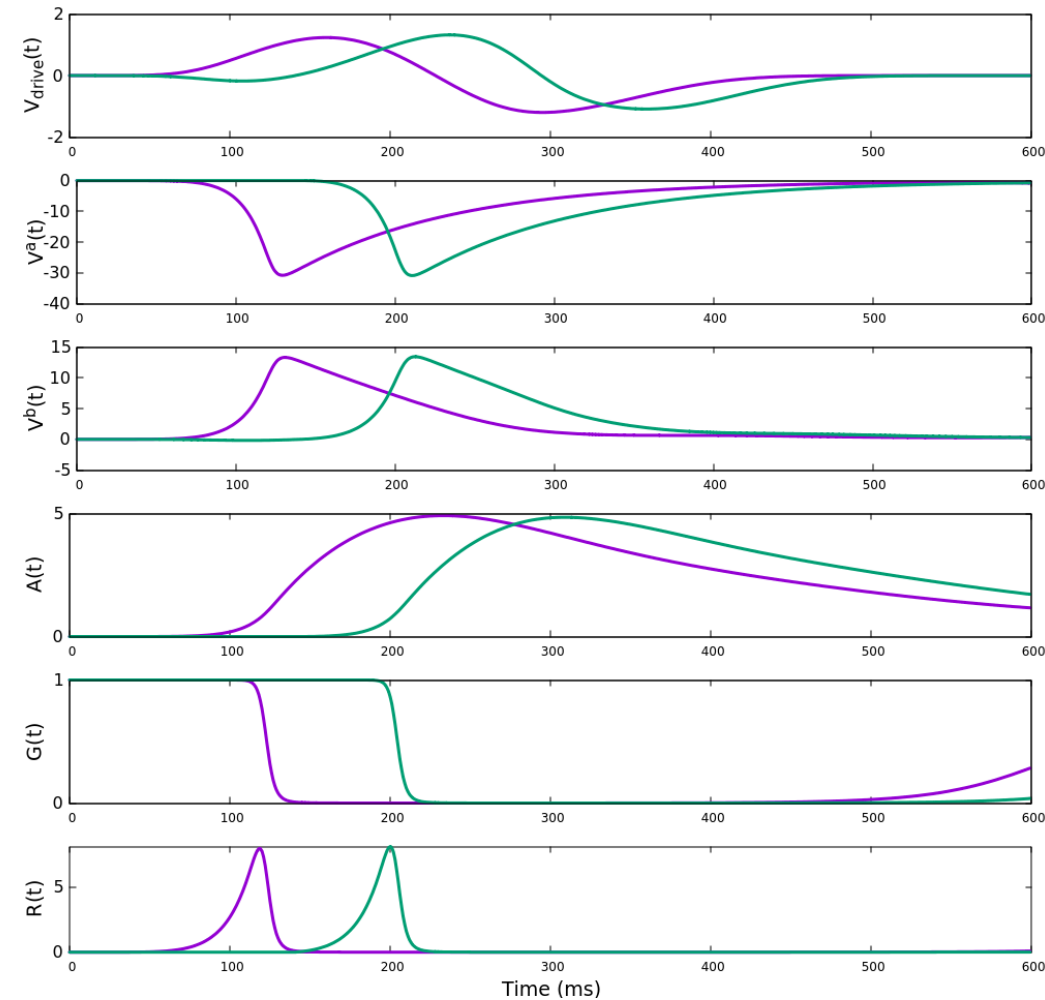

1D results : smooth motion anticipation with amacrine connectivity

Anticipation variability with stimulus
parameters

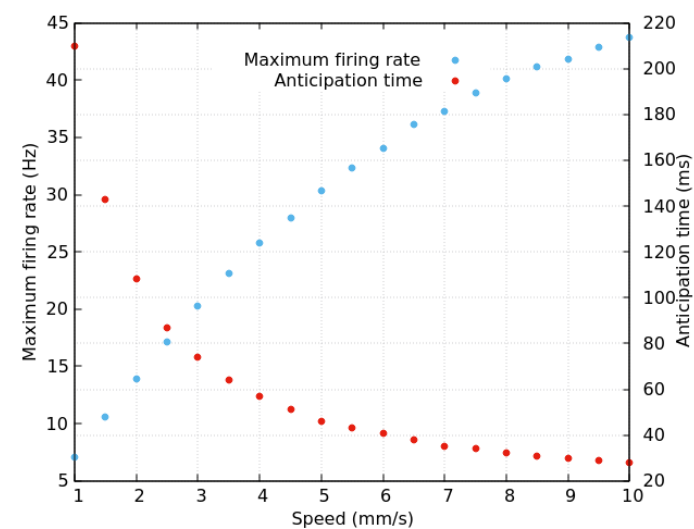
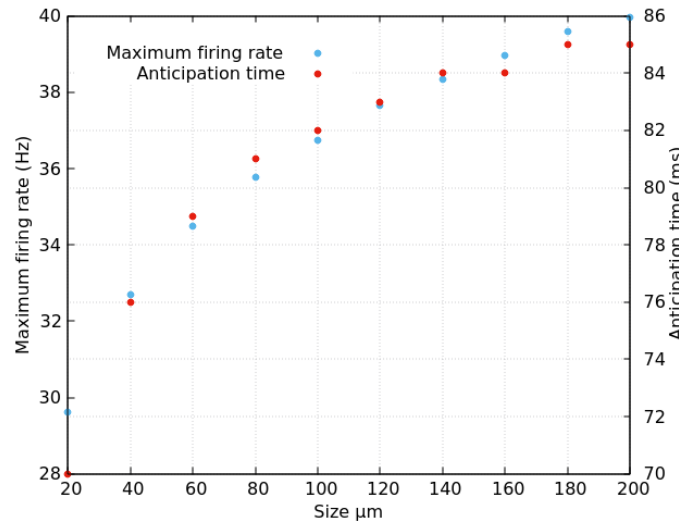
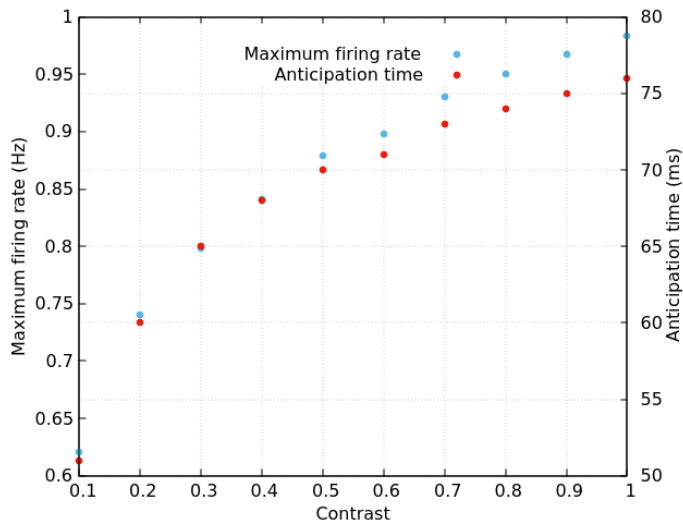

Comparing the performance of the three layers

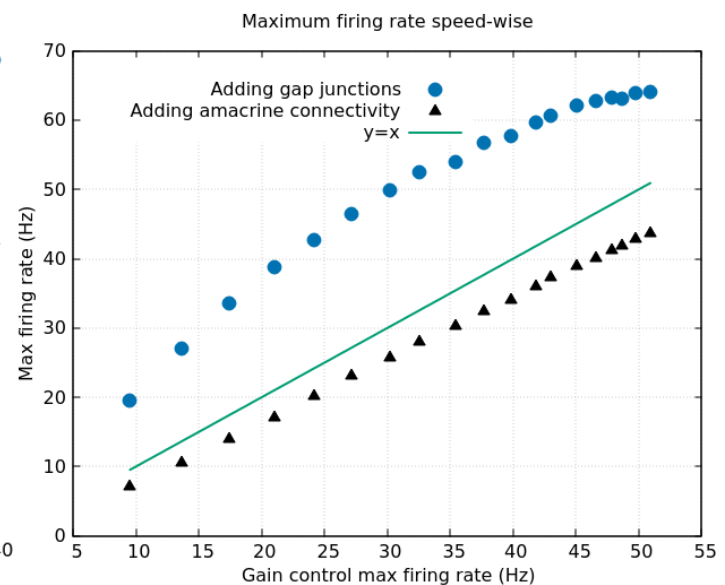
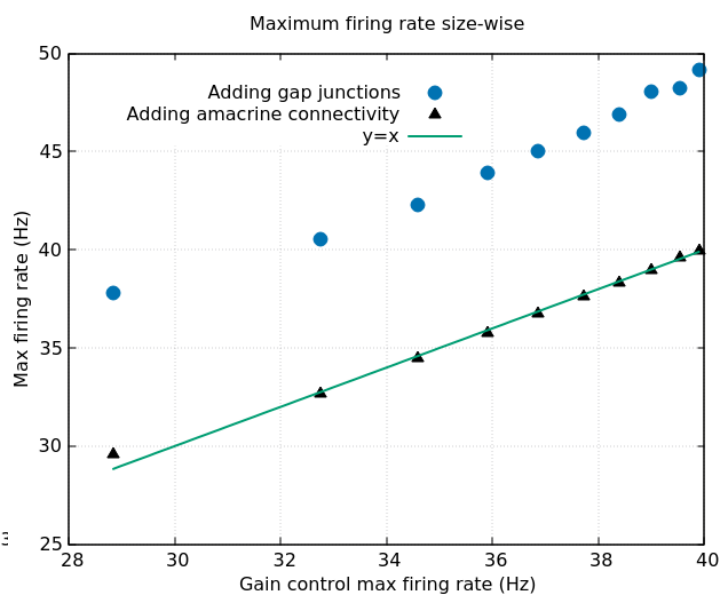
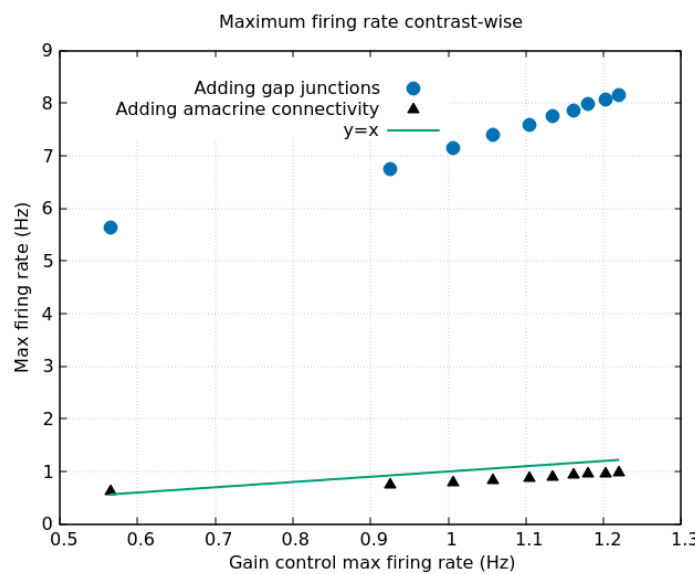
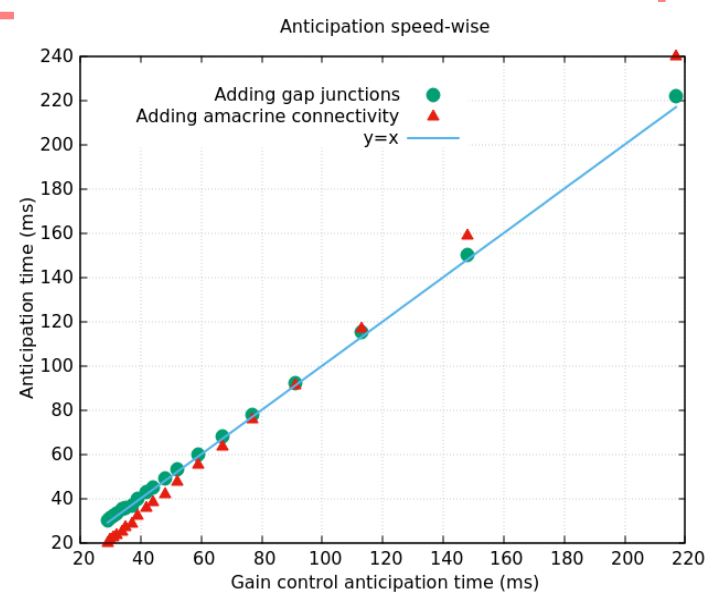
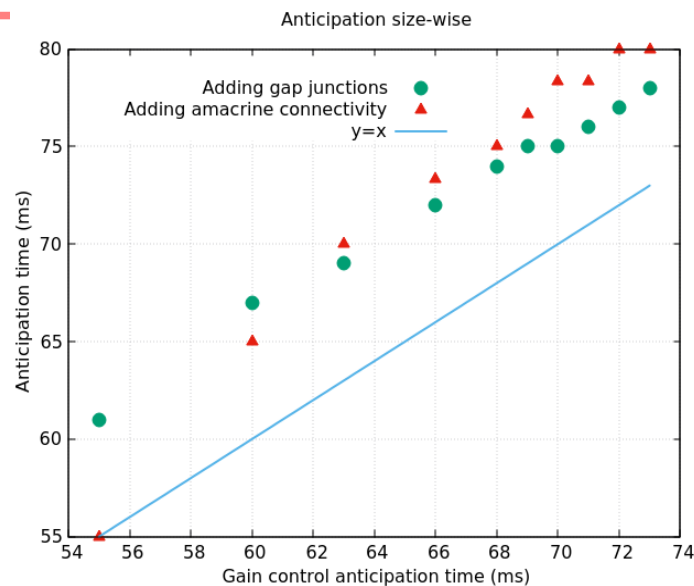
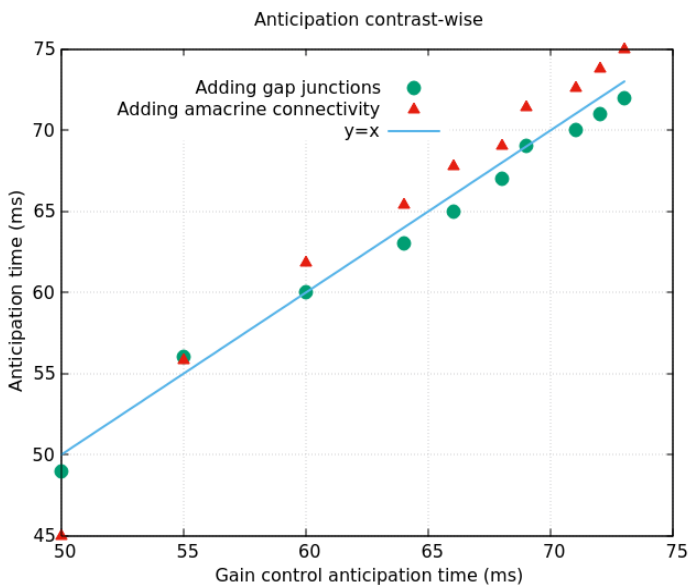

Suggesting new experiments : 2D results

1) Angular anticipation

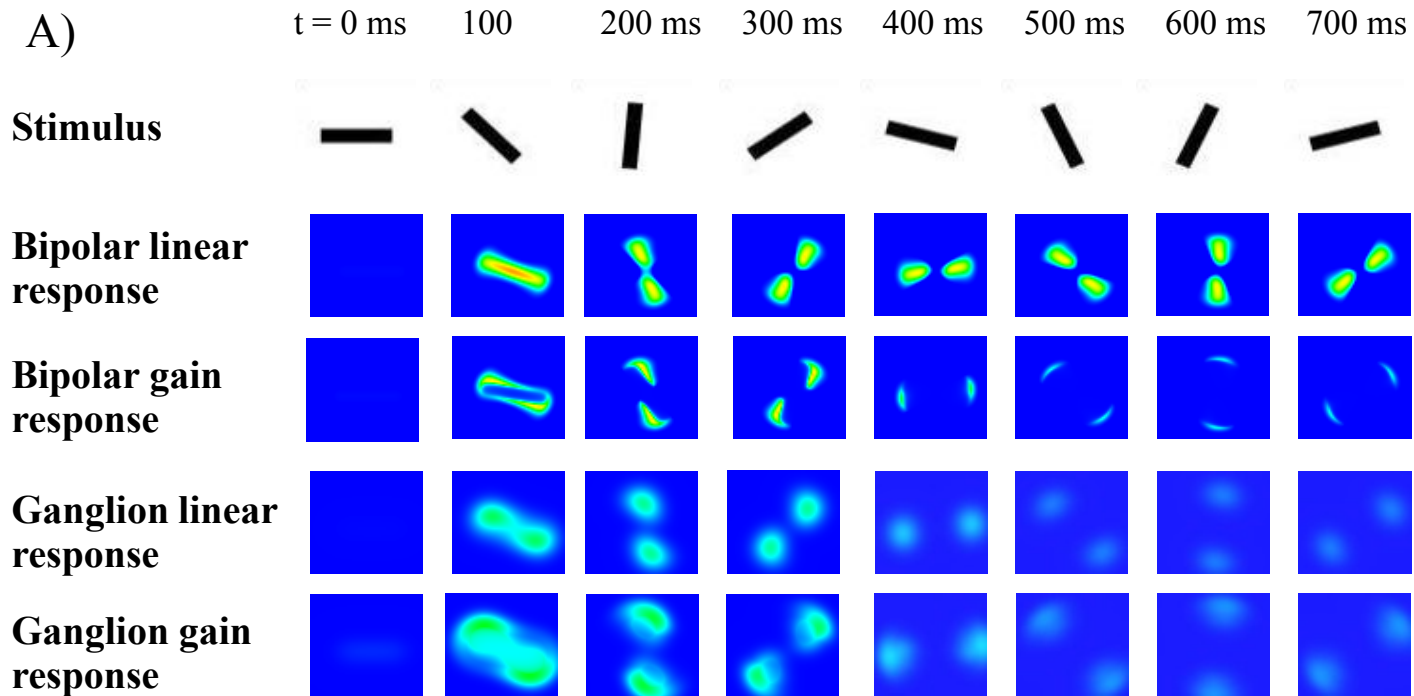

B)

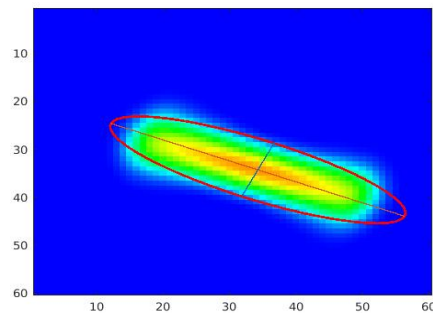

C)

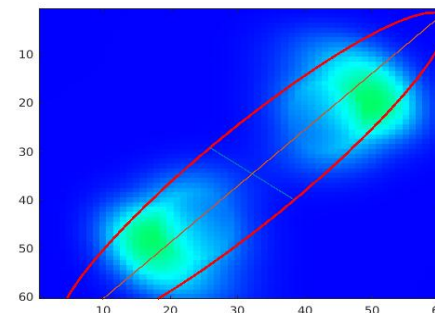

Suggesting new experiments : 2D results

1) Angular anticipation

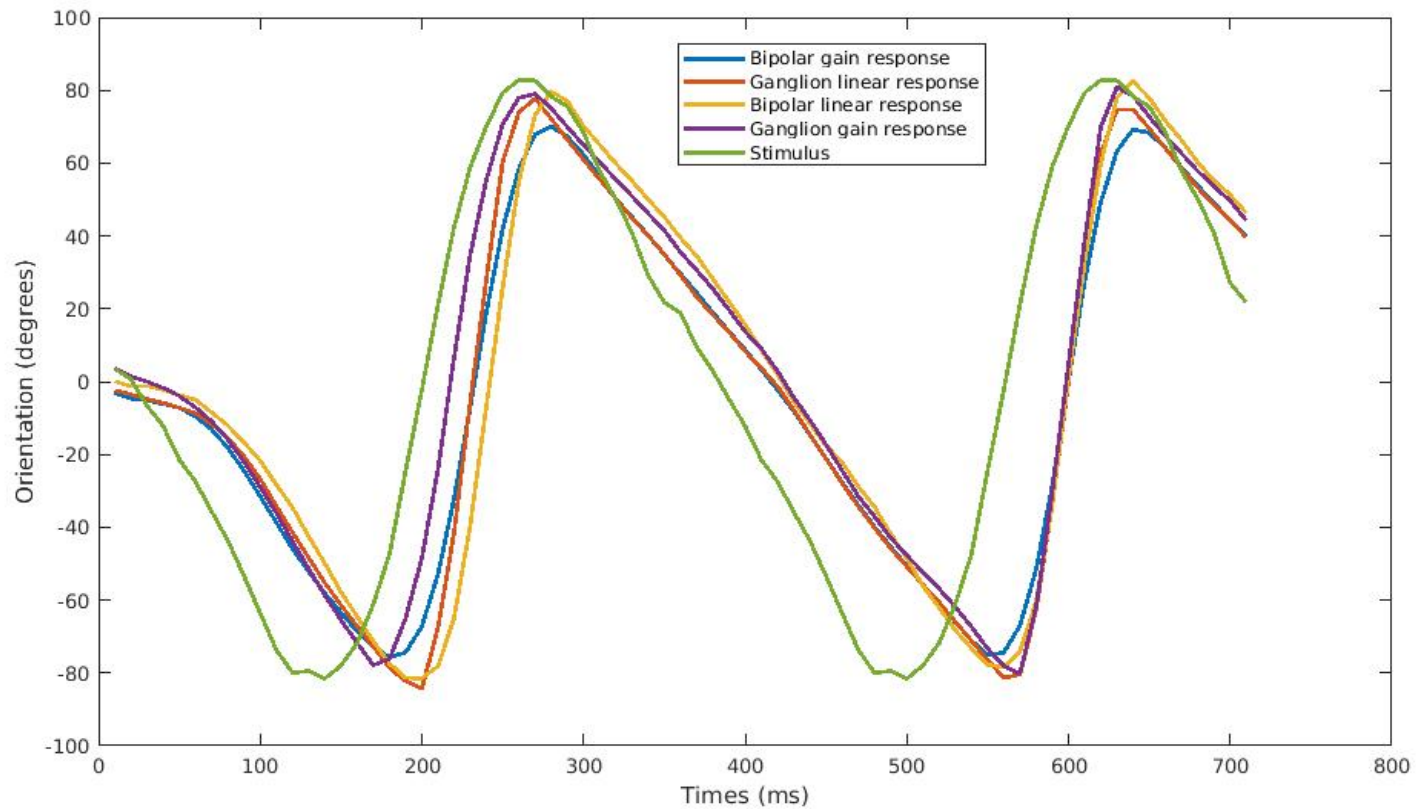

Conclusions

- The retina is able to encode complex visual scene features, fast and reliably, with a very low energy consumption, without spikes, except at the ganglion cells level.

Conclusions

- The retina is able to encode complex visual scene features, fast and reliably, with a very low energy consumption, without spikes, except at the ganglion cells level.
- A large part of the « computation » is made by synapses.

Conclusions

- The retina is able to encode complex visual scene features, fast and reliably, with a very low energy consumption, without spikes, except at the ganglion cells level.
- A large part of the « computation » is made by synapses.
- Starting from the retina architecture one can extract circuits solving « tasks » such as motion anticipation.

Conclusions

- The retina is able to encode complex visual scene features, fast and reliably, with a very low energy consumption, without spikes, except at the ganglion cells level.
- A large part of the « computation » is made by synapses.
- Starting from the retina architecture one can extract circuits solving « tasks » such as motion anticipation.
- The role of gain control and local synaptic balance between excitation-inhibition has been experimentally shown to play a central rôle in anticipation (Berry et al, 1999 ; Chen et al, 2013 ; Johnston-Lagando, 2015).

Conclusions

- The retina is able to encode complex visual scene features, fast and reliably, with a very low energy consumption, without spikes, except at the ganglion cells level.
- A large part of the « computation » is made by synapses.
- Starting from the retina architecture one can extract circuits solving « tasks » such as motion anticipation.
- The role of gain control and local synaptic balance between excitation-inhibition has been experimentally shown to play a central rôle in anticipation (Berry et al, 1999 ; Chen et al, 2013 ; Johnston-Lagando, 2015).
- Here we propose that lateral connectivity also plays a role in motion anticipation where a wave of activity propagates ahead of the motion.

Conclusions

- The retina is able to encode complex visual scene features, fast and reliably, with a very low energy consumption, without spikes, except at the ganglion cells level.
- A large part of the « computation » is made by synapses.
- Starting from the retina architecture one can extract circuits solving « tasks » such as motion anticipation.
- The role of gain control and local synaptic balance between excitation-inhibition has been experimentally shown to play a central rôle in anticipation (Berry et al, 1999 ; Chen et al, 2013 ; Johnston-Lagando, 2015).
- Here we propose that lateral connectivity also plays a role in motion anticipation where a wave of activity propagates ahead of the motion.
- Useful paradigms for :
 - 1) Computer vision ?
 - 2) Retinal prostheses ?

Anticipation in V1

Anticipation in V1

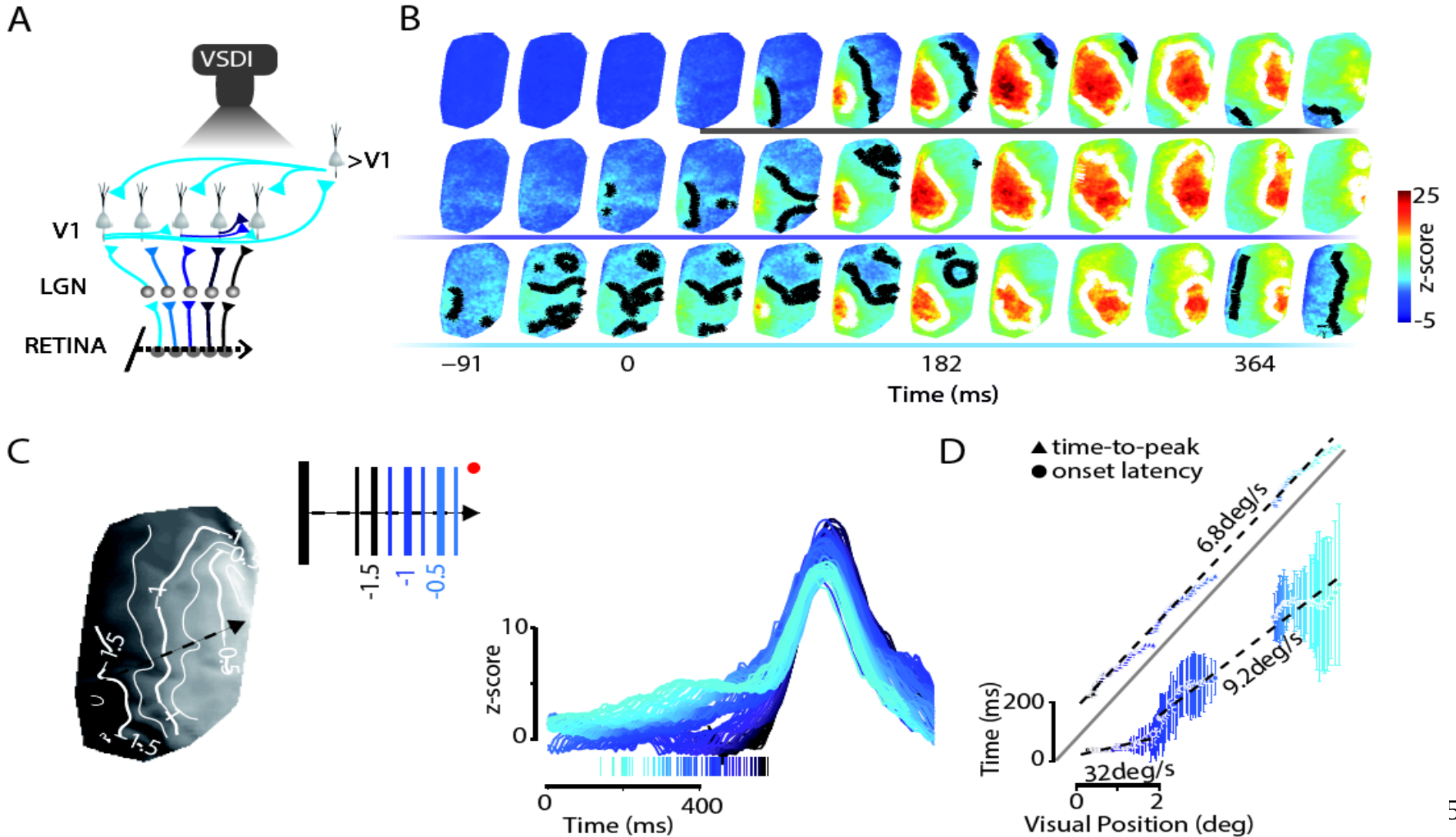

A mean field model to reproduce VSDI recordings

Zerlaut et al 2016
Chemla et al 2018

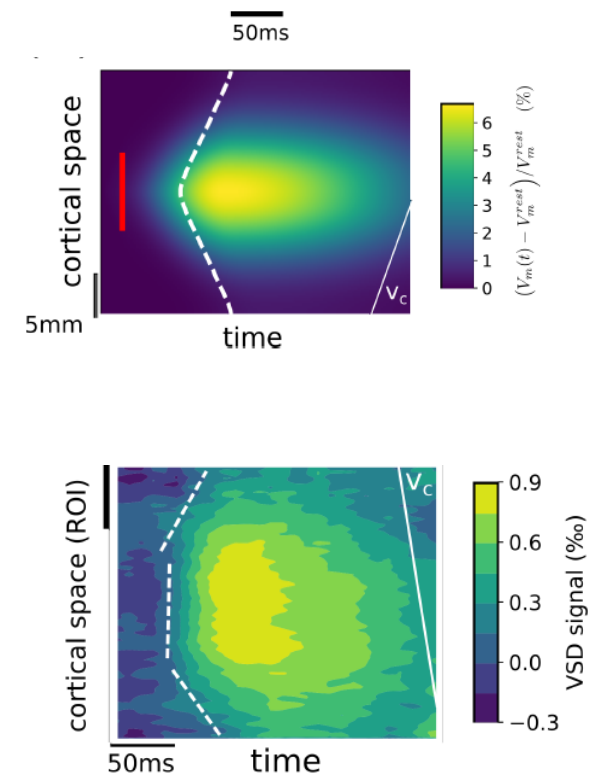
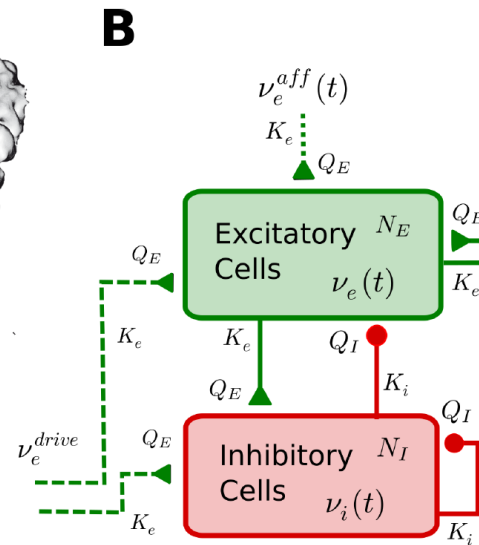
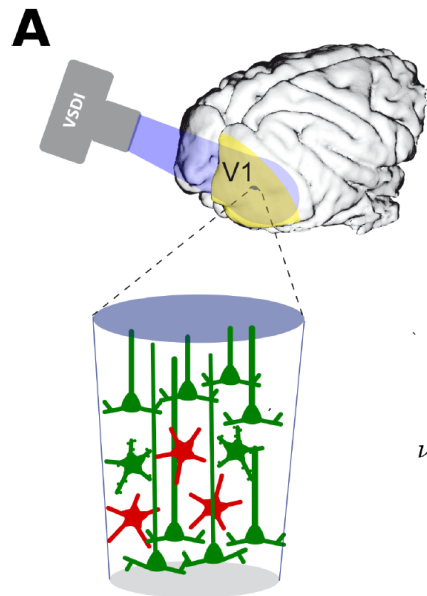

A mean field model to reproduce VSDI recordings

Zerlaut et al 2016
Chemla et al 2018

Master equation for first and second moments local population dynamics (El Boustani and Destexhe, 2009) read :

$$\left\{ \begin{array}{l} T \frac{\partial \nu_\mu}{\partial t} = (\mathcal{F}_\mu - \nu_\mu) + \frac{1}{2} c_{\lambda\eta} \frac{\partial^2 \mathcal{F}_\mu}{\partial \nu_\lambda \partial \nu_\eta} \\ T \frac{\partial c_{\lambda\eta}}{\partial t} = A_{\lambda\eta} + (\mathcal{F}_\lambda - \nu_\lambda) (\mathcal{F}_\eta - \nu_\eta) + \\ \quad c_{\lambda\mu} \frac{\partial \mathcal{F}_\mu}{\partial \nu_\lambda} + c_{\mu\eta} \frac{\partial \mathcal{F}_\mu}{\partial \nu_\eta} - 2c_{\lambda\eta} \end{array} \right. \longrightarrow T \frac{\partial \nu_\mu}{\partial t} = \mathcal{F}_\mu - \nu_\mu$$

$$A_{\lambda\eta} = \begin{cases} \frac{\mathcal{F}_\lambda (1/T - \mathcal{F}_\lambda)}{N_\lambda} & \text{if } \lambda = \eta \\ 0 & \text{otherwise} \end{cases}$$

A mean field model to reproduce VSDI recordings

Zerlaut et al 2016
Chemla et al 2018

Master equation for first and second moments local population dynamics (El Boustani and Destexhe, 2009) read :

$$\begin{cases} T \frac{\partial \nu_\mu}{\partial t} = (\mathcal{F}_\mu - \nu_\mu) + \frac{1}{2} c_{\lambda\eta} \frac{\partial^2 \mathcal{F}_\mu}{\partial \nu_\lambda \partial \nu_\eta} \\ T \frac{\partial c_{\lambda\eta}}{\partial t} = c_{\lambda\eta} + (\mathcal{F}_\lambda - \nu_\lambda)(\mathcal{F}_\eta - \nu_\eta) + \\ \quad c_{\lambda\mu} \frac{\partial \mathcal{F}_\mu}{\partial \nu_\lambda} + c_{\mu\eta} \frac{\partial \mathcal{F}_\mu}{\partial \nu_\eta} - 2c_{\lambda\eta} \end{cases} \rightarrow T \frac{\partial \nu_\mu}{\partial t} = \mathcal{F}_\mu - \nu_\mu$$

$$A_{\lambda\eta} = \begin{cases} \frac{\mathcal{F}_\lambda (1/T - \mathcal{F}_\lambda)}{N_\lambda} & \text{if } \lambda = \eta \\ 0 & \text{otherwise} \end{cases}$$

Affords a retino thalamic input

A mean field model to reproduce VSDI recordings

Zerlaut et al 2016
Chemla et al 2018

Single neuron model (The adaptative exponential integrate and fire model Brette and Gerstner, 2005)

$$\begin{cases} C_m \frac{dV}{dt} = g_L (E_L - V) + I_{syn}(V, t) + k_a e^{\frac{V - V_{thre}}{k_a}} - I_w \\ \tau_w \frac{dI_w}{dt} = -I_w + a \cdot (V - E_L) + \sum_{t_s \in \{t_{spike}\}} b \delta(t - t_s) \end{cases}$$

The conductance-based exponential synapse

$$I_{syn}(V, t) = \sum_{s \in \{e, i\}} \sum_{t_s \in \{t_s\}} Q_s (E_s - V) e^{-\frac{t-t_s}{\tau_s}} \mathcal{H}(t - t_s)$$

Semi analytical transfer function :

$$\nu_{out} = \mathcal{F}(\nu_e, \nu_i) = \frac{1}{2\tau_V} \cdot \text{Erfc}\left(\frac{V_{thre}^{eff} - \mu_V}{\sqrt{2}\sigma_V}\right) \quad \text{with} \quad V_{thre}^{eff}(\mu_V, \sigma_V, \tau_V^N) = P_0 + \sum_{x \in \{\mu_V, \sigma_V, \tau_V^N\}} P_x \cdot \left(\frac{x - x^0}{\delta x^0}\right) + P_{\mu_G} \log\left(\frac{\mu_G}{g_L}\right) + \sum_{x, y \in \{\mu_V, \sigma_V, \tau_V^N\}^2} P_{xy} \cdot \left(\frac{x - x^0}{\delta x^0}\right) \left(\frac{y - y^0}{\delta y^0}\right)$$

A mean field model to reproduce VSDI recordings

Zerlaut et al 2016
Chemla et al 2018

The mean, standard deviation and auto-correlation time of the excitatory and inhibitory conductance read :

$$\begin{array}{l}
 \mu_{G_e}(\nu_e, \nu_i) = \nu_e K_e \tau_e Q_e \\
 \sigma_{G_e}(\nu_e, \nu_i) = \sqrt{\frac{\nu_e K_e \tau_e}{2}} Q_e \\
 \mu_{G_i}(\nu_e, \nu_i) = \nu_i K_i \tau_i Q_i \\
 \sigma_{G_i}(\nu_e, \nu_i) = \sqrt{\frac{\nu_i K_i \tau_i}{2}} Q_i
 \end{array}
 \longrightarrow
 \begin{array}{l}
 \mu_G(\nu_e, \nu_i) = \mu_{G_e} + \mu_{G_i} + g_L \\
 \tau_m(\nu_e, \nu_i) = \frac{C_m}{\mu_G} \\
 \downarrow \\
 \mu_V(\nu_e, \nu_i) = \frac{\mu_{G_e} E_e + \mu_{G_i} E_i + g_L E_L}{\mu_G} \\
 \sigma_V(\nu_e, \nu_i) = \sqrt{\sum_s K_s \nu_s \frac{(U_s \cdot \tau_s)^2}{2(\tau_m^{\text{eff}} + \tau_s)}} \\
 \tau_V(\nu_e, \nu_i) = \left(\frac{\sum_s (K_s \nu_s (U_s \cdot \tau_s)^2)}{\sum_s (K_s \nu_s (U_s \cdot \tau_s)^2 / (\tau_m^{\text{eff}} + \tau_s))} \right)
 \end{array}$$

Finally, the transfer function reads :

$$\nu_{out} = \mathcal{F}(\nu_e, \nu_i) = \frac{1}{2\tau_V} \cdot \text{Erfc}\left(\frac{V_{thre}^{eff} - \mu_V}{\sqrt{2}\sigma_V}\right)$$

A mean field model to reproduce VSDI recordings

Zerlaut et al 2016
Chemla et al 2018

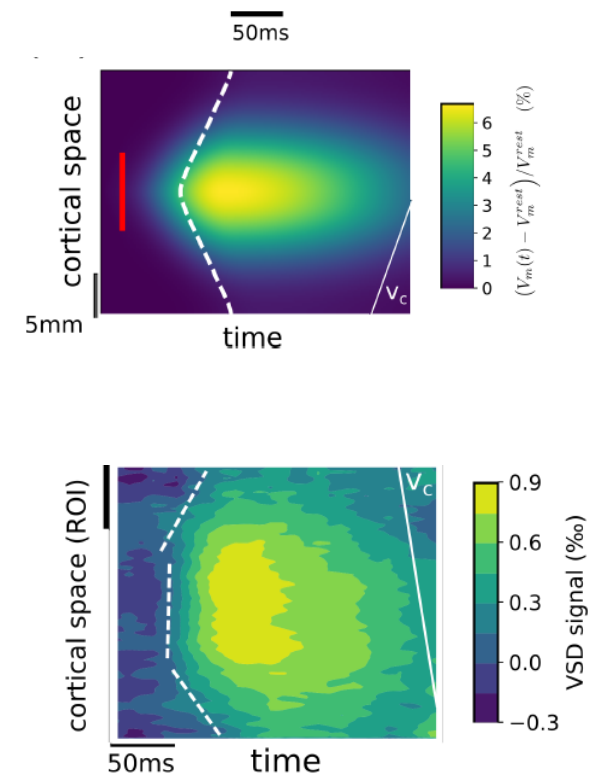
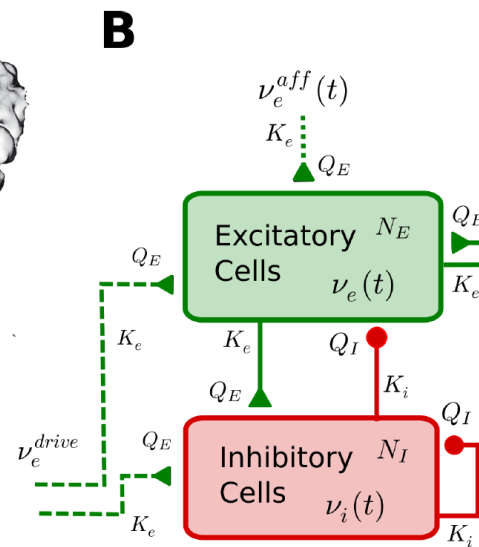
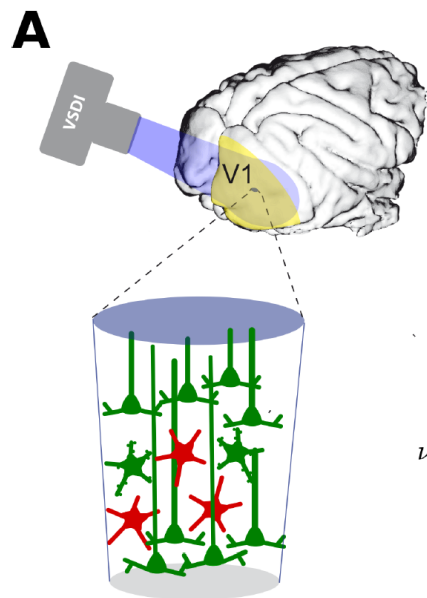

Response of the cortical model to a LN retina drive

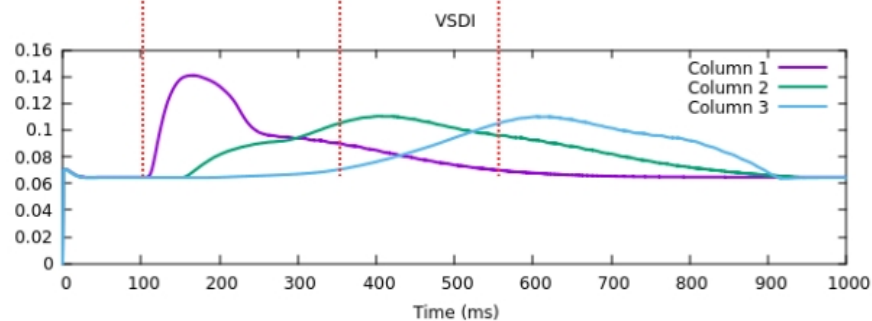
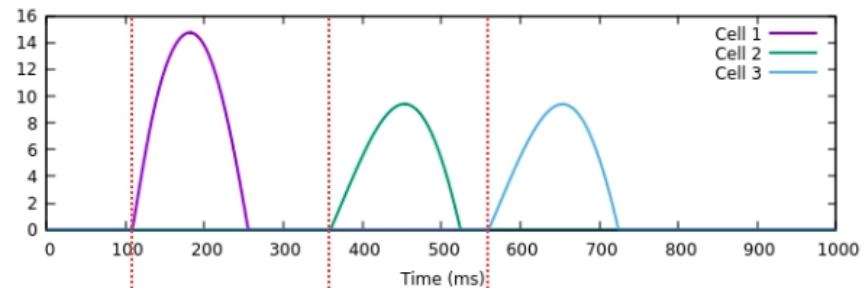
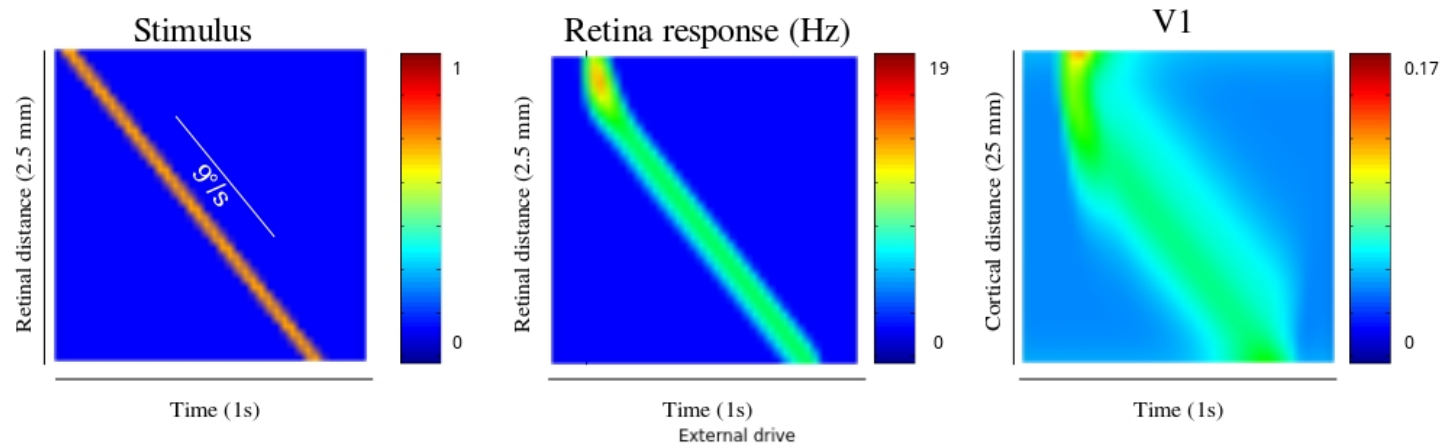

Response of the cortical model to a retina drive with gain control

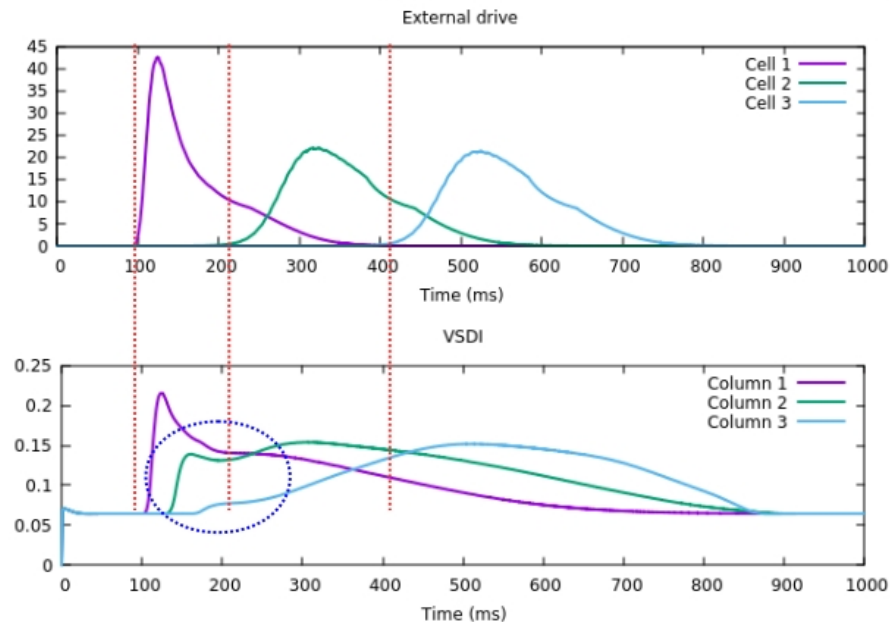
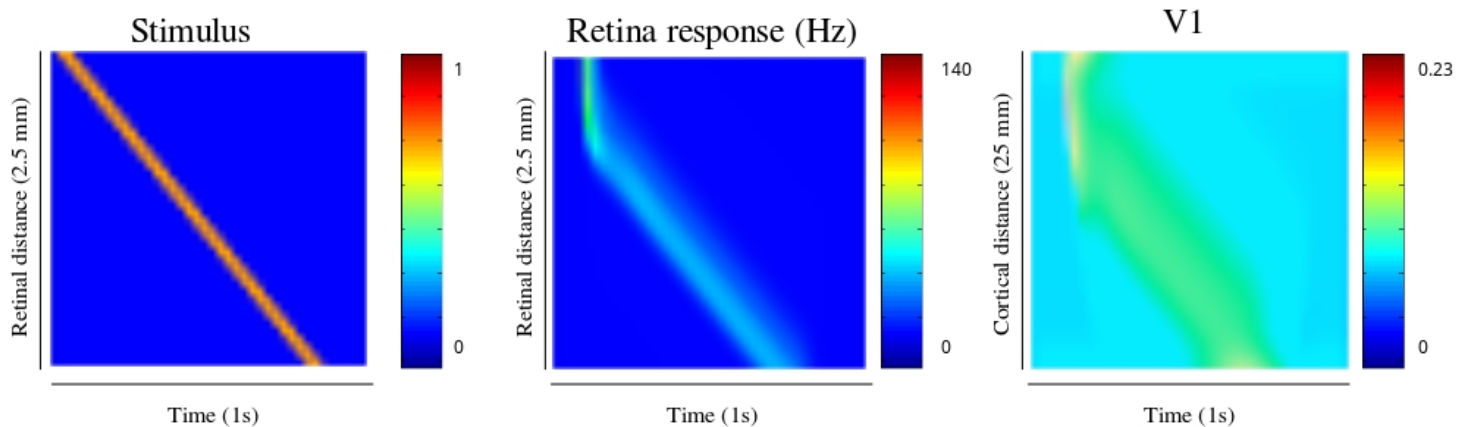

Anticipation in the cortex : VSDI data analysis

(Data courtesy of F. Chavane et S. Chemla)

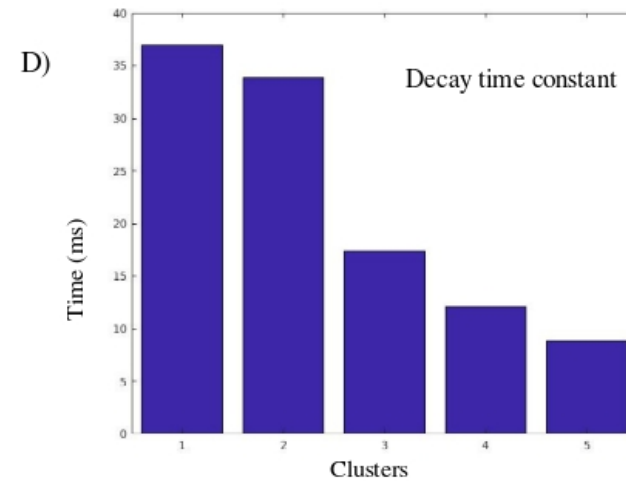
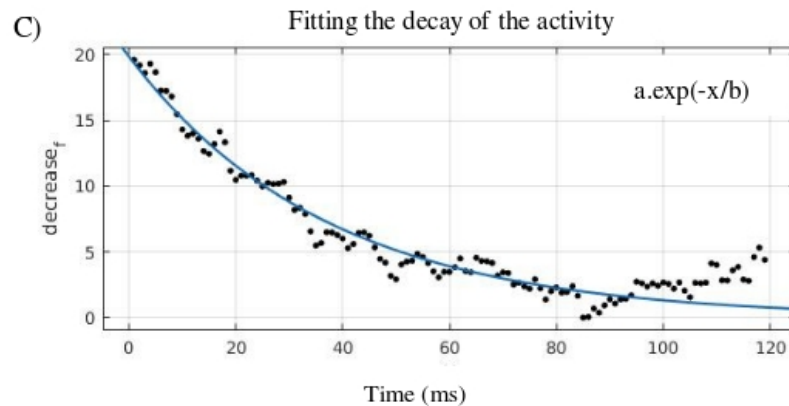
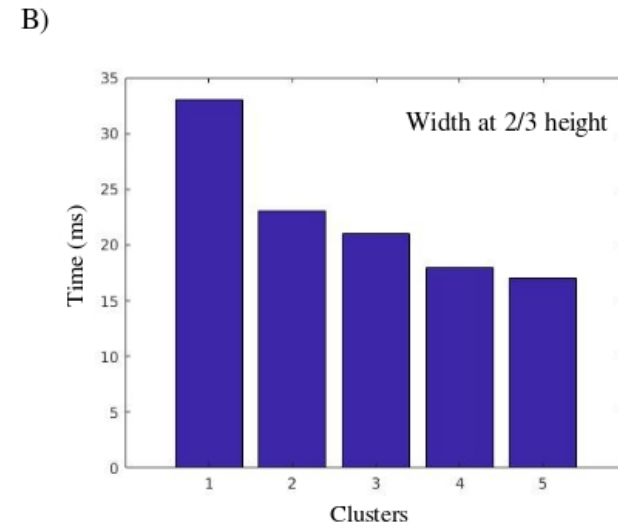
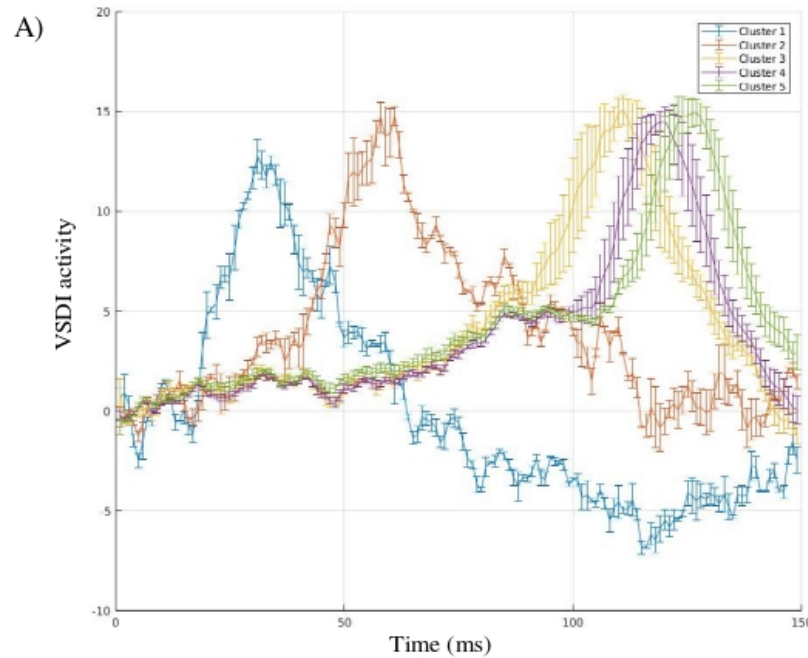

Comparing simulation results to VSDI recordings

Cortex experimental recordings

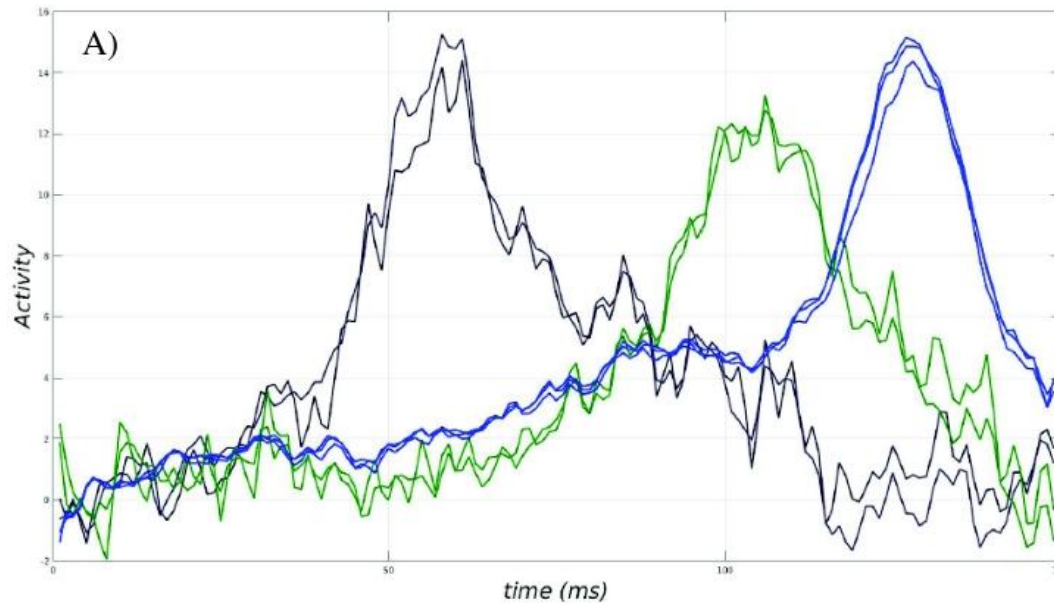

Simulation results
Response to an LN
model of the retina

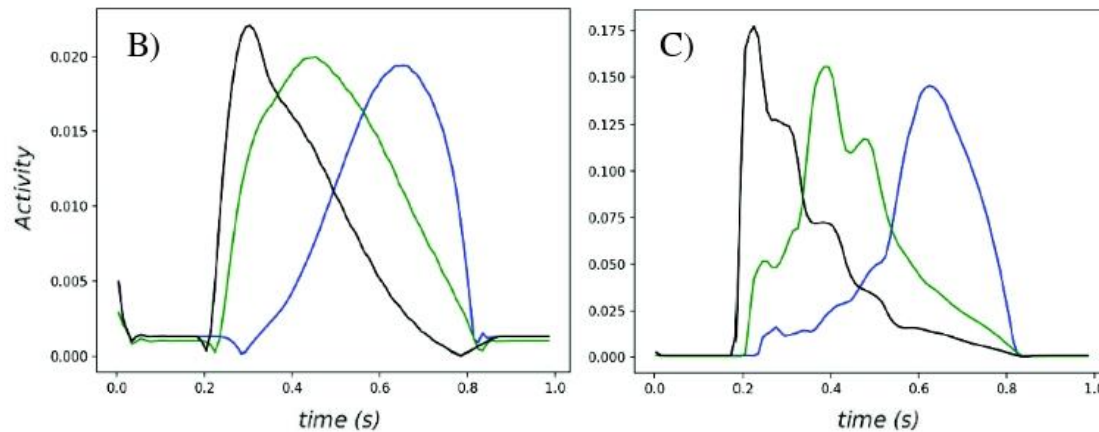

Simulation results
Response to a gain
control model of the
retina

Conclusions

- We developed a 2D retina with three ganglion cell layers, implementing gain control and connectivity.
- We use the output of our model as an input to a mean field model of V1, and were able to reproduce anticipation as observed in VSDI

Conclusions

- How to improve object identification
 - 1) exploring the model's parameters and
 - 2) using connectivity ?
- Is our model able to anticipate more complex trajectories, with accelerations for instance ?
- How to calibrate connectivity using biology ?
- How does anticipation affect higher order correlations ?
- Would it be possible to design psycho-physical tests clearly showing the role of the retina in visual anticipation ?

Thank you for your attention !