



HAL
open science

Cooperation between multiple RPL networks

Brandon Foubert

► **To cite this version:**

Brandon Foubert. Cooperation between multiple RPL networks. Networking and Internet Architecture [cs.NI]. 2018. hal-02307955

HAL Id: hal-02307955

<https://inria.hal.science/hal-02307955>

Submitted on 8 Oct 2019

HAL is a multi-disciplinary open access archive for the deposit and dissemination of scientific research documents, whether they are published or not. The documents may come from teaching and research institutions in France or abroad, or from public or private research centers.

L'archive ouverte pluridisciplinaire **HAL**, est destinée au dépôt et à la diffusion de documents scientifiques de niveau recherche, publiés ou non, émanant des établissements d'enseignement et de recherche français ou étrangers, des laboratoires publics ou privés.

UFR de mathématique et d'informatique

Université de Strasbourg

MASTER OF SCIENCE IN COMPUTER SCIENCE
COMPUTER NETWORKS AND EMBEDDED SYSTEMS

Master's thesis presented by

Brandon FOUBERT

brandon.foubert@etu.unistra.fr

COOPERATION BETWEEN MULTIPLE RPL NETWORKS

Internship supervised by

Julien MONTAVONT

montavont@unistra.fr

In the

ICUBE LABORATORY



TABLE OF CONTENTS

Table of Contents	iii
Introduction	iv
1 Hosting structure	1
1.1 The ICube laboratory	1
1.2 The computer science research department	1
1.3 The network research group	1
1.4 My assignment	2
2 Scientific context	3
2.1 The internet of things	3
2.1.1 IoT constraints	3
2.1.2 IoT network layer	4
2.2 Routing protocols	5
2.2.1 Distance-vector and link-state protocols	5
2.2.2 Proactive and reactive protocols	6
2.2.3 Hop-by-hop and source routing protocols	6
2.2.4 Routing in the IoT	6
2.3 IPv6 Routing Protocol for LLNs: RPL	7
2.3.1 Basic operations	7
2.3.2 Point-to-multipoint and point-to-point traffic support	9
2.3.3 Objective function	9
2.3.4 Advanced features	10
2.3.5 Instances	10
2.4 Problem statement	11
2.4.1 Border router failure	11
2.4.2 Funneling effect	11
3 State of the Art	13
3.1 Border router redundancy	13
3.2 Multiple sinks	13
3.2.1 Virtual DODAG root	14
3.3 Load balancing	15
4 Contribution: RPL-NAT-LB	16
4.1 Considered IoT scenario	16
4.2 Multiple border routers	16
4.2.1 Motivations	16

4.2.2	Virtual DODAG root	17
4.3	Multiple IPv6 prefixes	17
4.3.1	Motivations	17
4.3.2	Network address translation	18
4.4	Load balancing	19
4.4.1	Motivations	19
4.4.2	Prerequisites	20
4.4.3	Explicit redirection	20
5	Experimentation	22
5.1	Implementation	22
5.1.1	Contiki OS	22
5.1.2	Cooja	22
5.1.3	Implementation cost	22
5.2	Experiment setup	23
5.2.1	FIT/IoT-LAB	23
5.2.2	Experimental parameters	23
5.2.3	Network layout and scenario	24
5.3	Results	25
5.3.1	Obtained topology	26
5.3.2	Considered metrics	26
5.3.3	End-to-end packet error rate per node	27
5.3.4	MAC packet error rate per node	27
5.3.5	MAC errors repartition	29
5.3.6	Bandwidth repartition	30
5.3.7	Battery capacity decrease	31
5.3.8	Total transmission of control messages	32
6	Conclusion	35
6.1	Contribution	35
6.2	Discussion	36
6.3	Perspectives	36
6.4	Personal review	36
	Bibliography	37

The idea of the Internet of Things (IoT) is to connect multiple objects with wireless communication capabilities so those can share information across the Internet. Those objects face many constraints such as reduced storage memory, limited computation power and scarce energy. Due to those constraints, a dedicated computer networking protocol suite is needed. Those protocols must stay efficient even under unfriendly environment conditions such as bad link quality or interference. The Institute of Electrical and Electronics Engineers (IEEE) and Internet Engineering Task Force (IETF) organisms proposed a new network stack composed of new protocols specialized for IoT devices. Especially, the proposed protocol for the network layer is the IPv6 protocol, because it offers connectivity with many other devices as well as excellent scalability. While native IPv6 can be used in IoT networks, it is inefficient as it is, and protocols modifications are required in order to make it adequate. Particularly, the proposed *de facto* routing protocol for IoT networks is the Routing Protocol for Low power and lossy networks (RPL). RPL builds a Direction Oriented Directed Acyclic Graph (DODAG) rooted at one node. This node is known as the root, and in the case of IoT it generally is a border router which acts as a gateway to the Internet.

Because of the way RPL operates, it may suffer from inherent issues. As the border router relays all the traffic between the IoT network and the Internet, it is a single point of failure. Upon border router failure, all nodes depending on it may lose global connectivity with the Internet. Moreover, nodes close to the root must forward traffic from farther nodes in addition to their own, which may cause heavy congestion as well as energy depletion inequality. This is known as the funneling effect, and may lead to severe underachievement such as network partition. Border router failure and the funneling effect may heavily impact the quality of communication in IoT networks. Hinted by the RPL specification, border router redundancy could be a solution to both issues. However, there is currently no standard mechanism specified.

Hence, the purpose of this master's thesis is to specify a full solution to enable border router redundancy. To achieve this, we propose a mechanism leveraging cooperation between colocated RPL networks, allowing failover upon border router failure and load balancing. It is introduced thoroughly in the rest of this document along with the results from experiments on real hardware.

THESIS OUTLINE

In this thesis, we will first present the hosting laboratory and research group into which the internship had been conducted. Secondly, we will introduce the IoT as well as RPL and what issues it faces. Thirdly, we will review existing related work among the scientific literature. Then, we will detail our proposal, followed by the results obtained from experimentation. To conclude, we will discuss the conducted work and the potential future research.

This chapter first introduces the ICube laboratory, which was the internship hosting structure. Then we will move onto the layout of the hosting research group and the internship assignments.

1.1 THE ICUBE LABORATORY

The ICube laboratory [1] is one of the biggest research force in France. Directed by professor Michel de Matelin, it is split into seven distinct lab locations in the cities of the Strasbourg euro-metropolis and Illkirch-Graffenstaden. It is a mixed research unit between the Strasbourg University and the French National Center for Scientific Research (CNRS). Created in 2013, it actually hosts around 650 members. Regrouped under the common theme of engineering sciences, this research force is divided into four departments, which in turn are subdivided in groups. Illustrated on the organization chart in Figure 1.1, those four research departments are:

- the computer science department
- the imaging, robotics, remote sensing and biomedical department
- the solid-state electronics, systems and photonics department
- the department of mechanics

1.2 THE COMPUTER SCIENCE RESEARCH DEPARTMENT

The computer science department is directed by professor Pierre Gañarski and is composed of 6 research groups out of the 16 groups of the whole laboratory. Each one is specialized in certain fields of computer science, and works on various subjects such as computer graphics and geometry, bioinformatics, data science or computer networks.

1.3 THE NETWORK RESEARCH GROUP

The network research group [2] directed by professor Thomas Noël is part of the computer science department. It hosts several professors and associate professors, a CNRS researcher and an engineer, as well as PhD students and interns. The network group main research topics are the Internet of Things (IoT) and core networks. The group is also involved in several research projects (*e.g.* Future Internet of Things [3]).



Detailed organizational chart of the ICube laboratory

V7 - 01/2018

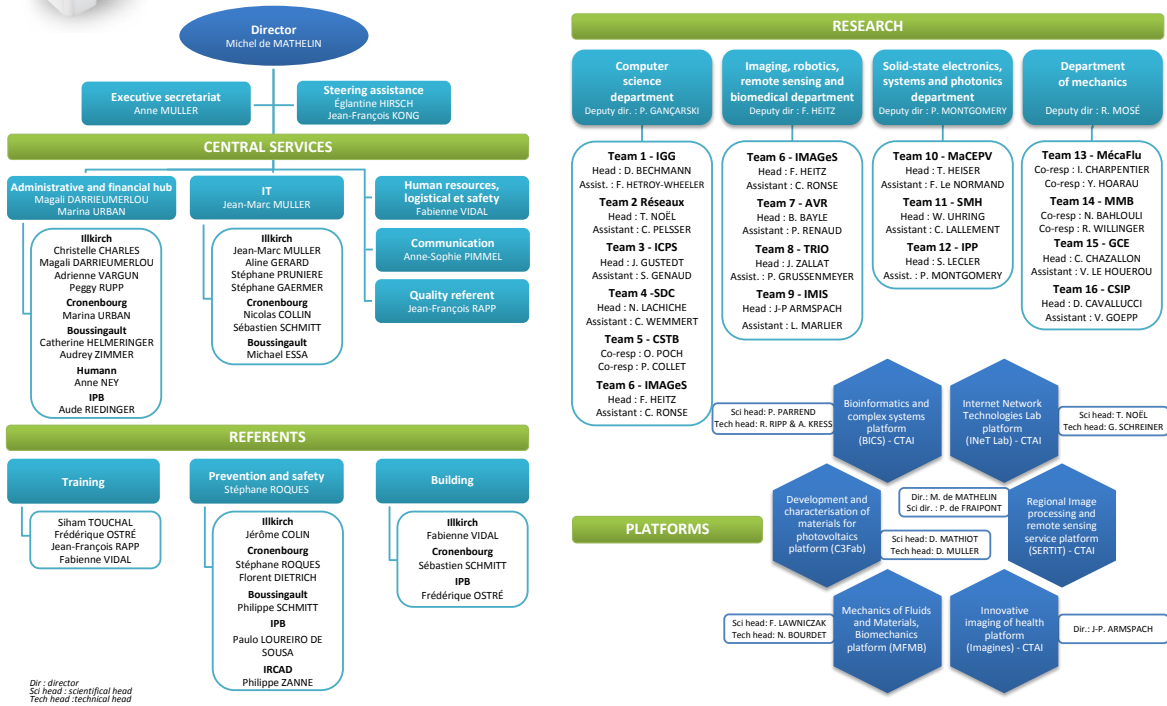

Figure 1.1: ICube organization chart (from the ICube website [1])

1.4 MY ASSIGNMENT

On a more personal note, I was an intern in the network research group for 6 months, and I worked on the topic of IoT. My subject was "Cooperation between multiple RPL networks", and it will be introduced in details in Chapter 2. My adviser and main collaborator was the associate professor Julien Montavont, although I worked with several members of the group. As a research intern, those were the tasks I was assigned to:

- conduct a state of the art related to my subject
- propose an original contribution to resolve existing issues
- implement a proof of concept software
- evaluate the implementation on a real testbed
- write a report summarizing my work

Now that the internship hosting structure has been briefly introduced, the next chapter will present the scientific context related to the matter of concern of this work.

This chapter will present the scientific context that motivated the internship subject. First we will define the internet of things and its constraints. Then we will move onto a specific subset of networking in the IoT: the routing, and we will introduce the *de facto* IoT routing protocol. Finally we will expose the issues this protocol may face.

2.1 THE INTERNET OF THINGS

The recent years have seen a drastic reduction of both physical size and economical cost of electronic components and devices. This opportunity opened the door to equip physical objects with computation and communication capabilities by integrating small and cheap electronic components into everyday objects. With small radio chips, those objects can form networks and benefit from a global Internet connectivity. This is what is known as the Internet of Things (IoT). The IoT have numerous application, such as environmental monitoring, home automation, medical or healthcare uses and many more. Depending on the application, IoT devices may embark additional sensors or actuators, to collect data or trigger physical mechanisms. The IoT is expected to be widely deployed in the next few years. Cisco's IoT Group anticipated that by 2020 there could be more than 50 billion IoT devices interacting with the Internet [4].

2.1.1 *IoT constraints*

Because of the reduced size and cost, as well as the environmental factors depending on the applications, these IoT objects need to put up with heavier constraints compared to classic electronic devices (*e.g.* desktop computers). Constraints include but are not limited to: low computation power, few storage memory, maximum physical size or weight, water or heat resistance... Furthermore, one universal constraint shared by IoT devices is the limited energy available: for mobility and flexibility's sake, these devices usually run on battery and one can only supply so much power. Manual change of batteries for a swarm of IoT devices is not practical, thus IoT devices need to make the most out of the available energy and save as much as possible. Studies have shown that most of the IoT devices' energy is consumed by radio communication [5, 6]. Hence, one way of reducing energy consumption is to reduce transmission power. Combined with large deployment area and simpler radio modulation, this directly leads to another constraint: IoT devices, that from now on will be referred as nodes, may not be in direct reach of every communication's destination. Thus, nodes must form what is known as multi-hop networks. This mean that most nodes need to forward communications from neighbor nodes toward their final destination. Multi-hop

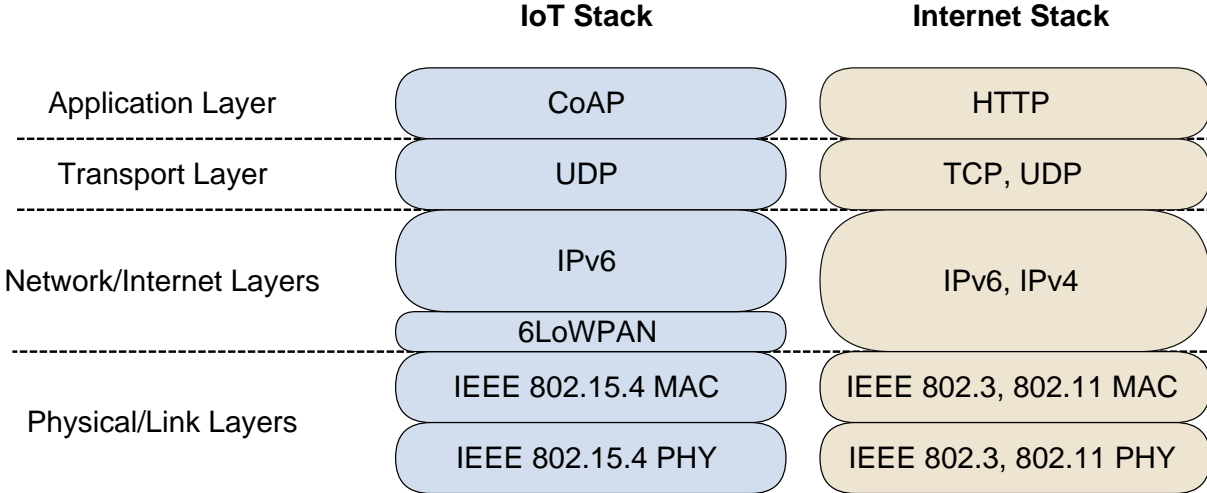

Figure 2.1: IoT stack

networks composed of nodes using small-range radio chips are known as Low-Power and Lossy Networks (LLNs).

As the classic networking protocol suite does not take energy or other constraints into account, IoT devices cannot operate with the well-known TCP/IP network stack. Therefore these particular systems need dedicated protocols that can run on limited hardware and that does not inconsiderately waste energy. Organization like the Institute of Electrical and Electronics Engineers (IEEE) and the Internet Engineering Task Force (IETF) specified new standard protocols adapted to the particularities of IoT systems. Figure 2.1 illustrates the new IoT stack alongside the classic TCP/IP stack. The IEEE standard for the physical and link layers is known as IEEE 802.15.4 [7]. In a few words, 802.15.4 enables low power communication between devices, offering two Medium Access Control (MAC) modes: beaconless mode, where nodes compete for the medium using unslotted CSMA/CA, and beacon mode where the network coordinator synchronizes nodes using a superframe and allocates time slots to each node. 802.15.4 also imposes a 127 bytes Max Transmission Unit (MTU), which can be very constricting.

2.1.2 *IoT network layer*

The IoT network layer is the IPv6 standard [8]. IPv6 not only allows IoT devices to communicate with other hosts across the Internet, but also offers considerable scalability capabilities, which is critical as the IoT is expected to be composed of billions of devices. However, the MTU of a 802.15.4 frame is restricted to 127 bytes. Using 25 bytes for the 802.15.4 header, 40 bytes for the IPv6 header and 8 bytes for the UDP header, there are only 54 bytes left for data in a 802.15.4 frame. Less than half of the space would be left for data, thus greatly lowering the expected performance. Increasing the MTU for a 802.15.4 frame was not considered (at least not before 802.15.4g) because special hardware would be required. Thus the only possibility left was to reduce the size occupied by the necessary headers.

This justifies the new intermediate layer introduced between the network and link layers.

The IPv6 Low power Wireless Personal Area Networks (6LoWPAN) layer [9] sits between layer 2 and 3 and because it uses layer 2 information on layer 3 operations and vice versa. It offers an IPv6 frame format for transmission over IEEE 802.15.4 as well as multiple compression and fragmentation mechanisms, enabling larger data transmission over a single frame while still keeping the 127 bytes MTU. Regarding the upper IoT stack layers, any well known transport (TCP/UDP) or application (HTTP...) protocol could be used theoretically. As transport protocol, UDP is still preferred to TCP, not only because of TCP's complexity, but also because its features (reliability, congestion and flow control, etc.) are covered by another layer (*e.g.* communication reliability with IEEE 802.15.4 using link layer acknowledgments) or are not mandatory considering IoT traffic. Considering the application layer, the Constrained Application Protocol (CoAP) [10] is well-used. CoAP is a web transfer protocol designed for the IoT, offering services close to HTTP while demanding less resources.

2.2 ROUTING PROTOCOLS

Focusing on the network layer, its main responsibilities could be roughly summarized in three tasks: logical addressing, message forwarding and routing. Logical addressing allows network devices to have one or multiple unique addresses specifying their network location. Message forwarding enables hosts from the same or distinct networks to communicate thanks to messages being relayed by others devices on the path. Routing is the operation of shifting a message from a source to a destination. The aim of routing protocols is to find the best path for messages between two devices communicating. The "best" path is the one which gives the best results considering specified metrics or constraints (*e.g.* minimal time consumption, minimal hop count, etc). Routing protocols are subdivided in two families: inter-domain and intra-domain routing protocols. The former group is composed of protocols routing between different networks (*e.g.* the border gateway protocol), and the latter group comprises protocols routing between devices that are part of the same network. Our work concerns routing in the IoT and thus is focused on intra-domain routing protocols. This section briefly introduces the strategies employed by routing protocols.

2.2.1 *Distance-vector and link-state protocols*

Intra-domain routing protocols come in two paradigms: distance-vector and link-state protocols. With distance-vector protocols, nodes only have a local view of the network, as each node only knows itself and its neighbors. Nodes announce known destinations associated to a cost, thus each node can chose for each destination the best next-hop in its neighborhood considering its metrics and constraints. Nowadays classical IP networks rarely use distance-vector protocols, because severe issues may arise like routing loops. In addition link-state protocols generally provide better performance. Unlike distance-vector protocols, link-state protocols nodes have a global view of the network. Based on that global map, each node can calculate its best route for each destination. Distance-vector protocols are generally simpler to implement and operate, while link-state protocols require more computational power and memory to do so. However, link-state protocols usually provide better performance, thus these are favored in nowadays networks.

2.2.2 Proactive and reactive protocols

Considering when to build routes, routing protocols use two strategies: proactive and reactive. Proactive protocols gather information at all times, trying to keep up to date information about every possible route in the network. Thus, a proactive routing protocol engages the operations to build and share the routes as soon as a node is up. Those protocols provide low latency, but may have an expensive cost on the battery lifetime because routes are built and maintained before they are needed. On the opposite, reactive protocols only build route when it is required. Routes are only built upon the start of a communication with another host. While those protocols are more thrifty battery-wise, they also suffer from higher latency because routes are built on demand.

2.2.3 Hop-by-hop and source routing protocols

When a message is carried through the different layers of the network stack and ends up in the network layer, it is called a network packet. A packet contains routing information (*e.g.* source and destination addresses). Two paradigms are used for packet routing, hop-by-hop and source routing. Hop-by-hop routing operations are illustrated in Figure 2.2a. With hop-by-hop forwarding, each node has its own routing table. A source node looks up the next hop for a packet's destination in its routing table before forwarding the packet. The next hop then verifies if the packet is destined to itself, and if not repeats the same operations as the source node. Nodes repeat this process until the packet reaches its destination.

On the opposite, with source routing the whole packet path is wrote into the packet header by the source. Thus, intermediate nodes forward packets by looking up the next hop in the packet header without needing a routing table. Only a single "coordinator" node could have a routing table when using source routing, while other nodes only retain the next hop to reach the coordinator. Source routing operations are illustrated in Figure 2.2b. If a source node different from the coordinator sends a packet, it is first forwarded to the coordinator node. Then the coordinator writes the source routing path in the packet's header before forwarding it to the next hop. Intermediate nodes look up the next hop in the source routing header to forward the packet until it reaches the destination. Source routing provides better memory-efficiency compared to hop-by-hop forwarding. However the packets' routing header greatly increases, enlarging traffic volume in the network. Source routing is also a centralized approach, thus upon central node failure other nodes can not communicate. Hop-by-hop on the other hand is distributed in a way that there is generally an alternate route toward destinations.

2.2.4 Routing in the IoT

Link-state may at first seem like a good choice for an IoT routing protocol: less issues and better performance. However, this would be highly inefficient because of the constrains of IoT devices, as maintaining a global map of the network is expensive memory-wise. Moreover, discovering and maintaining the entire network map requires to exchange a large amount of messages. Radio links in LLNs may also be of poor and unstable quality, leading to an increase in control traffic upon each update of the network map according to link state

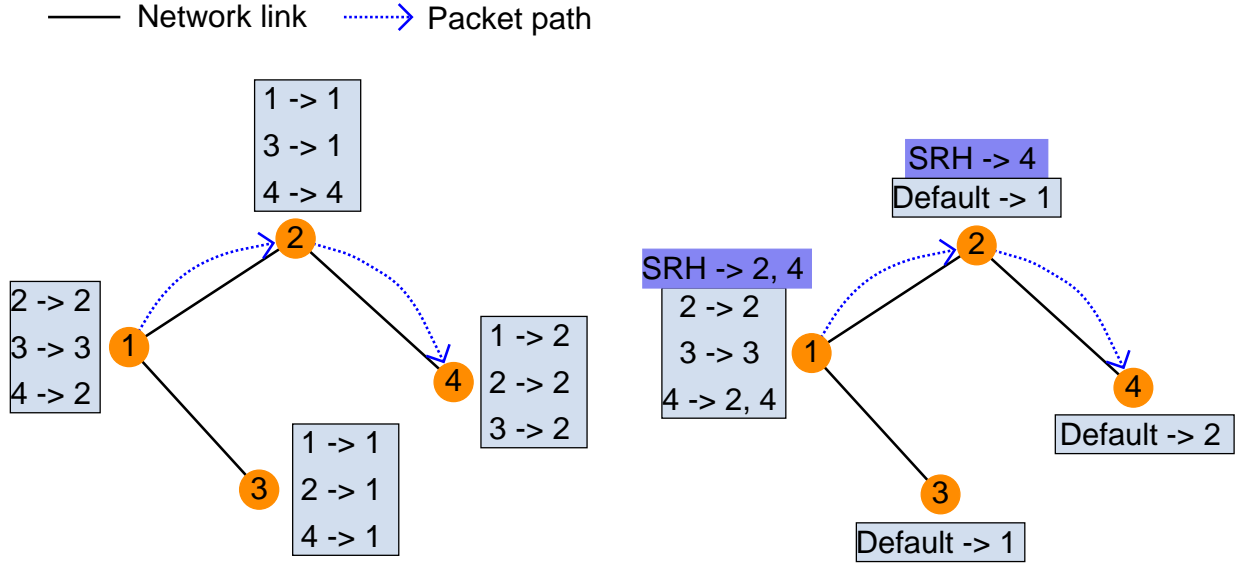

(a) Hop-by-hop routing example - node 1 sends a packet to node 4 which is forwarded according to each node routing table (b) Source routing example - node 1 writes the path in the Source Routing Header (SRH) and sends a packet to node 4

Figure 2.2: Packet routing strategies

variations. Thus, distance-vector protocols are preferred in IoT networks.

The two main IoT routing protocols are the Lightweight On-demand Ad hoc Distance-vector Routing Protocol - Next Generation (LOADng) and the IPv6 Routing Protocol for Low-Power and Lossy Networks (RPL). LOADng is a reactive distance-vector hop-by-hop routing protocol derived from the Ad hoc On-Demand Distance Vector Routing (AODV) protocol, which was created for Mobile Ad hoc Networks (MANETS). RPL is a proactive distance-vector hop-by-hop protocol (with source routing capabilities). RPL is the IETF standard for routing in LLN, thus we focused our work toward improving this protocol.

2.3 IPV6 ROUTING PROTOCOL FOR LLNs: RPL

The IPv6 Routing Protocol for Low-Power and Lossy Networks, which will be referred to as RPL for the rest of this document, is the standard routing protocol of the IETF for LLNs [11]. It is a proactive intra-domain distance-vector routing protocol. The IETF defined several specifications for routing requirements in building automation [12], home automation [13], industrial routing [14] and urban routing [15]. RPL was designed to fulfill the requirements introduced in those specifications.

2.3.1 Basic operations

LLN are mostly used to monitor an environment or other physical conditions [16]. Collected data is generally transmitted to a special node (known as gateway or sink) for storing or re-transmission to the external world. Such traffic is categorized as multipoint-to-point (M2P).

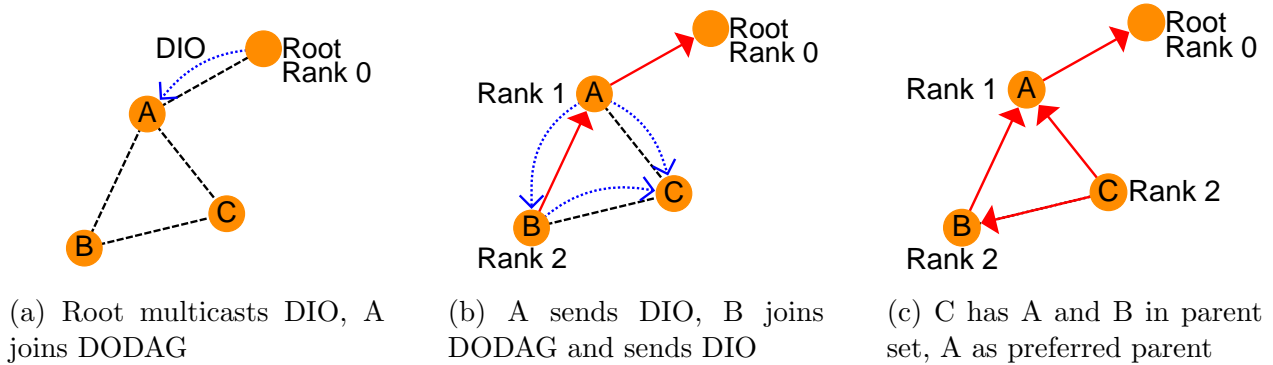
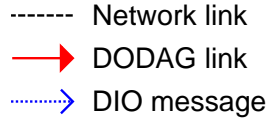

Figure 2.3: DODAG building example

RPL is specially designed to support M2P traffic by proactively building a Destination Oriented Directed Acyclic Graph (DODAG), which is a directed acyclic graph rooted at a single node known as the DODAG root. In addition, the DODAG structure allows nodes to keep redundant routes for reliability purpose in case of link or node failure. The DODAG root could act as a Border Router (BR) whenever the LLN is connected to a separate LLN or to another IP network.

RPL builds the DODAG based on the rank of nodes. The rank defines the relative position of nodes with respect to the DODAG root. For example, a node with a rank set to 1 is closer to the DODAG root than a node with a rank set to 3. So moving away from the DODAG root will strictly increase the rank. The computation of the rank depends on the objective function (*cf.* Section 2.3.3). The DODAG root starts RPL operations by periodically multicasting DODAG Information Object (DIO) messages. Those messages contain all the necessary parameters to enable surrounding nodes to join the DODAG. Upon reception of several DIO, a node joins the DODAG by listing all potential parents in the DODAG. This list is known as the parent set. Among the parent set, it selects its preferred parent, *i.e.* the preferred next hop toward the DODAG root. Then, the node calculates its own rank based on its preferred parent rank plus a fixed constant and may advertise further the DODAG by sending its own DIO. An example of DODAG building is presented in Figure 2.3.

RPL dynamically adapts the transmission frequency of DIO thanks to Trickle [17] to limit the energy consumption. Simply put, the interval between two consecutive DIO is doubled after each transmission while the network is stable. Whenever a change is detected, the interval is shortened in order to converge quickly to a stable state. As a result, Trickle can slow down control traffic to reduce both energy consumption and network contention, and fasten it up to react quickly to network changes. However, Trickle can lead to large intervals of time between two DIO transmissions. If a node wants to join the DODAG while the network has been stable for a long time, it may wait for a very long delay before receiving a DIO (up to 2-3 hours according to [11]). To mitigate this issue, a DODAG Information Solicitation (DIS) message can be sent to request immediate DIO transmission. Multicast

DIS are considered as a network instability, thus the interval between DIO is shortened which triggers DIO transmission. On the opposite, unicast DIS messages are used to refresh DODAG information, so the interval between DIO stays the same and the DIS receiver should reply to the sender with a unicast DIO.

2.3.2 *Point-to-multipoint and point-to-point traffic support*

Point-to-Multipoint (P2MP) traffic pattern is the opposite of MP2P traffic, from one node to many nodes. This is generally used in LLN when the root node needs to distribute messages to all of its nodes at once (e.g. firmware update). Point-to-Point (P2P) traffic pattern is from one node to another single node in the network. P2MP and P2P support are enabled thanks to the downward route mechanism.

Constructing a DODAG with DIO only builds upward routes (i.e. traffic can only go up the DODAG to the root). Once a node has joined a DODAG, it can send a Destination Advertisement Object (DAO) message to build a downward route to itself. A DAO contains information such as the RPLInstanceID and the DODAGID (*cf.* 2.3.4) to identify a DODAG, and also the preferred parent's address of the DAO's sender. A DAO is always sent in unicast to one's preferred parent. However, a DAO may be forwarded up the DODAG depending on the enabled downward route mode of operation. Downward route construction have two modes of operation: storing and non-storing.

In storing mode, all nodes maintain a routing table and send messages according to it. Regarding DAO processing, it is forwarded up the DODAG until it reaches a node that already knows the advertised destination. Storing mode corresponds to hop-by-hop routing, as each node looks up a destination's next hop in its routing table before forwarding a message. Using non-storing mode, only one central node maintains a view of the whole network, the DODAG root. When the root sends a packet to a node in its DODAG, this packet is source routed (*i.e.* the whole packet's path is wrote in a source routing header). When a node different from the root sends a packet, it is first forwarded up to the root which then source route it. Regarding DAO operations, it is always forwarded up until it reaches the root. Intermediate nodes on the path from the source to the root do not retain any information about DAOs they forward.

2.3.3 *Objective function*

One important element of design of RPL is that it separates the internal operations conducted to route packets and the mechanism to build routes. The Objective Function (OF) defines how the latter is operating. The OF describes how a node selects and optimizes its routes. It also defines how a node can convert given metrics and constraints to a value known as the rank, which represents the distance between a node and its DODAG root. Simply put, the OF defines what is the objective of each node when building routes (*e.g.* minimizing the number of hops). Currently, two OFs are standardized for RPL: the Objective Function Zero (OF0) [18] and the Minimum Rank with Hysteresis Objective Function (MRHOF) [19].

OF0 is designed with implementation interoperation as a guideline, thus it does not define how metrics are turned into a rank. This operation is left to the implementation (usually, the hop count metric is used). OF0 goal is for a node to join a DODAG that provides good

connectivity with a large set of nodes or routing infrastructure (such as the Internet). OF0 also defines that a node should choose a preferred parent among its parent set plus a backup parent in case of the preferred one’s failure.

MRHOF is designed to find routes with the smallest cost and to avoid unnecessary route reconfiguration. For that, the metrics used by MRHOF are turned into a rank by calculation. An hysteresis is used to ensure that small changes of a metric value do not trigger route reconfiguration, which would lead to an increase in the control traffic and network instability. MRHOF can use several additive metrics [20] that are regrouped in two categories as illustrated in Table 2.1. MRHOF can also use constraints in addition to those metrics, (*e.g.* node energy).

Node metrics	Link metrics
Node state and attribute object	Throughput object
Hop count object	Latency object
	Link reliability object

Table 2.1: Metrics for MRHOF objective function

The Expected Transmission Count (ETX) is the default metric of MRHOF and is a part of the link reliability object. The ETX is a measurement of link quality between two nodes. It represents the mean number of transmissions needed to successfully transmit a packet from source to destination. ETX is illustrated in equation 2.1 in which PDR stands for Packet Delivery Ratio, s is the source node and d is the destination.

$$ETX = \frac{1}{PDR_{s \rightarrow d} \times PDR_{d \rightarrow s}} \quad (2.1)$$

2.3.4 Advanced features

A RPL node identifies a DODAG with four values: a RPLInstanceID, a DODAGID, a DODAGVersionNumber and a Rank. The RPLInstanceID identifies a given RPL instance (*cf.* 2.3.5). The DODAGID identifies a DODAG which is part of the RPL instance. The DODAGVersionNumber points at one precise version of that DODAG. The Rank represents the position of a node with respect to the DODAG root.

A root node can order a global repair (*i.e.* DODAG reconfiguration) by increasing the DODAGVersionNumber identifier. Upon reception of a DIO containing a DODAGVersionNumber higher than the one they retained for the DODAG they are a part of, nodes start over the DODAG building and recalculate a new rank, then start to send updated DIO with the new DODAGVersionNumber.

2.3.5 Instances

A RPL instance can contain one or multiple root nodes, thus also one or multiple DODAGs. Each instance can provide different routes to different IPv6 prefixes, or pursue a different objective than another instance, therefore using a different objective function. A single node

can be part of multiple instances at the same time, but distinct RPL instances should not interact together. A RPL instance can be composed of:

- a single root maintaining a single DODAG
- multiple roots maintaining multiple distinct DODAGs
- multiple roots coordinated to maintain a single DODAG

2.4 PROBLEM STATEMENT

RPL creates its routes by building a DODAG which is rooted at one single node. Such routing structure may suffer from two main issues: border router failure and funneling effect.

2.4.1 Border router failure

If a RPL root is connected to another IP network, it may act as a Border Router (BR). This external network could be an access network or an ISP network that provides Internet connectivity. In such situation, sensor's data collected by nodes could be directly send to a remote station across the Internet. However upon BR failure, the whole LLN will be disconnected from the Internet as illustrated in Figure 2.4. BR failure could be an electronic or electrical failure, a software bug as well as an heavy congestion leading to an irreversible overload, preventing all or a part of the LLN to communicate with the Internet. Hence, data packets destined to the Internet will be delayed or even dropped which puts time or loss sensitive applications (e.g. healthcare monitoring) at risk. The BR is therefore a single point of failure.

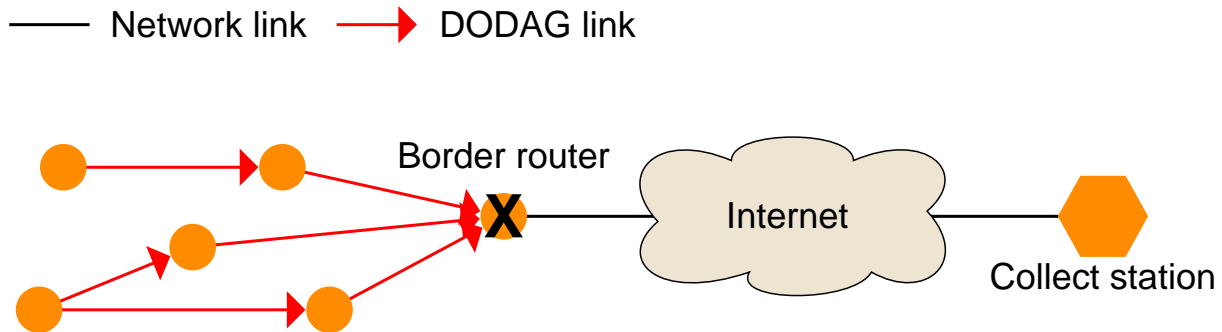

Figure 2.4: Upon border router failure Internet connectivity is lost

2.4.2 Funneling effect

Due to the DODAG structure and the OF and metrics used, the traffic load is generally not fairly shared into RPL network. Using RPL, a node must forward all the traffic from its sub-DODAG toward the BR on top of its own traffic. The closer a node is from the BR, the more likely it is to have many children in its sub-DODAG. This can lead to a situation in

which a node concentrates a large part of the traffic, increasing the contention in this area and potentially creating a congestion in the network. This phenomenon is known as the funneling effect and is illustrated in Figure 2.5. Studies have shown that wireless communication is the main reason of energy depletion of nodes [5, 6]. As a result, nodes that suffer from the funneling effect will prematurely run out of energy, disconnecting their sub-DODAG from other nodes. As a dynamic protocol, RPL can react to this by allowing nodes to either choose a new preferred parent from their parent set or perform a DODAG repair if the parent set is empty. However, there are situations where such solutions are inadequate, leading to a permanent disconnected DODAG (i.e. several nodes are unreachable).

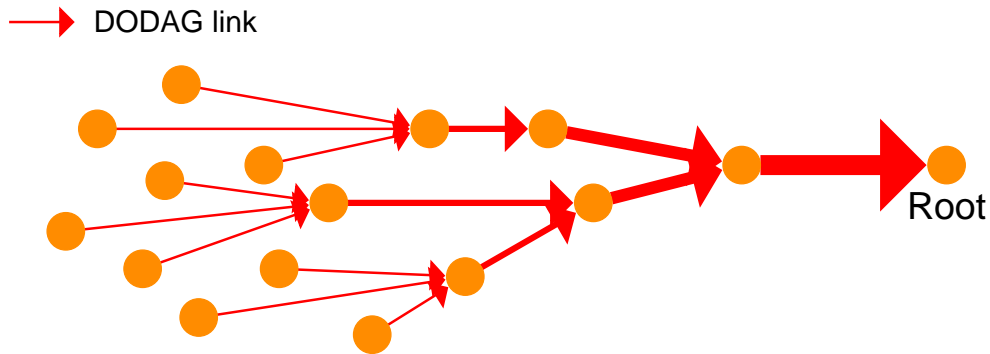

Figure 2.5: The funneling effect (the thicker a link is, the more traffic it carries)

In this chapter, we have seen the scientific context surrounding LLN and the routing task of the network layer. We have briefly presented the operations conducted by RPL, which is the IETF standard for routing in LLN. Then we have introduced the inherent issues that RPL may face, border router failure and funneling effect. In the next chapter, we will present preceding works from the scientific literature focusing on load sharing and using multiple end-points in LLN.

This chapter will review some existing works within the scientific literature related to our matter of interest. As mentioned in [21], over the recent years there has been a lot of work aimed at improving RPL with various mechanisms. However few works were conducted on the topics of multi-sink and multi-instance RPL. Furthermore, this survey shows no existing work classified in the 'General DAG' category, which is the intersection of multi-sink and multi-instance category, despite the considerable attention the RPL RFC devoted to it. This gap in RPL studies was our main motivation for the conducted work we present in this thesis.

3.1 BORDER ROUTER REDUNDANCY

The issues mentioned in Chapter 2 could be solved with one unique mechanism: border router redundancy. The idea is to introduce multiple border routers in one LLN. This would resolve border router failure as nodes could still have an exit point toward the Internet upon failure of one BR. It would also mitigate the funneling effect by distributing the traffic load among multiple exit points. RPL supports the usage of multiple BRs with the concept of virtual DODAG root. The idea is to have multiple DODAG roots acting as standard nodes and pretending to be connected to a unique DODAG root. However the RPL specifications only suggest the concept of virtual DODAG root and do not provide a complete specification. This thesis proposes a complete solution to support border router redundancy in RPL networks to alleviate issues resulting from border router failure or funneling effect. This contribution is presented in Chapter 4.

3.2 MULTIPLE SINKS

Multi-sink paradigm introduces BR redundancy and thus mitigates the aforementioned issues. This section presents published scientific works that propose mechanisms to integrate multi-sink into RPL operations. In [22], several RPL-based routing protocols using multi-sink are designed and evaluated through simulations. Each root node advertises its own DODAG with its own RPL Identifiers. A source node selects the closest sink before sending a packet according to the minimal hop count. Performance evaluation of this protocol using different approaches links better results with a higher number of sinks in the network. This work however does not consider the failure of one root node. With their following work [23], the authors propose a RPL-based routing framework aiming to improve RPL performance with different kind of traffic patterns. Multiple gateways are introduced to reduce the memory overhead due to RPL storing mode. The simulation results show overall better performance, but the aforementioned issues are still not considered. A proposal to dynamically augment the

number of sinks in RPL networks is described in [24]. The proposed mechanism introduces "rescue sinks" in RPL networks deployment. Those sinks would not run until a suffering node calls for help (i.e. a congested node sends DIO with special information). Near rescue sinks would then turn on and absorb a part of the traffic that was originally destined to the suffering node. This idea would not only greatly increase the cost of network deployment, but is also somewhat inefficient as rescue sinks could be used permanently to increase the performance of the network and save nodes' energy. Furthermore the efficiency of such mechanism would be entirely dependent of the location of each rescue sink, which is not studied thoroughly.

3.2.1 *Virtual DODAG root*

The concept of Virtual DODAG Root (VR) is first introduced in the RPL specification and will be thoroughly presented in Chapter 4. To put it simply, multiple root nodes that are part of a single DODAG are coordinated to look as if they were one unique root. It aims to offer multiple attachment points to nodes that are part of the DODAG instead of only one. An implementation of multiple LoWPAN border router is presented in [25]. Here, a single root BR maintains the network, while other BRs do not advertise themselves as roots. The difference with simple nodes is that those BRs have a link with an outer network (e.g. Internet) through which they relay messages to the unique DODAG root in the LLN, which in turn forward them to the destination. This eases the traffic load inside the LLN as outer links are preferred if available. However this solution is not optimal as the BRs that are different from the root could directly forward messages to their destination across Internet instead of relaying them to the LLN root. Furthermore, the utility of a central root BR comes from the fact that in IoT networks nodes are not likely to have a direct link to the Internet. The work presented in [26] offers a different design to introduce BR redundancy. Multiple BRs are connected to a common backbone network, into which is located the unique RPL root (i.e. the root is outside of the LLN). All BRs will then be part of the root DODAG as simple nodes, enabling BR redundancy. However this does not allow different networks to be connected to different backbone networks. In [27], the authors propose a mechanism to allow multi-sink support in RPL leveraging a VR. One central unit known as the "registrar" synchronizes DODAG parameters for all root nodes, thus a VR is created and maintained by the registrar. This enables load balancing as nodes join the DODAG through different roots, but its efficiency is highly dependent on the position of the roots, which had not been studied. Moreover, this work does not take into account the failure of a root node and how orphan nodes could recover from it, nor does it offer a dynamic way to redirect nodes upon congestion once the network is stable. The work presented in [28] proposes a similar way to create a VR in a RPL network. A central unit known as the "Anchor Agent" (AA) is located outside of the LLN and synchronizes DODAG parameters for all BRs. Load balancing is also introduced thanks to multiple root nodes. On the opposite of the previously cited work, it takes into account the failure of a root node. The AA, upon BR unreachability is able to redirect the IPv6 prefixes from the failed BR to another operating BR. Orphan nodes can then reattach to this new BR and recover from their BR failure, without breaking their ongoing connections as the advertised IPv6 prefix is the same. This mechanism uses IPv6 tunnels, which encapsulate IPv6 packets inside IPv6 packets. However, this increases headers' size in LLN communications, thus reducing further the size left for data. All those

works suffer from the same weakness: the use of one central device to maintain a VR. As it is operated by real hardware, the virtual root is not properly virtual, thus can face failure. Using a central device on which depends the proper functioning of the routing operations just shifts the single point of failure onto this device.

3.3 LOAD BALANCING

Using multi-sink indirectly provides load balancing depending on the localization of the sinks. However it is too hazardous to be really efficient and cannot adapt to dynamic variation of traffic. The authors of [29] propose to leverage the RPL objective function so nodes chose their preferred parent not only based on the metrics presented in 2.1 but also taking into account the load of potential parent. Queue utilization in addition to the hop count is used to compute ranks so nodes privilege uncongested path, thus it provides higher performance than RPL under congestion. However, using several parameters to compute a rank requires to associate a weight with each component. Moreover, different instances may pursue different objectives and thus use different objective function. Also, node redirection is not coordinated, thus upon heavy congestion every path may be congested and nodes will change path over and over without stabilizing. The authors propose a probabilistic parent change to avoid this: each node have a given probability to redirect, therefore this mechanism does not provide optimal redirections. Moreover, we believe that avoiding congestion should not be a specific objective of a network, but rather an inherent mechanism of a routing protocol. The mechanism presented in [30] proposes a load-balancing scheme based on multiple gateways. It is not based on RPL but still aims for 6LoWPAN networks use, and its operations make it very similar to RPL. A Virtual height Level (VL) parameter reflects the load of each node. A node selects the lowest VL in its neighborhood as next hop, thus sharing the load. However, being similar to [29] this mechanism suffers from the same downsides as well. In [31], a mechanism leveraging cooperative multiple instances based on game theory is proposed. It leverages the use of multiple instances within a single RPL network supervised by a single root. Cooperation between nodes that are part of different instances results in better overall performance. However this work does not consider BR failure nor does it provide a failover mechanism between instances. A coordination framework is proposed in [32]. This mechanism enables information piggybacking over DIO message. When a node that is part of a DODAG overhears DIOs from another DODAG, it records and transmits those with its own DAOs. Information is carried over to the DODAG root, which allows distinct networks roots to discover themselves and exchange metrics to optimize their network. Then roots can decrease the radius of DIOs transmissions to indirectly redirect nodes to a neighbor root, thus balancing the traffic load. Though it does not allow for precise redirection or consider BR failure, this is an interesting mechanism to which we will refer later in our contribution as it allows co-located BR to discover each other and exchange initialization information.

In this chapter, we have seen the scientific works related to the subject of this thesis. We briefly exposed why we think those works do not fully resolve the issues raised by BR failure and funneling effect. The next chapter will detail our own contribution.

The previous Chapter explained why, in our opinion, the existing scientific works related to RPL issues introduced in Chapter 2 do not provide a sufficient answer. Thus in this thesis we propose an original contribution which aims at alleviating BR failure and funneling effect. Our contribution, called RPL with Network Address Translation and Load Balancing (RPL-NAT-LB) is composed of three parts: first part follows the hint of the RPL RFC and introduces border router redundancy in LLNs. Second part uses the Network Address Translation (NAT) protocol to enable multiple IPv6 prefixes support between cooperating BRs. Third and final part introduces a load-balancing mechanism to alleviate the funneling effect.

4.1 CONSIDERED IoT SCENARIO

Our solution was designed according to our vision of the most likely IoT networks deployment scenario. Our guess is that IoT networks will be widely spread in home, urban and industrial environments, thus many networks would be colocated with others. IoT networks would be composed of different devices, produced by different companies, competing for control over the communication medium (most likely the air). We propose to leverage this colocation to enable cooperation between networks. In industrial environments, an economical obstacle could exist as companies would not want their network to cooperate with a competitor's one. However regarding urban and home networks, we think that the main matter of concern is network efficiency. Thus, colocated networks could share links and nodes to mitigate the nefarious effects stemming from BR failure and funneling effect.

4.2 MULTIPLE BORDER ROUTERS

Taking into account the considered scenario, each colocated IoT network would have one dedicated BR for its own network. Therefore if we can enable BRs coordination, BR redundancy would come at no additional cost.

4.2.1 *Motivations*

Multiple BRs in a single network bring multiple advantages: first, it increases the resilience of the network, as upon BR failure another could retrieve the orphan nodes, thus preserving their Internet connectivity. Secondly it offers load balancing, as the traffic load can be shared between multiple exit points. Moreover, BR redundancy can enable multi-homing support. Multi-homing occurs when a single network have multiple Internet accesses via

multiple Internet Service Providers (ISPs). Thus if one ISP undergo failure resulting in loss of Internet connectivity for its clients, a multi-homed network would maintain Internet connectivity through another ISP. Multi-homing provides load balancing as well as traffic load can be splitted between ISPs. Considering our scenario, different BRs from different networks may have different ISPs, which would enable multi-homing. BR redundancy was hinted by the RPL specification with the concept of virtual DODAG root.

4.2.2 Virtual DODAG root

The Virtual DODAG Root (VR) was first introduced in [11], but this document did not fully specified how it should be operating. As illustrated in Figure 4.1, a VR is obtained when multiple BRs from an unique RPL network coordinate themselves to act as if they were a unique DODAG root. This introduces BR redundancy without the need to modify deeply RPL operations. Therefore, the first part of our contribution enables VR support in a similar way to [27, 28]. All BRs maintaining the VR share the same RPL identifiers presented in Chapter 2, and use the same IPv6 addresses. Thus, all BRs are part of and maintain the same DODAG. All BRs send the same DIO, therefore nodes joining the DODAG only see one sole BR on network layer, and they can then join the nearest BR. As each BR keeps its unique MAC address, the differentiation between them is done on link layer. Using a VR requires parameters synchronization between BRs before starting the dissemination of DIO messages. BRs must also regularly update RPL identifiers as they may change (e.g. upon global repair). Works presented in [27, 28] use a central synchronizing point to maintain and distribute RPL parameters among BRs. In contrast to those, we use a distributed mechanism instead of a central one. Using an opportunist discover scheme between BRs from distinct networks, similarly to what is proposed in [32], BRs could discover themselves and then exchange their public IPv6 with piggybacking over control messages if needed (*i.e.* BRs not in direct radio reach of each others). They could then share the DODAG parameters and start maintaining a VR and a new DODAG. This benefits from the advantages of using a VR while avoiding the single point of failure represented by an unique synchronization point. Unfortunately, considering our privileged scenario one issue could arise as different IPv6 prefixes may be used in different networks.

4.3 MULTIPLE IPV6 PREFIXES

A global IPv6 network address is composed of three parts: the routing prefix, the subnet ID and the interface ID. The network prefix is the union of the routing prefix and the subnet ID. It identifies a given network, while the interface ID points to a given device part of this network. Different IPv6 networks should use different IPv6 network prefixes.

4.3.1 Motivations

The DODAGID RPL identifier refers to a unique DODAG, and is also the IPv6 address of a the DODAG root. In LLNs, BRs can distribute the IPv6 prefix used by the nodes taking part in the network, thus the DODAGID of a given BR is based on its prefix. The

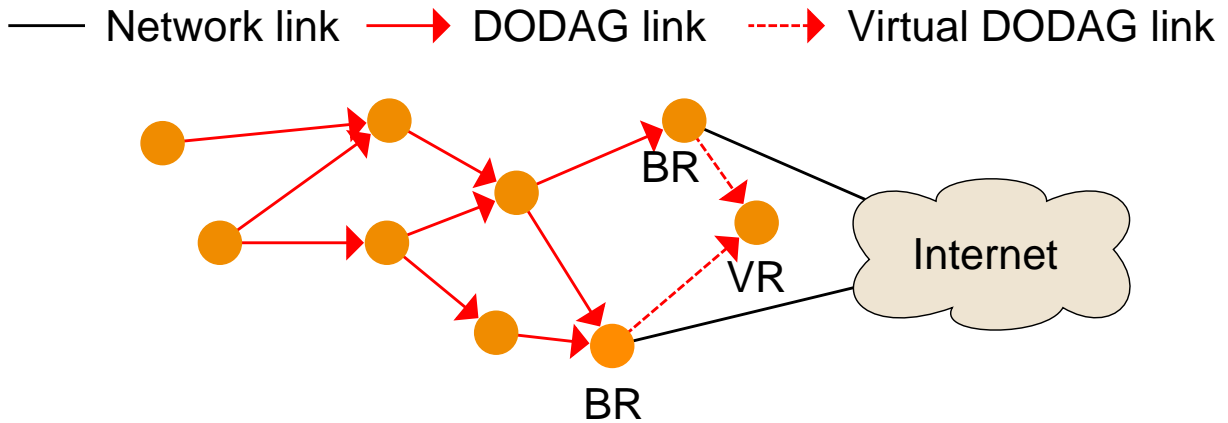

Figure 4.1: Virtual DODAG root

DODAGID is shared between all of the BRs taking part in a VR. Considering our scenario, distinct networks owned by different companies are likely to use and announce different IPv6 prefixes, thus raising a conflict with the use of a VR. BRs must synchronize and distribute one unique IPv6 prefix in the LLN, as BRs from the same VR share the same DODAGID and cannot use different IPv6 prefixes. Therefore, BR must synchronize on using one same IPv6 prefix in the DODAG, though as BRs may not be connected to the same backbone network, they may not be able to announce the same IPv6 prefix. The first motivation for multi-prefixes support is to resolve this issue. Furthermore, enabling multi-prefixes support could help enable IPv6 mobility as well. IPv6 mobility lets a device move from one network to another without having to change its IPv6 address. Without IPv6 mobility, a node that switches networks (e.g. upon BR failure) must discard its current address and configure a new one according to the new prefix. This requires time and resources and also breaks all ongoing communication with hosts located across the Internet. Moreover, most if not all of the works referenced in Chapter 3 make the hypothesis that the whole network uses one same IPv6 prefix. While this may be reasonable in the deployment of lone networks, we think that it is less likely to be a valid requirement when considering the cooperation of multiple networks owned by the different organizations.

4.3.2 Network address translation

Network Address Translation (NAT) is a widely used protocol in IPv4 networks. This mechanism specified in [33] was the main crutch preventing IPv4 to collapse from address exhaustion. The principle of NAT is to match IP addresses with corresponding IP addresses. It was often used in IPv4 networks to assign one public IP address to a whole private subnet composed of several hosts. Although NAT has provided many benefits, it was the cause of some difficulties as well: as the association of an host located in a private network was done on connection initialization, it was not possible to initiate a connection with an host located behind a NAT as it was (e.g. when running a server). When IPv6 was specified, one of the objectives was to get rid of NAT to avoid those issues. With the huge pool of IPv6 addresses,

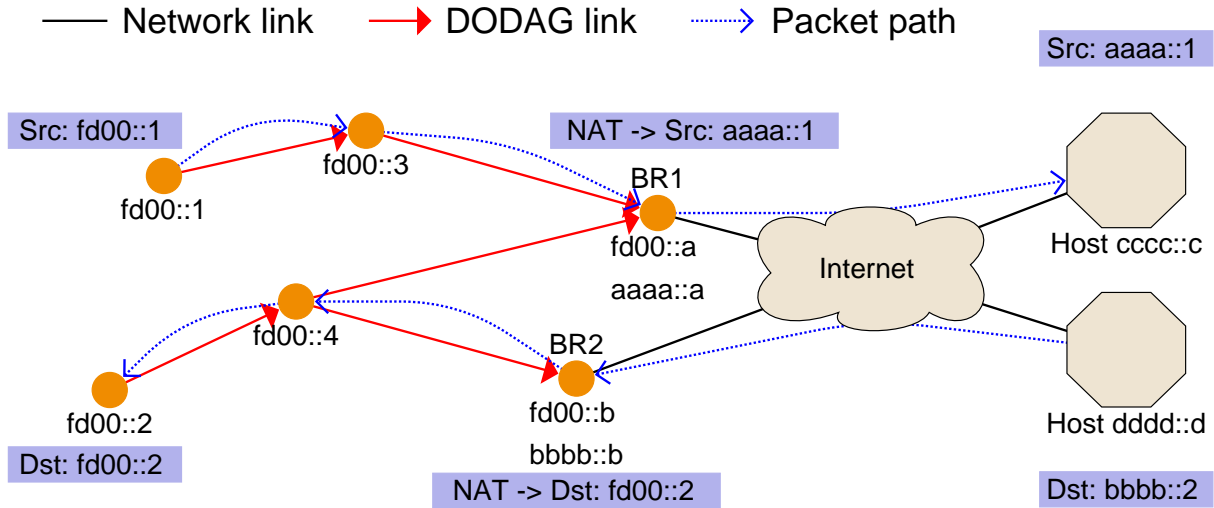

Figure 4.2: NAT example - address translation upon packet forwarding

each host can have its own IPv6 address without risking address exhaustion. Despite this, a specification for IPv6 NAT still exists [34]. One of the justifications to use NAT with IPv6 is that it can help enable multi-homing. Thus, in the second part of our contribution we adapted the NAT protocol within RPL to use a unique local prefix to synchronize multiple networks using different prefixes. BRs can each announce a different prefix, but they will distribute a default Unique Local IPv6 Unicast Addresses (ULA) prefix [35] into the LLN. Therefore, as illustrated in Figure 4.2, BRs will translate the source's or destination's IPv6 address depending on the packet's destination before forwarding. Every node will then be able to communicate with all nodes from another network regarding RPL operations as they will use the same IPv6 prefix. Cooperating BRs can then share their IPv6 prefixes through the Internet and position themselves as backup routes for prefixes owned by colocated BRs. Upon a BR failure, orphan nodes can join a neighbor BR while keeping the same IPv6 address, therefore preserving their connections with hosts across the Internet.

4.4 LOAD BALANCING

Hosts in the same network may not produce the same amount of traffic quantity. Load balancing is the action of evenly splitting the traffic load between hosts and intermediate devices, aiming at avoiding bottlenecks and uneven workload distribution. This is even more important in LLN than in classic IP networks because of the limited amount of energy and the multi-hop topologies.

4.4.1 Motivations

While the first two parts of our contribution solve BR failure, they only partially solve funneling effect. Bottlenecks may stem from the funneling effect, which in turn cause heavy congestion in the network. Using multiple BRs shares the load depending on the position of

those nodes, but it cannot alleviate dynamic congestion. A new load balancing mechanism could allow to dynamically share the load, thus reducing the risk of congestion and energy depletion inequality. We find referenced works in Chapter 3 not totally satisfying, hence we propose a new mechanism to dynamically balance the traffic load.

4.4.2 Prerequisites

Therefore, the third part of our contribution is a flexible mechanism to explicitly redirect nodes from a congested network to a less loaded one. Automatic redirection decided by the nodes themselves, similarly to [29], is fast and does not increase the control traffic in the network. However, this allows imprecise redirection to take place, which may only improve the connectivity of a single node while handicapping another part of the network. Moreover, this can cause jitter as nodes may not stabilize (e.g. if the whole network is heavily loaded). Instead, we propose an explicit redirection mechanism supervised by the cooperating BRs. This enables optimal node redirection from a global network point-of-view. This, however, has two prerequisites: first, we need to use the non-storing mode of downward routing of RPL. With non-storing, the BR of a network will receive all DAOs from all of the nodes joining its LLN, while using the storing mode does not guaranty that DAOs will travel all the way to the BR (not forwarded by the first node that already knows the advertised destination). If a BR receives all DAOs from its child nodes, it then knows all the nodes of its DODAG and their parent. Secondly, because of the VR, the BRs all look the same on network layer. Thus, we use RPL instances to differentiate which BR each node is attached to: each BR uses a unique RPLInstanceID. Each node is then a part of only one instance, and upon explicit redirection from its BR, must switch to another instance.

4.4.3 Explicit redirection

We define a redirectable node as one that has one or more neighbor nodes from a different RPL instance, which is learned when receiving DIOs. Upon reception of a DIO from a different instance, a node activates a special Redirectable Flag (RF) in its DAOs. A redirectable node also retains the IPv6 and link addresses from the best node (i.e. lowest rank) of another instance. DAOs are transmitted regularly, thus a BR quickly knows each redirectable node from its DODAG. In order to avoid bad links, a node sets its RF to 0 if it does not receive a DIO from another instance after two DIO intervals.

A BR has two modes in our protocol: normal and congested. In normal mode, the classic RPL operations are conducted. A BR enter congested mode depending on an user defined trigger (e.g. max sub-DODAG size, queue losses, etc). BRs can dynamically exchange DODAG information between them via the Internet (e.g. sub-DODAG size) and enter congested mode depending on specific calculation (e.g. significant difference in the sub-DODAG size). Cycling through its node list, a congested BR chooses the best nodes to redirect (e.g. if it needs to redirect X nodes, it redirects one node with X-1 children). Then, a BR sends in unicast a new control message that we introduced to redirect nodes, known as a DODAG Redirection Solicitation (DRS), and deletes the redirected node from its sub-DODAG list. As for now, a DRS is a simple ICMPv6 message containing no additional information. Those

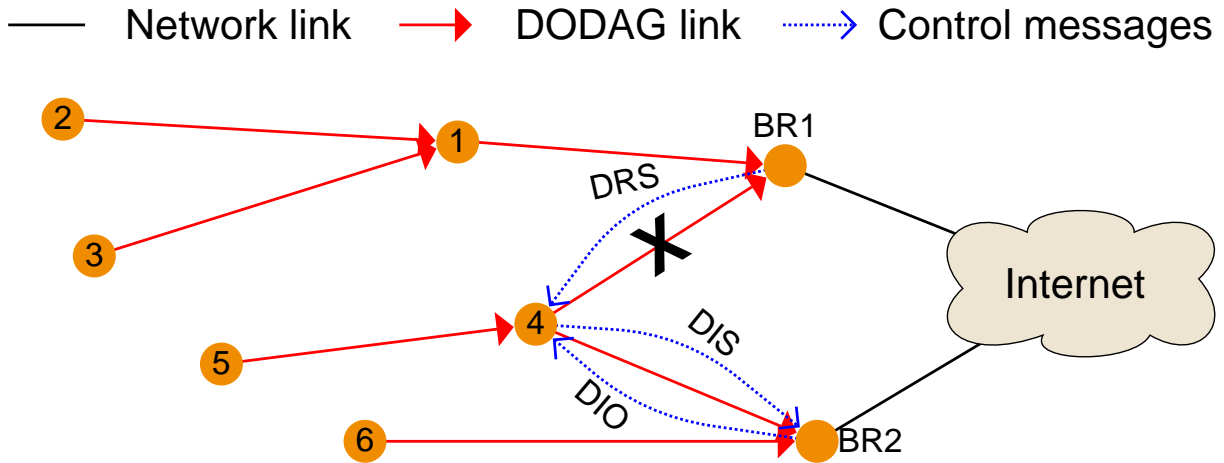

Figure 4.3: Redirection example - overloaded BR1 redirects nodes 4 and 5 with a DRS, node 4 join BR2’s instance and node 5 follows it

operations are repeated until the congested node trigger is released (e.g. even sub-DODAGs size between BRs).

Upon DRS reception, a node enters a transitioning redirection state. It first sends a unicast DIS to the best node from a different instance it has seen before using the retained addresses, to receive a fresh DIO instead of storing one that could potentially be obsolete at the moment of DRS reception. Upon DIO reception the node switches instances and joins another new DODAG from the another instance. However, upon non reception of a DIO before next DAO transmission, this node stops its redirection and turns off its RF. This allows nodes to keep their connectivity until effective redirection, thus avoiding the traffic loss that could occur within DRS and DIO reception. Furthermore, if a node receives a DIO from their preferred parent with a different RPLInstanceID, they immediately follow it to the new instance based on the received DIO. This enables multiple redirections with one DRS, and avoid issues occurring when a BR could redirect a node before receiving DAOs from its children. Those operations are illustrated in Figure 4.3.

Throughout this chapter, we have detailed each part of our proposal, known as RPL-NAT-LB. The VR alleviates BR failure, the NAT protocol enables multi-prefixes support and the explicit redirection with DRS mitigates congestion stemming from funneling effect. In the next chapter, we will present the implementation and experimentation of our proposal.

This chapter first presents our proposal implementation under Contiki OS. Then we detail the experiments conducted on FIT/IoT-LAB along with the results obtained from our contribution compared to RPL.

5.1 IMPLEMENTATION

To assess the efficiency of our proposal, it was implemented based on the existing open-source code of a well-used IoT operating system, known as Contiki.

5.1.1 *Contiki OS*

Our implementation uses Contiki OS version 3.x. Contiki OS [36] is a lightweight open-source operating system for IoT devices. It was created by Adams Dunkel in 2002 and was since improved by many scientists and industrial actors around the globe. It has become one of the most used operating systems for IoT. We have chosen to implement our contribution under Contiki for several reasons: firstly Contiki is widely spread and widely used. Secondly, it is supported by our testbed platform, and finally it is entirely written with the C programming language. Contiki comes with a full IPv6 network stack as well as an implementation of the RPL standard, known as Contiki RPL.

5.1.2 *Cooja*

Contiki provides its very own wireless network simulator, known as Cooja. Cooja is a simulator with emulator capabilities, as it offers to emulate different node hardware, which allows to obtain more precise results than basic simulation. While results obtained by simulations will not be presented here, we find it fair to mention Cooja anyway as it was a useful tool to quickly implement new features in Contiki OS and test those under a controlled environment.

5.1.3 *Implementation cost*

Our implementation cost in terms of memory used (in bytes) is visible in Table 5.1. Regarding the border router firmware, our contribution compared to using RPL enlarge the firmware by 5884 bytes. As for the node firmware, compared to using RPL, using our contribution enlarge the firmware by 5200 bytes. In perspective with the hardware of the motes used in our experiments (*cf.* Table 5.2), we find the size difference to be acceptable.

	Border router	Node
RPL	1063744B	1100896B
RPL-NAT-LB	1069628B	1106096B

Table 5.1: Compiled firmwares’ sizes in bytes

Microcontroller unit	ARM Cortex M3
Architecture	32 bits
Frequency	72 MHz
Random access memory	64 kB
Read-only memory	16 MB
Radio chip	AT86RF231

Table 5.2: M3 open node hardware

5.2 EXPERIMENT SETUP

We started to experiment on a real testbed with our contribution implemented on top of Contiki RPL. This section introduces the IoT-LAB testbed on which we have tested our proposal, as well as the test scenario and network layout we used.

5.2.1 FIT/IoT-LAB

We chose to conduct our experiments on a real testbed known as FIT/IoT-LAB [37]. IoT-Lab is one of the platforms provided by the Future Internet of Things (FIT) project [3]. It is a large scale testbed allowing any computer scientist to test wireless networks composed of small and constrained devices. The testbed is located in six different cities in France, and is composed of a total of 1791 wireless sensor nodes. IoT-Lab offers a tool box as well as an SSH frontend to quickly launch experiments and retrieve results through the serial link of each node. The testbed is composed of different hardware offering different testing environments, like different hardware or even mobile nodes. Our contribution was evaluated using the testbed from the IoT-Lab site located in Illkirch-Graffenstaden. We used the M3 nodes provided in IoT-Lab, whose hardware capabilities are presented in Table 5.2.

5.2.2 Experimental parameters

Experimental parameters used for the tests can be found in Table 5.3. As Media Access Control (MAC) layer, we have decided to use the simplest protocol available in Contiki, as the aim of our work is not to evaluate the performance of the MAC layer. The role of the MAC layer is to control the radio scheduling of each node and to avoid radio collisions. Carrier Sense Multiple Access Collision Avoidance (CSMA/CA) is a widely used MAC protocols in classic wireless networks such as Wi-Fi. Using CSMA, each node competes for the use of the shared communication medium (the air). If a collision is detected, the transmitting node stops, waits and after random backoff time, retries to transmit its data. We enabled the acknowledgment mechanism proposed by 802.15.4, in order for the nodes to know when a

MAC layer	IEEE 802.15.4 CSMA/CA
MAC acknowledgments	Enabled
MAC Tx queue size	1 packet
RDC mechanism	No RDC (NULLRDC)
Traffic type	UDP packets
Traffic rate	1 packet per second
Tx power	3 dBm
Rx power threshold	-60 dBm
Motes used	10 M3 open node
RPL mode	Non-storing
RPL OF	MRHOF ETX
Congested mode trigger	Sub-DODAG size threshold

Table 5.3: Experimental parameters

frame was lost and to retransmit it. We have also reduced the size of the waiting transmission queue of nodes in the network, to introduce congestion without having to use a large number of nodes or to saturate the link.

Regarding the Radio Duty Cycling (RDC) mechanism, we chose to use the NULLRDC available in Contiki as we do not intend to evaluate RDC mechanisms. The role of a RDC mechanism is to save energy by turning off the radio chip when it is not needed, while at the same time trying to preserve performance as much as possible. NULLRDC simply does nothing (*i.e.* the radio chip is on all the time), which corresponds to a RDC ratio of 100%. Nodes in the network generated traffic which was simple UDP packets, containing a single integer corresponding to the sequence number of the packet. Such packets were sent at a rate of one per second. The transmission power was left at its maximum capability with M3 motes, which is 3 dBm. However, we reduced the reception power threshold to -60 dBm. This means that transmission would be forwarded from the physical layer to the link layer only when they would be of a minimum quality represented by the threshold value, allowing us to have control over the RPL topology. We used a total of 10 M3 motes for our experiments. RPL mode of operation for building downward routes was non-storing, to have the root nodes know every node from their sub-DODAG. RPL objective function was MRHOF, using the ETX metric, as this is a rather well accurate and widely used link quality estimator. Finally, the trigger we used for congested mode was a threshold on one's BR sub-DODAG size equal to the total number of nodes divided by the number of BRs.

5.2.3 Network layout and scenario

To assess the efficiency of our proposal, we tested it on a controlled topology, in order to understand the observed results. We used 10 M3 nodes of IoT-LAB, two of which were BR, and the 8 other were simple nodes sending a regular amount of traffic destined to an host outside of the network. The nodes' output was collected through the serial link for each one of the 8 traffic generating nodes. Regarding the two BR, a Serial Link IP (SLIP) tunnel was used to collect BR output as well as to send the prefix that each BR should distribute.

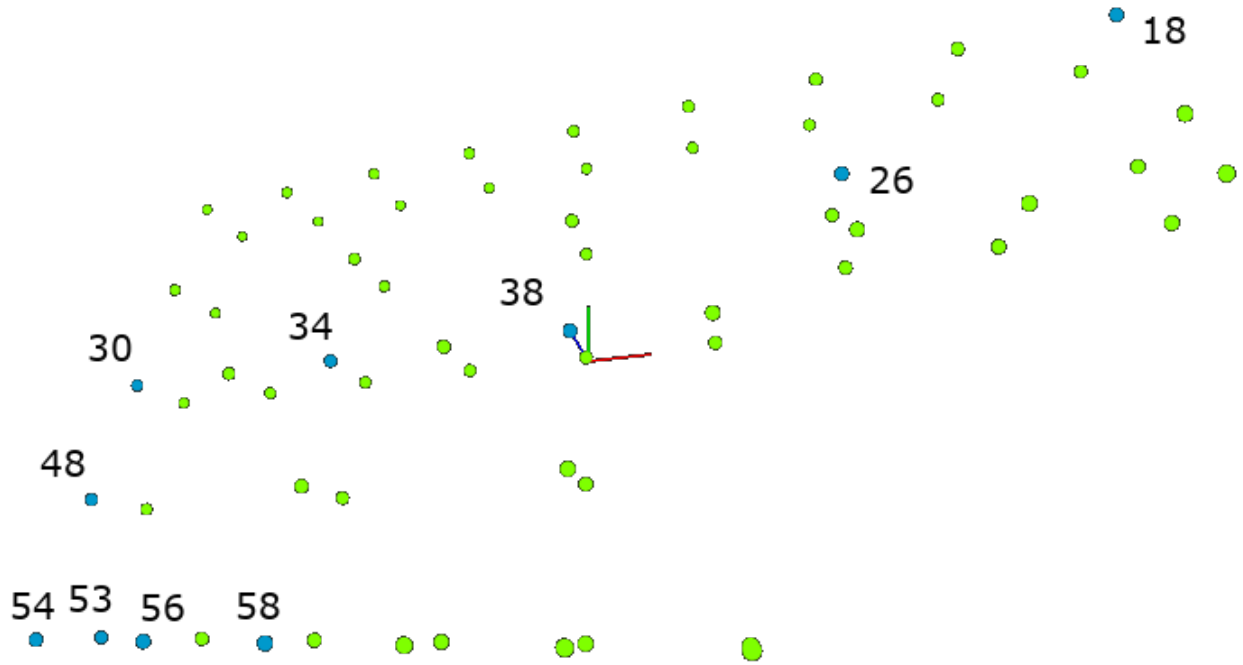

Figure 5.1: Physical topology of the testbed

This tunnel enables IP packet transmission through a serial link, thus allowing us to receive packets coming from the LLN on our computer. The physical topology of the network is visible in Figure 5.1. All the M3 motes of the Strasbourg site are represented. The blue ones are those we used in our experiments, along with their corresponding node ID. We chose to use the two nodes with the more distance to each other as BR, nodes 18 and 53. In our scenario, we wanted to recreate what could happen when a new network boots in colocation of a stable one. Therefore, the BR node 53 starts 60 seconds latter than the BR node 18. The 8 other nodes that are not BR start to transmit UDP packets at a rate of 1 packet per second after 30 seconds. The expected result is that by the time node 53 awakes, all 8 other nodes would have already joined the DODAG of node 18 and started to transmit data destined to an outer host. Thus the network would experience congestion, to which RPL would not be able to recover, while our proposal could balance the traffic load. As the topology is usually stable after about 10 minutes, we chose to make each experiment last for an hour. In order to have statistically significant results, we launched a total of 100 experiments. Half were using RPL and half RPL-NAT-LB. In the next section, we will present the results we obtained from those experiments.

5.3 RESULTS

In this section, we first show the DODAG obtained from the experiments. Then we introduce the collected metrics to evaluate the performance of RPL-NAT-LB and RPL. We finally present the obtained results under the experiment conditions described in the last section.

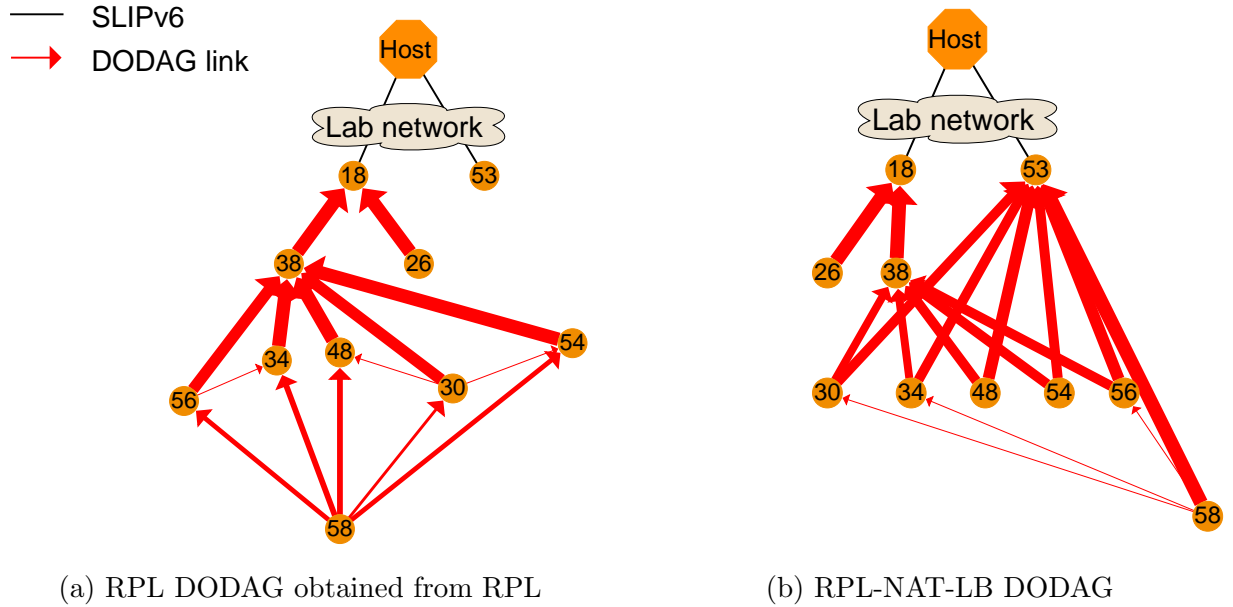

Figure 5.2: Mean topologies obtained - the thicker a DODAG link is, the more frequently it appears

5.3.1 Obtained topology

We have recorded the preferred parent of each node at the end of each experiment. Figure 5.2a represents the cumulative DODAG obtained from experiments using RPL, while Figure 5.2b represents it from using RPL-NAT-LB. Each DODAG link measured is represented by a red arrow. The thicker it is, the more frequently the link was measured. Regarding RPL results, the first thing we can see is that the BR node 53 does not have any child node. This was expected as this node starts a little bit after the other nodes, thus all nodes join the DODAG of the BR node 18. Due to the physical topology presented in Section 5.2 as well as the reduced Rx power threshold, 6 out of the 8 nodes generating traffic are children of the node 38. Therefore this node may be an important bottleneck in the network as it must relay all traffic from lower nodes in top of its own. Concerning RPL-NAT-LB results, we can see that the children are distributed among the two BR. Most of the nodes are child of nodes 38 or 53 depending on the experiments. This way, the traffic load is well balanced between BR, and the node 38 does not have to relay as much traffic as when using RPL.

5.3.2 Considered metrics

The first considered metric was the Packet Error Rate (PER, also known as the Packet Error Ratio). The PER is the ratio between the number of packets lost and the total number of sent packets. It is a good indicator of how well a network performs. Equation 5.1 shows the formula we used to calculate the PER of a given node in percentage as presented in the results. The second metric we have considered is the bandwidth repartition on each BR. Indeed, if our load-balancing mechanism is working as intended, then we should see an equal load on all BR of the network. On the contrary, using RPL would induce load imbalance

between BR. Third metric is the consumed energy by the nodes. If our proposal reduces congestion, thus it should reduce the number of transmitted messages. As the majority of the energy used by a node is spent by wireless communications, in turn we should see a decrease in the consumed energy when using our RPL-NAT-LB instead of RPL. The final metric we wanted to measure is the total number of control messages sent. As control message is additional traffic that does not carries any kind of directly useful data to the final user, a good routing protocol should minimize the quantity on control traffic introduced in the network. Regarding RPL, as the Trickle Timer is reset when inconsistencies are detected, a network that uses less control message should be a more stable network that a network using more control message.

$$PER = 1 - \left(\frac{Total_{received}}{Total_{sent}} \right) \times 100 \quad (5.1)$$

5.3.3 End-to-end packet error rate per node

The end-to-end PER of a node represent the ratio of lost packets on the path from a source to a destination. Figure 5.3 shows the mean end-to-end PER difference per node between RPL-NAT-LB and RPL in percentage, along with the standard deviation. This represents the loss ratio decrease when using our contribution instead of RPL. As this is a measure of end-to-end performance, here we only consider UDP traffic generated by all nodes that are not BR. We can observe that for all nodes except node 26, the end-to-end PER is slightly better when using our contribution than when using RPL. We can note that the difference between the two is small (less than 5%). This is due to the fact that thanks to the acknowledgments and retransmission mechanisms, most of the UDP packets reach the destination even though the network is congested. Node 26 tiny loss increase may come from random change in the environment, as RPL-NAT-LB does not modify its link as seen in Figure 5.2. Node 38 link is not modified either, but loss decrease is likely to be due to the number of its child nodes decreasing. As for the node 18 and 53, those are BR and thus does not send any UDP traffic, thus there is no end-to-end PER difference. As end-to-end loss are mainly due to queue drop, we can infer that RPL-NAT-LB enable a better load-balancing than RPL.

5.3.4 MAC packet error rate per node

The MAC PER of a node represent the ratio of lost packets between that node and a given immediate neighbor, only one hop away. We chose to measure the loss ratio of both Transmitted (Tx) and Received (Rx) packets. The Tx PER of a node is the ratio between the number of messages received by all nodes and the total number of message sent by this node. On the other hand, the Rx PER of a node is the ratio between the number of messages received by this node and the total number of message sent to this node by all other nodes. Figure 5.4 shows the mean MAC PER difference per node between RPL-NAT-LB and RPL in percentage, along with the standard deviation. Only the unicast messages are taken in count here, as multicast messages are not acknowledged, so we could not know if they were received or not. The UDP traffic as well as the RPL control traffic is considered. At first glance, the results seem to be lukewarm. Most nodes seem to have better results with RPL-NAT-LB

End-to-end Packet Error Rate difference between RPL-NAT-LB and RPL per node

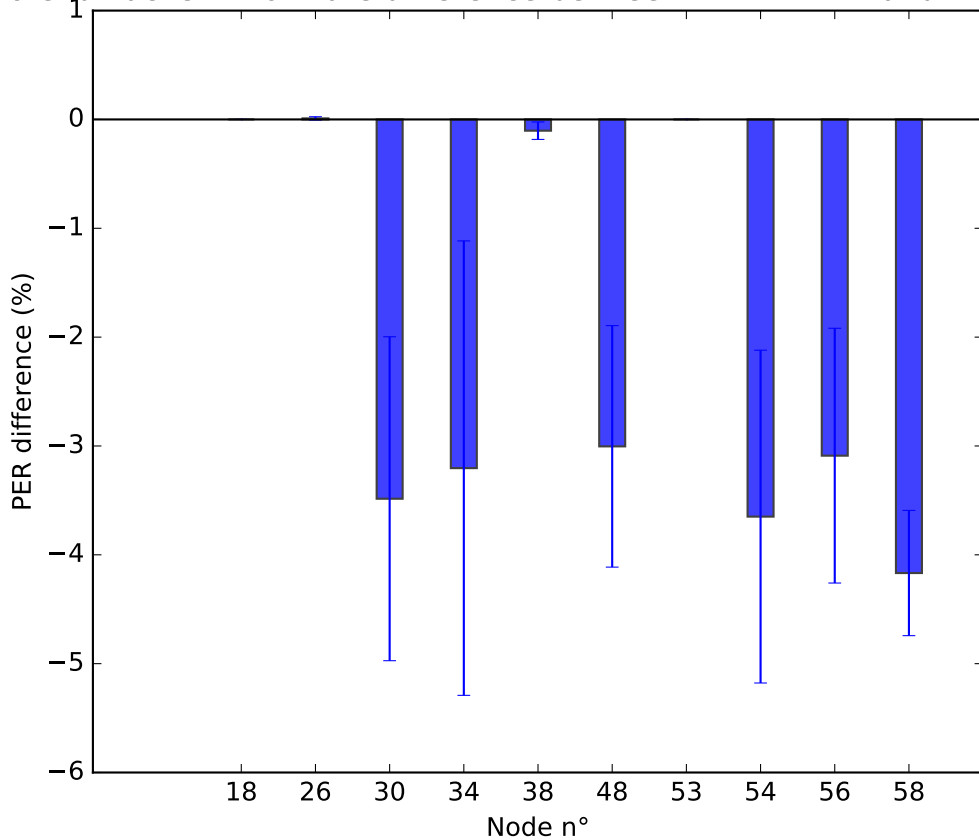

Figure 5.3: End-to-end packet error rate per node

than RPL. But nodes 18, 53, and 58 in Rx have worst results with our proposal. However, this is totally normal. Indeed, nodes 18 and 53 are BR in the network. First, regarding Tx: using RPL, the BR does not send any message in unicast to other node. This means that with RPL the Tx PER of nodes 18 and 53 is 0% (which is perfect). However, when using RPL-NAT-LB, BR redirects nodes by sending DRS in unicast to nodes in the network. The total number of sent DRS is not high (4 if no loss), but as the network is experiencing heavy congestion, those messages are often lost in the way. Thus the BR tries to redirect other node until the load is balanced. As the number of DRS sent and lost are small, the ratio quickly looks astounding when it is really not that bad. Secondly, regarding the BR Rx PER: with our proposal, the congestion stemming from the funneling effect is mitigated. This means in turn that more message travel all the way to the BR, and those need to receive more than when using RPL, which explained the slightly increased error rate. Now regarding the nodes that are not BR. We can see that all nodes except nodes 26 and 38 always have a better Tx PER when using our proposal. For those two, the little to no difference we can see is likely due to the fact that our proposal does not change the links of those, as seen in Figure 5.2. However, when considering Rx PER, the results are not as good. Especially, nodes 56 and 58 have a worst Rx PER with RPL-NAT-LB than with RPL. All other nodes have a better mean Rx PER but the standard deviation shows that it is not the case in all experiences.

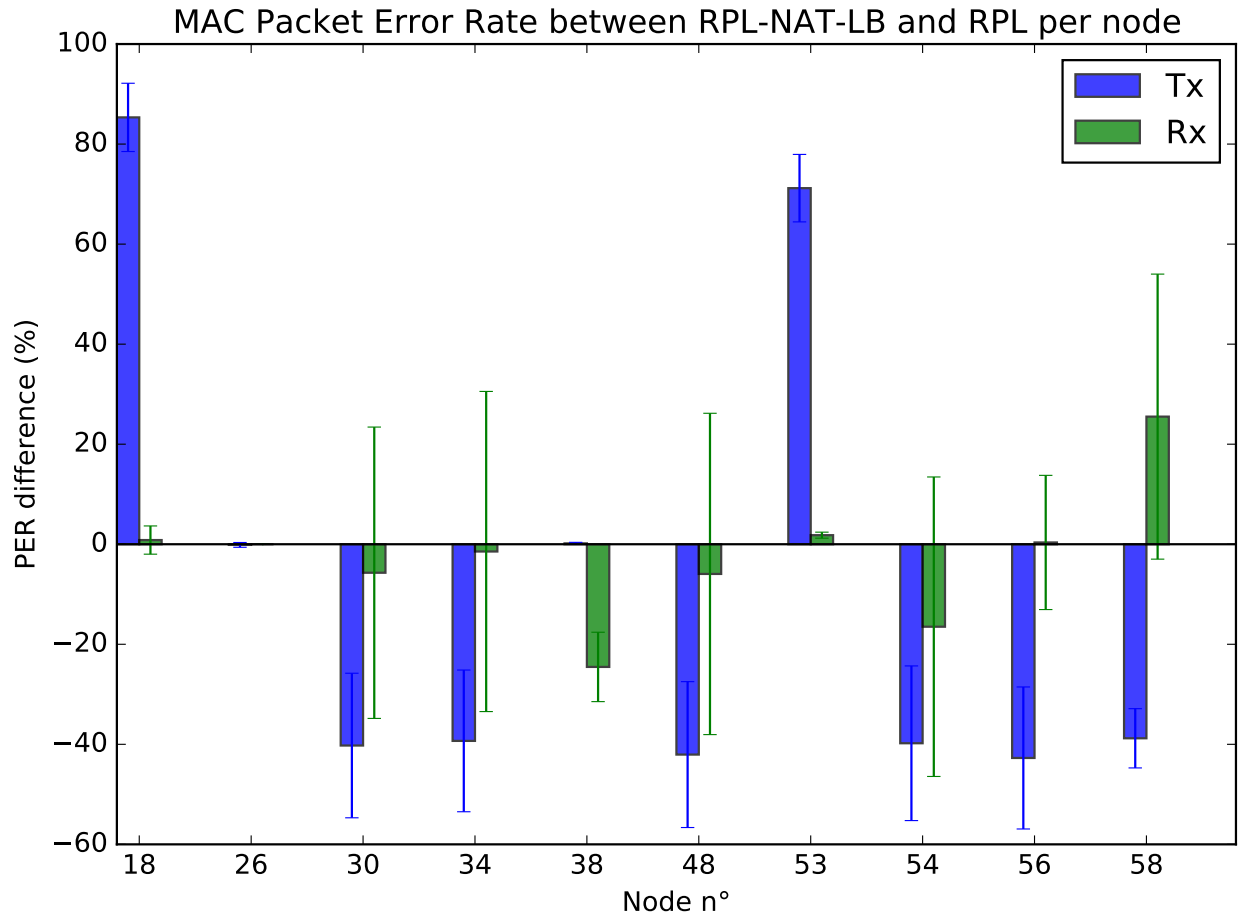

Figure 5.4: MAC packet error rate per node

Our hypothesis is that, due to the contingency of the test environment using a real testbed, and the erratic link quality, the preferred parent of the farther nodes is not always the same. Thus it explains the results obtained for Rx PER, as nodes being the preferred parent from other nodes are more likely to experience Rx errors. From the results, we can infer that node 58 is sometimes the preferred parent of other nodes joining the same instance, but as seen in Figure 5.2 it seems to have a bad link with almost every node except 53. Thus when chosen as a preferred parent, children experience errors and then switch to another parent. The same is likely to be true but at a smaller scale for node 56. What we draw from those results is that our proposal provides better links most of the time, but as the link quality is not considered when a node is redirected, sometimes a node joins the other instance via a parent with a bad link, such as node 58.

5.3.5 MAC errors repartition

We just have seen the MAC PER obtained from our experiences. As it is interesting to know which errors are the more common at MAC level, now we will see the error repartition. Figure 5.5 represents the mean repartition of each state obtained after a transmission, along

with the standard deviation. The left column are the results of RPL, while the column on the right are the results of RPL-NAT-LB. Using CSMA/CA in Contiki as the mac layer, there is only a given amount of possible errors that can happen. If a message is correctly transmitted, received and acknowledged, the transmission is thus valid (Tx OK). When a message is sent, but no acknowledgment (ack) is received back, the transmission is invalid and must be reinitialized (No Ack). If an ack is received, but does not correspond to the latest transmission, there is an ack collision and the message must be sent again (Collision on Ack). Before sending a message, a node listens to the medium. If the medium is busy, a collision state is returned, though there has not been an actual message transmission (Collision before Tx). Finally, if a message is correctly transmitted, the receiver may not be able to forward it because of a full transmission queue. It is thus discarded without any sort of notification (Queue drop). Regarding the results obtained, we can see that all nodes face less transmission errors using our proposal than using RPL. BR nodes 18 and 53 do not have any considerable results, as they only transmit DRS down the DODAG, and no UDP traffic. What may seem odd at first is that the total amount of Tx OK is not the same with RPL-NAT-LB than with RPL. This is due to less duplicate messages being sent, thanks to less total overall errors. Node 26 does not have significantly less transmission errors because our proposal does not act upon anything related to it. Node 38 does not experience less errors either, but it does have a great decrease in its total amount of Tx OK. This is because using RPL, most of the traffic goes through it as seen in Figure 5.2, however when using our proposal as half of nodes are redirected to the BR node 53, about half of the traffic from those nodes does not go through node 38 anymore as a result. Considering all the other nodes, we can notice a significant decrease in the total amount of collision. As our proposal relieves node 38 of half of its children nodes, those children have less risk to transmit at the same time and thus to face collisions. What we can draw from those results is that RPL-NAT-LB balances well the load in the network, which results in less overall transmission errors, as well as less duplicate transmissions. However an unexpected result is that queue drop does not represent a significant amount of the transmission errors recorded, even when decreasing the max size of a queue to only one packet. This may come from the relatively small size of our network.

5.3.6 *Bandwidth repartition*

Our proposal aims to balance the traffic load between BR. By measuring the bandwidth repartition of the goodput (i.e. output without redundancy) between our BR, we can assess the efficiency of our mechanism. Figure 5.6 represents the bandwidth of each BR in bytes per second as a function of time intervals of one second. Only two of our experiments randomly selected (one with RPL, the other with RPL-NAT-LB) are represented here. The black and blue curves respectively correspond to BR node 18 and BR node 53 using RPL, while the red and green curves correspond to the same nodes but using RPL-NAT-LB. First regarding RPL, we can notice that the BR node 53 does not forward any traffic. Indeed, as the BR node 18 starts to build its DODAG a little sooner (60 seconds), all nodes join its DODAG and thus node 18 absorbs all whole traffic from all the 8 other nodes. Therefore, the BR node 18 experiences congestion and this explains why its bandwidth is so large and unstable, as packets are lost or discarded on their path. Next, let's consider the results of our proposal

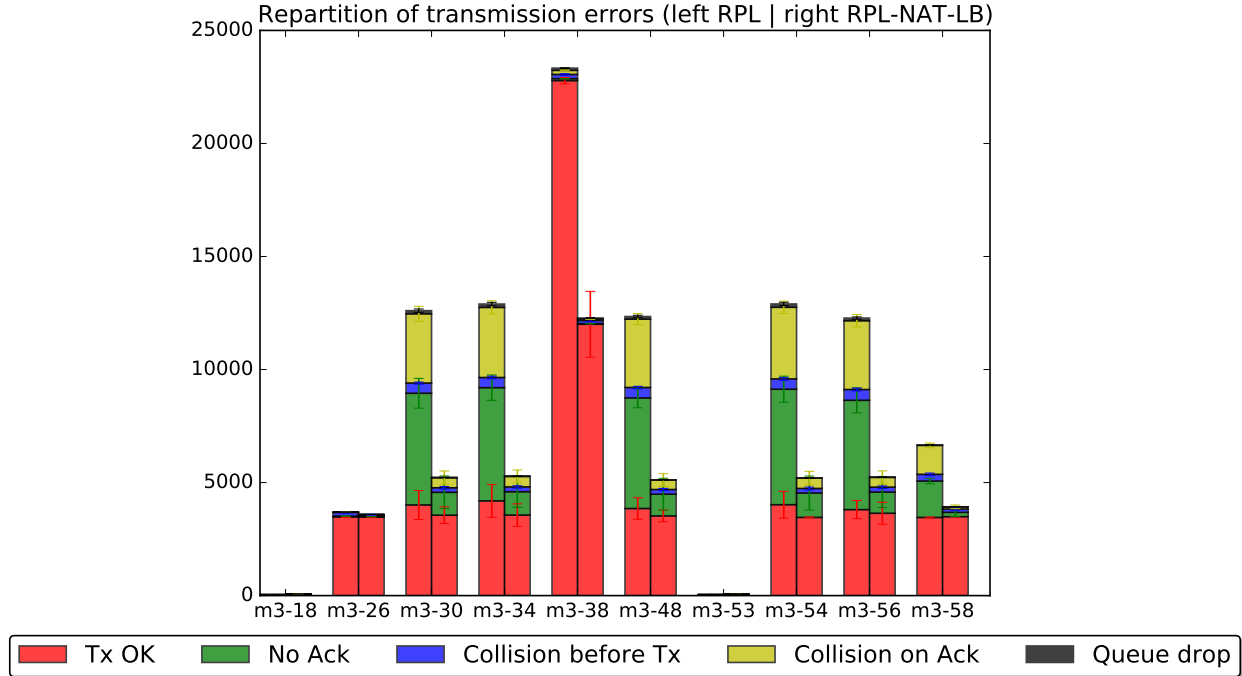

Figure 5.5: MAC errors repartition

RPL-NAT-LB. What we can see within the first 500 seconds of the experiment is the following scenario: BR node 18 wakes up first, at the same time as the 8 other nodes. All nodes join the DODAG and start to transmit UDP data towards an exterior destination. Node 18 is in congestion mode, but it does not know any redirectable node, so it absorbs the traffic for some time, until the BR node 53 wakes up. As node 53 multicast DIO, neighbor nodes indicates that they are redirectable upon DAO transmission. Node 18 then sends a DRS to a first node, around 100 seconds, and a second one to another around 200 seconds. Then around 450 seconds, node 18 redirects a node which is the preferred parent of another one. This way, half of the traffic generator nodes are redirected to the BR node 53. From this point forward, the load is equally balanced between the two BR available in the neighborhood. Other couples of experiences show the same bandwidth repartition, with minor differences, all ending with a stable and equal load repartition between the two BR. What we can draw from those results is that our proposal effectively balance the load between BR as intended.

5.3.7 Battery capacity decrease

Energy is a scarce resource in LLN, thus it is important to consider it when building an LLN routing protocol. IoT-LAB testbed allows us to measure the instant consumption of each M3 motes, thanks to embedded components. For our experiments, we measured the current, voltage and power of each our nodes, with a conversion time (CV) of $140\mu s$ and an averaging mode (AV) of 256. This results in a periodic measure of 71.680ms as given by the equation in 5.2.

$$PM = CT \times AV \times 2 \quad (5.2)$$

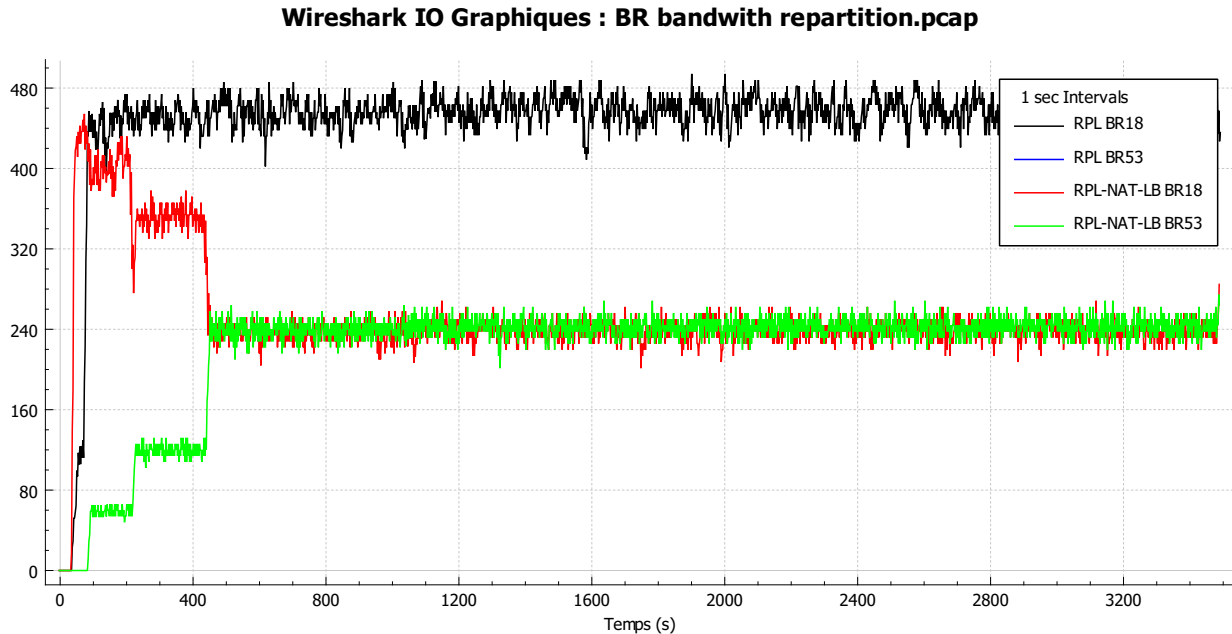

Figure 5.6: Bandwidth repartition

Figure 5.7 represents the mean capacity decrease of a fictive battery for each node in our network, either using RPL or RPL-NAT-LB. Standard deviation was not represented because it was really small as well as for readability purpose. The obtained results are somewhat disappointing. We expected a decrease in energy consumption on the majority of nodes, especially on those of which our proposal help to relieve a great quantity of traffic load (e.g. node 38, cf. Figure 5.5). Instead, what we see is a small increase in energy consumption for all nodes, moreover the increase of energy consumption of the node 38 is higher than other nodes. Those results may come from an increase in energy consumption spent on computation, but in any way the energy savings from reduced wireless retransmission should outmatch this. The possibility of an error in measurement is plausible too. Anyway, from those results, we can draw out that our proposal cost a little more energy consumption than RPL.

5.3.8 Total transmission of control messages

Control messages are used by a routing protocol to build and maintain its routes. Even if those are essential to the operations of the protocol, they represent additional traffic introduced in the network with no direct use to the final user as they do not carry data traveling further up than the network layer. A good routing protocol should therefore use control messages sparingly. Thus, Figure 5.8 represent the mean total number of control messages used either by RPL or RPL-NAT-LB during a whole experiment, along with the standard deviation. The total number of control messages includes all DIO, DAO, DIS and DRS sent by all nodes, in unicast as well as multicast. DIO are sent regularly in multicast based on the Trickle Timer to advertise the DODAG a node is part of, and a unicast DIO is sent upon reception of an unicast DIS. DAO are sent regularly in unicast from a node advertising itself

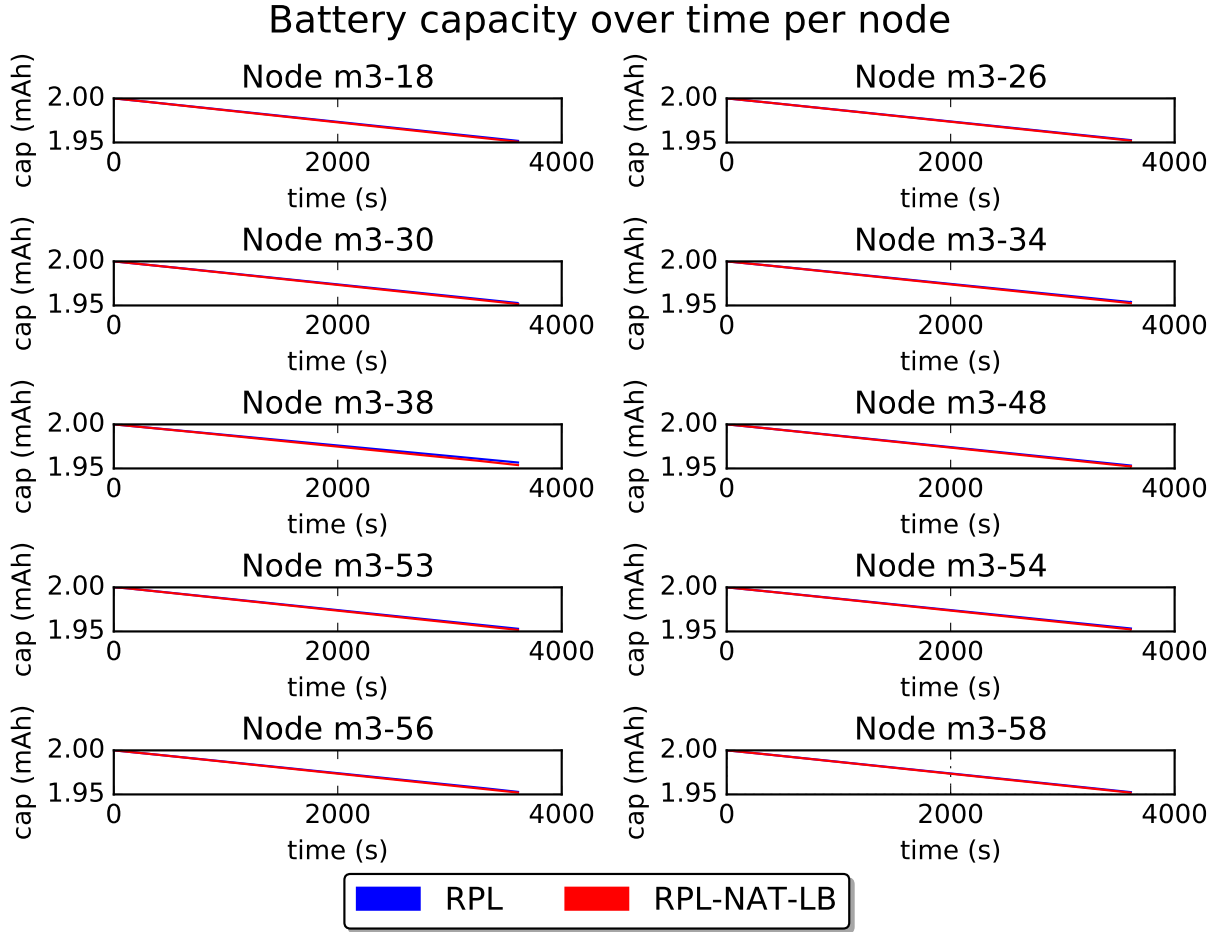

Figure 5.7: Battery capacity decrease

to its preferred parent which forwards it. DIS are sent to request immediate DIO transmission, by a node searching for a DODAG to join. DRS are RPL-NAT-LB exclusive messages sent by a BR to a node that must redirect by joining a different instance. Regarding the DIO first, we can see that usually RPL-NAT-LB uses less messages than RPL. This is most likely due to the fact that, as links are better and the load is distributed better, nodes have less difficulties to join and participate in the network. Nodes do not need to change preferred parent as often with RPL-NAT-LB than with RPL. As a result, the whole network is more stable, and thus there is less DIO total DIO sent. Next for the DAO, there seems to be no significant difference between the amount of messages used by RPL-NAT-LB and RPL. Finally concerning DIS and DRS, RPL-NAT-LB uses more of both. About the DRS, this is obvious because this is a type a message that we introduced in RPL-NAT-LB, and thus does not exists within classic RPL. For the DIS, this was expected as well, because in RPL-NAT-LB, nodes redirected send a unicast DIS the to best retained potential parent of another instance in order to request a fresh DIO transmission. Therefore an increase in DIS transmission is totally normal. What we can draw out from those results is that RPL-NAT-LB seems to build a more stable network than RPL in our scenario, at the modest price of some DIS and DRS while reducing the number of DIO.

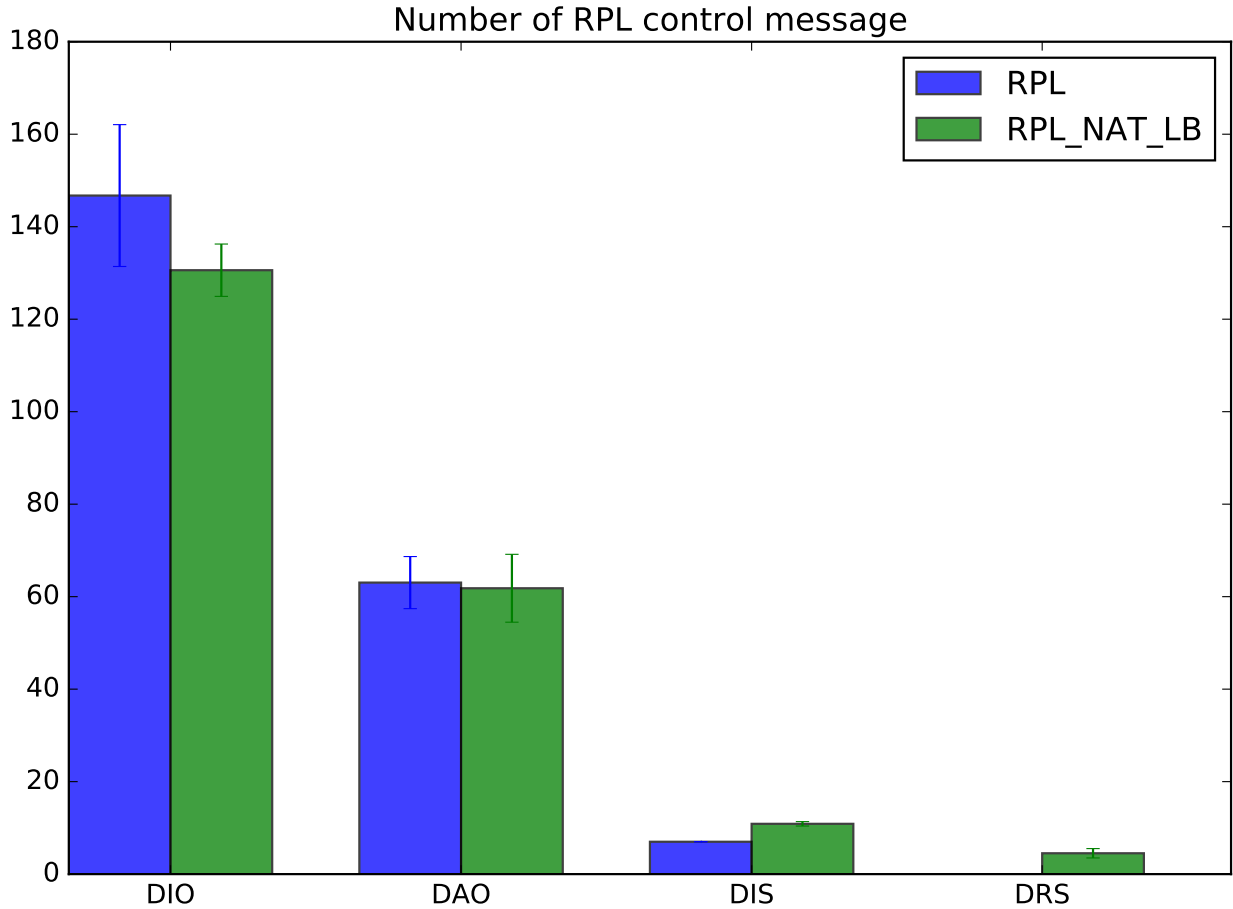

Figure 5.8: Total transmission of control messages

In this chapter we have seen the experimental setup under which we have compared our proposal and RPL. We have presented results obtained on a real testbed for RPL-NAT-LB and RPL. What we can conclude from those is that RPL-NAT-LB provide some significantly better performance, while not being satisfactory under every aspect, especially regarding the energy consumption of the nodes. In the next chapter we will discuss about the future work that could be conducted to improve our proposal, and we will conclude this thesis.

We have thoroughly presented our contribution, RPL-NAT-LB, in the previous chapters of this document. This final chapter summarizes the advantages that our contribution offers. We will also discuss the conducted work as well as what could be improved in future works.

6.1 CONTRIBUTION

The IoT is made of constrained objects with wireless communication capabilities connected between themselves and to the Internet. Because of many constraints that are not faced in classic IP networks, IoT devices need a dedicated protocol suite. IPv6 is used as network layer for IoT devices, and the standard routing protocol is known as RPL. RPL is a proactive intra-domain distance-vector routing protocol, and it builds a DODAG to connect nodes. Because a DODAG is rooted at a single node which acts as a border router, a RPL network facing border router failure would be disconnected from the Internet. Furthermore, the funneling effect inherent to the shape of a DODAG may induce heavy congestion and energy depletion inequality among nodes. A common answer to those issues may be to introduce border router redundancy in RPL networks, as this would relieve the single point of failure that is a single BR and may as well balance the traffic load between nodes.

Therefore, in this thesis we proposed a full solution to support border router redundancy to mitigate the effects of those issues. Our contribution is divided in three parts. First, the use of a virtual DODAG root allows several border router to be part of the same unique DODAG, by synchronizing DODAG parameters disseminated by those border router to make them look as if they were one unique border router. This introduces border router redundancy in the network, as upon one border router failure, the others would seamlessly retrieve the orphan nodes. Secondly, we proposed to adapt the well known NAT mechanism to enable RPL networks cooperation. Indeed, different networks may use different IPv6 prefixes which would prevent different networks to communicate at a routing protocol level. Furthermore, upon border router failure orphan nodes could join a neighbor RPL network but should change their IPv6 address to the new prefix, terminating ongoing communication with remote hosts. The NAT protocol allows us to distribute one unique prefix into all different RPL networks, while the border router translates addresses using its dedicated prefix when messages are forwarded outside of the LLN. Finally, we specified an explicit redirection mechanism to balance the load in the network. A border router enters congestion mode when a trigger is set off (e.g. number of nodes in sub-DODAG threshold). As each border router maintains a different RPL instance, a congested border router tries to redirect nodes from its sub-DODAG to the sub-DODAG of a neighbor border router. Nodes that overhear DIO transmission from another instance are redirectable, and upon reception of a new control message known as DRS, a redirectable node must switch instance to join the neighbor sub-DODAG.

6.2 DISCUSSION

Our proposal RPL-NAT-LB was implemented under the IoT operating system Contiki OS. We assessed the efficiency of our mechanism by conducting experiments on a real testbed known as FIT/IoT-LAB. Under a controlled scenario and network layout, our contribution provides overall better results than RPL. The end-to-end and MAC delivery ratio is improved thanks to less errors on the link layer. The bandwidth is equally shared between the border routers, and the cost in terms of control messages is more or less the same than RPL. Regarding the energy consumption, even if the obtained results do not match our expectations, the increased cost in energy is not significantly higher. However, the MAC reception delivery ratio seems to be highly unstable. This is likely due to the fact we did not sufficiently take into account the link quality a redirectable node has with a neighbor node from another instance. Thus nodes may be redirected to use a bad link without being able to find a better preferred parent in its neighborhood. Furthermore, the results presented in this thesis only concern a given favorable network layout. Even though the results are not detailed in this document, we tested our proposal under random topologies using the whole set of M3 motes available. The outcome was not stable, highly depending on the link quality from the redirected node to its new preferred parent.

6.3 PERSPECTIVES

Thus, the first expected part of our future lines of questioning will be to find a way to assess the quality of a new link before redirecting a node. Only nodes with better or equal link quality to a neighbor node from another instance should be redirected. This shall stabilize the jitter of the MAC reception delivery ratio, as well as the results obtained with random topologies. Therefore another part of our future research shall be to evaluate thoroughly our proposal with a larger number of nodes as well as random node topologies and random border routers placement, to fully assess the efficiency of our mechanism under various conditions. Finally one of our main future works will be to understand the counter intuitive results obtained considering the energy consumption of the nodes, locate the issue and resolve it.

6.4 PERSONAL REVIEW

I will end this thesis on a more personal note. Throughout my internship, I have discovered and learned many concepts and acquired knowledge about wireless networks. I had also the time to improve my abilities regarding understanding and writing scientific reports. Going through the full research modus operandi (state-of-the-art, specification, implementation, evaluation, writing), I believe that I have seen a relevant glimpse of the research process in computer science. Maybe most important, I now know that there is still an enormous amount of concepts that I know nothing of but that rouses my curiosity. I want to continue to learn and discover, and this is the reason why I will pursue in research with a PhD on a related subject.

BIBLIOGRAPHY

- [1] *ICube laboratory website*. URL: <https://icube.unistra.fr/en/> (visited on 07/21/2018).
- [2] *Network reseach group website*. URL: <http://icube-reseaux.unistra.fr/en/index.php/Home> (visited on 07/21/2018).
- [3] *FIT-IoT website*. URL: <https://fit-equipex.fr/> (visited on 07/21/2018).
- [4] Dave Evans. *The Internet of Things - How the Next Evolution of the Internet Is Changing Everything*. Tech. rep. Cisco - Internet of Things Group, April 2011.
- [5] S. Plancoulaine, A. Bachir, and D. Barthel. *WSN Node Energy Dissipation*. Tech. rep. France Telecom R&D, July 2006.
- [6] Abdelmalik Bachir et al. "MAC essentials for wireless sensor networks". In: *IEEE Communications Surveys & Tutorials* 12.2 (2010), pp. 222–248.
- [7] *IEEE 802.15.4 - IEEE Standard for Low-Rate Wireless Networks (2015 revision)*. URL: <https://standards.ieee.org/findstds/standard/802.15.4-2015.html> (visited on 07/21/2018).
- [8] S. Deering and R. Hinden. *Internet Protocol, Version 6 (IPv6) Specification*. STD 86. July 2017.
- [9] G. Montenegro et al. *Transmission of IPv6 Packets over IEEE 802.15.4 Networks*. RFC 4944. Sept. 2007.
- [10] Z. Shelby, K. Hartke, and C. Bormann. *The Constrained Application Protocol (CoAP)*. RFC 7252. June 2014.
- [11] T. Winter et al. *RPL: IPv6 Routing Protocol for Low-Power and Lossy Networks*. RFC 6550. Mar. 2012.
- [12] J. Martocci et al. *Building Automation Routing Requirements in Low-Power and Lossy Networks*. RFC 5867. June 2010.
- [13] A. Brandt, J. Buron, and G. Porcu. *Home Automation Routing Requirements in Low-Power and Lossy Networks*. RFC 5826. Apr. 2010.
- [14] K. Pister et al. *Industrial Routing Requirements in Low-Power and Lossy Networks*. RFC 5673. Oct. 2009.
- [15] M. Dohler et al. *Routing Requirements for Urban Low-Power and Lossy Networks*. RFC 5548. May 2009.
- [16] Muradha M. N. Adleer. "A Summary Survey on Recent Applications of Wireless Sensor Networks". In: *2013 IEEE Student Conference on Research and Development (SCOReD)*. Dec. 2013, pp. 485–490.
- [17] P. Levis et al. *The Trickle Algorithm*. RFC 6206. Mar. 2011.
- [18] P. Thubert. *Objective Function Zero for the Routing Protocol for Low-Power and Lossy Networks (RPL)*. RFC 6552. Mar. 2012.
- [19] O. Gnawali and P. Levis. *The Minimum Rank with Hysteresis Objective Function*. RFC 6719. Sept. 2012.
- [20] JP. Vasseur et al. *Routing Metrics Used for Path Calculation in Low-Power and Lossy Networks*. RFC 6551. Mar. 2012.

- [21] H. S. Kim et al. “Challenging the IPv6 Routing Protocol for Low-Power and Lossy Networks (RPL): A Survey”. In: *IEEE Communications Surveys Tutorials* 19.4 (Sept. 2017), pp. 2502–2525.
- [22] M. O. Farooq et al. “RPL-based routing protocols for multi-sink wireless sensor networks”. In: *2015 IEEE 11th International Conference on Wireless and Mobile Computing, Networking and Communications (WiMob)*. Oct. 2015, pp. 452–459.
- [23] M. O. Farooq and T. Kunz. “IoT-RF: A routing framework for the Internet of Things”. In: *2017 IEEE 28th Annual International Symposium on Personal, Indoor, and Mobile Radio Communications (PIMRC)*. Oct. 2017, pp. 1–7.
- [24] Khelifi Nesrine et al. “Rescue-Sink: Dynamic sink augmentation for RPL in the Internet of Things”. In: *Transactions on Emerging Telecommunications Technologies* 29.2 (). e3278 ett.3278, e3278.
- [25] Wei Ge et al. “Implementation of multiple border routers for 6LoWPAN with ContikiOS”. In: *2015 International Conference on Information and Communications Technologies (ICT 2015)*. Apr. 2015, pp. 1–6.
- [26] Laurent Deru et al. “Redundant Border Routers for Mission-Critical 6LoWPAN Networks”. In: *Real-World Wireless Sensor Networks*. Ed. by Koen Langendoen et al. Cham: Springer International Publishing, 2014, pp. 195–203. ISBN: 978-3-319-03071-5.
- [27] David Carels et al. “Support of multiple sinks via a virtual root for the RPL routing protocol”. In: *EURASIP Journal on Wireless Communications and Networking* 2014.1 (June 2014), p. 91. ISSN: 1687-1499.
- [28] Quang-Duy Nguyen et al. “RPL Border Router Redundancy in the Internet of Things”. In: *Ad-hoc, Mobile, and Wireless Networks*. Ed. by Nathalie Mitton, Valeria Loscri, and Alexandre Mouradian. Cham: Springer International Publishing, 2016, pp. 202–214. ISBN: 978-3-319-40509-4.
- [29] H. S. Kim et al. “Load Balancing Under Heavy Traffic in RPL Routing Protocol for Low Power and Lossy Networks”. In: *IEEE Transactions on Mobile Computing* 16.4 (Apr. 2017), pp. 964–979. ISSN: 1536-1233.
- [30] M. Ha et al. “Dynamic and Distributed Load Balancing Scheme in Multi-gateway Based 6LoWPAN”. In: *2014 IEEE International Conference on Internet of Things (iThings), and IEEE Green Computing and Communications (GreenCom) and IEEE Cyber, Physical and Social Computing (CPSCom)*. Sept. 2014, pp. 87–94.
- [31] Marc Barcelo et al. “Cooperative interaction among multiple RPL instances in wireless sensor networks”. In: *Computer Communications* 81 (2016), pp. 61–71. ISSN: 0140-3664.
- [32] M. M. Khan et al. “A multi-sink coordination framework for low power and lossy networks”. In: *2016 International Conference on Industrial Informatics and Computer Systems (CIICS)*. Mar. 2016, pp. 1–5.
- [33] Kjeld Borch Egevang and Paul Francis. *The IP Network Address Translator (NAT)*. RFC 1631. May 1994.
- [34] M. Wasserman and F. Baker. *IPv6-to-IPv6 Network Prefix Translation*. RFC 6296. June 2011.
- [35] R. Hinden and B. Haberman. *Unique Local IPv6 Unicast Addresses*. RFC 4193. Oct. 2005.
- [36] Adam Dunkels et al. *Contiki: The Open Source OS for the Internet of Things*. URL: <http://www.contiki-os.org> (visited on 07/21/2018).
- [37] *IoT-LAB website*. URL: <https://www.iot-lab.info/> (visited on 07/21/2018).