



**HAL**  
open science

# The fall of the reentry paradigm of cardiac fibrillation

Guillaume Attuel, Hussein Yahia

► **To cite this version:**

Guillaume Attuel, Hussein Yahia. The fall of the reentry paradigm of cardiac fibrillation. Second international Summer Institute on Network Physiology, Jul 2019, Como, Italy. , 2019. hal-02294891

**HAL Id: hal-02294891**

**<https://inria.hal.science/hal-02294891>**

Submitted on 23 Sep 2019

**HAL** is a multi-disciplinary open access archive for the deposit and dissemination of scientific research documents, whether they are published or not. The documents may come from teaching and research institutions in France or abroad, or from public or private research centers.

L'archive ouverte pluridisciplinaire **HAL**, est destinée au dépôt et à la diffusion de documents scientifiques de niveau recherche, publiés ou non, émanant des établissements d'enseignement et de recherche français ou étrangers, des laboratoires publics ou privés.

## Abstract

Cardiac fibrillation affects the atria or the ventricles and, in both cases, poses major challenges to public health management. Atrial fibrillation is the predominant cause of embolic stroke while ventricular fibrillation leads to sudden cardiac arrest and death. The medical community of cardiac electro-physiologists consider cardiac fibrillation as a disease of known cause, namely a chaotic multiplication of electric pulse reentries, but of unknown trigger. Putative triggers are targeted in an effort to solve this riddle by a combination of safe therapies including anti-arrhythmic drugs and catheter radio-frequency ablation. In two recent works (10.3389/fphys.2017.01139 and 10.3389/fphys.2019.00480), with Evgeniya Gerasimova Françoise Argoul and Alain Arneodo, we have provided evidence and modeling which clash with the accepted wisdom. We give here the main argument for the incompatibility of the electrical activity of fibrillating human hearts, with the reentry paradigm. In the model, pulse dynamics is akin to a random branching birth and death process due to a highly fluctuating conductance. In this respect, we sketch a calculation of the multifractal spectrum for our cardiac modeling, which underlines how the multifractal parameter is related to the variance of the abnormal capacitive electric field at the gap junction channels. Those new observations and modeling raise a number of theoretical and practical possibilities and new challenges, such as electric recording interpretation from the level of cell-to-cell coupling up to the level of neural modulations.

## Gray area

Is atrial fibrillation characterized only by spatio-temporal irregularity of local beat-to-beat cycles?

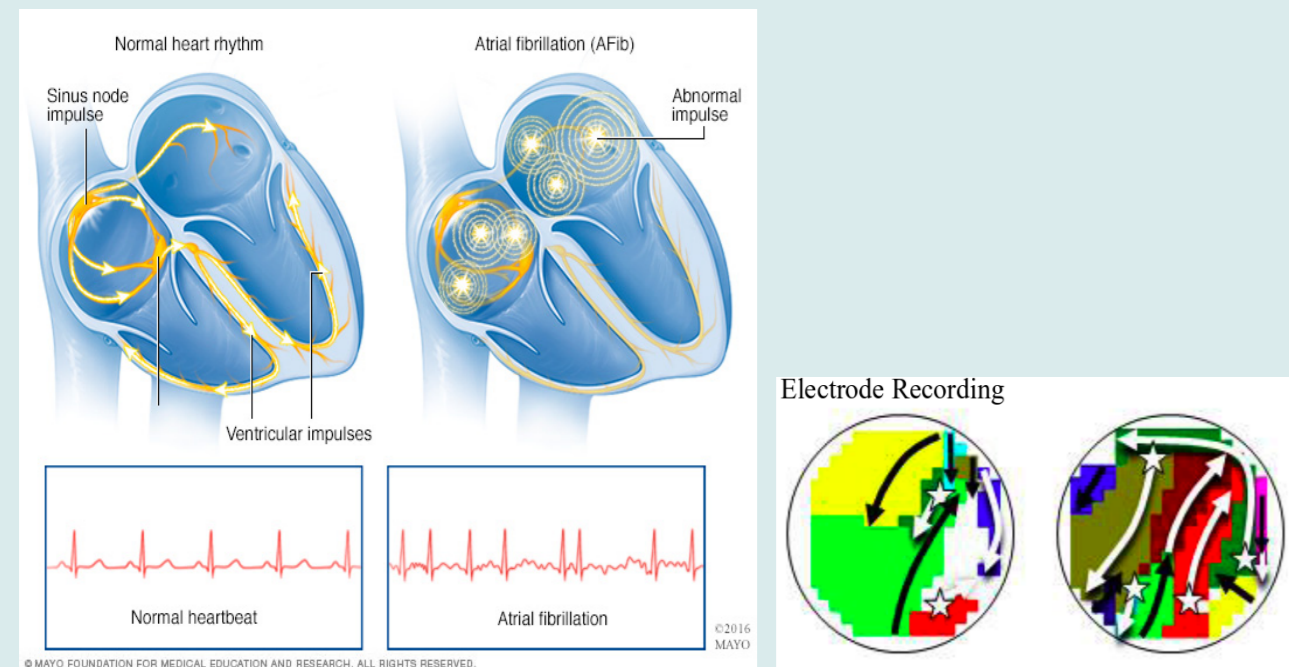

Figure 1: Left: Atrial fibrillation schematic mechanisms. Right: High density mapping of activation times.

► Three sources of complexity at three different scales.

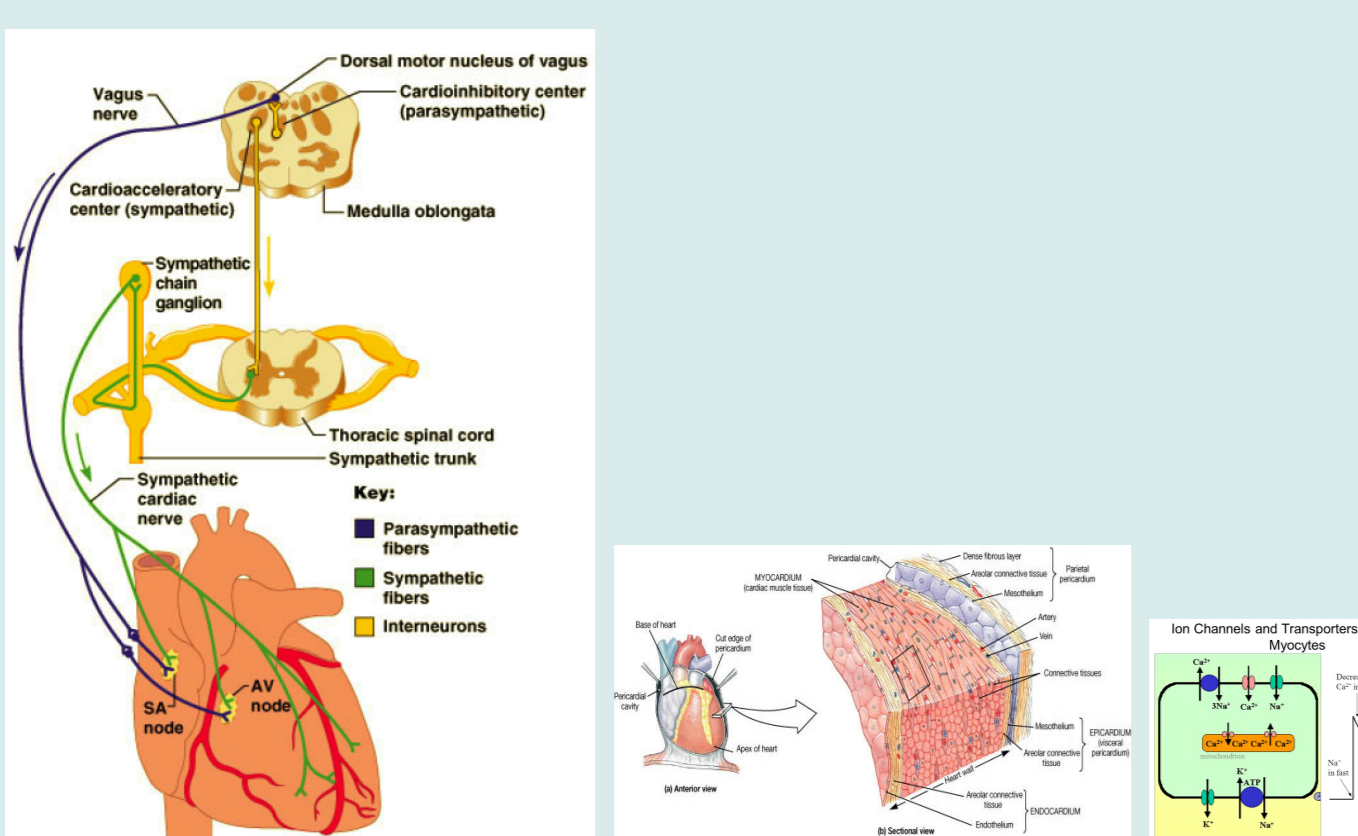

Figure 2: (Left) Nervous modulation affecting rhythm and action potential. (Center) Artist representation of the cardiac tissue. (Right) Ion channels involved in action potential excitation.

This work focuses on the *conducting substrate*.

## Main assumption

Cardiac pulse excitation and propagation

- Relaxation limit cycles: fast and slow time scales.
- Excitable threshold (saddle node bifurcation).
- Refractory state.
- Reaction diffusion with non diffusive inhibitor.

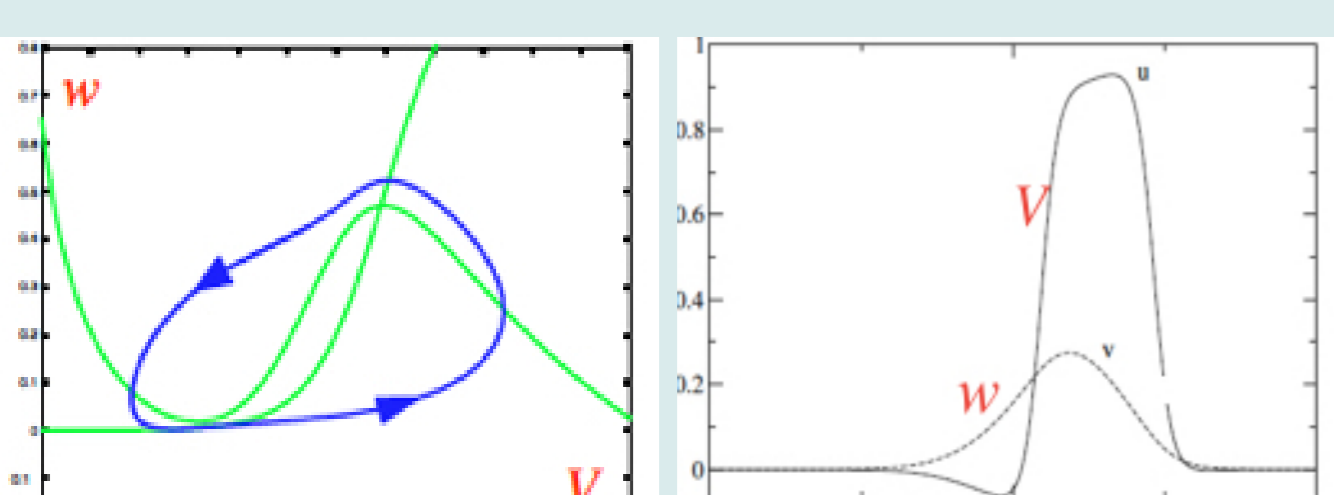

Figure 5: Left: Phase portrait with the two null-clines for the reactant  $v$  and dynamically "slaved" inhibitor  $w$ . The stable-unstable pair of fixed points is located at their intersection on the bottom left. Right: Resulting typical time trace of the propagating pulse.

Pulse:

$$\frac{\partial v}{\partial t} = \mu F(v, w) + \kappa \frac{\partial^2 v}{\partial x^2},$$

$$\frac{\partial w}{\partial t} = G(v, w),$$

- $(F, G)$  are acted upon by modulators such as a cholinergic hormone or an anti-arrhythmic drug.
- Cell-to-cell coupling affects  $\kappa \frac{\partial^2 v}{\partial x^2}$
- Gap junction channels are open pores made of connexins.
- They ensure homeostasis and electrical conduction: the connected substrate of cardiac cells is a *syncytium*.

## Sketch of calculation steps

A quick linear analysis of the instability shows that the growth rate is

$$\omega_i^2 \propto -\delta v_i.$$

This implies that the abnormal current grows like  $\delta j(s) = e^{\omega_i s} \delta j(0)$ . The instability occurs at discrete times  $t_i$  whenever  $\omega_i > 0$  and lasts typically  $\tau_i \sim \tau_r$  where  $\tau_r \approx 100$  ms is the refractory period scale. The phase  $\varphi$  of the pulse train becomes random and *singular* at  $t_i$ . The number of back-scattered pulses along an initially excited pulse is  $N(s) = \frac{1}{2\pi} \int^s \|\delta\varphi\|$  at time  $s$  (in Lagrangian coordinates following the initial pulse) and scales like  $N(s) \sim \ln(s)$  because the phase is a (regularized) 2D random free field. To show this, we write a Lagrangian for the pulse train scalar  $\Psi$  in the form

$$\mathcal{L} = \int \Psi^* (\partial_t + c\partial_x) (\partial_t - c\partial_x) \Psi,$$

where  $c$  is the conduction velocity, then applying a Wick

► What about the significance of large amplitude fluctuations?

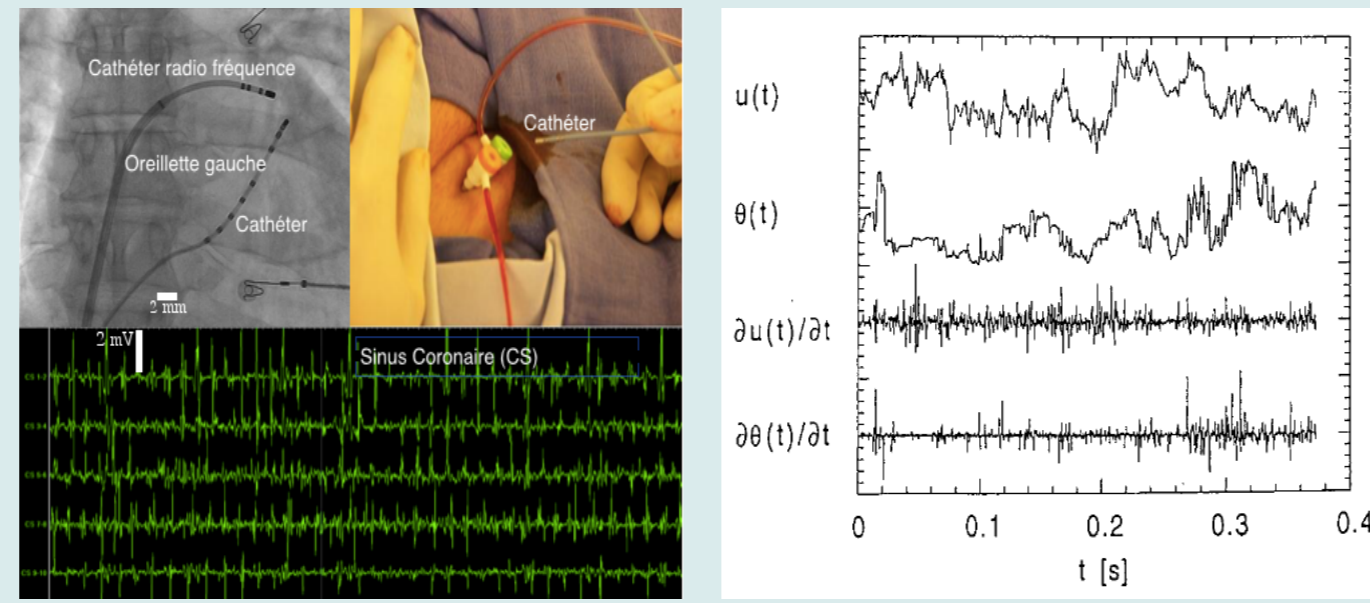

Figure 3: Left : Instance of bipolar potential amplitude increments  $\delta V$  for various nearby points in the atria of one patient. Right: Visual comparison with velocity increments of a turbulent flow.

► Bipolar electrogram PDFs show scaling  $p(\delta V) = \delta V^{-\tau} f(\delta V/\delta V_c)$ , however with non homogeneous scaling exponents  $\tau$ .

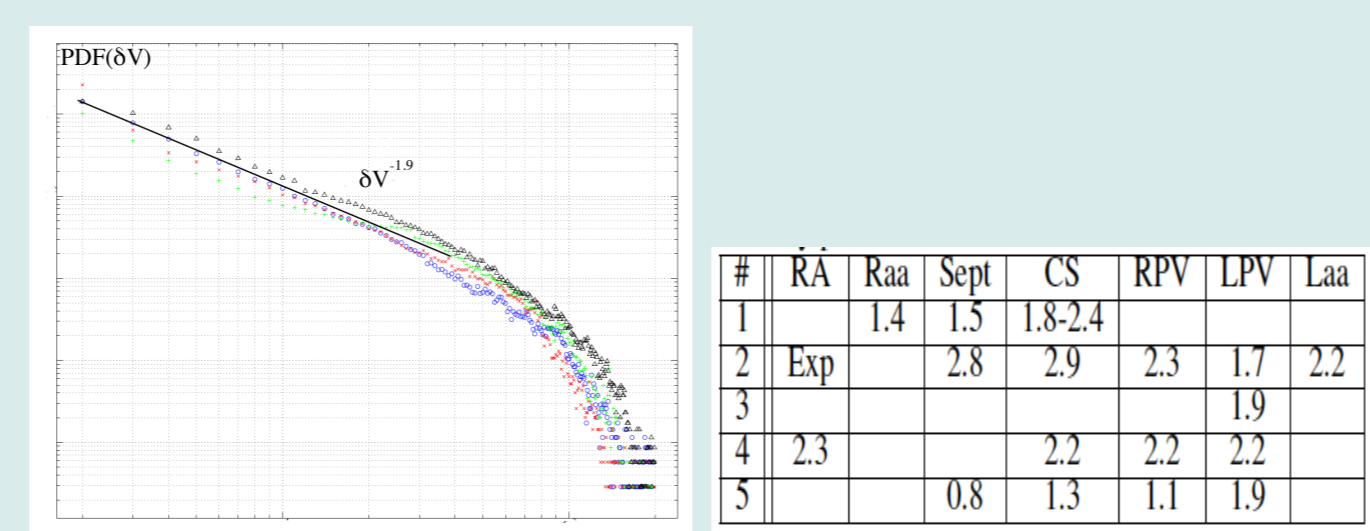

Figure 4: Left: Probability distribution function of bipolar electrogram amplitudes. Right: Table of measured Fisher exponents over various areas of the atria.

► Spatio-temporal irregularity versus self similar amplitude fluctuations : Weak versus Strong turbulence ("intensive" versus "extensive" chaos)?

What if gap junction channels close at wrong timings as pulse are crossing ?

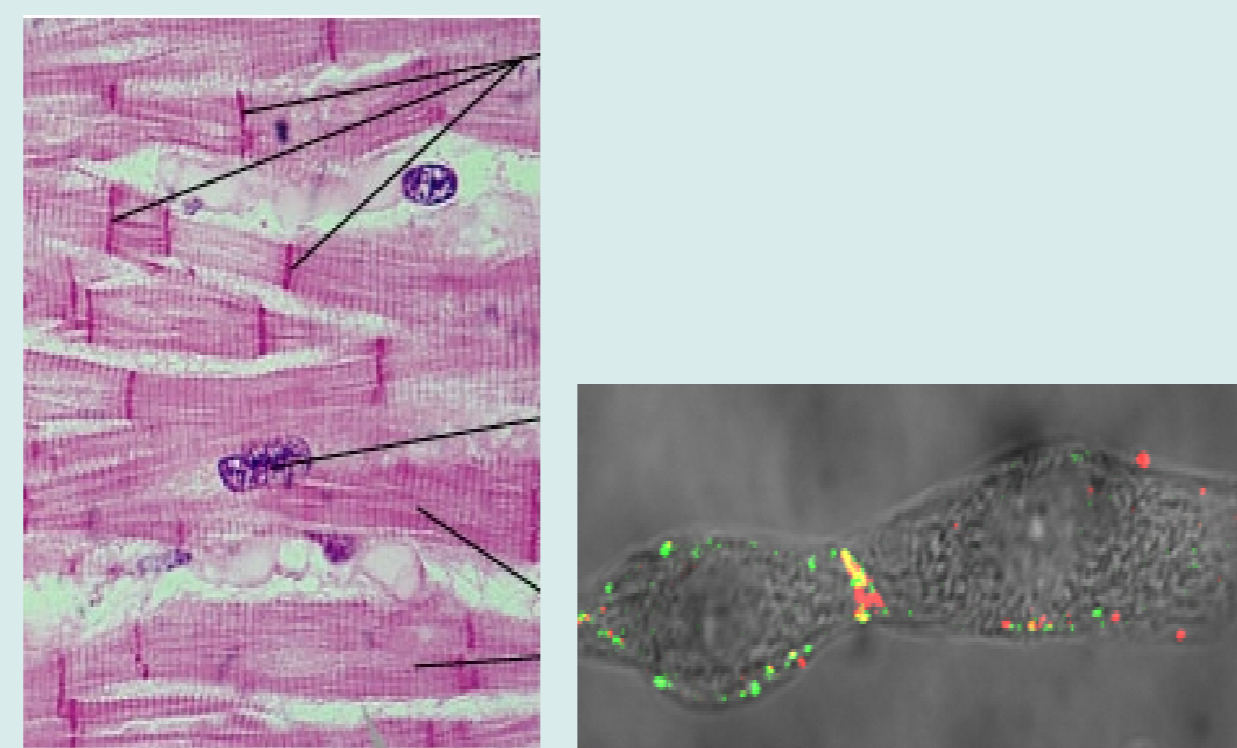
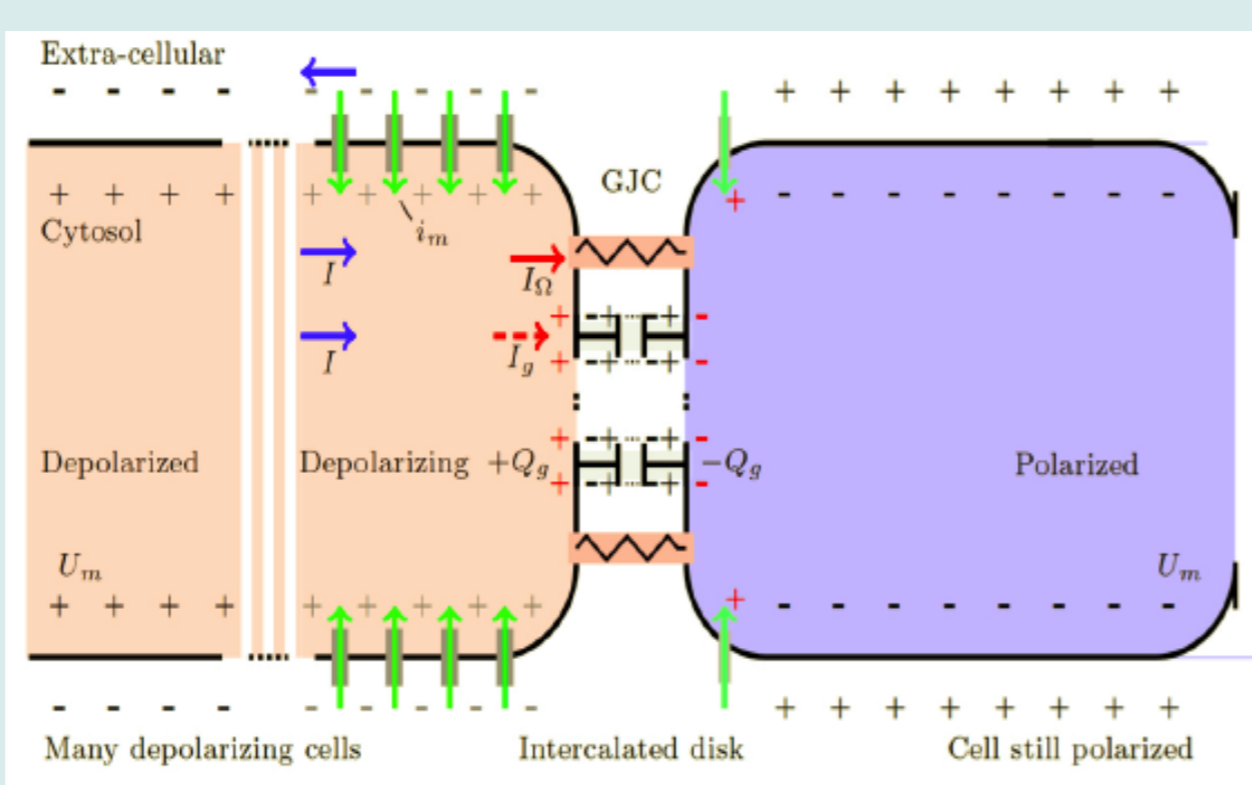

Figure 6: Left: Cardiac tissue microscopy exhibiting intercalated discs (arrows), where GJCs reside. Right: Fluorescopy in a bi-patch clamp setting exhibiting connexins (Cx43 and Cx45).

The answer is that they charge capacitively :



$$\text{Capacitance } \delta Q = C\delta v$$

$$\text{Conductance } J = -G\delta v$$

$$\text{Discharge } C_{\perp} \partial_t v = \text{Pulse} - \delta(G\delta v)$$

Zerth order kinetics dependence on capacitive charge for the abnormally desynchronizing gap junction channels :

$$\partial_t G \propto \delta Q$$

► An *instability* is triggered which leads to *chaotic* conduction and parallel electric field.

rotation  $t \rightarrow it$ . Thus, we have a random variable which behaves in law like:

$$\delta J(a) \sim e^{\sum_i \omega_i \tau_i} \sigma_a$$

where  $\sigma_a$  is a random variable with probability distribution that of initial conditions  $\delta J(0)$ . This is sufficient to obtain the multifractal spectrum where the *micro-canonical* scaling exponents are defined as

$$h = \frac{1}{N} \sum_i \omega_i \tau_i.$$

The multifractal parameter  $c_2$  is directly related to  $\langle \delta v^2 \rangle$ , and is a coupling constant for the phase field, the probability distribution of which is

$$p(\delta\varphi) \sim e^{\frac{1}{c_2} \int \|\delta\varphi\|^2}.$$

## Results

► Experimental and model energy time series exhibit a random multifractal noise nature above the beat-to-beat scale.

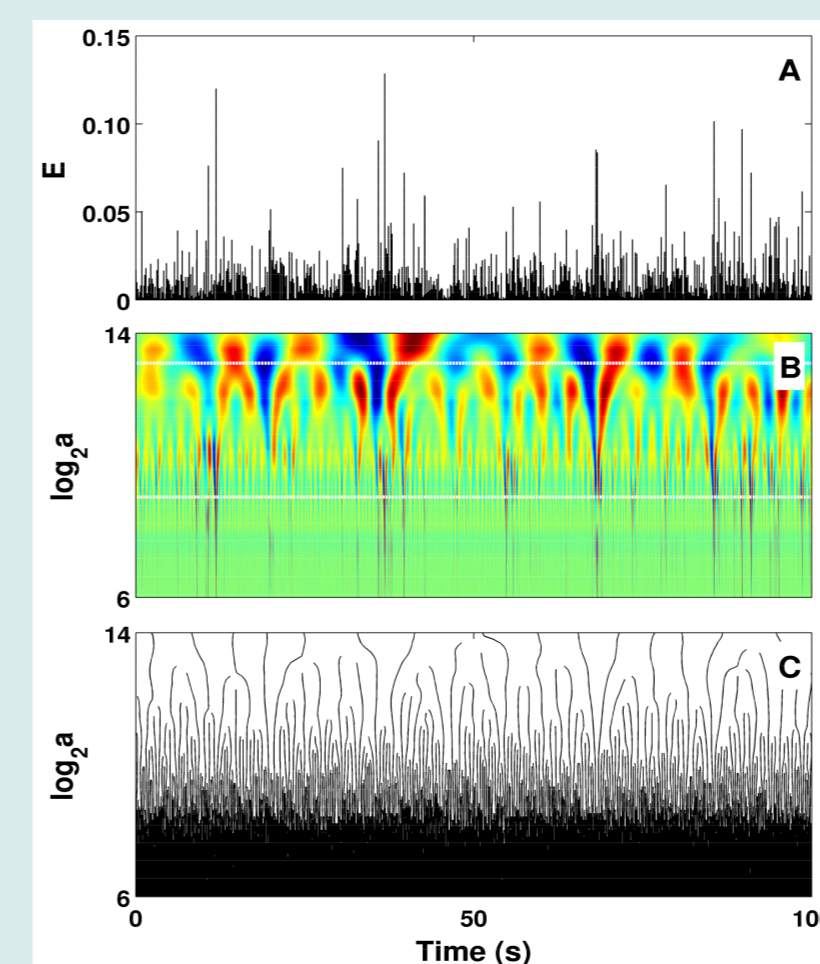

Figure 7: Time series, wavelet scalogram of the energy  $E = (\partial_t \delta V)^2$  computed from the atria, with its maxima skeleton.

► Both multifractal spectra compare remarkably well quantitatively in denervated areas where the geometry is 1+1D.

► The comparison becomes qualitative in an area near the Ligament of Marshall ( $c_2$  is different).

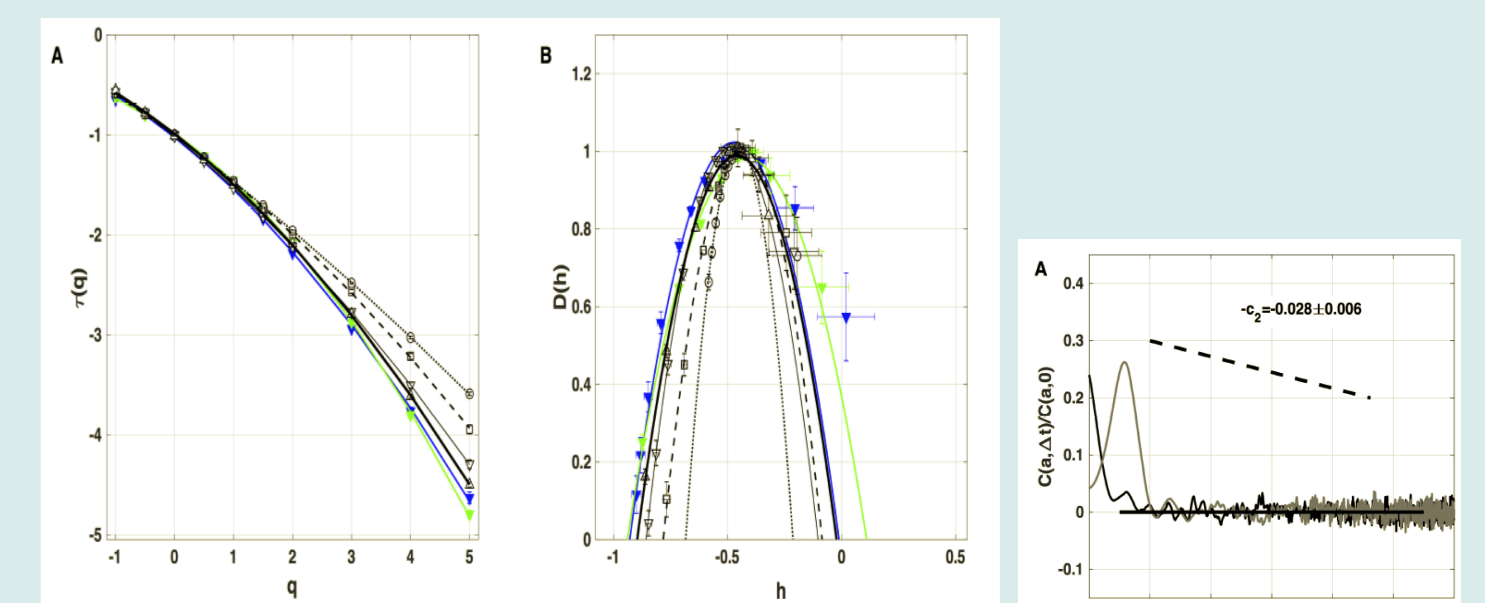

Figure 8: Left: Multifractal spectra for the energy in both experiment and modeling ( $\tau(q)$  and  $D(h)$ ). Right: No two-point correlations of the "volatility"  $\ln|T_\alpha|$ , in which  $T_\alpha$  is a wavelet convolution of the energy at time scale  $\alpha$ .

## Revising the reentry paradigm

The paradigm of fibrillation assumes multiple reentry pathways for cardiac pulses take place. This paradigm is compatible with the highly irregular timely patterns.

- Random defects, which are the spiral wave cores, reset the pulse train phase origins locally.
- A statistical mixture of the phase resetting (hyperbolic) attractor ensues.
- The amplitude distribution is not strongly affected.
- It is well known that atrial fibrillation has a Fourier signature very close to white noise.

However, it fails to properly describe large amplitude fluctuations and multifractal spectra. A truly "infinite" dimensional (non-hyperbolic) attractor is required for log-normal scaling ? What does a multifractal spectrum entails ?

$$\langle \delta_a V^q \rangle \sim a^{\tau(q)}$$

$$\delta_a V \sim \prod_i \Omega_i = \exp\left(\sum_i \omega_i \ln(a)\right)$$

$$h = \frac{1}{N} \sum_i \omega_i$$

$$p(h) = \exp(-N I(h))$$

$$D(h) \equiv I_{convex}(h) = \max_q (qh - \tau(q))$$

- Statistical mixture of scaling  $h$  at any scale  $a$ .
- Ultra-metric distance  $N \sim \ln(\frac{a}{\epsilon})$  (coarse graining  $\epsilon$ ).
- Thermodynamical description by large deviations and Legendre transform.
- Canonical entropy (rate function)  $I_{convex}$  related to Hausdorff dimensions  $D(h)$  of  $h$ -singularity sets.

Theoretical answer (c.f. calculation steps section):

- Look for  $\delta V \sim e^\chi$ , with  $\chi$  a real 2D "Gaussian free field".

## Conclusions

In summary :

- Evidence and modeling beyond paradigm of multiple reentries.
- In particular AF is a multifractal uncorrelated noise.
- Theory indicates an *exponentiation* of a "Gaussian free field".
- Model of abnormal capacitive  $i_g$  builds up at gap junction channels.
- The parallel electric potential gradient  $\delta v$  drives the instability.
- $\langle \delta v^2 \rangle$  determines the multifractal parameter  $c_2$  as a coupling constant for the "free field".
- The free field is the phase of the pulse *train*.
- Randomness of "volatility" comes from *non causal* tree nodes i.e. 1+1D geometry.

Bipolar electrograms result from the convolution of local currents with the electrode  $\Omega_p$  :

$$\delta V(x) = \int \Omega_p(x-x') (i_m(x') - i_g(x')) dx'.$$

- The measured potential is modified from classic theory, involving only membrane currents  $i_m$ , by  $i_g$  !
- **Missing bits** in the interpretation of data in all previous experiments with AF !
- In practice, all this implies a **huge blunder** made with Fourier filtering for ECG Imaging (CardioInsight® and Topera®) !

## Acknowledgment

G. A. dedicates this work to the late Alain Arneodo, to whom he was grateful, in memory of their many discussions and of his friendship.

- $\chi$  is directly related to the phase of pulse trains.
- The exponentiation comes from the instability, which leads to phase defects at *discrete times*.
- The *hierarchical* tree structure results from the logarithmic scaling of  $\chi$ .

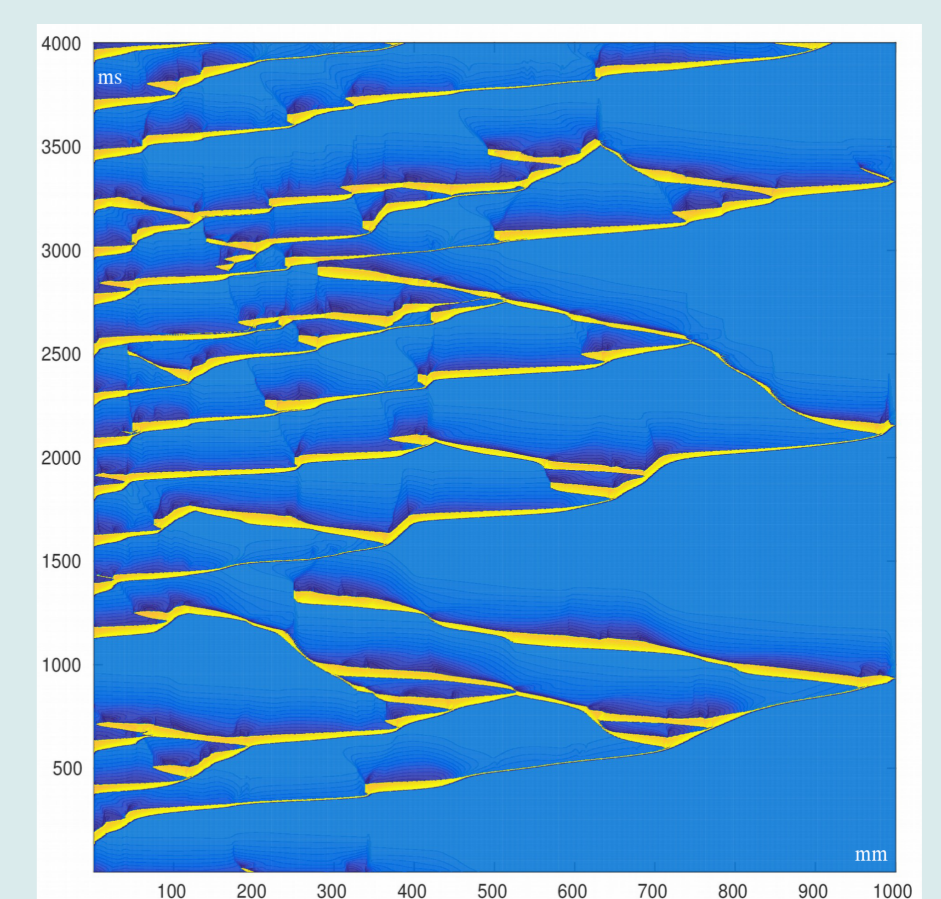

Figure 9: Instance of a spatio-temporal map of pulses in the 1+1D model. The main feature to be noticed is the tree-like structure due to random back-scattered pulses along forward propagating pulses with a high death rate upon collision.

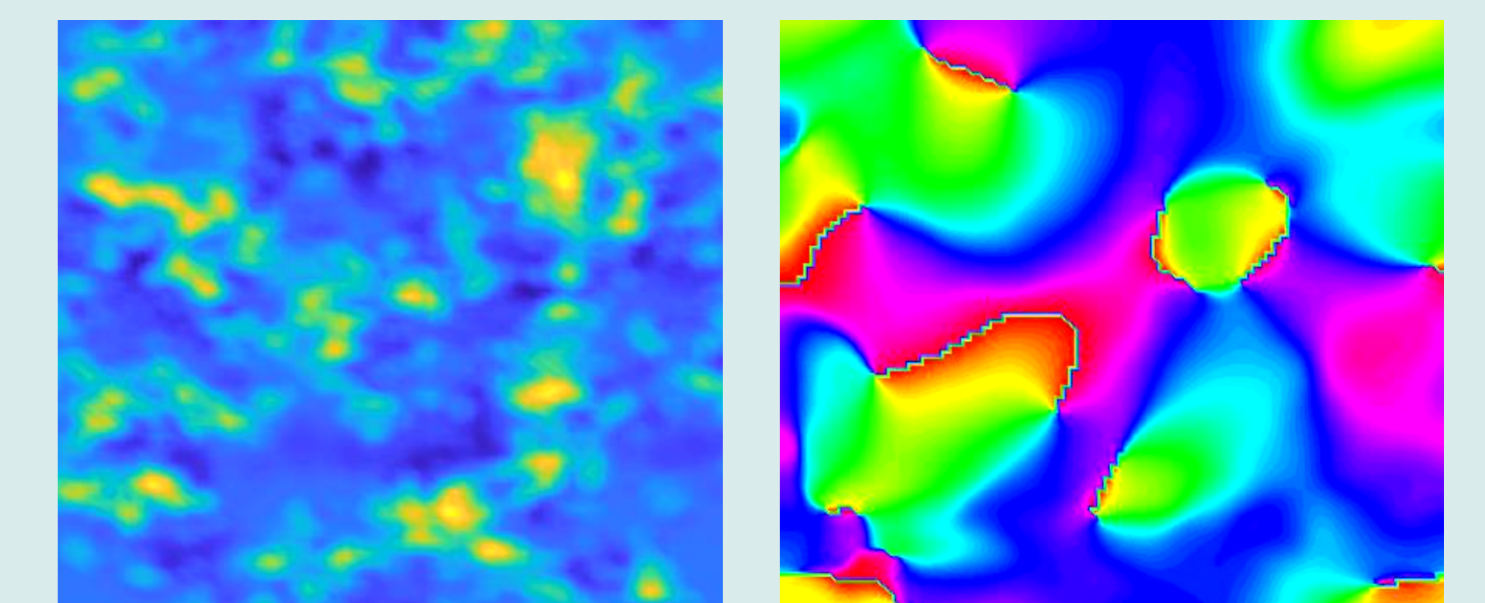

Figure 10: ECGI big blunder. Left: 2D snapshot of a simulation of pulses in the 1+2D model. The noisy nature is apparent upon visual inspection. Right: 2D snapshot of the phase of the Fourier filtered field (0:red,  $\pi$ :blue). ECG imaging assumes to look for multiple reentries and performs Fourier filtering in that respect. However, as it is demonstrated here, it results in artifacts because of the random phase, as "optical" vortices which are here characterized by a rotational circulation everywhere, as opposed to a focal flow for the spiraling pulse train away from the core.

Some open questions :

- Phenomenology related to random branching process in 1+1D modeling.
- Properties of the parallel electric potential gradient  $\delta v$  (in progress).
- Connections with depinning transition and avalanches.
- Higher dimensional network of cells in modeling.
- Adding nervous modulations in modeling.
- Prove  $i_g$  experimentally.
- Find out new drugs acting on  $i_g$ .
- Electrical to structural remodeling (of substrate) in relation to altered transport and fastening of connexins (electro-hydro dynamics) ?

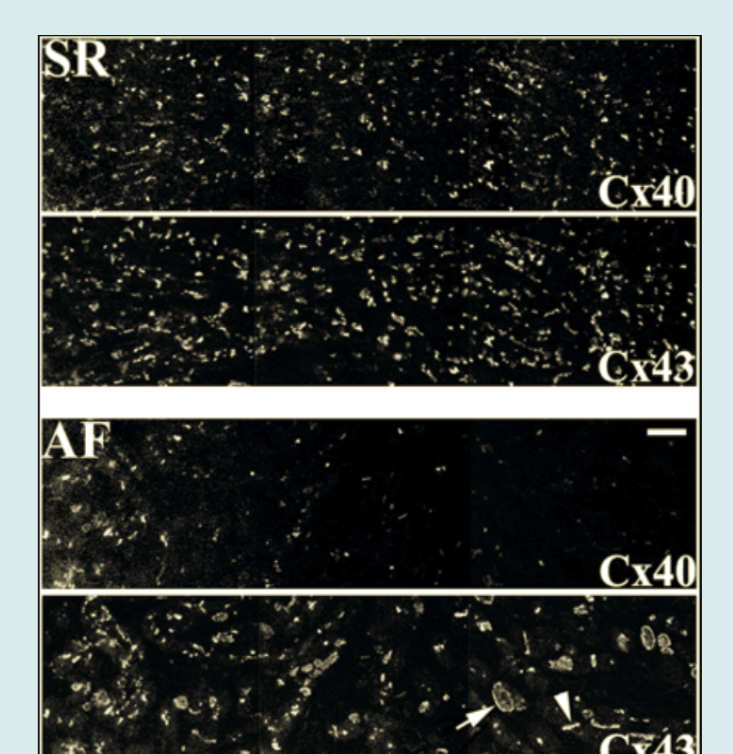

Figure 11: Structural remodeling of substrate : Depletion of connexin expression and fastening at gap junctions after long periods of atrial fibrillation.