



**HAL**  
open science

## A Creative Design Approach Based on TRIZ and Knowledge Fusion

Wei Liu, Run-Hua Tan, Ya-Fan Dong, Guozhong Cao, Limeng Liu

► **To cite this version:**

Wei Liu, Run-Hua Tan, Ya-Fan Dong, Guozhong Cao, Limeng Liu. A Creative Design Approach Based on TRIZ and Knowledge Fusion. 18th TRIZ Future Conference (TFC), Oct 2018, Strasbourg, France. pp.167-179, 10.1007/978-3-030-02456-7\_14 . hal-02279771

**HAL Id: hal-02279771**

**<https://inria.hal.science/hal-02279771>**

Submitted on 5 Sep 2019

**HAL** is a multi-disciplinary open access archive for the deposit and dissemination of scientific research documents, whether they are published or not. The documents may come from teaching and research institutions in France or abroad, or from public or private research centers.

L'archive ouverte pluridisciplinaire **HAL**, est destinée au dépôt et à la diffusion de documents scientifiques de niveau recherche, publiés ou non, émanant des établissements d'enseignement et de recherche français ou étrangers, des laboratoires publics ou privés.



Distributed under a Creative Commons Attribution 4.0 International License

# A Creative Design Approach based on TRIZ and Knowledge Fusion

WEI LIU<sup>1,2</sup> RUNHUA TAN<sup>1,2</sup> YAFAN DONG<sup>1,2</sup> GUOZHONG CAO<sup>1,2</sup> LIMENG LIU<sup>1,2</sup>

<sup>1</sup> Hebei University of Technology, Tianjin 300401, China

<sup>2</sup> National Engineering Research Center for Technological Innovation Method and Tool,  
Tianjin 300401, China  
lncs@springer.com

**Abstract.** Knowledge is an important driving force for creative design. The knowledge fusion, which is formulated by knowledge from different backgrounds, is able to inspire novelty solutions to engineering design. In this paper, a design method is proposed to facilitate knowledge fusion in engineering design based on the theory of inventive problem solving (TRIZ). In order to formulate this method, the mechanism that fosters creative ideas through knowledge fusion is firstly explained, subsequently, approaches that transform the design problems in each of the above-mentioned design stages into TRIZ problems are discussed, since the standard problems in TRIZ can be solved by corresponding TRIZ methods. A design process is therefore formulated by integrating formerly discussed strategies. Moreover, its workability is verified by a case study. The advantages of the proposed method such as the expanding the searchable range of knowledge resource for TRIZ problem solving are discussed in the final section.

**Keywords:** TRIZ, Knowledge Fusion, Creative Design, Design Method

## 1 Introduction

Innovation has been regarded as an imperative for the success of a company under the intensive competition in global market [1]. An obvious characteristic shared by current engineering design is the innovation originated from the information and knowledge of multi-disciplinary backgrounds [2]. Previous studies have claimed that the knowledge-based dynamic capabilities that refers to the ability to acquire, generate and combine internal and external knowledge resources to sense, explore and address environment dynamics [3] has a significant impact on companies' ability to innovate [4]. To facilitate the knowledge implementing in product innovation, study on knowledge management (KM) was carried out with regards to engineering design [5]. However, the KM is not well adopted to innovation in engineering design due to its lack of the mechanisms about how to apply knowledge in innovation from a

systems thinking perspective [6]. Thus, one main objective of this study is to propose a framework to facilitate the systematical implementing of knowledge in innovation.

Knowledge accumulation is the prerequisite for knowledge-based innovation [7]. Current methods from KM are helpful for gathering the appropriate knowledge that meets requirements of design. In terms of KM methods, knowledge fusion works outstandingly by transforming the discrete, relevant knowledge source into a single knowledge unit that inherits the wisdoms from all its contributors [8]. On one hand, knowledge fusion focuses on the technological implementation of the knowledge other than its domain. Thus, the knowledge from multidisciplinary background is clustered through knowledge fusion for solving the defined design problems. There is a finding suggesting the out-domain knowledge is useful for increasing the novelty of design result [9], which supports the idea that knowledge fusion is promising for obtaining creative solutions to engineering design. However, the function of knowledge fusion has very limited workability in practice since the absence of a systematical method for innovation.

This paper proposes a creative design method based on the integration of knowledge fusion and TRIZ in which TRIZ wisely guides knowledge fusion in creative design and knowledge fusion provides inspirations for solving TRIZ problems. Moreover, the design for a new protective shell for isolator is used as a case study to verify the feasibility of the proposed method.

The rest of this paper is organized as follows: Section 2 briefly reviews the relevant studies on knowledge fusion in innovation, integrations of TRIZ and knowledge-based innovation methods and knowledge fusion. Section 3 expresses the strategies and a step-by-step workflow to facilitate the innovation based on TRIZ and knowledge fusion. Section 4 uses a specific design case to stress the feasibility of the method proposed. Section 5 discusses and concludes the advantages and future developing trends of the method at the end.

## **2 Literature review**

### **2.1 Knowledge fusion in product innovation**

Knowledge fusion [10] is firstly proposed to represent knowledge combination from disparate sources in a highly dynamic way. Knowledge inflows from different domains enhance the chance of arising ideas that would not be considered by the designers in a single domain due to their psychological inertia [11]. As a result, cross-links that are initialized by the knowledge fusion often result in "creative leaps" in creative thinking [12]. Technological innovations usually emerge from complex fusion processes that integrate knowledge, technologies and other organizational resources. Therefore, knowledge fusion plays an important role in integrating all of the various knowledge sources for product innovation.

A typical knowledge fusion management system usually encompasses at least four parts [13] to support technological innovation, to name them respectively: acquiring knowledge, fusion knowledge with resources, executing projects and assessing the performance of results. As a consequence, with a feasible management approach,

knowledge fusion especially that is formulated by outside domain knowledge have potential for bringing about "destructive technology" and propelling the innovation. In information era, the development of computer science and big data is reshaping the background of knowledge fusion. Nowadays, it is easy to accumulate a large amount of knowledge from various fields for technological innovations. However, the explosion of knowledge in turns can hinder the innovation results partially due to the lack of systematic approach for processing the huge amount of collected knowledge.

Regarding the development stage of management for knowledge fusion, the existing methods such as the repository for cross-domains knowledge, searching approaches are mainly belong to the section of "knowledge acquiring". A more sophisticated version of knowledge management still requires the sub-sections as "fusion knowledge with resources", "executing projects "and "assessing the performance of results". Therefore, a part of this research is to propose feasible strategies to provide the required parts in current knowledge fusion management.

## **2.2 TRIZ in knowledge-based innovation**

TRIZ, a Russian acronym, translated into English as "Theory of Inventive Problem Solving (TIPS)" was introduced by Altshuller in the mid-1940s [14]. The philosophy of TRIZ is built on five key elements: ideality, functionality, resources, contradiction, and evolution. With a well-established tools system, TRIZ provides designers with strategic and pattern-based guidelines to solve innovative problems.

Within TRIZ framework, knowledge for innovation can be expressed, preserved, accessed and exploited by its users from any perspectives. By holding a series of tools, TRIZ enables its integration with other methods such knowledge management and plays an increasingly important role in knowledge-based innovation. The tools of TRIZ such as invention principles are usually applied to find the appropriate knowledge for ideation [11]. There is a study proposed a modified TRIZ technical system ontology by linking TRIZ problem solving to knowledge retrieval process, in which a document processor helps knowledge-based innovation regardless of users' experience [15]. A previous study also revealed that the application of TRIZ in multidisciplinary teams can boost the problem solving by providing generic models to communicate the knowledge among team members [16].

From the discussion above, it is evident that TRIZ has potential to merge with the knowledge-based innovation. Moreover, interactions between TRIZ and knowledge-based innovation enhances their practical usability since knowledge-based innovation approaches bring about the inspiring for solving TRIZ problems, in turns TRIZ directs the technological implementation of knowledge.

## **2.3 TRIZ and knowledge fusion**

Knowledge fusion is a process through which individual knowledge and group knowledge from many sources are fused and integrated with other knowledge sources to generate technological innovations [17]. Combination of knowledge from different sources has the potential to generate new kinds of technology, which can make a breakthrough in the technology development [18]. TRIZ has the potential to facilitate the innovations through knowledge fusion, since its systematic approach to solve the inventive problems. There are attempts [19, 20] to apply the TRIZ to process the

patent data from different backgrounds to inspire innovations. Besides patent knowledge, biological knowledge is another issue that has attracted the interest from the domain to incorporate in TRIZ problem solving, such as Bio-TRIZ [21] and efforts made to integrate TRIZ and biomimetics [22]. The study has a promising prospect when it provides a general approach to integrate TRIZ with the knowledge from different sources including patents and biology to generate creative ideas.

### 3 Methodology

This section explains the framework of the proposed method from two aspects: design strategies for the integration between TRIZ and knowledge fusion, the design workflow based on raised strategies.

#### 3.1 Strategies to facilitate TRIZ in knowledge fusion

**Prototype integrates TRIZ and knowledge fusion.** The attempts to integrate TRIZ and knowledge fusion boost the innovative problems solving since knowledge fusion can enhance TRIZ by providing knowledge that meet the design requirements. A prototype in Fig.1 illustrates a modified TRIZ problem solving process by incorporating knowledge fusion.

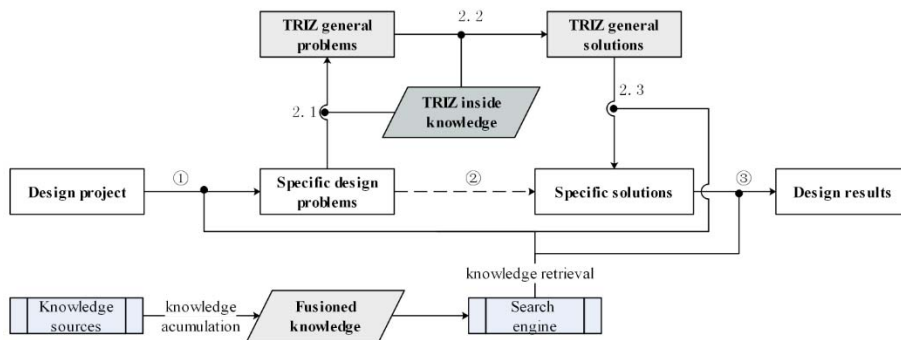

**Fig.1. A prototype for a modified TRIZ process integrated with knowledge fusion**

Refers to Fig1, there are three phases in knowledge fusion driving innovation:

design problem decomposing and analyzing; problem resolving; solution evaluation. Besides these phases, knowledge accumulation and knowledge retrieval are indispensable for fostering innovation through knowledge fusion.

The prototype has incorporated TRIZ problem solving process in phase problem resolving with three specific steps:

- 2.1 transferring to standard TRIZ problems;
- 2.2 choosing the appropriate TRIZ methods to solve the defined TRIZ problems;
- 2.3 mapping from TRIZ standard solutions to specific solutions.

In the prototype, the step 2.3 is the most difficult part in TRIZ problem solving especially for TRIZ beginners since it largely depends on designers' professional knowledge and experience. With the integration of knowledge fusion, the proposed prototype improves the status quo by providing abundant knowledge for mapping the TRIZ standard solutions to specific solutions.

In order to gain the complete design process, there are four important problems should be solved beforehand, to name them respectively:

The first is "how to apply the knowledge fusion in decomposing and analyzing the design problems?"

The second is "how to transfer and resolve the specifically defined design problems by TRIZ?"

The third is "how to apply knowledge fusion to facilitate the mapping from TRIZ standard solutions to specific design solutions? "

The fourth is "what is suitable evaluating strategy for combining the specific solutions to formulate a final design results?"

The answers to these four problems formulate the innovation strategies to facilitate the integration of TRIZ and knowledge fusion innovation.

**A fuzzy front analysis based on knowledge fusion.** The answer to the first problem lies in a fuzzy front analysis method for design project, since it clearly defines design problem at the beginning of design project.

In this paper, the fuzzy front analysis depends on the knowledge from both inside and outside TRIZ.

For inside TRIZ knowledge, theory of technological evolution can indicate the improving opportunities for the design project of interest by analyzing the current products and patents from relevant domains.

The design knowledge accumulation method such as Web-based patent search engine is able to provide the references from knowledge outside TRIZ about current design status. The knowledge outside TRIZ reveal the current technological solutions in related domains, which can be matched for their corresponding stages in certain evolution routes and laws.

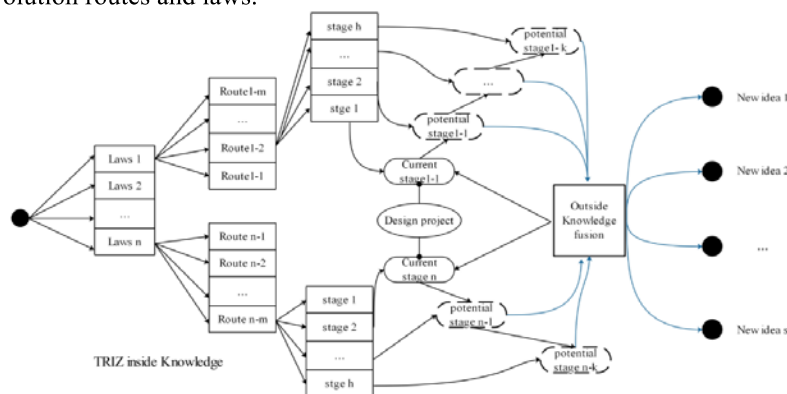
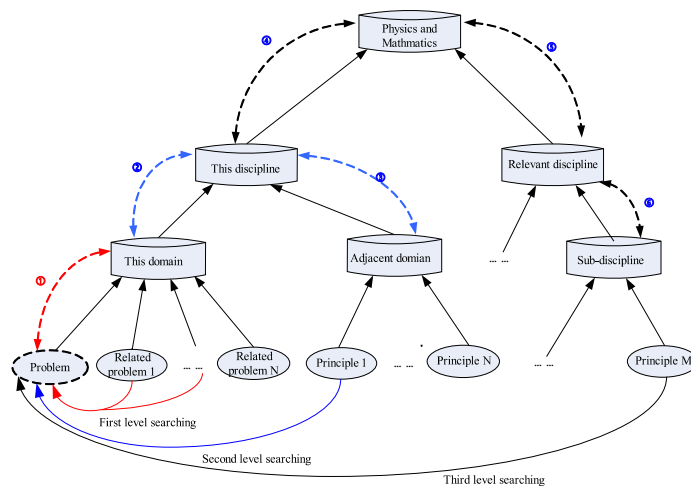

**Fig.2. Fuzzy front analysis of design projects based on knowledge fusion**

As a result, several new ideas are put forward. However, not all of them are practicable enough for in-depth development. Among them, the most practical one is chosen as the start point to define design problem. Fig. 2 illustrates how knowledge from both inside and outside TRIZ fused to work together in the fuzzy front analysis.

**Defining, transferring and solving the design problems by TRIZ.** After the design problem is defined, TRIZ methods such as the theory of contradiction and 76 standard solutions transfers these specific design problems into TRIZ standard problems as the step 2.1 shown in Fig.1. Subsequently, in step 2.2 the corresponding methods are applied to attain the TRIZ general solutions. These specific methods and working steps are referred in classic TRIZ. Therefore, their detailed explanations are omitted in this paper even though they are necessary to the proposed method.

**Mapping from TRIZ general solutions to specific solutions.** In most cases, it is the bottleneck for solving TRIZ problem to map TRIZ general solutions to specific solutions. In general, resource is usually applied to extend the solutions space of TRIZ problems and provide knowledge to inspire solutions. In this study, resource is reinforced by knowledge fusion to enhance innovation resource searching with its searching strategy shown in Fig.3. In the searching strategy, the knowledge resources are divided into three levels: the first is knowledge about the solutions that are similar to design problems from the same specific domain; the second level involves the principles from adjacent domains that are belonging to the same discipline as the design problem, knowledge on the third level of knowledge goes deeper to cover the physics and mathematics principles that are basis for the majority of disciplines, which enables a broad range for screening out the suitable principles for solving design problems.

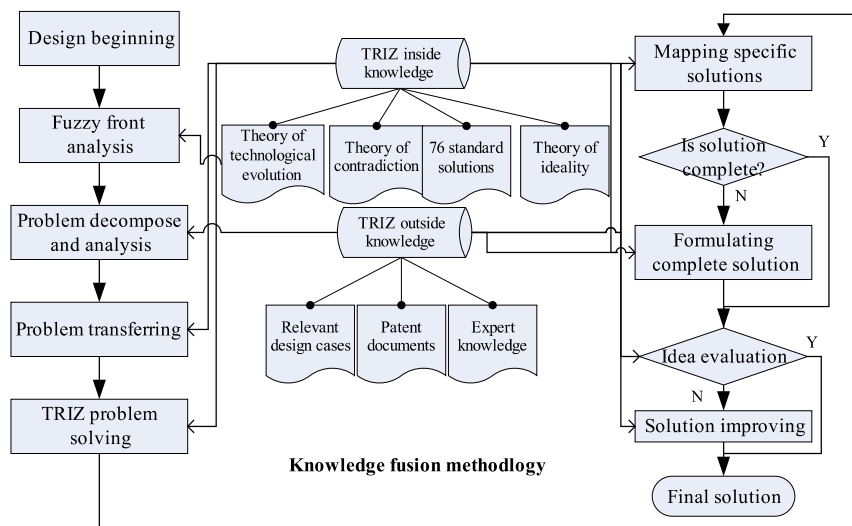

**Fig.3. An extended resource searching strategy to facilitate knowledge fusion**

**An idea evaluation approach based on knowledge fusion.** The specific design solutions should meet all the design requirements. However, a design problem is usually divided into several sub-problems after the design problems definition. In order to formulate the complete design solution, all these subdivided specific solutions should be combined as one during which supplementing knowledge is needed to finish the system construction. In most cases, there is more than one solution that meets all design requirements, the theory of ideality is usually applied to assess all the candidate design solutions and screen out the most valuable one. It depends on the knowledge from various backgrounds to assess the parameters in the ideality formula. Both the benefits parameters including useful functions and harmful parameters containing cost and harmful effects need the reference to make reasonable comparisons among these solutions. In general, the knowledge for evaluating design ideas comes from the common senses and professional comments from the evaluators.

### 3.2 Workflow of the proposed design method

Based on the aforementioned strategies, the complete workflow of the proposed method is shown in Fig.4, which consists of nine specific steps:



**Fig.4. Workflow of design method by integrating TRIZ and knowledge fusion**

Step 1: Fuzzy front analysis of design projects based on abovementioned strategy for defining problem definition and confirming the potential improving directions.

Step 2: Problem decompose and analysis in which the specific design problems are defined before being transferred to TRIZ general problems.

Step 3: Problem transferring converts the specific design problems into standard TRIZ problems.

Step 4: TRIZ problem solving provides TRIZ standard solutions to the defined problems.



Step 5: Mapping TRIZ general solutions to specific solutions with knowledge fusion from different domains for formulating the appropriate specific solutions.

Step 6: Completeness evaluation. If the solution is complete the subsequent job goes to Ideality evaluation in Step 8, otherwise, the solution should be made complete at the first in Step7.

Step 7: Formulating complete solution to make the design solution complete that may requiring knowledge both inside and outside TRIZ.

Step 8: Idea evaluation applies the theory of ideality to analyze whether there is the possibility to further improve the ideality of design solution.

Step 9: Solution improving stresses optimizing the solution to reach a ideality level that leads to an satisfying result.

#### 4 Case study

In this section, a new protective shell for protecting the composite insulator from bird's pecking works as a case study to verify the feasibility of the proposed method.

The problem of this project is resolved by the proposed method step by step:

Step 1: Fuzzy front analysis of the design project

From patent database, patent (CN200920227879.8) indicates a typical existing solution to the mentioned problem, which is illustrated in Fig.5.

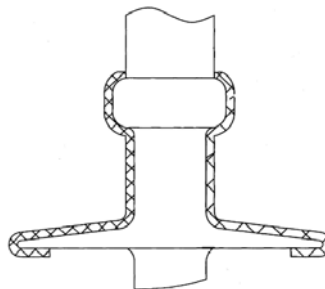

**Fig.5. A typical design of the protective shell for composite insulator**

In specific, a layer of shell material covers and encases the insulator, which is tough enough to absorb the shock from bird's pecking and prevent the damage to the insulator. After the fuzzy front analysis based on technological evolution, there are four specific potential opportunities found in technological evolution routes for improving the current design by referring to the classic TRIZ [14]:

1) Law 3 Dynamic: Route 3-1 Evolution to a continuous status system.

Current stage is single status since it is a permanent protective shell and its next stage is a double status system which indicates a system has two different working modes.

2) Law 4 Super system: Route 4.1 Evolution to multiple systems.

Current stage is only a protective shell as the function operator, next stage is a double system main including other subsystems such as control system.

3) Law 6 Completeness: Route 6.1 Evolution to system comprising subsystems of working unit, transmission, energy and control. Current stage only has a working unit, the next stage makes it complete with transmission, energy and control subsystems.

4) Law 8 Controllability: Route 8.1 Evolution to increase the controllability. Current stage has no control section. The next step will incorporate the control system in the system.

Step 2: Design problem definition and decomposition

After a long term of observation, it is found that the bird pecking mostly occurred at the interval when the laying work has finished but still wait for powering on. Moreover, the use of protective shell may hinder the insulation capability of the composite insulators by change their surface material. In summary, the protective shell is needed for preventing the insulator from bird pecking during its waiting period for the powering on, on the other hand, the shell should be removable when the insulator work under normal condition after powering on. Based on the analysis of potential improvements and the background information, the function architecture of the new design is shown in Fig.6.

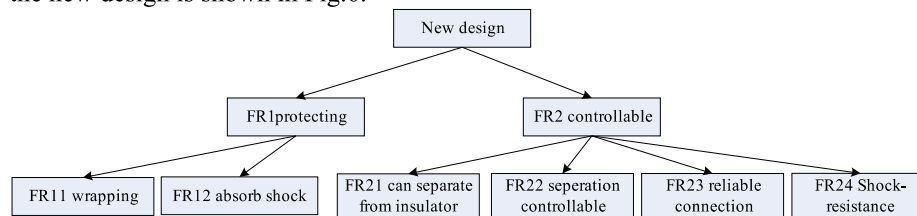

**Fig.6. Function architecture of the new design concept**

Step 3: Design problems are transformed into TRIZ general problems

Evidently, the paradoxical requirement for protective shell is a physical contradiction since a protective shell is needed and not needed under different conditions. Besides this problem, the introducing of absent subsystems such as control system is possible to be properly solved by TRIZ tools such as 76 standard solutions.

Step 4: Solving the TRIZ problem by TRIZ methods

To resolve the defined physical contradiction, the time separation principle is chosen to inspire a design idea that is a new protective shell can cover the insulator during its waiting period and depart from insulator when the powering is on. The function model of the original product is in Fig.7 (a) which is built by substance-field analysis. The product is not complete for lacking of other sub-systems, therefore, the No.1.1.1 form the 76 standard solutions is used for building a complete system as the premise of the following design. As a result, several substances and fields are added to the product system.

Step 5: Formulating the specific design solution based on knowledge fusion

With the TRIZ general solution obtained at the previous step, a new specific design solution is proposed by implementing the knowledge to facilitate the functions such as the "remote control", "activate the separation" come from the design cases in

relevant domains and fusing them with the original product. The function model of new design concept is shown in Fig.7 (b).

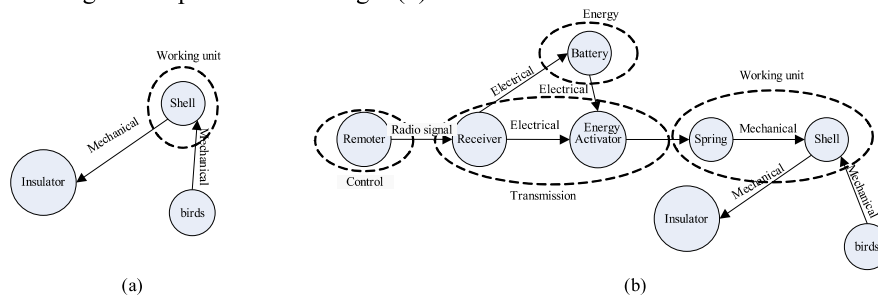

**Fig.7. (a) Function model for the original product; (b) Function model for the new design solution**

#### Step 6: Completeness evaluation of the proposed solution

Based on its function mode, it is reasonable to make the conclusion that the new solution is complete since it comprises all the four sub-systems to meet the all functional requirements. Therefore, the step 7 is skipped over and the design goes directly to the Step 8 in the workflow of Fig.4.

#### Step 7(original step 8): Ideality evaluation of the proposed solution

The most ideal means to prevent the insulator bird pecking from root is driving the birds away from the insulators. Therefore, the ideality of new product can be improved if it able to drive the bird away with no obvious cost, in turns a longer services life will be premised for the shell since the chance of bird pecking has been cut down dramatically.

#### Step 8 (original step 9): Solution optimization

The optimization of design solution also depends on the knowledge outside TRIZ, in this case, the biological knowledge is used as imitating the eyes of eagle which are painted on the surfaces of shell to scare the birds away. As a result, the ideality level of design solution is improved by extending the lifespan of protective shell with trivial cost. The final solution is shown in both Fig. 8(a) and (b).

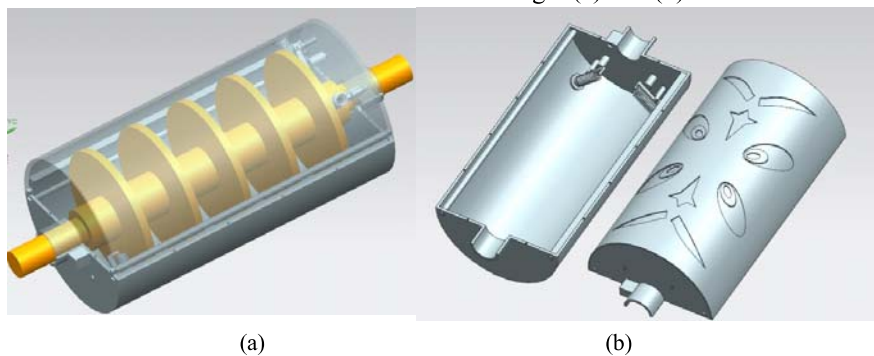

**Fig.8. Conceptual solution of the new design solution**

## 5 Discussion and conclusion

In this paper, a novel design method is put forward by incorporating TRIZ and knowledge fusion to solve design problem. In this method, TRIZ provides a bridge for fusing knowledge from patent or biology in creative design owing to its sophisticated methodology. On the other hand, knowledge fusion is able to bring about abundant resource for inspiring TRIZ problem solving. Generally speaking, TRIZ is a powerful problem solving methodology but it requires learners' knowledge and experience to formulate the well-built design solutions. From this viewpoint, with the suitable knowledge at hand, it is possible for all the TRIZ learners to become good TRIZ users, which in turns promotes the development of TRIZ. Knowledge fusion, an effective way for knowledge accumulation, is suitable to play the role of knowledge provider in TRIZ problem solving. The method that is represented by this paper stresses the feasibility of combing the TRIZ and knowledge fusion in creative design. With the proposed framework, it is practical to bring about promising solutions to design project, which has been proved by the case study in this paper.

To be honest, this paper is just a preliminary step for exploring the combination of TRIZ and knowledge fusion in product design. It is still a long way to go in the future, which requires continuous effort for developing a computer-aided tool for managing the knowledge fusion in TRIZ problem solving and a reasonable evaluation method to screen out the design solutions. With these effort in the future, an ideal design method can be formulate in which designers handle the manual tasks such as fuzzy analysis and making decision, while the computer doing the part that are more suitable for themselves, for examples knowledge accumulation and data processing.

## Acknowledgement

This paper was sponsored by the National Natural Science Foundation of China (Grant No. 51675159), China Scholarship Council, Chinese Hebei Province High-level Talent Support Project (Grant No. A201500113). Chinese Central Government Guides Local Science and Technology Development Project (Grant No.18241837G). We are grateful to all the anonymous reviewers for their positive comments and constructive suggestions.

## References

1. J. Xu, R. Houssin, E. Caillaud, and M. Gardoni.: Fostering continuous innovation in design with an integrated knowledge management approach. *Comput. Ind.* 62(4), 423–436 (2011).
2. T. Robert and F. Mayer.: Improving Models for Better Knowledge Interoperability in Product Design Process. *IFAC Proc.* 36(22), 233–237(2003).
3. S. Zheng, W. Zhang, and J. Du.: Knowledge based dynamic capabilities and innovation in networked environments. *J. Knowl. Manag.* 15(6), 1035–1051(2011).
4. P. Ritala and P. Hurmelinna-Laukkanen.: Incremental and radical innovation in coopection—the role of absorptive capacity and appropriability. *J. Prod. Innov. Manag.* 30(1), 154–169 (2013).

5. Y.-J. Chen, Y.-M. Chen, and H.-C. Chu.:Enabling collaborative product design through distributed engineering knowledge management. *Comput. Ind.* 59(4) 395–409(2008).
6. B. Rubenstein-Montano, J. Liebowitz, J. Buchwalter, D. McCaw, B. Newman, and K. Rebeck.: A systems thinking framework for knowledge management. *Decis. Support Syst.* 31(1), 5–16 (2001).
7. J. Geng and X. Tian.:Knowledge-based computer aided process innovation method. In *World Conference: TRIZ FUTURE, TF 2011-2014*, pp.97–101(2010).
8. B. Guo, J. Geng, and G. Wang.: Knowledge fusion method of process contradiction units for process innovation. In *World Conference: TRIZ FUTURE, TF 2011-2014*, pp. 816–822 (2015).
9. M. Delgado-Verde, G. Martín-De Castro, and J. Amores-Salvadó.:Intellectual capital and radical innovation: Exploring the quadratic effects in technology-based manufacturing firms. *Technovation.* 54, 35–47 (2016).
10. A. Preece et al.: KRAFT architecture for knowledge fusion and transformation. *Knowledge-Based Syst.* 13( 2), 113–120 (2000).
11. A. Albers, T. Deigendesch, and H. Schmalenbach.:TRIZ-box-Improving creativity by connecting TRIZ and artifacts. In *TRIZ Future Conference 2009*, pp. 214–221(2011).
12. J. R. Chou.: An ideation method for generating new product ideas using TRIZ, concept mapping, and fuzzy linguistic evaluation techniques. *Adv. Eng. Informatics.* 28(4), 441–454 (2014).
13. M. Heffner, N. Sharif, M. Heffner, and N. Sharif.:Knowledge fusion for technological innovation in organizations. *Journal of Knowledge management.* 12(2), 79-93 (2008).
14. G. Altshuller.:Creativity as an exact science. *Luxemb. Gordon Breach*, pp. 1–5(1984).
15. P. Prickett and I. Aparicio.:The development of a modified TRIZ Technical System ontology. *Comput. Ind.* 63(3), 252–264 (2012).
16. M. Schöfer, N. Maranzana, A. Aoussat, C. Gazo, and G. Bersano.: The value of TRIZ and its derivatives for interdisciplinary group problem solving .In *.World Conference: TRIZ FUTURE, TF 2011-2014*, pp. 672–681 (2015).
17. M. Heffner, N. Sharif, M. Heffner, and N. Sharif, “Knowledge fusion for technological innovation in organizations,” 2013.
18. S. H. Han, H. J. Kim, K. H. Cho, M. K. Kim, H. Kim, and S. H. Park, “Research planning methodology for technology fusion in construction,” 2006 Proc. 23rd Int. Symp. Robot. Autom. Constr. ISARC 2006, pp. 15–18, (2006).
19. H. Cong and L. H. Tong, “Grouping of TRIZ Inventive Principles to facilitate automatic patent classification,” *Expert Syst. Appl.*, vol. 34, no. 1, pp. 788–795, (2008).
20. H. Park, J. J. Ree, and K. Kim, “Identification of promising patents for technology transfers using TRIZ evolution trends,” *Expert Syst. Appl.*, vol. 40, no. 2, pp. 736–743, (2013).
21. J. F. V. Vincent, O. A. Bogatyreva, N. R. Bogatyrev, A. Bowyer, and A.-K. Pahl, “Biomimetics: its practice and theory,” *J. R. Soc. Interface*, vol. 3, no. 9, pp. 471–482, (2006).
22. A. Baldussu and G. Cascini, “About integration opportunities between TRIZ and biomimetics for inventive design,” in *Procedia Engineering*, vol. 131, pp. 3–13, (2015).