



**HAL**  
open science

# Anticipation in the retina and the primary visual cortex: towards an integrated retino-cortical model for motion processing

Selma Souihel, Bruno Cessac, Matteo Di Volo, Alain Destexhe, Frederic Chavane, Sandrine Chemla, Olivier Marre

## ► To cite this version:

Selma Souihel, Bruno Cessac, Matteo Di Volo, Alain Destexhe, Frederic Chavane, et al.. Anticipation in the retina and the primary visual cortex: towards an integrated retino-cortical model for motion processing. Waves Côte d'Azur, Jun 2019, Nice, France. hal-02172010

**HAL Id: hal-02172010**

**<https://inria.hal.science/hal-02172010>**

Submitted on 3 Jul 2019

**HAL** is a multi-disciplinary open access archive for the deposit and dissemination of scientific research documents, whether they are published or not. The documents may come from teaching and research institutions in France or abroad, or from public or private research centers.

L'archive ouverte pluridisciplinaire **HAL**, est destinée au dépôt et à la diffusion de documents scientifiques de niveau recherche, publiés ou non, émanant des établissements d'enseignement et de recherche français ou étrangers, des laboratoires publics ou privés.



# Anticipation in the retina and the primary visual cortex : towards an integrated retino-cortical model for motion processing

PhD student : Selma Souihel  
Adviser : Dr Bruno Cessac  
Team : Biovision



In collaboration with :

Matteo Di Volo  
Alain Destexhe



Frédéric Chavane  
Sandrine Chemla



Olivier Marre



# The visual flow

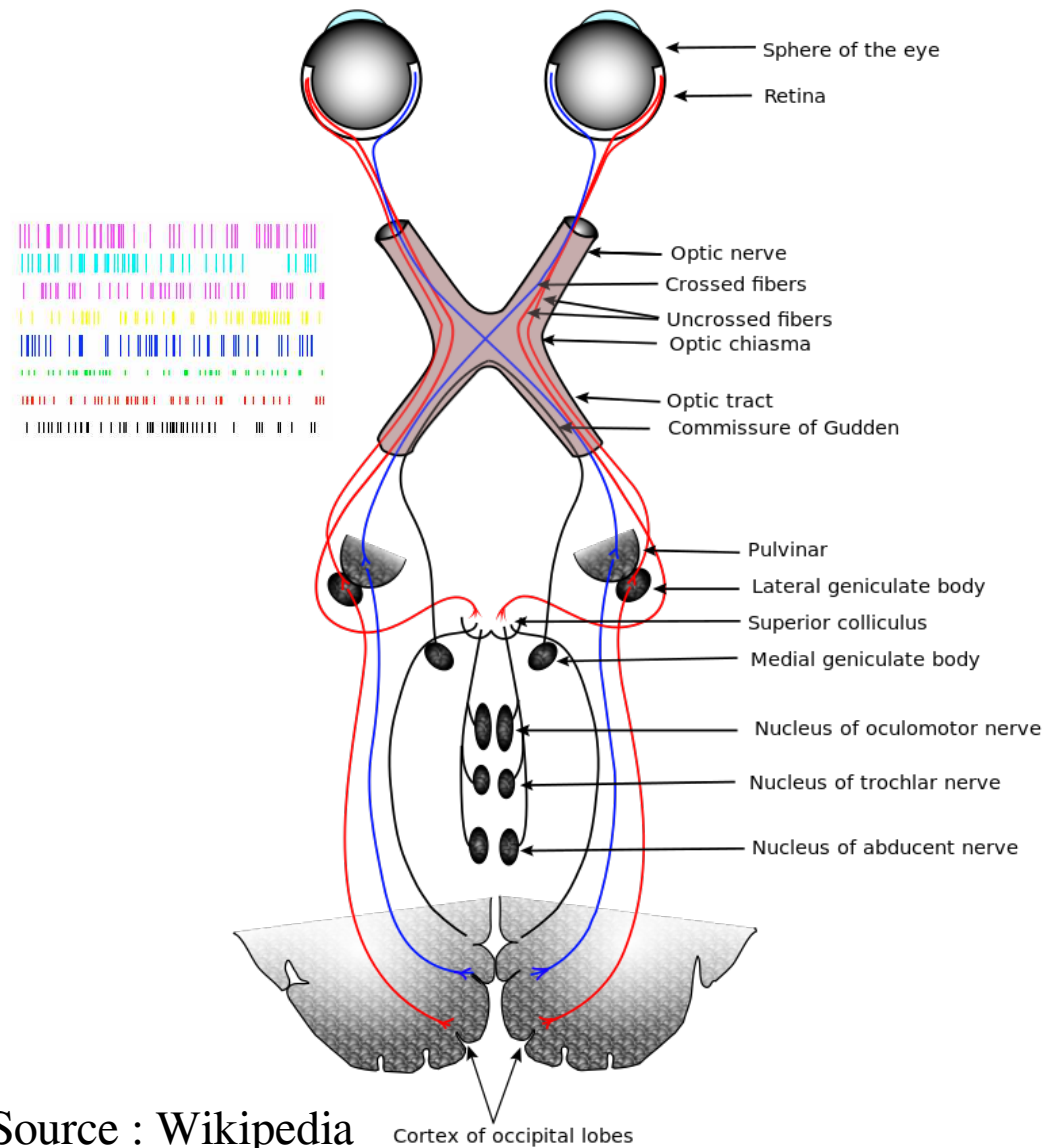

# The visual flow

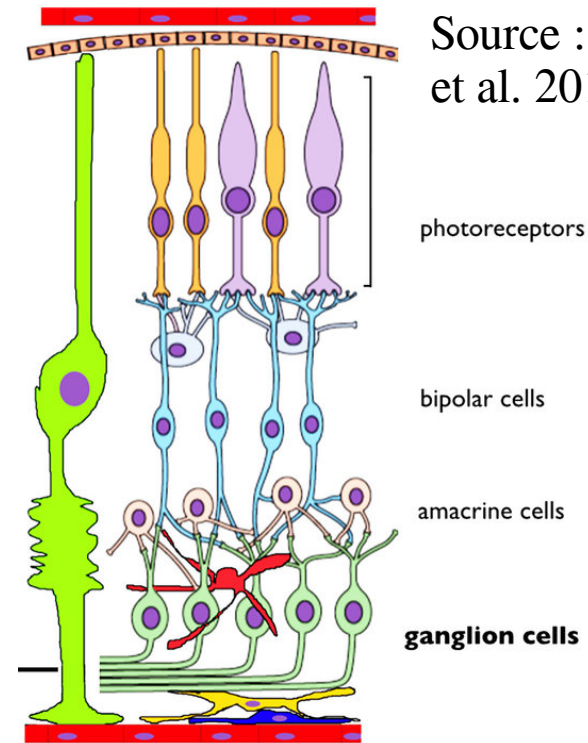
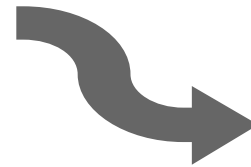
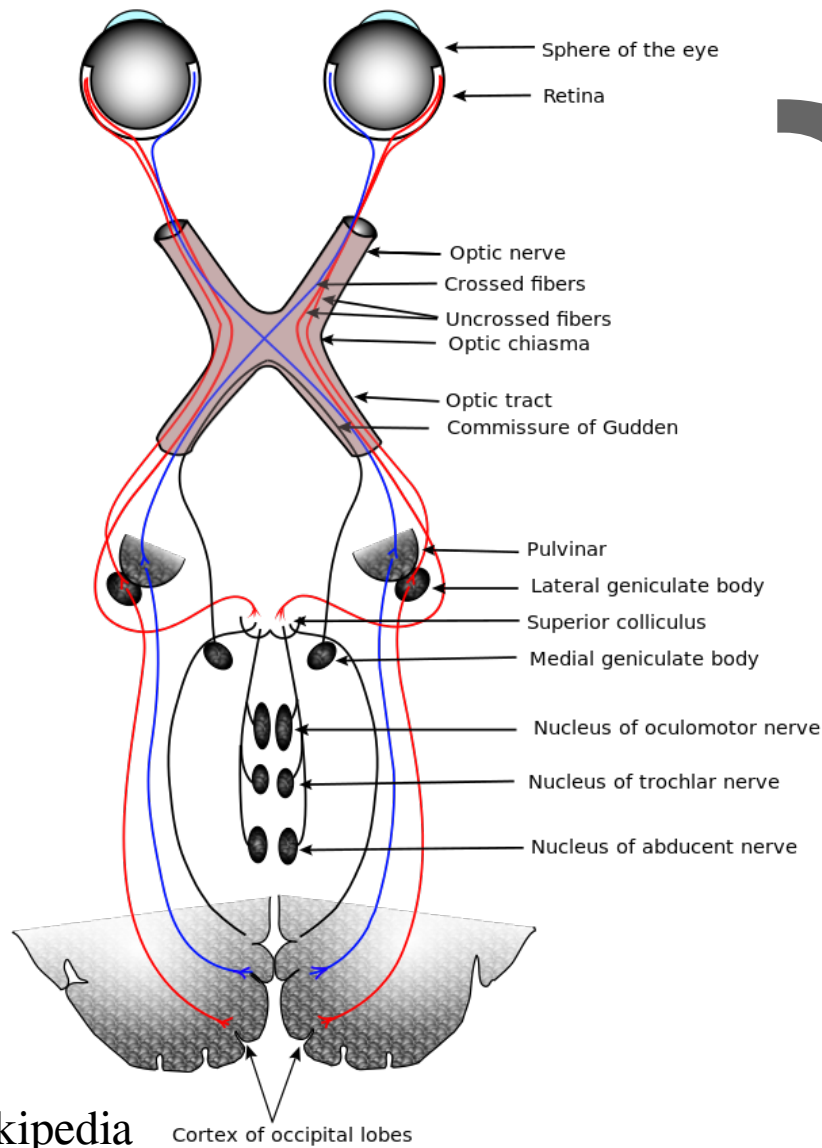

Source : Ryskamp et al. 2014



Source : Wikipedia

Cortex of occipital lobes

# Stating the problem : Visual Anticipation

**Anticipation** is carried out by the primary visual cortex (V1) through an activation wave

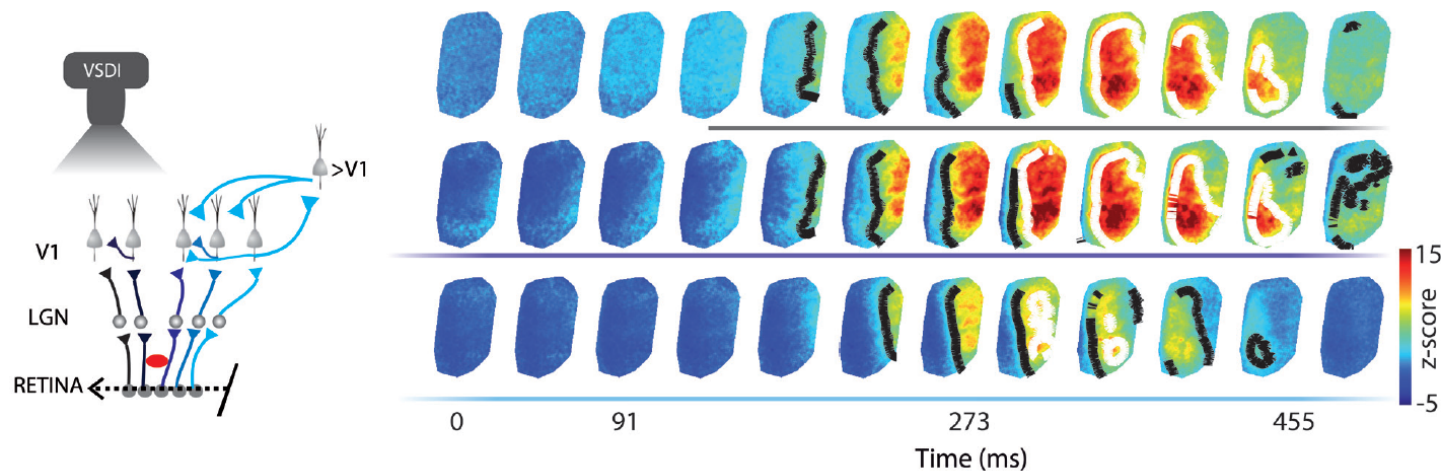

Source :  
Benvenuti et  
al. 2015

But the retina is not a mere transmitter, it is able to perform many computations such as :

- Orientation sensitivity
- Contrast gain control
- Sensitivity to differential motion
- .... and « **Motion Anticipation** »

➤ **What does retinal anticipation add to the cortical one ?**

# I ) Anticipation in the retina

# The Hubel-Wiesel view of vision

Nobel prize 1981

Ganglion cells response is the convolution of the stimulus with a spatio-temporal receptive field followed by a non linearity

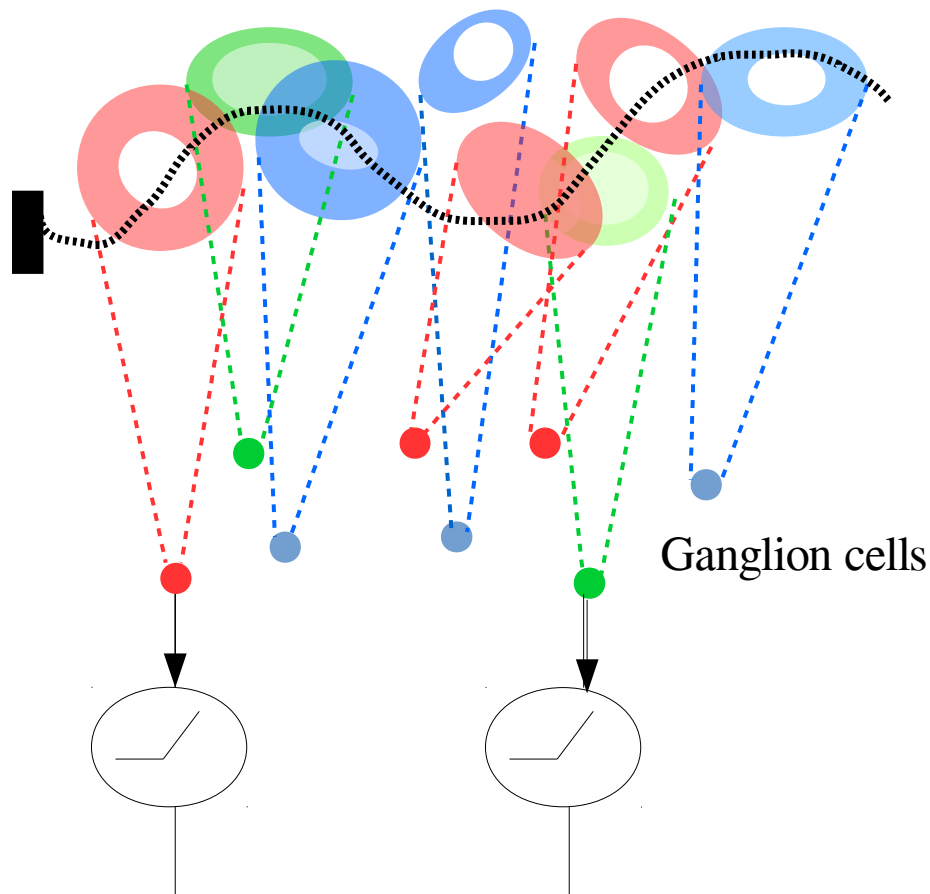

# The Hubel-Wiesel view of vision

Nobel prize 1981

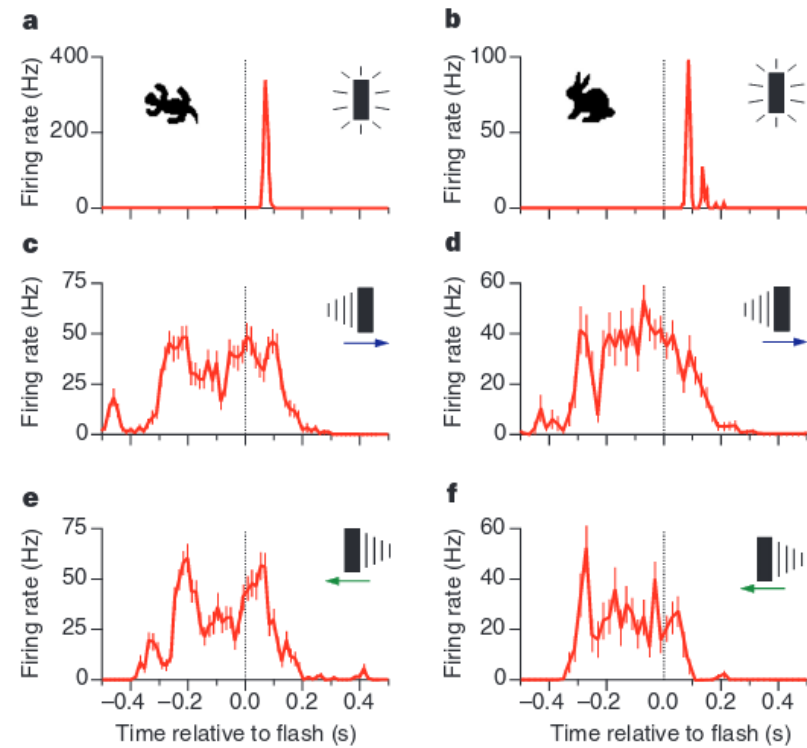
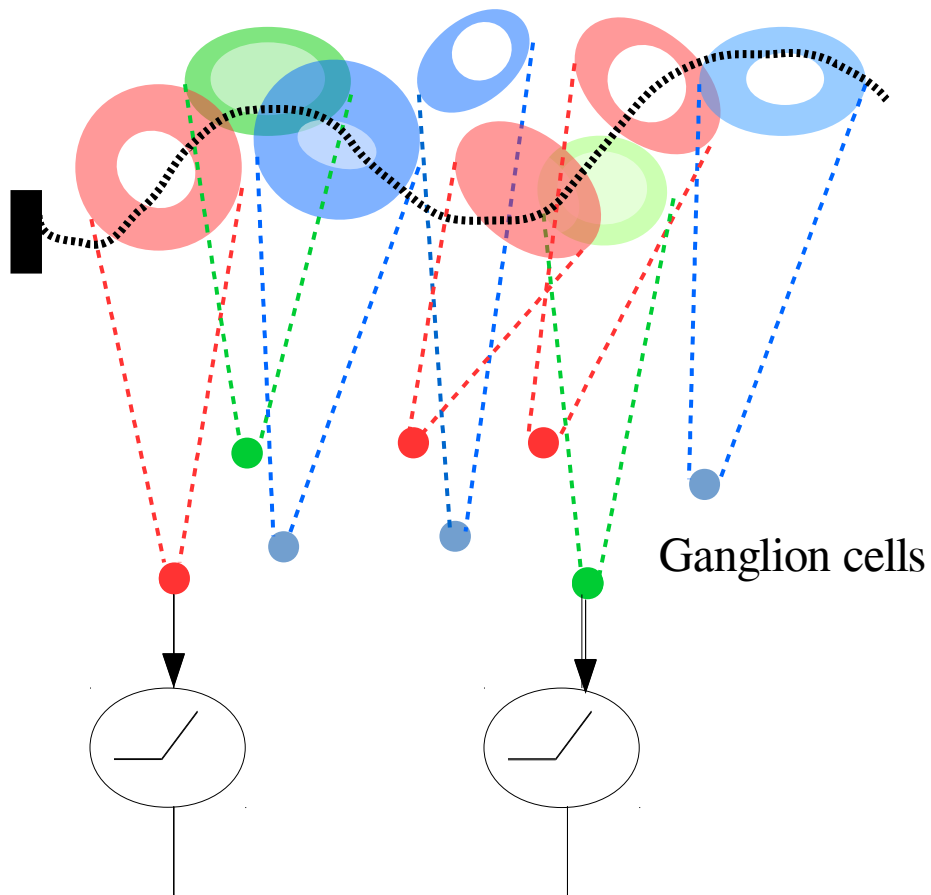

Source : Berry et al. 1999



# The Hubel-Wiesel view of vision

Nobel prize 1981

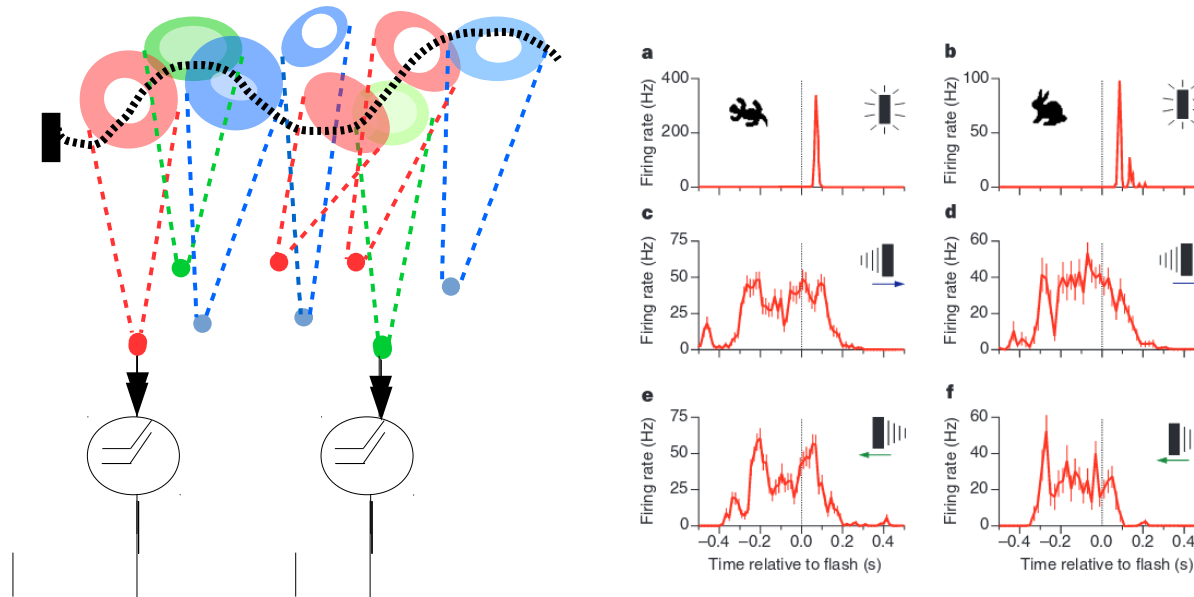

Source : Berry et al. 1999

➤ Which mechanism can account for motion anticipation in the retina ?

# Building a 2D retina model for motion anticipation

## 1) Gain control

How does it work ?

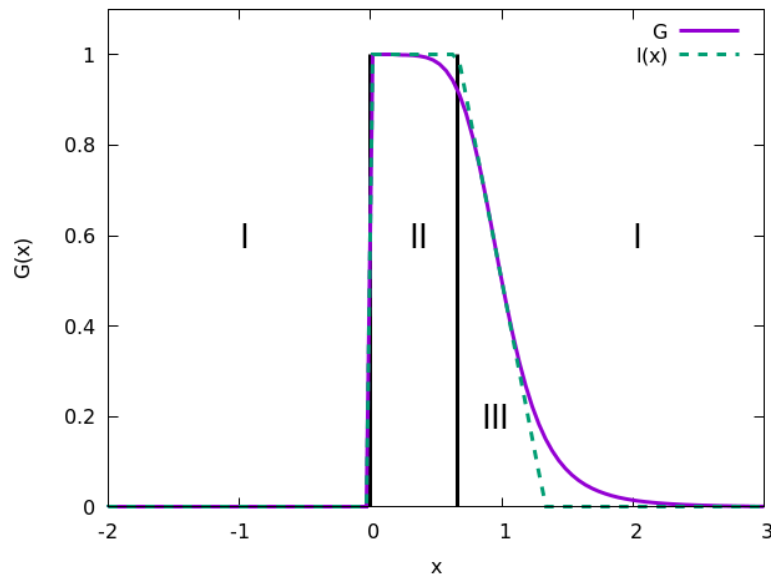

$$\mathcal{G}_B(A) = \begin{cases} 0, & \text{if } A \leq 0; \\ \frac{1}{1+A^6}, & \text{else.} \end{cases}$$

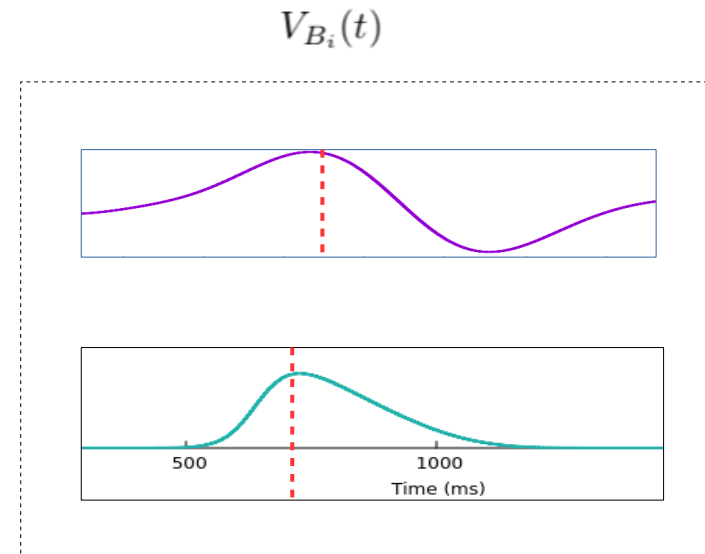

$$R_{B_i} = \mathcal{N}_B(V_{B_i}) \mathcal{G}_B(A_{B_i}).$$

# Building a 2D retina model for motion anticipation

## 1) Gain control (Chen et al. 2013)

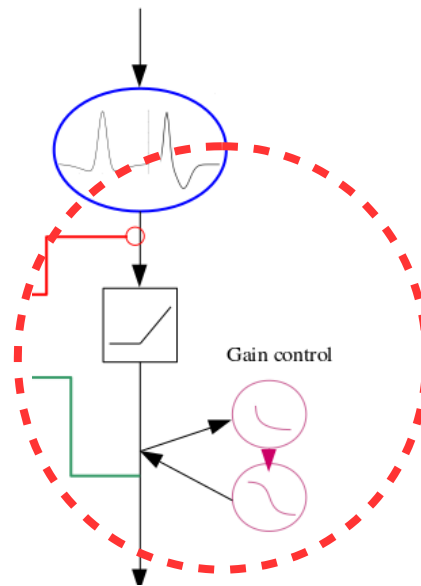

- Bipolar voltage :

$$V_{B_i}(t) = V_{i_{drive}}(t) + P_{B_i}(t).$$

- Non-linear function :

$$\mathcal{N}_B(V_{B_i}) = \begin{cases} 0, & \text{if } V_{B_i} \leq \theta_B; \\ V_{B_i} - \theta_B, & \text{else.} \end{cases}$$

- Activation function :

$$\frac{dA_{B_i}}{dt} = -\frac{A_{B_i}}{\tau_a} + h\mathcal{N}(V_{B_i}(t)).$$

- Gain Control function :

$$\mathcal{G}_B(A) = \begin{cases} 0, & \text{if } A \leq 0; \\ \frac{1}{1+A^6}, & \text{else.} \end{cases}$$

- Output :

$$R_{B_i} = \mathcal{N}_B(V_{B_i}) \mathcal{G}_B(A_{B_i}).$$

# Building a 2D retina model for motion anticipation

## 1) Gain control (Chen et al. 2013)

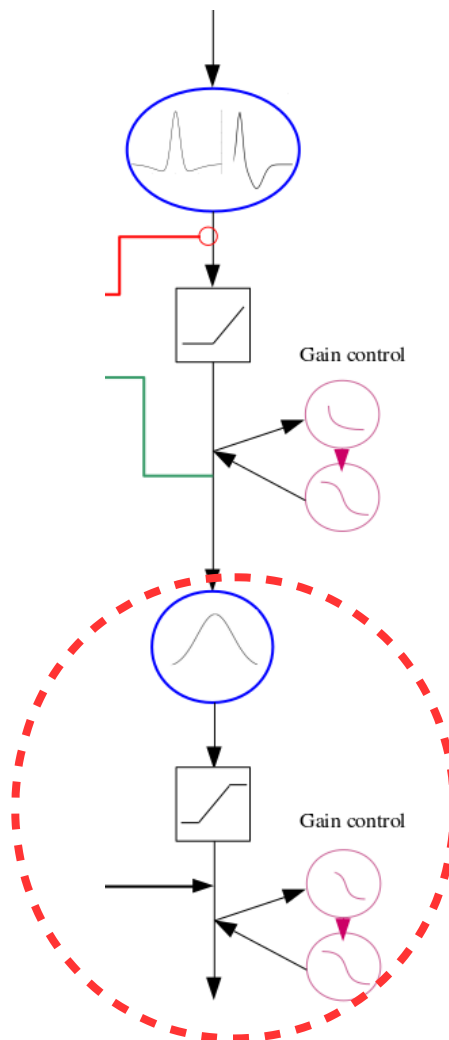

- Ganglion voltage

$$V_{G_k} = \sum_i W_{G_k}^{B_i} R_{B_i}$$

- Non-linear function :

$$\mathcal{N}_{G_F}(V) = \begin{cases} 0, & \text{if } V \leq 0; \\ \alpha_{G_F}(V - \theta_{G_F}), & \text{if } \theta_{G_F} \leq V \leq N_{G_F}^{max}/\alpha_{G_F} + \theta_{G_F} \\ N_{G_F}^{max}, & \text{else.} \end{cases}$$

- Activation function :

$$\frac{dA_{G_F k_F}}{dt} = -\frac{A_{G_F k_F}}{\tau_{G_F}} + h_{G_F} \mathcal{N}_{G_F}(V_{G_F k_F})$$

- Gain Control function :

$$\mathcal{G}_{G_F}(A) = \begin{cases} 0, & \text{if } A \leq 0; \\ \frac{1}{1+A}, & \text{else.} \end{cases}$$

- Output :

$$R_{G_F k_F}(V_{G_F k_F}, A_{G_F k_F}) = \mathcal{N}_{G_F}(V_{G_F k_F}) \mathcal{G}_{G_F}(A_{G_F k_F}).$$

# 1D results : smooth motion anticipation with gain control

Bipolar layer

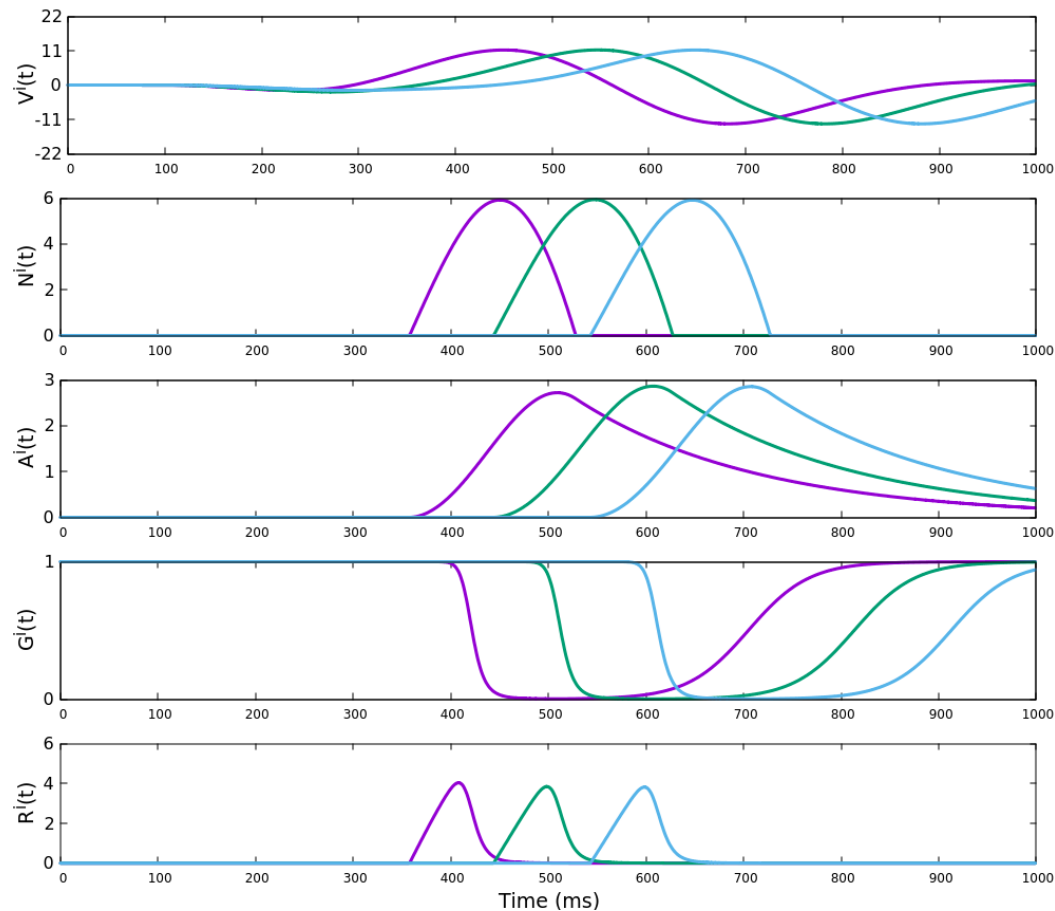

Ganglion layer

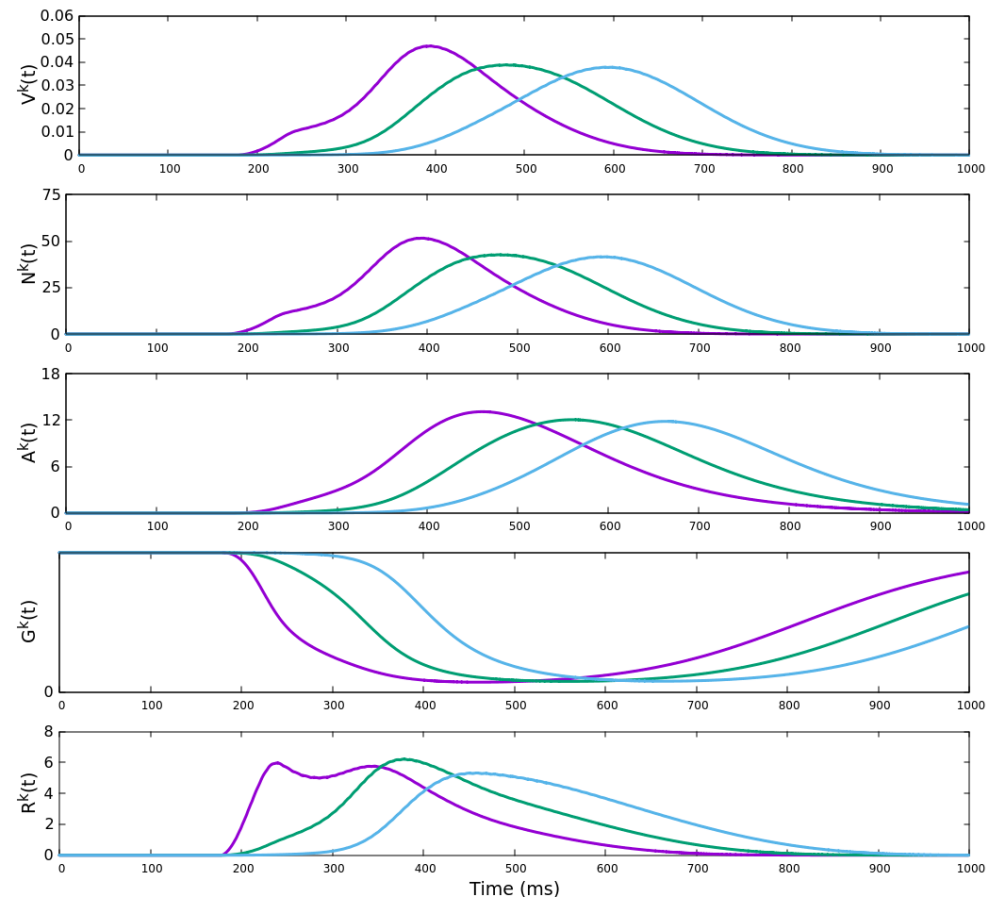

# 1D results : smooth motion anticipation with gain control

Anticipation variability with stimulus parameters

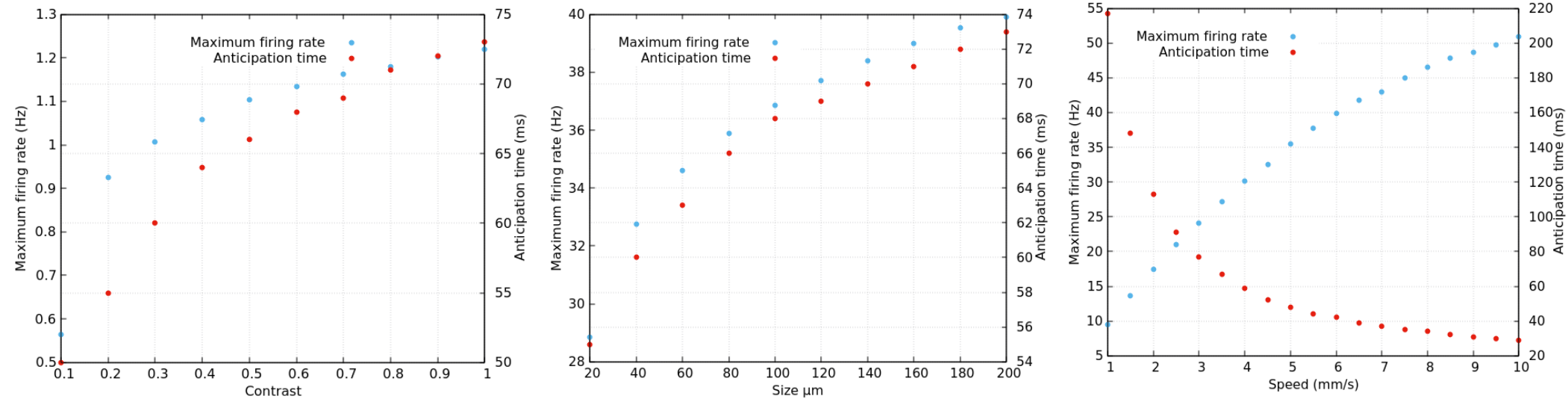

# Building a 2D retina model for motion anticipation

## 2) Gap junction connectivity

- A class of direction selective RGCs are connected through gap junctions
- Their activity comprises the activity pooled from bipolar cells and the activity coming from the downstream RGCs, in the direction of motion

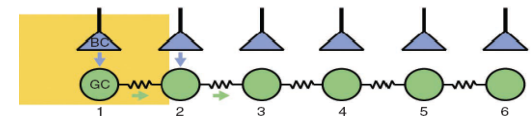
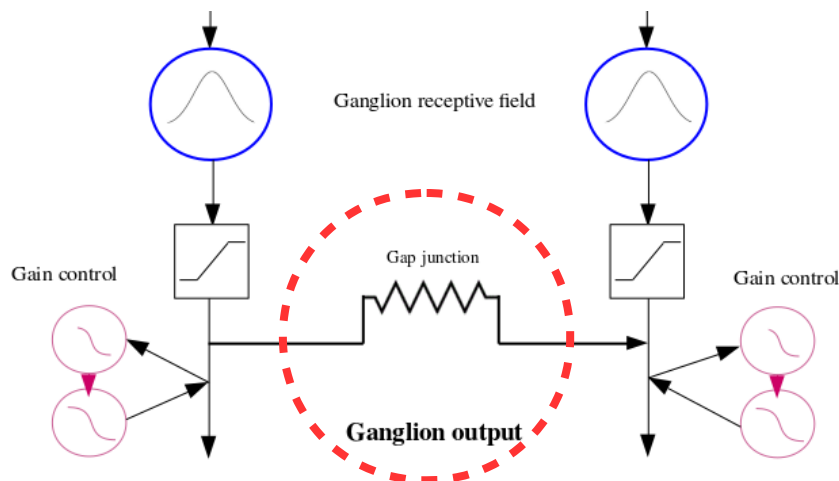

$$R_{GDk_D} = V_{GDk_D} + \beta R_{GDk_D-1}$$

# 1D results : smooth motion anticipation with gap junctions

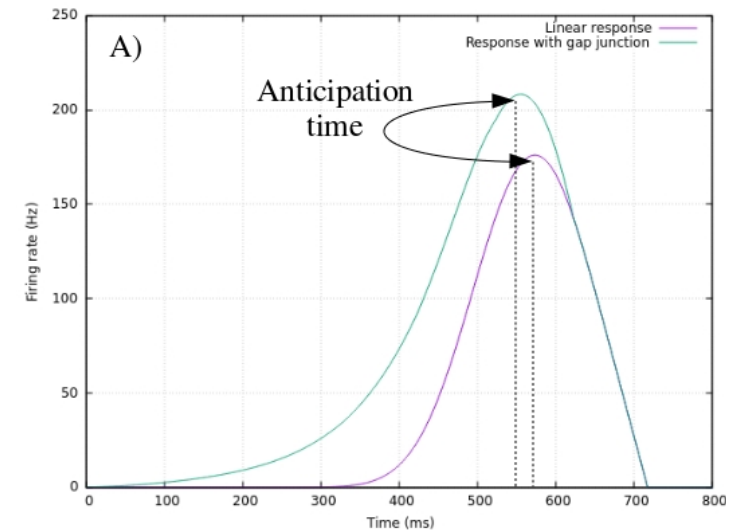
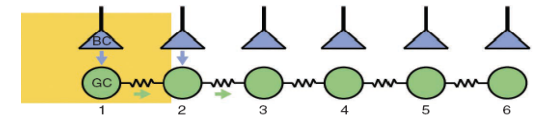
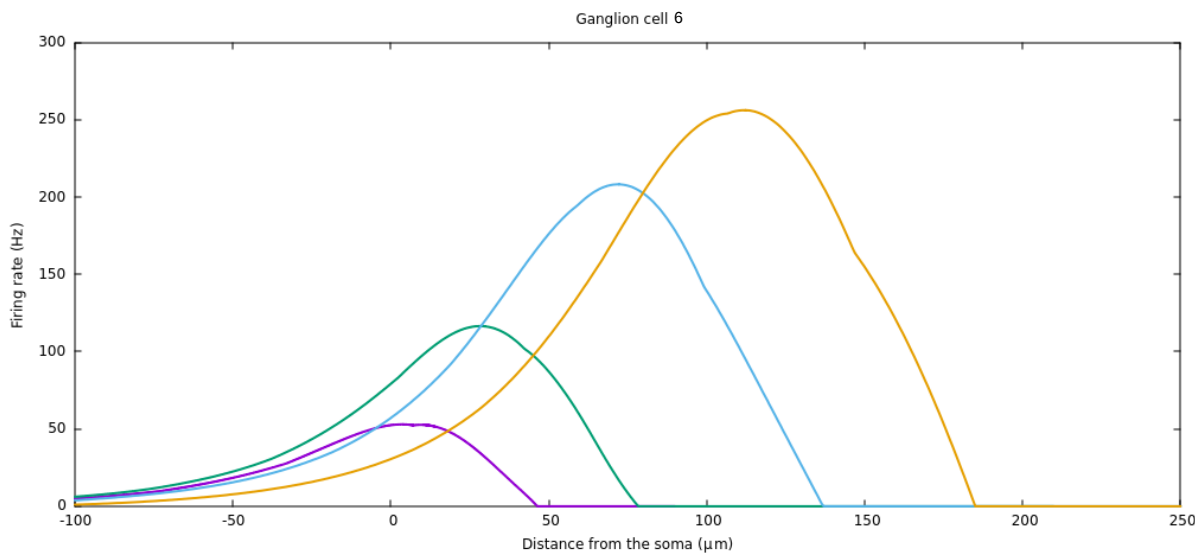



# 1D results : smooth motion anticipation with gap junctions

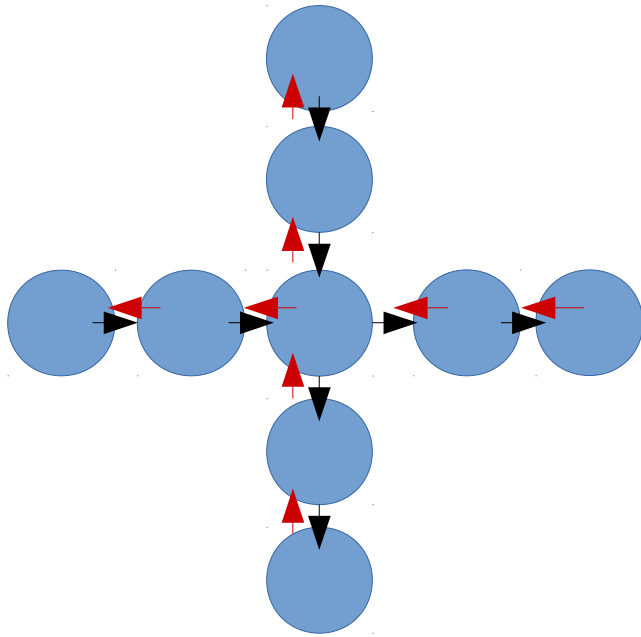

# 1D results : smooth motion anticipation with gap junctions

Anticipation variability with stimulus parameters

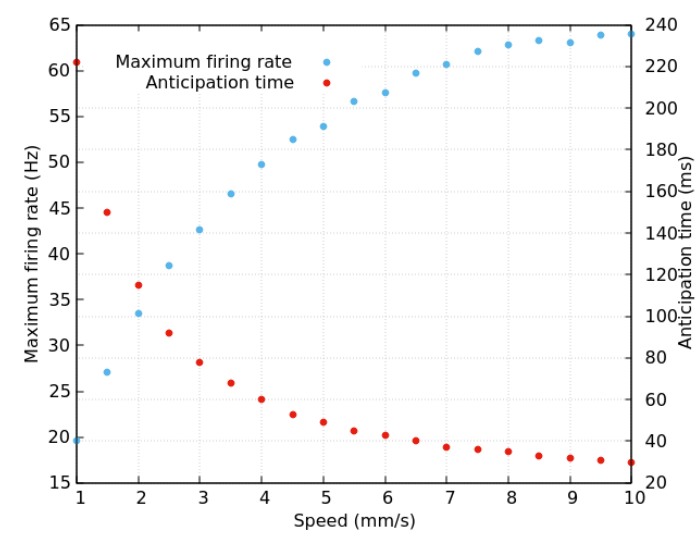
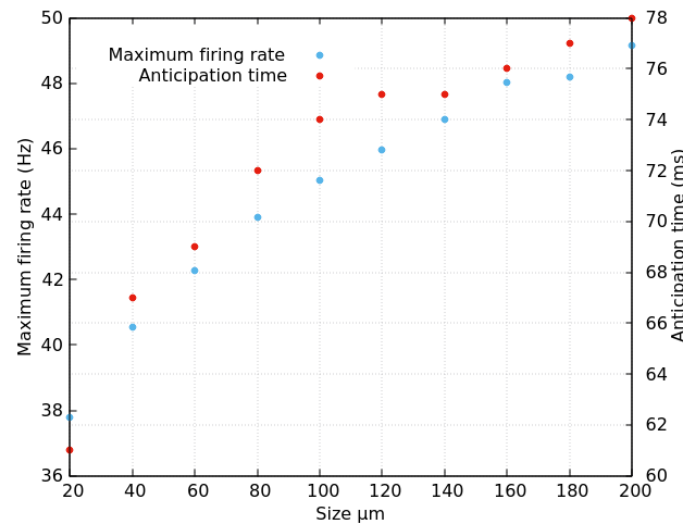
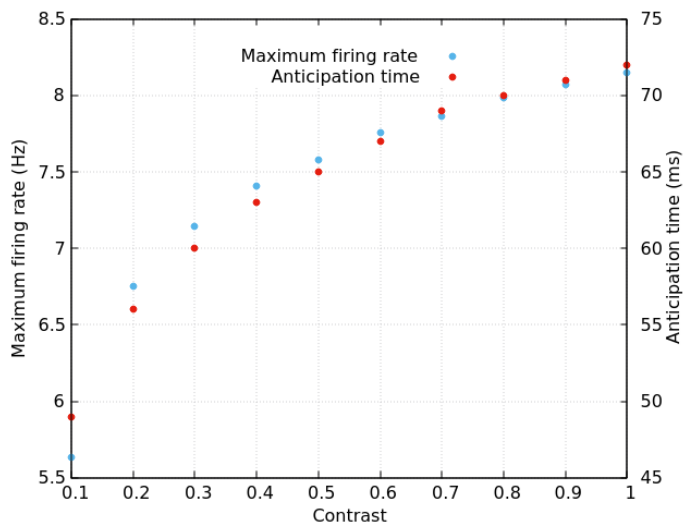

# Building a 2D retina model for motion anticipation

## 3) Amacrine cells connectivity

- A class of RGCs are selective to differential motion

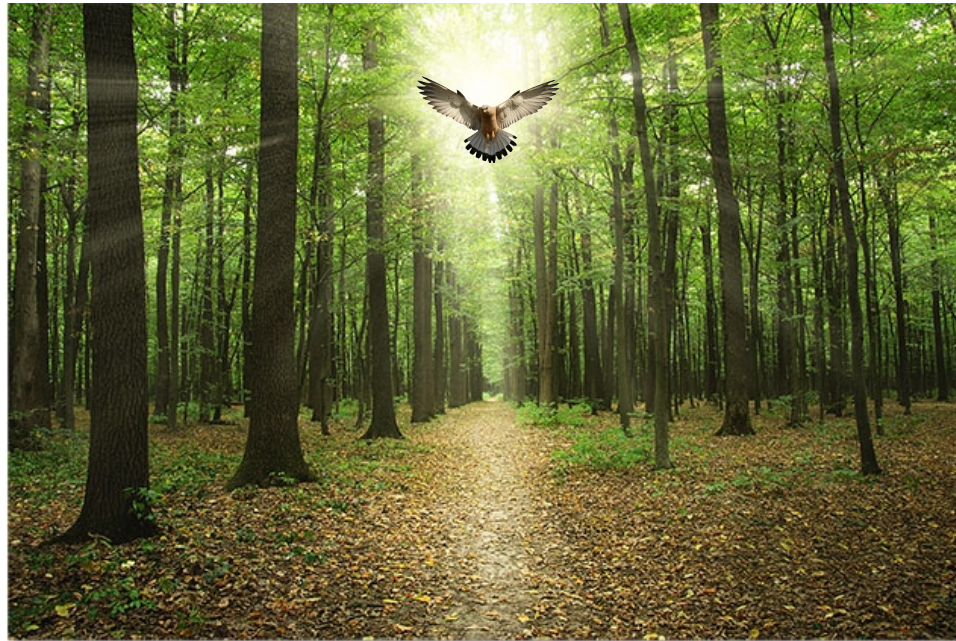

# Building a 2D retina model for motion anticipation

## 3) Amacrine cells connectivity

- A class of RGCs are selective to differential motion



- The circuitry involves amacrine cells connectivity upstream of ganglion cells

# Connectivity pathways

## 2) Amacrine cells connectivity

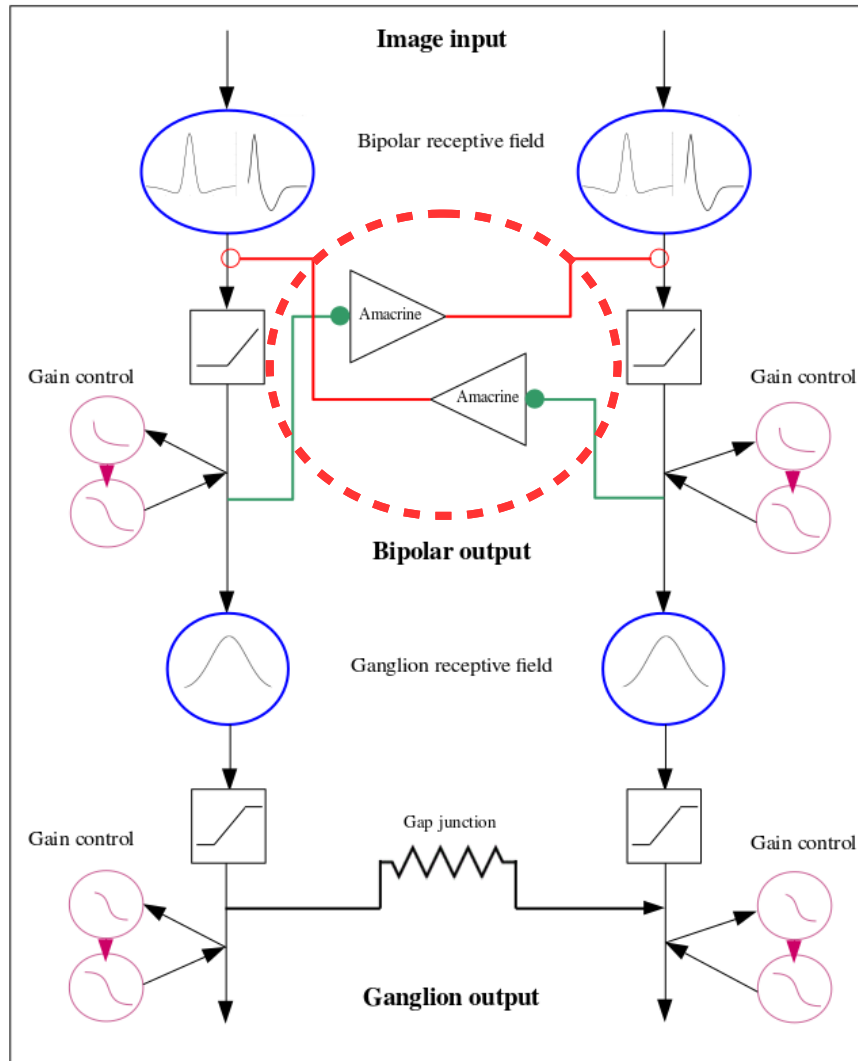

- Bipolar voltage :

$$\frac{dV_{B_i}}{dt} = -\frac{1}{\tau_B} V_{B_i} + \sum_{j=1}^{N_A} W_{B_i}^{A_j} V_{A_j} + F_{B_i}(t).$$

- External drive :

$$F_{B_i}(t) = \left[ K_i \overset{S,t}{*} \left( \frac{\mathcal{S}}{\tau_B} + \frac{d\mathcal{S}}{dt} \right) \right] (t)$$

- Amacrine voltage :

$$\frac{dV_{A_j}}{dt} = -\frac{1}{\tau_A} V_{A_j}(t) + \sum_{i=1}^{N_A} W_{A_j}^{B_i} R_{B_i}(t).$$

- Coupled dynamics :

$$\left\{ \begin{array}{l} \frac{dV_{B_i}}{dt} = -\frac{1}{\tau_B} V_{B_i} + \sum_{j=1}^{N_A} W_{B_i}^{A_j} V_{A_j} + F_{B_i}(t) \\ \frac{dA_{B_i}}{dt} = -\frac{A_{B_i}}{\tau_a} + h \mathcal{N}(V_{B_i}(t)), \\ \frac{dV_{A_j}}{dt} = -\frac{1}{\tau_A} V_{A_j}(t) + \sum_{i=1}^{N_A} W_{A_j}^{B_i} R_{B_i}(t). \end{array} \right. \quad 20$$

# 1D results : smooth motion anticipation with amacrine connectivity

Bipolar layer

Ganglion layer

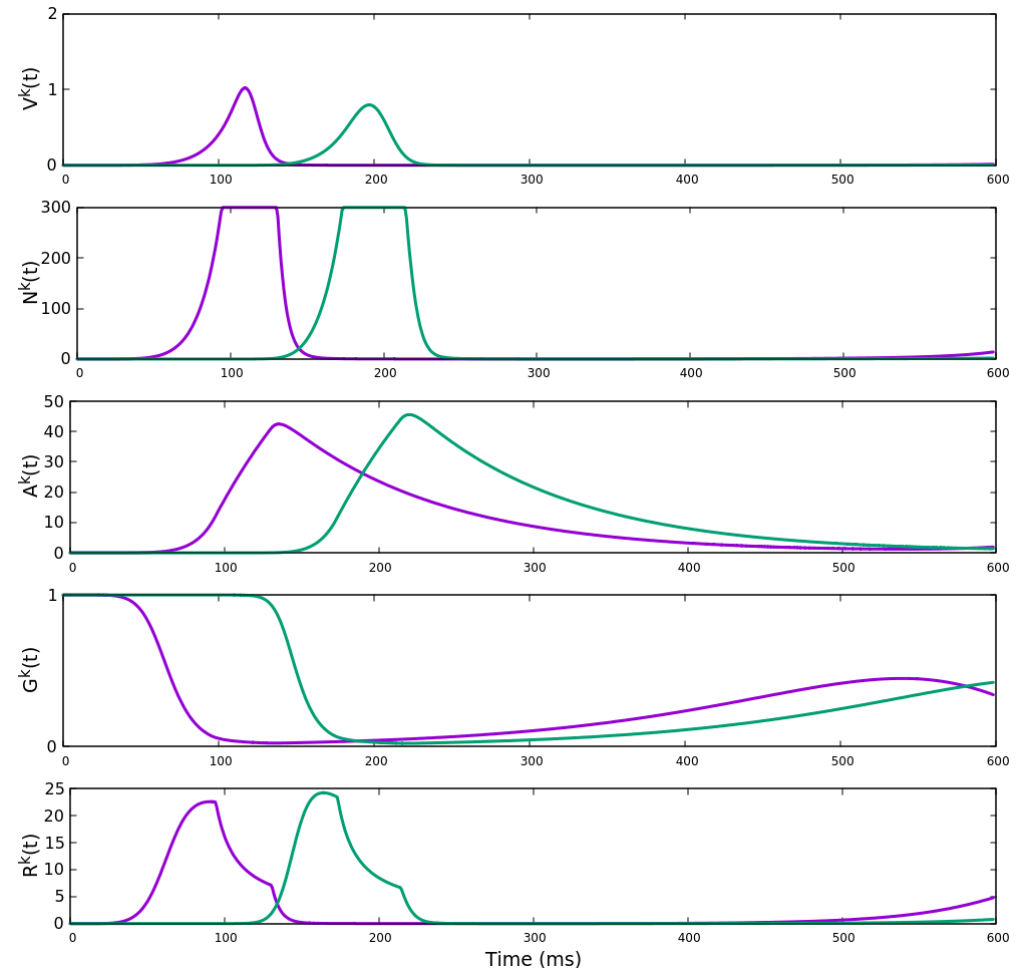
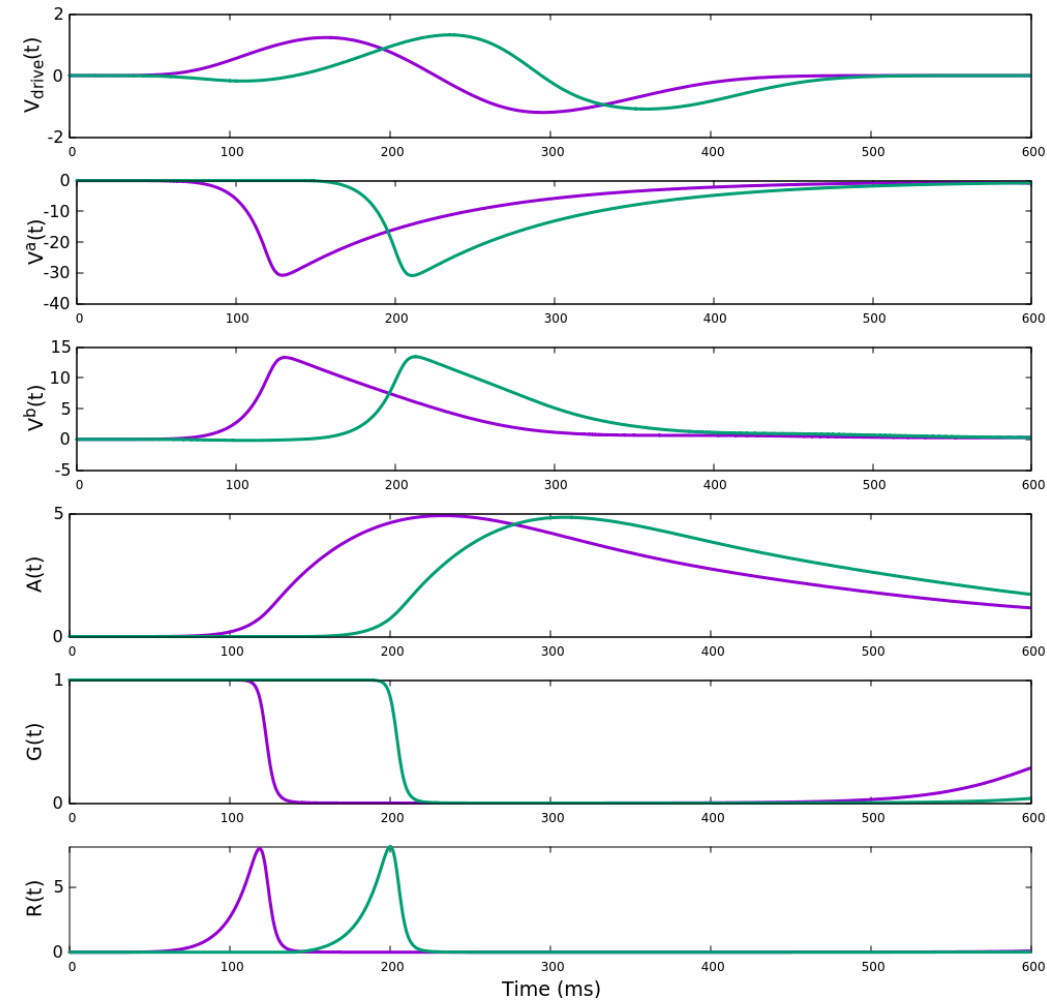

# 1D results : smooth motion anticipation with amacrine connectivity

Anticipation variability with stimulus parameters

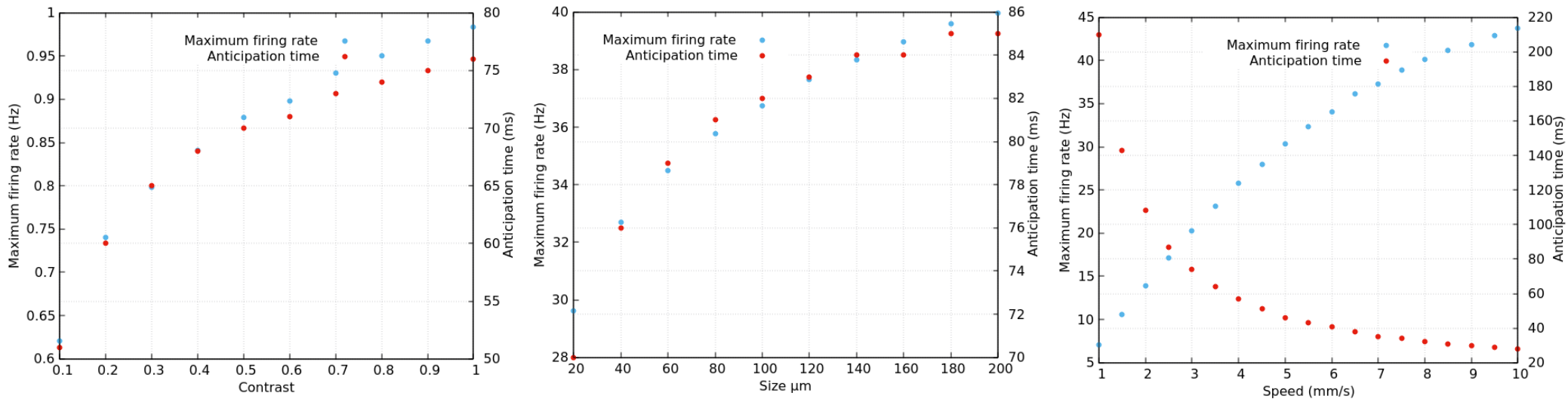

# Comparing the performance of the three layers

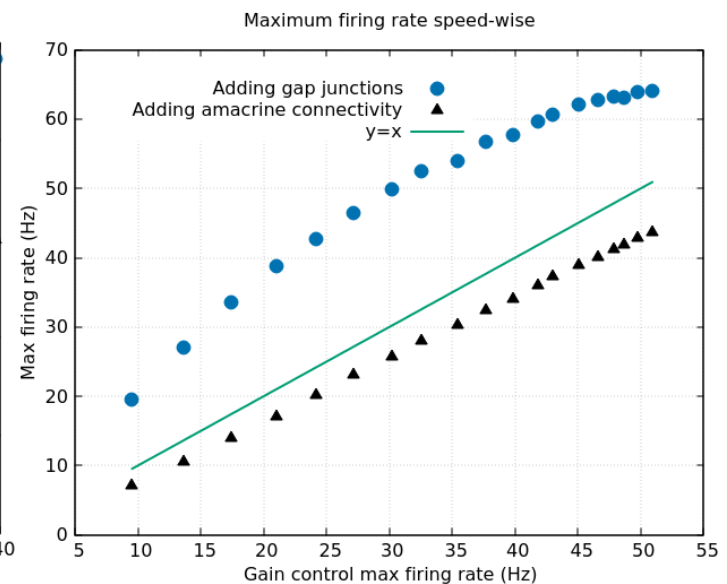
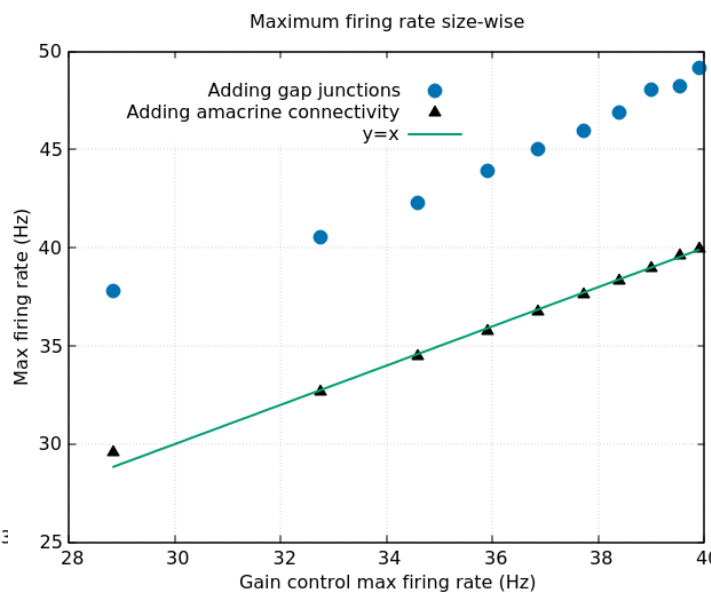
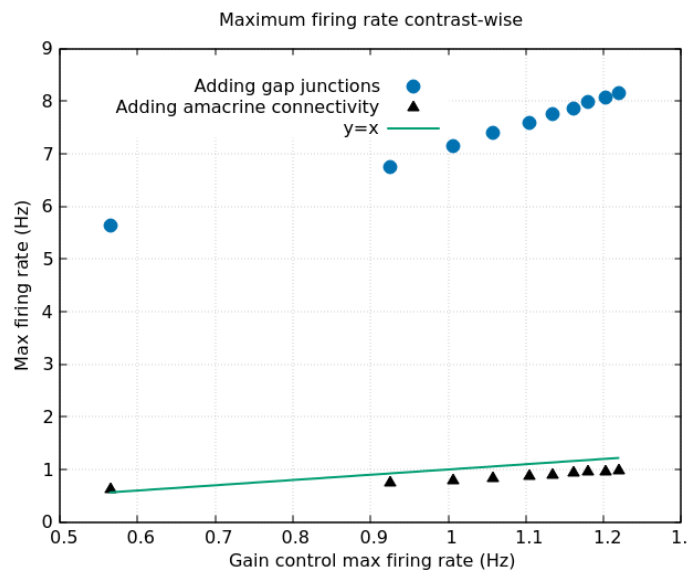
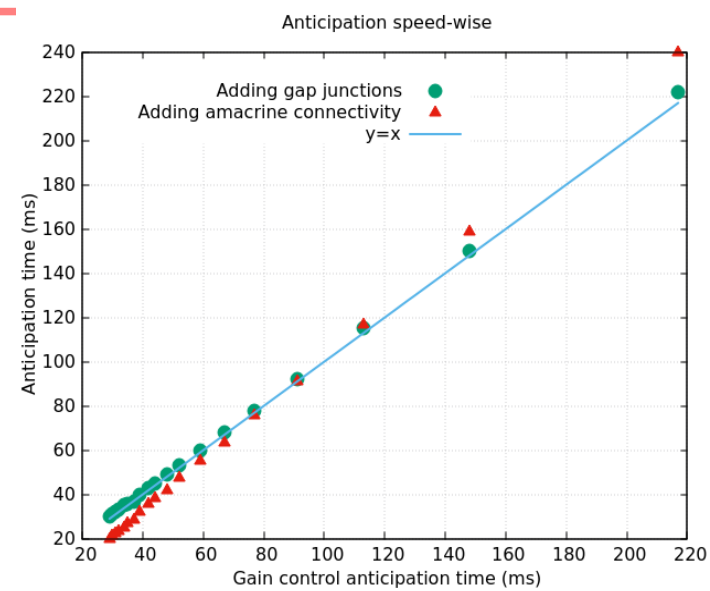
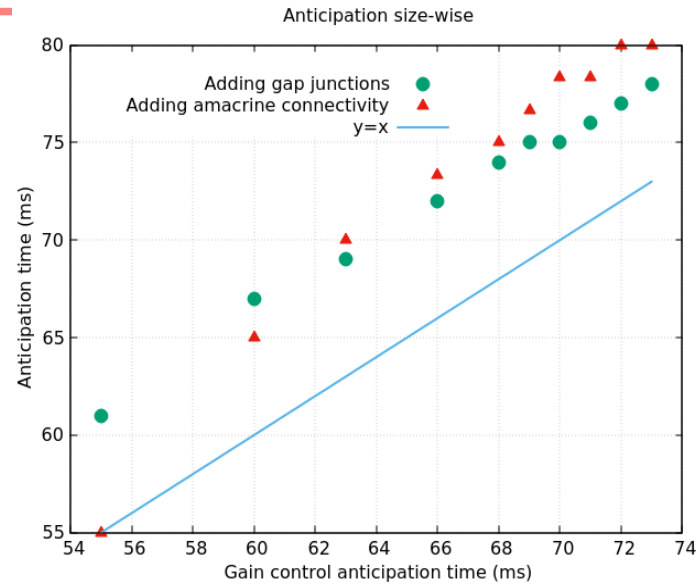
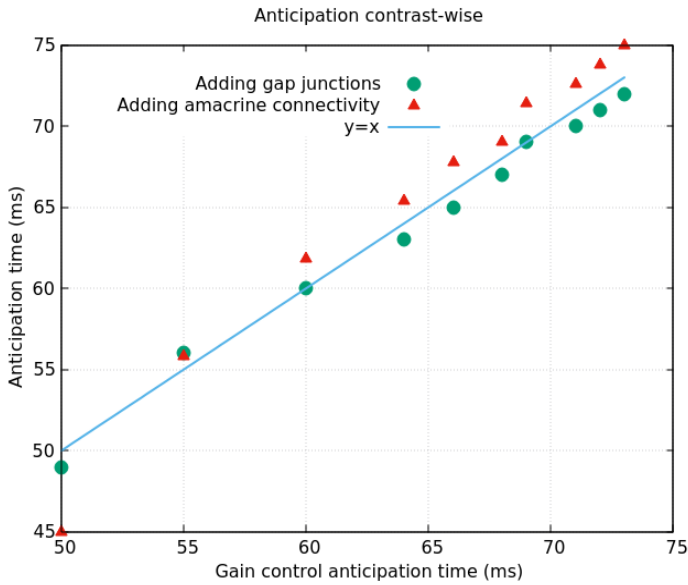



# Suggesting new experiments : 2D results

## 1) Angular anticipation

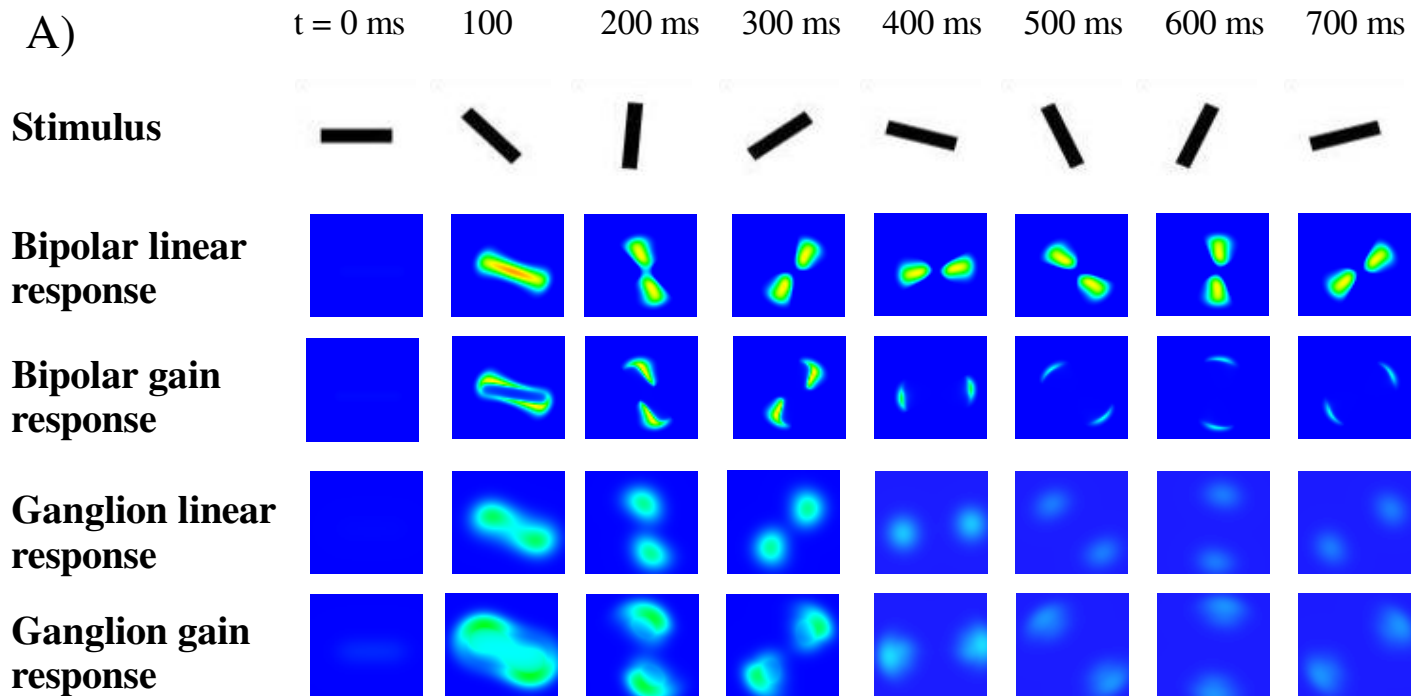

B)

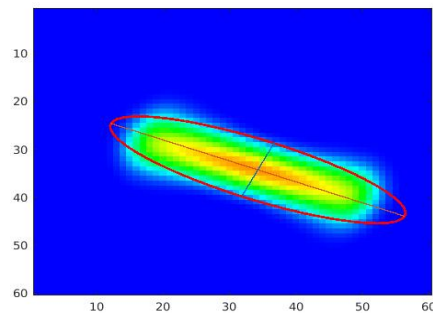

C)

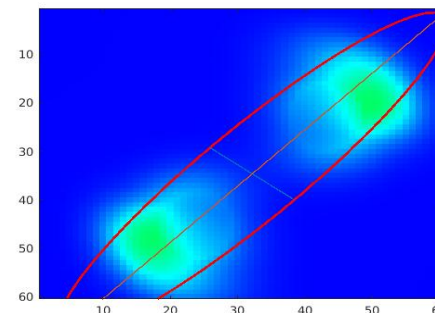

# Suggesting new experiments : 2D results

## 1) Angular anticipation

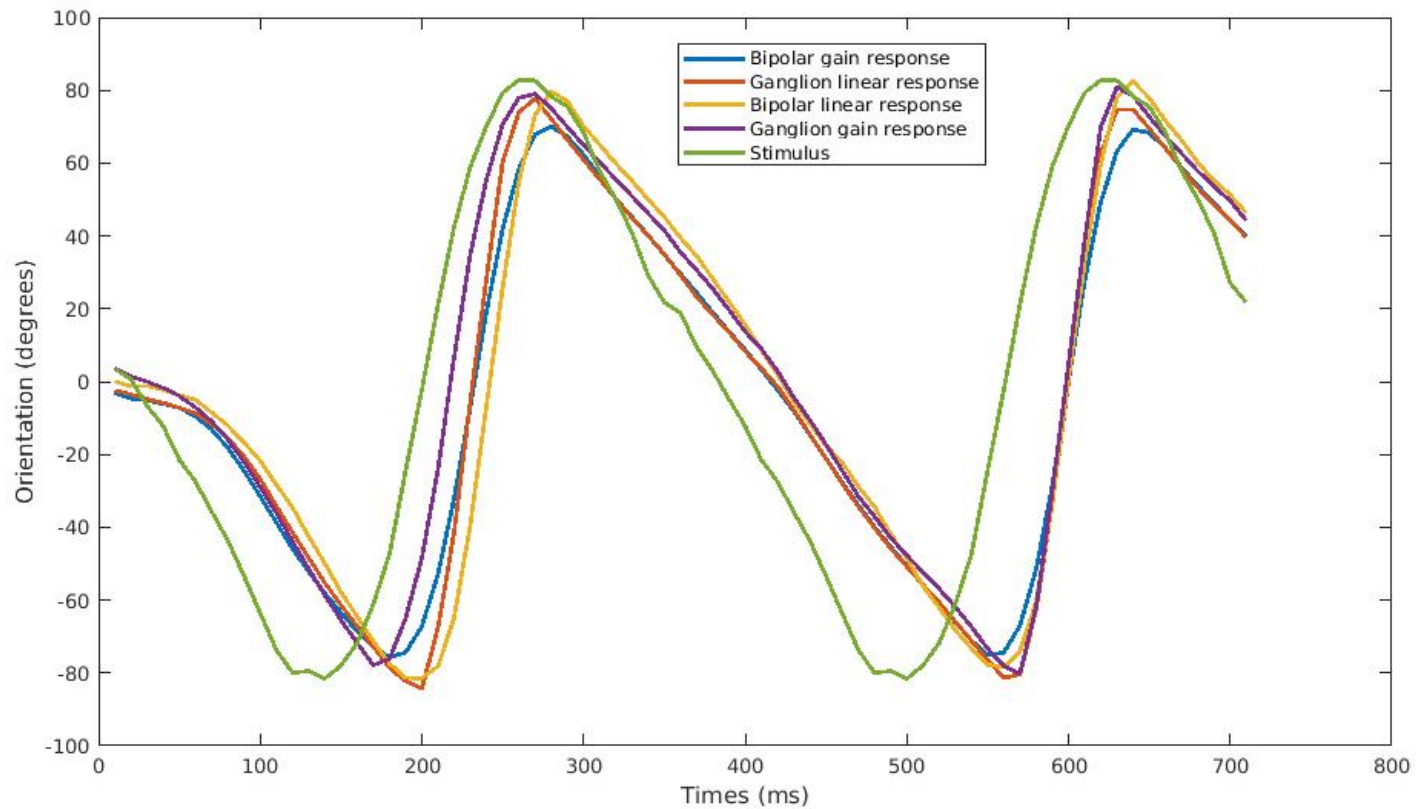

# Suggesting new experiments : 2D results

## 2) Anticipation and shape

Stimulus



Bipolar linear  
activity



Ganglion gain  
control activity



# Suggesting new experiments : 2D results

## 2) Anticipation on a noisy background

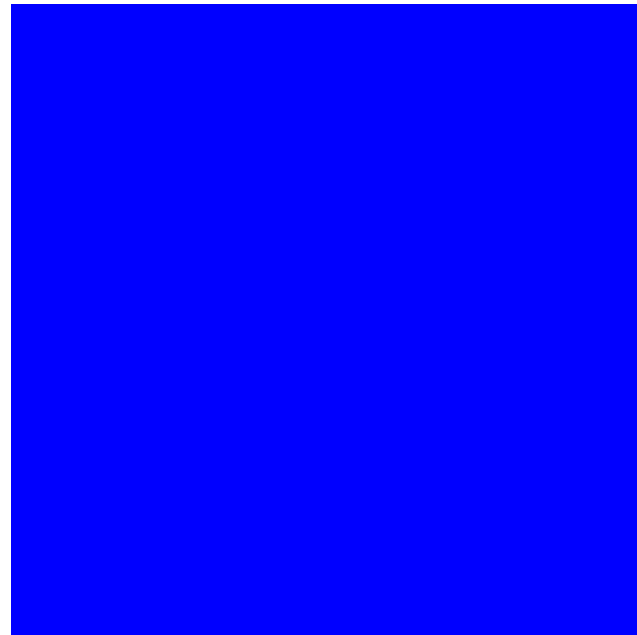

## II ) Anticipation in V1

# Anticipation in V1

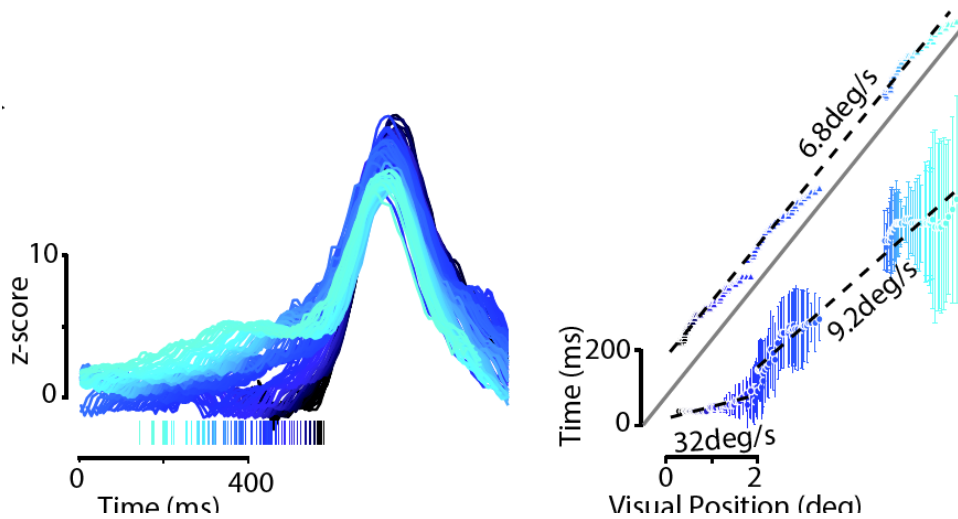

Source : Benvenuti et al. 2015

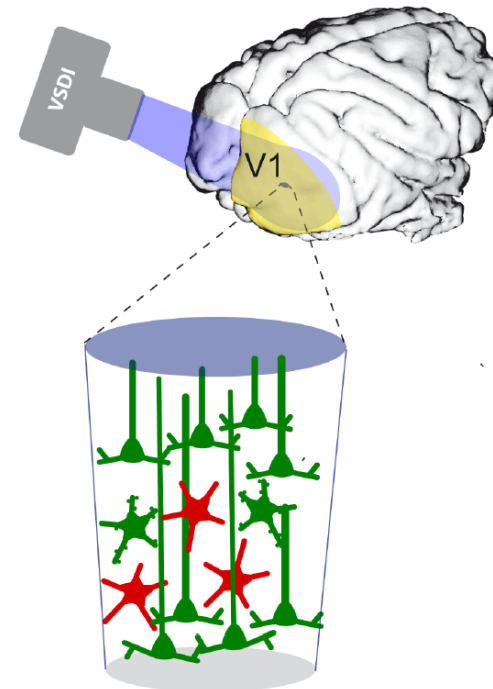

# Anticipation in the cortex : VSDI data analysis

(Data courtesy of F. Chavane et S. Chemla)

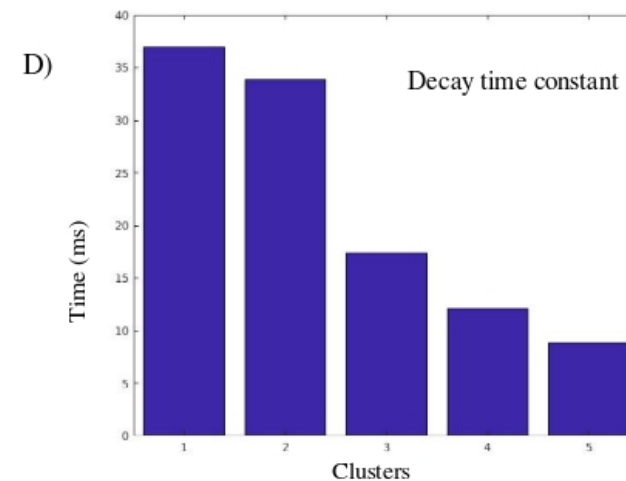
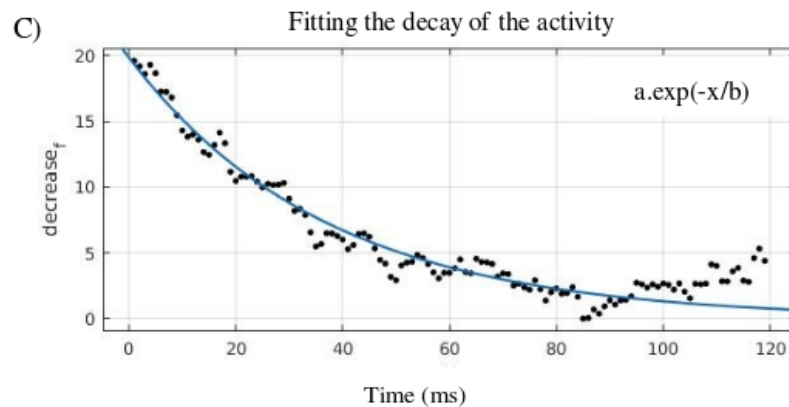
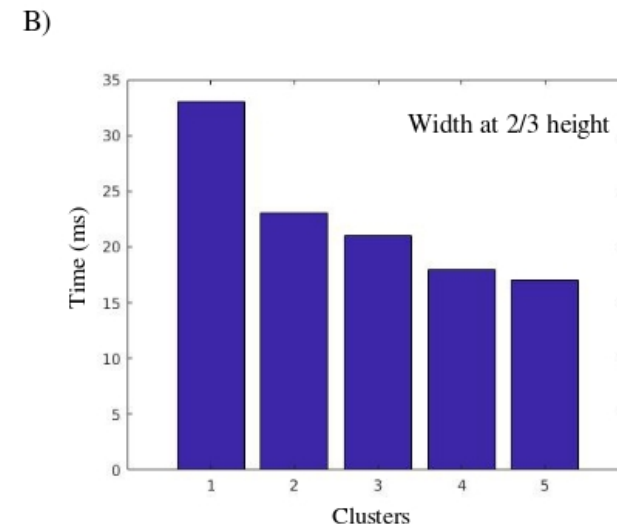
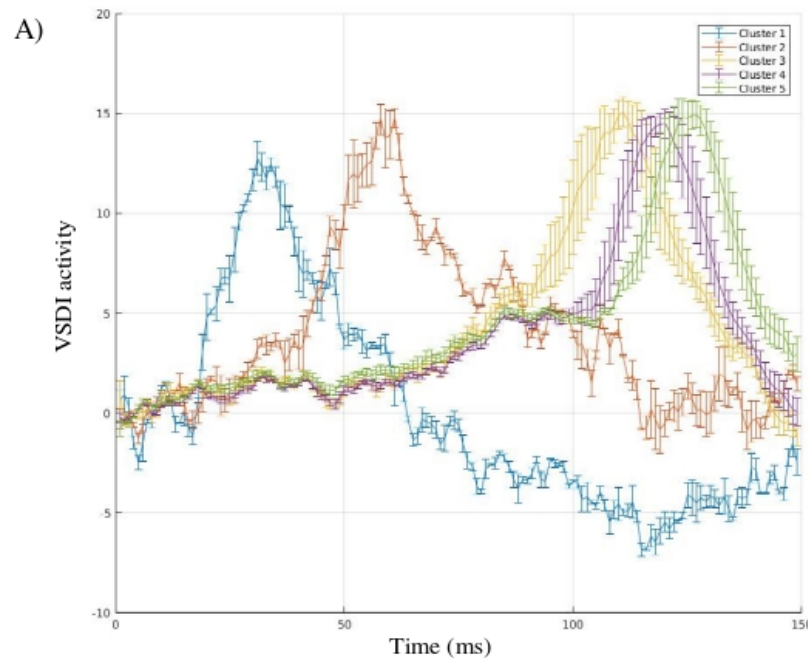

# A mean field model to reproduce VSDI recordings

Zerlaut et al 2016  
Chemla et al 2018

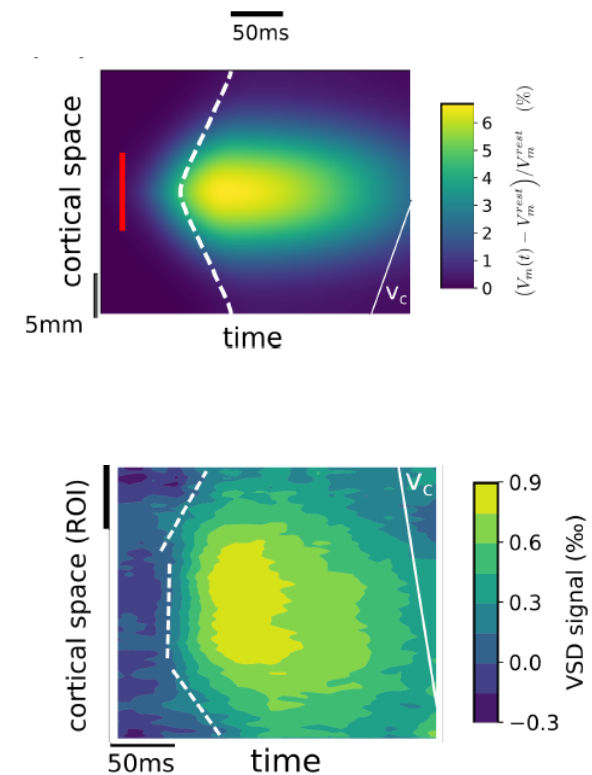
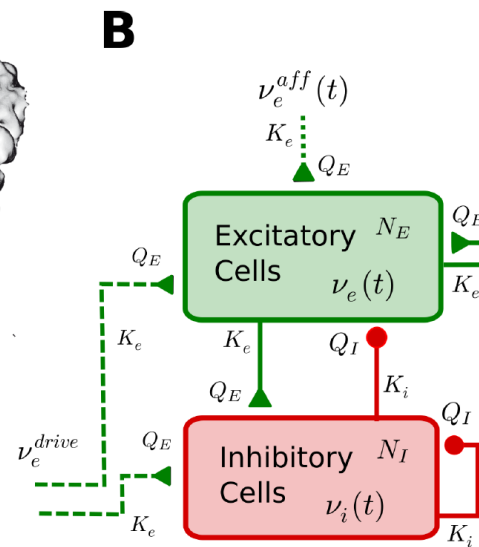
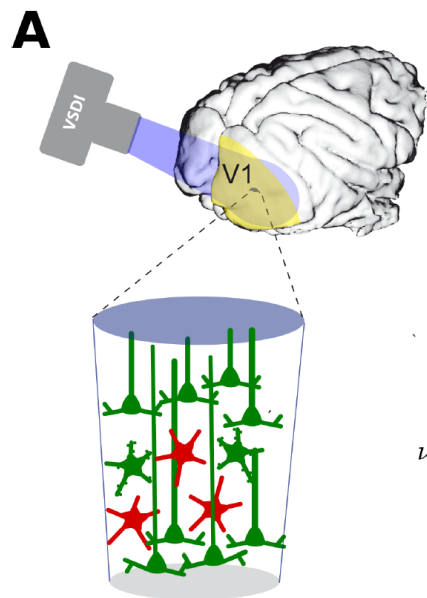



# Response of the cortical model to a LN retina drive

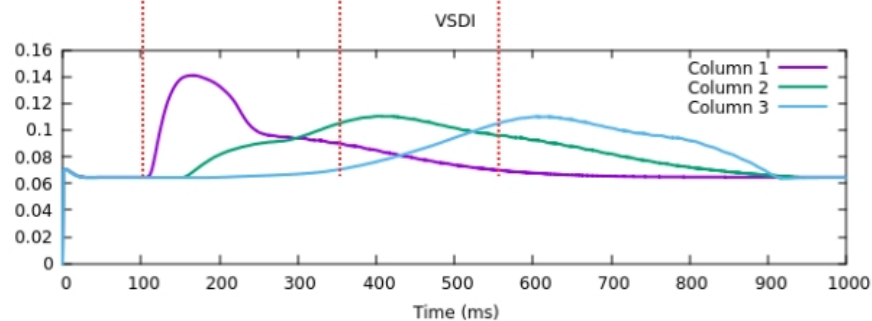
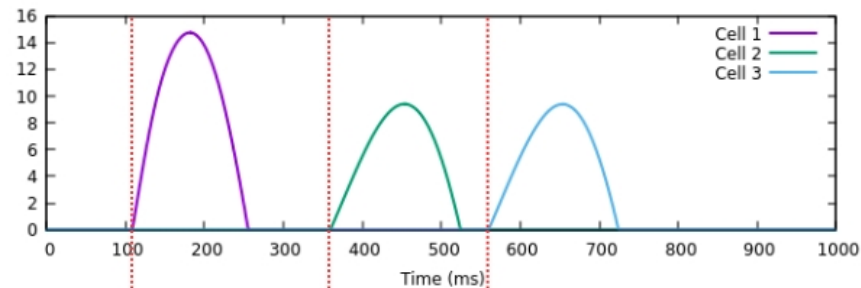
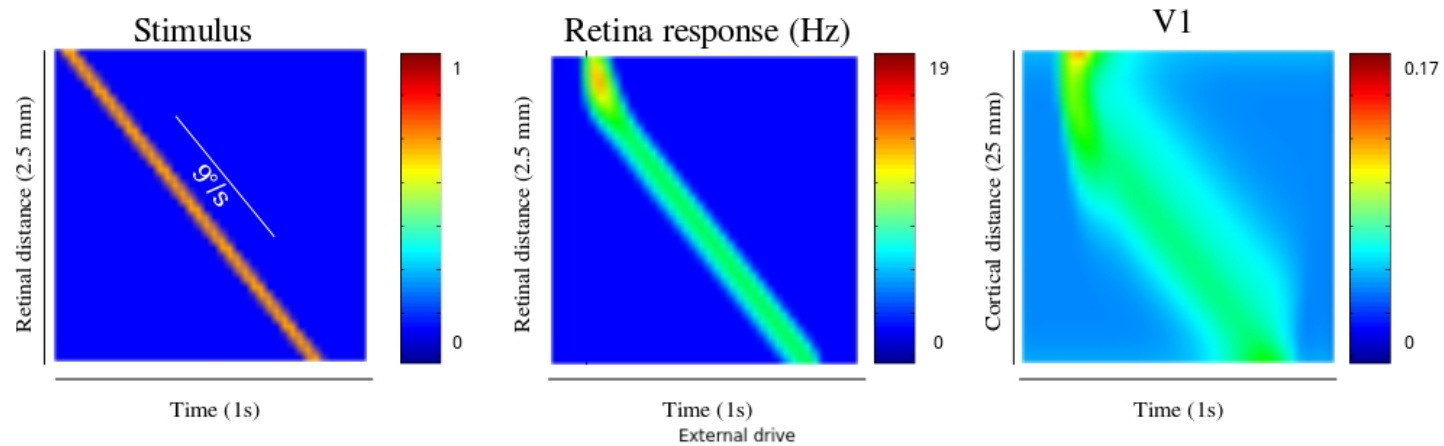

# Response of the cortical model to a retina drive with gain control

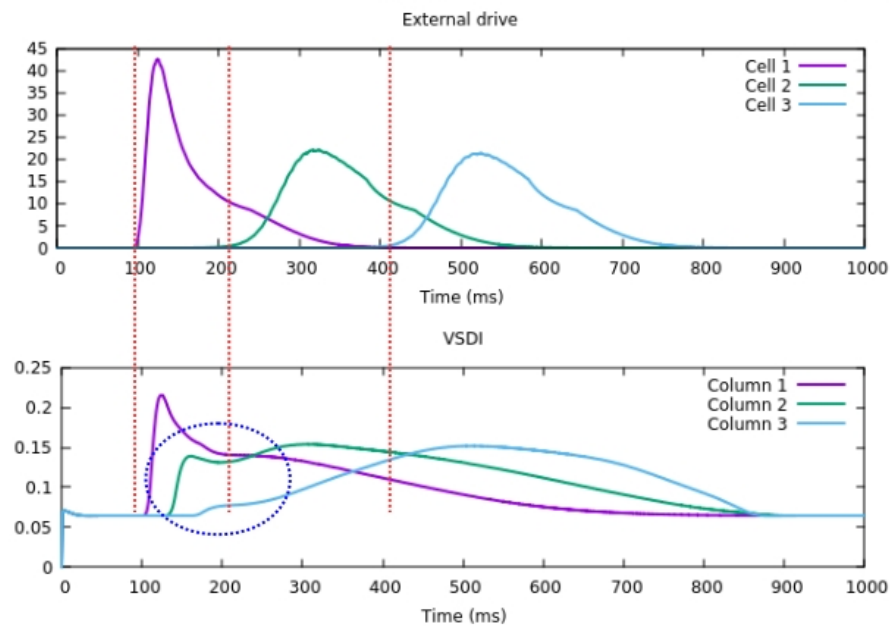
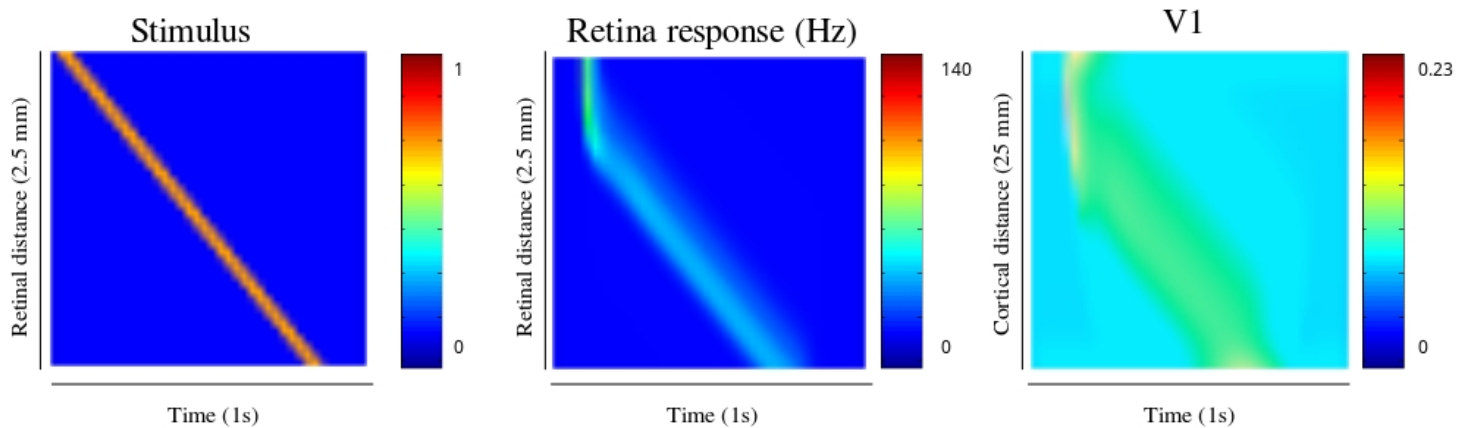

# Comparing simulation results to VSDI recordings

Cortex experimental recordings

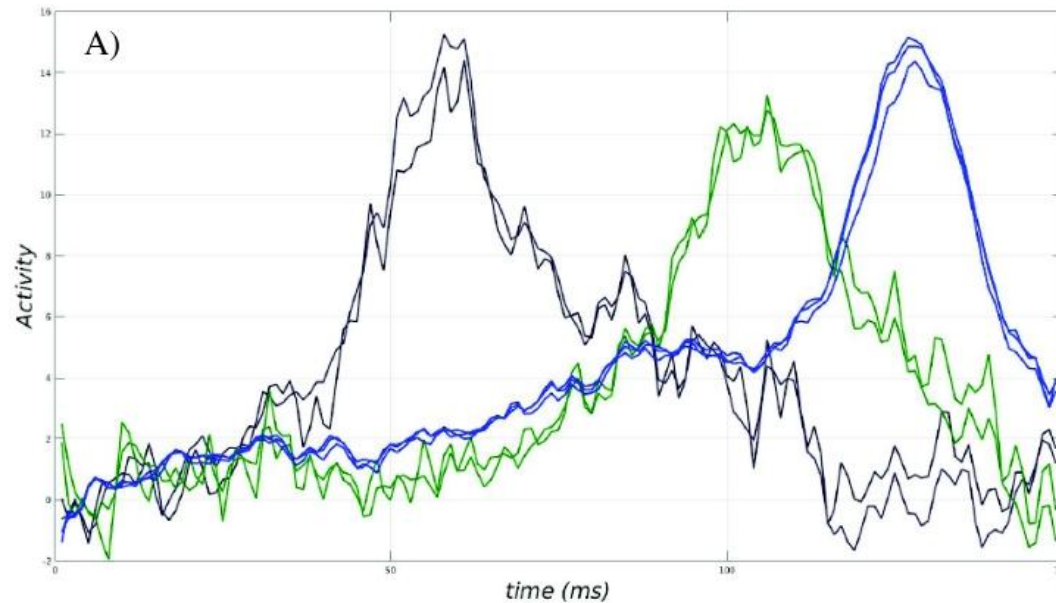

Simulation results  
Response to an LN  
model of the retina

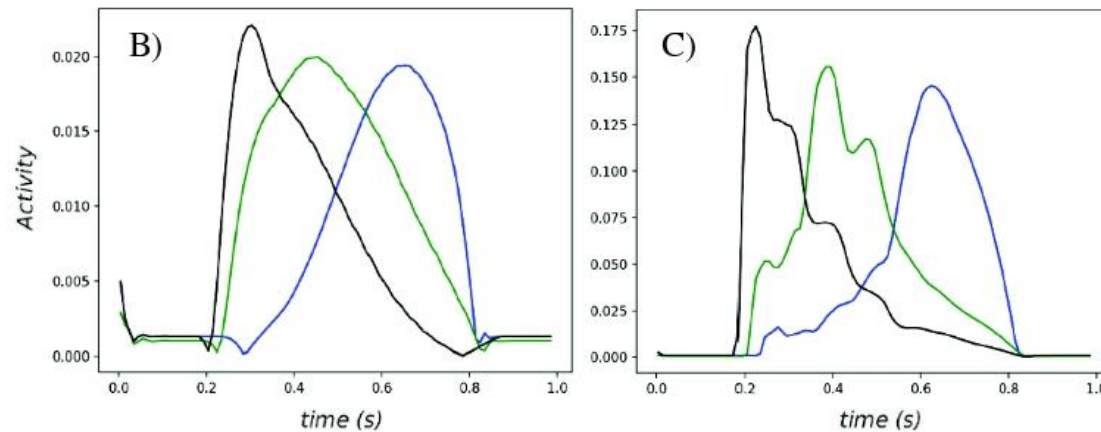

Simulation results  
Response to a gain  
control model of the  
retina

# Conclusions

- We developed a 2D retina with three ganglion cell layers, implementing gain control and connectivity.
- We use the output of our model as an input to a mean field model of V1, and were able to reproduce anticipation as observed in VSDI

## Questions :

- How to improve object identification 1) exploring the model's parameters and 2) using connectivity ?
- Is our model able to anticipate more complex trajectories, with accelerations for instance ?
- How to calibrate connectivity using biology ?
- How does anticipation affect higher order correlations ?
- Would it be possible to design psycho-physical tests clearly showing the role of the retina in visual anticipation ?

Thank you for your attention !

# Supplementary material

# Stimulus integration

$$\left[ K_i \begin{smallmatrix} S, t \\ * \end{smallmatrix} \mathcal{S} \right] (t) = \int_{-\infty}^t K_T(t-u) \left[ \int_{\mathbb{R}^2} K_{i,S}(x, y) \mathcal{S}(x, y, u) dx dy \right] du \equiv V_{i,drive}(t).$$

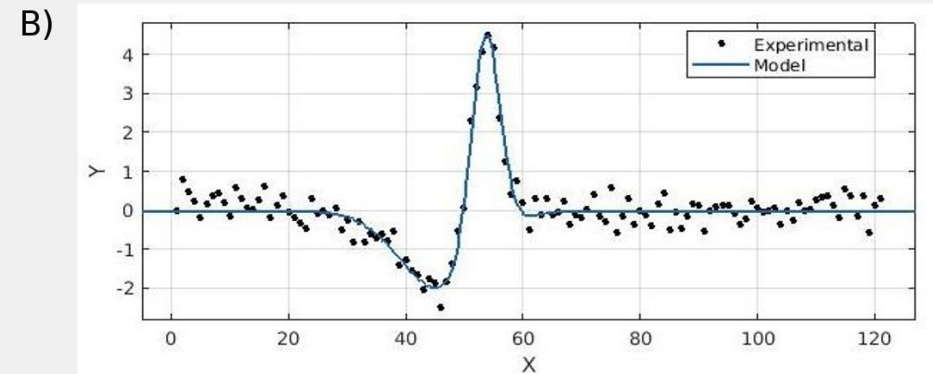
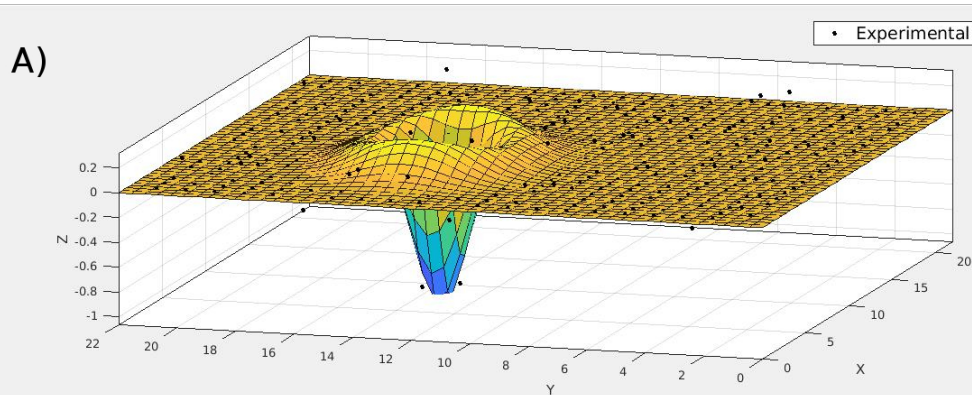

$$K_{i,S}(x, y) = \frac{A_1}{2\pi\sqrt{\det C_1}} e^{-\frac{1}{2} \bar{X}_1 \cdot C_1^{-1} \cdot X_1} - \frac{A_2}{2\pi\sqrt{\det C_2}} e^{-\frac{1}{2} \bar{X}_1 \cdot C_2^{-1} \cdot X_1},$$

$$K_T(t) = \left( \frac{K_1}{\sqrt{2\pi}\sigma_1} e^{-\frac{(t-\mu_1)^2}{2\sigma_1^2}} - \frac{K_2}{\sqrt{2\pi}\sigma_2} e^{-\frac{(t-\mu_2)^2}{2\sigma_2^2}} \right) H(t)$$

(Data courtesy of O. Marre )

# Stimulus integration : anisotropy

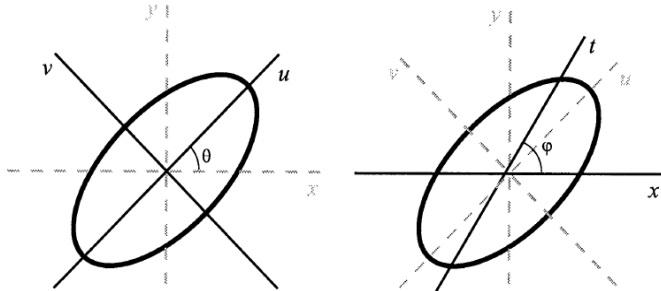

Geusebroek et al. 2003

$$\sigma_{x'} = \frac{\sigma_x \sigma_y}{\sqrt{\sigma_x^2 \cos^2 \theta + \sigma_y^2 \sin^2 \theta}}$$

$$\sigma_\phi = \frac{\sqrt{\sigma_y^2 \cos^2 \theta + \sigma_x^2 \sin^2 \theta}}{\sin \phi}$$

$$\tan(\phi) = \frac{\sigma_y^2 \cos^2 \theta + \sigma_x^2 \sin^2 \theta}{(\sigma^2 - \sigma_y^2) \cos \theta \sin \theta}$$

$$I = \sigma_{x'} \sqrt{\frac{\pi}{2}} \sum_{(i;j) \in [0, s_x] \times [0, s_y]} \int_{y - \frac{\delta}{\sin(\phi)}}^{(y+1) \frac{\delta}{\sin(\phi)}} C_{ij} e^{-\frac{(y'-y'_0)^2}{2\sigma_\phi^2}}$$

$$[erf(\frac{(-\cos(\phi)y' + x + 1)\delta - x'_0}{\sqrt{2}\sigma_{x'}}) - erf(\frac{(-\cos(\phi)y' + x)\delta - x'_0}{\sqrt{2}\sigma_{x'}})] dy'$$

$\Theta = 0^\circ$

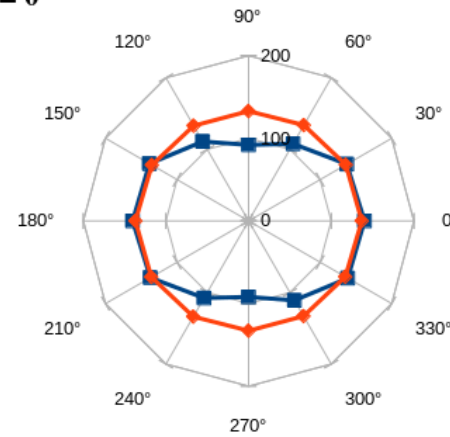

$\Theta = 30^\circ$

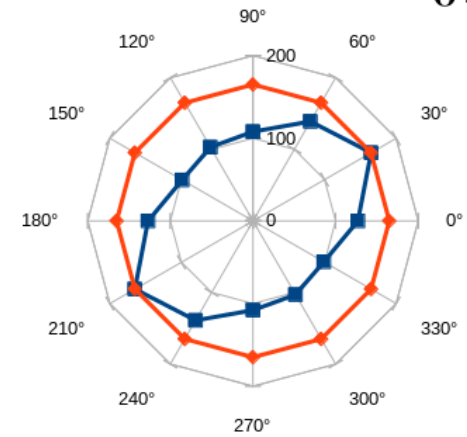

$\Theta = 90^\circ$

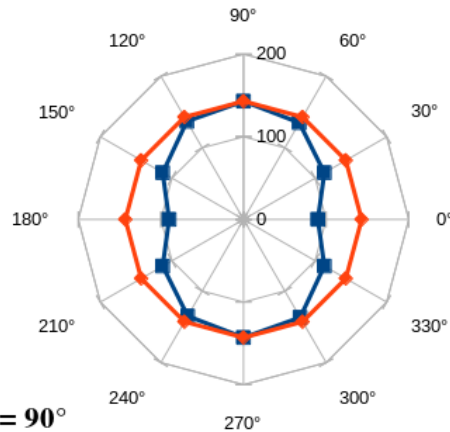

$\Theta = 120^\circ$

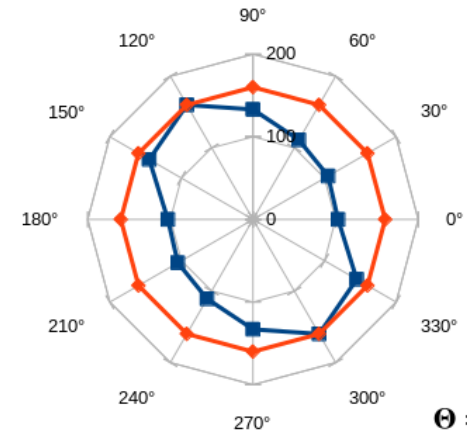



# Connectivity graph

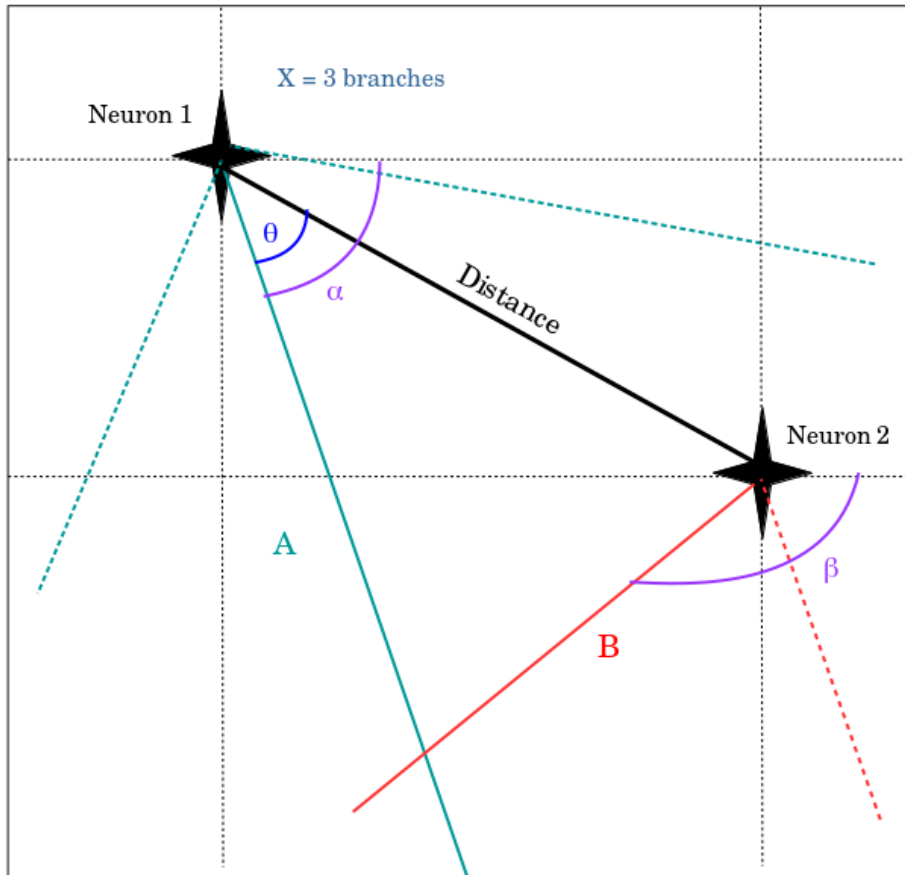

- Variables of the model :
- Number of branches  $N$
  - Branch length  $X$
  - Branch angle  $\alpha$

$$F_X(x) = \int_0^1 \frac{1}{\pi\sqrt{1-\delta^2}} \frac{x}{x+\delta} d\delta$$

$$\sin\left(\beta + \frac{\arcsin |y_j - y_i|}{\sqrt{(x_j - y_i)^2 + (y_j - x_j)^2}}\right)$$

# Cortex mean field model

Zerlaut et al 2016  
Chemla et al 2018

Single neuron model (The adaptive exponential integrate and fire model Brette and Gerstner, 2005 )

$$\begin{cases} C_m \frac{dV}{dt} = g_L (E_L - V) + I_{syn}(V, t) + k_a e^{\frac{V - V_{thre}}{k_a}} - I_w \\ \tau_w \frac{dI_w}{dt} = -I_w + a \cdot (V - E_L) + \sum_{t_s \in \{t_{spike}\}} b \delta(t - t_s) \end{cases}$$

The conductance-based exponential synapse

$$I_{syn}(V, t) = \sum_{s \in \{e, i\}} \sum_{t_s \in \{t_s\}} Q_s (E_s - V) e^{-\frac{t-t_s}{\tau_s}} \mathcal{H}(t - t_s)$$

Semi analytical transfer function :

$$\nu_{out} = \mathcal{F}(\nu_e, \nu_i) = \frac{1}{2\tau_V} \cdot \text{Erfc}\left(\frac{V_{thre}^{eff} - \mu_V}{\sqrt{2}\sigma_V}\right) \quad \text{with} \quad V_{thre}^{eff}(\mu_V, \sigma_V, \tau_V^N) = P_0 + \sum_{x \in \{\mu_V, \sigma_V, \tau_V^N\}} P_x \cdot \left(\frac{x - x^0}{\delta x^0}\right) + P_{\mu_G} \log\left(\frac{\mu_G}{g_L}\right) \\ + \sum_{x, y \in \{\mu_V, \sigma_V, \tau_V^N\}^2} P_{xy} \cdot \left(\frac{x - x^0}{\delta x^0}\right) \left(\frac{y - y^0}{\delta y^0}\right)$$

# Cortex mean field model

Zerlaut et al 2016  
Chemla et al 2018

The mean, standard deviation and auto-correlation time of the excitatory and inhibitory conductance read :

$$\begin{array}{l}
 \mu_{Ge}(\nu_e, \nu_i) = \nu_e K_e \tau_e Q_e \\
 \sigma_{Ge}(\nu_e, \nu_i) = \sqrt{\frac{\nu_e K_e \tau_e}{2}} Q_e \\
 \mu_{Gi}(\nu_e, \nu_i) = \nu_i K_i \tau_i Q_i \\
 \sigma_{Gi}(\nu_e, \nu_i) = \sqrt{\frac{\nu_i K_i \tau_i}{2}} Q_i
 \end{array}
 \longrightarrow
 \begin{array}{l}
 \mu_G(\nu_e, \nu_i) = \mu_{Ge} + \mu_{Gi} + g_L \\
 \tau_m(\nu_e, \nu_i) = \frac{C_m}{\mu_G} \\
 \downarrow \\
 \mu_V(\nu_e, \nu_i) = \frac{\mu_{Ge} E_e + \mu_{Gi} E_i + g_L E_L}{\mu_G} \\
 \sigma_V(\nu_e, \nu_i) = \sqrt{\sum_s K_s \nu_s \frac{(U_s \cdot \tau_s)^2}{2(\tau_m^{\text{eff}} + \tau_s)}} \\
 \tau_V(\nu_e, \nu_i) = \left( \frac{\sum_s (K_s \nu_s (U_s \cdot \tau_s)^2)}{\sum_s (K_s \nu_s (U_s \cdot \tau_s)^2 / (\tau_m^{\text{eff}} + \tau_s))} \right)
 \end{array}$$

Finally, the transfer function reads :

$$\nu_{out} = \mathcal{F}(\nu_e, \nu_i) = \frac{1}{2\tau_V} \cdot \text{Erfc}\left(\frac{V_{thre}^{\text{eff}} - \mu_V}{\sqrt{2}\sigma_V}\right)$$

# Cortex mean field model

Zerlaut et al 2016  
Chemla et al 2018

Master equation for first and second moments local population dynamics (El Boustani and Destexhe, 2009) read :

$$\left\{ \begin{array}{l} T \frac{\partial \nu_\mu}{\partial t} = (\mathcal{F}_\mu - \nu_\mu) + \frac{1}{2} c_{\lambda\eta} \frac{\partial^2 \mathcal{F}_\mu}{\partial \nu_\lambda \partial \nu_\eta} \\ T \frac{\partial c_{\lambda\eta}}{\partial t} = A_{\lambda\eta} + (\mathcal{F}_\lambda - \nu_\lambda) (\mathcal{F}_\eta - \nu_\eta) + \\ \quad c_{\lambda\mu} \frac{\partial \mathcal{F}_\mu}{\partial \nu_\lambda} + c_{\mu\eta} \frac{\partial \mathcal{F}_\mu}{\partial \nu_\eta} - 2c_{\lambda\eta} \end{array} \right. \longrightarrow T \frac{\partial \nu_\mu}{\partial t} = \mathcal{F}_\mu - \nu_\mu$$

$$A_{\lambda\eta} = \begin{cases} \frac{\mathcal{F}_\lambda (1/T - \mathcal{F}_\lambda)}{N_\lambda} & \text{if } \lambda = \eta \\ 0 & \text{otherwise} \end{cases}$$