



HAL
open science

Anticipation in the retina and the primary visual cortex: towards an integrated retino-cortical model for motion processing

Selma Souihel, Bruno Cessac

► **To cite this version:**

Selma Souihel, Bruno Cessac. Anticipation in the retina and the primary visual cortex: towards an integrated retino-cortical model for motion processing. ICMNS 2019 - The 5th International Conference on Mathematical NeuroScience, Jun 2019, Copenhagen, Denmark. hal-02167737

HAL Id: hal-02167737

<https://inria.hal.science/hal-02167737>

Submitted on 28 Jun 2019

HAL is a multi-disciplinary open access archive for the deposit and dissemination of scientific research documents, whether they are published or not. The documents may come from teaching and research institutions in France or abroad, or from public or private research centers.

L'archive ouverte pluridisciplinaire **HAL**, est destinée au dépôt et à la diffusion de documents scientifiques de niveau recherche, publiés ou non, émanant des établissements d'enseignement et de recherche français ou étrangers, des laboratoires publics ou privés.



Anticipation in the retina and the primary visual cortex : towards an integrated retino-cortical model for motion processing

PhD student : Selma Souihel
Adviser : Dr Bruno Cessac
Team : Biovision



In collaboration with :

Matteo Di Volo
Alain Destexhe



Frédéric Chavane
Sandrine Chemla



Olivier Marre



The visual flow

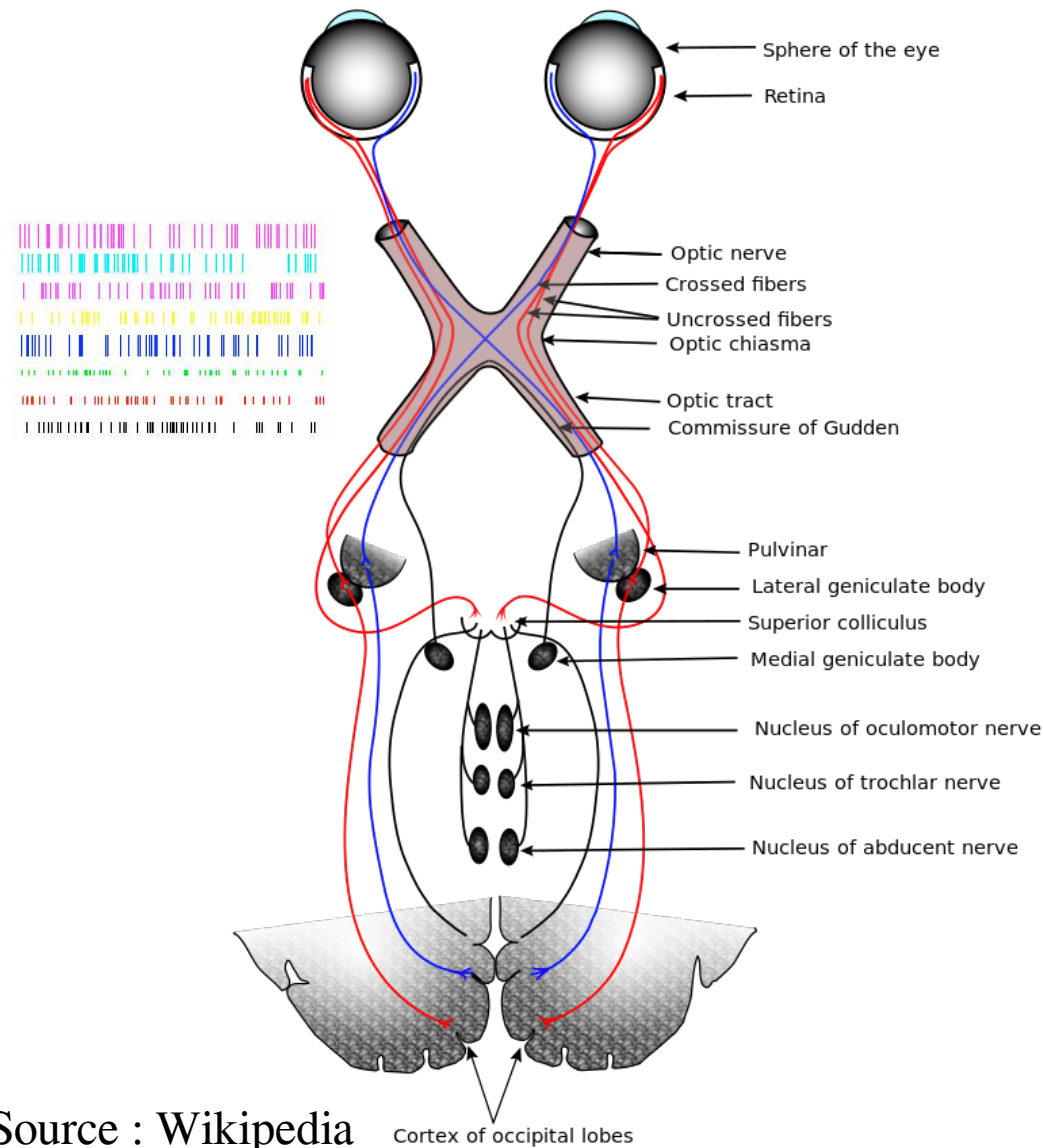

The visual flow

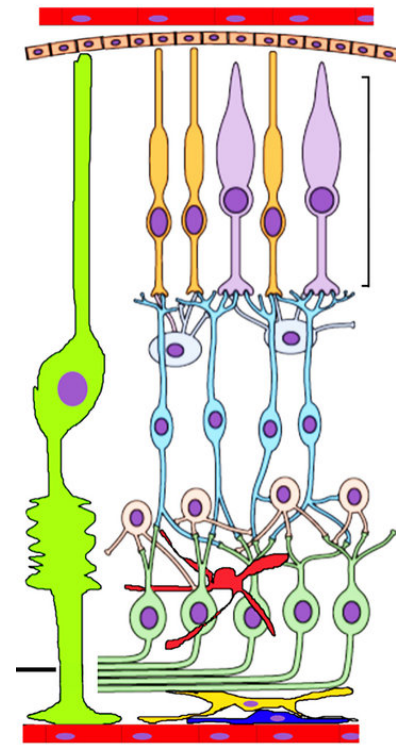
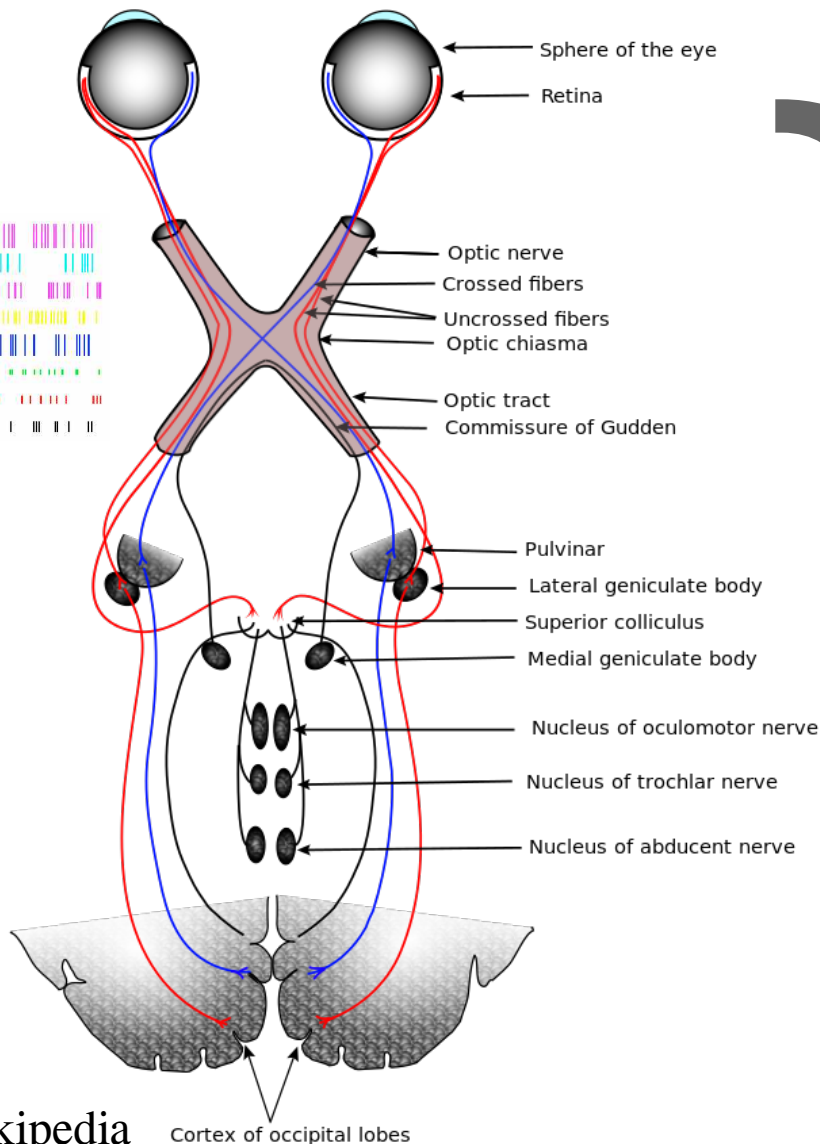

Source : Ryskamp et al. 2014

photoreceptors

bipolar cells

amacrine cells

ganglion cells

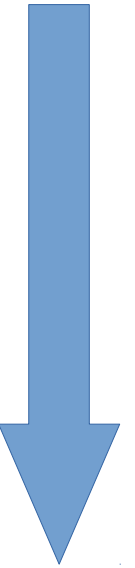

The visual flow

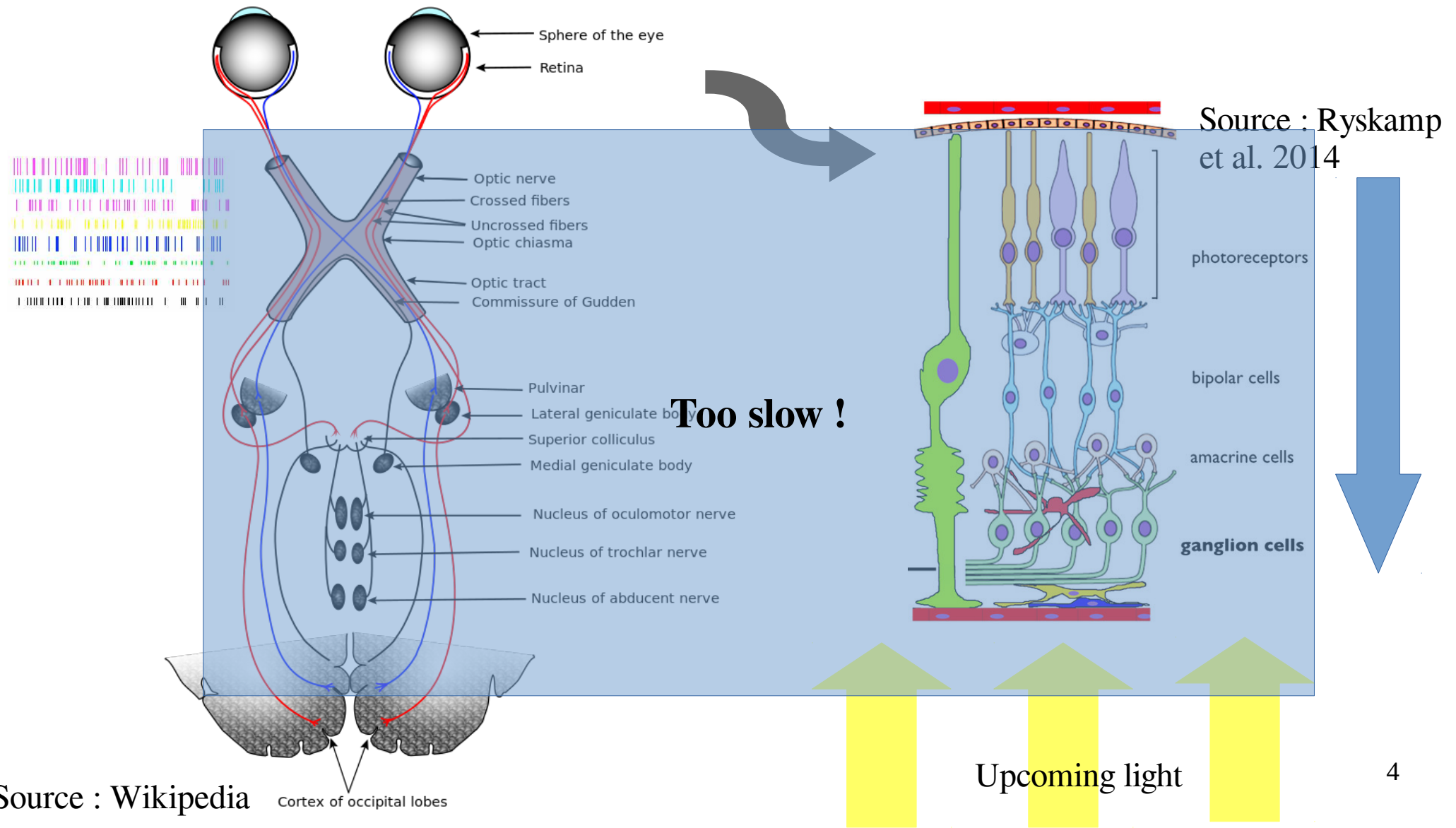

Stating the problem : Visual Anticipation

Anticipation is carried out by the primary visual cortex (V1) through an activation wave

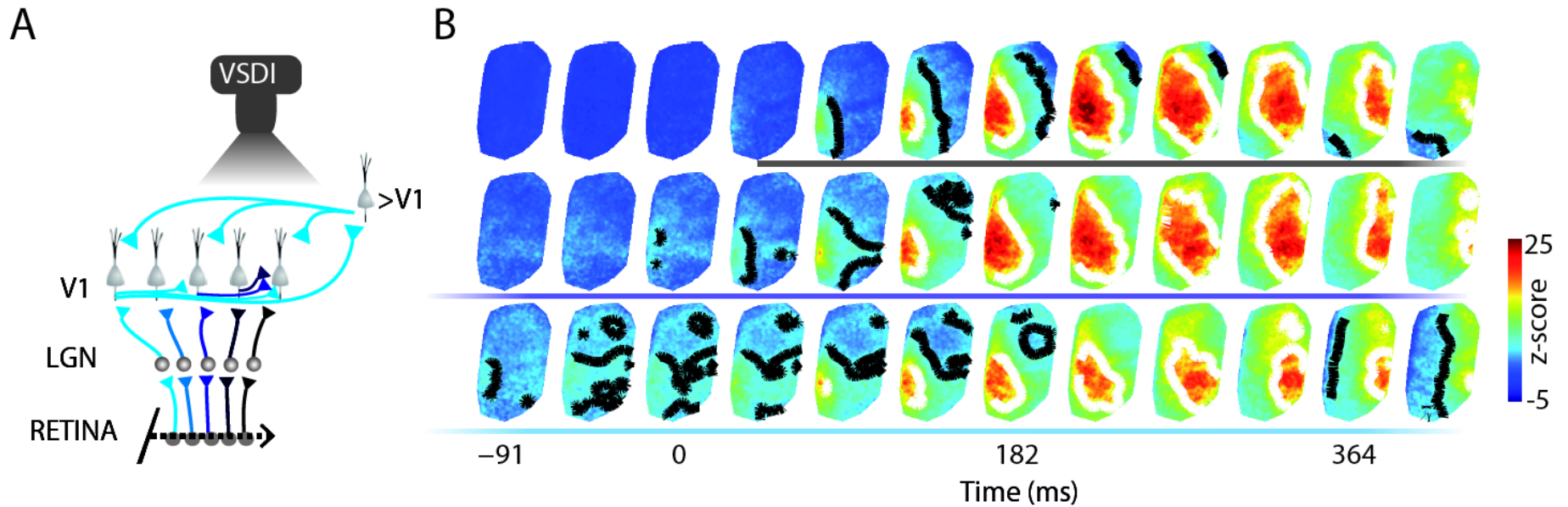

Source :
Benvenuti et
al. 2015

Stating the problem : Visual Anticipation

But the retina is not a mere transmitter, it is able to perform many computations such as :

- Orientation sensitivity
- Contrast gain control
- Sensitivity to differential motion
- and « **Motion Anticipation** »

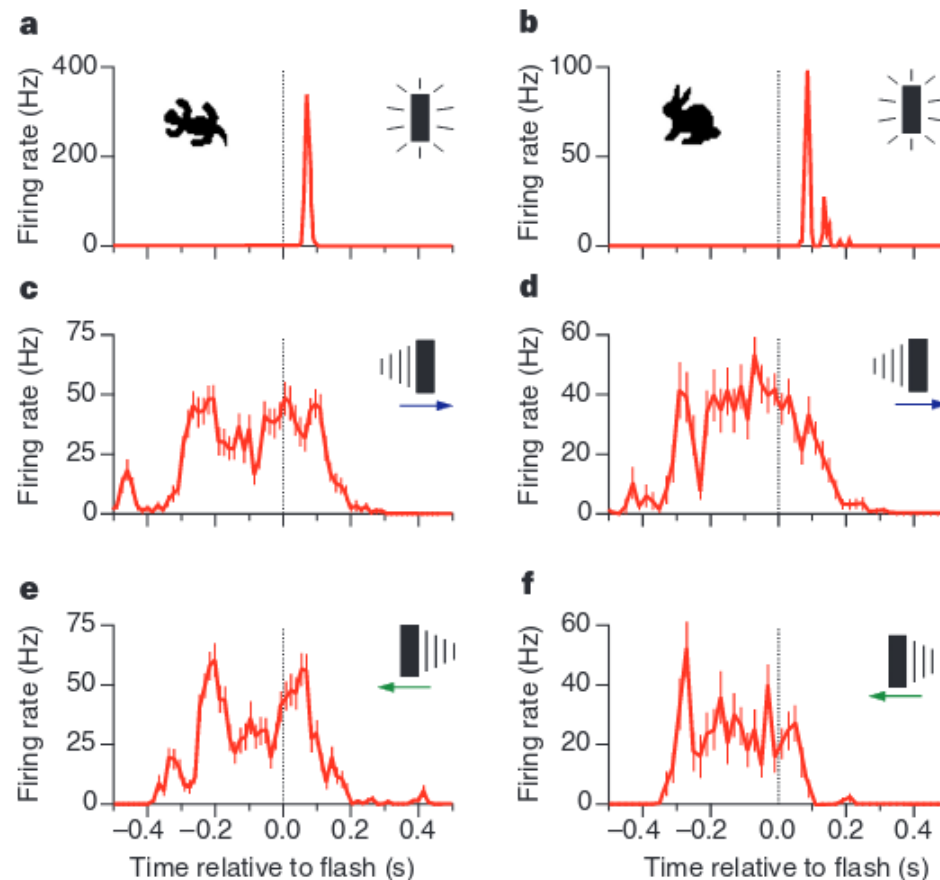

Source : Berry et al. 1999

Stating the problem : Visual Anticipation

- **What are the respective :**
- **Mechanisms underlying retinal and cortical anticipation?**
- **Role of each part ?**

I) Anticipation in the retina

The Hubel-Wiesel view of vision

Nobel prize 1981

Ganglion cells response is the convolution of the stimulus with a spatio-temporal receptive field followed by a non linearity

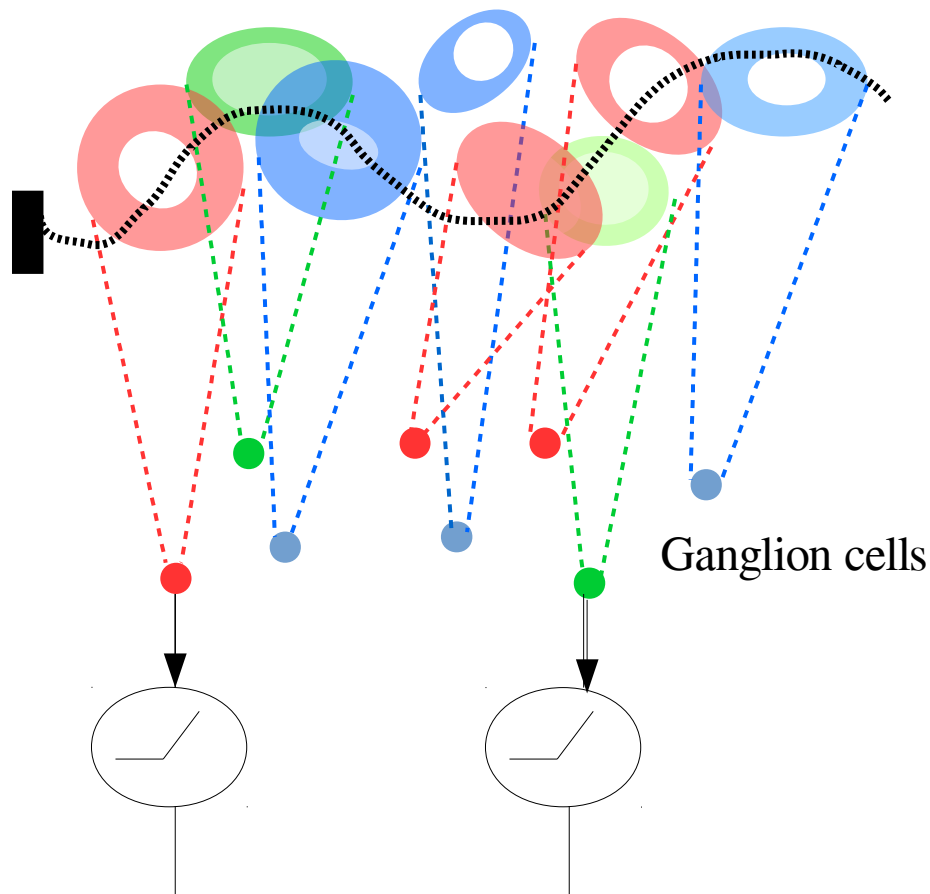

Ganglion cells are independent encoders

The Hubel-Wiesel view of vision

Nobel prize 1981

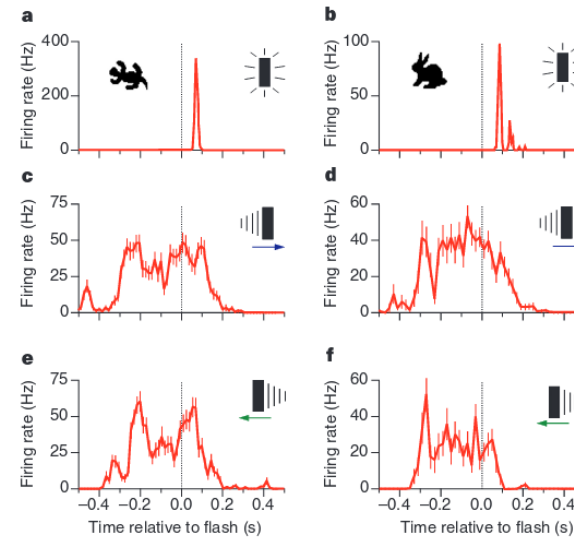
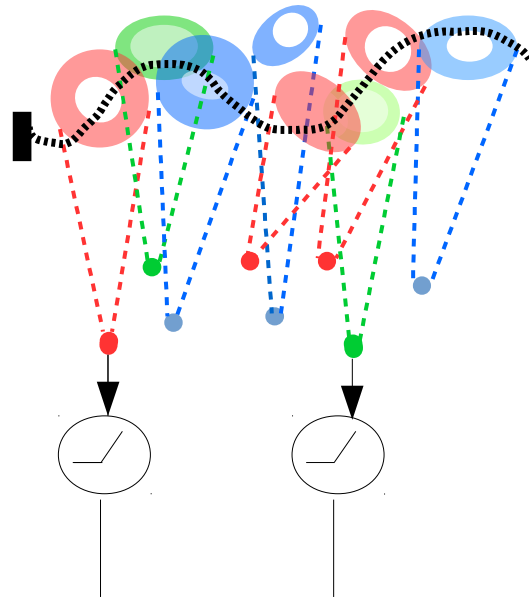

Source : Berry et al. 1999

➤ Which mechanism can account for motion anticipation in the retina ?

Building a 2D retina model for motion anticipation

1) Gain control (Chen et al. 2013)

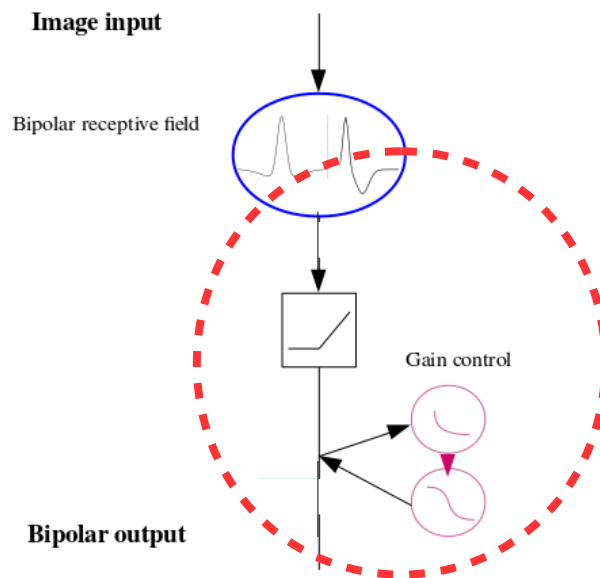

- Bipolar voltage :

$$\left[K_i \overset{S,t}{*} S \right] (t) = \int_{-\infty}^t K_T(t-u) \left[\int_{\mathbb{R}^2} K_{i,S}(x,y) S(x,y,u) dx dy \right] du$$

- Non-linear function :

$$\mathcal{N}_B(V_{B_i}) = \begin{cases} 0, & \text{if } V_{B_i} \leq \theta_B; \\ V_{B_i} - \theta_B, & \text{else.} \end{cases}$$

- Activation function :

$$\frac{dA_{B_i}}{dt} = -\frac{A_{B_i}}{\tau_a} + h \mathcal{N}(V_{B_i}(t)).$$

- Gain Control function :

$$\mathcal{G}_B(A) = \begin{cases} 0, & \text{if } A \leq 0; \\ \frac{1}{1+A^6}, & \text{else.} \end{cases}$$

- Output :

$$R_{B_i} = \mathcal{N}_B(V_{B_i}) \mathcal{G}_B(A_{B_i}).$$

Building a 2D retina model for motion anticipation

1) Gain control (Chen et al. 2013)

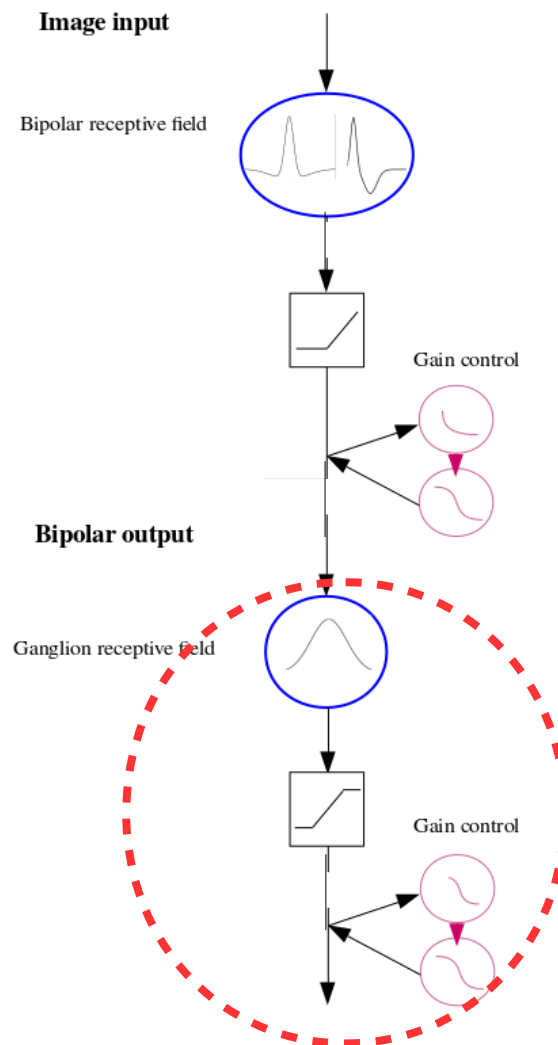
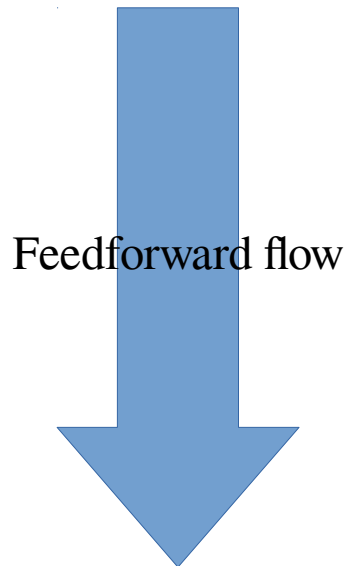

- Ganglion voltage

$$V_{G_k} = \sum_i W_{G_k}^{B_i} R_{B_i}$$

- Non-linear function :

$$\mathcal{N}_{G_F}(V) = \begin{cases} 0, & \text{if } V \leq 0; \\ \alpha_{G_F}(V - \theta_{G_F}), & \text{if } \theta_{G_F} \leq V \leq N_{G_F}^{max} / \alpha_{G_F} + \theta_{G_F} \\ N_{G_F}^{max}, & \text{else.} \end{cases}$$

- Activation function :

$$\frac{dA_{G_F k_F}}{dt} = -\frac{A_{G_F k_F}}{\tau_{G_F}} + h_{G_F} \mathcal{N}_{G_F}(V_{G_F k_F})$$

- Gain Control function :

$$\mathcal{G}_{G_F}(A) = \begin{cases} 0, & \text{if } A \leq 0; \\ \frac{1}{1+A}, & \text{else.} \end{cases}$$

- Output :

$$R_{G_F k_F}(V_{G_F k_F}, A_{G_F k_F}) = \mathcal{N}_{G_F}(V_{G_F k_F}) \mathcal{G}_{G_F}(A_{G_F k_F}).$$

1D results : smooth motion anticipation with gain control

Bipolar layer

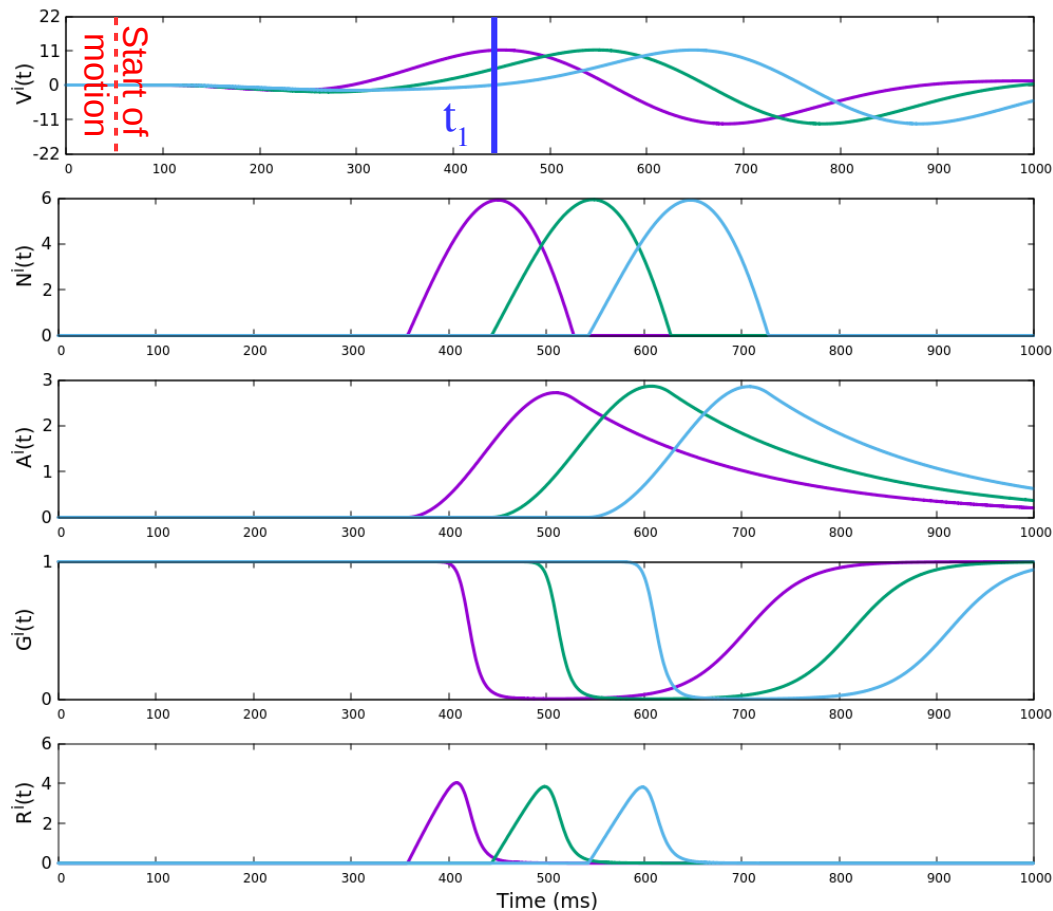

Ganglion layer

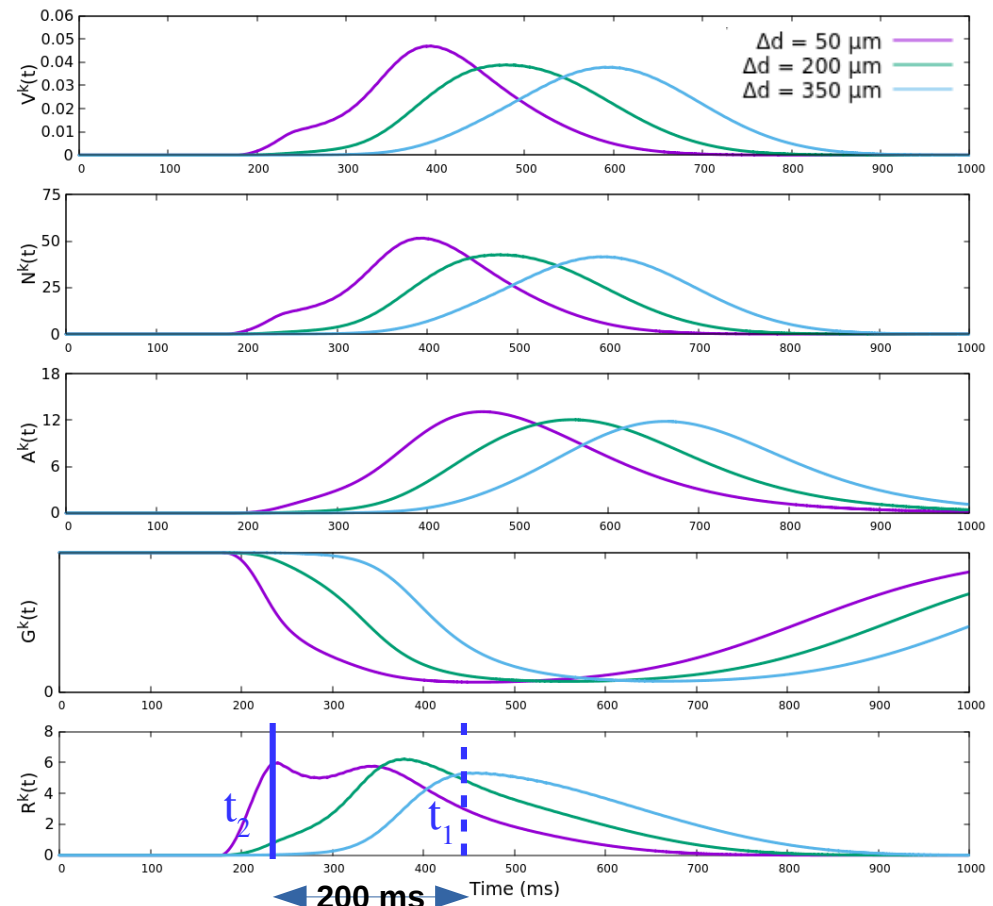

$$\text{Anticipation time} = |t_1 - t_2|$$

1D results : smooth motion anticipation with gain control

Anticipation variability with stimulus parameters

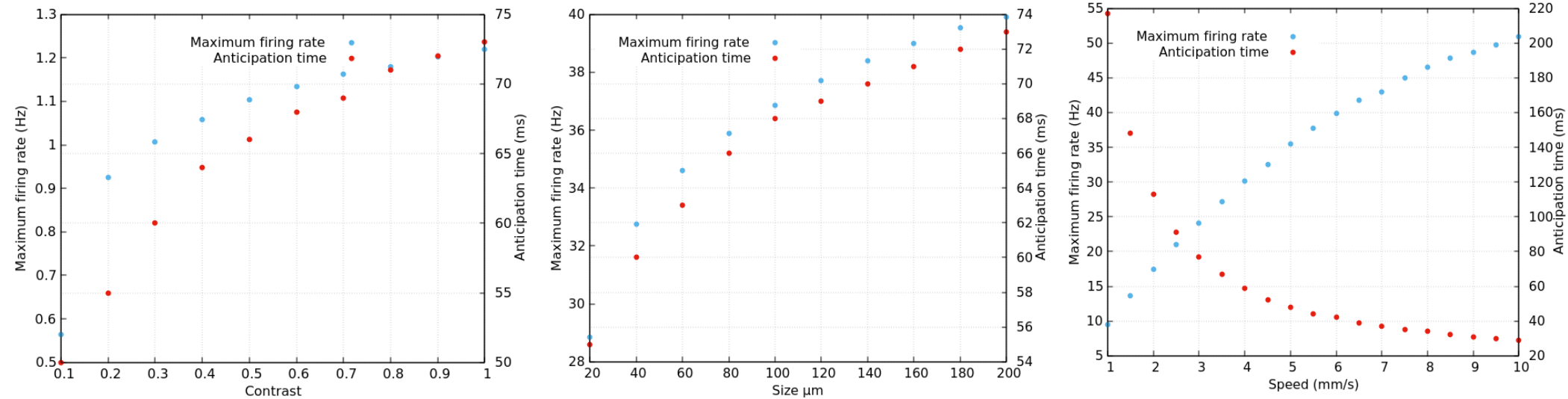

Building a 2D retina model for motion anticipation

2) Gap junction connectivity

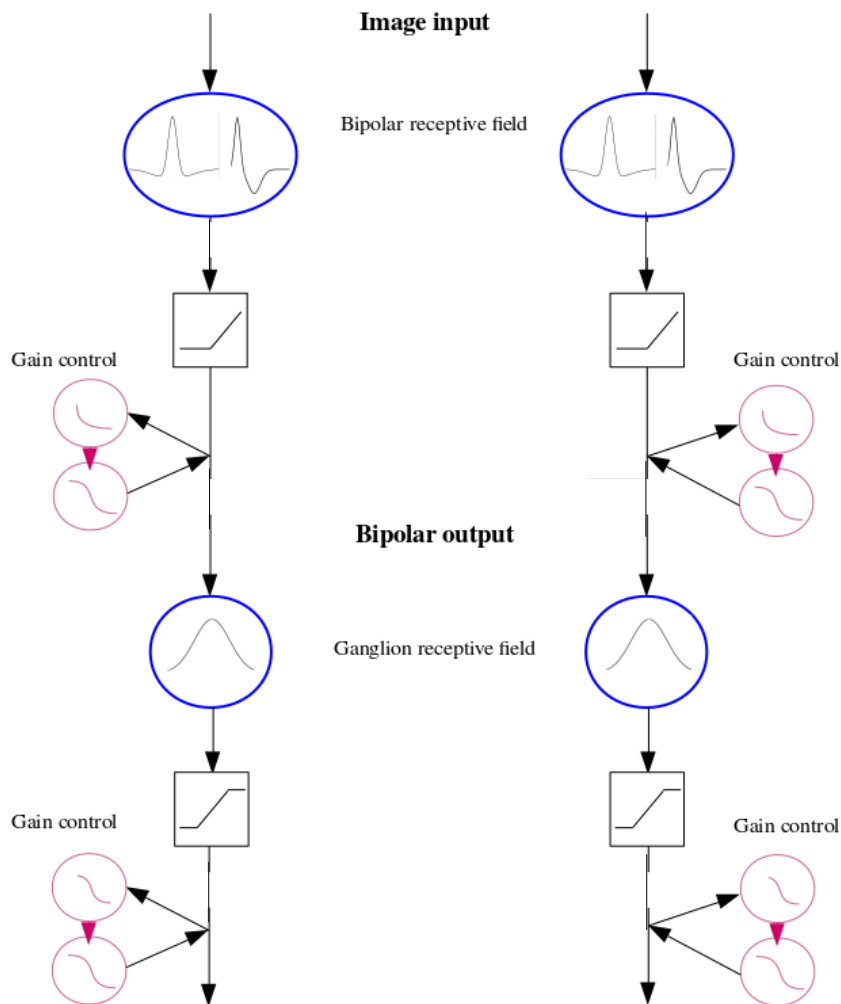

Ganglion cells are independent encoders

Building a 2D retina model for motion anticipation

2) Gap junction connectivity

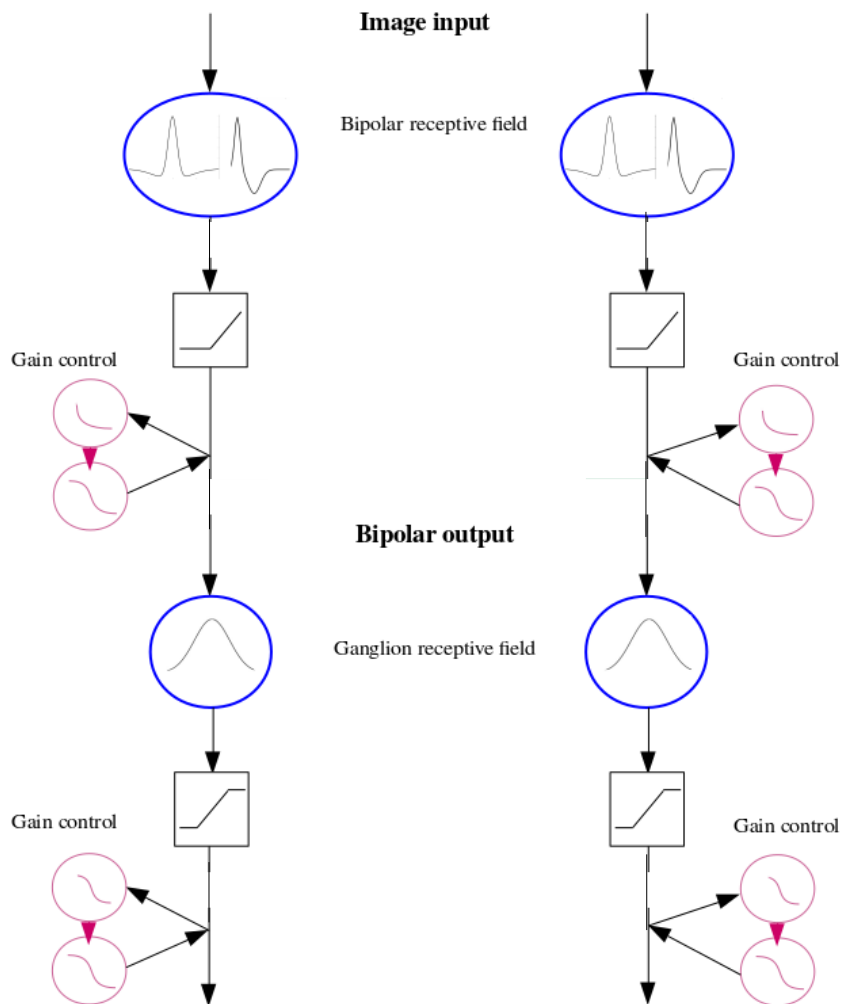

~~Ganglion cells are independent encoders~~

Building a 2D retina model for motion anticipation

2) Gap junction connectivity

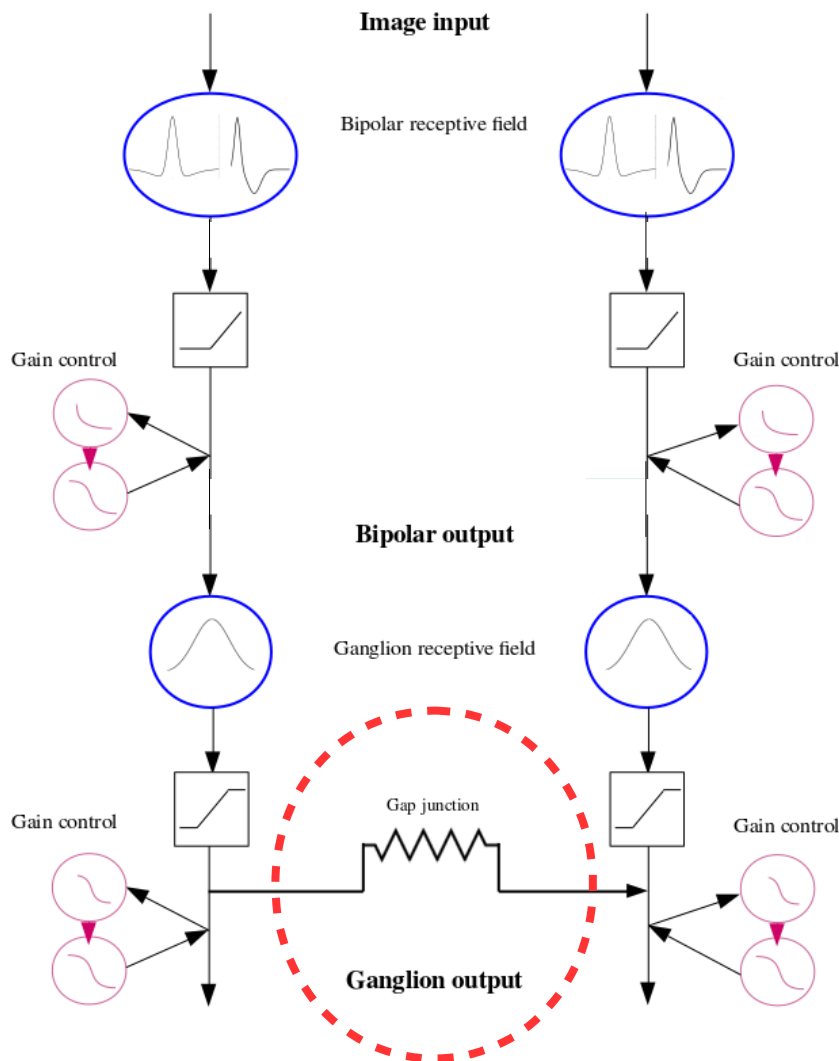

- A class of direction selective RGCs are connected through gap junctions
- Their activity comprises the activity pooled from bipolar cells and the activity coming from the downstream RGCs, in the direction of motion

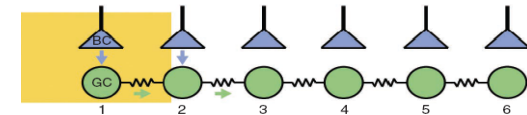

$$R_{GDkD} = V_{GDkD} + \beta R_{GDkD-1}$$

Trenholm & al. 2013

1D results : smooth motion anticipation with gap junctions

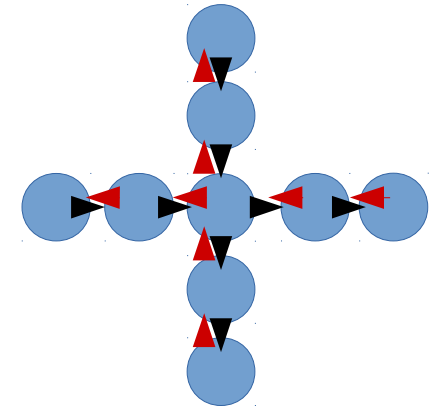
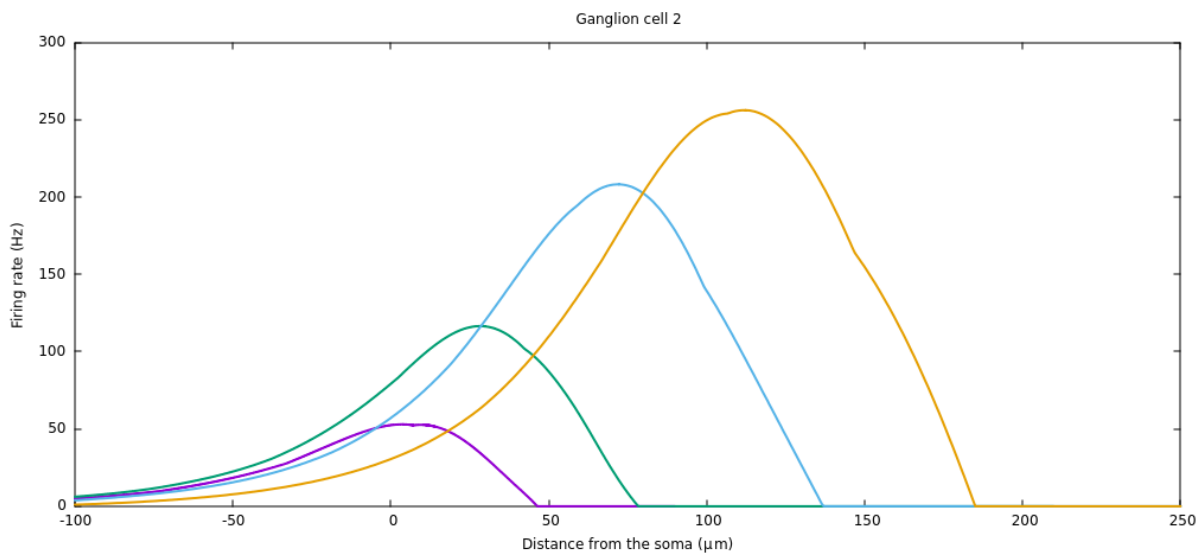

DSGCs in cardinal directions

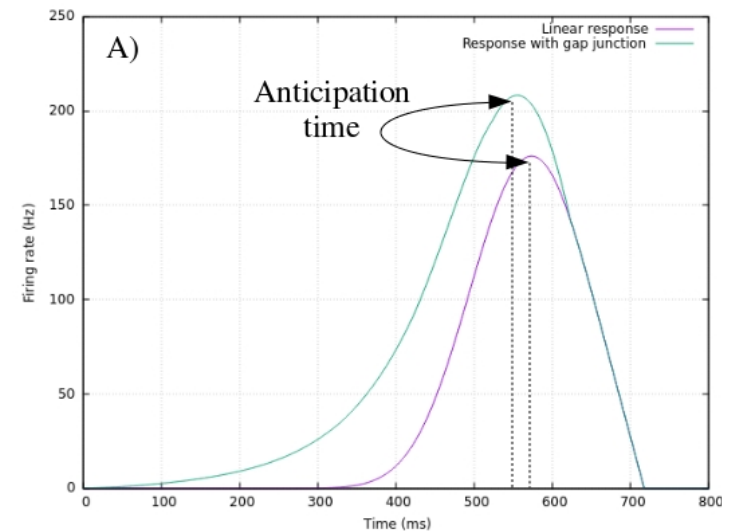

1D results : smooth motion anticipation with gap junctions

Anticipation variability with stimulus parameters

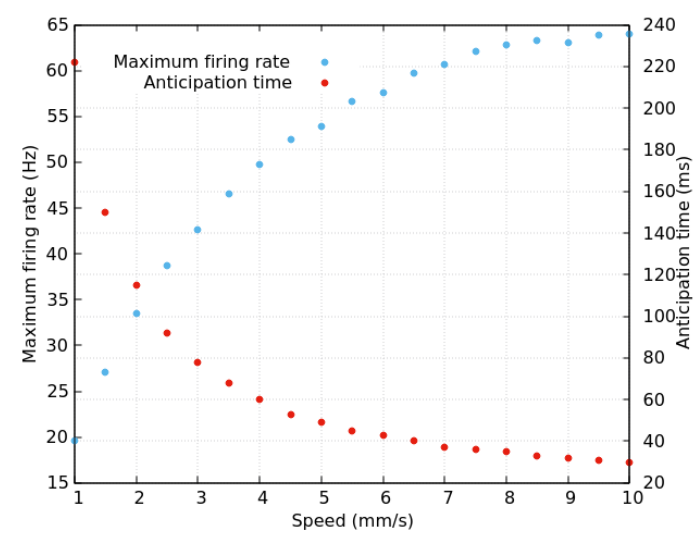
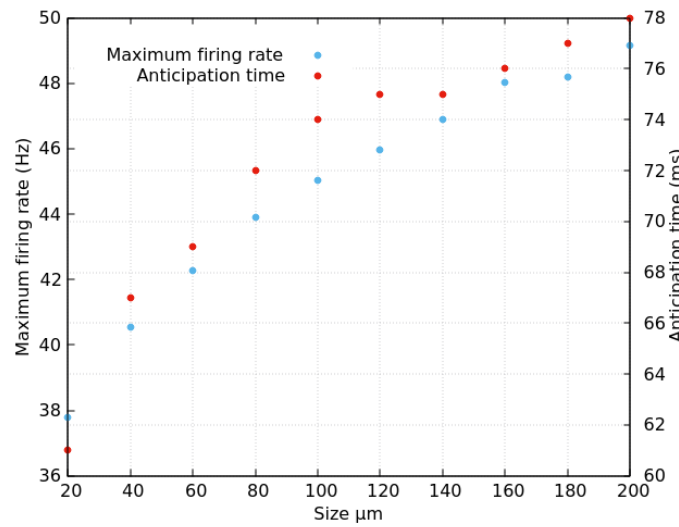
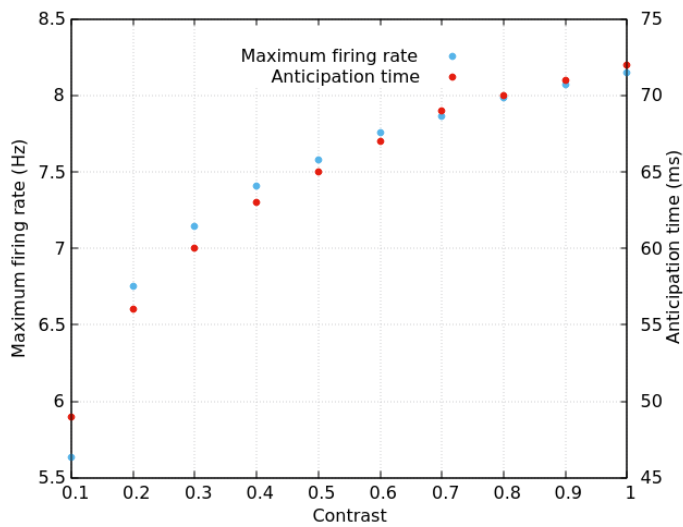

Building a 2D retina model for motion anticipation

3) Amacrine cells connectivity

- A class of RGCs are selective to differential motion

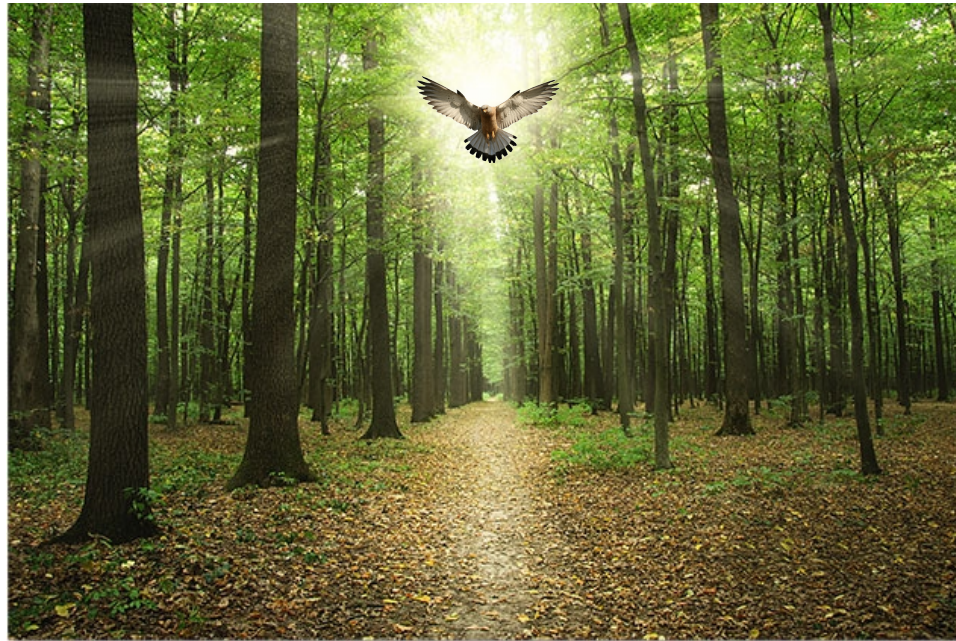

Building a 2D retina model for motion anticipation

3) Amacrine cells connectivity

- A class of RGCs are selective to differential motion



- The circuitry involves amacrine cells connectivity upstream of ganglion cells

Connectivity pathways

2) Amacrine cells connectivity

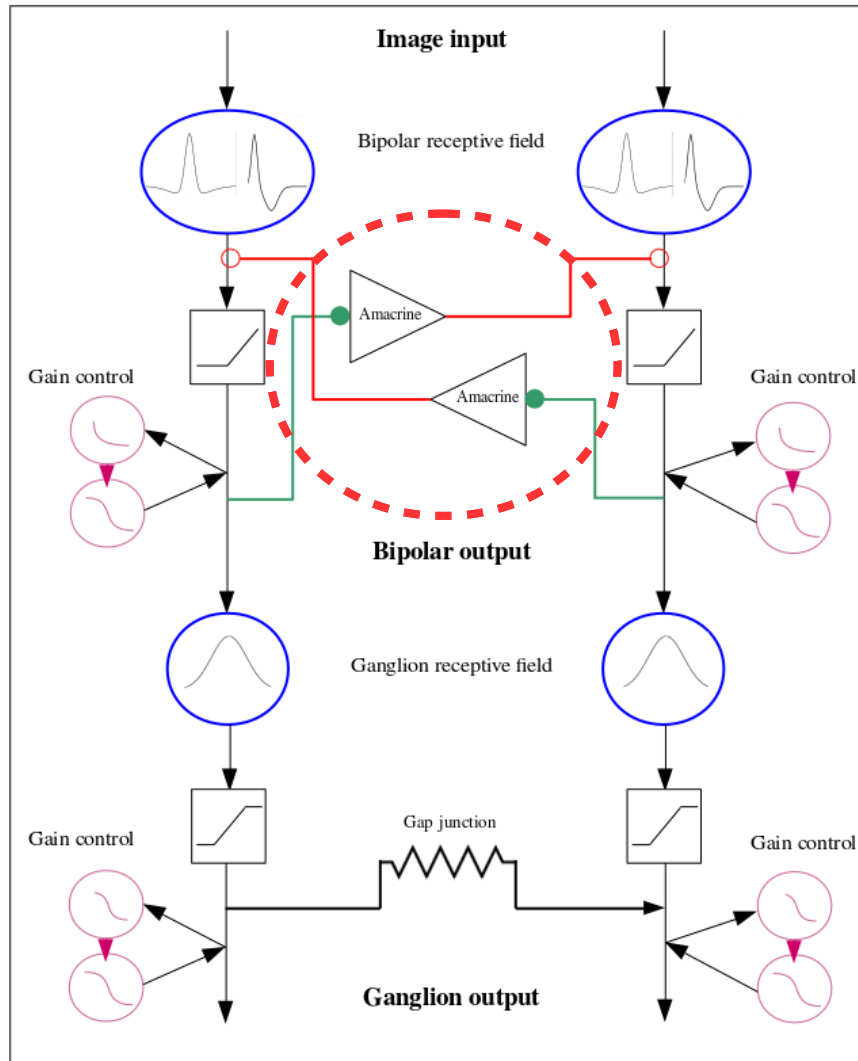

- Bipolar voltage :

$$\frac{dV_{B_i}}{dt} = -\frac{1}{\tau_B} V_{B_i} + \sum_{j=1}^{N_A} W_{B_i}^{A_j} V_{A_j} + F_{B_i}(t).$$

- External drive :

$$F_{B_i}(t) = \left[K_i \overset{S,t}{*} \left(\frac{\mathcal{S}}{\tau_B} + \frac{d\mathcal{S}}{dt} \right) \right] (t)$$

- Amacrine voltage :

$$\frac{dV_{A_j}}{dt} = -\frac{1}{\tau_A} V_{A_j}(t) + \sum_{i=1}^{N_A} W_{A_j}^{B_i} R_{B_i}(t).$$

- Coupled dynamics :

$$\left\{ \begin{array}{l} \frac{dV_{B_i}}{dt} = -\frac{1}{\tau_B} V_{B_i} + \sum_{j=1}^{N_A} W_{B_i}^{A_j} V_{A_j} + F_{B_i}(t) \\ \frac{dA_{B_i}}{dt} = -\frac{A_{B_i}}{\tau_a} + h \mathcal{N}(V_{B_i}(t)), \\ \frac{dV_{A_j}}{dt} = -\frac{1}{\tau_A} V_{A_j}(t) + \sum_{i=1}^{N_A} W_{A_j}^{B_i} R_{B_i}(t). \end{array} \right. \quad 22$$

1D results : smooth motion anticipation with amacrine connectivity

Bipolar layer

Ganglion layer

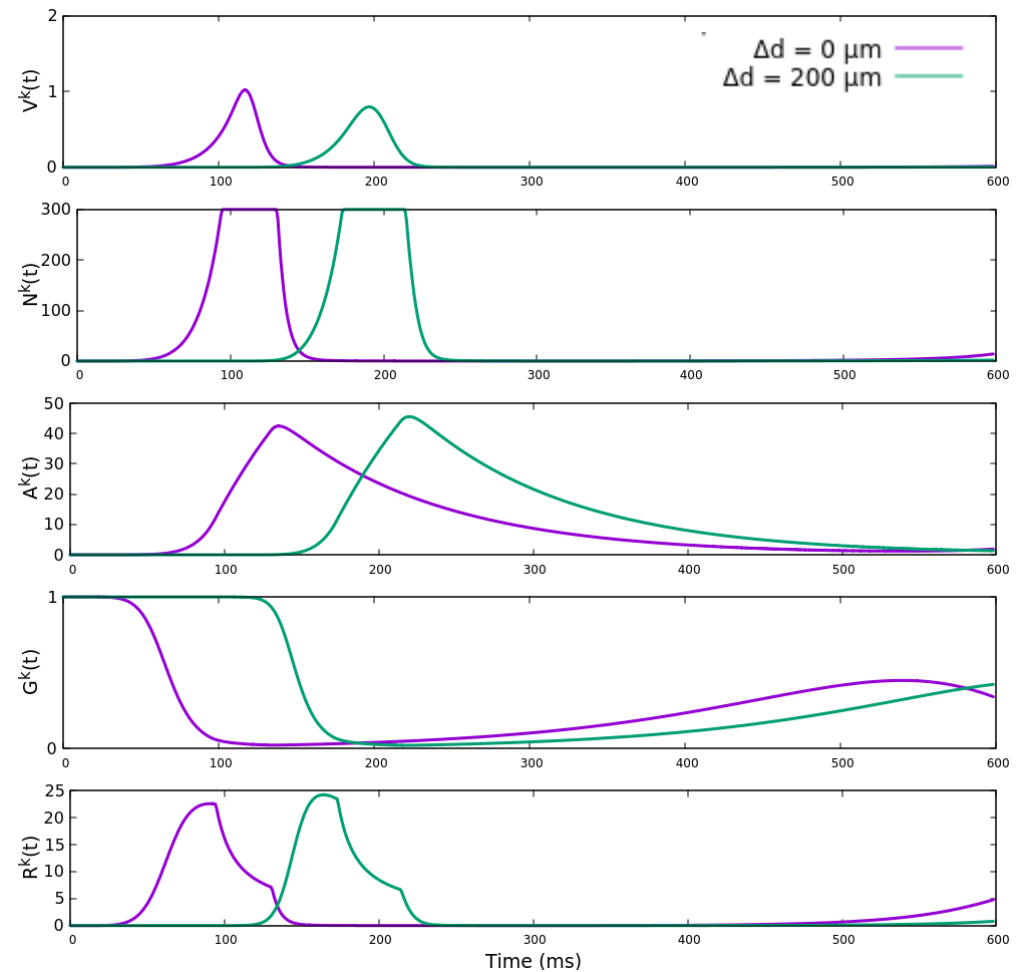
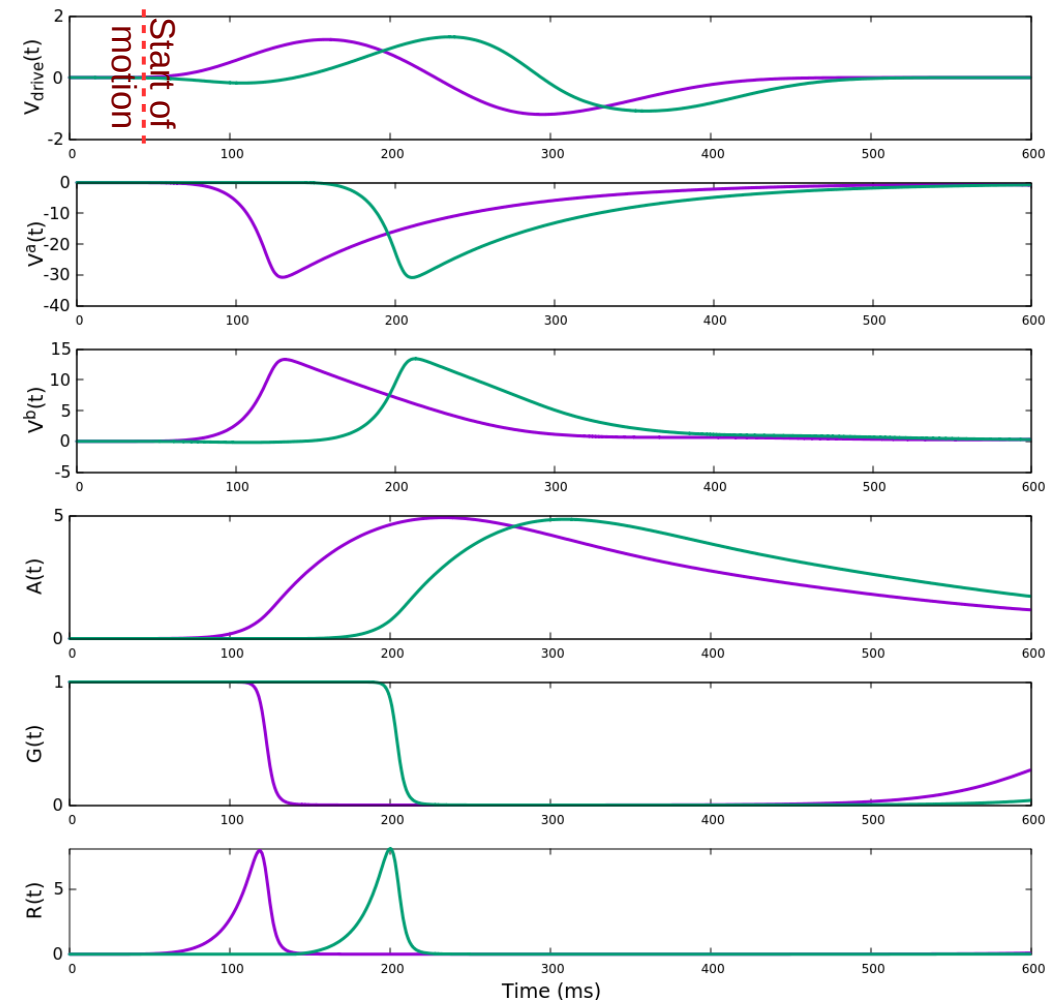

1D results : smooth motion anticipation with amacrine connectivity

Anticipation variability with stimulus parameters

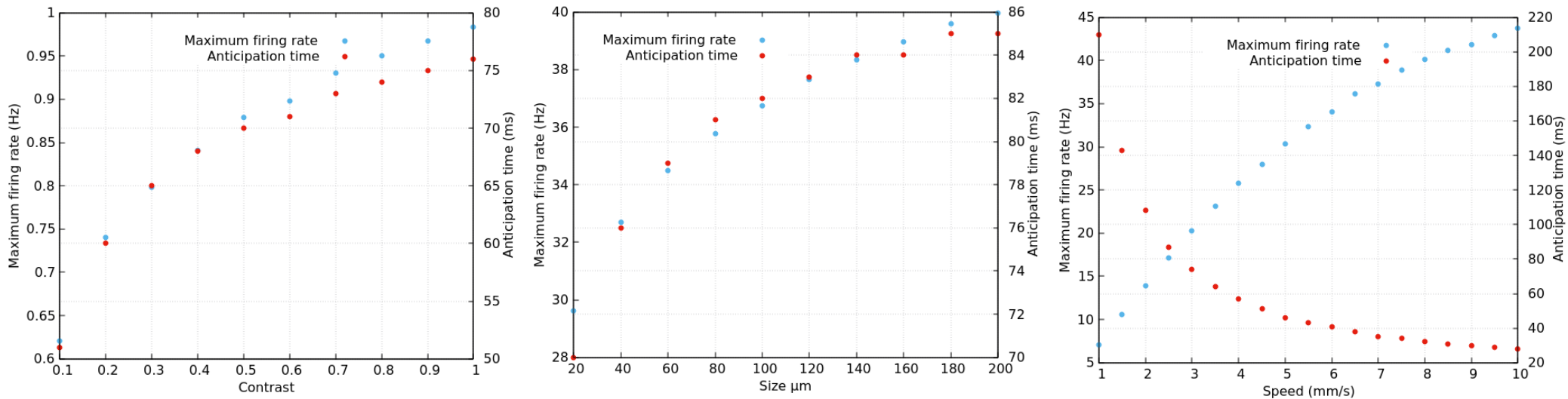

Comparing the performance of the three layers

Anticipation contrast-wise

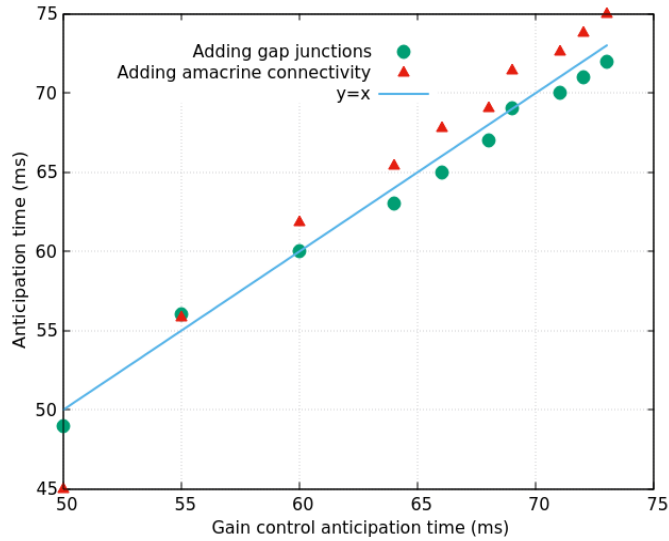

Anticipation size-wise

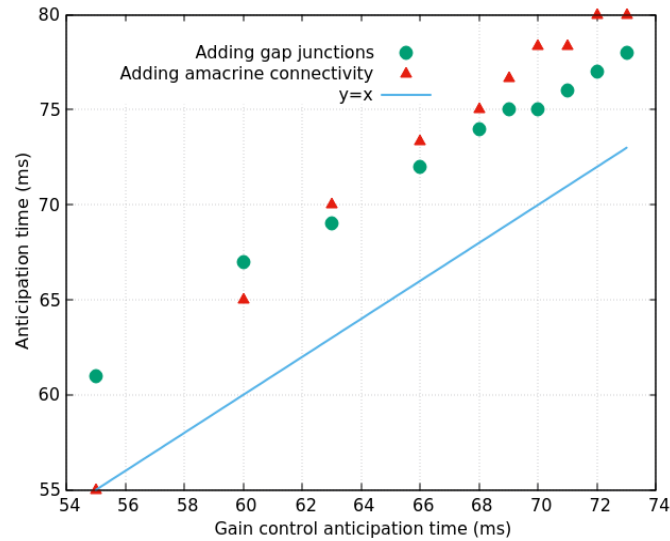

Anticipation speed-wise

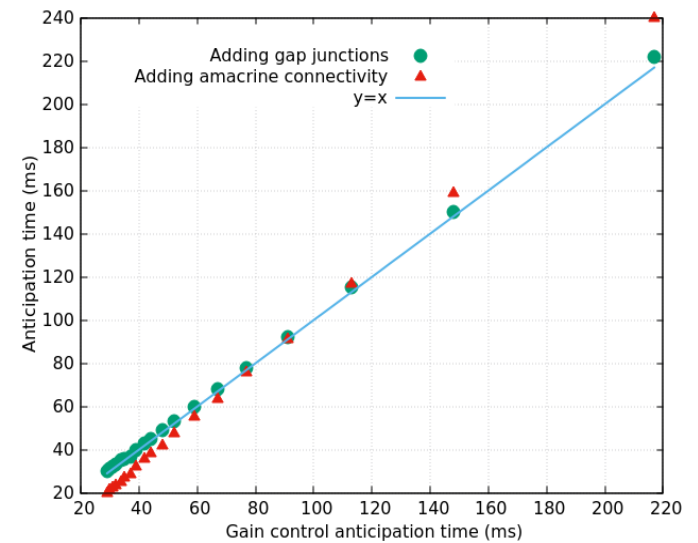

Maximum firing rate contrast-wise

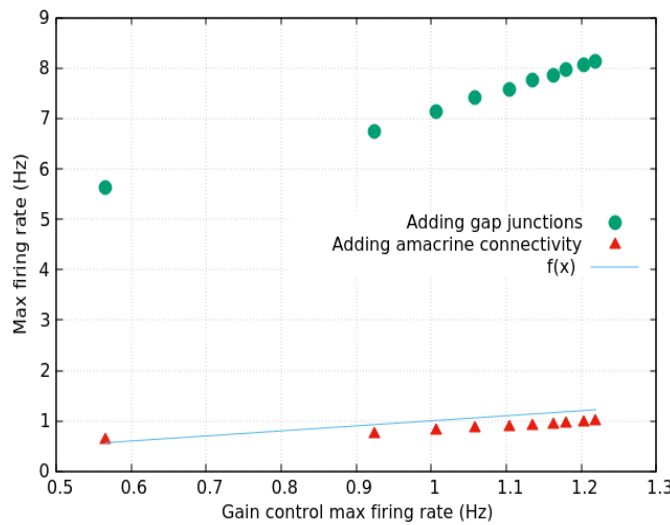

Maximum firing rate size-wise

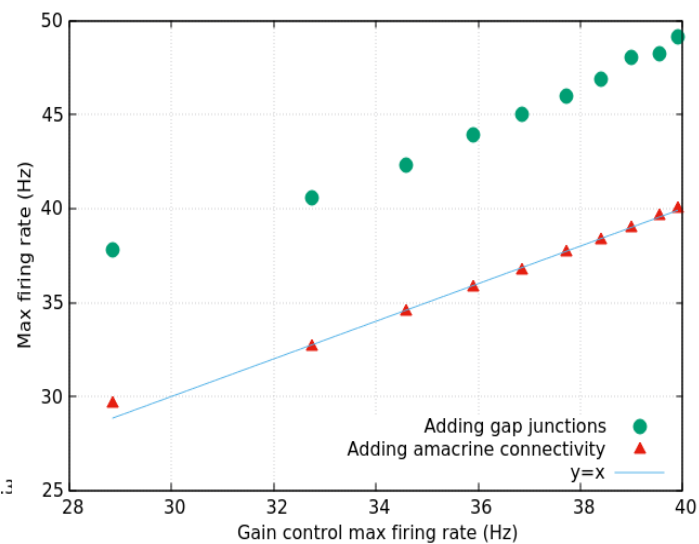

Maximum firing rate speed-wise

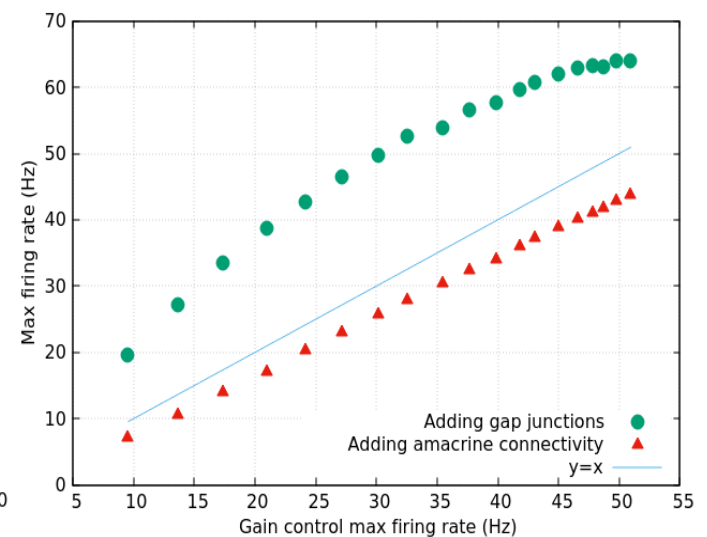

Suggesting new experiments : 2D results

1) Angular anticipation

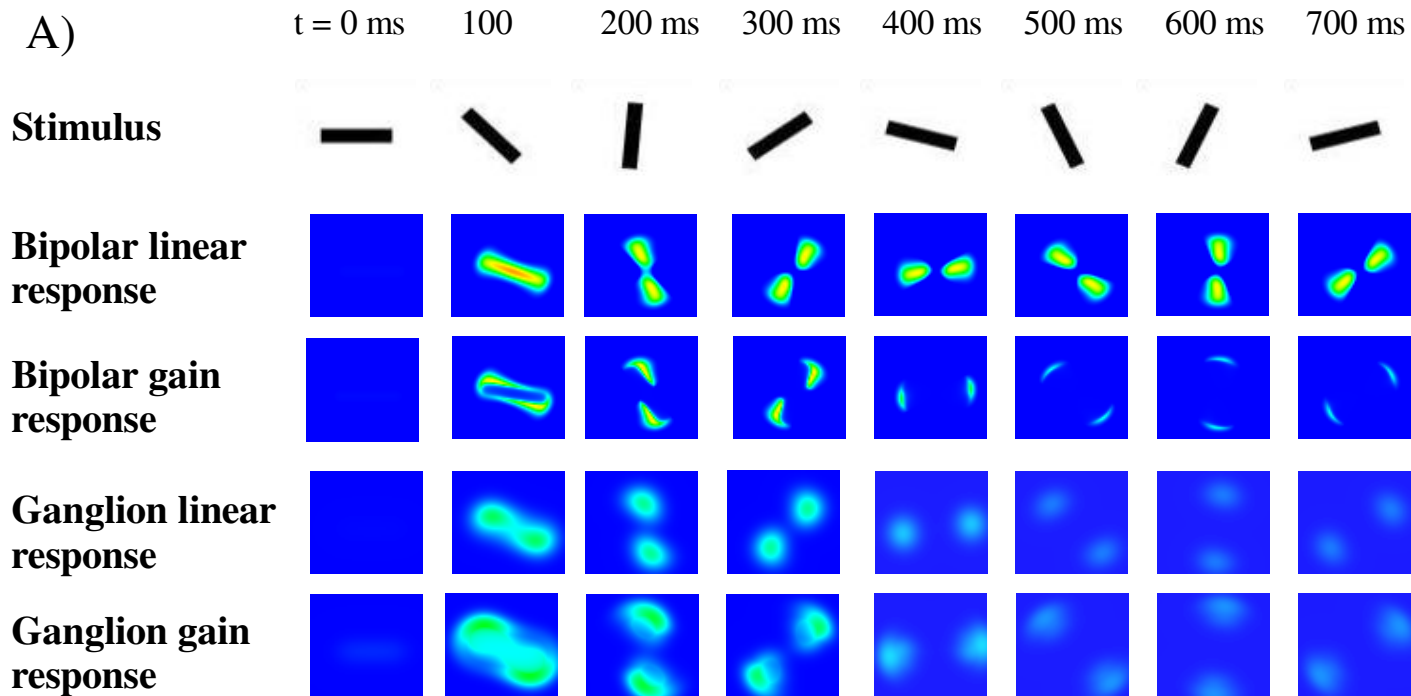

B)

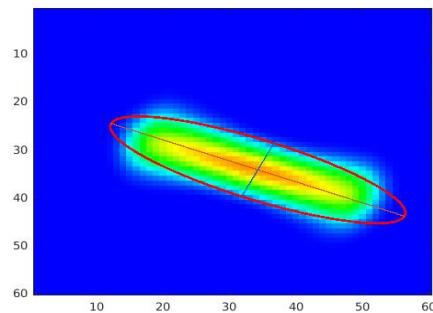

C)

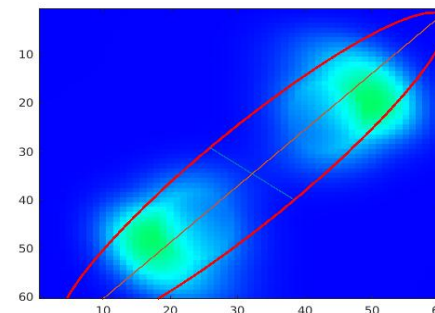

Suggesting new experiments : 2D results

1) Angular anticipation

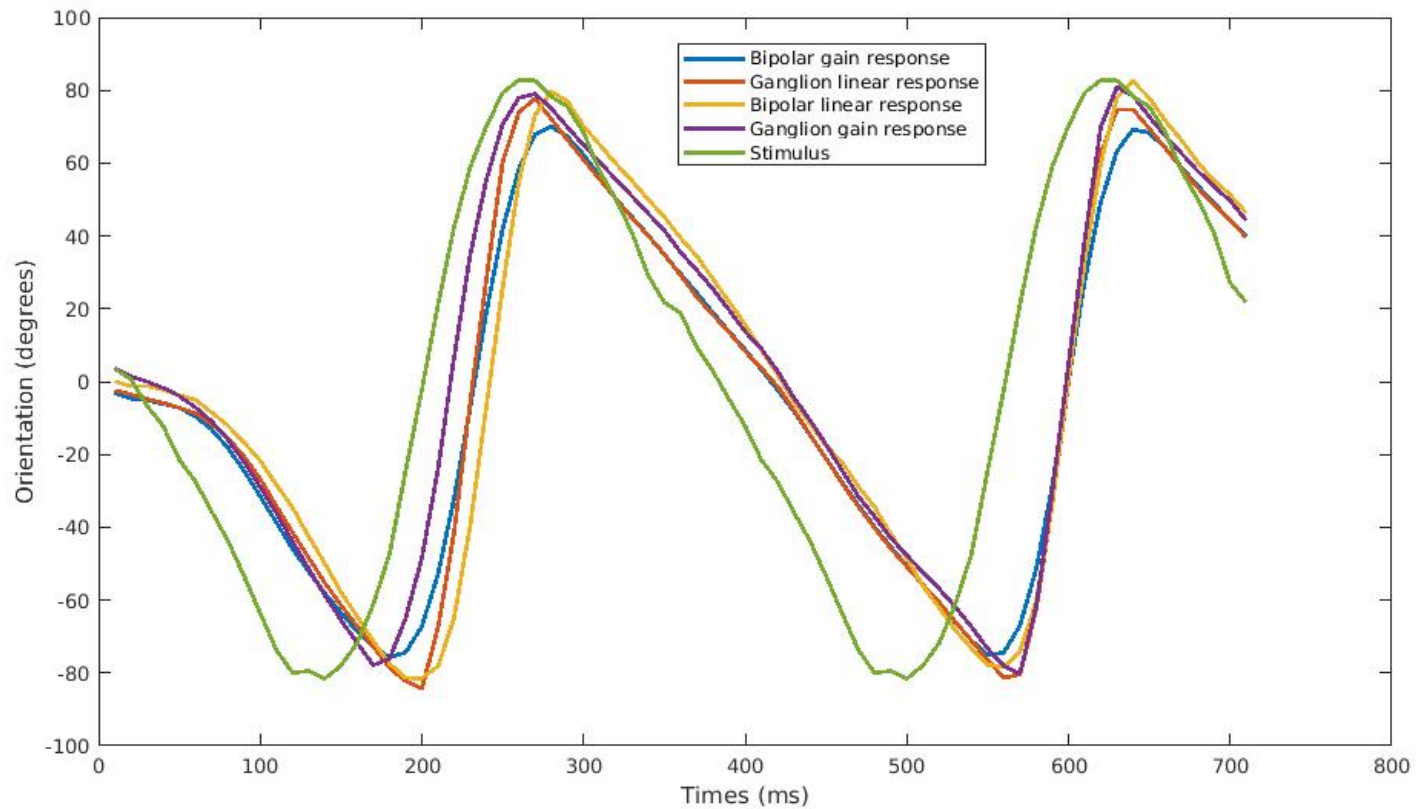

II) Anticipation in V1

A mean field model to reproduce VSDI recordings

Zerlaut et al 2016
Chemla et al 2018

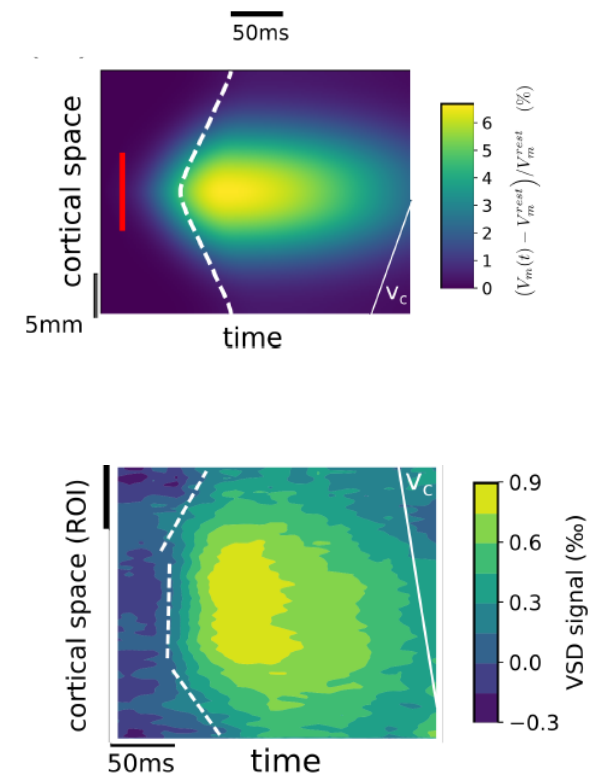
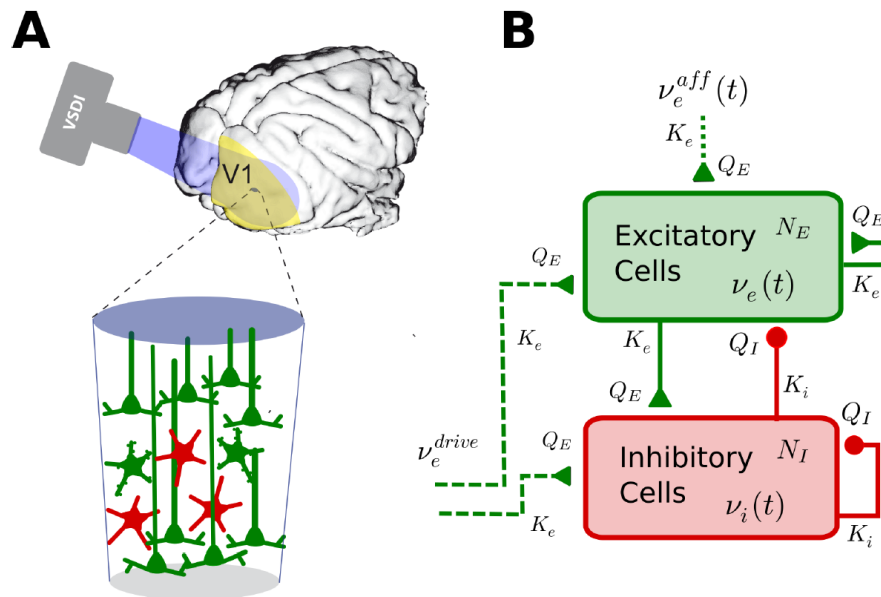

A mean field model to reproduce VSDI recordings

Zerlaut et al 2016
Chemla et al 2018

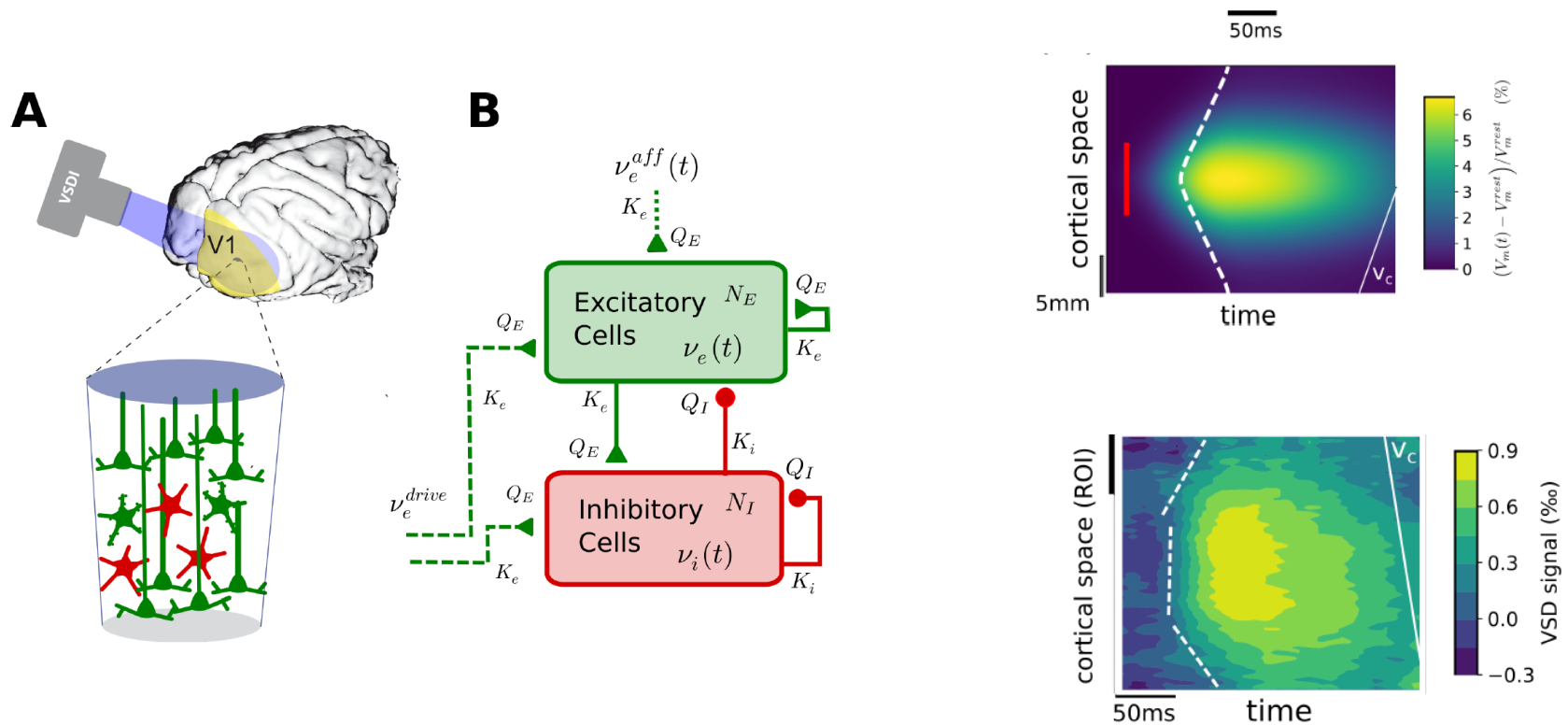

Challenge : connect our retina model to a mean field cortical model reproducing VSDI data

Cortex mean field model

Zerlaut et al 2016
Chemla et al 2018

Single neuron model

Semi analytical transfer function

Mean field equations

Single neuron model (The adaptative exponential integrate and fire model Brette and Gerstner, 2005)

$$\begin{cases} C_m \frac{dV}{dt} = g_L (E_L - V) + I_{syn}(V, t) + k_a e^{\frac{V - V_{thre}}{k_a}} - I_w \\ \tau_w \frac{dI_w}{dt} = -I_w + a \cdot (V - E_L) + \sum_{t_s \in \{t_{spike}\}} b \delta(t - t_s) \end{cases}$$

$$I_{syn}(V, t) = \sum_{s \in \{e, i\}} \sum_{t_s \in \{t_s\}} Q_s (E_s - V) e^{-\frac{t - t_s}{\tau_s}} \mathcal{H}(t - t_s)$$

Semi analytical transfer function

$$\nu_{out} = \mathcal{F}(\nu_e, \nu_i) = \frac{1}{2\tau_V} \cdot \text{Erfc}\left(\frac{V_{thre}^{eff} - \mu_V}{\sqrt{2}\sigma_V}\right)$$

$$V_{thre}^{eff}(\mu_V, \sigma_V, \tau_V^N) = P_0 + \sum_{x \in \{\mu_V, \sigma_V, \tau_V^N\}} P_x \cdot \left(\frac{x - x^0}{\delta x^0}\right) + P_{\mu_G} \log\left(\frac{\mu_G}{g_L}\right) + \sum_{x, y \in \{\mu_V, \sigma_V, \tau_V^N\}^2} P_{xy} \cdot \left(\frac{x - x^0}{\delta x^0}\right) \left(\frac{y - y^0}{\delta y^0}\right)$$

Master equation local population dynamics (El Boustani and Destexhe, 2009)

$$\begin{cases} T \frac{\partial \nu_\mu}{\partial t} = (\mathcal{F}_\mu - \nu_\mu) + \frac{1}{2} c_{\lambda\eta} \frac{\partial^2 \mathcal{F}_\mu}{\partial \nu_\lambda \partial \nu_\eta} \\ T \frac{\partial c_{\lambda\eta}}{\partial t} = A_{\lambda\eta} + (\mathcal{F}_\lambda - \nu_\lambda) (\mathcal{F}_\eta - \nu_\eta) + c_{\lambda\mu} \frac{\partial \mathcal{F}_\mu}{\partial \nu_\lambda} + c_{\mu\eta} \frac{\partial \mathcal{F}_\mu}{\partial \nu_\eta} - 2c_{\lambda\eta} \end{cases}$$

$$A_{\lambda\eta} = \begin{cases} \frac{\mathcal{F}_\lambda (1/T - \mathcal{F}_\lambda)}{N_\lambda} & \text{if } \lambda = \eta \\ 0 & \text{otherwise} \end{cases}$$

Anticipation in V1

For distant bars, the activity rises earlier

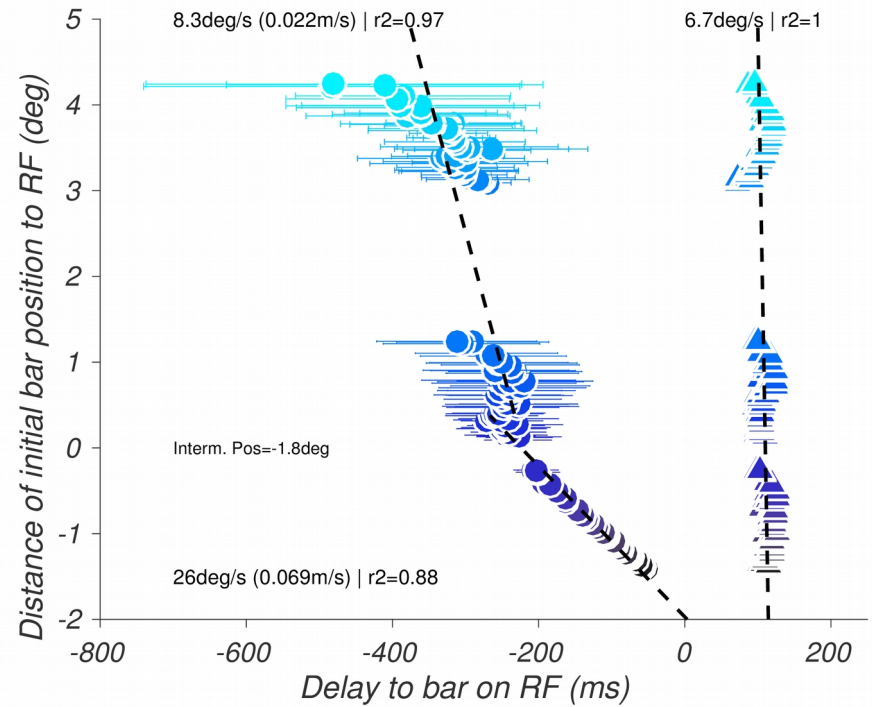
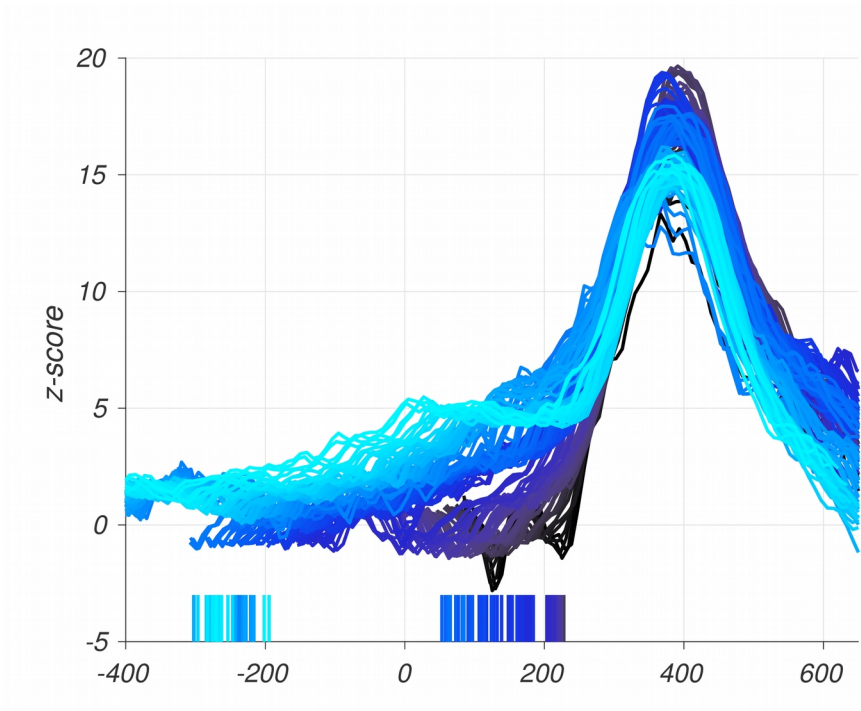

Source : Benvenuti et al. 2015

Response of the cortical model to a retina drive without gain control

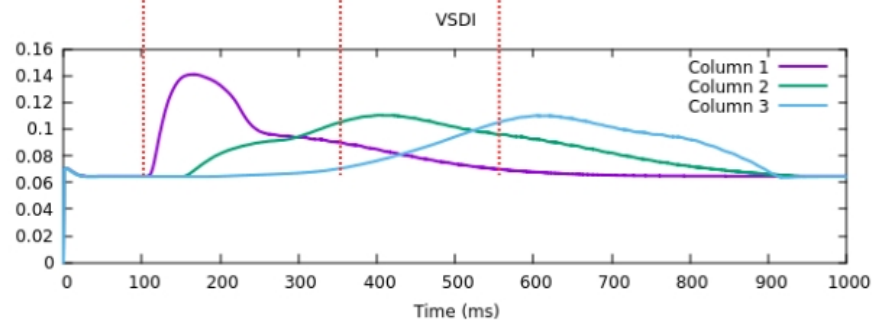
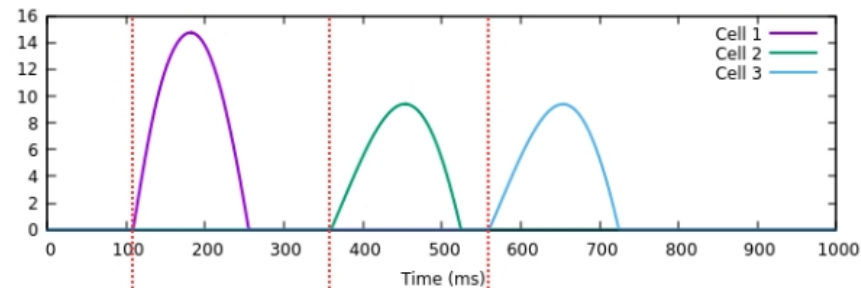
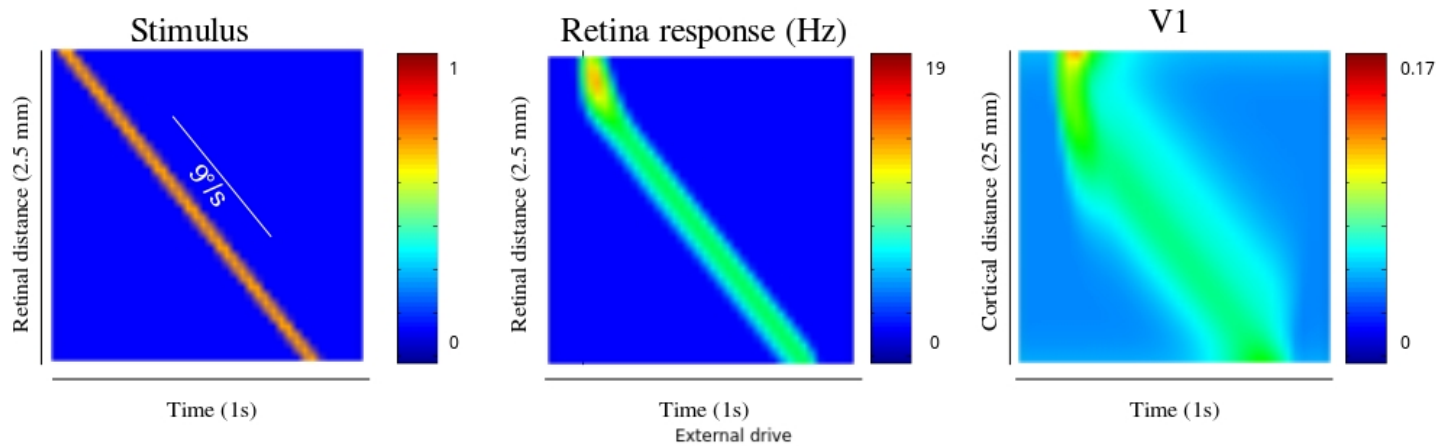

Response of the cortical model to a retina drive with gain control

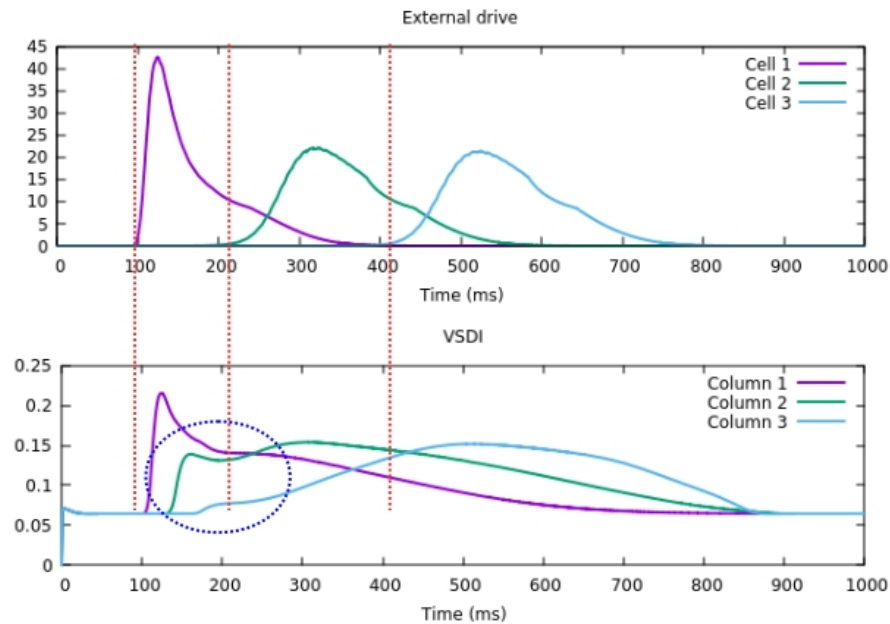
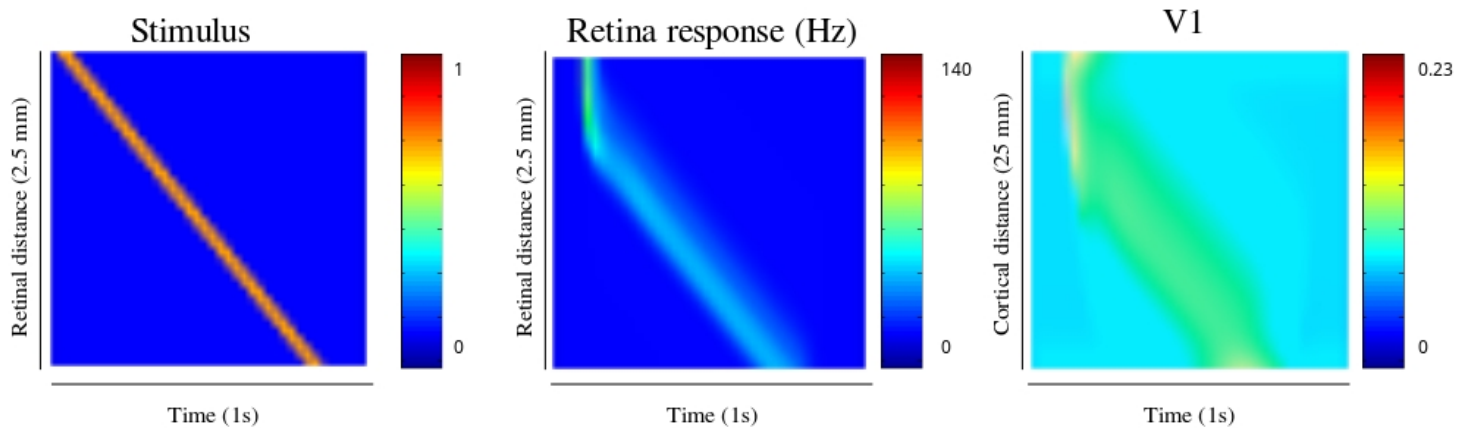

Response of the cortical model to a retina drive with amacrine connectivity

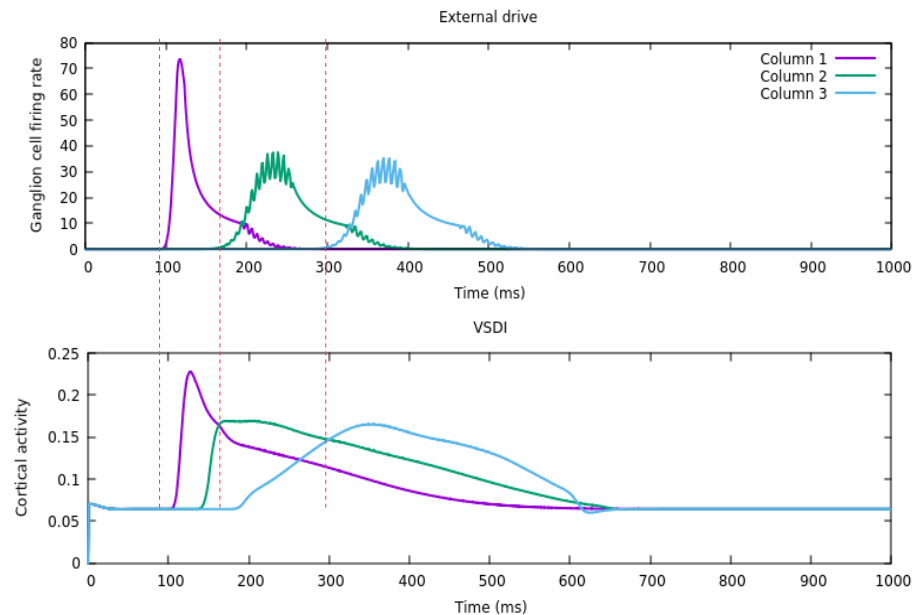
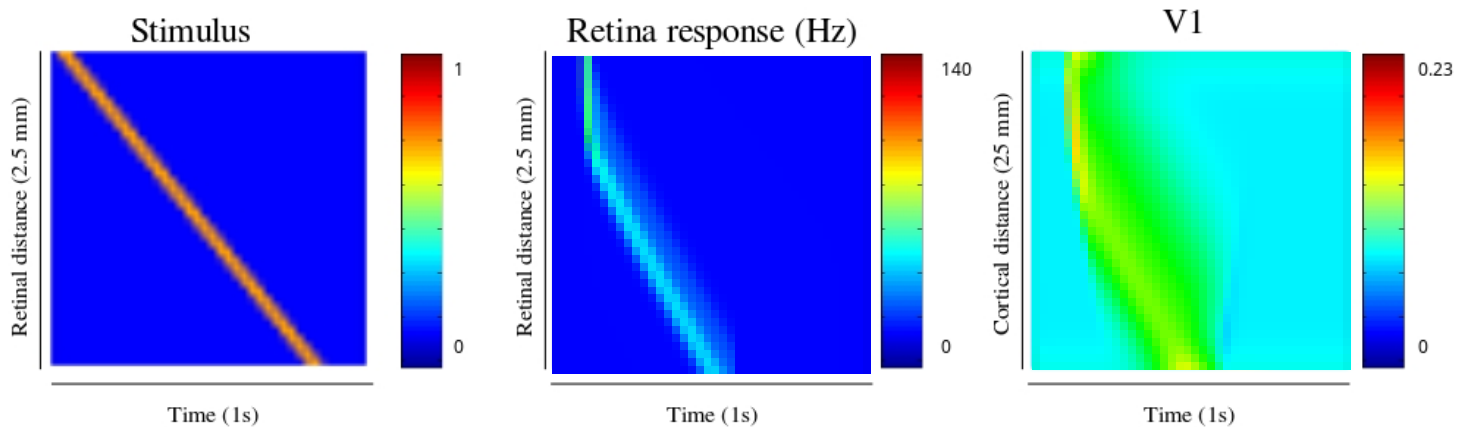

Anticipation in the cortex : VSDI data analysis

(Data courtesy of F. Chavane et S. Chemla)

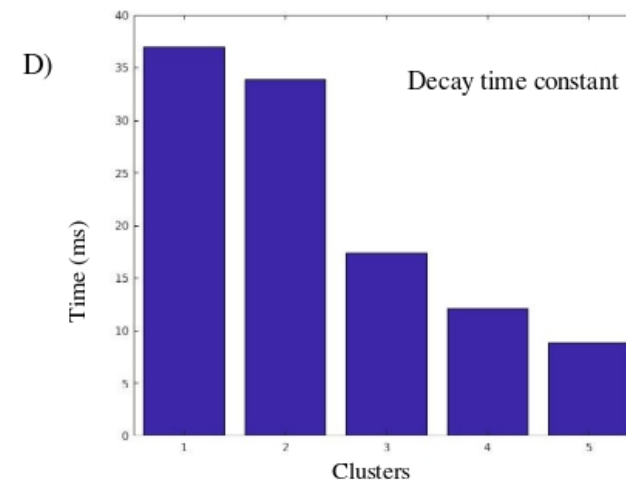
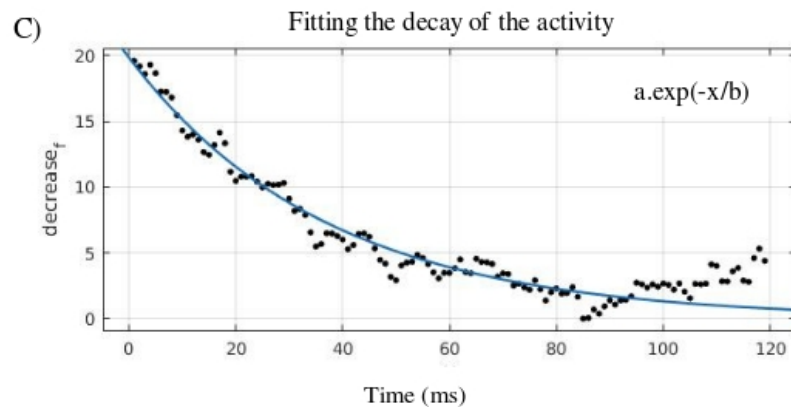
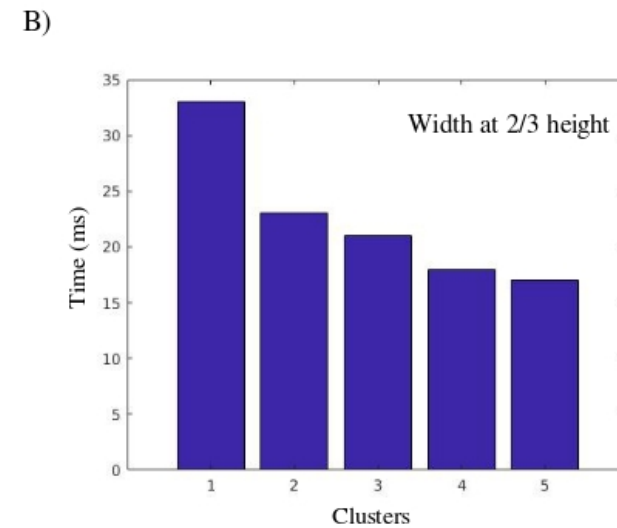
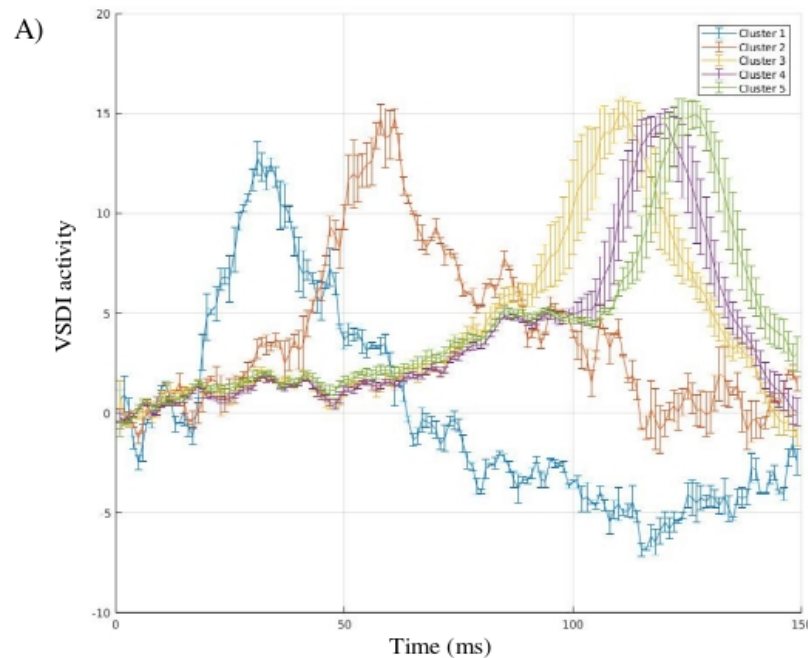

Anticipation in V1

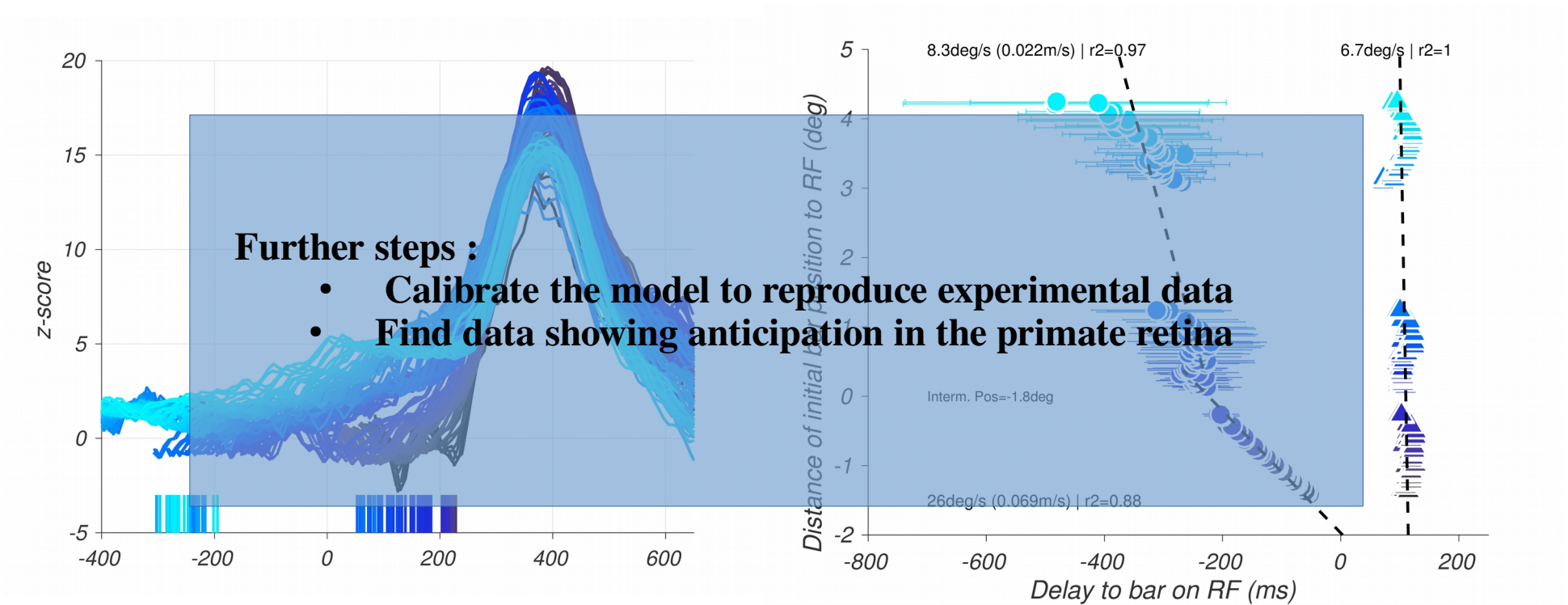

Conclusions

Ongoing work :

- Studying analytically anticipation in the amacrine connectivity sub-model
- Studying anticipation on non-uniform backgrounds
- Assessing the effect of anticipation in the retina on the one in the cortex

Questions :

- How to improve object identification 1) exploring the model's parameters and 2) using connectivity ?
- Is our model able to anticipate more complex trajectories, with accelerations for instance ?
- How to calibrate connectivity using biology ?
- Would it be possible to design psycho-physical tests clearly showing the role of the retina in visual anticipation ?

Thank you for your attention !

Supplementary material

How does gain control work

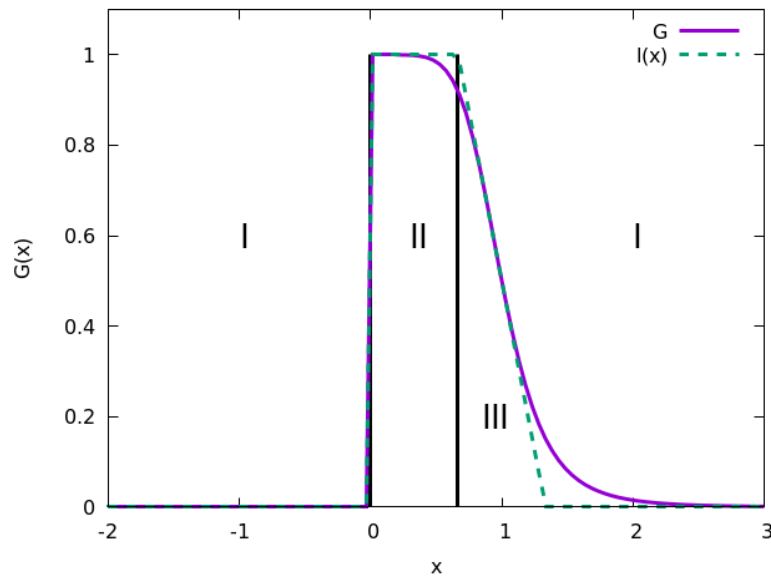

$$\mathcal{G}_B(A) = \begin{cases} 0, & \text{if } A \leq 0; \\ \frac{1}{1+A^6}, & \text{else.} \end{cases}$$

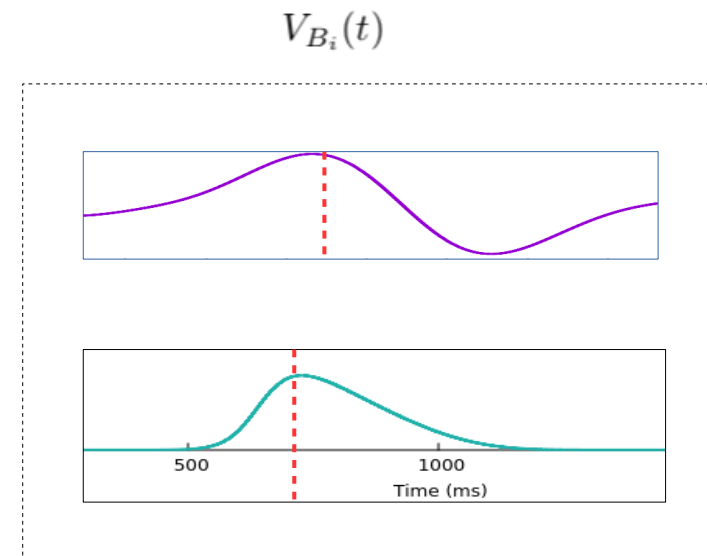

$$R_{B_i} = \mathcal{N}_B(V_{B_i}) \mathcal{G}_B(A_{B_i}).$$

Stimulus integration

$$\left[K_i \begin{smallmatrix} S, t \\ * \end{smallmatrix} \mathcal{S} \right] (t) = \int_{-\infty}^t K_T(t-u) \left[\int_{\mathbb{R}^2} K_{i,S}(x, y) \mathcal{S}(x, y, u) dx dy \right] du \equiv V_{i,drive}(t).$$

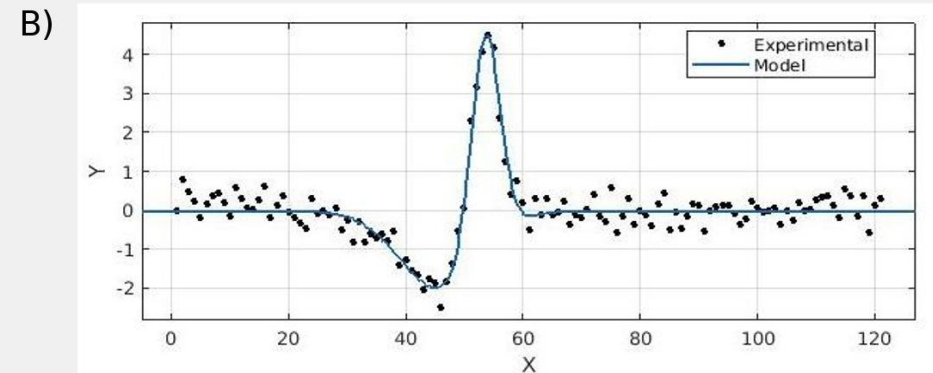
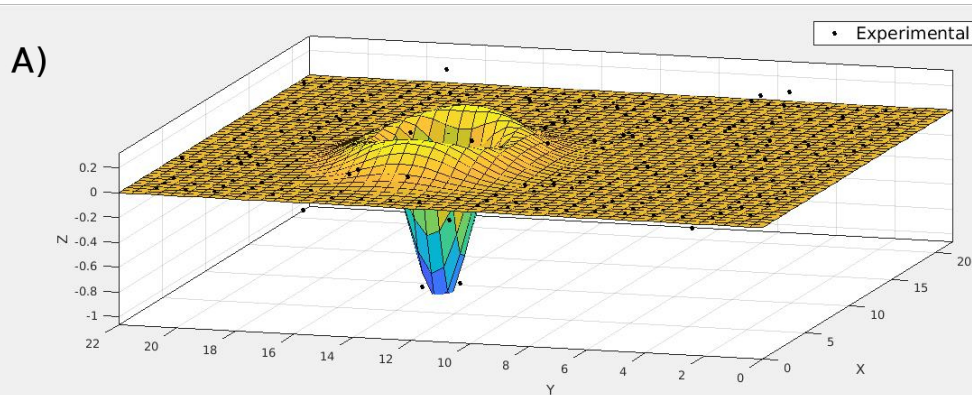

$$K_{i,S}(x, y) = \frac{A_1}{2\pi\sqrt{\det C_1}} e^{-\frac{1}{2} \bar{X}_1 \cdot C_1^{-1} \cdot X_1} - \frac{A_2}{2\pi\sqrt{\det C_2}} e^{-\frac{1}{2} \bar{X}_1 \cdot C_2^{-1} \cdot X_1},$$

$$K_T(t) = \left(\frac{K_1}{\sqrt{2\pi}\sigma_1} e^{-\frac{(t-\mu_1)^2}{2\sigma_1^2}} - \frac{K_2}{\sqrt{2\pi}\sigma_2} e^{-\frac{(t-\mu_2)^2}{2\sigma_2^2}} \right) H(t)$$

(Data courtesy of O. Marre)

Stimulus integration : anisotropy

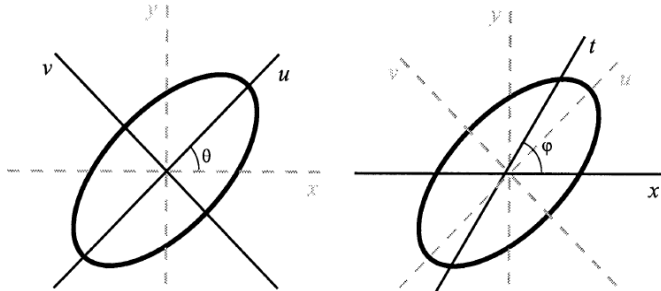

Geusebroek et al. 2003

$$\sigma_{x'} = \frac{\sigma_x \sigma_y}{\sqrt{\sigma_x^2 \cos^2 \theta + \sigma_y^2 \sin^2 \theta}}$$

$$\sigma_\phi = \frac{\sqrt{\sigma_y^2 \cos^2 \theta + \sigma_x^2 \sin^2 \theta}}{\sin \phi}$$

$$\tan(\phi) = \frac{\sigma_y^2 \cos^2 \theta + \sigma_x^2 \sin^2 \theta}{(\sigma^2 - \sigma_y^2) \cos \theta \sin \theta}$$

$$I = \sigma_{x'} \sqrt{\frac{\pi}{2}} \sum_{(i;j) \in [0, s_x] \times [0, s_y]} \int_{y - \frac{\delta}{\sin(\phi)}}^{(y+1) \frac{\delta}{\sin(\phi)}} C_{ij} e^{-\frac{(y' - y'_0)^2}{2\sigma_{x'}^2}}$$

$$[erf(\frac{(-\cos(\phi)y' + x + 1)\delta - x'_0}{\sqrt{2}\sigma_{x'}}) - erf(\frac{(-\cos(\phi)y' + x)\delta - x'_0}{\sqrt{2}\sigma_{x'}})] dy'$$

$\Theta = 0^\circ$

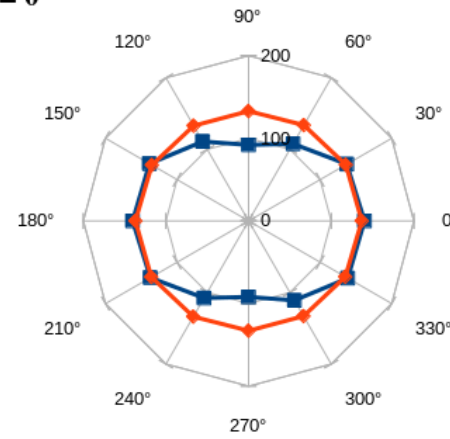

$\Theta = 30^\circ$

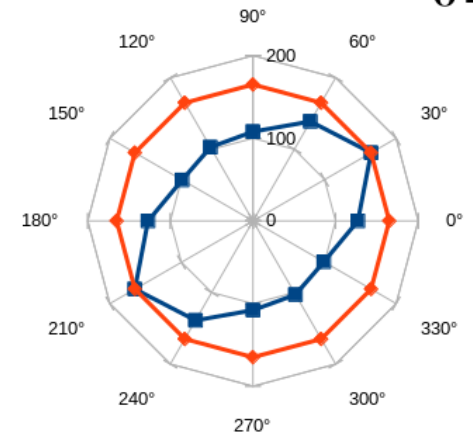

$\Theta = 90^\circ$

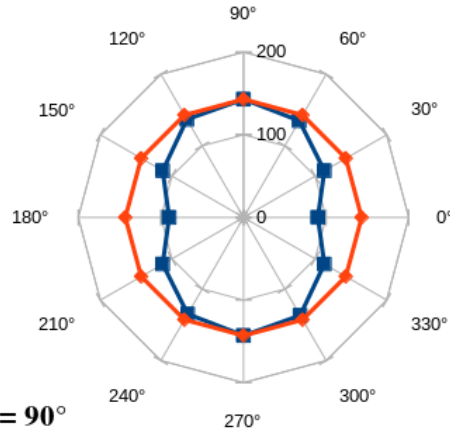

$\Theta = 120^\circ$

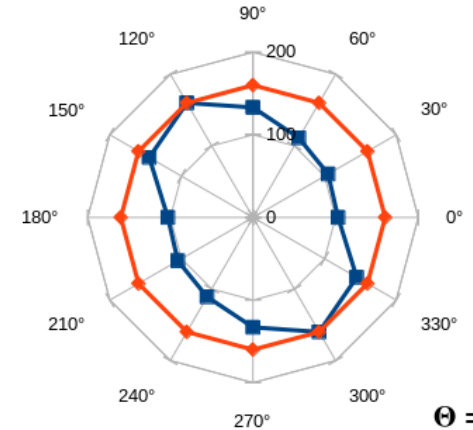

Connectivity graph

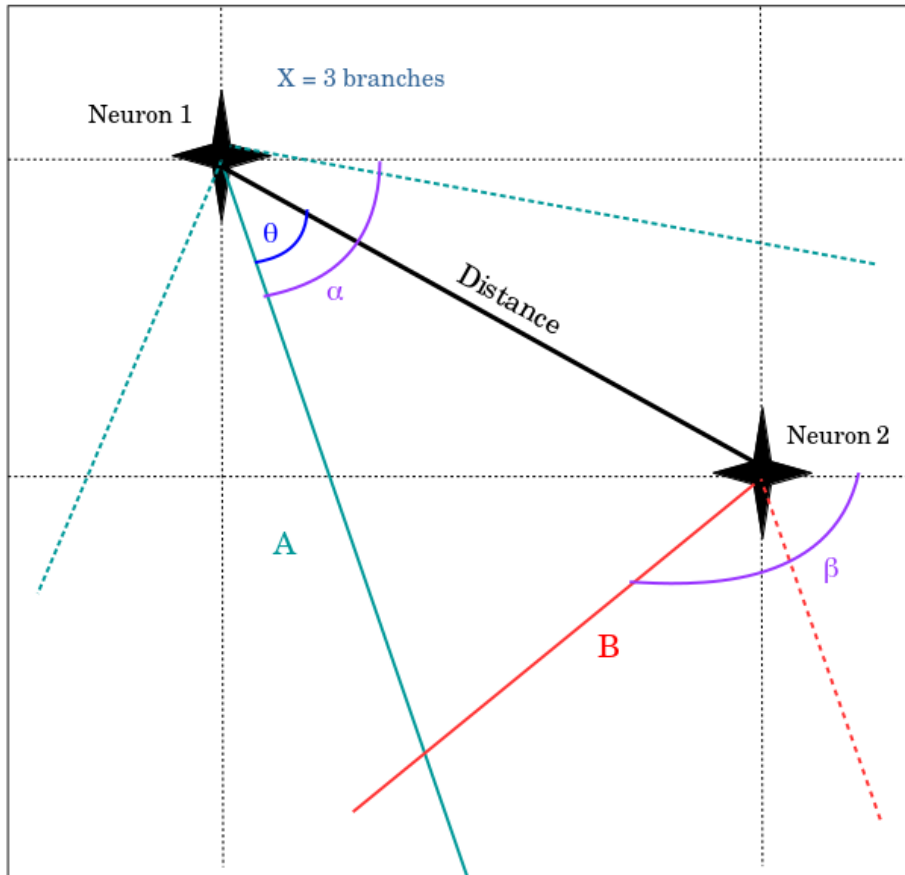

- Variables of the model :
- Number of branches N
 - Branch length X
 - Branch angle α

$$F_X(x) = \int_0^1 \frac{1}{\pi\sqrt{1-\delta^2}} \frac{x}{x+\delta} d\delta$$

$$\sin\left(\beta + \frac{\arcsin |y_j - y_i|}{\sqrt{(x_j - y_i)^2 + (y_j - x_j)^2}}\right)$$

Cortex mean field model

Zerlaut et al 2016
Chemla et al 2018

Single neuron model (The adaptive exponential integrate and fire model Brette and Gerstner, 2005)

$$\begin{cases} C_m \frac{dV}{dt} = g_L (E_L - V) + I_{syn}(V, t) + k_a e^{\frac{V - V_{thre}}{k_a}} - I_w \\ \tau_w \frac{dI_w}{dt} = -I_w + a \cdot (V - E_L) + \sum_{t_s \in \{t_{spike}\}} b \delta(t - t_s) \end{cases}$$

The conductance-based exponential synapse

$$I_{syn}(V, t) = \sum_{s \in \{e, i\}} \sum_{t_s \in \{t_s\}} Q_s (E_s - V) e^{-\frac{t-t_s}{\tau_s}} \mathcal{H}(t - t_s)$$

Semi analytical transfer function :

$$\nu_{out} = \mathcal{F}(\nu_e, \nu_i) = \frac{1}{2\tau_V} \cdot \text{Erfc}\left(\frac{V_{thre}^{eff} - \mu_V}{\sqrt{2}\sigma_V}\right) \quad \text{with} \quad V_{thre}^{eff}(\mu_V, \sigma_V, \tau_V^N) = P_0 + \sum_{x \in \{\mu_V, \sigma_V, \tau_V^N\}} P_x \cdot \left(\frac{x - x^0}{\delta x^0}\right) + P_{\mu_G} \log\left(\frac{\mu_G}{g_L}\right) \\ + \sum_{x, y \in \{\mu_V, \sigma_V, \tau_V^N\}^2} P_{xy} \cdot \left(\frac{x - x^0}{\delta x^0}\right) \left(\frac{y - y^0}{\delta y^0}\right)$$

Cortex mean field model

Zerlaut et al 2016
Chemla et al 2018

The mean, standard deviation and auto-correlation time of the excitatory and inhibitory conductance read :

$$\begin{array}{l}
 \mu_{Ge}(\nu_e, \nu_i) = \nu_e K_e \tau_e Q_e \\
 \sigma_{Ge}(\nu_e, \nu_i) = \sqrt{\frac{\nu_e K_e \tau_e}{2}} Q_e \\
 \mu_{Gi}(\nu_e, \nu_i) = \nu_i K_i \tau_i Q_i \\
 \sigma_{Gi}(\nu_e, \nu_i) = \sqrt{\frac{\nu_i K_i \tau_i}{2}} Q_i
 \end{array}
 \quad \longrightarrow \quad
 \begin{array}{l}
 \mu_G(\nu_e, \nu_i) = \mu_{Ge} + \mu_{Gi} + g_L \\
 \tau_m(\nu_e, \nu_i) = \frac{C_m}{\mu_G} \\
 \downarrow \\
 \mu_V(\nu_e, \nu_i) = \frac{\mu_{Ge} E_e + \mu_{Gi} E_i + g_L E_L}{\mu_G} \\
 \sigma_V(\nu_e, \nu_i) = \sqrt{\sum_s K_s \nu_s \frac{(U_s \cdot \tau_s)^2}{2(\tau_m^{\text{eff}} + \tau_s)}} \\
 \tau_V(\nu_e, \nu_i) = \left(\frac{\sum_s (K_s \nu_s (U_s \cdot \tau_s)^2)}{\sum_s (K_s \nu_s (U_s \cdot \tau_s)^2 / (\tau_m^{\text{eff}} + \tau_s))} \right)
 \end{array}$$

Finally, the transfer function reads :

$$\nu_{out} = \mathcal{F}(\nu_e, \nu_i) = \frac{1}{2\tau_V} \cdot \text{Erfc}\left(\frac{V_{thre}^{eff} - \mu_V}{\sqrt{2}\sigma_V}\right)$$

Cortex mean field model

Zerlaut et al 2016
Chemla et al 2018

Master equation for first and second moments local population dynamics (El Boustani and Destexhe, 2009) read :

$$\left\{ \begin{array}{l} T \frac{\partial \nu_\mu}{\partial t} = (\mathcal{F}_\mu - \nu_\mu) + \frac{1}{2} c_{\lambda\eta} \frac{\partial^2 \mathcal{F}_\mu}{\partial \nu_\lambda \partial \nu_\eta} \\ T \frac{\partial c_{\lambda\eta}}{\partial t} = A_{\lambda\eta} + (\mathcal{F}_\lambda - \nu_\lambda) (\mathcal{F}_\eta - \nu_\eta) + \\ \quad c_{\lambda\mu} \frac{\partial \mathcal{F}_\mu}{\partial \nu_\lambda} + c_{\mu\eta} \frac{\partial \mathcal{F}_\mu}{\partial \nu_\eta} - 2c_{\lambda\eta} \end{array} \right. \longrightarrow T \frac{\partial \nu_\mu}{\partial t} = \mathcal{F}_\mu - \nu_\mu$$

$$A_{\lambda\eta} = \begin{cases} \frac{\mathcal{F}_\lambda (1/T - \mathcal{F}_\lambda)}{N_\lambda} & \text{if } \lambda = \eta \\ 0 & \text{otherwise} \end{cases}$$

Comparing simulation results to VSDI recordings

Cortex experimental recordings

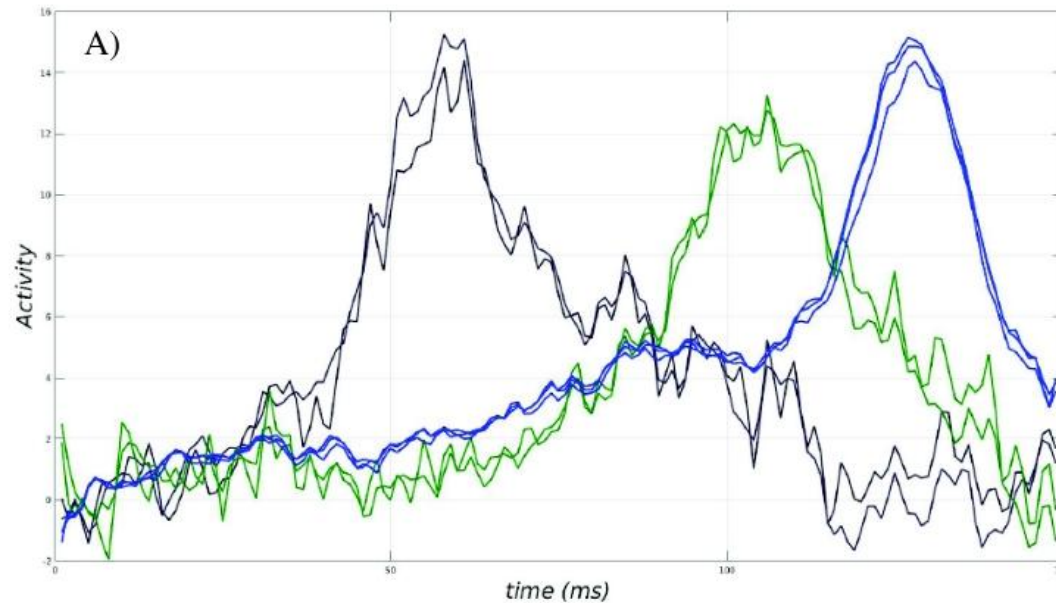

Simulation results
Response to an LN
model of the retina

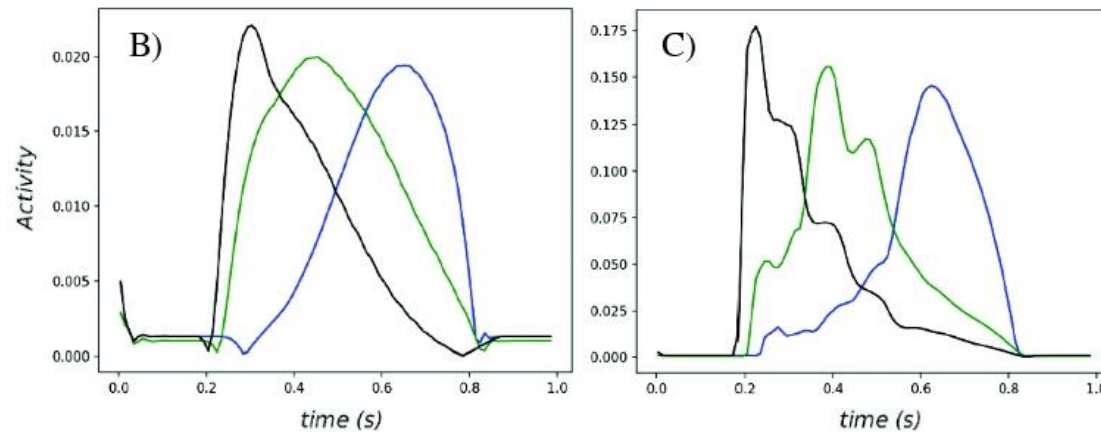

Simulation results
Response to a gain
control model of the
retina