



HAL
open science

Research on Automatic Steering Control System of Full Hydraulic Steering Tractor

Shupeng Hu, Weiqiang Fu, You Li, Yue Cong, Yehua Shang, Zhijun Meng

► **To cite this version:**

Shupeng Hu, Weiqiang Fu, You Li, Yue Cong, Yehua Shang, et al.. Research on Automatic Steering Control System of Full Hydraulic Steering Tractor. 11th International Conference on Computer and Computing Technologies in Agriculture (CCTA), Aug 2017, Jilin, China. pp.517-528, 10.1007/978-3-030-06137-1_48 . hal-02124228

HAL Id: hal-02124228

<https://inria.hal.science/hal-02124228>

Submitted on 9 May 2019

HAL is a multi-disciplinary open access archive for the deposit and dissemination of scientific research documents, whether they are published or not. The documents may come from teaching and research institutions in France or abroad, or from public or private research centers.

L'archive ouverte pluridisciplinaire **HAL**, est destinée au dépôt et à la diffusion de documents scientifiques de niveau recherche, publiés ou non, émanant des établissements d'enseignement et de recherche français ou étrangers, des laboratoires publics ou privés.



Distributed under a Creative Commons Attribution 4.0 International License

Research on Automatic Steering Control System of Full Hydraulic Steering Tractor

Shupeng Hu^{1,2}, Weiqiang Fu^{1,2}, You Li^{1,2}, Yue Cong^{1,2}, Yehua Shang^{1,2}, Zhijun Meng^{1,2}(✉)

¹ Beijing Research Center for Information Technology in Agricultural, Beijing, P. R. China

{husp, fuwq, liyou, congy, shangyh, mengzj}@nercita.org.cn

² National Research Center of Intelligent Equipment for Agriculture, Beijing, P. R. China

Abstract. The performance of automatic steering control directly affects the accuracy of tractor navigation. In order to improve the tractor navigation performance, the tractor automatic steering control technology is researched. The automatic steering control system for the full hydraulic steering tractor is designed with the Lovol Europard FT704 tractor. The mathematical model of automatic steering system is established. The PID parameters are determined by digital simulation analysis, and verified by steering test. The field test results show that the offset error is not greater than 5.98 cm and the average offset error is not greater than 1.23 cm at the travel speed of 1.0 m/s. The field tests indicated the tractor automatic steering control system can meet the needs of tractor automatic navigation.

Keywords: Automatic steering; Full hydraulic steering; Electro-hydraulic proportional control; Digital simulation; automatic navigation

1 Introduction

Most tractors use full hydraulic handling maneuver, so there are two ways to achieve the steering mechanism of automatic control: one way is to drive the steering wheel or steering shaft with motor to realize steering control; another way is to connect hydraulic control valve group and the tractor steering system in series or parallel, through controlling the opening and direction of the valve to realize steering control [1,2,3]. This electro-hydraulic control mode has quick response, high navigation tracking accuracy, and convenient switching between manual and automatic steering [4]. Now, the domestic tractor steering mostly uses the open-type steering assembly, so that the research on automatic steering control technology is aimed at the open-type steering gear assembly [5,6]. With the development of large-scale production mode of modern agriculture, the trend of large-scale tractor is becoming more and more obvious, and the steering gear assembly is developing from open-type to the load sensing steering assembly [7].

Therefore, this paper researches on the automatic steering control technology of tractor with load sensing steering assembly, proposes an automatic steering control scheme based on the original tractor steering system, and designs the automatic steering control system of tractor based on CAN bus, at last, this paper constructs the mathematical model and simulation model of the system, and carries out the simulation and field test for tractor automatic steering control system.

2 Automatic Steering System Components

Automatic steering system is mainly composed of hydraulic part and steering control. Hydraulic part is composed of electro-hydraulic proportional directional valve, electro-magnetic valve, priority valve, closed hydraulic steering gear, pressure compensator and so on [8,9,10]. Steering control part is composed of steering controller, wheel swivel angle sensor, pressure sensor and so on [11,12,13]. The system can achieve the automatic steering function and manual steering function switching freely and ensure that manual steering function priority at any time, at the same time, the steering wheel can be operated to realize artificial driving when the automatic steering control fails, the system structure shown in Fig.1.

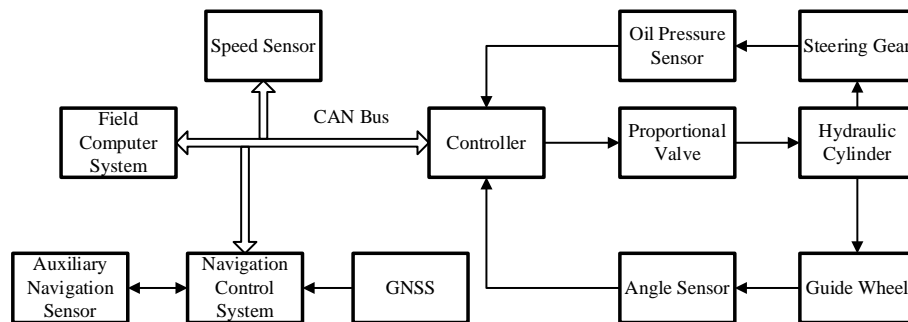

Fig.1 The tractor auto-steer system structure

3 Automatic Steering System Design

3.1 Electro-hydraulic Steering Device Design

The electro-hydraulic steering device is designed through installing electro-hydraulic control valves on the full hydraulic steering system of the LOVOL tractor FT704 tractor as the platform. The working principle (Fig.2) is as follows. Electro-hydraulic proportional directional valve, electromagnetic switch valve and other hydraulic components were connected together with the valve block, those components is connected with tractor hydraulic steering gear in series and connected with steering cylinder in parallel. The hydraulic oil flows through the electro-hydraulic proportional directional valve to steering cylinder, so that the tractor steering system can be controlled and the wheel swivel angle can be turned to expected value.

The hydraulic system workflow is as follows: The pressure sensing port LS of the priority valve is connected to the control port of the tractor steering gear, the port CF is connected with the oil inlet of steering gear and the pressure switch, the port EF is connected with the oil inlet of the electrohydraulic proportional directional valve. When the system pressure is established and the steering gear is not working, the CF port is closed, so the pressure of port LS is zero. The oil flows into the right of the spool, and the liquid pressure acts on the right of spool, which makes the spool move to the left, at this time, port P and port EF are connected, the pressure oil flows through the electro-hydraulic proportional directional valve to the steering cylinder. The electro-hydraulic proportional directional valve is connected with the steering cylinder, and the automatic steering function of the tractor is actively. When the steering gear is working, the steering system is in a manual mode, the port P is connected to the port CF with the pressure, so the steering gear is connected with steering cylinder, through the priority valve and the steering gear, the pressure oil enters the steering cylinder and realizing the tractor steering control.

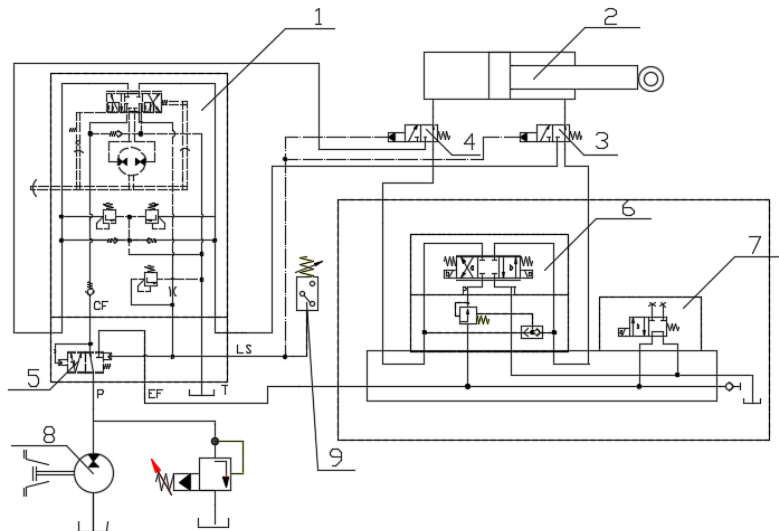

1-Load Sensing Steering Gear 2-Hydraulic Cylinder 3-Solenoid Valve 4-Solenoid Valve 5-Priority Valve 6-Electrohydraulic Proportional Valve Block 7-Solenoid Valve 8-Oil Pump 9-Oil Pressure Sensor

Fig.2 Structure diagram of tractor automatic steering control system

According to the performance parameters of the FT704 tractor original hydraulic steering system to select the appropriate hydraulic components. The original hydraulic steering system of FT704 tractor is mainly composed of constant flow gear pump, hydraulic cylinder, the rated flow of constant flow gear pump is $12 \pm 1 \text{ mL/r}$, rated pressure is $12.5 \pm 0.5 \text{ MPa}$; hydraulic cylinder's trip is 188mm, hydraulic cylinder diameter is 55mm, Piston rod diameter is 25mm. According to the system working pressure, flow and other parameters, the PRM2-043Z11/12-12 electro-hydraulic proportional directional valve which is manufactured by Germany ARGO-HYTOS company is chose, the rated working voltage of valve is 12V DC, rated current is 1.9A, and maximum flow is 12L/min when the pressure difference is 7MPa.

In the electro-hydraulic control system, the part of hydraulic cylinder controlled by electro-hydraulic proportional directional valve has the lowest natural frequency ω_n in all aspects of the system. In order to improve the natural frequency of hydraulic and ensure the ease of installation, a hydraulic valve block is designed to connect the valve group for improving the system response speed. Hydraulic valve and the overall connection effect is shown in Fig.3.



Fig.3 Physical of steering systems transformed

3.2 Steering Control Hardware Design

According to the electrical parameters of FT704 tractor and the performance parameters of electro-hydraulic steering device to select the appropriate control device.

The control system composes an angle sensor fixed on the left guide wheel as the measurement sensor for the system feedback signal. As the FT704 tractor just

can provide the 12V DC working voltage, so the tcsensor WYH-3V0 non-contact angle sensor is chosen. The linear range of sensor is from 0 to 90°, and working voltage range is from 8 to 18V, while the output voltage range is continuously change from 0 to 5V, and the sensor supports 360° continuous rotation.



Fig.4 Fixed angle sensor

The RC6-9 controller which is manufactured by Germany Bosch Rexroth is chose as steering controller. The controller supports $12\pm 1V$ and $24\pm 1V$ two levels of working voltage. The controller has two CAN bus、10-bit ADC sampling accuracy, and supports 0-2.3A PWM current output with IP65 protection grade, the CPU frequency is 40MHz.

3.3 Automatic Steering Control Software Design

Tractor automatic steering control system is a typical electro-hydraulic proportional position control system. It uses closed-loop control mode with high anti-interference ability, no-sensitive of the system parameter change, high control precision, quickly response speed and so on.

The steering control principle is as follows: After receiving the steering message from vehicle controller computer system, steering controller runs the steering control program, and compares the target wheel swivel angle with real-time detection value of wheel swivel angle, then, according to the control algorithm, steering controller outputs PWM control signal which can directly drive the electro-hydraulic proportional valve to control the flow and direction of electro-hydraulic proportional directional valve, so that hydraulic cylinder can be driven to a predetermined position.

The steering control workflow is as follows: Firstly, steering controller initializes the state parameters of CAN bus and steering control, and initializes PID parameters. Then, steering controller detects the measurement of wheel swivel angle sensor, and judgments whether the measurement exceeds the system setting limit value. If the measurement exceeds the limit, steering controller sets the flag of steering to manual and sends an error angle value message to the CAN bus, and next, the steering control mode is switched to manual mode. If the measurement is in the normal range, steering controller detects the measurement of pressure sensor. If the measurement exceeds the limit, steering controller sets the flag of steering to manual and sends an oil pressure abnormality message to the CAN bus, and next, the steering control mode is switched to manual mode. If the measurement is in the normal range, steering controller judgments whether a steering control command has been received. If received, according to the new target value, steering controller calculates the duty ratio of PWM waveform to drive the coefficient opening of electro-hydraulic proportional valve to control the system oil flow direction and flow rate by the linear PID algorithm, through controlling the position of hydraulic cylinder piston to the desired to achieve the tractor automatically steering, until now, a cycle of control action is completed.

Steering control software code is programed with PLC's SFC and ST language, the corresponding compiler environment is the BODAS 3.0.

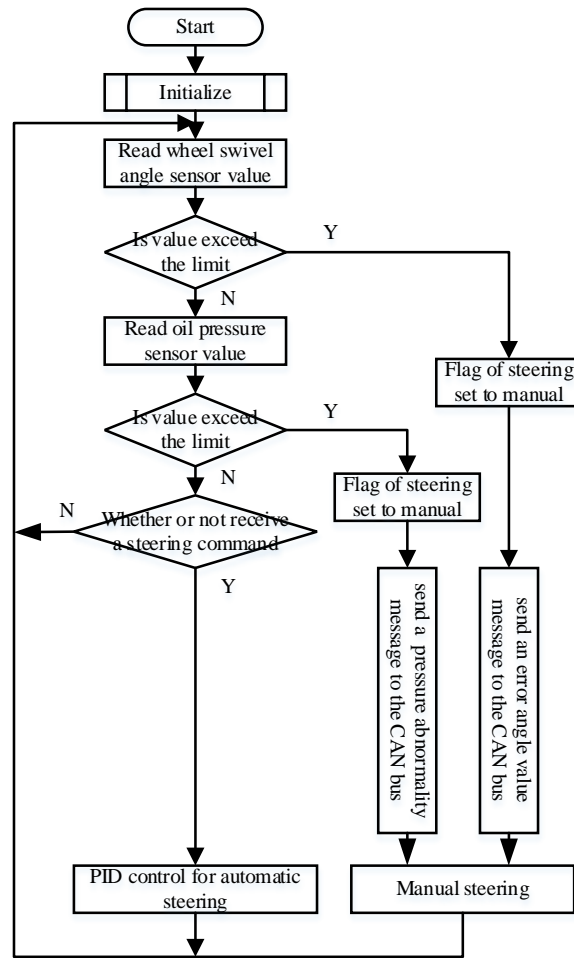

Fig.5 The steering controller flow chart

4 Modeling and Simulation

In order to analysis the dynamic of the electro-hydraulic steering system, it is necessary to establish the mathematical model of the proportional valve-control hydraulic cylinder system.

4.1 Proportional Directional Valve Transfer Function

In practice, as the response frequency of proportional valve is higher, the proportional directional valve's transfer function is generally simplified as a second-order system:

$$G_v(s) = \frac{Q_L(s)}{I(s)} = \frac{K_q}{\frac{1}{\omega_v^2} s^2 + \frac{2\xi_v}{\omega_v} s + 1} \quad (1)$$

Where: K_q is the flow gain of valve; ω_{v2} is the natural frequency of valve; ξ_v is the damping ratio of valve.

4.2 Valve-controlled Hydraulic Cylinder Transfer Function

In the practical, valve-controlled hydraulic cylinder is generally simplified as a second-order system.

$$\frac{Y(s)}{Q_L(s)} = \frac{\frac{K_q}{A} x_v - \frac{K_{ce}}{A^2} \left(1 + \frac{V_t}{4\beta_e K_{ce}} s \right) F_L}{s \left(\frac{s^2}{\omega_h^2} + \frac{2\xi_h}{\omega_h} s + 1 \right)} \quad (2)$$

Where, Y is a hydraulic cylinder piston displacement; K_q is the electro-hydraulic valve flow coefficient; x_v is the spool displacement of valve; A is the hydraulic cylinder cross-sectional area; K_{ce} is the total flow-pressure coefficient; V_t is the total volume; β_e is the effective modulus of elasticity of the working fluid; F_L is an external load acting on a hydraulic cylinder piston; ω_h is the non-damped hydraulic natural frequency; ξ_h is hydraulic damping ratio.

As the FT704 steering hydraulic cylinder is an asymmetric cylinder, it is necessary to adjust the mathematical model of valve controlled hydraulic cylinder according to the running state:

When the piston elongates ($dy/dt > 0$), the transfer function of valve-controlled hydraulic cylinder is:

$$\frac{Y(s)}{Q_L(s)} = \frac{\frac{K_q}{A_1} x_v - \frac{K_{ce}}{A_1^2} \left(1 + \frac{V_t}{4\beta_e K_{ce}} s \right) F_L}{s \left(\frac{s^2}{\omega_{h1}^2} + \frac{2\xi_{h1}}{\omega_{h1}} s + 1 \right)} \quad (3)$$

$$\omega_{h1} = \sqrt{\frac{4\beta_e A_1^2}{V_t m_t}} \quad (4)$$

$$\xi_{h1} = \frac{K_{ce}}{A_1} \sqrt{\frac{\beta_e m_t}{V_t}} + \frac{B_p}{4A_1} \sqrt{\frac{V_t}{\beta_e m_t}} \quad (5)$$

When the piston shortens ($dy/dt < 0$), the transfer function of valve-controlled hydraulic cylinder is:

$$\frac{Y(s)}{Q_L(s)} = \frac{\frac{K_q}{A_2} x_v - \frac{K_{ce}}{A_2^2} \left(1 + \frac{V_t}{4\beta_e K_{ce}} s \right) F_L}{s \left(\frac{s^2}{\omega_{h2}^2} + \frac{2\xi_{h2}}{\omega_{h2}} s + 1 \right)} \quad (6)$$

$$\omega_{h2} = \sqrt{\frac{4\beta_e A_2^2}{V_t m_t}} \quad (7)$$

$$\xi_{h2} = \frac{K_{ce}}{A_2} \sqrt{\frac{\beta_e m_t}{V_t}} + \frac{B_p}{4A_2} \sqrt{\frac{V_t}{\beta_e m_t}} \quad (8)$$

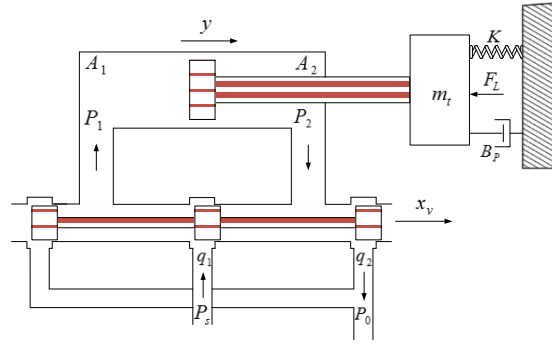

Fig.6 The schematic diagram of valve-controlled asymmetric hydraulic cylinder

4.3 The Tractor Steering Trapezium

The tractor steering trapezium can be simplified like Fig.7, the mathematical relationship between wheel swivel angle θ and hydraulic cylinder length L can be get out which likes this:

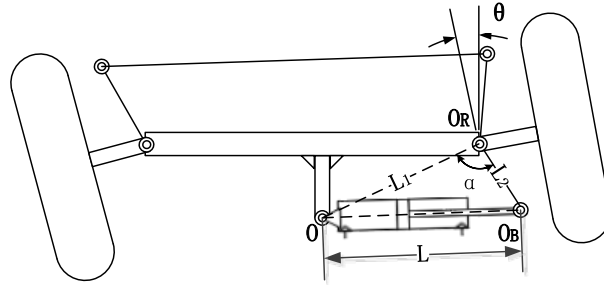

Fig.7 Tractor steering trapezium

$$\theta = \frac{180}{\pi} \left(\arccos \frac{L_1^2 + L_2^2 - L^2}{2L_1L_2} - \arccos \frac{L_1^2 + L_2^2 - L_0^2}{2L_1L_2} \right) \quad (9)$$

Where: θ is wheel swivel angle; L_0 is hydraulic cylinder length when the wheel swivel angle is 0° .

4.4 The Transfer Function of Wheel Swivel Angle

The input of the angle sensor is the wheel swivel angle θ , while the output is voltage U_f , the bandwidth is much higher than the system bandwidth, the wheel swivel angle sensor can be regarded as a proportional link, so the mathematical model can be expressed as:

$$U_f = \theta K_a \quad (10)$$

Where: U_f is feedback voltage; K_a is the flow gain of wheel swivel angle sensor; θ is wheel swivel angle.

4.5 System Simulation

Reference to the hydraulic system design manual, the main parameters of system transfer function are as follows:

Electro-hydraulic directional valve leakage flow $Q_{vp} = 2.5$ L/min

Electro-hydraulic directional valve flow gain $K_q = 2$ m³/s

Electro-hydraulic directional valve leakage factor $K_{ce} = 5.95 \times 10^{-12}$ m³/s

Total volume of valve chamber and hydraulic cylinder $V_t = 6.5 \times 10^{-3}$ m³

After definite the related parameters of system transfer function, the control

simulation model of valve-controlled hydraulic cylinder's mathematical model is established. As shown in Fig.8.

According to the simulation model, PID adjust and calibration link is added to simulation model, through adjusting the parameters of simulation control system, we can get different output. Considering the load fluctuation is not large in the actual operating conditions, the load is set to a constant, we can set different amplitude of the step signal. Fig.9 is a step response curve about typical step signal $\pm 45^\circ$. Considering the basic effect of proportion K_p , integration K_i and differentiation K_d on the control system. According to decay curve method to adjust the PID parameters, until the system has good dynamic response performance, overshoot, adjustment time and steady-state error and other indicators can be control in the design range, with good fastness and stability, and meets the overall design requirements of steering control. The measured curve of automatic steering control system with PID correction shown in Fig.10.

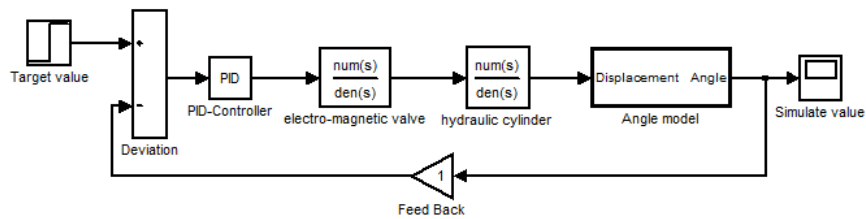

Fig.8 The simulation model of automatic steering control system

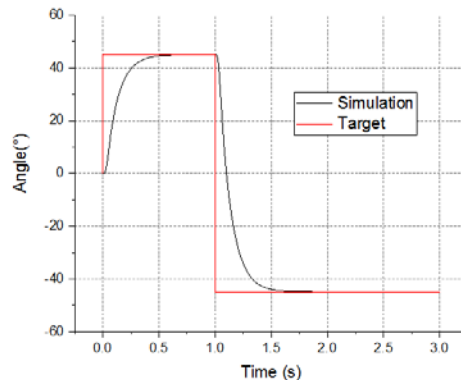

Fig.9 The step response simulation curve of automatic steering control system

5 Test

Transferring the controller, angle sensor, field computer, junction box and so on to a refitted tractor and testing the tractor electronic control hydraulic steering system. During the test, the USB-CAN module is accessed automatic navigation CAN bus and the CANTest software is used to record the commands of steering control from the field computer and return data of the wheel swivel angle, the test result is shown in Fig.10. As can be seen from Figure 10 the regulation time is 1.36 seconds while the wheel is rotated from 0° to 45° , and the steady-state error to a maximum of 0.391° , and the steady state error of average error of 0.138° . The regulation time is 1.58 seconds while the wheel is rotated from 45° to 0° , and the steady-state error to a maximum of 0.297° , the steady state error of average error of 0.159° . The results show that the refitted steering control system has good response speed and accuracy.

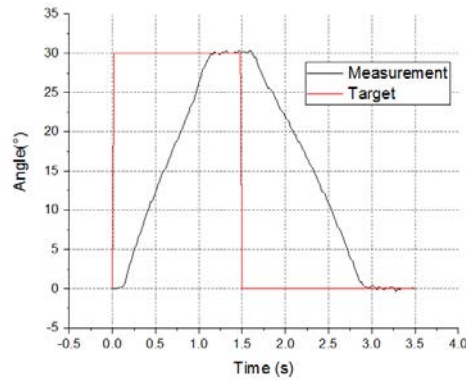

Fig.10 Steering test result of tractor

The field navigation test was test in the Beijing Changping Xiaotangshan National Precision Agriculture demonstration basement. During the test, the speed of the tractor is 1m/s which is controlled by the fixed oil supply with the manual gear, by acquiring the coordinates of two different points in the field, the field computer forms a straight line and serves as the navigation line. The field computer is else be used to record the tractor tracking error, the test result is shown in Fig.11. The results show that the tractor tracking error is not larger than 5.98cm, and the average tracking error is not larger than 1.23cm, so the response speed and control accuracy of the automatic steering system meet the requirement of the automatic navigation system.

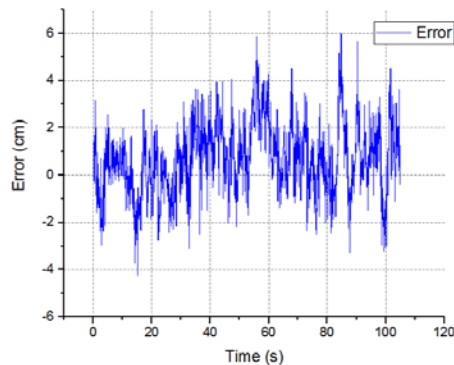

Fig.11 Field navigation test of tractor

6 Conclusion

According to the proposed automatic steering control scheme, refitting the original tractor steering system of Lovol Europard FT704 tractor, establishing an automatic steering test platform of full hydraulic steering tractor, designing an automatic steering control system of tractor based on CAN bus, and realizing the automatic control of the steering system and the accurate control of the wheel angle.

The mathematical model and control simulation model of the automatic steering system is established, a PID adjust and calibration link is added, reference to decay curve method to adjust the PID parameters, and the performance of the automatic the steering system and the effect of field navigation is tested. The results show that the response time of 45° steering control step signal is not larger than 1.58 seconds, the steady-state error is not larger than 0.391°, the steady state error of average error is not larger than 0.391°; the tractor tracking error is not larger than 5.98cm, and the average tracking error is not larger than 1.23cm. The results show that the response speed and control accuracy of the refitted automatic steering

system meet the requirement of automatic steering control of agricultural automatic navigation system.

Acknowledgements

This work is supported by Beijing science and technology planning project of China (D161100003216003), National Natural Science Foundation of China (31571564), the BAAFS innovation team project of China (JNKYT201607), Recommend International Advanced Agricultural Science and Technology Plan Grant of China (2016-X26), and Science and technology plan project of Heilongjiang farms & land reclamation administration Grant of China (HNK 135-06-05).

References

1. Zhang, Z., Luo, X., Li, J.: Automatic steering control system of wheeled model farming machinery. *Transactions of the CSAE*, 21(11), 77-80 (2005).
2. Gao, L., Hu, J., Bai, X., et al.: Agro-machinery Automatic Navigation Control System Study for Precision Agriculture Applications. *International Conference on Broadcast Technology and Multimedia Communication*, 315-322 (2010).
3. Zhou, J., Zheng, W., Li, S., et al.: Automatic Navigation Control System for Tractor Based on ISO 11783. *Transactions of The Chinese Society of Agricultural Machinery*, 41(4), 184-188 (2010).
4. Sarkar, BK., Mandal, P., Saha, R., et al.: GA-optimized feedforward-PID tracking control for a rugged electrohydraulic system design. *ISA Transactions*, 52(6), 853-861 (2013).
5. Wang, N., Shi, J., Li, G.: Study on Active Steering Control Strategy for Steer-by-Wire System. *Automobile Applied Technology* (2016).
6. Lu, Z., Chang, J., Bai, X., et al.: Analysis of Steering Control Strategy on Tractor's Hydraulic Steering By-Wire System. *Applied Mechanics and Materials*, 487, 630-634 (2014).
7. Yang, X., Luo, M., Mei, T., et al.: Co-simulation research of the mechanical-hydraulic-control coupling system of ITER tractor. *Plasma Science and Technology*, 11(3), 334-340 (2009).
8. Zhang, G., Zhu, S., Li, W., et al.: Simulation and experiment of in-situ steering of large wheel tractor with hinge swing link. *Transactions of the Chinese Society for Agricultural Machinery*, 43(10), 25-30 (2012).
9. Chang, J.: Research on Steering Control Strategy of the Tractor's Hydraulic Steering By-Wire System. M.S. Thesis, Nanjing Agricultural University, Nanjing (2012).
10. Luo, X., Zhang, Z., Zhao, Z., et al.: Design of DGPS navigation control system for Dongfanghong X-804 tractor. *Transactions of the Chinese Society of Agricultural Engineering*, 25(11), 139-145 (2009).
11. Lian, S., Chen, J., Jia, H., et al.: Automatic Turning Control System of Tractor Based on PID Control. *Journal of Agricultural Mechanization Research*, 6(6), 211-213 (2009).
12. You, W.: Design and Research on automatic steering control system of tractor seeding operation. M.S. Thesis, Shihezi University, Shihezi (2014).
13. Zhang, C.: The tractor automatic steering control system research and optimization. M.S. Thesis, Shihezi University, Shihezi (2016).