



HAL
open science

New fast time synchronization method for MIMO-OFDM systems

Ali Beydoun, Hamzé Alaeddine, Haidar Elmokdad

► **To cite this version:**

Ali Beydoun, Hamzé Alaeddine, Haidar Elmokdad. New fast time synchronization method for MIMO-OFDM systems. 11th IFIP Wireless and Mobile Networking Conference (WMNC 2018), Sep 2018, Prague, Czech Republic. pp.61-66. hal-01995431

HAL Id: hal-01995431

<https://inria.hal.science/hal-01995431>

Submitted on 26 Jan 2019

HAL is a multi-disciplinary open access archive for the deposit and dissemination of scientific research documents, whether they are published or not. The documents may come from teaching and research institutions in France or abroad, or from public or private research centers.

L'archive ouverte pluridisciplinaire **HAL**, est destinée au dépôt et à la diffusion de documents scientifiques de niveau recherche, publiés ou non, émanant des établissements d'enseignement et de recherche français ou étrangers, des laboratoires publics ou privés.



Distributed under a Creative Commons Attribution 4.0 International License

New fast time synchronization method for MIMO-OFDM systems

1st Ali Beydoun
Faculty of sciences-Physics department
Lebanese university
Beirut, Lebanon
ali.beydoun.edu.lb

2nd Hamze Alaeddine
Faculty of sciences-Physics department
Lebanese university
Beirut, Lebanon
hamze.alaeddine@ul.edu.lb

3rd Haidar elmokdad
Faculty of engineering
Lebanese university
Beirut, Lebanon
hmokdad@ul.edu.lb

Abstract—This paper presents a fast and low complexity timing synchronization method for MIMO-OFDM system. The proposed method uses simple CAZAC sequence as synchronization preamble and the combination of a set of correlators at the receiver side in order to increase the probability of correct timing acquisition. Simulation results in AWGN-Rayleigh fading channel show that an acquisition probability of 1 could be achieved for a Signal to Noise Ratio (SNR) higher than $-20dB$ with a preamble length of 1024.

Index Terms—MIMO-OFDM system, Timing synchronization, CAZAC sequence, Maximum ratio combiner

1. Introduction

The current trend in mobile communication systems goes towards the integration of novel data intensive applications such that high-definition video streaming, smart health monitoring, Internet of Things (IoT) and other multimedia services which requires a large increase in the data rate [1] [2]. To achieve this target, the combination of Multiple Input Multiple-Output (MIMO) system with Orthogonal Frequency Division Multiplexing (OFDM) presents a promising solution due to its capability of supporting high data rates [3]. In fact, OFDM has attracted a lot of attention to achieve higher data rate over wireless channel thanks to its higher spectral efficiency, its simplicity and its robustness against frequency selective channels by dividing the entire channel into many narrow flat fading orthogonal sub-channels which reduces the Inter-Carrier Interference and the Inter-Symbol Interference (ISI) [4]. Moreover, the MIMO system [5], using multiple antennas at the both side of transceiver, allows to increase the link capacity by sending different data stream over different transmit antenna or to improve the link reliability by sending the same data stream over different antenna using Space Time Block Code (STBC) [6].

One of the main problems of MIMO-OFDM system is the timing synchronization between the transmitter and the receiver. Indeed, incorrect timing synchronization introduces inter-carrier interference and leads to apply the FFT at the receiver side at the undesired position which prevents the OFDM signal to be correctly decoded and decreases significantly the expected performances. Therefore, accurate

timing synchronization is crucial for reliable reception of the transmitted data using MIMO-OFDM [5].

Several timing synchronization approaches have been proposed for MIMO-OFDM system in the literature [7], [8], [9], [10]. The main idea of Schmidl and Cox algorithm is to transmit a synchronization preamble, in front of the signal to be transmitted, composed of two identical halves of an orthogonal sequence. At the receiver side, the synchronization is performed in two steps:

- 1) Coarse synchronization: This steps tries to roughly localize the synchronization preamble. A running window correlation of every N samples of the received signal with the next consecutive N samples is performed in order to determine the Region Of Interest (ROI) where the synchronization preamble is present.
- 2) Fine synchronization: In order to find the exact position of the first sample, the received signal is correlated with the known preamble sequence in the region of interest to detect a correlation peak that precisely locates the first sample of the synchronization preamble and deduce consequently the start of the data OFDM symbols.

This method produces broad plateau in the autocorrelation metric due to the presence of two identical sequences in the preamble which increases the region of interest and therefore the computational complexity and the execution time will be increased [9]. In [10], the plateau effect was removed using sliding window differentiator after the coarse synchronization. However the execution time remains high as the synchronization is always done in two steps. In order to reduce the execution time, the solution proposed in [11] avoids the plateau problem and achieves the synchronization in one step using different preamble structures based on CAZAC Sequence. These preambles are inserted in the frequency domain before the Inverse Fourier Transform (IFFT) and the cyclic prefix insertion which increases the computational resources. For this purpose, this paper proposes a new synchronization scheme aiming to insert preambles in the time domain in order to not involve the FFT in the synchronization process and to reduce consequently the execution time.

The remaining of the paper is organized as follows. Section 2 introduces briefly the MIMO-OFDM system model. The proposed timing synchronization method is described in section 3. Simulations results and comparison are discussed in section 4. Finally, the conclusion is drawn in section 5.

2. MIMO-OFDM system model

A simple 2×2 MIMO-OFDM system with two transmit antennas and two receive antennas using the STBC-Alamouti encoder is shown in Figure 1.

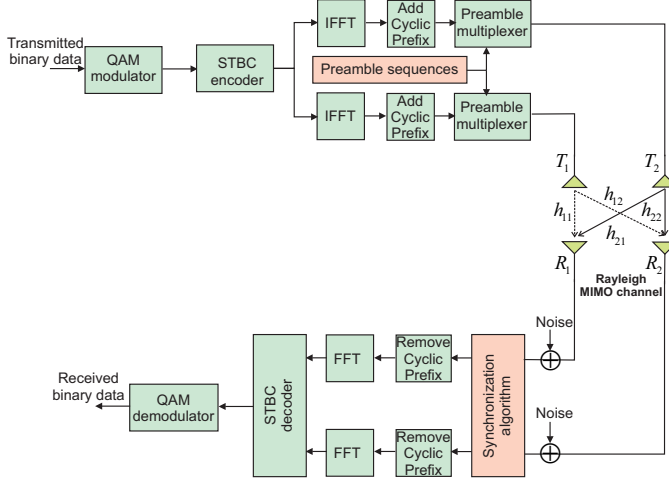

Figure 1. Simplified block diagram of MIMO-OFDM system.

The binary data to be transmitted is first mapped to the complex modulation symbols by using M-QAM signal constellation. The QAM symbols are then introduced into a STBC (Space-Time Block Coding) encoder that allows to exploit the spatial diversity and increases the reliability of transmission [12]. Thereafter, Inverse Fast Fourier Transform (IFFT) is applied to generate the OFDM symbols. A cyclic prefix (CP), the replica of last part of any given OFDM symbol, is attached at the beginning of each time domain OFDM symbol to counteract the distortion caused by ISI in the channel. The length of CP should exceed the maximum excess delay of the multipath propagation channel [4]. After the insertion of CP, the resultant OFDM symbols are converted to serial form and are transmitted over the 2×2 AWGN Rayleigh channel. The OFDM symbol transmitted from the i^{th} transmitting antenna is given by [4]:

$$s_i(n) = \frac{1}{\sqrt{N}} \sum_{k=0}^N S_i(k) e^{j \frac{2\pi n k}{N}} \quad (1)$$

where $S_i(k)$ is the data in the frequency domain before the IFFT and N is the number of sub-carriers for one OFDM symbol. The Rayleigh channel between i^{th} transmit antenna and j^{th} receive antenna is given by:

$$h_{ij}(t) = \sum_{l=0}^L \alpha_{ij}^l \delta(t - \tau_{ij}^l) \quad (2)$$

where L is the number of multi-path channels between i^{th} transmitter and j^{th} receiver. α_{ij}^l denotes the channel gain and τ_{ij}^l denotes the delay of the path.

The received signal r_j on each receive antenna R_j is given by:

$$r_j(t) = \sum_{i=1}^2 \sum_{l=0}^L (\alpha_{ij}^l \delta(t - \tau_{ij}^l) * s_i(t)) + n_j(t), \quad j = 1, 2 \quad (3)$$

where s_i is the transmitted signal on the transmit antenna T_i , n_j is the additive white Gaussian noise (AWGN).

At the receiver side, the first block after the analog to digital converter (ADC) is the timing synchronization block. After a good timing synchronization, the cyclic prefix of each OFDM symbol is removed. The signal returns back into frequency domain thanks to the FFT block. The OFDM symbols are then decoded and combined by the STBC decoder. Finally, a QAM demodulator is used to demodulate and recover the binary data.

3. Preamble timing synchronization algorithm for mimo-ofdm system

3.1. Review of timing synchronization method

In order to reduce the execution time, the timing synchronization method proposed in [11] performs the synchronization in single step. It is based on sending a synchronization preamble at the beginning of each OFDM frame that has the same length as an OFDM symbol. The main characteristic of the synchronization preamble is to have good autocorrelation and cross-correlation properties in order to detect a correlation peak as closed as possible to a Dirac pulse. On the other hand, the synchronization preambles should be orthogonal to eliminate the interferences between preambles at simultaneous transmissions in MIMO systems. Several types of preambles have been proposed in [11] using Constant Amplitude Zero Auto-Correlation (CAZAC) sequences [13]. These sequences are characterized by their constant amplitude and good correlation properties. They are expressed by:

$$C(k) = \begin{cases} e^{j \frac{\pi M k(k+1)}{L_c}} & \text{if } L_c \text{ is odd} \\ e^{j \frac{\pi M k^2}{L_c}} & \text{if } L_c \text{ is even} \end{cases} \quad (4)$$

where L_c is the length of CAZAC sequence, M is a natural number relatively prime to L_c and $0 \leq k \leq L_c - 1$.

The two types of preambles proposed in [11] are shown in Figure 2. For type 1, the CAZAC sequence of length $L_c = \frac{L_p}{2}$ is combined with its opposite conjugate to build the preamble of length L_p . The values of the CAZAC sequence are mapped to odd sub-carriers while the opposite conjugate values are mapped to even sub-carriers. For type 2, the CAZAC sequence and its opposite conjugate are placed side by side to form the synchronization preamble. For both types, the proposed preambles show good correlation properties and do not destroy the orthogonality between

sub-carriers while maintaining the orthogonality between different preambles over transmit antennas.

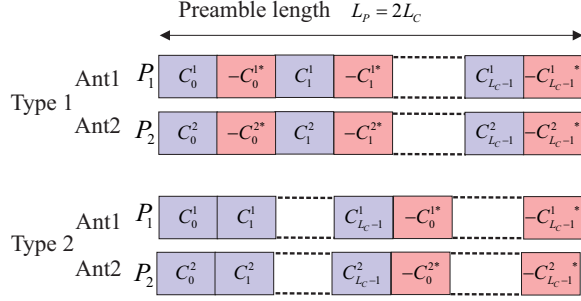

Figure 2. Schematic diagram of proposed preambles in [11].

It is important to recall that the preamble is inserted in the frequency domain which requires that the size of the preamble must be the same as the IFFT size. Therefore, the IFFT and the Add Cyclic Prefix blocks will be involved in the synchronization process which increases the complexity and the execution time of the method.

3.2. Proposed timing synchronization method

In order to reduce the complexity, the proposed method inserts the synchronization preamble in the time domain after the OFDM modulator (see Figure 1). In this case, the preamble structure is simply the CAZAC sequence without any restriction on the length L_p as shown in Figure 3.

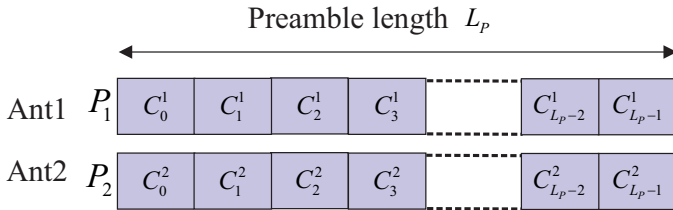

Figure 3. Proposed preamble structure using only CAZAC sequence.

However, the prime number M in the equation of the CAZAC sequence (4) must be carefully chosen from the set of prime numbers \mathbb{M} . Indeed, not all prime numbers give the same auto-correlation function. Figure 4 shows the normalized auto-correlation function with different prime numbers for a preamble length $L_p = 128$.

It can be noticed that the difference between the first and the second peak is not the same for all prime numbers. This difference is considered as the main criteria in our method to select the best two prime numbers, from the set \mathbb{M} , that correspond to the CAZAC sequences with the highest difference. Therefore, the auto-correlation of the synchronization preambles are as close as possible to a Dirac function.

At the receiver side, in order to detect the timing synchronization peak, the proposed synchronization algorithm correlates simultaneously the received signal on each antenna R_j with the known sequences P_1 and P_2 as shown

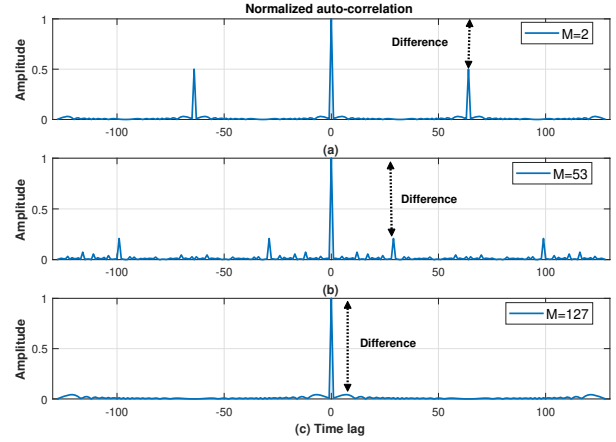

Figure 4. Normalized auto-correlation of CAZAC sequence with length $L_p = 128$ for the prime number (a) $M = 2$, (b) $M = 53$, (c) $M = 127$.

in Figure 5. Afterward, the timing synchronization estimate

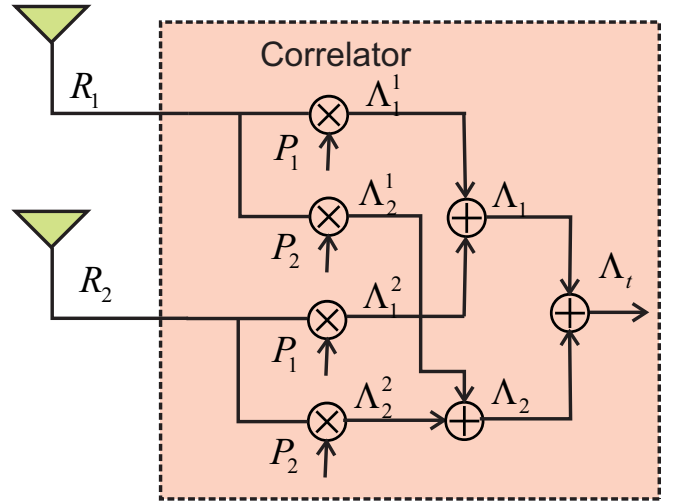

Figure 5. Synchronization module.

is chosen as the argument that maximizes $\|\lambda(d)\|^2$ and is denoted by $\hat{\tau}$:

$$\hat{\tau} = \arg \max_d \left(\|\lambda(d)\|^2 \right) \quad (5)$$

Three expressions could be considered for the timing metric $\lambda(d)$:

1)

$$\lambda(d) = \Lambda_i^j(d) = r_j \otimes P_i = \sum_{m=0}^{L_p-1} r_j(d+m) P_i^*(m) \quad (6)$$

where i and $j \in [1, 2]$ and \otimes denotes the correlation operation.

In this case, one correlator is needed and the timing metric $\lambda(d)$ is simply the correlation between any received signal r_j with any preamble sequence P_i .

2)

$$\lambda(d) = \Lambda_i(d) = \sum_{j=1}^2 \lambda_i^j(d) \quad i = 1, 2 \quad (7)$$

The received signals at both antennas are correlated with the same sequence P_i and added together in order to increase the acquisition probability.

3)

$$\lambda(d) = \Lambda_t(d) = \sum_{i=1}^2 \sum_{j=1}^2 \lambda_i^j(d) \quad (8)$$

To further increase the acquisition probability, the received signals at different antennas are correlated with both preambles and combined together in a way similar to Maximum Ratio Combining (MRC).

With purpose of validating this concept, the correlation of the received signal at antenna R_1 following the transmission of the two synchronization preambles with the known preamble P_1 is given by:

$$\Lambda_1^1 = (P_1 * h_{11} + P_2 * h_{21} + n_1) \otimes P_1 \quad (9)$$

where \otimes and $*$ denote the correlation and the convolution operations respectively. n_1 is the white noise added to the signal. Without loss of generality, we can interchange the correlation and convolution operations and rearrange equation 9 in the following way:

$$\Lambda_1^1 = \underbrace{(P_1 \otimes P_1)}_{\delta} * h_{11} + \underbrace{(P_2 \otimes P_1)}_{=0} * h_{12} + n_1' \quad (10)$$

Based on the orthogonality between preambles and the auto-correlation function of each preamble, the expression of Λ_1^1 is simplified to be :

$$\Lambda_1^1 = h_{11} + n_1' \quad (11)$$

This results can be easily extended for other correlators and we can conclude that the correlation of the received signal at the receive antenna R_j with the local sequence P_i produces the impulse response between the i^{th} transmitter and the j^{th} receiver plus some correlated noise.

Theoretically, the first tap of the channel impulse response, that corresponds to the direct path, has the highest amplitude and the start of the preamble can be efficiently detected. However, due to the presence of the noise in the channel (n_1' in (11)), it is difficult to identify the first tap in the channel as the first tap may not be necessarily the strongest peak especially at low Signal to Noise Ratio (SNR) values. For this purpose, the proposed method suggests the combination of the outputs of two or four correlators to increase the probability of correct detection at very low SNR values.

It is important to mention that this method could be easily extended without any loss of generality to higher order MIMO systems.

4. simulation results

The performance of the proposed method is evaluated by computer simulation using Matlab. In these simulations, a 2×2 MIMO-OFDM system is considered with the parameters listed in Table 1.

TABLE 1. SIMULATION PARAMETERS

Parameter	Value
FFT/IFFT length	$N = 512$
Cyclic Prefix length	48
Channel type	Multi-path Rayleigh and AWGN
Number of synchronization symbol	1
Modulation technique	4 QAM
Number of channel multi-path between different antenna [14]	$L = 6$
Propagation delay between multi path [14]	$[0 T_s, 2T_s, 3T_s, 4T_s, 5T_s]$
The power of each multi-path [14]	$[0.8111, 0.1532, 0.0289, 0.0055, 0.001, 0.0002]$

Figure 6 and Figure 7 show the probability of correct timing synchronization over an SNR range of $[-26 \dots 30]$ dB with the proposed method for different timing metrics (equations: 6, 7, 8). Each probability value is estimated using an average of 100 independent Monte Carlo trials. It can be noticed that for short preamble length

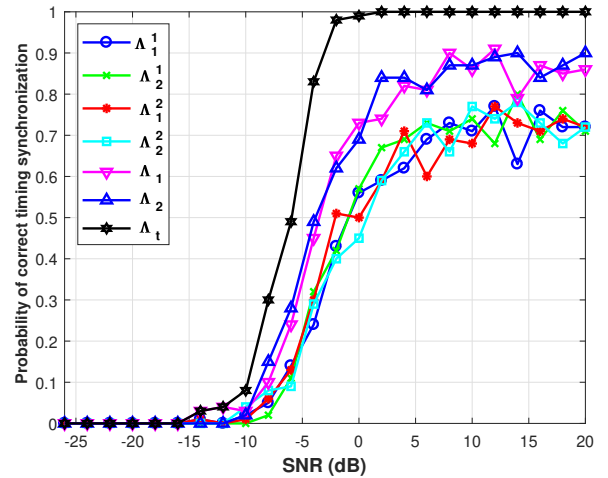

Figure 6. Probability of correct timing synchronization with the proposed method with preamble length $L_P = 64$ for different timing metrics.

($L_P = 64$) the performances with only one correlator (Λ_i^j , Eq. (6)) are almost the same. Increasing the number of correlators to 2 (Λ_i , Eq.(7)) or 4 (Λ_t , Eq. (8)) improves the algorithm's ability to detect the correct timing.

Figure 8 shows the effect of the preamble length L_P using the timing metric Λ_t and Figure 9 shows the evolution of the SNR threshold from which the acquisition probability is 1 in terms of the preamble length. It can be noticed that the higher the preamble length, the better the expected performance and the lower the SNR value above which 100% of correct detection is reached.

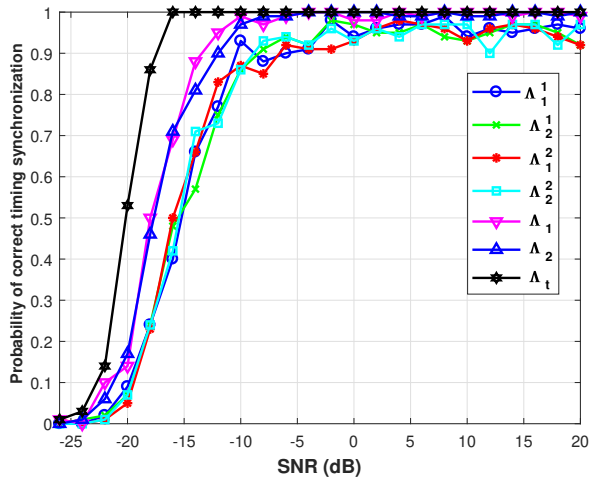

Figure 7. Probability of correct timing synchronization with the proposed method with preamble length $L_P = 1024$ for different timing metric.

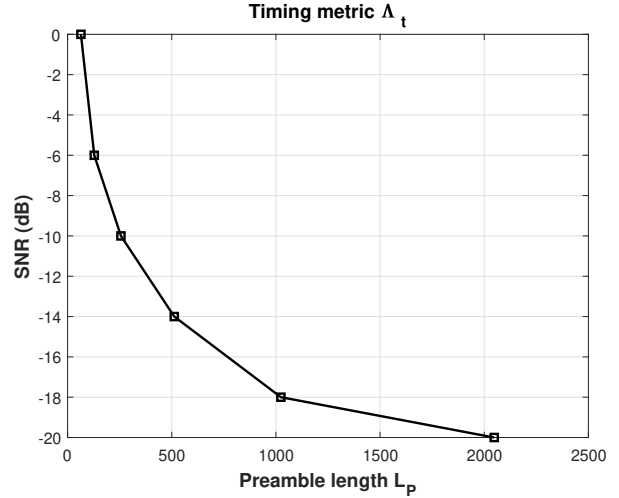

Figure 9. Evolution of the SNR threshold.

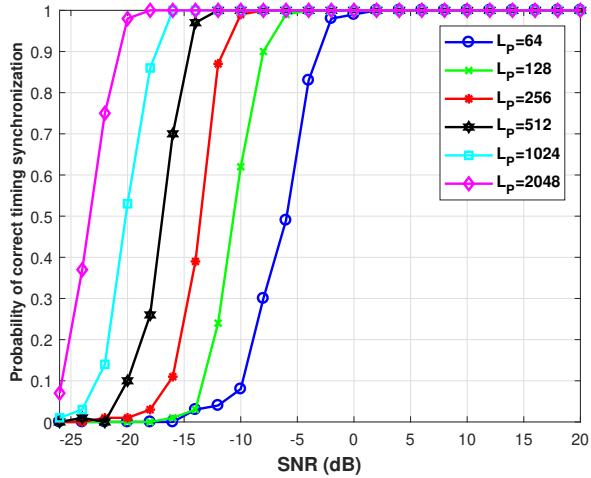

Figure 8. Probability of correct timing synchronization with the timing metric Λ_t for different preamble length.

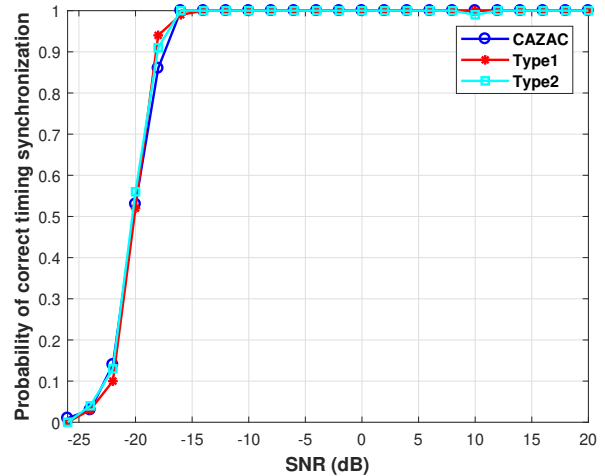

Figure 10. Comparison of the proposed method with the method proposed in [11].

Figure 10 compares the acquisition probability in terms of SNR using the timing metric Λ_t and a preamble length $L_P = 1024$ between the proposed method and the one presented in [11]. It can be shown that both methods give the same performance if the CAZAC sequence is well chosen with good auto-correlation function. However, the main advantage of the proposed method lies in the significant reduction of complexity and execution time.

5. conclusion

A robust synchronization method for MIMO-OFDM system was proposed in this paper. The proposed method aims to detect the timing start of the OFDM frame by correlating the received signal at both antenna with local orthogonal preambles and combining them in order to increase

the correct timing acquisition probability. The considered orthogonal preamble is simply a CAZAC sequence where the prime number in the sequence equation is carefully chosen in order to obtain an auto-correlation function as close as possible to a Dirac function. The proposed method shows satisfactory performance with an acquisition probability of 1 for $SNR > -20dB$ with a preamble length of 1024 while reducing considerably the computational complexity and the execution time compared to the solution presented in [11].

References

- [1] Y. Zhuang, J. Cappos, T. S. Rappaport, and R. McGeer, "Future Internet bandwidth trends: An investigation on current and future disruptive technologies," Secure Systems Lab, Dept. Comput. Sci. Eng., Polytech. Inst. New York Univ., New York, NY, USA, 1955. January 2013.

- [2] S. Din and A. Paul, "Smart health monitoring and management system: Toward autonomous wearable sensing for internet of things using big data analytics," *Future Generation Computer Systems*, Elsevier, 2018.
- [3] Y.S. Cho, J. Kim, W.Y. Yang and C.G. Kang R. Prasad, "MIMO-OFDM wireless communications with MATLAB ," John Wiley & Sons, 2010.
- [4] U. Jha and R. Prasad, "OFDM towards fixed and mobile broadband wireless access ," Artech House, Inc., 2007.
- [5] G.Tsoulos, "MIMO system technology for wireless communications,"CRC press, 2006.
- [6] V. Tarokh, A. Naguib,N. Seshadri and A.Calderbank, "Space-time codes for high data rate wireless communication: performance criteria in the presence of channel estimation errors, mobility, and multiple paths,"*IEEE Transactions on Communications*, vol. 47, pp. 199–207, 1999.
- [7] T. Schmidl and D. Cox, "Robust frequency and timing synchronization for OFDM," *IEEE transactions on communications*, vol. 45, pp. 1613–1621,1997.
- [8] C. Jieping, "An improved training sequence based timing synchronization algorithm for MIMO-OFDM system ," *Intelligent Systems Design and Engineering Applications (ISDEA)*, 2014 Fifth International Conference on, 2014.
- [9] S. Sreedhar, S. Sekhar and S. Pillai, "An efficient preamble design for timing synchronization in MIMO-OFDM systems," *IEEE Control, Instrumentation, Communication and Computational Technologies (ICCICCT)*, 2015 International Conference on, pp. 84–88,2015.
- [10] L. Nasraoui, L. Atallah and M. Siala, "Robust Synchronization Approach for MIMO-OFDM Systems with Space-Time Diversity ," *IEEE Vehicular Technology Conference (VTC Spring)*, 2015.
- [11] A. Rachini, F. Nouvel, A. Beydoun and B. Beydoun, "A Novel Timing Synchronization Method for MIMO-OFDM Systems ," *International Journal On Advances in Telecommunications*,vol. 7, pp. 22–33, 2014.
- [12] E. Larsson and P. Stoica, "Space-time block coding for wireless communications ," Cambridge university press, 2008.
- [13] P. Fan and M. Darnell, "Sequence design for communications applications ," Research Studies Press, 1996.
- [14] B. OHara and A. Petrick, "The IEEE 802.11 Handbook: A Designers Companion ," Standards Information Network IEEE Press, 2005.