



HAL
open science

Optimality of linear optical Bell measurements. How much can ancillae help?

Andrea Olivo, Frédéric Grosshans

► **To cite this version:**

Andrea Olivo, Frédéric Grosshans. Optimality of linear optical Bell measurements. How much can ancillae help?. GDR IQFA 9th Colloquium, Nov 2018, Montpellier, France. hal-01951749

HAL Id: hal-01951749

<https://inria.hal.science/hal-01951749>

Submitted on 11 Dec 2018

HAL is a multi-disciplinary open access archive for the deposit and dissemination of scientific research documents, whether they are published or not. The documents may come from teaching and research institutions in France or abroad, or from public or private research centers.

L'archive ouverte pluridisciplinaire **HAL**, est destinée au dépôt et à la diffusion de documents scientifiques de niveau recherche, publiés ou non, émanant des établissements d'enseignement et de recherche français ou étrangers, des laboratoires publics ou privés.

Optimality of linear optical Bell measurements

How much can ancillæ help?

Andrea Olivo^{1,2}, Frédéric Grosshans¹

¹INRIA Paris

²Laboratoire Aimé Cotton, Université Paris-Saclay

arXiv:1806.01243, Phys. Rev. A **98**, 042323



The task: unambiguous Bell measurement

$$|\phi^+\rangle = \frac{1}{\sqrt{2}}(|00\rangle + |11\rangle)$$

$$|\phi^-\rangle = \frac{1}{\sqrt{2}}(|00\rangle - |11\rangle)$$

$$|\psi^+\rangle = \frac{1}{\sqrt{2}}(|01\rangle + |10\rangle)$$

$$|\psi^-\rangle = \frac{1}{\sqrt{2}}(|01\rangle - |10\rangle)$$

Bell Measurement

Projective measurement on the Bell basis

Unambiguous

Outcome never wrong, but can fail with probability $\mathcal{P}_{\text{fail}}$

The task: unambiguous Bell measurement

$$|\phi^+\rangle = \frac{1}{\sqrt{2}}(|00\rangle + |11\rangle)$$

$$|\phi^-\rangle = \frac{1}{\sqrt{2}}(|00\rangle - |11\rangle)$$

$$|\psi^+\rangle = \frac{1}{\sqrt{2}}(|01\rangle + |10\rangle)$$

$$|\psi^-\rangle = \frac{1}{\sqrt{2}}(|01\rangle - |10\rangle)$$

Bell Measurement

Projective measurement on the Bell basis

Unambiguous

Outcome never wrong, but can fail with probability $\mathcal{P}_{\text{fail}}$

Quantum teleportation, dense coding, entanglement swapping...

The framework: static linear optics

Why? Because...

- ...experimentally easier: no feedforward

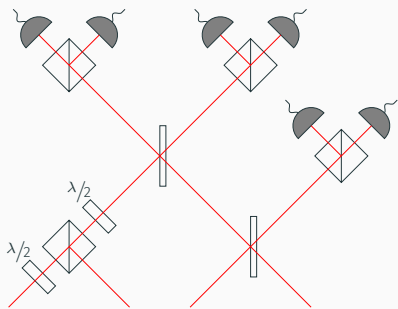

The framework: static linear optics

Why? Because...

- ...experimentally easier: **no feedforward**
- ...simple mathematical framework to work with

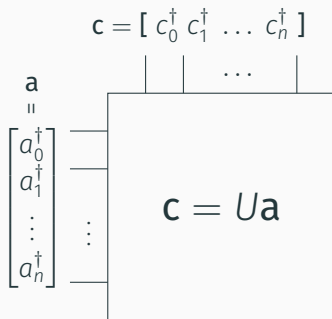
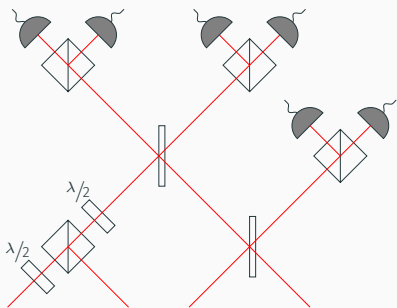

State of the art: Bell measurement without ancilla

[Braunstein and Mann, 1995]

- Known $\mathcal{P}_{\text{succ}} = \frac{1}{2}$ scheme [Braunstein & Mann, 1995]
- **Optimal**, even with feedforward [Calsamiglia & Lütkenhaus, 2001]

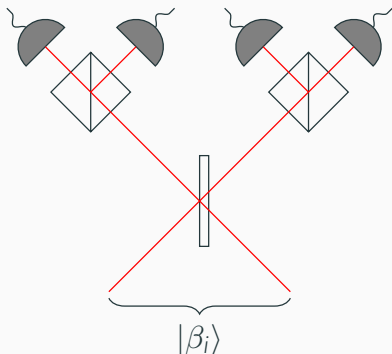

$$|\psi^+\rangle \longrightarrow \frac{1}{\sqrt{2}}(|1100\rangle + |0011\rangle)$$

$$|\psi^-\rangle \longrightarrow \frac{1}{\sqrt{2}}(|1001\rangle - |0110\rangle)$$

$$|\phi^\pm\rangle \longrightarrow \frac{i}{2}(|2000\rangle \pm |0200\rangle + |0020\rangle \pm |0002\rangle)$$

[Grice, 2011]

- $\mathcal{P}_{\text{succ}} = \frac{3}{4}$ with an extra $|\phi^+\rangle$ as ancilla
- $\mathcal{P}_{\text{fail}} = 2^{-N}$ with GHZ-like states of $2^N - 2$ photons

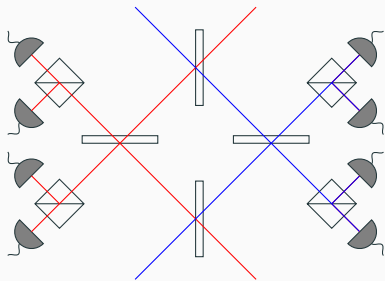

[Grice, 2011]

- $\mathcal{P}_{\text{succ}} = \frac{3}{4}$ with an extra $|\phi^+\rangle$ as ancilla
- $\mathcal{P}_{\text{fail}} = 2^{-N}$ with GHZ-like states of $2^N - 2$ photons

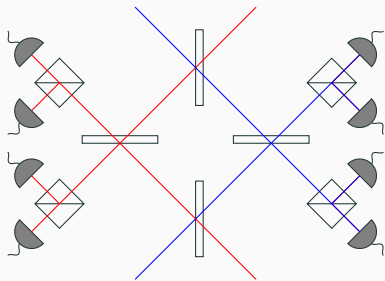

[Ewert and van Loock, 2014]

- $\mathcal{P}_{\text{succ}} = \frac{3}{4}$ with 4 single photons
- $\mathcal{P}_{\text{succ}} = \frac{25}{32}$ with 12 single photons
- Cons: limited efficiency
- Pros: unentangled ancilla (for the two above)

[Grice, 2011]

- $\mathcal{P}_{\text{succ}} = \frac{3}{4}$ with an extra $|\phi^+\rangle$ as ancilla
- $\mathcal{P}_{\text{fail}} = 2^{-N}$ with GHZ-like states of $2^N - 2$ photons

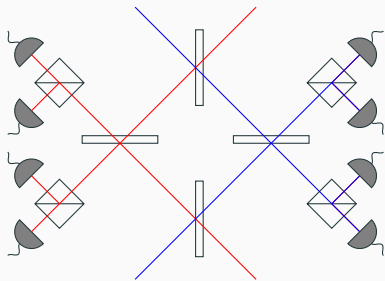

[Ewert and van Loock, 2014]

- $\mathcal{P}_{\text{succ}} = \frac{3}{4}$ with 4 single photons
- $\mathcal{P}_{\text{succ}} = \frac{25}{32}$ with 12 single photons
- Cons: limited efficiency
- Pros: unentangled ancilla (for the two above)

What can we say about their **optimality**?

Ideally, we want an **upper bound** on $\mathcal{P}_{\text{succ}}$ depending on the ancilla.

We provide:

Ideally, we want an **upper bound** on $\mathcal{P}_{\text{succ}}$ depending on the ancilla.

We provide:

- An **analytical** bound for polarization-preserving interferometers

Ideally, we want an **upper bound** on $\mathcal{P}_{\text{succ}}$ depending on the ancilla.

We provide:

- An **analytical** bound for polarization-preserving interferometers
- A thorough **numerical search** for generic (small) interferometers

Analytical upper bound

Overview of the proof

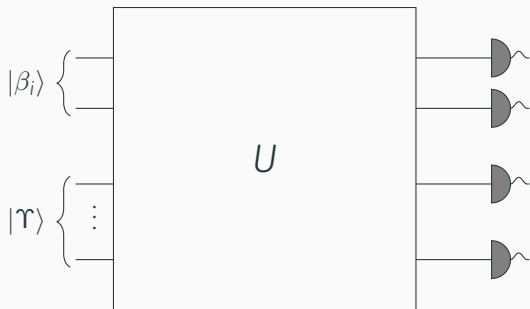

Input: $|\Psi_{\text{in}}\rangle = |\beta_i\rangle |\Upsilon\rangle$, with $|\Upsilon\rangle = \sum_{\lambda=0}^k v_{\lambda} |\Upsilon, \lambda\rangle$ a k -photon ancilla

Each $|\Upsilon, \lambda\rangle$ is a state with λ horizontally polarized photons

Overview of the proof

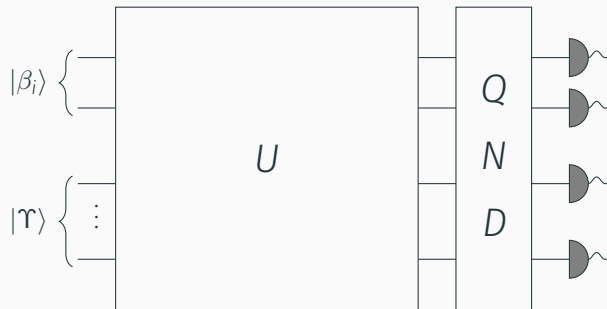

Output statistics unchanged under a projective measurement of the horizontally-polarized photon number of $|\psi_{\text{out}}\rangle$

Overview of the proof

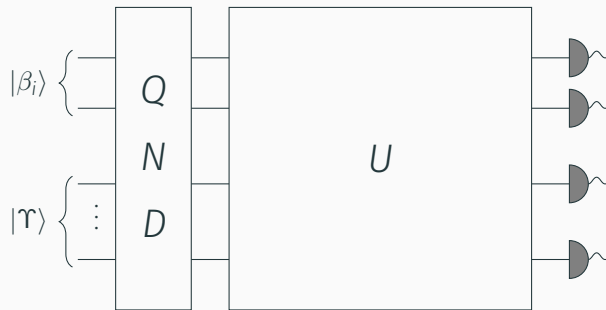

Measurement commutes \iff polarization-preserving network

Overview of the proof

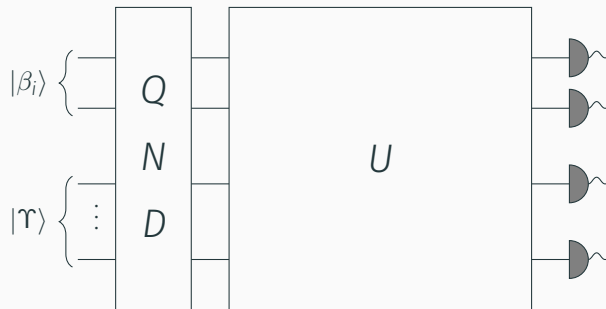

$|\psi^+\rangle$, $|\psi^-\rangle$ and $|\phi^\pm\rangle$ are mapped in **three orthogonal subspaces** $\forall \lambda$

Overview of the proof

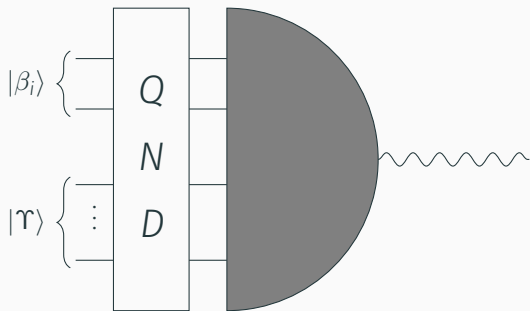

Non-orthogonal post-measurement states $|\Lambda^\pm\rangle$ corresponding to $|\phi^+\rangle$ and $|\phi^-\rangle$ can be discriminated with optimal $\mathcal{P}_{\text{succ}} \leq 1 - |\langle \Lambda^+ | \Lambda^- \rangle|$.

Ancilla polarization-based upper bound:

$$\mathcal{P}_{\text{fail}} \geq \frac{1}{2} \left(\max_{\lambda \text{ even}} |v_{\lambda}|^2 + \max_{\lambda \text{ odd}} |v_{\lambda}|^2 \right) \quad (1)$$

(looser) Photon number-based upper bound:

$$\mathcal{P}_{\text{fail}} \geq \frac{1}{\lceil k+1 \rceil_{\text{even}}} \quad (2)$$

N.B. The Grice's schemes **saturate** both bounds!

Linear network optimizer

Polynomial representation

Second quantization, n -modes interferometer.

Input/output state \longrightarrow polynomial in the input/output mode operators:

$$|\psi_{\text{in}}\rangle = P_{\text{in}}(a_1^\dagger, \dots, a_n^\dagger) |0\rangle \quad |\psi_{\text{out}}\rangle = P_{\text{out}}(c_1^\dagger, \dots, c_n^\dagger) |0\rangle$$

Action of the interferometer on $|\psi_{\text{in}}\rangle \longrightarrow$ **unitary transformation** U acting on the mode operators:

$$a_i^\dagger = \sum_{j=1}^n u_{ij} c_j^\dagger$$

Measurement of $|\psi_{\text{out}}\rangle$ by an array of PNRD.

Detection event \longrightarrow a configuration of clicks at the output.

Task: maximize $\mathcal{P}_{\text{succ}}$ over all possible n -modes interferometers, using k -photon ancilla $|\Upsilon\rangle$

Task: maximize $\mathcal{P}_{\text{succ}}$ over all possible n -modes interferometers, using k -photon ancilla $|\Upsilon\rangle$

1. For each $|\psi_{\text{in}}\rangle = |\beta_i\rangle |\Upsilon\rangle \longrightarrow 2^{\text{nd}}$ quantization output polynomial

The method

Task: maximize $\mathcal{P}_{\text{succ}}$ over all possible n -modes interferometers, using k -photon ancilla $|\Upsilon\rangle$

1. For each $|\psi_{\text{in}}\rangle = |\beta_i\rangle |\Upsilon\rangle \rightarrow 2^{\text{nd}}$ quantization output polynomial
2. Functions $p_i^e(U) \rightarrow$ probability of detection event e for input β_i

The method

Task: maximize $\mathcal{P}_{\text{succ}}$ over all possible n -modes interferometers, using k -photon ancilla $|\Upsilon\rangle$

1. For each $|\psi_{\text{in}}\rangle = |\beta_i\rangle |\Upsilon\rangle \rightarrow 2^{\text{nd}}$ quantization output polynomial
2. Functions $p_i^e(U) \rightarrow$ probability of detection event e for input β_i

Above steps are **automatic symbolic** computation. Then:

The method

Task: maximize $\mathcal{P}_{\text{succ}}$ over all possible n -modes interferometers, using k -photon ancilla $|\Upsilon\rangle$

1. For each $|\psi_{\text{in}}\rangle = |\beta_i\rangle |\Upsilon\rangle \rightarrow 2^{\text{nd}}$ quantization output polynomial
2. Functions $p_i^e(U) \rightarrow$ probability of detection event e for input β_i

Above steps are automatic symbolic computation. Then:

3. Functions $p_i^e(U)$ are hardcoded in C

The method

Task: maximize $\mathcal{P}_{\text{succ}}$ over all possible n -modes interferometers, using k -photon ancilla $|\Upsilon\rangle$

1. For each $|\psi_{\text{in}}\rangle = |\beta_i\rangle |\Upsilon\rangle \rightarrow 2^{\text{nd}}$ quantization output polynomial
2. Functions $p_i^e(U) \rightarrow$ probability of detection event e for input β_i

Above steps are automatic symbolic computation. Then:

3. Functions $p_i^e(U)$ are hardcoded in C
4. A f.o.m. $f(U)$ is numerically optimized over $U(n)$

An example: no ancilla on $|\phi^+\rangle$

$$n = 4, k = 0 \quad P_{\text{in}} = \frac{1}{\sqrt{2}}(a_1^\dagger a_3^\dagger + a_2^\dagger a_4^\dagger)$$

An example: no ancilla on $|\phi^+\rangle$

$$n = 4, k = 0 \quad P_{\text{in}} = \frac{1}{\sqrt{2}}(a_1^\dagger a_3^\dagger + a_2^\dagger a_4^\dagger)$$

↓

$$P_{\text{out}} = \frac{1}{\sqrt{2}} \left(\sum_{j_1} u_{1j_1} c_{j_1}^\dagger \right) \left(\sum_{j_2} u_{3j_2} c_{j_2}^\dagger \right) + \frac{1}{\sqrt{2}} \left(\sum_{j_3} u_{2j_3} c_{j_3}^\dagger \right) \left(\sum_{j_4} u_{4j_4} c_{j_4}^\dagger \right)$$

An example: no ancilla on $|\phi^+\rangle$

$$n = 4, k = 0 \quad P_{\text{in}} = \frac{1}{\sqrt{2}}(a_1^\dagger a_3^\dagger + a_2^\dagger a_4^\dagger)$$

↓

$$P_{\text{out}} = \frac{1}{\sqrt{2}} \left(\sum_{j_1} u_{1j_1} c_{j_1}^\dagger \right) \left(\sum_{j_2} u_{3j_2} c_{j_2}^\dagger \right) + \frac{1}{\sqrt{2}} \left(\sum_{j_3} u_{2j_3} c_{j_3}^\dagger \right) \left(\sum_{j_4} u_{4j_4} c_{j_4}^\dagger \right)$$

↓

| | |
|------|------------------------------------------------------------------------|
| 2000 | $u_{11}u_{31} + u_{21}u_{41}$ |
| 0200 | $u_{12}u_{32} + u_{22}u_{42}$ |
| 0020 | $u_{13}u_{33} + u_{23}u_{43}$ |
| 0002 | $u_{14}u_{34} + u_{24}u_{44}$ |
| 1100 | $(u_{11}u_{32} + u_{12}u_{31} + u_{21}u_{42} + u_{22}u_{41})/\sqrt{2}$ |
| 1010 | $(u_{11}u_{33} + u_{13}u_{31} + u_{21}u_{43} + u_{23}u_{41})/\sqrt{2}$ |
| 1001 | $(u_{11}u_{34} + u_{14}u_{31} + u_{21}u_{44} + u_{24}u_{41})/\sqrt{2}$ |
| 0110 | $(u_{12}u_{33} + u_{13}u_{32} + u_{22}u_{43} + u_{23}u_{42})/\sqrt{2}$ |
| 0101 | $(u_{12}u_{34} + u_{14}u_{32} + u_{22}u_{44} + u_{24}u_{42})/\sqrt{2}$ |
| 0011 | $(u_{13}u_{34} + u_{14}u_{33} + u_{23}u_{44} + u_{24}u_{43})/\sqrt{2}$ |

An example: no ancilla on $|\phi^+\rangle$

$$n = 4, k = 0 \quad P_{\text{in}} = \frac{1}{\sqrt{2}}(a_1^\dagger a_3^\dagger + a_2^\dagger a_4^\dagger)$$

↓

$$P_{\text{out}} = \frac{1}{\sqrt{2}} \left(\sum_{j_1} u_{1j_1} c_{j_1}^\dagger \right) \left(\sum_{j_2} u_{3j_2} c_{j_2}^\dagger \right) + \frac{1}{\sqrt{2}} \left(\sum_{j_3} u_{2j_3} c_{j_3}^\dagger \right) \left(\sum_{j_4} u_{4j_4} c_{j_4}^\dagger \right)$$

↓

| | |
|------|------------------------------------------------------------------------|
| 2000 | $u_{11}u_{31} + u_{21}u_{41}$ |
| 0200 | $u_{12}u_{32} + u_{22}u_{42}$ |
| 0020 | $u_{13}u_{33} + u_{23}u_{43}$ |
| 0002 | $u_{14}u_{34} + u_{24}u_{44}$ |
| 1100 | $(u_{11}u_{32} + u_{12}u_{31} + u_{21}u_{42} + u_{22}u_{41})/\sqrt{2}$ |
| 1010 | $(u_{11}u_{33} + u_{13}u_{31} + u_{21}u_{43} + u_{23}u_{41})/\sqrt{2}$ |
| 1001 | $(u_{11}u_{34} + u_{14}u_{31} + u_{21}u_{44} + u_{24}u_{41})/\sqrt{2}$ |
| 0110 | $(u_{12}u_{33} + u_{13}u_{32} + u_{22}u_{43} + u_{23}u_{42})/\sqrt{2}$ |
| 0101 | $(u_{12}u_{34} + u_{14}u_{32} + u_{22}u_{44} + u_{24}u_{42})/\sqrt{2}$ |
| 0011 | $(u_{13}u_{34} + u_{14}u_{33} + u_{23}u_{44} + u_{24}u_{43})/\sqrt{2}$ |

Optimization: a case for symbolic computation

Why not using pen and paper for $p_i^e(U)$?

For (small!) $\frac{3}{4}$ Grice's scheme:

| | |
|----------------------------------|--------|
| Total number of functions | 1320 |
| Independent | just 5 |

Optimization: a case for symbolic computation

Why not using pen and paper for $p_i^e(U)$?

For (small!) $\frac{3}{4}$ Grice's scheme:

| | |
|---------------------------|--------|
| Total number of functions | 1320 |
| Independent | just 5 |

But 2nd iteration, $\frac{7}{8}$:

| | |
|---------------------------|------------------|
| Total number of functions | 490314 |
| Independent | 22 |
| Total number of terms | $1,8 \cdot 10^6$ |

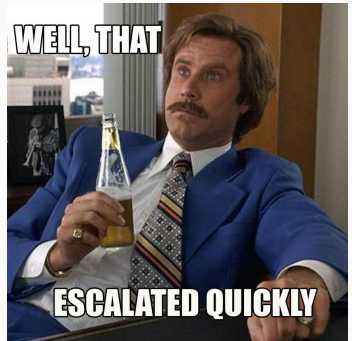

Results

Simplest type of ancilla, no known scheme

- Polarization-preserving bound predicts $\mathcal{P}_{\text{succ}} \leq \frac{1}{2}$
- Numerical search confirms the result

Simplest type of ancilla, no known scheme

- Polarization-preserving bound predicts $\mathcal{P}_{\text{succ}} \leq \frac{1}{2}$
- Numerical search confirms the result

We find **no advantage** using just one extra photon.

More single, unentangled photons

| k photons | Pol. Pres. bound | Num. search | Explicit scheme |
|-------------|------------------|-------------|-----------------|
| 2 | $5/8$ | $5/8$ | $5/8$ |
| 4 | $3/4$ | $3/4$ | $3/4$ |
| 6 | $13/16$ | $3/4$ | — |
| 8 | $25/32$ | — | $49/64$ |
| 12 | $13/16$ | — | $25/32$ |

More single, unentangled photons

| k photons | Pol. Pres. bound | Num. search | Explicit scheme |
|-------------|------------------|-------------|-----------------|
| 2 | 5/8 | 5/8 | 5/8 |
| 4 | 3/4 | 3/4 | 3/4 |
| 6 | 13/16 | 3/4 | — |
| 8 | 25/32 | — | 49/64 |
| 12 | 13/16 | — | 25/32 |

just 2 single photons beat 50% limit!

The “half”-Ewert & van Loock scheme

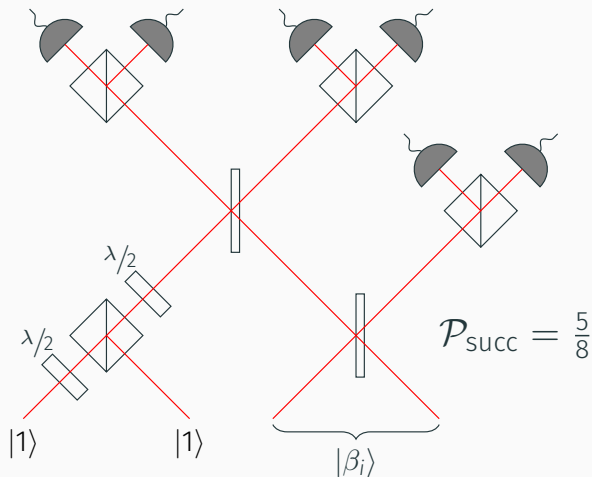

Also independently found by Ewert & van Loock

Do **entangled** ancillæ help?

- Grice's one-Bell-pair: **optimal** $\frac{3}{4}$, by numerical search

Do **entangled** ancillæ help?

- Grice's one-Bell-pair: **optimal** $\frac{3}{4}$, by numerical search
- 2 Bell pairs: no better than one Bell pair
- 3 to N Bell pairs: out of reach with 12 cores, 256GB RAM cluster
 - Pol. pres. bound predicts $\mathcal{P}_{\text{fail}} \gtrsim \frac{1}{\sqrt{\pi k}} > \frac{1}{k}$

Do **entangled** ancillæ help?

- Grice's one-Bell-pair: **optimal** $\frac{3}{4}$, by numerical search
- 2 Bell pairs: no better than one Bell pair
- 3 to N Bell pairs: out of reach with 12 cores, 256GB RAM cluster
 - Pol. pres. bound predicts $\mathcal{P}_{\text{fail}} \gtrsim \frac{1}{\sqrt{\pi k}} > \frac{1}{k}$
- Grice's $\frac{7}{8}$ scheme needs $n = 16, k = 6$: barely out of reach

Conclusion

What can we say on the optimal $\mathcal{P}_{\text{succ}}$ of unambiguous Bell measurement?

- **Upper bound** for polarization-preserving interferometers, saturated by known schemes
- Hybrid **numerical/symbolical search**
 - Confirms optimality of (some) known schemes
 - New **2-photon scheme** with $\mathcal{P}_{\text{succ}} = \frac{5}{8}$
- Explored several ancillæ $\rightarrow \frac{3}{4}$ stays the best (for small networks)

Open questions

We have [automated second quantization simulator](#), up to 10 modes and 8 photons.

Open questions

We have **automated second quantization simulator**, up to 10 modes and 8 photons.

- Include noise. But how to generalize “unambiguous”?
- Adapt for **state generation** problem

Thank you