



**HAL**  
open science

## New detection criteria and shunting monitoring in railway track circuit receivers

Xavier Lorang, Sofiane Kerbal, Laurent Lemarchand, Vincent Le Cam,  
Jean-Jacques Mogoro

### ► To cite this version:

Xavier Lorang, Sofiane Kerbal, Laurent Lemarchand, Vincent Le Cam, Jean-Jacques Mogoro. New detection criteria and shunting monitoring in railway track circuit receivers. IWSHM-RS 2018, 2nd International Workshop on Structural Health Monitoring for Railway Systems, Oct 2018, Qingdao, China. 10 p. hal-01898678

**HAL Id: hal-01898678**

**<https://inria.hal.science/hal-01898678>**

Submitted on 18 Oct 2018

**HAL** is a multi-disciplinary open access archive for the deposit and dissemination of scientific research documents, whether they are published or not. The documents may come from teaching and research institutions in France or abroad, or from public or private research centers.

L'archive ouverte pluridisciplinaire **HAL**, est destinée au dépôt et à la diffusion de documents scientifiques de niveau recherche, publiés ou non, émanant des établissements d'enseignement et de recherche français ou étrangers, des laboratoires publics ou privés.

## **New detection criteria and shunting monitoring in railway track circuit receivers**

### **Authors:**

Xavier LORANG,  
Sofiane KERBAL,  
Laurent LEMARCHAND,  
Vincent LE-CAM,  
Jean-Jacques MOGORO

## **ABSTRACT**

Track circuits play a major role in railway signaling. In some exceptional conditions, poor rail/wheel contact conditions may lead to a non-detection of the train on the zone. A presentation of the principle of detection by track circuits is proposed to introduce the existing detection criterion. The aim of the paper is first to present new detection approaches based on signal processing on an experiment with a dedicated train running on a track equipped with a track circuit. The second objective is to present a strategy to test new detection criteria on commercial zones over a long period of time (a few months) with the help of the PEGASE acquisition board. PEGASE has been developed by IFSTTAR and the presented work is the result of SNCF/IFSTTAR collaboration.

## **INTRODUCTION - PROJECT CONTEXT**

### **Actors:**

IFSTTAR is the French National Institute of Science and Technology for Transport, Developments and Networks which dedicates a significant part of its research and developments to railways applications. Those national, European or international research projects and expertise cover various fields from Civil Engineering studies or Structural Monitoring combining instrumentation to structural modeling.

SNCF is the national company of the French rail network since January 1938. Its main activities are the carriage of passengers, the transport of freight, the exploitation of the rail network and the management of railway infrastructures. Every year in France, 149,500 collaborators contribute to transport 2 billion passengers on 30,000 km. Some of these employees are related to the management of engineering to continue to deploy the network and develop innovative solutions.

---

Xavier Lorang, SNCF, Innovative & Research Department, 40 avenue des terroirs de France, 75611 Paris Cedex 12, France

Sofiane Kerbal, ITG for SNCF, Innovative & Research Department, 40 avenue des terroirs de France, 75611 Paris Cedex 12, France

Vincent Le-cam, Laurent Lemarchand, IFSTTAR Nantes, SII Laboratory Department  
CoSys, Inria I4S team, Allée des Ponts et Chaussées, Route de Bouaye - CS4 44344  
Bouguenais FRANCE

Jean-Jacques Mogoro, SNCF Réseau, Signaling Department, 6, avenue François Mitterrand  
93574 La plaine Saint Denis Cedex

**Project:**

Shunting malfunction which is a consequence of a poor wheel/rail contact is rare. SNCF is working on taking into account this phenomenon for existing installations. New detection criteria are considered into track circuits receivers. The work presented here is the result of a collaboration between SNCF and IFSTTAR. IFSTTAR has developed the PEGASE acquisition board to help SNCF perform shunting monitoring on a commercial context for the test of these new criteria.

**1 – Principle of detection by track circuits****a) Principles : the Automatic Block Signaling**

In order to prevent the collision between trains, each line of the French railway network is divided into sections, in which the presence of one train at most is allowed. The system used to control the traffic on the railway lines is called Automatic Block Signaling (ABS). Whenever a train enters a “block”, the ABS detects it and conveys the information that the block is occupied to the approaching trains (Figure 1).

The train detection in a block is performed by an electrical device called track circuit.

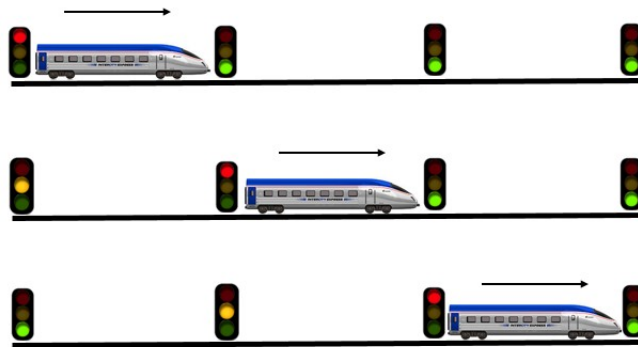

*Figure 1: Automatic block signaling in the French railway network*

Track circuits play a crucial role in railway signaling because they allow permanent and automatic detection of the trains anywhere on the railway network. Their lengths vary from 800 m to 2,500 m.

A track circuit consists of 3 main elements:

- An emitter, connected to one end of the track circuit. It supplies a current whose properties vary depending on the type of track circuit;

- A transmission line consisting of the rails used as electrical conductors;

- A receiver, connected to the other end of the track circuit. It ensures the filtering, the amplification and the shaping of the signal received through the rails to power a relay.

When no train is present, the emitter sends an electrical message to the receiver through the rails, as shown in Fig. 2a. When a train enters the track circuit, its wheels and axles short-circuit the rails: the electrical message is no longer transmitted to the receiver, as shown in Fig. 2b. The short circuit provoked by the axle of the train is called shunt.

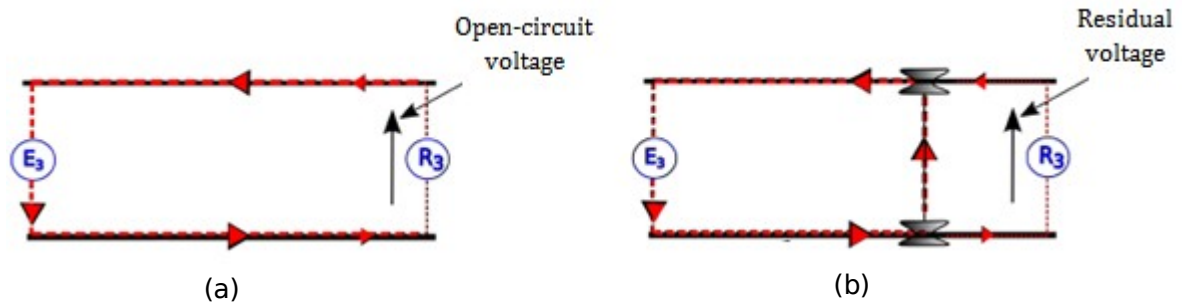

Figure 2: Shunting of the track circuit by the axle of the train

In case a train is present in the block or a rail is broken, the receiver detects the absence of electrical message and the light turns red.

### Track circuit insulation

In order to detect trains in well-defined sections, track circuits must be insulated from one another. Depending on the type of track, the insulation can be either physical or electrical. In the case of physical separation, the rails are cut and maintained in position using screwed joint bars. The block separation is performed using insulated joints. However, these are liable to mechanical failure and maintenance and noise.

### Electrical insulation

Most modern railways use Continuous Welded Rails (CWR). In this type of track, the rails are welded together to form one continuous rail that can be several kilometers long. CWRs provide smoother rides, less noise and require less maintenance.

In France, a common track circuit used in this jointless configuration is the UM71, in which the emitter sends a frequency modulated signal to the receiver. To form distinct sections in this case, UM71s are electrically insulated from one another.

To prevent the signal from one block passing into the adjacent block, LC filters tuned to the carrier frequency are placed at the section boundaries (blue rectangles in Fig 3). On the same track, the UM71 track circuits use two carrier frequencies  $F_A$  and  $F_B$  for the emitted signals (the frequencies are near 2 kHz).

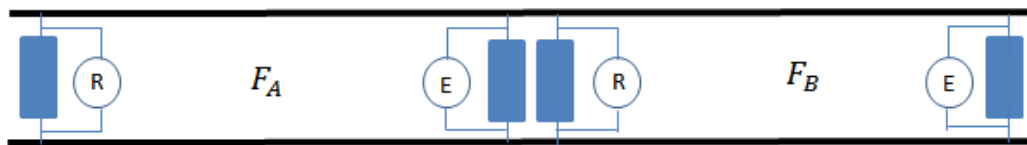

Figure 3: UM71 track circuits and the spatial arrangement of the different carrier frequencies

### b) Frequency modulation in UM71 track circuits

UM71 track circuits use a common digital Frequency Modulation technique called Frequency-Shift Keying (FSK) modulation [3,4].

The principle of FSK modulation is to transmit digital information (modulating signal) through discrete frequency changes of a carrier signal (modulated signal). In the UM71, the transmitted information is binary: the frequency of the carrier wave is varied between two frequencies  $f_1$  and  $f_2$ . The switching between  $f_1$  and  $f_2$  is performed by a switched oscillator, whose output is connected to a clock that changes states every 64 periods, thus creating the modulating square signal. Theoretically, the phase of the carrier wave should be continuous: this attribute is desirable because discontinuities in a signal introduce wideband frequency components. However, discontinuities are hard to avoid in practice.

Figure 4 details how an FSK modulated signal is generated. For display purposes, the signal plotted in the figure contains different frequencies than in an actual UM71. In the example depicted in Figure 4, we have:

$$\begin{cases} f_c = f_1 & \text{if } s_m(t) = 1 \\ f_c = f_2 & \text{if } s_m(t) = 0 \end{cases}$$

Where  $f_c$  indicates the carrier frequency and  $s_m(t)$  the modulating (message) signal. If we note  $s_1(t)$  (resp.  $s_2(t)$ ) the sine wave with frequency  $f_1$  (resp.  $f_2$ ), the FSK signal can be written as:

$$s_{FSK}(t) = s_m(t)s_1(t) + (1 - s_m(t))s_2(t)$$

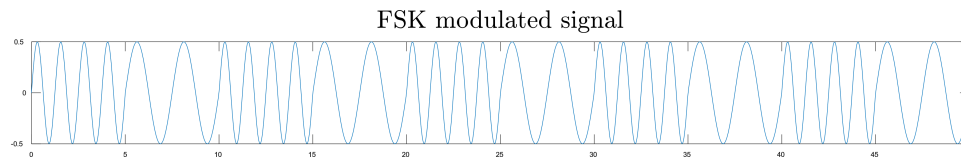

Figure 4: FSK modulated signal

Figure 5 displays the spectrum of a signal measured in a UM71 in which the transmitter's carrier frequency varies around 2 000 Hz.

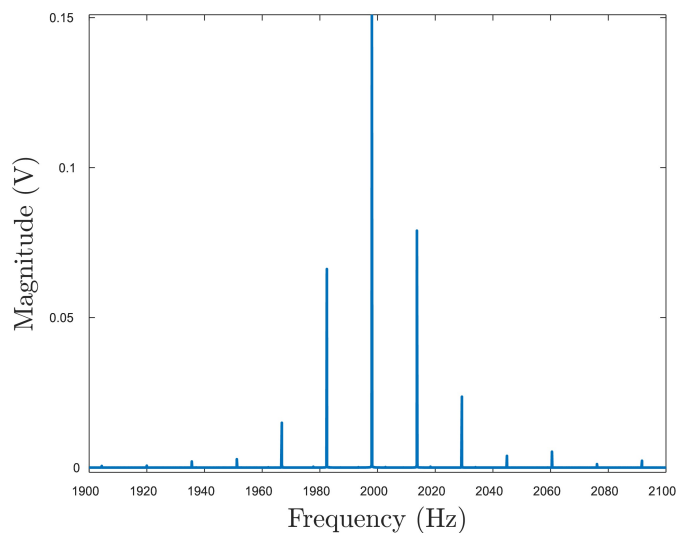

Figure 5: Spectrum of a signal transmitted in a UM71 track circuit

### c) Track circuit Receiver

The existing detection system, based on the signal drop when a train enters a track circuit, may prove defective in exceptional circumstances.

Before activating the relay, the electrical signal is processed in the receiver.

An amplifier in the receiver is used to adjust the voltage of the track depending on the configuration of the track circuit (e.g. its length). This allows having the same order of magnitude for the voltage irrespective of the track circuit throughout the network.

A band-pass filter, whose bandwidth is centered on the carrier frequency of the track circuit emitter, ensures that the spurious frequencies are filtered out. The RMS voltage is then computed and analyzed in the thresholding circuit shown in Figure 6.

As depicted in Figure 6, an RMS voltage level:

- Less than 160 mV causes the activation of the track relay;
- Greater than 220 mV causes the deactivation of the track relay.

Figure 7 displays the RMS voltage of a signal across a UM71. By convention, an RMS level above 60 mV indicates a high level of residual voltage caused by a poor shunting of the track circuit. The lower (resp. upper) limit of the threshold circuit are marked by the orange (resp. yellow) dashed line. The train is:

- detected if the RMS voltage drops below the yellow (red) dashed line (160 mV);
- not detected if the RMS voltage crosses the purple (yellow) dashed line (220 mV).

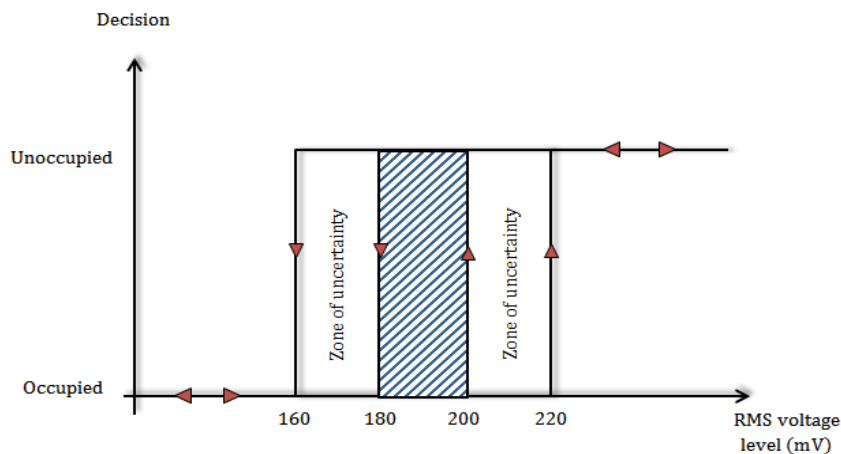

Figure 6: Thresholding circuit and hysteresis in the UM71 receiver

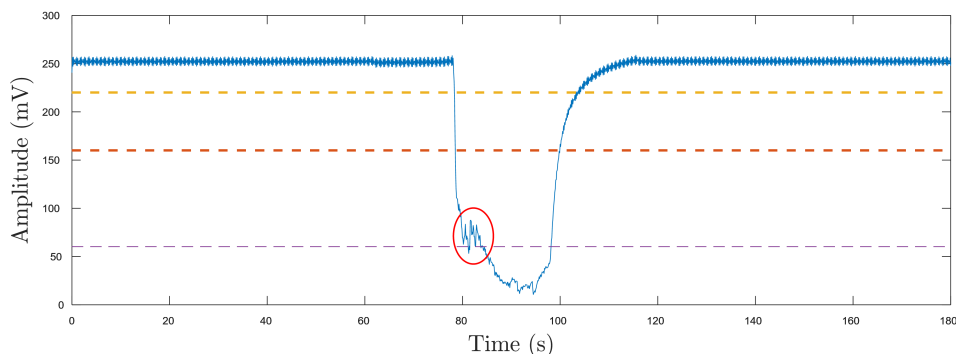



Figure 7: RMS level of a received track signal

## 2 - Test of new criteria in severe wheel/rail conditions

### a) Presentation of the experimentation

The goal of the experimentation is to artificially create the conditions of poor wheel/rail contact and try to detect a train rolling on the track equipped with a track circuit with the help of a new criterion. The chosen track is not commercial and is a test zone where trains rarely travel. The track has a high level of oxidation. In addition, leaves are intentionally crushed on a zone. The evolution of residual voltage as a function of time is plotted in Figure 8a during the pass-by of the dedicated train on the zone.

The observation of the evolution of the residual voltage shows that from 150 to 300 s, the RMS voltage increases from 50 to 380 mV, crossing the threshold of 220 mV. The train is lost here due to presence of leaves and oxidation.

The idea here is to find new criteria based on signal processing that can help to detect a train on the zone.

### b) Proposition of a new criterion : power in a spectral band centered on the 3<sup>rd</sup> Order Harmonic (3OH)

The principle of this approach is to follow the evolution of the 3OH in a signal over time. The motivation is based on the observation that in the case of a poor rail/wheel contact, the voltage in parallel of the wheelset appears to be a deformed sinus signal.

#### Construction of the criterion

The method consists in estimating the power  $P$  of a received signal in a spectral band centered on the 3OH using a sliding window.

The same processing is done with a signal of reference, which is chosen to be a segment of signal when the track is unoccupied, to get the power  $P_{ref}$ . Because there is noise in the signal, the mean of  $P_{ref}$ ,  $M_{ref}$  is considered. The criterion  $C_1$  is defined as follows:

$$C_1 = 10 \log_{10} \left( \frac{P}{M_{ref}} \right)$$

#### Detection threshold

Finally, a threshold is computed from the reference  $P_{ref}$ . In order to include the noise in the signal when the track is unoccupied,  $4\sigma$  has been chosen for the threshold, where  $\sigma$  is the standard deviation of  $P_{ref}$ .

#### Results on a signal measured in severe shunting conditions

Figure 8b shows the evolution of the criterion  $C_1$  as a function of time. This criterion leads to a detection of the train in the oxidation zone (around 250 s), where the existing criterion (based on a thresholding of the residual voltage) is found to be ineffective.

The detection of the train in the leaves zone still remains difficult.

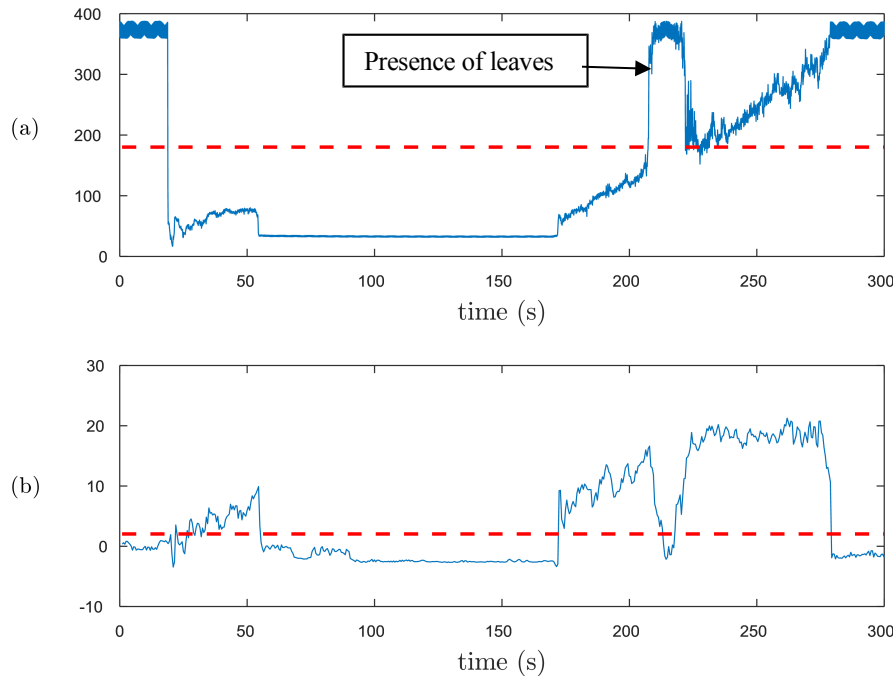

Figure 8: (a) Residual voltage (in  $mV$ ). The red dashed line represents the threshold of the existing criterion – (b) Criterion of average power in a spectral band centered on the 30H (in  $dB$ ). The detection threshold is represented by the red dashed line.

### 3 – Perspectives for the test of new criteria on commercial lines with PEGASE platform

In the previous section, the test of new detection criteria has been conducted on experimental data from a specific acquisition system which cannot allow to get data on a commercial context for a very long period of time.

The strategy is to deploy a PEGASE platform [1,2] system on some commercial sites and to collect actual data for several months.

#### Focus on IFSTTAR "PEGASE 2 platform": Generic Wireless mother board

PEGASE 2 platform is a mature product developed by IFSTTAR and sold via third-party companies. PEGASE is the commercial name of a **Generic Wireless Sensor Platform** conceived and designed by IFSTTAR since 2008. The PEGASE concept is essentially based on a generic vision of its hardware and software abilities. Hardware genericity is provided by a principle of mother and pluggable daughter boards. The PEGASE mother board -described below- integrates most common functions of typical wireless systems: ensure computation, manage energy, offer multiple I/Os and wireless communications. Each pluggable daughter board adds a specific function to the mother board (figure 9), such as 8-analog/digital channels (figure 10), 3/4G GSM extension, or inertial measurements. Software genericity is embedded through a small Linux Operating System added to an open Single Development Kit (SDK) given in open-source in object-oriented languages.

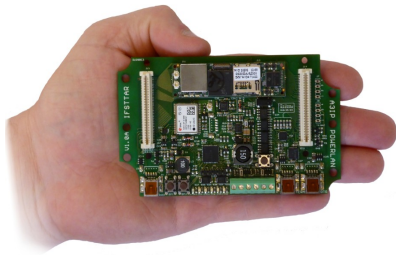

Figure 9: Generic wireless sensor platform PEGASE 2

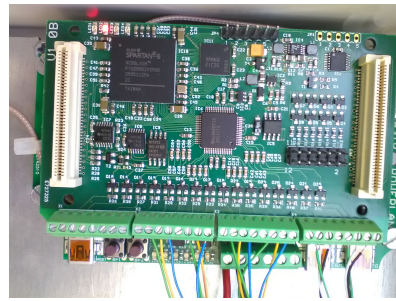

Figure 10: channel analog daughter board to collect "real" data

PEGASE 2 is not only a more efficient electronic device, but the concept also includes generic *cloud* supervision software that allows operating various sensors.

In the context of investigation of new criteria, PEGASE 2 will be connected to the track circuit receiver to acquire:

- the voltage time signal at the receiver terminals sampled at 32 kHz
- the status of the track relay

A set of criteria will be computed in the platform and the results will be sent to the cloud supervision software. The database will help to propose new criteria and to update it remotely in PEGASE platforms.

## Conclusions

A new detection criterion has been proposed and evaluated on a dedicated test. This test has shown that progress can be made in the detection of trains in case of poor quality of the wheel/rail contact. The PEGASE platform and the way it will be used for a test of new criteria in commercial conditions for a long period have been presented.

## REFERENCES

- [1] V. Le Cam, L. Lemarchand, W. Martin, N. Bonnac. Improving wireless sensor behavior by means of generic strategies. *EWSHM*, Sorrento, Italy, 2010.
- [2] V. Le Cam, M. Döhler, M. Le Pen, L. Mevel. Embedded modal analysis algorithms on the smart wireless sensor platform PEGASE. *IWSHM*, Stanford, CA, USA, 2013.
- [3] SNCF (IG.SF): Récepteur numérique pour Circuit de Voie UM 71 C TVM. CT n°554 (EF 5 B 32/314), édition du 14/06/2011.
- [4] Jean-Pierre POITEVIN: Licence Professionnelle en Etudes de Signalisation Ferroviaire. Module Circuit de Voie, Circuit de Retour du Courant de Traction et Compatibilité électromagnétique. Le Circuit de voie UM 71. Edition du 08/12/2014.
- [5] Alexandra DEBIOLLES: Diagnostic de systèmes complexes à base de modèle interne, reconnaissance des formes et fusion d'informations. Application au diagnostic des Circuits de Voie ferroviaires. Thèse présentée pour l'obtention du grade de docteur, Université de Technologie de Compiègne, 2007.