



**HAL**  
open science

# A Globally Convergent Adaptive Indirect Field-Oriented Torque Controller for Induction Motors

Romeo Ortega, Anton Pyrkin, Alexey Bobtsov, Denis Efimov, Stanislav Aranovskiy

► **To cite this version:**

Romeo Ortega, Anton Pyrkin, Alexey Bobtsov, Denis Efimov, Stanislav Aranovskiy. A Globally Convergent Adaptive Indirect Field-Oriented Torque Controller for Induction Motors. *Asian Journal of Control*, 2020, 22 (1), pp.11-24. 10.1002/asjc.1904 . hal-01807720

**HAL Id: hal-01807720**

**<https://inria.hal.science/hal-01807720v1>**

Submitted on 18 Jun 2018

**HAL** is a multi-disciplinary open access archive for the deposit and dissemination of scientific research documents, whether they are published or not. The documents may come from teaching and research institutions in France or abroad, or from public or private research centers.

L'archive ouverte pluridisciplinaire **HAL**, est destinée au dépôt et à la diffusion de documents scientifiques de niveau recherche, publiés ou non, émanant des établissements d'enseignement et de recherche français ou étrangers, des laboratoires publics ou privés.

# A GLOBALLY CONVERGENT ADAPTIVE INDIRECT FIELD-ORIENTED TORQUE CONTROLLER FOR INDUCTION MOTORS<sup>†</sup>

June 18, 2018

Romeo Ortega, Anton Pyrkin, Alexey Bobtsov, Denis Efimov, Stanislav Aranovskiy<sup>1 2</sup>

## Abstract

One of the most challenging problems in AC drives applications is the design of a simple plug-in adaptation scheme to estimate the unknown rotor resistance and load torque for the industry-standard indirect field oriented control. In this paper we give the first globally convergent solution to this problem for *torque* control of current-fed induction motors that does not rely on any excitation assumption. Some results on *speed* regulation are also presented.

---

<sup>1</sup> Romeo Ortega is with Laboratoire des Signaux et Systèmes, CNRS-SUPELEC, Plateau du Moulon, 91192, Gif-sur-Yvette, France.

Anton Pyrkin is with School of Automation, Hangzhou Dianzi University, Xiasha Higher Education Zone, Hangzhou, Zhejiang, P.R. China and also with Department of Computer Science and Control Systems, ITMO University, Kronverkskiy av. 49, Saint Petersburg, 197101, Russia.

Alexey Bobtsov is with Department of Computer Science and Control Systems, ITMO University, Kronverkskiy av. 49, Saint Petersburg, 197101, Russia.

Denis Efimov is with Inria, Non-A team, Parc Scientifique de la Haute Borne, 40 avenue Halley, Bât.A Park Plaza, F-59650 Villeneuve d'Ascq, France.

Stanislav Aranovskiy is with CentraleSupélec – IETR, Avenue de la Boulaie, 35576 Cesson-Sévigné, France and also with Department of Computer Science and Control Systems, ITMO University, Kronverkskiy av. 49, Saint Petersburg, 197101, Russia.

<sup>2</sup>This article is supported by Government of Russian Federation (GOSZADANIE 2.8878.2017/8.9, grant 08-08), the Russian Foundation for Basic Research (grant 17-58-53129), and the Ministry of Education and Science of Russian Federation (project 14.Z50.31.0031).

**Key words: Induction motors, field-oriented control, adaptive control, torque control, speed control.**

## 1 Introduction

The industry standard in induction motor (IM) control is the so-called indirect field-oriented control (IFOC), which provides asymptotic regulation of the generated torque (or the rotor speed) and flux modulus around constant references and does not require rotor flux sensors (or estimators) [8, 9, 12, 14]. The popularity of IFOC stems from its extreme simplicity and intuitive operation that permits independent tuning of the flux and torque control loops. IFOC relies on the assumption that the stator currents are available as control inputs—an assumption that is often justified in practice by the use of high-gain current control loops. A drawback of the standard IFOC scheme is that it requires accurate *knowledge of the rotor resistance*, which may vary significantly with temperature, frequency and current amplitude. Even though it has been shown in [6] that stability is preserved for very large errors in rotor resistance estimation, this mismatch seriously affects the performance: it degrades the flux regulation, which may lead to saturation or under-excitation, slows down the torque response and induces a steady-state error. It is fair to say that, from the practitioners' viewpoint, the development of a *plug-in* scheme to incorporate adaptation to IFOC is one of the most relevant open problems in IM control. For further detail on IFOC the reader is referred to the books [5, 9, 11, 13].

A globally stable adaptive IFOC for the current-fed IM, with the only assumption of the rotor resistance belonging to a discrete known (but arbitrarily large) set, was reported in [3]. Unfortunately, as shown in [4], the proposed scheme is extremely complex and difficult to tune hampering its application in most practical scenarios. In [2] a globally convergent adaptive IFOC with unknown rotor resistance and load torque, but assuming *measurement of the motor torque*, was reported. A theoretically interesting globally stable output feedback adaptive design was reported in [10]. However, there are several drawbacks to the proposed controller. First, it is much more complicated than the basic IFOC and is difficult to implement and tune. Second, the stability analysis relies on a critical persistency of excitation requirement [15] that may be hard to verify in applications. Finally, the scheme is based on feedback linearization that is in open contradiction with the physical operation of the system and, as it is based on exact cancellation of nonlinearities, is a highly non-robust operation. In [13, 14] some analytical and experimental evidence of these facts are reported. See also [16] for some new results on

persistence of excitation-based parameter estimation of IM.

In this paper a plug-in adaptive IFOC for regulation of *torque* of IM that estimates the rotor resistance is proposed. Global regulation of the torque and the flux amplitude is guaranteed measuring only the rotor speed and assuming that *load torque is known*. The proposed estimator is extremely simple, *does not* require any persistence of excitation assumption and achieves asymptotic convergence even in the case of zero rotor speed and/or low torque. To remove the practically unreasonable assumption of known load torque, we then add a load torque estimator and establish global boundedness and convergence to a residual set of the torque regulation error. Finally, it is also shown that a slight modification to the estimator can be used for *speed* regulation with a PI controller. This leads to error equations that exactly coincide with the globally convergent dynamics of torque regulation when the output of the PI converges to a constant. This suggests that the system is amenable to a singular perturbation-like stability analysis—that is, unfortunately, still conspicuous by its absence.

The remainder of the paper is organized as follows. In Section 2 we present the model of the current-fed IM and in Section 3 we recall the torque regulation IFOC. Section 4 formulates the adaptive IFOC problem while Section 5 contains the new plug-in rotor resistance estimator for the adaptive implementation of the torque regulation IFOC with known load torque. In Section 6 we add a load torque estimator to remove the assumption of known load torque. In Section 7 the speed regulation IFOC is briefly presented and some preliminary results of its adaptive implementation are given. Simulation results that illustrate the transient performance and robustness of the torque and speed adaptive IFOCs are presented in Section 8. Our work is wrapped-up with concluding remarks and future work in Section 9.

## 2 Model of the Current-Fed Induction Motor

The induction motor in the fixed stator frame is described by the state equations [8, 9, 12]

$$\begin{aligned}
 \dot{i}_a &= \frac{L_{sr}R_r}{L_s\sigma L_r^2}\lambda_a + \frac{n_P L_{sr}}{L_s\sigma L_r}\omega\lambda_b - \gamma_0 i_a + \frac{1}{L_s\sigma}v_a \\
 \dot{i}_b &= \frac{L_{sr}R_r}{L_s\sigma L_r^2}\lambda_b - \frac{n_P L_{sr}}{L_s\sigma L_r}\omega\lambda_a - \gamma_0 i_b + \frac{1}{L_s\sigma}v_b \\
 \dot{\lambda}_a &= -\frac{R_r}{L_r}\lambda_a - n_P\omega\lambda_b + \frac{R_r L_{sr}}{L_r}i_a \\
 \dot{\lambda}_b &= -\frac{R_r}{L_r}\lambda_b + n_P\omega\lambda_a + \frac{R_r L_{sr}}{L_r}i_b \\
 \dot{\omega} &= \frac{1}{D}(\tau - \tau_L) \\
 \tau &= \frac{n_P L_{sr}}{L_r}(\lambda_a i_b - \lambda_b i_a)
 \end{aligned} \tag{1}$$

where  $\lambda_{ab} = [\lambda_a, \lambda_b]^\top$  is the rotor flux vector,  $i_{ab} = [i_a, i_b]^\top$  is the stator current vector, and  $v_{ab} = [v_a, v_b]^\top$  is the vector of stator voltages.  $R_s, R_r$  [ $\Omega$ ] are stator and rotor resistances,  $L_s, L_r$  [ $H$ ] are the inductances of the stator and rotor windings and  $L_{sr}$  [ $H$ ] is the mutual inductance.  $\sigma = 1 - \frac{L_{sr}^2}{L_s L_r} > 0$  is the total leakage factor of the motor,  $\gamma_0 = \frac{R_s}{L_s\sigma} + \frac{L_{sr}^2}{L_s\sigma L_r T_r}$ ,  $D$  [ $\text{kgm}^2$ ] is the rotor inertia,  $\omega$  [ $\text{rad/s}$ ] the rotor speed and  $n_P$  is the number of pole pairs.

In many practical applications high-gain current loops (sometimes with PI actions) of the form

$$v = \frac{1}{\epsilon}(i_{ab}^* - i_{ab})$$

are used to force  $i_{ab}$  to track their corresponding references  $i_{ab}^*$ , where  $\epsilon$  is a small positive number. It is reasonable then to consider the singularly perturbed reduced model obtained by setting  $\epsilon \rightarrow 0$ , that is

$$\begin{aligned}
 \dot{\lambda}_{ab} &= -\frac{R_r}{L_r}\lambda_{ab} + n_P\omega\mathcal{J}\lambda_{ab} + \frac{R_r L_{sr}}{L_r}i_{ab} \\
 D\dot{\omega} &= \tau - \tau_L \\
 \tau &= \frac{n_P L_{sr}}{L_r}i_{ab}^\top \mathcal{J}\lambda_{ab}
 \end{aligned}$$

with the skew-symmetric matrix  $\mathcal{J} := \begin{bmatrix} 0 & -1 \\ 1 & 0 \end{bmatrix}$ . The underlying assumption of this model is that the stator currents are exactly equal to their references, *i.e.*,  $i_{ab}(t) \equiv i_{ab}^*(t)$ . To further simplify the equations, we introduce

the (globally defined) change of coordinates

$$\begin{aligned} u &= L_{sr} \begin{bmatrix} \cos(n_P\theta) & \sin(n_P\theta) \\ -\sin(n_P\theta) & \cos(n_P\theta) \end{bmatrix} i_{ab}, \\ \lambda &= \begin{bmatrix} \cos(n_P\theta) & \sin(n_P\theta) \\ -\sin(n_P\theta) & \cos(n_P\theta) \end{bmatrix} \lambda_{ab}, \end{aligned}$$

with  $\dot{\theta} = \omega$ . Hence,  $u$  and  $\lambda$  are quantities expressed in a frame rotating with the (electrical) speed of the rotor. In the new state coordinates, and with the *new control inputs*  $u$ , we have the following *bilinear* model

$$\frac{L}{R} \dot{\lambda} = -\lambda + u, \quad (2)$$

$$D\dot{\omega} = \tau - \tau_L \quad (3)$$

$$\tau = \frac{n_P}{L} u^\top J \lambda, \quad (4)$$

where, to simplify the notation, we have defined  $R := R_r, L := L_r$ .

Throughout the paper, we will assume that the behaviour of the (so-called) current-fed induction motor is captured by the dynamical model (2)-(4). As discussed in [7, 13] this apparently innocuous system can exhibit an amazingly complex behaviour and poses a significant challenge for control system design.

### 3 Indirect Field Oriented Torque Control

The classical IFOC for *torque regulation* is given as

$$\begin{aligned} u &= e^{J\rho_d} \begin{bmatrix} \beta_d \\ \frac{L}{n_P} \frac{\tau_d}{\beta_d} \end{bmatrix} \\ \dot{\rho}_d &= \frac{R}{n_P} \frac{\tau_d}{\beta_d^2}, \end{aligned} \quad (5)$$

where  $\beta_d > 0$  and  $\tau_d > 0$  are references for the flux and the torque amplitude, respectively.

The remarkable stability properties of the torque regulation IFOC, which does not require any measurement of the systems state, are summarized in the proposition below. See [6] for its robustness analysis.

**Proposition 1.** Consider the IM model (2)-(4) in closed-loop with the torque regulation IFOC (5). For all initial conditions  $(\lambda(0), \omega(0), \rho_d(0)) \in \mathbb{R}^4$  we have

$$\lim_{t \rightarrow \infty} \tau(t) = \tau_d, \quad \lim_{t \rightarrow \infty} |\lambda(t)| = \beta_d, \quad (6)$$

where  $|\cdot|$  is the Euclidean norm.

*Proof.* First, notice that

$$e^{J\rho_d} = \begin{bmatrix} \cos \rho_d & -\sin \rho_d \\ \sin \rho_d & \cos \rho_d \end{bmatrix},$$

and define the desired flux vector as

$$\lambda_d := e^{J\rho_d} \begin{bmatrix} \beta_d \\ 0 \end{bmatrix}.$$

Notice that  $|\lambda_d| = \beta_d$  and  $\lambda_d$  satisfies

$$\frac{L}{R} \dot{\lambda}_d = \alpha J \lambda_d, \quad \lambda_d(0) = \begin{bmatrix} \beta_d \\ 0 \end{bmatrix}, \quad (7)$$

where, to simplify the notation, we defined the key positive constant

$$\alpha := \frac{L}{n_P} \frac{\tau_d}{\beta_d^2}. \quad (8)$$

The IFOC (5) can then be written as

$$u = (I + \alpha J) \lambda_d. \quad (9)$$

Defining the flux error  $e_\lambda := \lambda - \lambda_d$  and replacing (7) and (9) in (2) we get

$$\dot{e}_\lambda = -\frac{R}{L} e_\lambda,$$

which implies  $\lim_{t \rightarrow \infty} e_\lambda(t) = 0$  and, consequently,  $\lim_{t \rightarrow \infty} |\lambda(t)| = \beta_d$ .

Now, using (9), the torque equation (4) becomes

$$\begin{aligned} \tau &= \frac{n_P}{L} u^\top J (\lambda_d + e_\lambda) \\ &= \frac{n_P}{L} \lambda_d^\top (I - \alpha J) J \lambda_d + \epsilon_t \\ &= \frac{n_P}{L} \alpha |\lambda_d|^2 + \epsilon_t \\ &= \tau_d + \epsilon_t, \end{aligned} \quad (10)$$

where  $\epsilon_t := \frac{n_P}{L} u^\top J e_\lambda$  is an exponentially decaying term and we have used the facts that  $J^\top = -J$  and  $J^2 = -I$ . This concludes the proof.  $\square\square\square$

It is clear from the rotor dynamics (3) that, since  $\tau(t) \rightarrow \tau_d$ , the torque reference should be chosen equal to  $\tau_L$  to ensure speed remains bounded.<sup>3</sup>

## 4 Formulation of the Adaptive IFOC Torque Regulation Problem

Consider the IM model (2)-(4) verifying the following assumptions.

**Assumption 1.** Rotor speed  $\omega$  is measurable, the parameters  $L$  and  $D$  are *known* and the references are such that the constant defined in (8) verifies

$$\alpha < 1. \quad (11)$$

**Assumption 2.** The rotor resistance  $R$  is *unknown*, but two constants  $R_M$  and  $R_m$  that verify

$$\frac{R}{\alpha^2} > R_M \geq R \geq R_m > 0,$$

are *known*.

Design a *rotor resistance estimator*

$$\begin{aligned} \dot{\chi} &= F(\chi, u, \omega, \tau_L) \\ \hat{R} &= H(\chi, u, \omega, \tau_L), \end{aligned} \quad (12)$$

where  $\chi \in \mathbb{R}^q$  is the estimator state such that the IM model (2)-(4) in closed-loop with the *adaptive torque regulation IFOC*

$$\begin{aligned} u &= e^{J\hat{\rho}_d} \begin{bmatrix} \beta_d \\ \frac{L}{n_P} \frac{\tau_d}{\beta_d} \end{bmatrix} \\ \dot{\hat{\rho}}_d &= \frac{\hat{R}}{n_P} \frac{\tau_d}{\beta_d^2}, \end{aligned} \quad (13)$$

ensures (6) for all  $(\lambda(0), \omega(0), \hat{\rho}_d(0), \chi(0)) \in \mathbb{R}^{4+q}$ .

Although Assumption 2 is quite reasonable in applications, Assumption 1 looks quite technical and deserves some clarification. In Subsection 1.4 of the comprehensive book [11] it is first shown that the field-oriented version of the IM model (1), with outputs  $\omega$  and the  $d$ -component of the flux, is exactly *left invertible*. Then, in Subsection 2.1, the authors prove that, for constant

---

<sup>3</sup>This is, actually, only a theoretical requirement, since in all practical applications, the presence of viscous friction ensures speed is bounded even if  $\tau_d \neq \tau_L$ .



desired outputs, the inverse dynamics controller destabilizes the system for large load torques. Finally, in Subsection 5.1, they prove, that when applied to the current-fed model (2)-(4), the reduced order tracking error dynamics has an additional equilibrium—besides the origin—and this equilibrium is *unstable* if  $\alpha > 1$ . In other words, Assumption 1 pertains to the stability of the open-loop, left-inverting control of the IM.<sup>4</sup>

## 5 A Globally Convergent Adaptive Torque Regulation IFOC

In this section we provide a solution to the adaptive torque regulation IFOC problem defined in Section 3 adding the following, admittedly unpractical, assumption.

**Assumption 3.** The load torque  $\tau_L$  is *known*.

**Proposition 2.** Consider the IM model (2)-(4) verifying Assumptions 1-3 in closed-loop with the adaptive torque regulation IFOC (13) with  $\tau_d > 0$  and the rotor resistance estimator

$$L\dot{\hat{\lambda}} = -\hat{R}\hat{\lambda} + \hat{R}u \quad (14)$$

$$\dot{z} = \gamma \left[ \frac{D}{n_P} \hat{R} \omega \hat{\lambda}^\top (J + \alpha I) u + (\hat{\lambda}^\top J u)^2 + \frac{L\tau_L}{n_P} (\hat{\lambda}^\top J u) \right] \quad (15)$$

$$\hat{R} = \begin{cases} R_M & \text{if } S(z, \omega, \hat{\lambda}, u) \geq R_M \\ S(z, \omega, \hat{\lambda}, u) & \text{if } R_M > S(z, \omega, \hat{\lambda}, u) > R_m \\ R_m & \text{if } R_m \geq S(z, \omega, \hat{\lambda}, u), \end{cases} \quad (16)$$

where  $\gamma > 0$  is a tuning gain and we defined the switching function

$$S(z, \omega, \hat{\lambda}, u) := z + \gamma \frac{DL}{n_P} \omega \hat{\lambda}^\top J u. \quad (17)$$

For all  $(\lambda(0), \omega(0), \rho_d(0), \hat{\lambda}(0), z(0)) \in \mathbb{R}^7$ , (6) holds.

*Proof.* Defining the flux observation error  $\tilde{\lambda} := \hat{\lambda} - \lambda$  and using (2) and (14) we get

$$\begin{aligned} L\dot{\tilde{\lambda}} &= -\hat{R}\hat{\lambda} + \hat{R}u + R\lambda - Ru \\ &= -R(\hat{\lambda} - \lambda) - \tilde{R}\hat{\lambda} + \tilde{R}u \\ &= -R\tilde{\lambda} + \tilde{R}(u - \hat{\lambda}), \end{aligned} \quad (18)$$

---

<sup>4</sup>The authors are deeply grateful to the anonymous reviewer that pointed out this very important fact.

where  $\tilde{R} := \hat{R} - R$  is the parameter estimation error. Now, from (16) we get

$$\dot{\tilde{R}} = \begin{cases} 0 & \text{if } S(z, \omega, \hat{\lambda}, u) \geq R_M \\ \dot{S} & \text{if } R_M > S(z, \omega, \hat{\lambda}, u) > R_m \\ 0 & \text{if } R_m \geq S(z, \omega, \hat{\lambda}, u), \end{cases} \quad (19)$$

where  $\dot{S}$  is computed from (17) as

$$\dot{S} = \dot{z} + \gamma \frac{DL}{n_P} \dot{\omega} \hat{\lambda}^\top J u + \gamma \frac{DL}{n_P} \omega \frac{d}{dt} \left( \hat{\lambda}^\top J u \right),$$

with the first right hand term given by (15). The derivative of the speed is defined by (3) and (4) as

$$\dot{\omega} = -\frac{n_P}{DL} \lambda^\top J u - \frac{\tau_L}{D}. \quad (20)$$

The term  $\frac{d}{dt} \left( \hat{\lambda}^\top J u \right)$  is computed as

$$\begin{aligned} \frac{d}{dt} \left( \hat{\lambda}^\top J u \right) &= \dot{\hat{\lambda}}^\top J u + \hat{\lambda}^\top J \dot{u} \\ &= \left( -\frac{1}{L} \hat{R} \hat{\lambda} + \frac{1}{L} \hat{R} u \right)^\top J u \\ &\quad + \hat{\lambda}^\top J \left( e^{J \hat{\rho}_d} J \begin{bmatrix} \beta_d \\ \frac{L \tau_d}{n_P \beta_d} \end{bmatrix} \right) \frac{\hat{R}}{n_P} \frac{\tau_d}{\beta_d^2} \\ &= -\frac{1}{L} \hat{R} \hat{\lambda}^\top J u - \hat{\lambda}^\top u \frac{\hat{R}}{n_P} \frac{\tau_d}{\beta_d^2} \\ &= -\frac{1}{L} \hat{R} \hat{\lambda}^\top (J + \alpha I) u, \end{aligned} \quad (21)$$

where  $\alpha$  is given by (8)

Substituting (15), (20), and (21) into (19)—for the case  $R_M > S(z, \omega, \hat{\lambda}, u) > R_m$ —yields

$$\begin{aligned} \dot{\tilde{R}} &= \gamma \frac{D}{n_P} \hat{R} \omega \hat{\lambda}^\top (J + \alpha I) u + \gamma \left( \hat{\lambda}^\top J u \right)^2 \\ &\quad + \gamma \frac{L \tau_L}{n_P} \left( \hat{\lambda}^\top J u \right) - \gamma \left( \lambda^\top J u + \frac{L \tau_L}{n_P} \right) \hat{\lambda}^\top J u \\ &\quad - \gamma \frac{DL}{n_P} \omega \left( \frac{1}{L} \hat{R} \hat{\lambda}^\top (J + \alpha I) u \right) \\ &= \gamma \left[ \left( \hat{\lambda}^\top J u \right)^2 - \lambda^\top J u \hat{\lambda}^\top J u \right]. \end{aligned} \quad (22)$$

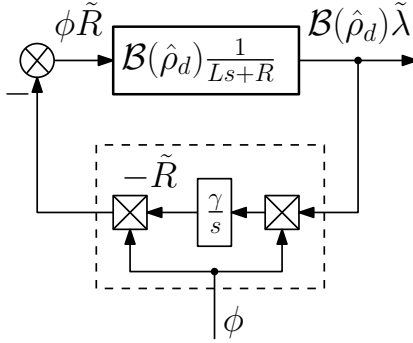

**Figure 1:** Block diagram representation of the estimator error equations (24).

Notice that the parameter  $\gamma$  plays the role of adaptation gain in the proposed estimator.

Defining the two-dimensional vector  $\phi := u - \hat{\lambda}$  it is possible to write (22) as

$$\dot{\tilde{R}} = \gamma \phi^\top J u u^\top J \tilde{\lambda}.$$

Hence, developing  $J u u^\top J$  and defining

$$\mathcal{B}(\hat{\rho}_d) := J u u^\top J = \beta_d^2 e^{J \hat{\rho}_d} \begin{bmatrix} \alpha^2 & -\alpha \\ -\alpha & 1 \end{bmatrix} e^{-J \hat{\rho}_d}, \quad (23)$$

the estimator error equations (18) and (22) can be written in the more familiar form

$$\begin{aligned} L \dot{\tilde{\lambda}} &= -R \tilde{\lambda} + \phi \tilde{R} \\ \dot{\tilde{R}} &= -\gamma \phi^\top \mathcal{B}(\hat{\rho}_d) \tilde{\lambda}. \end{aligned} \quad (24)$$

In Fig. 1 a block diagram representation of (24) is given. It clearly underscores the close connection with the classical model reference adaptive control error system [15, 1]. As is well-known [1] the operator in the feedback loop of Fig. 1 is passive. Unfortunately, the matrix  $\mathcal{B}(\hat{\rho}_d)$ —although positive semidefinite—is *not constant*. Hence, the operator corresponding to the forward part cannot be shown to be passive without further assumptions on  $\hat{\rho}_d$ . This hampers the application of the standard passivity argument to prove the stability of the feedback system.

To overcome the aforementioned obstacle and be able to carry out standard Lyapunov-like analysis it is necessary, as done in [6], to define coordinates on which the steady-state behaviour of the system corresponds to

constant equilibria and not periodic orbits. Towards this end, we define the five-dimensional vector

$$x := \text{col}(\lambda^\top u, \lambda^\top Ju, \hat{\lambda}^\top u, \hat{\lambda}^\top Ju, \hat{R}). \quad (25)$$

Straightforward calculations yield

$$\begin{aligned} L\dot{x}_1 &= -Rx_1 + \alpha x_5 x_2 + R\beta_d^2(1 + \alpha^2) \\ L\dot{x}_2 &= -Rx_2 - \alpha x_5 x_1 \\ L\dot{x}_3 &= -x_5 x_3 + \alpha x_5 x_4 + x_5 \beta_d^2(1 + \alpha^2) \\ L\dot{x}_4 &= -x_5 x_4 - \alpha x_5 x_3 \\ \dot{x}_5 &= \gamma x_4(x_4 - x_2). \end{aligned} \quad (26)$$

We will, first, analyze the equilibria of (26). From (16) and Assumption 2 we have that

$$\frac{R}{\alpha^2} > R_M \geq x_5 \geq R_m > 0. \quad (27)$$

Now, from (26) we have the following equivalences

$$\begin{aligned} \dot{x}_1 = \dot{x}_2 = 0 &\Leftrightarrow \begin{bmatrix} x_1 \\ x_2 \end{bmatrix} = \frac{R\beta_d^2(1 + \alpha^2)}{R^2 + \alpha^2 x_5^2} \begin{bmatrix} R \\ -\alpha x_5 \end{bmatrix} \\ \dot{x}_3 = \dot{x}_4 = 0 &\Leftrightarrow \begin{bmatrix} x_3 \\ x_4 \end{bmatrix} = \beta_d^2 \begin{bmatrix} 1 \\ -\alpha \end{bmatrix}, \end{aligned}$$

where we ruled out the case  $x_5 = 0$  in the second equivalence. Now, since  $x_4 = -\alpha\beta_d^2 \neq 0$ , we have that

$$\begin{aligned} \dot{x}_5 = 0 &\Leftrightarrow x_2 = x_4 \\ &\Leftrightarrow (x_5 - R)(x_5 - \frac{R}{\alpha^2}) = 0, \end{aligned}$$

where the second equivalence is obtained replacing the definitions of  $x_2$  and  $x_4$  above. Invoking (27) we see that the only solution of this equation is  $x_5 = R$ . Consequently, the system (26) has a *unique equilibrium* at

$$\bar{x} := \text{col}(\beta_d^2, -\alpha\beta_d^2, \beta_d^2, -\alpha\beta_d^2, R).$$

To relate the problem of stabilization of this equilibrium with the control objective notice first that  $x_2 = -\frac{L}{n_P}\tau$  and  $\bar{x}_2 = -\frac{L}{n_P}\tau_d$ . On the other hand,

invoking (13), it is possible to establish the following chain of implications

$$\begin{aligned}
\begin{bmatrix} x_1 \\ x_2 \end{bmatrix} = \begin{bmatrix} \bar{x}_1 \\ \bar{x}_2 \end{bmatrix} &\Leftrightarrow \begin{bmatrix} u^\top \\ -u^\top J \end{bmatrix} \lambda = \begin{bmatrix} \bar{x}_1 \\ \bar{x}_2 \end{bmatrix} \Leftrightarrow \\
\Leftrightarrow \lambda &= \frac{1}{|u|^2} \begin{bmatrix} u & Ju \end{bmatrix} \begin{bmatrix} \bar{x}_1 \\ \bar{x}_2 \end{bmatrix} \\
\Leftrightarrow \lambda &= \frac{1}{\beta_d^2(1+\alpha^2)} \begin{bmatrix} u & Ju \end{bmatrix} \begin{bmatrix} \beta_d^2 \\ -\alpha\beta_d^2 \end{bmatrix} \\
\Rightarrow |\lambda| &= \beta_d.
\end{aligned}$$

Consequently, the control objective is achieved if we can prove that  $\lim_{t \rightarrow \infty} (x_1(t), x_2(t)) = (\bar{x}_1, \bar{x}_2)$  with all signals remaining bounded.

To proceed with the stability analysis it is convenient to shift the equilibrium of (26) to zero. For this purpose, we define the errors  $e := x - \bar{x}$  and, after some basic computations, get the error dynamics

$$\begin{aligned}
L\dot{e}_1 &= -Re_1 + \alpha(e_5 + R)e_2 - \alpha^2\beta_d^2e_5 \\
L\dot{e}_2 &= -Re_2 - \alpha(e_5 + R)e_1 - \alpha\beta_d^2e_5 \\
L\dot{e}_3 &= -(e_5 + R)(e_3 - \alpha e_4) \\
L\dot{e}_4 &= -(e_5 + R)(e_4 + \alpha e_3) \\
\dot{e}_5 &= \gamma(e_4 - \alpha\beta_d^2)(e_4 - e_2).
\end{aligned} \tag{28}$$

The first observation is that, under Assumption 2, the origin of the system  $(e_3, e_4)$  is globally exponentially stable. Indeed, the derivative of the function

$$V_1(e_3, e_4) := \frac{L}{2}(e_3^2 + e_4^2),$$

verifies

$$\dot{V}_1 = -(e_5 + R)(e_3^2 + e_4^2) \leq -\frac{2R_m}{L}V_1,$$

where we have used the fact that

$$e_5 + R = \hat{R} \geq R_m.$$

Second, considering the function

$$V_2(e_1, e_2) := \frac{L}{2}(e_1^2 + e_2^2),$$

we get

$$\dot{V}_2 = -R(e_1^2 + e_2^2) - \alpha\beta_d^2e_5(\alpha e_1 + e_2). \tag{29}$$

Since  $e_5 \in \mathcal{L}_\infty$  by construction we conclude from the equation above that  $e_1, e_2 \in \mathcal{L}_\infty$  as well.

Now, define the signals

$$\begin{aligned} w_1 &:= e_1 - \alpha e_2 \\ w_2 &:= e_2 - e_4 \end{aligned} \quad (30)$$

Evaluating their time derivative along the error dynamics (28) yields

$$\begin{aligned} L\dot{w}_1 &:= -(R - \alpha^2 \hat{R})w_1 + \alpha(1 + \alpha^2)\hat{R}(w_2 + e_4) \\ L\dot{w}_2 &:= -(R + \alpha^2 \hat{R})w_2 - \alpha\hat{R}(w_1 + \alpha e_4 - e_3) \\ &\quad + (e_4 - \alpha\beta_d^2)e_5. \end{aligned} \quad (31)$$

Consider the function

$$W(w_1, w_2, e_5) := \frac{1}{2} \left( \frac{L}{1 + \alpha^2} w_1^2 + L w_2^2 + \frac{1}{\gamma} e_5^2 \right),$$

whose derivative verifies

$$\begin{aligned} \dot{W} &= -\frac{R - \alpha^2 \hat{R}}{1 + \alpha^2} w_1^2 - (R + \alpha^2 \hat{R}) w_2^2 \\ &\quad + w_1 \epsilon_1 + w_2 \epsilon_2 \\ &\leq -\frac{R - \alpha^2 \hat{R}}{2(1 + \alpha^2)} w_1^2 - \frac{1}{2} (R + \alpha^2 \hat{R}) w_2^2 \\ &\quad + \frac{1 + \alpha^2}{2(R - \alpha^2 \hat{R})} \epsilon_1^2 + \frac{1}{2(R + \alpha^2 \hat{R})} \epsilon_2^2, \end{aligned} \quad (32)$$

where we defined the exponentially decaying signals

$$\begin{aligned} \epsilon_1 &:= \alpha(e_5 + R)e_4 \\ \epsilon_2 &:= \alpha(e_5 + R)(\alpha e_4 - e_3), \end{aligned}$$

in the first identity and used the well-known bound  $2ab \leq ka^2 + \frac{1}{k}b^2$  for the last inequality. Recalling that it has been established that  $e \in \mathcal{L}_\infty$ ,  $e_3$  and  $e_4$  are exponentially converge to zero, we conclude that there exists a compact invariant set  $\Omega = \{e \in \mathbb{R}^5 : \|e\| \leq C_\Omega, e_3 = e_4 = 0\}$ , on which (32) becomes

$$\dot{W} \leq -\frac{R - \alpha^2 \hat{R}}{2(1 + \alpha^2)} w_1^2 - \frac{1}{2} (R + \alpha^2 \hat{R}) w_2^2 \leq 0,$$

hence invoking LaSalle's invariance principle we conclude that all trajectories converge to the limit set where  $\dot{W} = 0$ , i.e.  $w_1 = 0 = w_2 = 0$ . Consequently,

from (30) follows that on the limit set  $e_1 = e_2 = 0$  and, using (28),  $e_5 = 0$ . Thus,  $\lim_{t \rightarrow \infty} e(t) = 0$ .

To complete the proof let us compute the torque provided by the controller (13) as in Section 3. Define the desired flux vector as

$$\hat{\lambda}_d := e^{J\hat{p}_d} \begin{bmatrix} \beta_d \\ 0 \end{bmatrix}.$$

Notice that  $|\hat{\lambda}_d| = \beta_d$  and  $\hat{\lambda}_d$  satisfies

$$\dot{\hat{\lambda}}_d = \frac{\alpha \hat{R}}{L} J \hat{\lambda}_d, \quad \hat{\lambda}_d(0) = \begin{bmatrix} \beta_d \\ 0 \end{bmatrix}. \quad (33)$$

The control law (13) can then be written as

$$u = (I + \alpha J) \hat{\lambda}_d. \quad (34)$$

Defining the flux error  $e_\lambda := \lambda - \hat{\lambda}_d$  and replacing (33) and (34) in (2) we get

$$\dot{e}_\lambda = -\frac{R}{L} e_\lambda - \frac{\alpha}{L} J \hat{\lambda}_d \tilde{R}.$$

Since  $\tilde{R} = \hat{R} - R = e_5$  converges to zero then  $\lim_{t \rightarrow \infty} e_\lambda(t) = 0$  and  $\lim_{t \rightarrow \infty} |\lambda(t)| = \beta_d$ .

Following (10) and using (34), the torque (4) becomes

$$\tau = \frac{n_P}{L} u^\top J (\hat{\lambda}_d + e_\lambda) = \frac{n_P}{L} \alpha |\hat{\lambda}_d|^2 + \epsilon_t = \tau_d + \epsilon_t,$$

which completes the proof. □□□

## 6 A Globally Stable Adaptive Torque Regulation IFOC with Load Torque Estimator

The main limitation of the adaptive IFOC of Proposition 2 is, of course, the assumption that the load torque  $\tau_L$  is known. In this section we propose a load torque estimator that ensures boundedness of all solutions and convergence of the error signals to a residual ball, whose radius is proportional to the rotor resistance estimation error.

**Proposition 3.** Consider the IM model (2)-(4) verifying Assumptions 1 and 2 in closed-loop with the adaptive torque regulation IFOC (13) with  $\tau_d > 0$  and the rotor resistance and load torque estimator

$$L\dot{\hat{\lambda}} = -\hat{R}\hat{\lambda} + \hat{R}u \quad (35)$$

$$\dot{\hat{z}} = \gamma \left[ \frac{D}{n_P} \hat{R} \omega \hat{\lambda}^\top (J + \alpha I) u + (\hat{\lambda}^\top J u)^2 + \frac{L \hat{\tau}_L}{n_P} (\hat{\lambda}^\top J u) \right] \quad (36)$$

$$\dot{\chi} = -k \hat{\tau}_L - k \frac{n_P}{L} \hat{\lambda}^\top J u \quad (37)$$

$$\hat{R} = \begin{cases} R_M & \text{if } S(\hat{z}, \omega, \hat{\lambda}, u) \geq R_M \\ S(\hat{z}, \omega, \hat{\lambda}, u) & \text{if } R_M > S(\hat{z}, \omega, \hat{\lambda}, u) > R_m \\ R_m & \text{if } R_m \geq S(\hat{z}, \omega, \hat{\lambda}, u), \end{cases} \quad (38)$$

$$\hat{\tau}_L = \chi - k D \omega, \quad (39)$$

where  $\gamma, k > 0$  are tuning gains and

$$S(\hat{z}, \omega, \hat{\lambda}, u) := \hat{z} + \gamma \frac{D L}{n_P} \omega \hat{\lambda}^\top J u. \quad (40)$$

The following properties are true for all initial conditions  $(\lambda(0), \omega(0), \rho_d(0), \hat{\lambda}(0), z(0), \chi(0)) \in \mathbb{R}^8$ .

- (i) All solutions are bounded.
- (ii) Define the  $\mathcal{L}_\infty$  norm of the rotor resistance estimation error  $\delta := \|\hat{R}(t) - R\|_\infty$ . Then,<sup>5</sup>

$$\begin{aligned} \lim_{t \rightarrow \infty} |\tau(t) - \tau_d| &\leq \mathcal{O}(\delta) \\ \lim_{t \rightarrow \infty} ||\lambda(t)| - \beta_d| &\leq \mathcal{O}(\delta). \end{aligned}$$

*Proof.* Similarly to the proof of Proposition 2 consider the model of the observation errors. The flux observation error  $\tilde{\lambda}$  is the same as in (18)

$$L\dot{\tilde{\lambda}} = -R\tilde{\lambda} + \tilde{R}(u - \hat{\lambda}).$$

Now, from (38) we get

$$\dot{\tilde{R}} = \begin{cases} 0 & \text{if } S(\hat{z}, \omega, \hat{\lambda}, u) \geq R_M \\ \dot{S} & \text{if } R_M > S(\hat{z}, \omega, \hat{\lambda}, u) > R_m \\ 0 & \text{if } R_m \geq S(\hat{z}, \omega, \hat{\lambda}, u), \end{cases} \quad (41)$$

<sup>5</sup>Where  $\mathcal{O}(\cdot)$  is the uniform big  $O$  symbol.



where  $\dot{S}$  is computed from (40) as

$$\dot{S} = \dot{\hat{z}} + \gamma \frac{DL}{n_P} \dot{\omega} \hat{\lambda}^\top J u + \gamma \frac{DL}{n_P} \omega \frac{d}{dt} \left( \hat{\lambda}^\top J u \right),$$

with the first right hand term given by (36). Using (20) and (21), from (41)—for the case  $R_M > S(\hat{z}, \omega, \hat{\lambda}, u) > R_m$ —we get

$$\begin{aligned} \dot{\hat{R}} &= \gamma \frac{D}{n_P} \hat{R} \omega \hat{\lambda}^\top (J + \alpha I) u + \gamma \left( \hat{\lambda}^\top J u \right)^2 \\ &\quad + \gamma \frac{L \tilde{\tau}_L}{n_P} \left( \hat{\lambda}^\top J u \right) - \gamma \left( \lambda^\top J u + \frac{L \tau_L}{n_P} \right) \hat{\lambda}^\top J u \\ &\quad - \gamma \frac{DL}{n_P} \omega \left( \frac{1}{L} \hat{R} \hat{\lambda}^\top (J + \alpha I) u \right) \\ &= \gamma \left[ \left( \hat{\lambda}^\top J u \right)^2 - \lambda^\top J u \hat{\lambda}^\top J u \right] + \gamma \frac{L \tilde{\tau}_L}{n_P} \left( \hat{\lambda}^\top J u \right). \end{aligned}$$

where the load torque estimation error  $\tilde{\tau}_L := \hat{\tau}_L - \tau_L$  satisfies

$$\begin{aligned} \dot{\tilde{\tau}}_L &= -k \hat{\tau}_L - k \frac{n_P}{L} \hat{\lambda}^\top J u - k D \dot{\omega} \\ &= -k \hat{\tau}_L + k \frac{n_P}{L} u^\top J \hat{\lambda} - k \frac{n_P}{L} u^\top J \lambda + k \tau_L \\ &= -k \tilde{\tau}_L - k \frac{n_P}{L} \tilde{\lambda}^\top J u. \end{aligned}$$

Define the six-dimensional vector

$$x := \text{col}(\lambda^\top u, \lambda^\top J u, \hat{\lambda}^\top u, \hat{\lambda}^\top J u, \hat{R}, \frac{L \tilde{\tau}_L}{n_P}).$$

Straightforward calculations yield

$$\begin{aligned} L \dot{x}_1 &= -R x_1 + \alpha x_5 x_2 + R \beta_d^2 (1 + \alpha^2) \\ L \dot{x}_2 &= -R x_2 - \alpha x_5 x_1 \\ L \dot{x}_3 &= -x_5 x_3 + \alpha x_5 x_4 + x_5 \beta_d^2 (1 + \alpha^2) \\ L \dot{x}_4 &= -x_5 x_4 - \alpha x_5 x_3 \\ \dot{x}_5 &= \gamma x_4 (x_4 - x_2 + x_6), \\ \dot{x}_6 &= -k (x_4 - x_2 + x_6). \end{aligned} \tag{42}$$

Similarly to the case of known  $\tau_L$ , we conclude that the system (42) has a *unique equilibrium* at

$$\bar{x} := \text{col}(\beta_d^2, -\alpha \beta_d^2, \beta_d^2, -\alpha \beta_d^2, R, 0).$$

To proceed with the stability analysis it is convenient to shift the equilibrium of (42) to zero and consider the model of errors  $e := x - \bar{x}$  and, after some basic computations, get the error dynamics

$$\begin{aligned}
L\dot{e}_1 &= -Re_1 + \alpha(e_5 + R)e_2 - \alpha^2\beta_d^2e_5 \\
L\dot{e}_2 &= -Re_2 - \alpha(e_5 + R)e_1 - \alpha\beta_d^2e_5 \\
L\dot{e}_3 &= -(e_5 + R)(e_3 - \alpha e_4) \\
L\dot{e}_4 &= -(e_5 + R)(e_4 + \alpha e_3) \\
\dot{e}_5 &= \gamma(e_4 - \alpha\beta_d^2)(e_4 - e_2 + e_6), \\
\dot{e}_6 &= -k(e_4 - e_2 + e_6).
\end{aligned} \tag{43}$$

Comparing (43) with (28) we notice that the only modification that the load torque estimator has introduced is the addition in  $\dot{e}_5$  of the signal  $e_6$ , whose dynamics is given in (43).

As shown in the proof of Proposition 2 the origin of the system  $(e_3, e_4)$  is globally exponentially stable and the function  $e_5 \in \mathcal{L}_\infty$  by construction. Now, from (29) we can get the bound

$$\dot{V}_2 \leq -\frac{R}{L}V_2 + \frac{1}{R}\alpha^2(1 + \alpha^2)\beta_d^4|e_5|^2,$$

from which we conclude that  $e_1, e_2 \in \mathcal{L}_\infty$ . Moreover, the bound of the steady state depends on the  $\mathcal{L}_\infty$ -norm of  $e_5$ . Finally, from the last equation of (43) we conclude that  $e_6 \in \mathcal{L}_\infty$  which means that all errors are bounded.  $\square\square\square$

Therefore, we conclude that the torque and flux amplitude regulation errors enter asymptotically a neighborhood of zero whose radius decreases proportionally to the  $\mathcal{L}_\infty$  norm of the rotor resistance estimation error. At first glance this seems to be a rather weak property that is, however, not the case. Indeed, by construction, the resistance estimation error lives in the prior knowledge interval  $[R_m, R_M]$ , see (27). This implies that the quality of the regulation is improved with better knowledge of the rotor resistance, and in the ideal case, when this parameter is exactly known, we achieve convergence to zero of the errors.

## 7 Preliminary Results on Adaptive Speed Regulation IFOC

As is well-known [5, 9, 11, 13] IFOC can also be used to control *rotor speed*, instead of torque. This is achieved simply replacing  $\tau_d$  in (5) by the output

of a PI control loop around the rotor speed error, that is,

$$\tau_d = - \left( k_P + \frac{k_I}{p} \right) \tilde{\omega} \quad (44)$$

where we defined the speed error  $\tilde{\omega} := \omega - \omega_d$ , with  $\omega_d \in \mathbb{R}$  the desired speed,  $p := \frac{d}{dt}$  and  $k_P, k_I > 0$  are *arbitrary* tuning gains.

Similarly to the torque regulation IFOC its speed regulation version ensures global convergence, as indicated in the proposition below.

**Proposition 4.** Consider the IM model (2)-(4) in closed-loop with the speed regulation IFOC (5), (44). For all initial conditions of the PI and all  $(\lambda(0), \omega(0), \rho_d(0)) \in \mathbb{R}^4$  we have that all signals remain bounded and

$$\lim_{t \rightarrow \infty} \omega(t) = \omega_d, \quad \lim_{t \rightarrow \infty} |\lambda(t)| = \beta_d. \quad (45)$$

*Proof.* First, notice that the only modification to the torque regulation IFOC (5) is in the definition of  $\tau_d$ . Therefore, we still have the property (10), that is  $\tau = \tau_d + \epsilon_t$ , with  $\epsilon_t$  converging to zero exponentially fast. Replacing the expression above in (3), (4) we get

$$D\dot{\tilde{\omega}} = \tau_d - \tau_L + \epsilon_t.$$

The proof is completed replacing (44) above and invoking well-known properties of linear systems.  $\square\square\square$

It is shown in [6] that stability of the speed regulation IFOC is preserved even for large variations of the rotor resistance. However, as is well-known [12, 13], performance is degraded when this parameter is unknown—motivating the inclusion of a resistance estimator. In this section we propose a slight modification to the estimator of Proposition 2 and the addition of a (fast) filter to the PI controller (44) of the form

$$\tau_d = - \left[ \frac{1}{p + k_F} \left( k_P + \frac{k_I}{p} \right) \right] \tilde{\omega}, \quad (46)$$

with  $k_F > 0$  a large number, to generate an adaptive speed regulation IFOC. If the filter  $\frac{1}{p+k_F}$  is chosen sufficiently fast the difference between the filtered and the unfiltered signal is negligible, although its practical implementation may generate some numerical problems. As will become clear below, the reason for its inclusion stems from the need to compute—without differentiation nor measurement of acceleration—the signal  $\dot{\tau}_d$  for the adaptive implementation.

We consider the adaptive IFOC (13) with  $\tau_d$  defined by the (filtered) speed PI (46), the estimator (14), (16), (17) and

$$\begin{aligned} \dot{z} = & \gamma \left[ \frac{D}{n_P} \hat{R} \omega \hat{\lambda}^\top (J + \alpha I) u + \left( \hat{\lambda}^\top J u \right)^2 + \frac{L \tau_L}{n_P} \left( \hat{\lambda}^\top J u \right) \right] \\ & + \gamma \frac{D}{n_P} \omega \hat{\lambda}^\top e^{J \hat{p}_d} \begin{bmatrix} 0 \\ \frac{L^2}{n_p \beta_d} \dot{\tau}_d \end{bmatrix}, \end{aligned} \quad (47)$$

where  $\alpha$  is given by (8) and (46),  $\gamma > 0$  and the tuning gains  $k_F, k_P$  and  $k_I$  are selected such that the polynomial

$$\delta(s) := s^3 + k_F s^2 + \frac{k_P}{D} s + \frac{k_I}{D} \quad (48)$$

is Hurwitz.

We will now proceed to show that, modulo the definition of  $\alpha$ , the resulting closed-loop dynamics *exactly coincide* with the dynamics of the torque regulation IFOC. More precisely,  $\alpha$  given in (8), is a constant parameter in the latter, while in speed regulation it is a function proportional to the output of the (filtered) PI (46). As discussed below, this difference significantly complicates the stability analysis.

First, notice that we have only added to the estimator of Proposition 2 the last right hand term of (47), which equals zero if  $\tau_d$  is constant. For the speed regulation case of interest, this term can be computed—without differentiation—via

$$\dot{\tau}_d = - \left[ \frac{p}{p + k_F} \left( k_P + \frac{k_I}{p} \right) \right] \tilde{\omega}.$$

Repeating *verbatim* the calculations in the proof of Proposition 2 we see that in the computation of  $\dot{u}$  in (21) a term depending on  $\dot{\tau}_d$  appears. To recover the desired form of the parameter error dynamics (22) the the last right hand term of (47) must be added to  $\dot{z}$ . Notice that the flux observer, and consequently its error dynamics (18), remains also unchanged. Hence, the estimator error equations are given by (24). Moreover, the dynamics of the (partial) state vector (25) is given by (26).

Now, define  $\tilde{\tau} := \tau - \tau_d$  and write the rotor dynamics (3) as

$$D \dot{\tilde{\omega}} = \tau_d + \tilde{\tau} - \tau_L.$$

Replacing (46) above and grouping terms we have

$$D \dot{\tilde{\omega}} = \frac{p^2 + k_F p}{\delta(p)} (\tilde{\tau} - \tau_L). \quad (49)$$

Recalling that  $\tau_L$  is constant and  $\delta(s)$  is Hurwitz, from (49) we see that, *if torque regulation is achieved*, that is, if

$$\lim_{t \rightarrow \infty} |\tau(t) - \tau_d(t)| = 0,$$

then (45) holds.

As indicated in (ii) of Proposition 4 the vector  $x$  defined in (25) is only a *partial* state vector for the closed-loop dynamics to which we need to add the states coming from the PI (46). These new states are fed-back, through the signal  $\alpha$ , to the  $x$  dynamics yielding a highly complicated interconnected system. For instance, the definition of its steady-state behavior—that in torque regulation IFOC are easily definable constant equilibria—in this case is hard to elucidate.

## 8 Simulation Results

In this section we first show simulations of the IM model (2)-(4) in closed-loop with the adaptive torque regulation IFOC of Proposition 2. Then, to relax the assumption of knowledge of the load torque  $\tau_L$ , the controller of Proposition 3 is simulated. Finally, simulations for the adaptive speed regulation IFOC discussed in Section 7 are given.

We have simulated the model of a 0.5[KW] IM available in the Laboratoire de Genie Electrique de Paris, for which experimental results are reported in [2]. The IM model parameters are given as  $R = 2.76 [\Omega]$ ,  $L = 0.42 [H]$ ,  $D = 0.06 [kg m^2]$ ,  $n_p = 2$ . All simulations start from the initial speed  $\omega(0) = 0$  and without load torque  $\tau_L = 0$  and, at time  $t = 1[sec]$ , the load torque is stepped-up to  $\tau_L = 2 [Nm]$ . Notice that we have chosen a worst-case simulation scenario for the rotor resistance estimator. Indeed, for torque regulation the control  $u$  is frozen for  $0 \leq t \leq 1$  providing no excitation in this time interval for the estimator, with a similar situation happening for all other controllers.

### 8.1 Torque regulation with known load torque

Figures 2-5 correspond to the adaptive torque regulation IFOC of Proposition 2, that is, assuming  $\tau_L$  is known. The references are set to  $\beta_d = 1$ ,  $\tau_d = \tau_L$ , which correspond to  $\alpha = 0.42$  and the *a priori* estimated interval for  $R$  was taken as  $R_m = 1$  and

$$R_M = 5 < \frac{R}{\alpha^2} = 13.04.$$

In Figs. 2 and 3 different initial conditions and a fixed adaptation gain  $\gamma = 100$  are considered. As expected from the discussion above the rotor resistance estimation goes “in the right direction” only after  $t = 1[\text{sec}]$ —a pattern that is repeated in all simulations. To show the tracking ability of the estimator, in Figs. 4 and 5 we present the case when the resistance is changed from its nominal value  $R = 2.76 [\Omega]$  for  $0 \leq t < 10$  to  $0.5R$  for  $10 \leq t < 20$  and  $1.5R$  for  $t \geq 20$ . Fig. 4 shows the behaviour for different adaptation gains  $\gamma$ . As expected, convergence time decreases with increasing adaptation gain, at the price of a larger overshoot. Fig. 5 explores the robustness properties of the scheme when we use wrong estimates of  $L$  and  $D$ , denoted  $\hat{L}$  and  $\hat{D}$ , respectively. We see from Fig. 5 that the algorithm is particularly sensitive to underestimation of  $L$ .

## 8.2 Torque regulation with load torque estimator

To test in simulation the performance of the adaptive IFOC with the load torque estimator of Proposition 3 the same simulation scenario of Fig. 4 was repeated—with different estimator adaptation gains  $k$ . The results, presented in Fig. 6, show that transient performance degradation of the adaptive IFOC due to the replacement of the exact knowledge of  $\tau_L$  by its estimate is hardly perceptible.

## 8.3 Speed regulation

In Figs. 7 and 8 the simulation results for the adaptive speed regulation IFOC discussed in Section 7, with different desired constant speeds and various PI tuning gains, are given. In Fig. 7 we fix the desired speed to  $\omega_d = 0.4[\text{rpm}]$  and select the PI controller gains  $k_P$ ,  $k_I$ , and  $k_F$  in (46) to make the polynomial (48) equal to  $(p + a)^3$  for different positive constants  $a$ . As expected, as we move the poles further to the left, the speed of response increases. In Fig. 8 we fix  $a = 50$  and show the behaviour for different values of the desired speed  $\omega_d$ . In all cases the rotor resistance is consistently estimated and the desired speed and rotor flux norm regulations are satisfactorily achieved.

# 9 Discussion and Future Extensions

**D1** The main difficulty of the task addressed in this paper is the constraint that the IFOC structure should be preserved and it is only allowed to add a rotor resistance estimator to track the variations of this parameter. This

constraint is consistent with industrial practice where a long successful experience with a given controller, on one hand, discourages practitioners from major modifications to it while, on the other hand, has led them to identify the major culprit of the scheme—in the case of IFOC its sensitivity to variations of the rotor resistance, which happens in normal operation of the IM. Schemes that involve major departures from IFOC, usually requiring high-order complicated implementations, have proven to be only of academic interest. The same remark applies, of course, to controllers relying on the injection of high-gain, *e.g.*, sliding mode or high-gain observer-based, whose noise amplification characteristics makes them unsuitable for motor applications.

**D2** The constraint (11) of Assumption 1 expressed in terms of the motor parameters and the controller references is

$$\frac{\tau_d}{\beta_d^2} < \frac{n_P}{L}.$$

Given the usual order of magnitudes of these quantities this inequality is satisfied for a large class of IM—particularly in the cases where there is some freedom in the choice of  $\beta_d$ . In any case, we are investigating modifications of the proposed scheme to remove this constraint and enlarge the realm of application of our scheme. Another issue of concern is the sensitivity of the scheme, observed in simulations, to uncertainty on the rotor inductance—in particular, to its underestimation.

**D3** As shown in the proof of Proposition 2 the assumption  $\alpha < 1$  is required, on one hand, to ensure uniqueness of the equilibrium. On the other hand, from (31) we see that the dynamics of the coordinate  $w_1$  becomes unstable at the equilibrium  $\hat{R} = R$  if  $\alpha > 1$ . Hence, this is a *critical structural* condition that is not a consequence of the analytical tools used in the paper. Simulation results have shown that, for some initial conditions, trajectories grow unbounded if  $\alpha > 1$ . See also the discussion at the end of Section 4.

**D4** Unfortunately, the stability analysis of the adaptive speed regulation IFOC discussed in Section 7 is incomplete. The fact that the dynamics of this scheme exactly coincides with the globally convergent dynamics of torque regulation when the output of the PI, *i.e.*,  $\tau_d$ , converges to a constant, suggests that the system is amenable to a singular perturbation-like stability analysis that we are currently investigating.

**D5** The IM model (2)-(4) coincides, up to the presence of the term  $\lambda$  in

the first equation and the load torque  $\tau_L$  with the celebrated non-holonomic integrator of Brockett for which a vast amount of research has been devoted. Interesting connections, extensions and simplifications between the time-varying controllers used for this system and the IFOC of Section 2 are explored in [7].

## References

- [1] B.D.O. Anderson, R.R. Bitmead, C.R. Johnson, P.V. Kokotovic, R.L. Kosut, I.M.Y. Mareels, L. Praly and B.D. Riedle, *Stability of Adaptive Systems: Passivity and Averaging Analysis*, The M.I.T. Press, Cambridge, MA and London, 1986.
- [2] A. Astolfi, D. Karagiannis and R. Ortega, *Nonlinear and Adaptive Control with Applications*, Springer-Verlag, Berlin, Communications and Control Engineering, 2008.
- [3] G. Chang, J. P. Hespanha, A. S. Morse, M. Netto and R. Ortega, Supervisory field-oriented control of induction motors with uncertain rotor resistance, *Int. J. Adaptive Control and Signal Processing*, Vol. 15, No. 3, pp. 353-375, 2001.



- [4] G. Chang, Sur la commande non-linéaire des machine électriques: synchrones et asynchrones, PhD Thesis, SUPELEC-LSS, France, 1999.
- [5] J. Chiasson, *Modeling and High-Performance Control of Electric Machines*, John Wiley and Sons, 2005.
- [6] P. de Wit, R. Ortega and I. Mareels, Indirect field oriented control of induction motors is robustly globally stable, *Automatica*, Vol. 32. No. 10, pp 1393-1402, Octobre 1996.
- [7] G. Escobar, R. Ortega and M. Reyhanoglu, Regulation and tracking of the non holonomic double integrator, *Automatica*, Vol. 34, No. 1, 1998.
- [8] P.C. Krause, *Analysis of Electric Machinery*, McGraw Hill, New York, 1986.
- [9] W. Leonhard, *Control of Electrical Drives*, Springer-Verlag, Berlin, 1985.
- [10] R. Marino, S. Peresada and P. Tomei, Adaptive output feedback control of current-fed induction motors with uncertain rotor resistance and load torque, *Automatica*, Vol. 34, No. 5, pp. 617-624, 1998.
- [11] R. Marino, P. Tomei and C. Verrelli, *Induction Motor Control Design*, Springer Verlag, London, 2010.
- [12] K. Nam, *AC Motor Control and Electric Vehicle Applications*, CRC Press, 2010.
- [13] R. Ortega, A. Loria, P. J. Nicklasson and H. Sira-Ramirez. *Passivity-Based Control of Euler-Lagrange Systems*. Springer-Verlag, Berlin, Communications and Control Engineering, 1998.
- [14] S. Peresada, A. Tilli and A. Tonielli, Theoretical and experimental comparison of indirect field-oriented controllers for induction motors, *IEEE Transactions on Power Electronics*, Vol. 18, No. 1, pp. 151-163,
- [15] S. Sastry and M. Bodson, *Adaptive Control: Stability, Convergence and Robustness*, Prentice-Hall, London, 1989.
- [16] C. Verrelli, A. Savoia, M. Mengoni, R. Marino, P. Tomei and L. Zarri, On-line identification of winding resistances and load torque in induction machines, *IEEE Trans. Control Systems Technology*, Vol. 22, pp. 1629-1637, No. 4, July 2014.

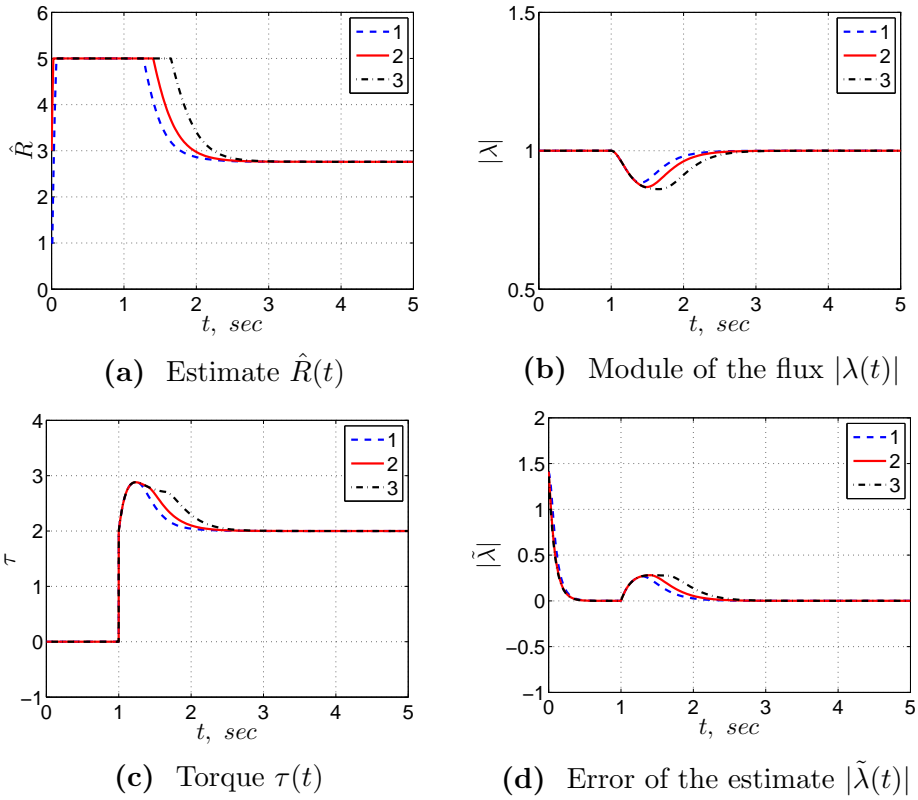

**Figure 2:** Simulation results of the adaptive *torque* regulation IFOC of Proposition 2 with  $\gamma = 100$ ,  $\lambda(0) = (1, 0)$ ,  $\hat{\lambda}(0) = (0, 1)$  and *different initial conditions* for  $z$ . 1. (blue line)  $z(0) = 0$ ; 2. (red line)  $z(0) = 3$ ; 3. (black line)  $z(0) = 5$ .

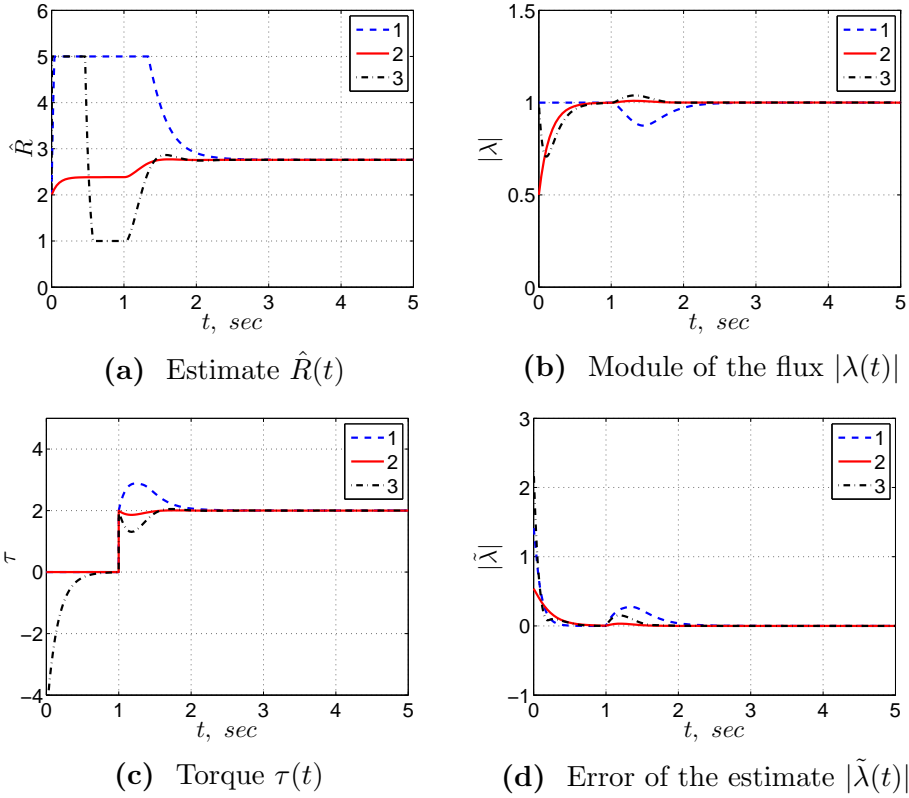

**Figure 3:** Simulation results of the adaptive *torque* regulation IFOC of Proposition 2 with  $\gamma = 100$ ,  $z(0) = 2$  and *different initial conditions for  $\lambda$  and  $\hat{\lambda}$* . 1. (blue line)  $\lambda(0) = (1, 0)$ ,  $\hat{\lambda}(0) = (0, -1)$ ; 2. (red line)  $\lambda(0) = (0.5, 0)$ ,  $\hat{\lambda}(0) = (0, 0.2)$ ; 3. (black line)  $\lambda(0) = (0, 1)$ ,  $\hat{\lambda}(0) = (-1, 3)$ .

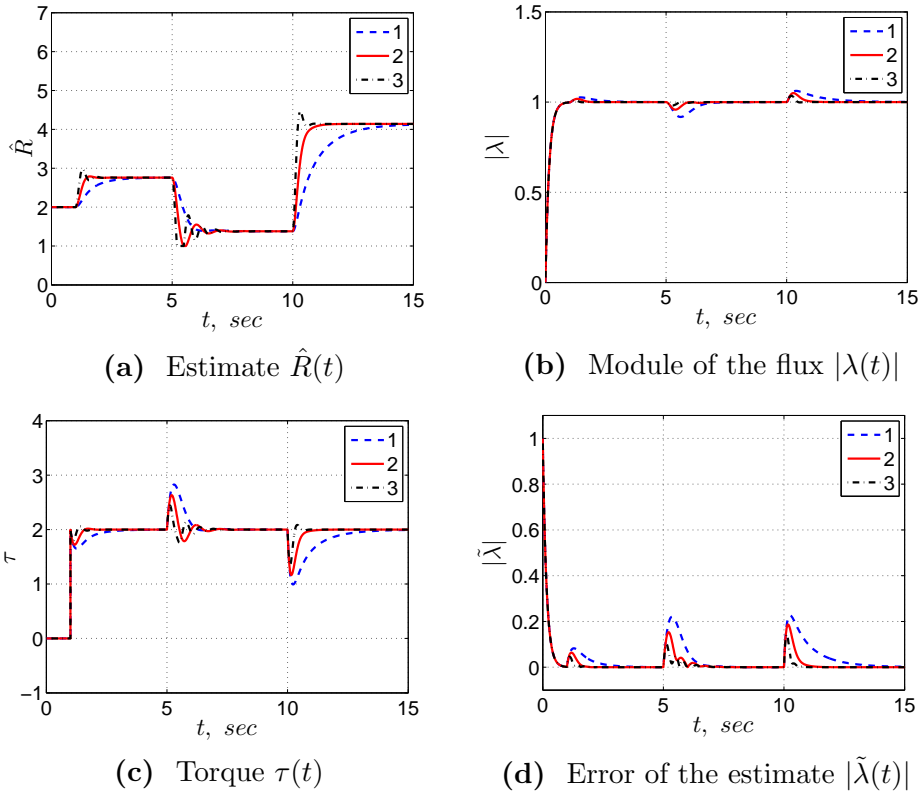

**Figure 4:** Simulation results of the adaptive *torque* regulation IFOC of Proposition 2 with  $z(0) = 2$ ,  $\lambda(0) = (0, 0)$ ,  $\hat{\lambda}(0) = (1, 0)$  *step changes in  $R$  and different adaptation gains.* 1. (blue line)  $\gamma = 30$ ; 2. (red line)  $\gamma = 100$ ; 3. (black line)  $\gamma = 300$ .

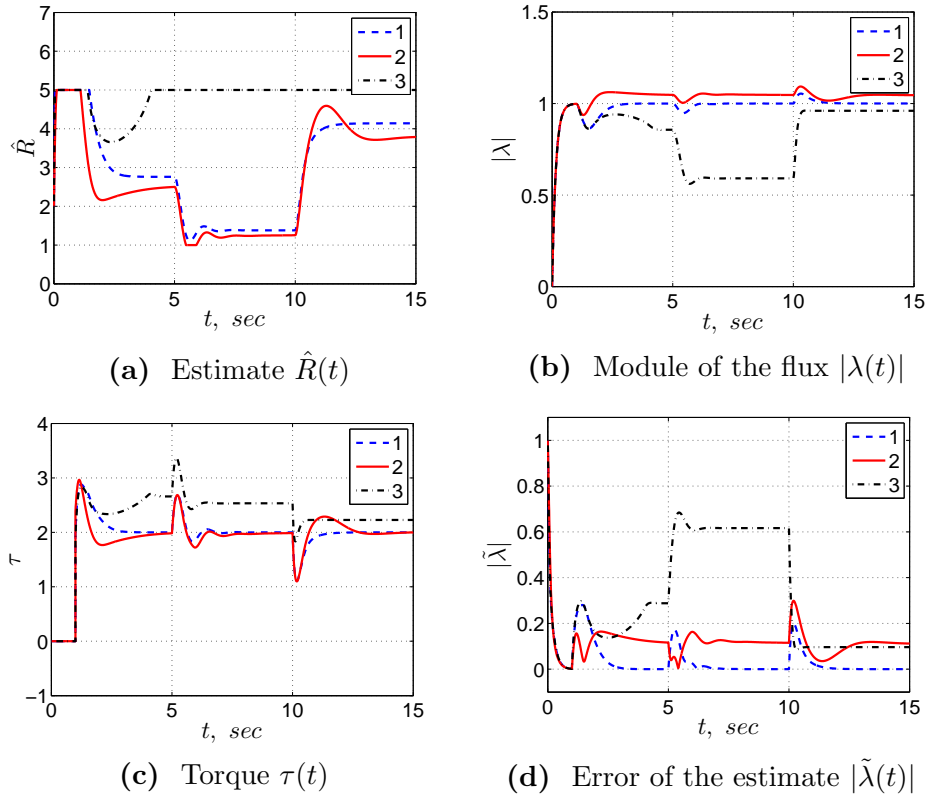

**Figure 5:** Simulation results of the adaptive *torque* regulation IFOC of Proposition 2 with  $\gamma = 50$ ,  $z(0) = 2$ ,  $\lambda(0) = (0, 0)$ ,  $\hat{\lambda}(0) = (0, 1)$  step changes in  $R$  and wrong estimates of  $D$  and  $L$ . 1. (blue line)  $\hat{D} = 0.7D$ ,  $\hat{L} = L$ ; 2. (red line)  $\hat{D} = 0.9D$ ,  $\hat{L} = 1.2L$ ; 3. (black line)  $\hat{D} = 1.2D$ ,  $\hat{L} = 0.95L$ .

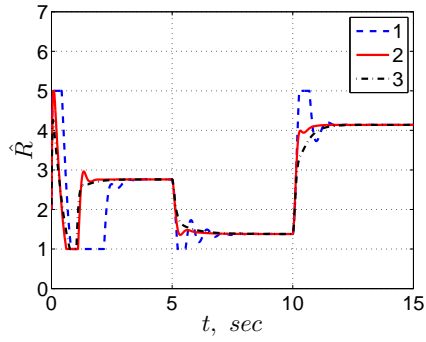

(a) Estimate  $\hat{R}(t)$

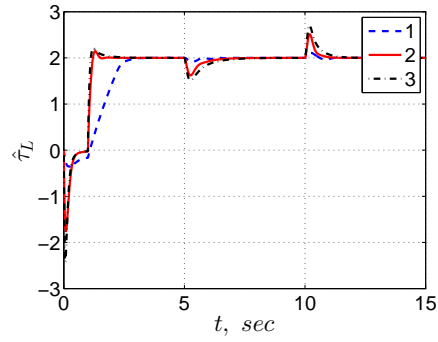

(b) Estimate of the load torque  $\hat{\tau}_L(t)$

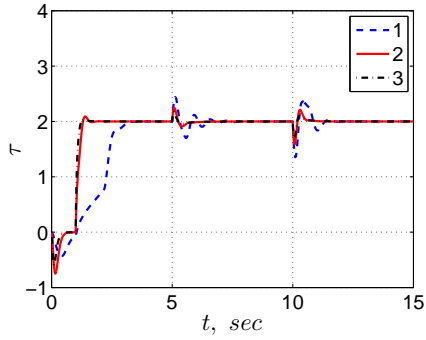

(c) Torque  $\tau(t)$

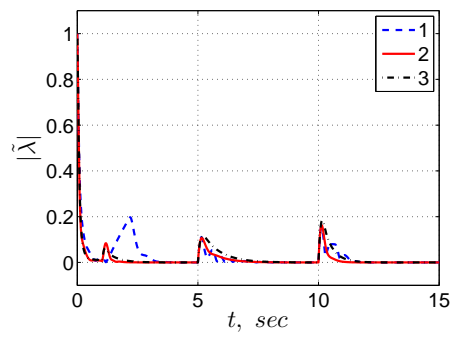

(d) Error of the estimate  $|\tilde{\lambda}(t)|$

**Figure 6:** Simulation results of the adaptive *torque* regulation IFOC with the *load torque estimator* (35)-(37) with  $\gamma = 200$ ,  $z(0) = 2$ ,  $\lambda(0) = (0, 0)$ ,  $\hat{\lambda}(0) = (0, 1)$  *step changes in R* and *different adaptation gains k*. 1. (blue line)  $k = 1$ ; 2. (red line)  $k = 10$ ; 3. (black line)  $k = 100$ .

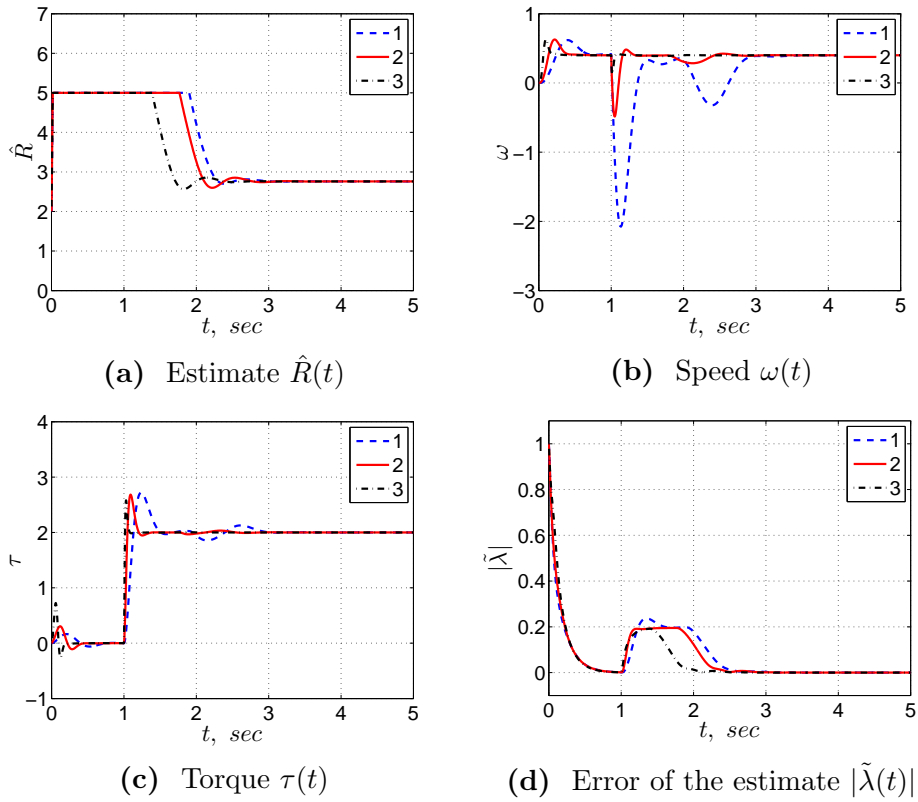

**Figure 7:** Simulation results of the adaptive *speed* regulation IFOC discussed in Section 7 with  $\gamma = 200$ ,  $z(0) = 2$ ,  $\lambda(0) = (0, 0)$ ,  $\hat{\lambda}(0) = (0, 1)$ ,  $\omega_d = 0.4$  and *different values of  $a$* . 1. (blue line)  $a = 10$ ; 2. (red line)  $a = 30$ ; 3. (black line)  $a = 100$ .

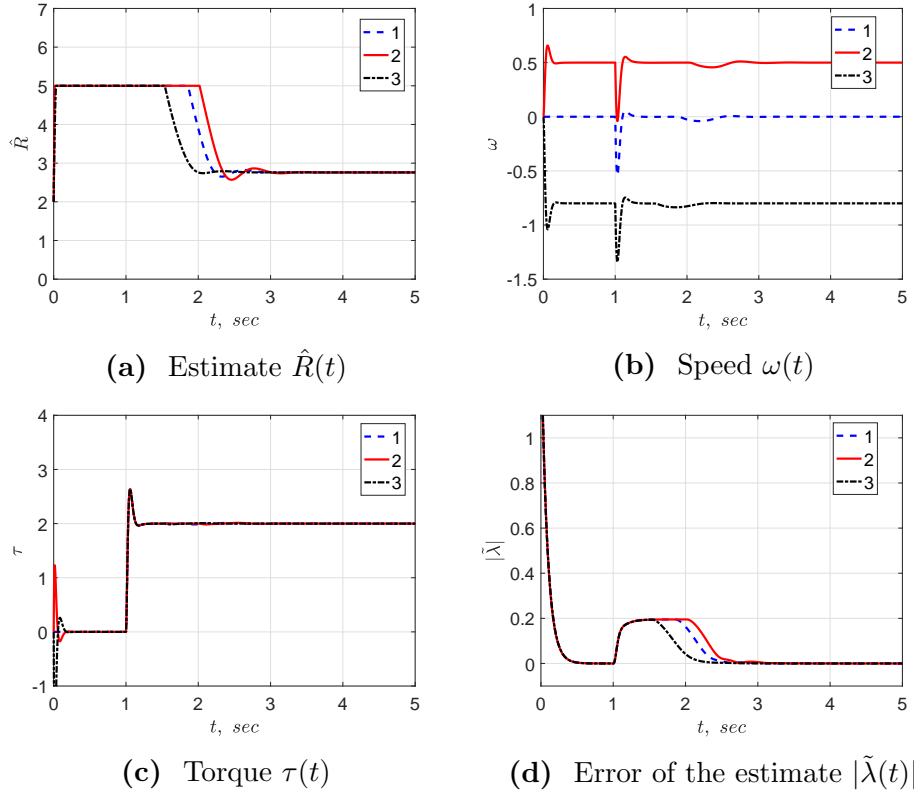

**Figure 8:** Simulation results of the adaptive *speed* regulation IFOC discussed in Section 7 with  $\gamma = 200$ ,  $z(0) = 2$ ,  $\lambda(0) = (0, 0)$ ,  $\hat{\lambda}(0) = (0, 1)$ ,  $a = 50$ , and *different desired speeds*. 1. (blue line)  $\omega_d = 0$ ; 2. (red line)  $\omega_d = 0.5$ ; 3. (black line)  $\omega_d = -0.8$ .