



HAL
open science

Challenges of mastering the energy sector and sustainable solutions for development in Africa

J. D. D. Nguimfack-Ndongmo, A. Muluh Fombu, L. L. Sonfack, R. Kuaté-Fochie, G. Kenné, F. Lammabhi-Lagarrigue

► To cite this version:

J. D. D. Nguimfack-Ndongmo, A. Muluh Fombu, L. L. Sonfack, R. Kuaté-Fochie, G. Kenné, et al.. Challenges of mastering the energy sector and sustainable solutions for development in Africa. *Revue Africaine de Recherche en Informatique et Mathématiques Appliquées*, In press, 30, pp.16. hal-01697412v2

HAL Id: hal-01697412

<https://inria.hal.science/hal-01697412v2>

Submitted on 1 Apr 2019 (v2), last revised 3 May 2019 (v3)

HAL is a multi-disciplinary open access archive for the deposit and dissemination of scientific research documents, whether they are published or not. The documents may come from teaching and research institutions in France or abroad, or from public or private research centers.

L'archive ouverte pluridisciplinaire **HAL**, est destinée au dépôt et à la diffusion de documents scientifiques de niveau recherche, publiés ou non, émanant des établissements d'enseignement et de recherche français ou étrangers, des laboratoires publics ou privés.

Challenges of mastering the energy sector and sustainable solutions for development in Africa

J.d.D. Nguimfack-Ndongmo^{*a} — A. Muluh Fombu^{*b} — L.L. Sonfack^{*c}
R. Kuaté-Fochie^{*d} — G. Kenné^{*e} — F. Lamnabhi-Lagarigue^{**}

* Unité de Recherche d'Automatique et d'Informatique Appliquée (LAIA),
Département de Génie Électrique, IUT Fotso Victor Bandjoun,
Université de Dschang, B.P. 134 Bandjoun, Cameroun.
^anguimfackjdedieu@yahoo.fr, ^bfombuandrewmuluh@yahoo.com
^cliosonfack@yahoo.fr, ^dkuate_rf@yahoo.fr
^egodpromesse@gmail.com, godpromesse.kenne@univ-dschang.org

** CNRS-INS2I-Laboratoire des Signaux et Systèmes (L2S),
Université Paris Saclay,
Rue Joliot Curie, 91192 Gif-sur-Yvette, France
lamnabhi@l2s.centralesupelec.fr

ABSTRACT. The African continent is currently experiencing a period of sustained economic and population growth that requires massive investment in the energy sector to effectively meet the energy needs in the context of sustainable development. At the same time, Paris COP21 agreements now call all the states to use clean energy. Yet a great energy potential is available, but the rate of energy consumption for the continent currently accounts for only 3.3% of the world's energy production (BP Statistical Review of World Energy 2018 [1]). Also, the demand for both quality and quantity energy requires the mastery of applied mathematical tools to efficiently solve problems arising in the energy system. In this article, the major problems affecting the energy sector in Africa are identified and some solutions to the challenges are proposed with more emphasis given to applied mathematics tools as well as energy policy. As case studied, a new control strategy of SSSC based on intelligent techniques is proposed for Power Flow Control.

RÉSUMÉ. Le continent africain connaît actuellement une période de croissance économique et démographique soutenue qui requiert un investissement massif dans le secteur de l'énergie en vue d'un développement durable. Dans le même temps, les accords de la COP21 de Paris interpellent désormais les états à recourir aux énergies propres. Malgré son potentiel énergétique énorme, l'Afrique ne consomme que 3.3% de la production mondiale (BP Statistical Review of World Energy 2018 [1]). D'autre part, la demande d'énergie en qualité et en quantité nécessite un recours aux outils mathématiques modernes pour résoudre les problèmes des réseaux électriques. Cet article présente la situation énergétique africaine et propose des solutions tant sur le plan des mathématiques appliquées que de la gouvernance. A titre d'illustration des solutions mathématiques nouvelles, une méthode de commande du SSSC combinant des techniques intelligentes est proposée pour l'amélioration du transit de puissance.

KEYWORDS : Energy challenges, New governance, Sustainable development, Power systems modeling, SCADA, FACTS, Neural network, Fuzzy logic, Sliding mode.

MOTS-CLÉS : Défis énergétiques, Nouvelle gouvernance, Développement durable, Modélisation des réseaux électriques, SCADA, FACTS, Réseau de neurones, Logique floue, Mode glissant.



1. Introduction

The rate of energy production of any country today is an indicator of its level of sustainable development. The energy sector combines economic, political, social, technical, environmental and climatic issues that are inseparable from the reflections to be pursued in order to ensure an efficient, competitive and sustainable development in the world. In Africa, a great energy potential is available, but the rate of energy consumption for the continent currently accounts for only 3.3% of the world's energy production [1]. The current needs are enormous, especially in the Sub-Saharan region excluding South Africa.

Several studies have already been done on the energy sector in Africa: the low energy consumption, the difficult access to energy for a majority of the population, just to name a few. Numerous recommendations have also been made on the subject [2–4] but little has changed. In most cases, the electric power produced is consumed simultaneously, so, production must adapt to consumption permanently. Faced with consumption fluctuations, it is necessary to permanently adapt the production and set up energy storage units. The operation of the network is also characterized by the fluctuations of active and reactive power flow. These fluctuations result in time variations in frequencies, currents and voltages. Maintaining the frequency and voltage within a certain range is an essential element for network managers. The adjustment network voltage, and especially frequency, is necessary for the proper functioning of the electrical system.

Moreover, the liberalization of the electricity market and the development of decentralized production lead to many new scientific and technical problems. These problems are obviously related to the new types of sources, which are distributed geographically and evolving rapidly, but they will also concern, within a few years, the management or even the structure of the energy networks. The main problem associated with decentralized energy sources is that they generally do not participate in system services (voltage regulation, frequency, islanding, etc.). This is particularly true for renewable energy sources whose primary source is fluctuating and difficult to predict. Globally, we are faced with a problem of network stability. Hence, the demand for energy of both quality and quantity requires the mastery of applied mathematical tools to solve problems that arise at each level within the electrical network.

The paper is organized as follows. In Section 2, a brief overview of the energy potential in Africa is presented. Some problems and solutions to the challenges of the energy sector are presented in Section 3 and 4. As case studied, a New Control Strategy for Power Flow Control is proposed for a FACTS device (SSSC) in section 5. Finally, in Section 6, some concluding remarks end the paper.

2. Energy potential of Africa

There are many major sources of energy exploited on the continent such as: oil, natural gas, coal, biomass, and hydropower. Other poorly exploited energy potentials are: solar, wind, geothermal, and nuclear (in very small proportion in South Africa).

2.1. Oil, Natural Gas and Coal

Worldwide, oil represents only 35% per inhabitant energy consumption [2]. In sub-Saharan Africa, this source accounts for 50% of energy consumption. Yet after more than half a century of oil exploitation and many years of revenue available for national

investments, the African oil producing countries have not seen their situation improve significantly in terms of development. Globally, the poor management of oil wealth did not enable the continent to benefit from the expected income of its "energy exploitation" [2].

Natural gas is used domestically, industrially and for the production of electricity. It is abundant in the northern part of Africa (Algeria, Egypt, and Libya), and plays a key role in European energy supply (Algerian exports cover more than 10% of European gas needs). The gas sector is in full expansion, with the discovery of gas deposits in some countries such as Cameroon, Mozambique, Tanzania, etc. [2].

The African coal reserves are mostly found in South Africa and Zimbabwe. With an annual production of about 250 million tones, South Africa is the main producer of the continent where it is mainly used in the production of electricity.,

2.2. Renewable Energies

The African continent has enormous potential for all types of renewable energy, including hydropower, solar, wind, geothermal and biomass.

2.2.1. Hydroelectricity

It is the most developed form of electrical energy in Africa. However, a large proportion of the hydroelectric potential (12% of the world's potential) remains under-exploited and is mainly located in Central Africa, particularly in Congo-Kinshasa and Cameroon. An important potential also exists along the Nile, Guinea-Conakry and Mozambique. The exploitation of this hydraulic potential would provide clean energy and low unit costs, but it nevertheless requires expensive installations[1]. Within the framework of the emergency plan for the development of the hydropower sector, the Cameroon government has launched a program to build new hydroelectric power dams and stations (Lom-pamgar, Memve'élè, Song-Mbengue, Mekim, ...) which will be fully operational by 2020 and will contribute to reduce the national energy deficit [3].

2.2.2. Solar Energy

Africa benefits from a high level of solar radiation, especially within the Saharan region. The use of solar energy for the production of electricity can be done in two ways; solar thermal for dryers, cookers, heaters, production of electricity via hot steam etc and solar photovoltaic for decentralized energy production. The latter solution requires the use of equipments that are still very expensive for some regions of Africa. A current project aims at setting up PV installations in the Sahara could eventually cover 10 to 15% of Europe's electricity needs [2].

2.2.3. Wind Energy

Many African regions (mountainous or coastal) benefit from a good exposure to winds but Africa ranks last in terms of wind power production. This type of energy represents only 0.4% of the world's wind energy production and is produced mainly by three countries: Tunisia, "Cap Vert" and South Africa [5].

2.2.4. Geothermal Energy and Biomass

A geothermal potential has been found in the Rift Valley. It is exploited by Kenya for electricity production (125 MW power plant). The consumption of biomass, mainly firewood and charcoal, is high in Africa: African consumption of charcoal accounts for more than half the world production and about 60% of energy consumption in sub-Saharan Africa [2]. This massive consumption of biomass has so many negative effects such as:

harvesting of timber (which is time-consuming and mostly carried out by women), health problems related to the inhalation of smoke in houses. Nevertheless, there are new ways of producing and consuming wood (improved firewood cookers), as well as energy crops that are being realized in order to reconcile the use of biomass and the protection of ecological balances.

3. Some Problems Faced by the Energy Sector in Africa

Some of the problems that undermine the energy sector in Africa are related to: governance, technology, quality human resource and low exploitation of adequate applied mathematical tools.

3.1. Governance problems

Good governance in the field of energy is essential because it enables decision-makers to define better policy and the appropriate regulatory framework for each African country. Global governance provides possible directions with the objective of securing investment by striking a balance between the involvement of the country's capacities, public aid to development and the payment of services by users. However, in many African countries, instability slows down the good monitoring of energy policies. Within the framework of decentralization, the new governance model that strengthens the transport and distribution functions must be based on local communities and institutions that do not always have the financial, human and technological capacities to manage their energy production structures.

3.2. Technological Problems

3.2.1. Electricity Production, Transportation and Distribution Problems

The electricity production infrastructure is generally outdated and vulnerable to changes in demand. This situation results in load shedding and blackouts in many sub-Saharan countries. According to the World Bank, line losses due to distribution equipments can reach 2% of GDP (Gross Domestic Productivity) in many sub-Saharan African countries [4]. This inefficient situation is due to the lack of investment in the electricity sector (0.7% of GDP on average). To remedy this situation, many African countries use less optimal solutions which in turn are much more expensive. Despite abundant energy sources, electricity in sub-Saharan Africa, with average prices above international standards, is scarce and expensive. Sub-Saharan Africa also presents specific aggravating difficulties:

- With low production, there are few interconnected networks. This situation further penalizes the integration of strong production capacities.

- The availability rate of installations is very low, the network equipment is often obsolescent and the maintenance is not always correctly assured (25% of installed capacity is out of function). As a result, cuts in electricity reach about 50 days a year and penalize both the health of the electricity companies and economic life in general.

- Electricity consumers often use inefficient appliances (incandescent lamp). A practice which reduces their incomes.

- A large part of the electricity consumption is used by insolvent populations. Most of the time, this energy is subsidized by the state or suffers from very low public tariffs.

Consequently, accounts imbalance prevents the extension of the networks.

- The renewable sectors, adapted to serve isolated populations, remain very expensive.

3.2.2. Biomass Energy Production Problems

Biomass in the form of firewood is the most commonly used source of energy for domestic purposes in sub Saharan Africa. This consumption poses many problems: Deforestation, poor carbon footprint (pollution), social problems related to wood harvesting, domestic pollution causing illness and death.

3.2.3. Quality Human Resource Problems

Africa suffers from brain drain. The Diaspora comes from successive emigration trips to the western countries. This is mainly due to the fact that, at independence, many African countries in the race for development sent their nationals to Western countries for studies and a good number of well-trained professionals choose to remain in the host country. In the process of emergence, this migration towards western countries affects negatively the developing countries.

3.2.4. Poor Exploitation of Appropriate Applied Mathematical Tools

Currently, it can be noted that many algorithms (almost all) used in the monitoring and control of the various sectors of production, transport and distribution of energy in Africa are not based on the recent results of research in applied mathematics.

4. Some Solutions to the Challenges of the Energy in Africa

4.1. State of the art of Current Solutions

In the face of the alarming lack of adequate energy supply, African countries have undertaken over the past decade to reform the ownership, organization and regulation of the energy sector. More than 30 African countries have initiated a program to open the electricity sector to private operators. Although the situation lacks a satisfactory assessment, it seems that these reforms have produced mitigated results at the moment. In some countries, reliable regulation has made it possible to attract investors and improve access to electricity by the population. In others, an incomplete process has compromised the chances of success, underlining the crucial importance of the regulatory framework to facilitate transfer to the private sector. Past experiences highlight the essential role of the initial stages of the reform, namely the clear formulation of an electricity policy (setting out the guiding principles of the reform programs) and the establishment of a transparent and independent electricity market. National reforms must also take into consideration cross-border policies. Indeed, the nature of electricity projects, in particular their size and the possibilities of economies of scale linked to them, justifies the extension of networks beyond the borders.

A network interconnection plan is already being implemented in southern Africa: Southern African Power Pool-SAPP and another is being finalized in West Africa: West Africa Power Pool-WAPP [2]. Fostering regional initiatives to improve access to electricity is one of the fundamental proposals of the NEPAD (New Partnership for Africa's Development) energy initiative. Again, the establishment of an adequate common regulatory framework remains a crucial condition for success.

4.2. New Solutions Based on Applied Mathematics

4.2.1. Interconnection of Energy Production Pools using FACTS/HVDC

In Sub-Saharan Africa, the organization of Power Pools appears to be a key factor in the evolution of the sector, by structuring the African energy space into globally homogeneous groups, enabling the co-ordination of energy policies to better meet growth needs and to secure access to energy. The potential for expanding cross-border trade is significant.

For example, in the Southern African Power Pool alone, the volume traded could rise from 45 TWh (current figure), to 141 TWh per year [4]. According to the World Bank report (2008), by drawing maximum advantage from regional electricity trade, sub-Saharan African countries can aim for an access rate of 35% by 2020. Both Ethiopia and the Democratic Republic of Congo, would become major exporters of hydropower within their power pool. Funding would not necessarily come from domestic resources, but could be guaranteed to some extent by importing countries.

The large projects are under way in Cameroon on the intensification of the electricity grid (Lom-pamgar, Mvele, Mekim, Natchigal, etc. [3]) and other solar power projects in rural areas would eventually participate in the Interconnection of the Central-Africa-Power Pools to enable exchanges of energy flows in the sub-region. The construction of Power Pools would integrate the modern control devices of the transport networks such as FACTS (Flexible Alternating Current Transmission Systems) to enhance power flow as well as transient and oscillatory stabilities. In this paper, we propose a simple approach to design a nonlinear Static Synchronous Series Compensator (SSSC) controller which is based on recent results of research in applied mathematics.

4.3. Mastery of Modeling

Most of the electricity grids on the African continent do not have a known mathematical model (such as the Cameroon RIS and RIN networks). An important domain that requires research in the African power grid is the determination of their mathematical model which would be used in a number of simulations for various forecasting studies.

4.4. Global control and management strategy of modern energy system

The interconnection of African networks between sub-regions, regions and with the European network can be easily achieved if the networks of the different African countries are better structured and have appropriate equipments. It is with this in view that we propose a modern and simple architecture for the sub-Saharan countries which are still slowing down in the modernization of their electricity network. Note that microgrids control and optimization/management techniques are available in the literature [6–8], but very few contributions concerning large electric power system have been published. The main specifications requirements can be summarized as follows.

- Balance between production and consumption demands
- Maximization of the renewable energy production
- Economic constraints (minimization of the costs of the energy production)
- Voltage and frequency regulation and minimization of the power losses
- Safety requirements/operations.

4.4.1. Description of the proposed architecture.

The proposed architecture for the future Sub Saharan Africa energy power system is shown in Fig. 1.

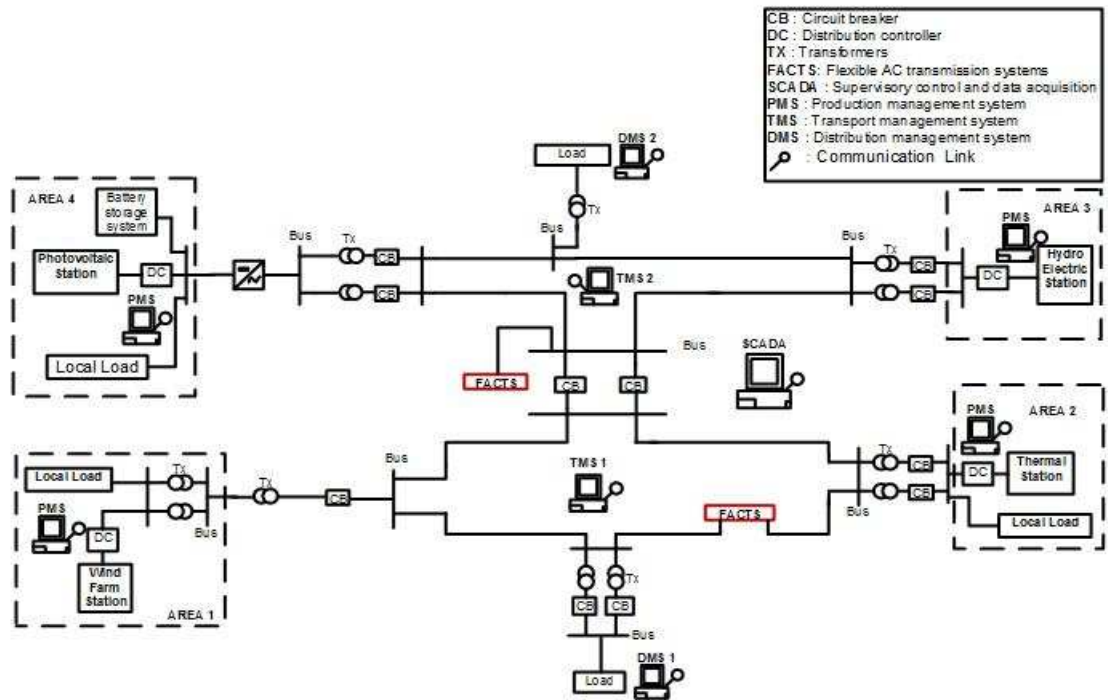

Figure 1. Proposed global architecture for Sub-Saharan African Power-Grid

The main parts of this architecture are: Wind turbine generators (WTG), Photovoltaic Array (PV), Hydroelectric power station (HPS), Diesel engine generators (DEG), Storage systems (SS), Loads, Circuit Breakers (CB), FACTS units, Distributed controllers (DC), Distribution management system (DMS), Supervisory control and data acquisition (SCADA). The whole grid is divided into several finite areas. Each area is managed using production management system (PMS).

4.4.2. Description of the mains control tasks.

Hierarchical distributed control scheme (primary, secondary and tertiary control) is always adopted [9–11]. The primary control is designed for controlling the distributed generators (DG) in order to satisfy some local requirements for the power system. Secondary control always deals with the correction of the steady-state errors in frequency and voltage magnitudes produced by the primary loop [12].

DCs work at the device level (primary and secondary control) and are designed for a correct operation (DC must be fast and reliable to maintain voltages) of every distributed energy resource (DER).

At the tertiary level, coordination between the primary and secondary levels should be achieved with the purpose of attaining a safer operation of the whole power system. In any case, the most important task is to maintain the security requirements. The whole power management of the energy system is achieved in this level.

4.4.3. Description of the mains tasks of management and optimization control of the power system.

Four type of management and optimization control can be distinguished namely: the production management system (PMS), the transmission management system (TMS), the distribution management system (DMS) and the supervisory control and data acquisition (SCADA) unit. e.g. Architecture of Fig.1 contains: 4 PMS which correspond to 4 production area or substations; 2 TMS; 2 DMS; 1 SCADA.

Note that a two-way communication between the SCADA and (PMS, TMS, DMS) is required to allow the interchange of control information. In addition, the main problem of the SCADA in AC power system is the synchronization of the data acquisition. HVDC has been introduced to overcome this problem.

The integration of the smart sensors installed in various areas of the architecture of Fig.1 will transform the proposed global power system into a smart-grids networks which is the future power network of the world.

Since the global architecture of Fig.1 is divided into several finite areas which can be considered as micro-grids, the optimization of the whole power energy operation in the wide area power grid can be obtained using SCADA unit, responsible of the whole energy operation and control.

4.4.4. Optimal control problem.

The optimal control problem (OCP) is related with finding the minimum of the real valued function $f(u)$ subject to the defined linear and nonlinear constraints in the continuous/discrete space. The general formulation of OCP is:

$$\min_u f(u) \quad \text{subject to} \quad \begin{cases} u_L < u < u_U \\ b_L < Au < b_U \\ c_L < c(u) < c_U \end{cases} \quad (1)$$

where u , u_L , u_U , $f(u)$, A , b_L , b_U and c_L , $c(u)$, c_U , represent the control variable, upper and lower limits of u ; cost function, matrix of linear constraints, upper and lower limits of the linear constraints; nonlinear constraints, upper and lower limits of $c(u)$, respectively. Optimal control techniques are classified according to the objective function to be minimized and the optimization method. The classification of the optimal control techniques presented for micro-grids is illustrated in [8].

5. Case studied: New SSSC Control Strategy for Power Flow Control

5.1. Design of SSSC neuro-sliding mode controller

The nonlinear SSSC state equations in the dq reference frame are given by [13, 14]

$$\begin{cases} \frac{di_D}{dt} = -\frac{\omega_0 R_s}{X_s} i_D + \omega_0 i_Q + \frac{\omega_0}{X_s} (V_{SD} - V_{RD} + V_{seD}) \\ \frac{di_Q}{dt} = -\frac{\omega_0 R_s}{X_s} i_Q - \omega_0 i_D + \frac{\omega_0}{X_s} (V_{SQ} - V_{RQ} + V_{seQ}) \\ \frac{dv_{dc}}{dt} = -\frac{\omega_0}{C_{dc}} \left(\frac{v_{dc}}{R_{dc}} + \frac{V_{seD} i_D + V_{seQ} i_Q}{v_{dc}} \right). \end{cases} \quad (2)$$

Where i_D and i_Q are the dq currents in per unit, C_{dc} is the capacitance of the DC side capacitor, v_{dc} is the voltage across the DC capacitor, ω_0 is the synchronous speed in rad/s, R_s and X_s are the series coupling transformer resistance and inductance in per unit respectively, $V_{seD} = V_{dc} U_d$ and $V_{seQ} = V_{dc} U_q$ are the inputs control components. $U_d = m \cos(\delta + \varphi_r)$ and $U_q = m \sin(\delta + \varphi_r)$ with m being the modulation ratio and φ_r the phase shift of the voltage V_r at the receiving end.

The control objectives of the SSSC can be divided into two modes.

– For mode 1, the SSSC injects a variable series voltage into the line such that the line powers track the desired active power P_r^* and the desired reactive power Q_r^* .

– For mode 2, the SSSC injects a variable series voltage into the line such that the line active power tracks the desired active power P_r^* with regulation of DC bus voltage V_{dc} to the reference value.

The dynamic model (2) of the plant must be written in the form of an affine non-linear system as:

$$\begin{cases} \dot{x} = f(x, t) + g(x, t)u + d(t) \\ y = x \end{cases} \quad (3)$$

where $x \in R$, $u \in R$ and $y \in R$ are the state variable, system input, and system output respectively. $f(x, t)$ and $g(x, t)$ are unknown smooth functions with $f(x, t)$ representing the nominal part of the system which does not depend on the control input while the uncertainties and external disturbance are represented by the term $d(t)$ assumed to be bounded by an unknown constant $d_0 > 0$; since all physical plants operate in bounded regions, we study the control problem of system (3) whose state x belongs to a compact subset $\Omega \subset R$.

Let the tracking error and the switching function for the sliding mode controller be defined as:

$$e_x = x^* - x, \quad \text{and} \quad S_x = e_x + l_x \int e_x dt \quad (4)$$

where $l_x > 0$ is a design parameter. The integral term is included in the sliding manifold S_x so as to ensure that the system trajectories start on the sliding manifold from the first instant of time. From \dot{S}_x , if the desired sliding mode controller is chosen as [15]:

$$u_x^* = -\frac{1}{g(x, t)} (f(x, t) + \mu_x + d(t)) - \frac{S_x}{\epsilon_x} \quad (5)$$

where $0 < \epsilon_x < 1$ is a design parameter, then $\dot{S}_x = -\frac{S_x}{\epsilon_x}$ and S_x will converge exponentially to 0.

Remarks.

– The control u_x^* given by (5) is not implementable in practice since $f(x, t)$, and $g(x, t)$ are assumed to be unknown. In addition the uncertainty and external disturbance $d(t)$ is assumed to be bounded by an unknown constant.

– Sliding mode control of the form $u_x^* = -K_x \text{sgn}(S_x)$ can be used but it requires high control gain that would excite high frequencies un-modeled dynamics under high frequency control switching.

– Some approaches in the literature [15–18] proposed the approximation of the unknown function and disturbance in (5) but the bounds on the disturbance/unknown function are assumed to be known.

Hence in this work, a RBF neural network combined with the sliding mode technique will be applied to approximate the unknown controller u_x^* as:

$$\hat{u}_x^*(\chi_x, t) = \Psi(\chi_x, \hat{w}) + b_x(t) \quad \text{with} \quad \Psi(\chi_x, \hat{w}) = \sum_{j=1}^N \hat{w}_j \phi(\|\chi_x - C_j\|, \nu_j), \quad (6)$$

where $\phi(\cdot)$ denotes a nonlinear function given by: $\phi = \exp[-\frac{\|\chi_x - C_j\|^2}{2\nu_j^2}]$

C_j and ν_j , $j = 1, \dots, N$ are the center and the width of the j -th hidden unit.

The term $b_x(t) = \pm \hat{\lambda}_x \text{sgn}(S_x)$ using in [15] is now approximate by the fuzzy gain $h(x, \theta)$ as:

$$h(x, \theta) = \frac{\sum_{m=1}^M \theta^m \prod_{i=1}^n \mu_{A^i}(x)}{\sum_{m=1}^M \prod_{i=1}^n \mu_{A^i}(x)} = \theta_x^T \psi(x) \quad (7)$$

In which M is the amount of the rules, θ_x^T is chosen as a parameter to be updated, and $\psi(x) = \frac{\prod_{i=1}^n \mu_{A^i}(x)}{\sum_{m=1}^M \prod_{i=1}^n \mu_{A^i}(x)}$ the height of the membership functions of $h(x, \theta)$, $\mu_{A^i}(x)$ is a gaussian function. This fuzzy system prevents unexpected variations in the control input and reduces the undesirable phenomenon of chattering greatly.

The dynamic equations of the SSSC (2) can be rewritten as:

$$\begin{cases} \frac{di_D}{dt} = f_{i_D} + g_{i_D} v_{seD} + d_{i_D}(t) \\ \frac{di_Q}{dt} = f_{i_Q} + g_{i_Q} v_{seQ} + d_{i_Q}(t) \\ \frac{dv_{dc}^2}{dt} = f_{v_{dc}} + g_{v_{dc}} P_{se} + d_{v_{dc}}(t) \end{cases} \quad (8)$$

with

$$\begin{cases} f_{i_D} = ai_D + \omega_0 i_Q + c(V_{SD} - V_{RD}), \\ f_{i_Q} = ai_Q + \omega_0 i_D + c(V_{SQ} - V_{RQ}), \\ a = -\frac{\omega_0 R_s}{X_s}, b = -\frac{2\omega_0}{C_{dc}}, g_{v_{dc}} = b, f_{v_{dc}} = \frac{b}{R_{dc}}, c = \frac{\omega_0}{X_s}, g_{i_D} = g_{i_Q} = c \end{cases}$$

where $d_{i_D}(t)$, $d_{i_Q}(t)$ and $d_{v_{dc}}(t)$ have been added to (8) to represent system uncertainties. Since g_{i_D} and g_{i_Q} are strictly positive, and $g_{v_{dc}}$ is strictly negative, we can design the sliding-neural controller (V_{seD}) using the dynamic of i_D as:

$$\hat{u}_{V_{seD}}^*(\chi_{i_D}, t) = \Psi(\chi_{i_D}, \hat{w}_{i_D}) + h(S_{i_D}, \theta_{S_{i_D}}), \quad (9)$$

$$\text{with } \begin{cases} \chi_{i_D}^T = (i_D, S_{i_D}, \frac{S_{i_D}}{\epsilon_{i_D}}), \\ \hat{w}_{i_{D_j}} = \text{Proj}[-S_{i_D} \frac{\partial \Psi}{\partial w_{i_{D_j}}} |_{w_{i_{D_j}} = \hat{w}_{i_{D_j}}}], \quad j = 1, \dots, N \\ = \begin{cases} -S_{i_D} \frac{\partial \Psi}{\partial w_{i_{D_j}}} |_{w_{i_{D_j}} = \hat{w}_{i_{D_j}}} & \text{if } |\hat{w}_{i_{D_j}}| < R_{w_{i_D}} \\ 0 & \text{otherwise} \end{cases} \\ S_{i_D} = e_{i_D} + C_{i_D} \int e_{i_D} dt \\ \hat{\theta}_{S_{i_D}} = \text{Proj}[-\gamma S_{i_D} \psi(S_{i_D})] \end{cases}$$

Where $e_{i_D} = i_D^* - i_D$, γ is a positive arbitrary constant and $\text{Proj}(\cdot)$ is the well known projection function on the compact set $\Omega_\omega = \{\omega : \|\omega\| \leq R_\omega\}$; This function guarantees that the estimates $\hat{w}_{i_{D_j}}$ remain bounded, so that the neural network controller error S_{i_D} converges in finite time to the origin.

Remarks.

- The same methodology is applied to design V_{seQ} , and the DC bus voltage controller, by using equation (8)
- The detailed block-diagram of the RBF-Neuro-Fuzzy sliding mode controller proposed in this paper is depicted in Fig. 2.

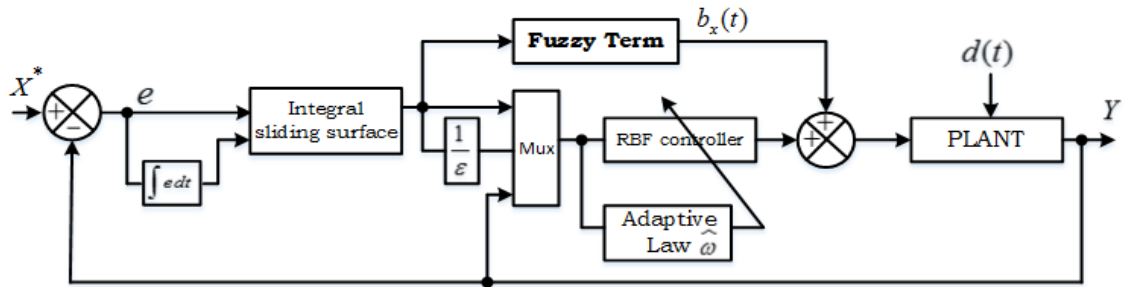

Figure 2. Detailed block-diagram of the RBF-Neuro-Fuzzy sliding mode controller

5.2. Numerical Simulation

The RBF neuro-fuzzy control strategy is evaluated through numerical simulations within the MATLAB/Simulink software for an IEEE 9 bus test system shown in [19]. The fault simulation has been conducted according to the following sequence:

5.2.1. Mode 1: Power flow PQ control

- 1) At $t = 0s$, the system is in pre-fault state;
- 2) At $t = 1s$, step changes in active power (from 0.7769 to 0.85 pu) and reactive power (from -0.0195 to -0.035 pu) occur simultaneously and the system is restored to its pre-fault state at $t = 1.3s$.

5.2.2. Mode 2: Active power control with regulation of DC bus voltage

All test are performed under online variation of the transmission line resistance R_s (up to +40% of its nominal value at time $t = 1.2s$ for mode 1 and for mode 2), and variation of the transmission line inductance X_s (up to +20% of its nominal value at time $t = 1.2s$ for mode 1 and for mode 2).

Since the parameters vary during the operation of power systems, it can be seen that in Fig.3a, the power in transmission line is slightly affected with the proposed controller when the parameters are varied from their nominal values. Comparative results with the direct adaptive neural network controller [16] (RBF-NN) clearly show the superiority of the proposed controller (RBF-F-NS) in terms of robustness, with respect to online variation of the resistance R_s (up to +40%) and inductance X_s (up to +20%).

It can be seen from Fig.4b, Fig.7a that the tracking error with the proposed controller is very small than the direct adaptive neural network controller (RBF-NN) during the contingencies. Fig.6a, shows that the active power in transmission line and DC bus voltage track his reference much better in terms of overshoot and settling time than that of the direct adaptive neural network controller.

It can be noticed that the number of oscillation to settling time in the case of proposed controller is less than that of the direct adaptive neural network controller for the voltages of bus 7 and 8 (see Fig.6b). Fig.5b and Fig.7b shows the behavior of the control inputs of SSSC during step change.

From the simulations results, it can be seen globally that the hybrid controller automatically adapts to changes in the system operating conditions and hence provides better performances unlike the direct adaptive neural network controller whose performances are degraded for such changes.

5.3. Mathematical challenges for future developments

Though interesting results have been obtained using the proposed method, some mathematical challenges need to be addressed:

- It will be more interesting to find new algorithms for simultaneously optimizing the widths, centers and weights without requiring the knowledge of the bounds of the RBF input vector elements

- When a permanent fault affects a single phase, the stability is reduced, then the continuity of the service system is greatly affected. Achieving a high level continuity of electric power under permanent contingencies remains an open and non-properly solved problem.

6. Conclusion

In this work, the major problems which undermine the energy sector in Africa are identified and some solutions to the energy challenges are proposed, with more emphasis

given both to the exploitation of appropriate applied mathematics tools as shown in the case studied, and the new governance policies.

The design and implementation of an efficient SCADA with complete automation of the operation for sub-saharan Africa region power network is suggested. For decentral-

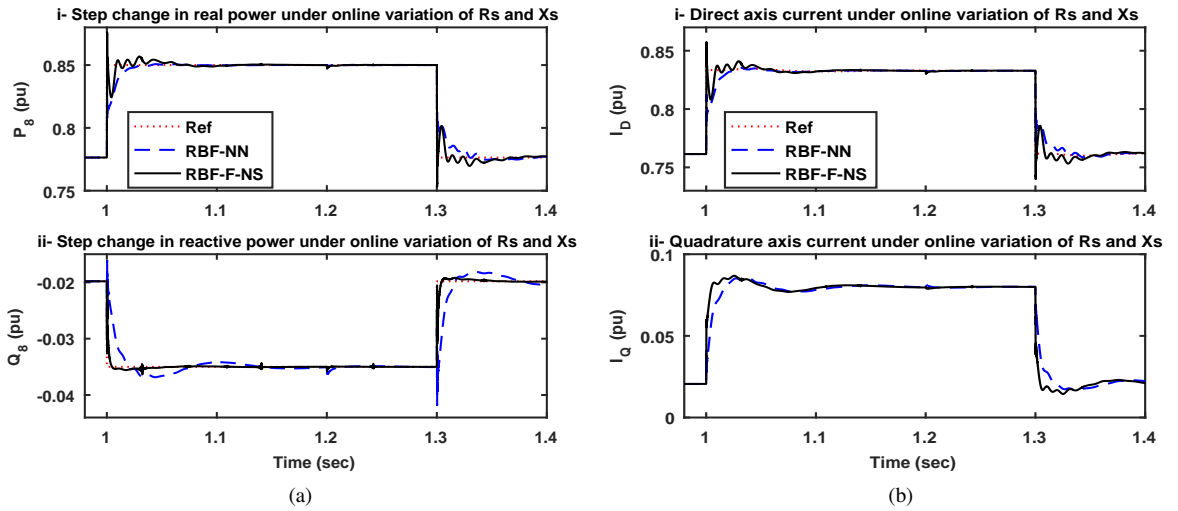

Figure 3. Mode 1: Control response to step changes in real and reactive powers of the transmission line under online variation of R_s (up to +40%) and online variation of X_s (up to +20%). (a) Active and reactive power in the transmission line (b) DQ currents

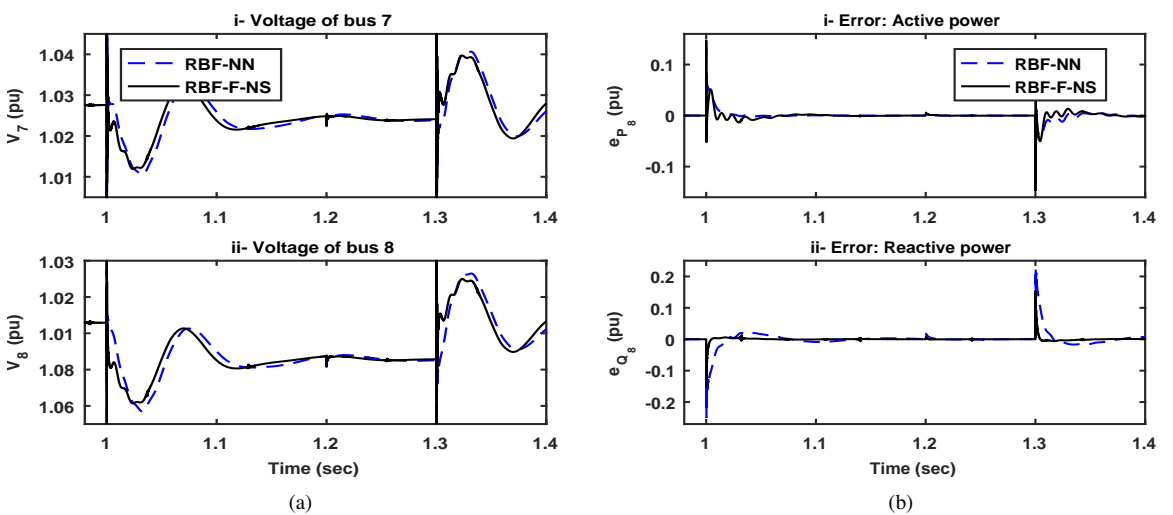

Figure 4. Mode 1: Control response to step changes in real and reactive powers of the transmission line under online variation of R_s (up to +40%) and online variation of X_s (up to +20%). (a) Voltage of bus 7 and 8 (b) Error of direct axis and quadrature axis current

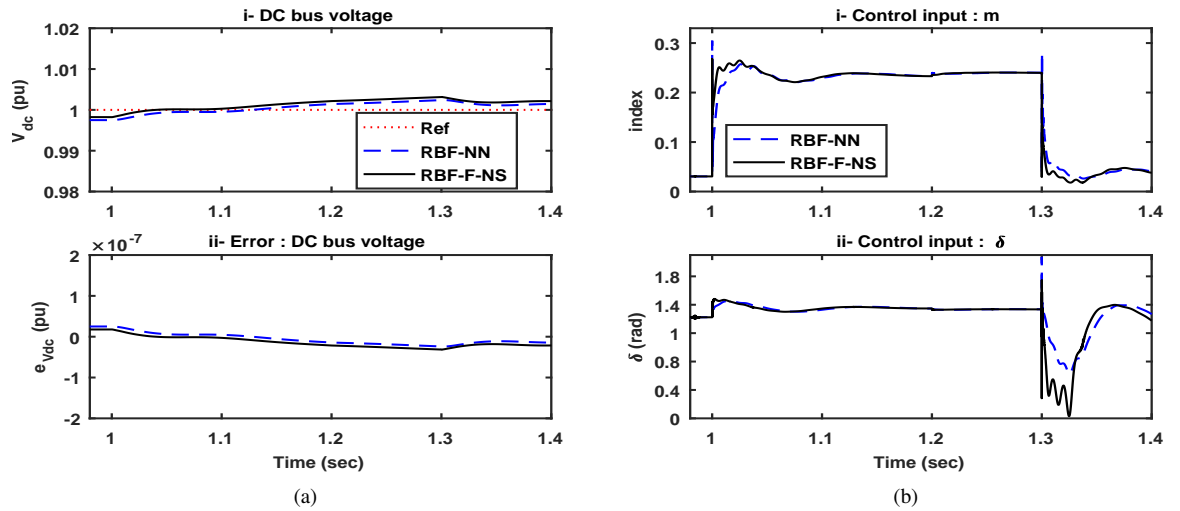

Figure 5. Mode 1: Control response to step changes in real and reactive powers of the transmission line under online variation of R_s (up to +40%) and online variation of X_s (up to +20%). (a) DC bus voltage of SSSC (b) Control input of SSSC

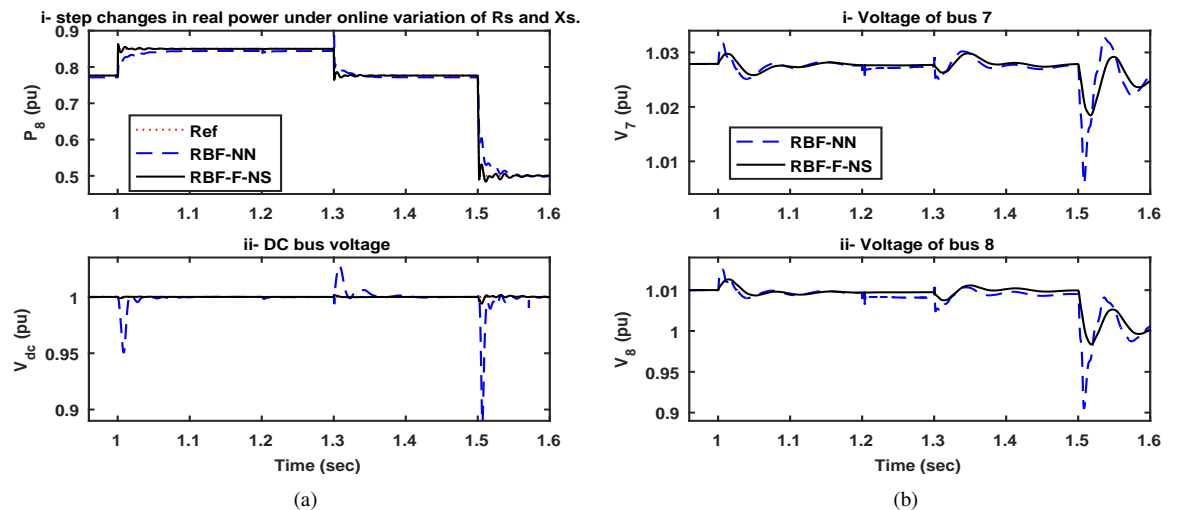

Figure 6. : Mode 2: Control response to step changes in real and reactive powers of the transmission line under online variation of R_s (up to +40%) and online variation of X_s (up to +20%). (a) Active power in the transmission line and DC bus voltage of SSSC (b) Voltage of bus 7 and 8

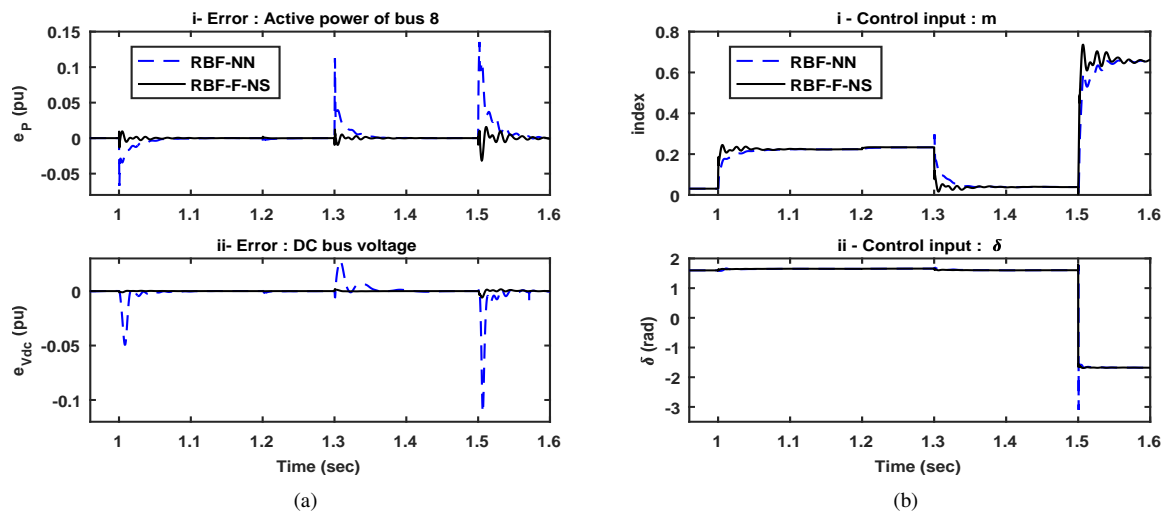

Figure 7. : Mode 2: Control response to step changes in real and reactive powers of the transmission line under online variation of R_s (up to +40%) and online variation of X_s (up to +20%). (a) Error of DC bus voltage and Active power Error of bus 8 (b) Control input of SSSC

ized control, the feasibility of real time coordination between subsystems is still a major challenge since these subsystems are interconnected in wide geographical areas. It will be more interesting to the electrical power system company to integrate recent applied mathematical results for more safety and efficiency energy production and management in the context of the upcoming deregulated electricity market.

The starting point of the implementation of new controllers in the applications of power systems in Sub-Saharan Africa could be done using improved PID regulators.

7. References

- [1] BOB DUDLEY, SPENCER DALE, "BP Statistical Review of World Energy 2018 ", 2018.
- [2] J.P. FAVENNEC, C. ADEDJOUNON, B. DUHAMEL, J. GIRI, H. GILLES, A. TRONCHE, "L'énergie en Afrique à l'horizon 2050" *Rapport Agence Française de Développement et Banque Africaine de Développement*, 2009.
- [3] J.D.D. NGUIMFACK-NDONGMO, "Contribution la commande du SSSC et des génératrices asynchrones à double alimentation pour l'amélioration de la stabilité transitoire des systèmes de puissance", *Thèse de Doctorat/Ph.D. LETS, LAIA, Faculté des Sciences, Université de Dschang, Cameroun, soutenue le 25 juin 2016*, 2016.
- [4] BM-RAPPORT BANQUE MONDIALE, "La crise de l'électricité en Afrique: Explication des paradoxes", *Perspectives économiques régionales: Afrique sub-saharienne, Fonds Monétaire International*, Washington DC, 2008.
- [5] S. GSÄNGER , J.D. PITTELOUD , "World Wind Energy Association Report", *WWEA Head Office Bonn*, 2012.
- [6] M.S. MAHMOUD , N.M. ALYAZIDI , M.I. ABOUHEAF , "Adaptive intelligent techniques for microgrid control systems: A survey", *International Journal of Electrical Power and Energy Systems*, vol. 90, 2017, pp. 292 - 305.

- [7] M. LAKSHMI, S. HEMAMALINI, "Decoupled control of grid connected photovoltaic system using fractional order controller", *Ain Shams Engineering Journal*, In Press, 2016.
- [8] L.I. MINCHALA-AVILA, L. E. GARZA-CASTANON, A. VARGAS-MARTINEZ, YOUMIN ZHANG, "A Review of Optimal Control Techniques Applied to the Energy Management and Control of Microgrids, 5th International Conference on Sustainable Energy Information Technology (SEIT 2015)", *Procedia Computer Science*, vol. 52, 2015, pp. 780-787.
- [9] J. M. GUERRERO, J. C. VASQUEZ, J. MATAS, L. G. DE VICUA, M. CASTILLA, "Hierarchical control of droop-controlled AC and DC microgrids - A general approach toward standardization", *IEEE Trans. Ind. Electron*, vol. 58, 2011, pp. 158-172.
- [10] H. BOUATTOUR, J. W. SIMPSON-PORCO, F. DORFLER, F. BULLO, "Article Title", *52nd IEEE Conf. Decis. Control*, 2013, pp. 1514-1519.
- [11] Q. SHAFIEE, J. M. GUERRERO, J. C. VASQUEZ, "Distributed secondary control for islanded microGrids - A novel approach", *IEEE Trans. Power Electron*, vol. 29, 2014, pp. 1018-1031.
- [12] Y. WASA, K. SAKATA, K. HIRATA, KENKO UCHIDA, "Differential Game-based Load Frequency Control for Power Networks and Its Integration with Electricity Market Mechanisms", *Proceeding of the 2017 IEEE Conference on Control Technology and Applications*, 2017
- [13] L. BANGJUN, F. SHUMIN , "A brand new nonlinear robust control design of SSSC for transient stability and damping improvement of multi-machine power systems via pseudo-generalized hamiltonian theory.", *Control Engineering Practice*, vol. 29, 2014, pp. 147-157.
- [14] L. DONG, M. CROW, Z. YANG, C. S. MEMBER, L. ZHANG, S. ATCITY, "A Reconfigurable FACTS System for University Laboratories", *IEEE transactions on power systems*, vol. 19, 1, 2004, pp. 120-128.
- [15] G. KENNE, A. FOTSO SIMO, LAMNABHI-LAGARRIGUE F, "A new adaptive control strategy for a class of nonlinear system using RBF neuro-sliding mode technique: Application to SEIG wind turbine control system.", *International Journal of Control*, 2016.
- [16] S. GE , C. WANG , "Direct adaptive NN control of a class of nonlinear systems", *IEEE Tras. On Neural Networks*, vol. 13, 2002, pp. 214-221.
- [17] F. JUNTAO , H. DING , "Adaptive sliding mode control of dynamic system using rbf neural network", *Nonlinear Dynamics*, vol. 70, 2012, pp. 1563-1573.
- [18] C. HUA, C. YU, X. GUAN, "Neural network observer-based networked control for a class of nonlinear systems", *Neurocomputing*, vol. 133, 2014, pp. 103-110.
- [19] P.M. ANDERSON , A.A. FOUAD , "Power system control and stability.", *IEEE Press*, 1994.