



HAL
open science

Modifying a biologically inspired retina simulator to reconstruct realistic responses to moving stimuli

Selma Souihel, Bruno Cessac

► **To cite this version:**

Selma Souihel, Bruno Cessac. Modifying a biologically inspired retina simulator to reconstruct realistic responses to moving stimuli. Conference Cauca, Jun 2017, Fréjus, France. hal-01638104

HAL Id: hal-01638104

<https://inria.hal.science/hal-01638104>

Submitted on 19 Nov 2017

HAL is a multi-disciplinary open access archive for the deposit and dissemination of scientific research documents, whether they are published or not. The documents may come from teaching and research institutions in France or abroad, or from public or private research centers.

L'archive ouverte pluridisciplinaire **HAL**, est destinée au dépôt et à la diffusion de documents scientifiques de niveau recherche, publiés ou non, émanant des établissements d'enseignement et de recherche français ou étrangers, des laboratoires publics ou privés.

Modifying a biologically inspired retina simulator to reconstruct realistic responses to moving stimuli

Selma Souihel, Bruno Cessac
selma.souihel@inria.fr, bruno.cessac@inria.fr

Abstract

The visual system constantly uses anticipation in everyday life, to compensate for the 30 to 150-ms delay that exists between the perception of a visual stimulus and the neural responses it elicits. Without this anticipation, a tennisman, for instance, would be unable to hit a moving ball. Neurobiologists first believed that the anticipation only happens in the visual cortex, but recent studies have shown that it starts earlier, in the retina. To better understand the state of the art and possibly propose new experiments, we are working on a retina simulator reproducing anticipation. Ultimately, we would like to use our reconstructed retina spike trains as inputs to a primary visual cortex simulator, and understand all the mechanisms lying behind anticipation. This work is done within the ANR project : Trajectory.

Retina Simulator [3]

Virtual Retina is a software able to convert a visual scene into spike trains similar to those transmitted by the retina to the brain. It uses a three-processing-stage model mimicking photoreceptors, bipolar cells and ganglion cells.

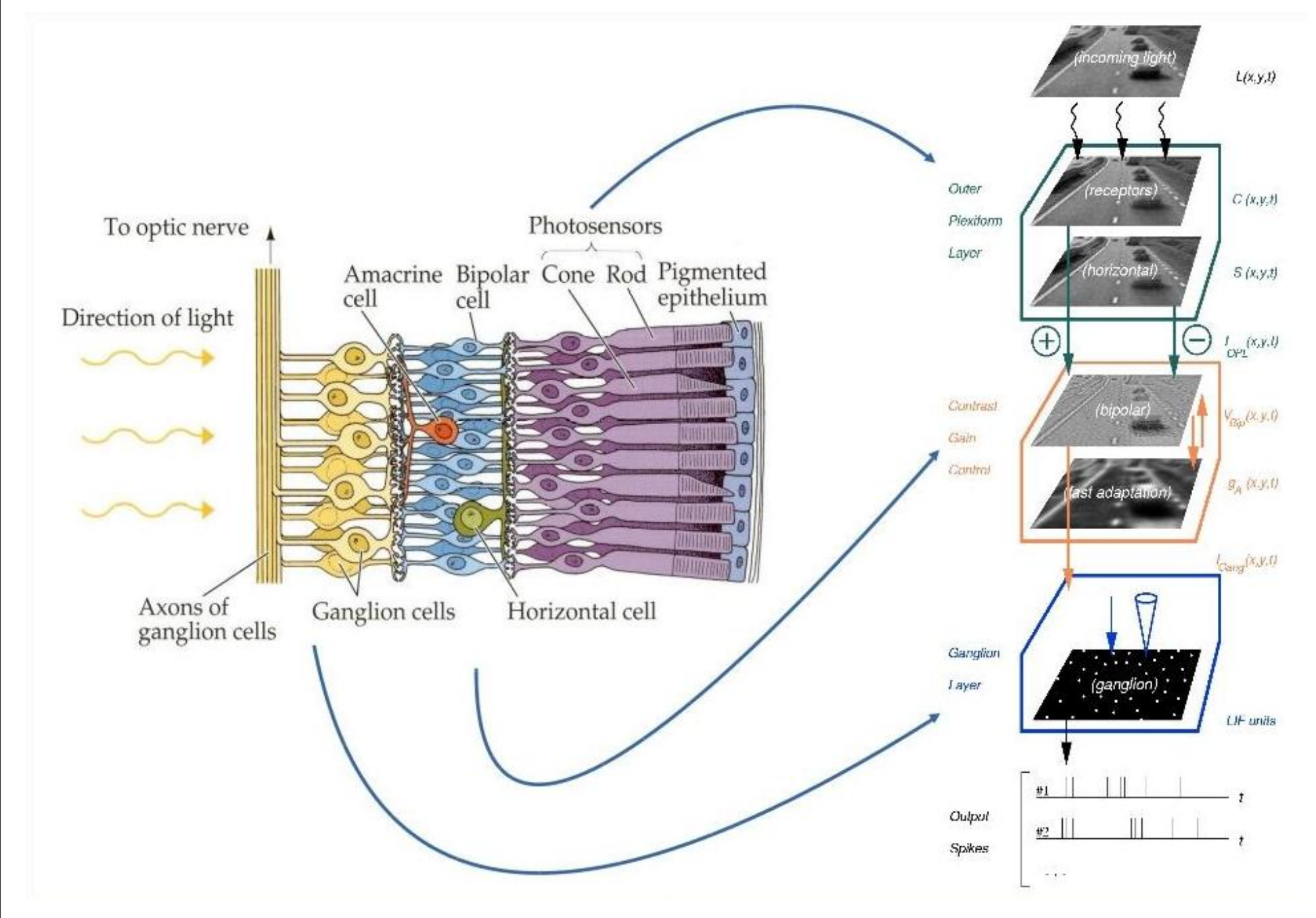

Gain control mechanism [2]

Chen's & al. model contains two layers : bipolar and ganglion cells. Both layers implement a gain control mechanism through a feedback loop.

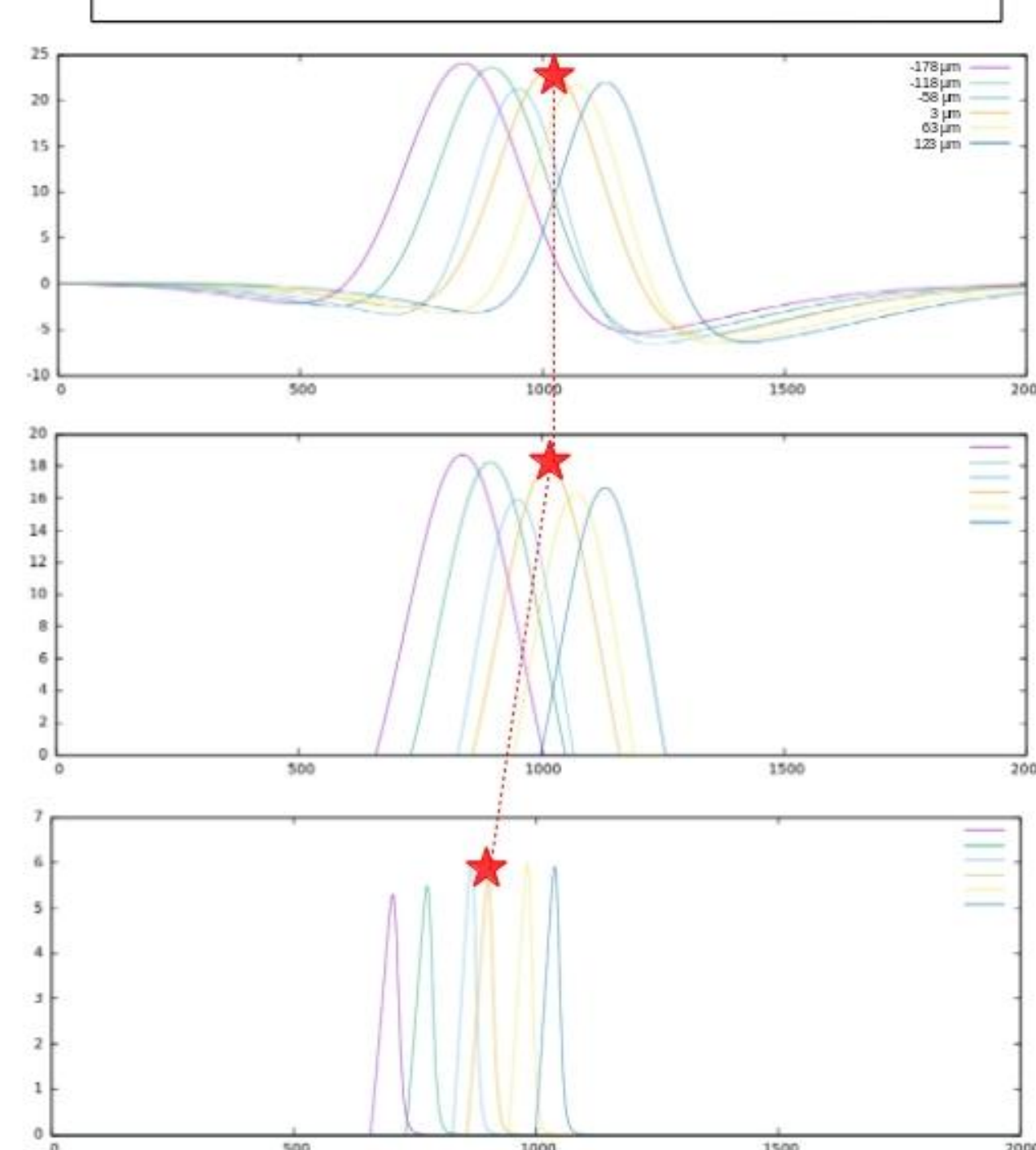
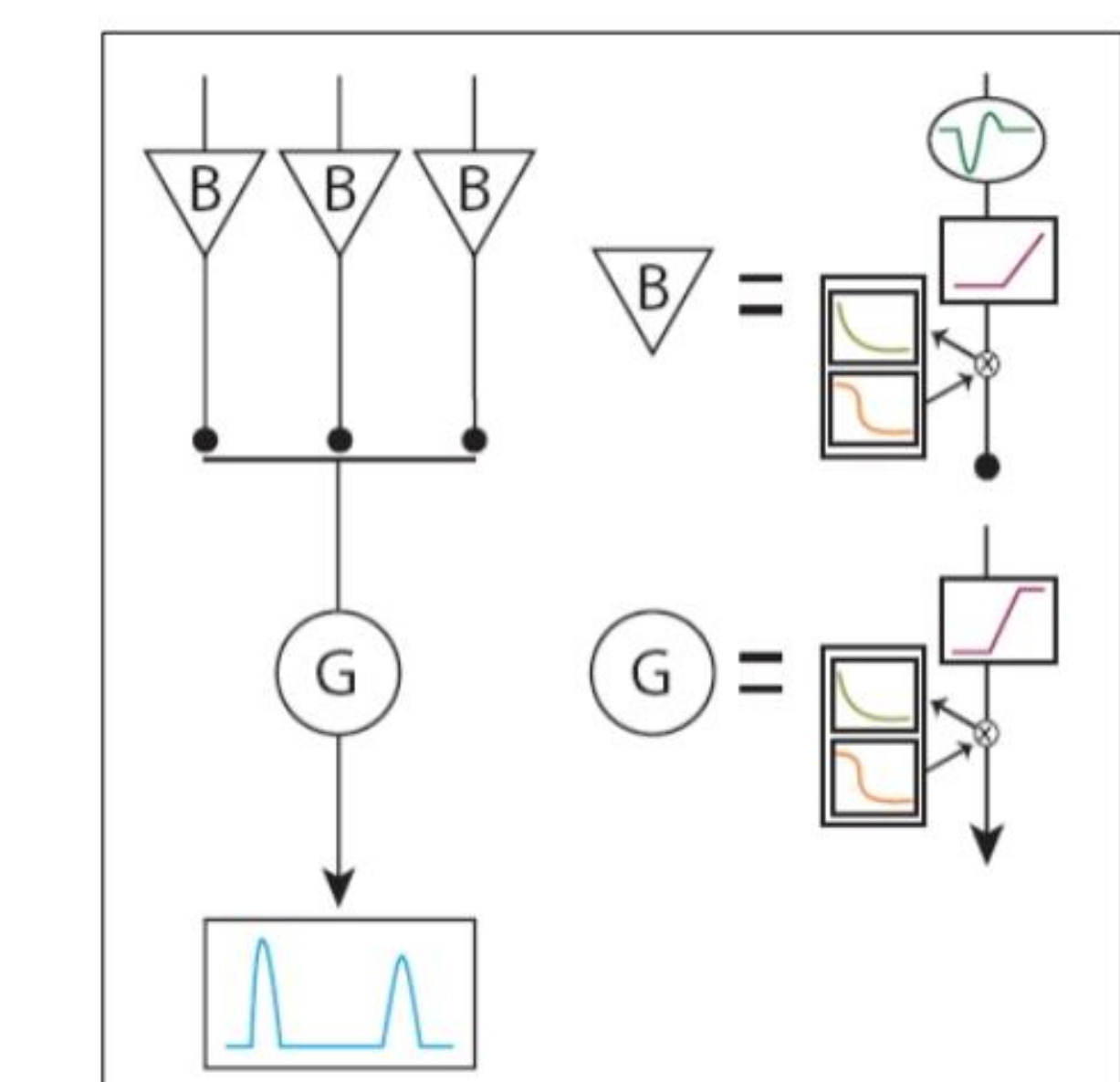

Threshold Adaptation

Generating impulses at the level of ganglion cells relies on the leaky integrate and fire model discretisation. Its general equation is given by :

$$V(t+1) = \gamma V(t) + J_L dt + J(t) dt$$

$$\text{with } \gamma = 1 - \frac{dt}{\tau_L}$$

For $I(n) = I$ constant, the threshold below which the potential equation holds is the following :

$$\theta = V_L + (1 - \gamma^{t+1}) \frac{I}{g_L}$$

Adaptation of the threshold is then given by :

$$\theta = V_L + (1 - \gamma^{\frac{1000}{R_G(t)} + 1}) \frac{I}{g_L}$$

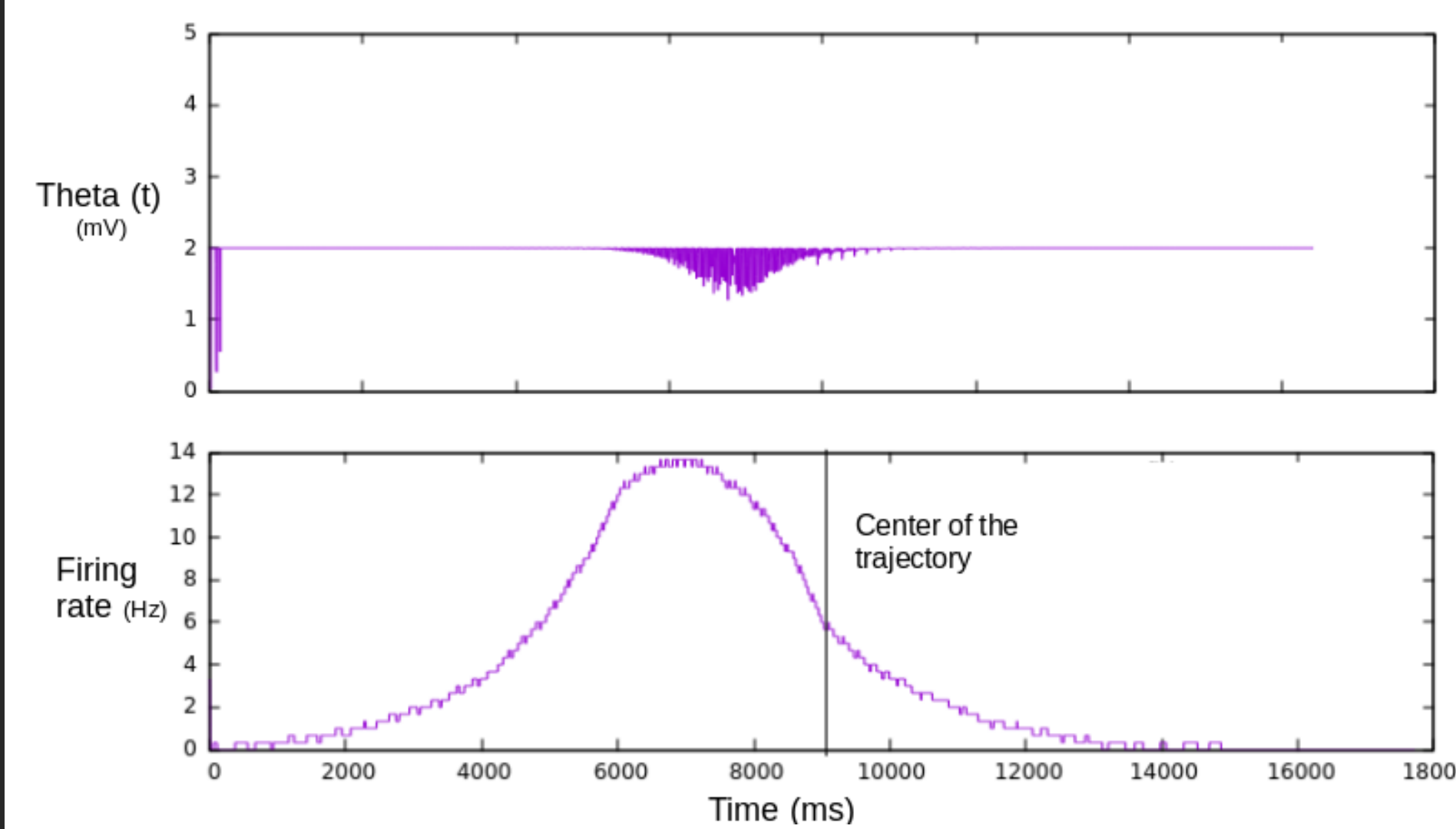

Moving bar results

Our implementation of the model recovers the anticipatory effect occurring in the case of smooth motion, as the shifted pic of response appears before the bar reaches the center of the receptive field. The alert response has also been reproduced, with an amplitude higher than smooth motion's or motion onset's. Finally, the motion onset effect appears in the fact that this type of stimulus elicits stronger response than smooth motion, shorter in time.

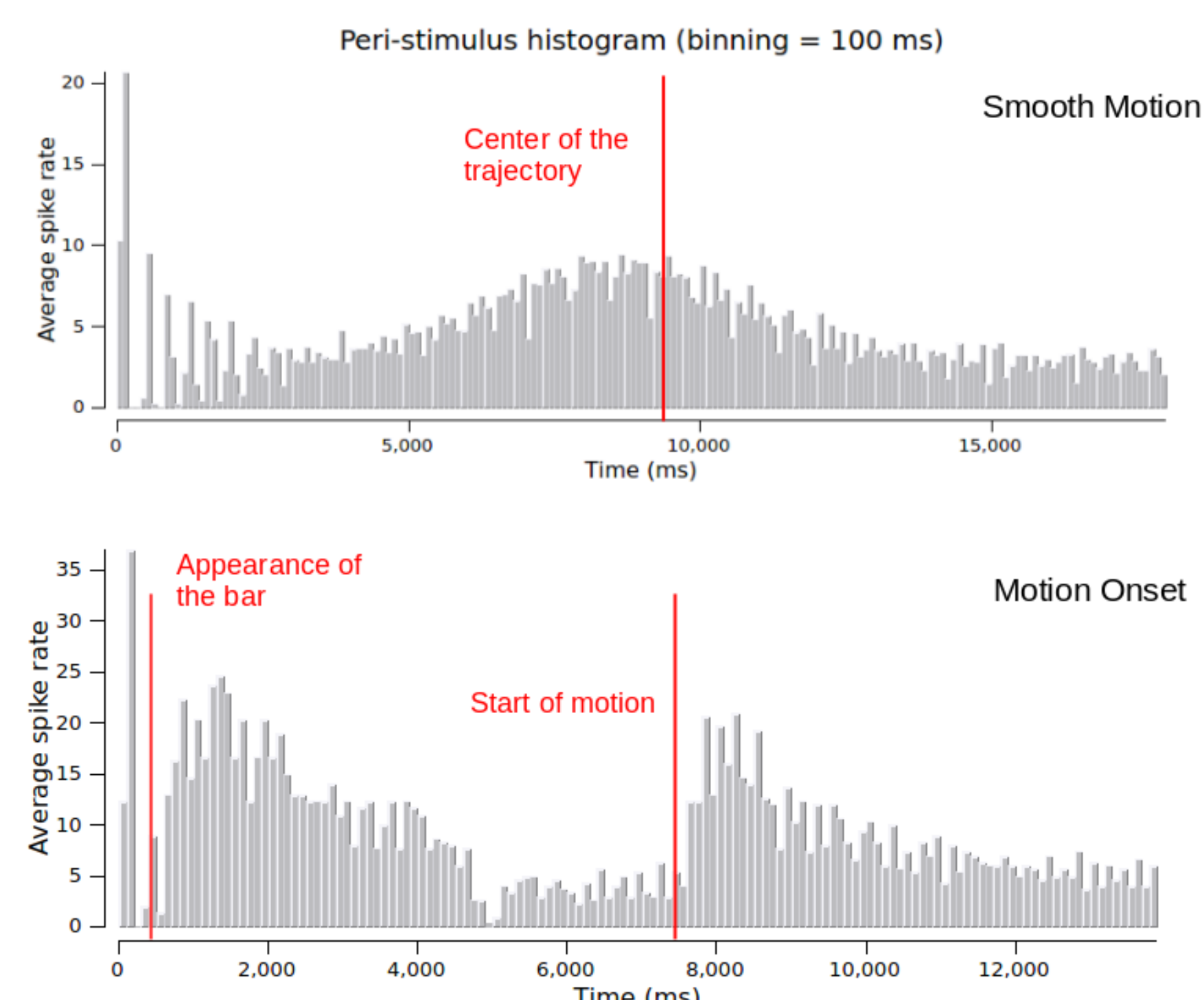

The results below show the neuronal activity in the case of smooth motion. The anticipation is reproduced though there is a strong inhibitory effect following the bar motion.

Stimulus						
Retina reconstruction						
Time stamps	3000 ms	3100 ms	5500 ms	10500 ms	14500 ms	15300 ms

Anticipating a car trajectory

We used a reconstruction algorithm to rebuild the stimulus from the obtained spike trains. The results show the original stimulus in pink and the activity it elicits in blue.

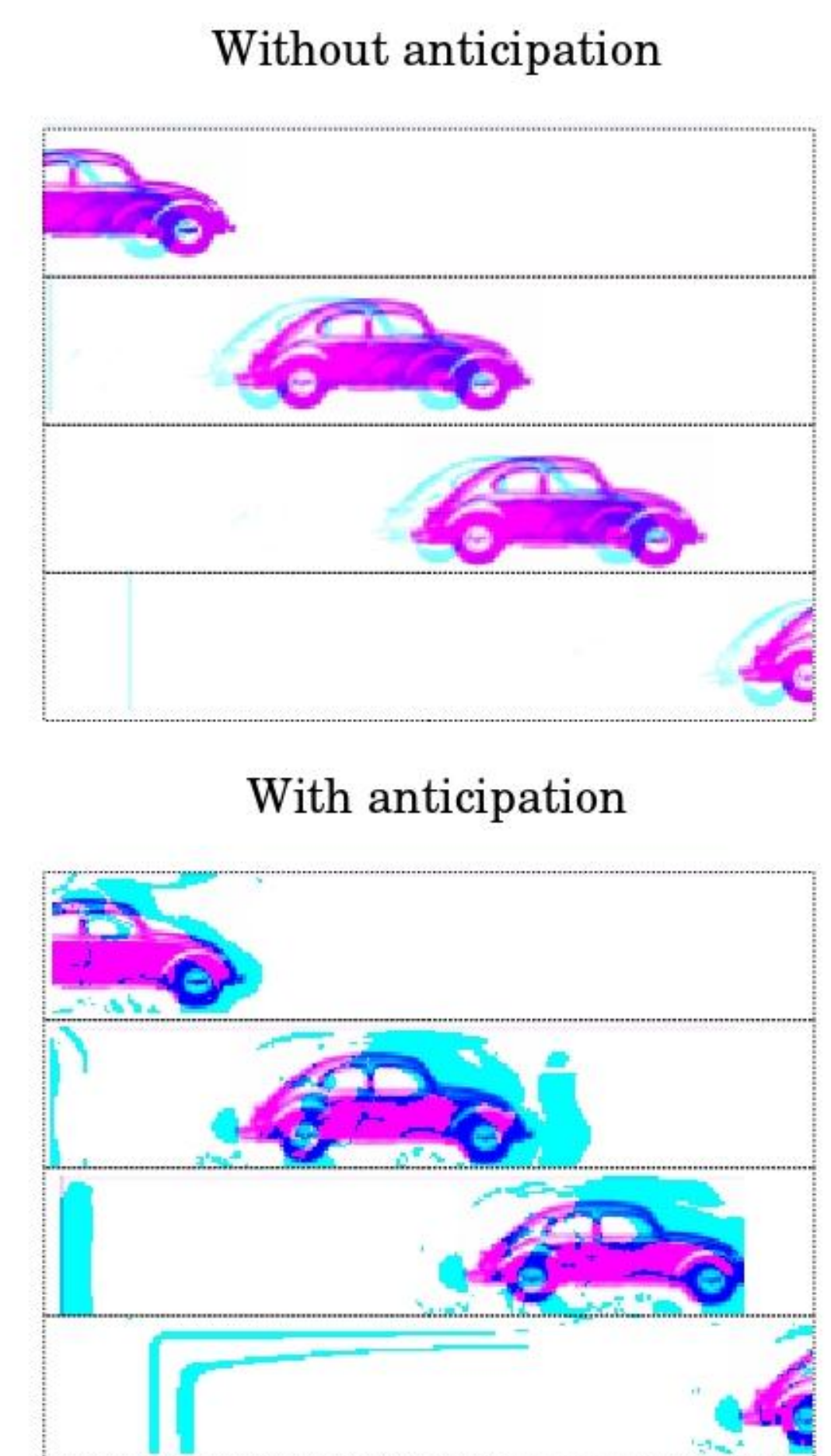

Conclusion & future work

- The gain control as implemented enabled us to reproduce simple motion features; anticipation, alert response and motion onset.
- The model has however an effect on the object form, as shown in the car trajectory results.
- Next step will be to improve the model in a way to denoise the reconstruction.
- More complex stimuli require the implementation of connectivity.
- Our current work aim to develop a biologically inspired model of connectivity.

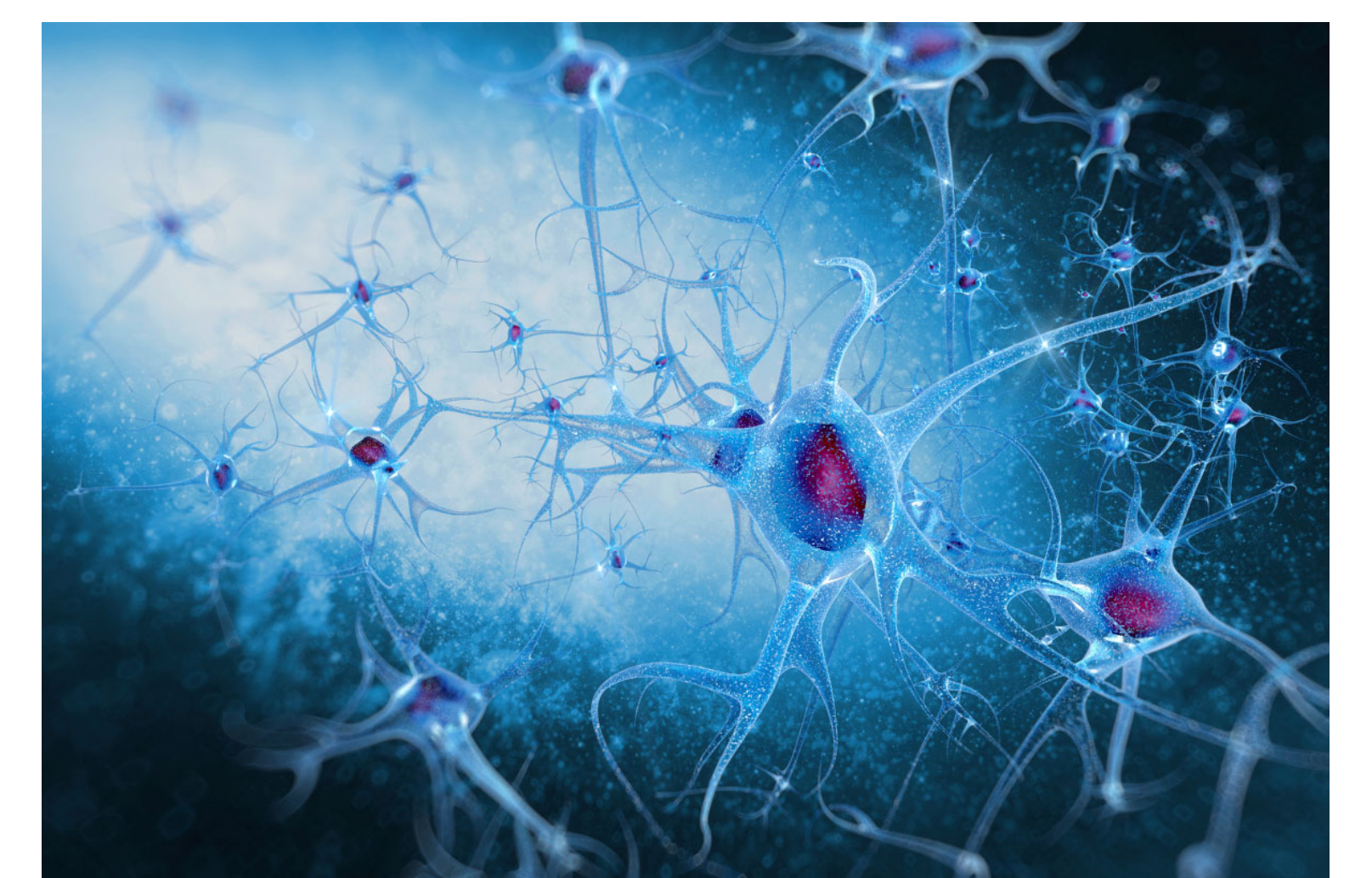

Acknowledgement

This research is entirely supported by Agence National de la Recherche. We would like to thank our ANR collaborators, Olivier Marre from Institut De la Vision and Frederic Chavane from Institut des Neurosciences de la Timone for their significant help and their insightful suggestions.

References

- [1] Michael J. Berry, Iman H. Brivanlou, Thomas A. Jordan & Markus Meister: *Anticipation of moving stimuli by the retina*, Nature (1999)
- [2] Eric Y. Chen, Olivier Marre, Clark Fisher, Greg Schwartz, Joshua Levy, Rava Azeredo da Silveira, & Michael J. Berry: *Alert Response to Motion Onset in the Retina*, The Journal of Neuroscience (2013)
- [3] Adrien Wohrer & Pierre Kornprobst : *Virtual Retina, a biological retina model and simulator, with contrast gain control*, Journal of Computational Neuroscience(2009)