



HAL
open science

Modeling and Performance Analysis of Giant Magnetostrictive Microgripper with Flexure Hinge

Qinghua Cao, Quanguo Lu, Junmei Xi, Jianwu Yan, Changbao Chu

► **To cite this version:**

Qinghua Cao, Quanguo Lu, Junmei Xi, Jianwu Yan, Changbao Chu. Modeling and Performance Analysis of Giant Magnetostrictive Microgripper with Flexure Hinge. 4th Conference on Computer and Computing Technologies in Agriculture (CCTA), Oct 2010, Nanchang, China. pp.237-245, 10.1007/978-3-642-18369-0_27 . hal-01564890

HAL Id: hal-01564890

<https://inria.hal.science/hal-01564890>

Submitted on 19 Jul 2017

HAL is a multi-disciplinary open access archive for the deposit and dissemination of scientific research documents, whether they are published or not. The documents may come from teaching and research institutions in France or abroad, or from public or private research centers.

L'archive ouverte pluridisciplinaire **HAL**, est destinée au dépôt et à la diffusion de documents scientifiques de niveau recherche, publiés ou non, émanant des établissements d'enseignement et de recherche français ou étrangers, des laboratoires publics ou privés.



Distributed under a Creative Commons Attribution 4.0 International License

Modeling and Performance Analysis of Giant Magnetostrictive Microgripper with Flexure Hinge

Qinghua Cao, Quanguo Lu, Junmei Xi, Jianwu Yan and Changbao Chu,

Institute of Micro/nano Actuation and Control, Nanchang Institute of Technology,
Nanchang, P. R. China
qh9863@126.com

Abstract. In order to improve the steady output of micgripper, the giant magnetostrictive micgripper with flexure hinge is taken as the research object . Its structure and working principle are presented .the static performance experiments are done and the better linear work domain is found. On the basis of that the dynamic model of the microgripper is established and the formula of the microgripper's output displacement is deduced. the relationship between the microgripper's parameters and responses are analyzed and open-loop simulation step is done, The simulation results show the giant magnetostrictive material(GMM) rod damp effects on the response time and its quality has little influence.

Keywords: Giant magnetostrictive micgripper, Flexure hinge, Dynamic model, Open-loop simulation step

1 Introduction

Microgripper[1] fulfils the core role in fine handling micro- parts, which can convert other power into mechanical energy. In recent years, the research of the micgripper are concentrated in two respects with the rapid development of tiny technology : One is the drive mode, for example electrostatic microgripper , thermally driven microgripper [2], piezoelectric driven microgripper [3], shape memory alloy microgripper [4], and vacuum adsorption microgripper, etc. on the other hand, Many studies have been conducted to develop microgripper technology.

In this study, the giant magnetostrictive micgripper with flexure hinge is taken as the research object . the static performance experiments are done and the better linear work domain is found. On the basis of that the dynamic model of the microgripper is established and open-loop simulation step is done.

2 Structure and Static Performance Experiments

2.1 Structure Design of the Microgripper

Magnetostrictive microgripper is a new microgripper[5], which is produced by GMM doing work through the stretching deformation of it in changed magnetic field. Fig. 1 shows a conceptual drawing of the microgripper proposed in this study.

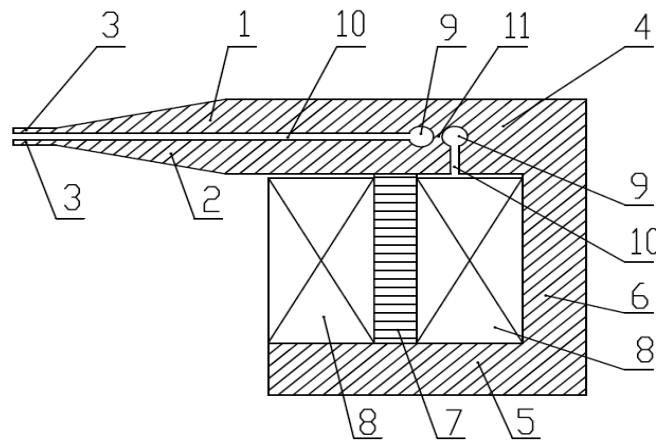

- 1.palate 2.microgripper jaw 3.JAW
4. uppersuspensionarm
5. suspensionarm 6. linker arm 7.GMM
8. Electromagnetic coil 9. Circular hole 10. Slice
11. Flexure hinge

Fig.1. Conceptual drawing of microgripper.

The principle of operation of the proposed microgripper is as follows: firstly, GMM is placed between the microgripper jaw and the suspensionarm, A magnetic circuit is formed through the microgripper jaw , uppersuspensionarm, linker arm, suspensionarm, GMM. When the controlled current is flowing into the electromagnetic coil to produce magnetic field, GMM produces stretching deformation. Secondly, Deformation can promote the microgripper jaw around the flexible hinge towards the direction of palate, so that the JAW produces microdisplacement to clamping objects.

2.2 Static Performance Experiments

The PC machine is adopted in the measurement and control system, digital signals which PC generate converted into analog voltage signals by PCI-8333D/A, which input to the controllable constant current source. the coil is driven from current source so that the magnetic field strength around the rod is altered, the GMM rod produces magnetostrictive deformation in order to provide microgripper driving, accordingly, displacement and clamping force of JAW is generated. Experimental system is placed on vibration isolation platform in order to reduce effect of the ground vibration. At the same time, environmental humidity and temperature stability are to meet the requirement of experiment. experimental In-kind photo is shown in Fig 2.

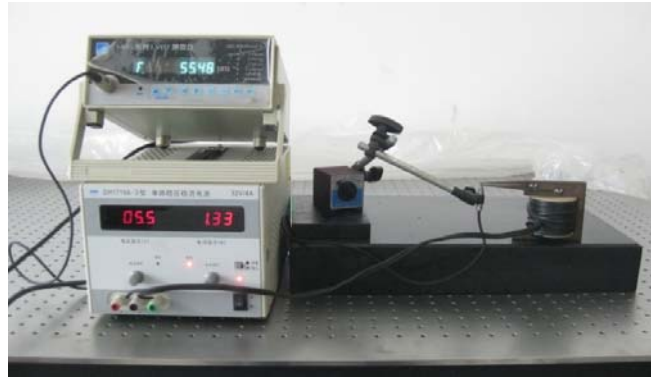

Fig. 2. experimental In-kind photo

The controlled current began to increase from 0 to 4A, experimental curve is drawn, which are shows in Fig .3. There is the characteristic of large-time delay of the giant magnetostrictive material(GMM) , the linear degrees are relatively poor, to simplify the mathematics model, the better linear work domain for 0.6 ~ 1. 5A is found by the test and analysis

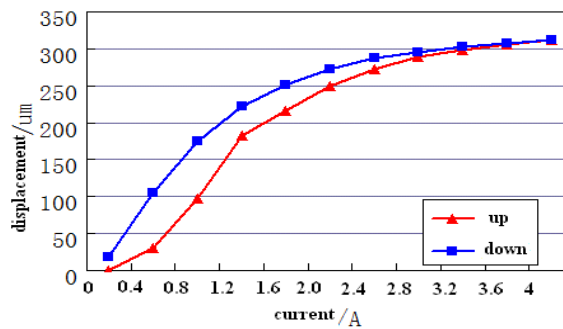

Fig.3. static performance experiments

3 Displacement-current Modle of the Microgripper

3.1 The Linear Model of GMM

Under the environment of steady current, the GMM rod is elongated due to the magnetic field, which generate driving force f_q and elastic restoring force f_h , Supposed the rod as an ideal elastomer, x is the rod elongation, according to Hooker's theory, elastic restoring force function f_h can be expressed as:

$$f_h = K_{GMM} x \quad (1)$$

Where K_{GMM} is the rod stiffness coefficient, From mechanics of materials ,function K_{GMM} is defined as:

$$K_{GMM} = \frac{E_1 A}{l_m} \quad (2)$$

Where E_1 is Young's modulus of the length direction , A is cross-sectional area and l_m is the rod length.

Neglecting the other force, force diagram is described in Fig. 4.

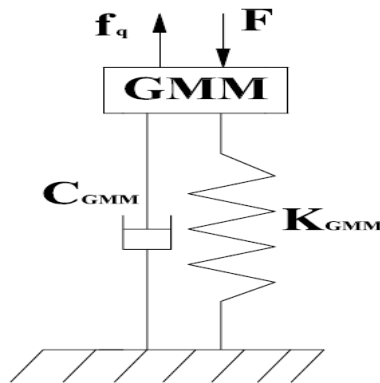

Fig. 4. Force diagram of GMM

In the light of d'Alembert's principle, function F can be written as:

$$F = f_q - K_{gmm} x - C_{gmm} \dot{x} - M_{gmm} \ddot{x} \quad (3)$$

Where F is the force which the rod is received from the microgripper jaw.

Overlooking the temperature change, and only considering the axial deformation the length, literature describes the following linear piezomagnetic equation:

$$\varepsilon = \frac{\sigma}{E_1} + dH \quad (4)$$

$$B = d\sigma + \mu H \quad (5)$$

Where ε is the total axial strain, d is piezomagnetic coefficient, μ is magnetic permeability and H is Magnetic field strength.

Both sides of (4) are multiplied by the rod length l_m , the rod elongation function x can be expressed as:

$$x = \frac{\sigma \cdot l_m}{E_1} + d \cdot H \cdot l_m \quad (6)$$

According to Ampere's theorem, the magnetic field around rod is uniform magnetic field, and magnetic field strength at electromagnetic coil center is approximately equal to the average intensity of rod, one can get the following relations:

$$NI = K_{coil} H l_m \quad (7)$$

Where K_{coil} is the compensatory coefficient of the driven coil.

Substituting (7) into (6) and rearranging gives:

$$x = \frac{\sigma \cdot l_m}{E_1} + \frac{d \cdot NI}{K_{coil}} \quad (8)$$

Substituting (1),(2),(6),(8) into (3), function F can be rewritten as follows:

$$F = \frac{E_1 A d N}{K_{coil} l_m} i - K_{gmm} x - C_{gmm} \dot{x} - M_{gmm} \ddot{x} \quad (9)$$

Where reference [6] is cited, driving force function f_q is implemented as:

$$f_q = \frac{E_1 \cdot A \cdot d \cdot N}{l_m} I$$

3.2 The Design of Flexure Hinge

The structure of Flexible hinge is shown in Figure 5, where t is the minimum thickness of flexible hinge, $a = t + 2R - 2R\cos\theta$ is infinitesimal thickness, $du = d(R\sin\theta)$ is the infinitesimal length, around the z -axis the moment of inertia function[7] $I_z = ba^3/12$.

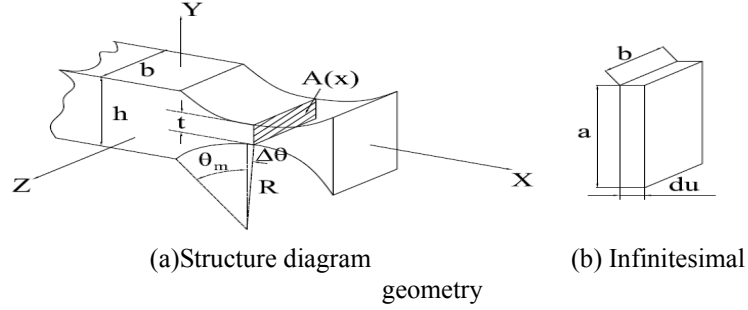

Fig.5. Analysis of flexible hinge

Supposing deformation of flexible hinge is pure bending, ignoring angular displacement except the flexible hinge, E_2 is Young's modulus of the microgripper, the deflection angle function α_z as follows:

$$\alpha_z = \int_z \frac{M_z(x) dx}{E_2 I_z(x)} = \int_{-\theta_m}^{\theta_m} \frac{12M_z R \cos \theta}{E_2 b(t + 2R - 2R \cos \theta)^3} d\theta$$

Here $s = R/t$, function α_z can be rewritten as:

$$\begin{aligned} \alpha_z &= \frac{12M_z}{E_2 b R^2} \int_{-\theta_m}^{\theta_m} \frac{\cos \theta}{(t + 2R - 2R \cos \theta)^3} d\theta \\ &= \frac{12M_z}{E_2 b R^2} \int_{-\theta_m}^{\theta_m} \frac{\cos \theta}{(s + 2 - 2 \cos \theta)^3} d\theta \end{aligned}$$

Torsional stiffness of flexible hinge function k can be derived as follows:

$$k = \frac{M_z}{\alpha_z} = \frac{E_2 b R^2}{12 \int_{-\theta_m}^{\theta_m} \frac{\cos \theta}{(s + 2 - 2 \cos \theta)^3} d\theta} = \frac{E_2 b R^2}{12f} \quad (10)$$

Where

$$\begin{aligned}
f &= \int_{-\theta_m}^{\theta_m} \frac{\cos \theta}{(s + 2 - 2 \cos \theta)^3} d\theta \\
&= \frac{8s^4(2s+1)\tan \frac{\theta_m}{2}}{(4s+1)^2 \left[1 + (4s+1)\tan^2 \frac{\theta_m}{2} \right]^2} \\
&\quad + \frac{4s^3(6s^2+3s+1)\tan \frac{\theta_m}{2}}{(4s+1)^2 \left[1 + (4s+1)\tan^2 \frac{\theta_m}{2} \right]} \\
&\quad + \frac{12s^4(2s+1)}{(4s+1)^{5/2}} \arctan \left(\sqrt{4s+1} \tan \frac{\theta_m}{2} \right)
\end{aligned}$$

According to principles of Action and Reaction, force of the microgripper received from GMM is equal to the force of microgripper jaw acting on the GMM, F is external force of the flexible hinge, Leverage model simplified from flexible hinge is shown in Fig.6.

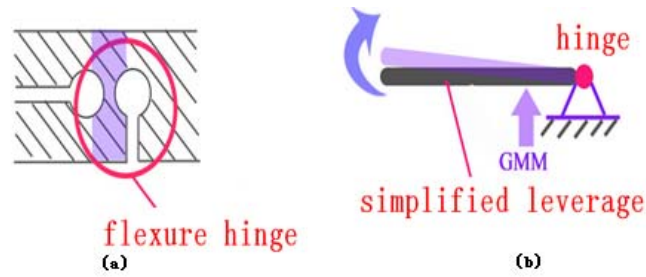

Fig.6. Leverage model (b) simplified from flexible hinge (a)

Because the rod elongation x is very small, the angle of leverage rotation $\theta = \frac{x}{m}$, where m is distance from the rod to the hinge simplified. Stored elastic energy A_θ of the flexible hinge can be expressed as: $A_\theta = \frac{1}{2}k\theta^2$, elastic energy A_θ is equal to work done from force F , work function A can be defined as: $A = fx$, force F can be rewritten again:

$$F = \frac{kx}{m^2} \quad (11)$$

Substituting (10),(11) into (9) and rearranging gives:

$$M_{gmm} \ddot{x} + C_{gmm} \dot{x} + (K_{gmm} + \frac{K}{m^2})x = \frac{E_1 AdN}{K_{coil} l_m} i \quad (12)$$

3.3 Displacement of JAW

According to leverage shown in Fig.4, one can get the following relations:

$$\frac{y}{h} = \frac{x}{m} \quad (13)$$

Where h is the distance from JAW to the hinge, y is the displacement of JAW. Substituting (12) into (14) and rearranging gives:

$$\frac{m}{h} M_{gmm} \ddot{y} + \frac{m}{h} C_{gmm} \dot{y} + \frac{m}{h} (K_{gmm} + \frac{K}{m^2})y = \frac{E_1 AdN}{K_{coil} l_m} i \quad (14)$$

4 Experiments of the Microgripper

Laplace transform of (14) is done and rearranging gives:

$$G(s) = \frac{x(s)}{I(s)} = \frac{\frac{E_1 AdN}{K_{coil} l_m}}{\frac{m}{h} M_{gmm} s^2 + \frac{m}{h} C_{gmm} s + \frac{m}{h} (K_{gmm} + \frac{K}{m^2})} \quad (15)$$

The relevant parameters of (15) is given and function $G(s)$ can be rewritten as:

$$\begin{aligned} G(s) &= K^* \frac{\omega_n^{*2}}{s^2 + 2\xi^* \omega_n^* s + \omega_n^{*2}} \\ &= 2.71 \times 10^{-4} \times \frac{51970^2}{s^2 + 2 \times 0.39 \times 51970 s + 51970^2} \end{aligned}$$

Where K^* is open-loop gain, ξ^* is the damp coefficient, ω_n^* is angular frequency of the undamped oscillation.

the relationship between the microgripper's parameters and responses are analyzed and open-loop simulation step is done, steps are as follows: firstly, the GMM damp is

changed when the other parameters remain, the simulation result is shown in Fig.7. secondly, the GMM quality is changed when the other parameters remain, the simulation result is shown in Fig.8

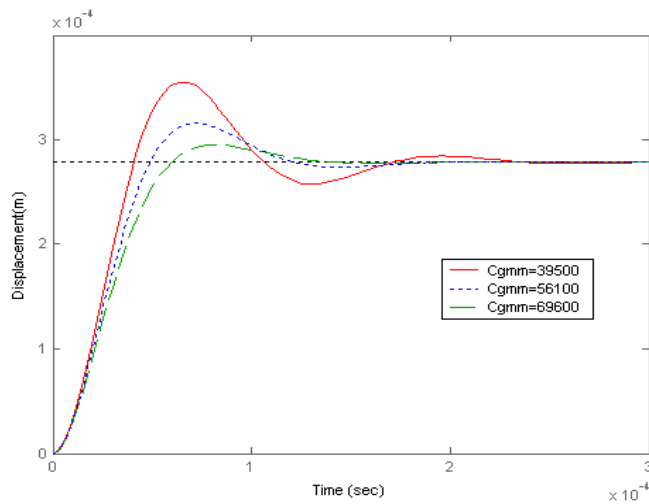

Fig.7. Comparison of the simulation curves with the different damp

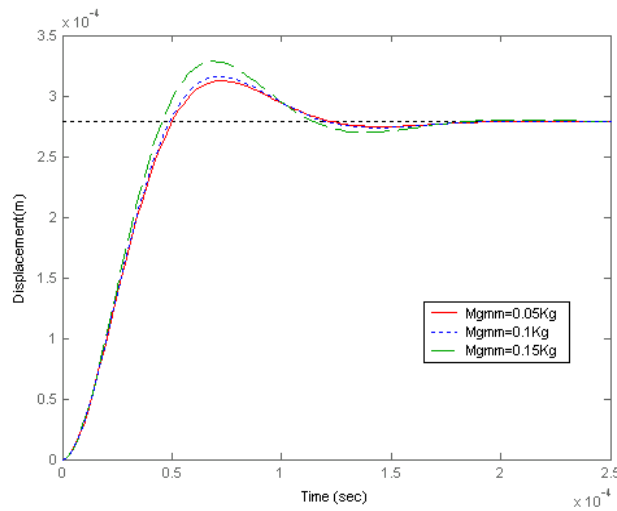

Fig.8. Comparison of the simulation curves with the different quality

The simulation results show the giant magnetostrictive material(GMM) rod damp effects on the response time and its quality has little influence, At the same time, the overshoot decrease due to the damp increase, while the overshoot increase due to the

quality increase. Accordingly, the relationship between the microgripper's designed parameters and responses are found, It is beneficial for the microgripper to optimize parameter.

5 Conclusion

In this study, the giant magnetostrictive microgripper with flexure hinge is taken as the research object . Firstly, due to the hysteresis and nonlinearity of GMM ,the better linear work domain is found when the static performance experiments are finished. Secondly, a flexible hinge mechanism to magnify the displacement is prototyped and torsional stiffness are analyzed, with compact structure, small size, motion sensitivity. the dynamic model of the microgripper is established and the formula of the microgripper's output displacement is deduced. Lastly, open-loop simulation step is finished, The simulation results show the giant magnetostrictive material(GMM) rod damp effects on the response time and its quality has little influence . there lie foundation for follow-up parameter optimized research.

6 Acknowledgment

The authors would like to acknowledge the financial support by the National Natural Science Fund of China (Grant No. 50865008) , China Postdoctoral Science Fund (Grant No. 20080431005) and Youth Science Fund of Jiangxi province office of education of China (Grant No.GJJ09611, Grant No. GJJ10633).

References

1. Anis. Y.H, Mills.J.K and Cleghorn.W.L, "Active microgripper interface used in microassembly of MEMS," Electrical and Computer Engineering, CCECE,2006, Canadian Conference onMay 2006 pp.352–354
2. Elbuken. C, Lin. Gui, Ren.C.L, Yavuz. M and Khamesee. M.B,"A monolithic polymeric microgripper with photo-thermal actuation for biomanipulation,"Mechatronics and Automation, ICMA . IEEE International Conference ,2008 ,pp.707 –711.
3. S.K. Nah and Z.W. Zhong, "A microgripper using piezoelectric actuation for micro-object manipulation," Sensors and Actuators:A 133, 2007,pp.218–224
4. Chang. R.J, Lin.Y.C, Shiu. C.C and Hsieh. Y.T, "Development of SMA-actuated microgripper in micro assembly applications," 33rd Annual Conference of the IEEE Industrial Electronics Society, IECON 2007,pp. 2886-2891
5. Jia. Zhenyuan and Guo.Dongming, Theory and Applications of Giant Magnetostrictive Microdisplacement Actuator, science and technology press of Beijing,2008
6. Cao Qinghua, Lu Quanguo, Yan Jianwu, Liu dehui. Design of New Microgripper Based on GMM [C]. The 1st International Conference On Mechanic Automation and Control Engineering, June 25-27,2010