



**HAL**  
open science

# Analysis of the Heat Transfer Performance of Vapor-Condenser during Vacuum Cooling

Gailian Li, Tingxiang Jin, Chunxia Hu

► **To cite this version:**

Gailian Li, Tingxiang Jin, Chunxia Hu. Analysis of the Heat Transfer Performance of Vapor-Condenser during Vacuum Cooling. 4th Conference on Computer and Computing Technologies in Agriculture (CCTA), Oct 2010, Nanchang, China. pp.238-249, 10.1007/978-3-642-18333-1\_28 . hal-01559618

**HAL Id: hal-01559618**

**<https://inria.hal.science/hal-01559618>**

Submitted on 10 Jul 2017

**HAL** is a multi-disciplinary open access archive for the deposit and dissemination of scientific research documents, whether they are published or not. The documents may come from teaching and research institutions in France or abroad, or from public or private research centers.

L'archive ouverte pluridisciplinaire **HAL**, est destinée au dépôt et à la diffusion de documents scientifiques de niveau recherche, publiés ou non, émanant des établissements d'enseignement et de recherche français ou étrangers, des laboratoires publics ou privés.



Distributed under a Creative Commons Attribution 4.0 International License

# Analysis of the heat transfer performance of vapor-condenser during vacuum cooling

Gailian. LI, Tingxiang JIN \*, Chunxia HU

School of Mechanical & Electricity engineering, Zhengzhou University of Light Industry,  
5 Dong Feng Road, Zhengzhou 450002, Henan Province, P. R. China, [txjin@126.com](mailto:txjin@126.com)

**Abstract.** The heat transfer performance of vapor-condenser has been studied under different temperature of cold trap and different thickness of the frost layer in this paper. The relationship between dimensionless number  $Nu$  and  $Kn$  is obtained. The results show that the capturing efficiency of cold trap increases with the decrease of the surface temperature of vapor-condenser. The frost accumulated on the surface of vapor-condenser can cause the overall heat transfer coefficient decrease, which has a negative effect on heat transfer of vapor-condenser.  $Kn$  has an effect on the heat transfer of vapor-condenser during vacuum cooling.

**Keywords:** Heat transfer performance; Vapor-condenser; Cold trap; Vacuum cooling

## 1 Introduction

Vacuum cooling is a rapid evaporative cooling method. Vacuum cooling has been successfully used to cool vegetables and flowers since the 1950s [1]. In the recent years, for the safety of foods, a rapid cooling treatment after cooking process should be used to minimize the growth of surviving organisms. Compared with the conventional cooling methods, vacuum cooling has many advantages. Therefore, many researches have highlighted the applications of vacuum cooling for the cooked meats [2-4]. In addition, heat and mass transfer characteristics during vacuum cooling have been investigated. Predictive models can provide much valuable information for the cooling process of large cooked meat joints under broad experimental conditions within a short time. Wang and Sun have developed a mathematical model for describing the vacuum cooling process of the large cooked meat joints [5-7].

A vacuum cooler is a machine to maintain the defined vacuum pressure in a sealed chamber, where the boiling of the water in the cooked meats occurs to produce the cooling effect. Theoretically, only the speed of vacuum pump is high enough to produce the defined vacuum pressure in the vacuum chamber. However, at a low

---

\*Corresponding Author. Tel: +86-371-63556785.

E-mail address: [txjin@126.com](mailto:txjin@126.com) (T. X. Jin).

### Nomenclature

$Q_0$  – Cold load of vapor-condenser,  $W$  ;

$R_v$  – Gas constant for water vapor,  $J \cdot mol^{-1} \cdot K^{-1}$  ;

$h_{vs}$  – Sublimation heat of ice,  $J \cdot kg^{-1}$  ;

$T$  – The Kelvin temperature,  $K$  ;

$\dot{m}$  – Mass flux,  $kg \cdot s^{-1}$  ;

$v$  – Specific volume,  $m^3 \cdot kg^{-1}$  ;

$P$  – Pressure,  $Pa$  ;

$D$  – Gas constant,  $J \cdot mol^{-1} \cdot K^{-1}$  ;

$t$  – Time,  $s$  ;

$A$  – Area,  $m^2$  ;

$d$  – Diameter,  $m$  ;

$\alpha$  – Heat transfer coefficient  $W \cdot m^{-2} \cdot K^{-1}$  ;

$h_o, h_i$  – Enthalpy,  $J \cdot kg^{-1}$  ;

$C_p$  – Specific heat at constant pressure,  $J \cdot kg^{-1} \cdot K^{-1}$  ;

$t$  – Time,  $s$  ;

$F_i$  – Thermal accommodation factor;

$F$  – Tangential momentum accommodation factor;

$Pr$  – Prandtl number;

$Nu$  – Nusselt number;

$Kn$  – Knudsen number;

Greeks

$\delta$  – Thickness,  $m$  ;

$\rho$  – Density,  $kg \cdot m^{-3}$  ;

$\gamma$  – The ratio of specific heat;

$\lambda$  – Thermal conductivity,  $J \cdot m^{-1} \cdot K^{-1} \cdot s^{-1}$  ;

$\sigma$  – Stefan's constant,  $5.7 \times 10^{-8} W \cdot m^{-2} \cdot K^{-4}$  ;

$\varepsilon$  – Emissivity;

$\bar{\lambda}$  – Mean free path of free molecular,  $m$  ;

Subscripts

$fr$  – Frost layer;

$v$  – Vapor;

$i$  – Inlet;

$o$  – Outlet;

$c$  – Coolant;

pressure, the volume ratio of steam and water is very large. For example, when the pressure is 1073 Pa, the corresponding saturation temperature is 8°C, the specific volume is  $120.851 m^3/kg$ . If the entire vapor is evacuated only through the vacuum pump, the speed of vacuum pump should be very large, many vacuum pumps are required in the vacuum cooler, which is obviously unsuitable. In order to remove the large amount of water vapor and keep the cooling cycle within a reasonable length of time, the vapor-condenser is used to economically and practically handle the large volume of water vapor by condensing the vapor back to water and then draining it through the drain valve. The vacuum pump and the vapor-condenser in the vacuum cooling system are used to remove the water vapor evaporated from the cooked meats. Generally, the temperature of the vapor-condenser is about  $-30^\circ C \sim -50^\circ C$  during vacuum cooling. The large temperature difference exists between the surface of vapor-condenser and the water vapor in the vacuum chamber. Consequently, the water vapor will become the frost at the surface of vapor-condenser. The frost formation on the cold surface below  $0^\circ C$  acts not only as a thermal insulator between the surface and the water vapor, but also significantly reduces the heat transfer performance of vapor-condenser, which can result in the decrease of the capability of capturing water vapor in the vapor-condenser. In order to improve the capturing efficiency of the vapor-condenser, the evaporation temperature of refrigerant in the vacuum cooler must be lowered. However, the lower evaporation temperature will add the cost of vacuum

cooler and energy consumption. Therefore, it is very important to investigate the heat transfer performance of vapor-condenser for designing and optimizing the vacuum cooling system. The phase change heat transfer theory under vacuum pressure is hardly studied. Hong and Leena [8] have modeled the frost characteristics under atmosphere pressure. In the current study, the heat transfer performance of vapor-condenser in the vacuum cooler is investigated. Moreover, the factors of affecting the heat transfer performance of vapor-condenser are also analyzed.

## 2 Experimental apparatus

The laboratory-scale vacuum cooler as shown in Fig. 1 was built by Shanghai Pudong Freezing Dryer Instruments Co. Ltd. (Shanghai, China). Vacuum cooler has four basic components: a vacuum chamber, a vacuum pump, a vapor-condenser and a refrigeration system. The vapor-condenser is an evaporator in the refrigeration system and a condenser capturing water vapor evaporated from the cooked meats during vacuum cooling. The cooling coil of vapor-condenser is set up in a stainless cylindrical steel, which is enclosed with 30 mm thickness polyurethane foam to prevent heat transfer. The stainless cylindrical steel with vapor-condenser is defined as cold trap. The water vapor is evaporated from the cooked meats during vacuum cooling. The vapor-condenser and vacuum pump removes the water vapor and air to reduce the pressure in the vacuum chamber. Because of the large temperature difference between the cold trap and the water vapor, the large amount of water vapor can enter into the cold trap. One part of water vapor is condensed into water by liquefaction, and the other part of water vapor become frost on the surface of vapor-condenser by solidification.

A set of T-type copper-constantan thermocouples with an accuracy of  $\pm 0.1$  °C are used to record the temperature of the cold trap. The mass flux of coolant is measured through supersonic flowmeter (UFLO2000P, USA). The vacuum pressure is measured through the pressure transducer (CPCA-130Z) with an accuracy of  $\pm 0.5$  Pa, the range of pressure transducer is 10 Pa~10 Kpa. The mass of the sample and water are measured through the electric balance (JA12002, made in China). Thermal conductivity of frost layer is measured by an unsteady state method using a line heat thermal conductivity probe, based on the design of Sweat as described by Scully [13, 14]. The thickness of frost layer is directly determined by a micrometer having a 0.1mm resolution.

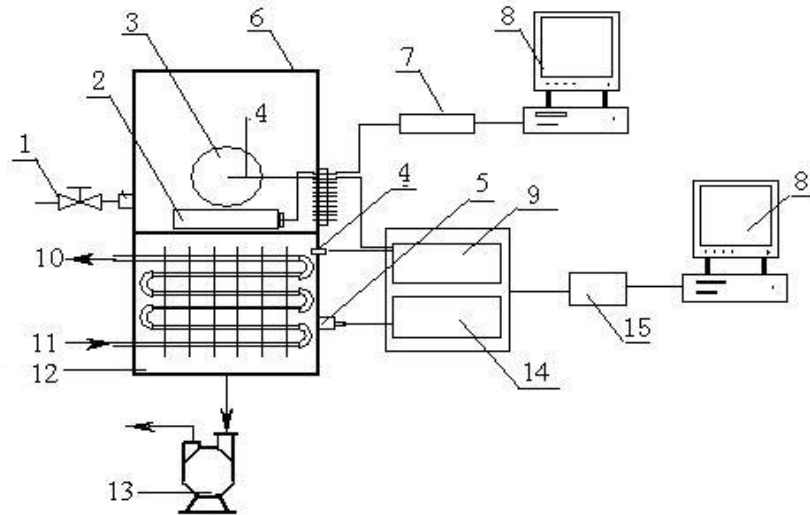

1-bleeding valve; 2-weight sensor; 3-sample; 4-thermal couple; 5-pressure sensor; 6-vacuum chamber; 7-electronic balance; 8-compute; 9-temperature controller; 10-coolant outlet; 11-coolant inlet; 12-cold trap; 13-vacuum pump; 14-pressure controller; 15-I-7018P module

**Fig. 1.** Schematic diagram of the vacuum cooler system

### 3 Theoretical analysis of heat transfer in cold trap

#### 3.1 The formation mechanism of the frost on the surface of vapor-condenser

Fig. 2 shows the formation process of frost. The sensible heat is transferred from the water vapor in the cold trap to the frost surface by the temperature difference driving force between the water vapor and the frost surface. Some of the transferred moisture deposits on the frost layer, causing the frost layer to grow. The remainder diffuses into the frost layer. The heat of sublimation caused by the phase change of the added frost layer is transferred through the frost layer. The latent heat and sensible heat transferred from the water vapor are then transferred through the frost layer by conduction. The water vapor diffusing into the frost layer changes phase within the frost layer. The frost density increases as a result of this process.

The frost layer is a porous medium composed of ice crystal and air. The ice crystal has different shapes during the formation of the frost layer. Ice crystal shapes are classified into main forms: plate-like forms and column-like forms. The microscopic structure of ice crystal is shown as in Fig. 3 [9].

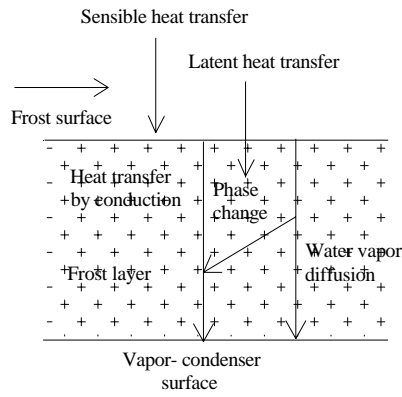

**Fig. 2.** The formation process of the frost

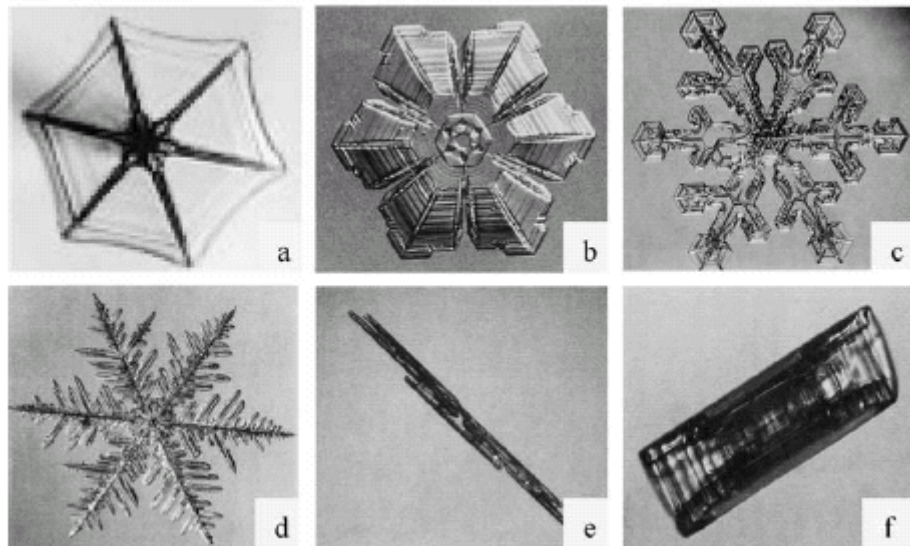

**Fig. 3.** Ice crystal shape (1) Plate-like forms: (a) plate, (b) simple sectored plate, (c) dendritic sectored plate, (d) fern-like stellar dendrite; (2) Column-like forms: (e) needle crystal, (f) hollow column, or sheath-like crystal.

During the formation of the frost, the mass flux through water vapor diffusing into the frost layer can be calculated by the Clapeyron-Clausius equation. The expression is as follows [10]:

$$\dot{m}_{fr} = \frac{Q_0}{h_{vs} + \frac{\lambda_{fr} R T_{fr}^2 (v_v - v_{ice}) \left[ 1 + \left( \frac{\rho_{fr}}{\rho_{ice}} \right)^{0.5} \right]}{D_v [h_{vs} - P_v (v_v - v_{ice})] \left( 1 - \frac{\rho_{fr}}{\rho_{ice}} \right)}} \quad (1)$$

Where  $Q_0$  is the refrigeration load of vapor-condenser;

$h_{vs}$  is the sublimation heat of ice;

$R$  is the gas constant;

$T_{fr}$  is the surface temperature of the frost layer;

$v_v$  and  $v_{ice}$  are respectively specific volume of water vapor and ice;

$\rho_{fr}$  and  $\rho_{ice}$  are respectively density of frost layer and ice;

$P_v$  is the partial pressure of water vapor;

$D_v$  is the diffusivity of water vapor;

$\lambda_{fr}$  is the thermal conductivity of the frost layer, the expression is as follows

[11]:

$$\lambda_{fr} = 0.02422 + 7.214 \times 10^{-4} \rho_{fr} + 1.1797 \times 10^{-6} \rho_{fr}^2 \quad (2)$$

The density of frost can change during the formation of frost.  $\rho_{fr}$  can be expressed as:

$$\frac{d\rho_{fr}}{dt} = \frac{\dot{m}_{fr}}{2r} - \frac{r}{4} \left[ \frac{d}{dt} \left( \frac{d\rho_{fr}}{dr} \right) \right] \quad (3)$$

### 3.2 Heat transfer in cold trap

The temperature of cold trap is about  $-30^\circ\text{C} \sim -60^\circ\text{C}$ . The water vapor evaporated from the cooked meats will become the frost at the surface of vapor-condenser in the cold trap. The frost layer at the surface of vapor-condenser gets thicker and thicker with the increment of time. The frost layer is a porous structure composed of ice crystal and air pores. Moreover, the porous structure contains a low thermal conductivity, which reduces the thermal conductivity of the frost layer. Finally, the

frost layer results in a significant heat transfer resistance from the water vapor to the surface of vapor-condenser in the cold trap. The relationship between the heat flux and the thickness of the frost layer can be expressed:

$$q = -\lambda_{fr} \frac{\Delta T}{\delta} \quad (4)$$

Where  $\lambda_{fr}$  is the thermal conductivity of the frost layer;  $\delta$  is the thickness of the frost layer.

Heat transfer coefficient,  $k$  is an important index to evaluate the heat transfer performance. Heat transfer coefficient of cold trap is measured by the quasi-stable method in this experiment. The total heat transfer coefficient is expressed as follows:

$$k = \frac{Q_0}{A \cdot \Delta T_m} \quad (5)$$

Where  $A$  is the total area of heat transfer; the logarithmic temperature difference,  $\Delta T_m$ , can be expressed as:

$$\Delta T_m = \frac{T_i - T_o}{\ln\left(\frac{T_i - T_e}{T_o - T_e}\right)} \quad (6)$$

Where  $T_e$  is the evaporation temperature.

On the other hand, the total heat transfer coefficient is also theoretically determined by:

$$k = \frac{1}{1/\alpha_v + \delta/\lambda_{fr} + 1/\alpha_c \cdot d_1/d_2} \quad (7)$$

Where  $\alpha_v$  is the heat transfer coefficient of vapor in cold trap;  $\alpha_c$  the heat transfer coefficient of coolant in coil of vapor-condenser;  $d_1$  and  $d_2$  are respectively inner and outer diameters.

The refrigeration load of vapor-condenser,  $Q_0$ , in Eq. (1) and Eq. (5) can be calculated by the enthalpy difference of refrigerant between inlet and outlet.

$$Q_0 = \dot{m}_c (h_o - h_i) \quad (8)$$

Where  $\dot{m}_c$  is the mass flux of refrigerant;  $h_o, h_i$  is respectively the enthalpy of refrigerant in outlet and inlet.

$Q_0$  is also calculated through heat transfer of gas in cold trap. The expression can be given by:



$$Q_0 = \alpha_v A (T_\infty - T_{fr}) + \varepsilon A \sigma (T_\infty^4 - T_{fr}^4) + \dot{m}_{fr} \left( \int_{T_{fr}}^{T_{ml}} C_{pf_r} dT + \int_{T_{ml}}^{T_\infty} C_{pv} dT + h_{vs} \right) \quad (9)$$

Where  $C_{pf_r}$ ,  $C_{pv}$  is the specific heat of the frost and water vapor;  $T_\infty$  is the gas temperature in cold trap;  $T_{ml}$  is the sublimation temperature.

The vacuum pump and vapor-condenser can cause the reduction of pressure in cold trap. When the gases in cold trap are at low pressure, the slip flow occurs. The relative importance of effects due to the rarefaction of a gas in cold trap can be indicated by Knudsen number ( $Kn$ ), a ration of the magnitude of the mean free molecular path ( $\bar{\lambda}$ ) in the gas to the characteristic dimension ( $L$ ) in the flow field. When the slip flow occurs in the cold trap, the gas adjacent to the surface no longer reaches the velocity or temperature of the surface. The gas at the surface of the frost has a tangential velocity and it slips along the surface. The temperature of the gas at the surface of the frost is finitely different from the surface temperature of the frost layer, and there is a jump in temperature between the surface of the frost layer and the adjacent gas. The energy and momentum equations in cylindrical coordinates can be written as [12]:

$$u \frac{\partial T}{\partial x} = \frac{\lambda}{\rho C_p} \frac{1}{r} \frac{\partial}{\partial r} \left( r \frac{\partial T}{\partial r} \right) \quad (10)$$

$$\mu \frac{\partial P}{\partial x} = \frac{1}{r} \frac{\partial}{\partial r} \left( r \frac{\partial u}{\partial r} \right) \quad (11)$$

The slip velocity as a function of the velocity gradient near the wall of cold trap can be expressed as:

$$u_{r=r_0} = \bar{\lambda} \cdot \frac{F-2}{F} \left( \frac{\partial u}{\partial r} \right)_{r=r_0} \quad (12)$$

The temperature jump in slip flow at the wall of cold trap can be written as:

$$T_v - T_w = \frac{F_t - 2}{F_t} \cdot \frac{2\gamma}{\gamma + 1} \cdot \frac{\bar{\lambda}}{\text{Pr}} \left( \frac{\partial T}{\partial r} \right)_{r=r_0} \quad (13)$$

Where  $\bar{\lambda}$  is mean free path of water vapor;  $F$  is the tangential momentum accommodation factor;  $F_t$  is the thermal accommodation factor;  $\gamma$  is the ratio of specific heat;  $\text{Pr}$  is the Prandtl number;  $r_0$  is the radius of cold trap.

The Nusselt number can be given from Eq. (10) and (11):

$$Nu = \frac{48}{11 - \frac{36Kn}{1+6Kn} + \left(\frac{6Kn}{1+6Kn}\right)^2 + 24 \cdot \frac{2-F_t}{F_t} \cdot \frac{2\gamma}{\gamma+1} \cdot \frac{\bar{\lambda}}{Pr} \cdot \frac{1}{r_0}} \quad (14)$$

## 4 Result and discussion

### 4.1 The influence of the frost layer on heat transfer in cold trap

Fig. 4 shows the experimental data for the thermal conductivity of the frost. The time ranges, for which the data were taken, are given on Fig. 4. When the experimental temperature of cold trap is  $-45^\circ\text{C}$ , the average thermal conductivity of the frost layer during vacuum cooling is  $0.1072 \text{ W} \cdot \text{m}^{-1} \cdot \text{K}^{-1}$ . It can be also found from Fig. 4 that the thermal conductivity of the frost layer increases with the increment of time. This is because the density and the thickness of the frost layer depend on the temperature of the frost and the time. The lower temperature, the more water vapor in cold trap becomes the frost on the surface of vapor-condenser and diffuses into the frost layer, which can increase the density and the thickness of the frost layer. The relationship between the thermal conductivity of the frost layer and the density of the frost layer has been shown in Eq. (2).

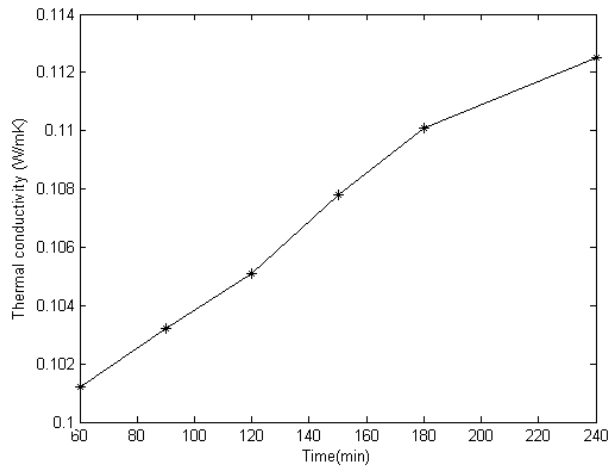

**Fig. 4.** Thermal conductivity of the frost layer

Fig. 5 shows the heat transfer coefficient in different thickness of the frost layer. When the thickness of the frost layer is 1 mm, the heat transfer coefficient is about  $4.4 \text{ W} \cdot \text{m}^{-2} \cdot \text{K}^{-1}$ . The heat transfer coefficient is  $3.3 \text{ W} \cdot \text{m}^{-2} \cdot \text{K}^{-1}$  at 5 mm thickness of the frost layer. Which means that the heat transfer resistance increases when the frost layer gets thick. The results show that the experimental data match with Eq. (7).

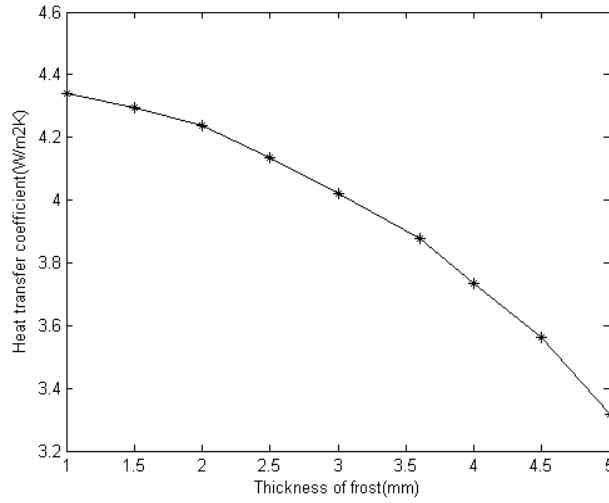

**Fig. 5.** The influence of thickness of the frost layer on the heat transfer coefficient

#### 4.2 The influence of temperature of cold trap on the capturing efficiency

The capturing efficiency of cold trap can be defined as follows:

$$\eta = \frac{M_{pw}}{M_{tw}} \times 100\% \quad (15)$$

Where  $M_{pw}$  is the total captured practical amount of the frost by solidify and water by condensation in cold trap;  $M_{tw}$  is the captured theoretical amount of the frost by solidify and water by condensation in cold trap.

Fig. 6 shows the capturing efficiency of cold trap in different temperature of cold trap. It can be found that the lower temperature of cold trap is, the higher the capturing efficiency of cold trap is. When the temperature of cold trap is about  $-55^\circ\text{C}$ , the capturing efficiency of cold trap is above 90%. However, if the temperature of cold trap decreases to  $-40^\circ\text{C}$ , the capturing efficiency of cold trap is about 20%. Therefore, the temperature of cold trap should be very low so that the cold trap can

capture more water vapor. On the other hand, if the temperature of cold trap is too low, some water vapors become the frost on the surface of vapor-condenser and on the wall of cold trap, the thick frost layer has the low thermal conductivity. Which increases the heat transfer resistance between the surface of vapor-condenser and the water vapor. With the increment of thickness and density of the frost layer, the heat transfer resistance between the surface of vapor-condenser and the water vapor increases, the temperature of cold trap become high so that the capturing efficiency of cold trap gets more and more low.

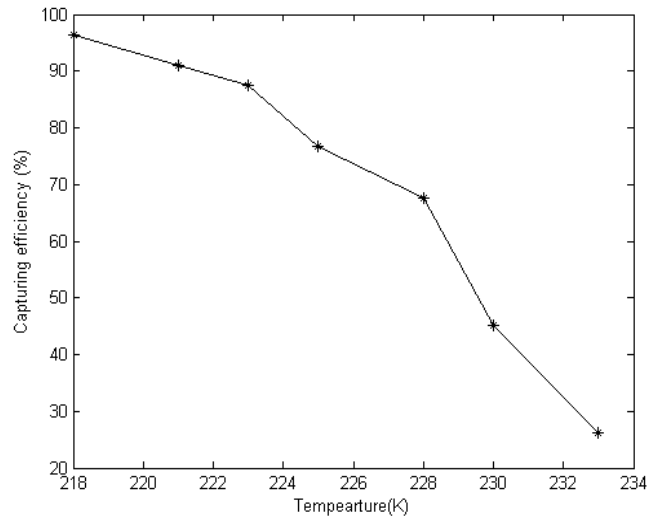

**Fig. 6.** The influence of temperature of cold trap on the capture efficiency

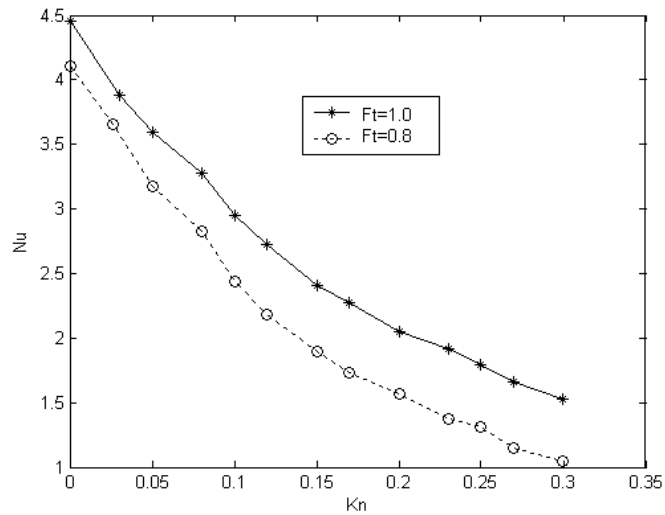

**Fig. 7.** The relationship between Nu and Kn

### 4.3 The influence of vacuum pressure on heat transfer in cold trap

It is assumed that the gas in cold trap is diatomic. The ratio of specific heat of diatomic ( $\gamma$ ) is 1.4. The relationship between  $Nu$  and  $Kn$  can be given in Eq. (14). Fig. 7 gives the variation between  $Nu$  and  $Kn$  in the different thermal accommodation factor.  $Kn$  is correlated with the vacuum pressure. It can be found that  $Nu$  decreases when the vacuum pressure in cold trap decreases. This is because convection heat can reduce at low vacuum pressure.  $Nu$  at the high thermal accommodation factor (1.0) is higher than that at the low thermal accommodation factor (0.8). The variation of  $Nu$  is opposite to the variation of  $Kn$ .

## 5 Conclusion

The heat transfer performance of vapor-condenser has been studied in different temperature of cold trap and different thickness of the frost layer in this paper. The lower the temperature of cold trap is, the more water vapor is captured. At the same time, because of the low temperature in cold trap, water vapor become frost at the surface of vapor-condenser and on the wall of cold trap. The frost layer is a porous medium composed of ice crystal and air. The low thermal conductivity of the frost layer has a negative effect on heat transfer of vapor-condenser. When the accumulated frost at the surface of vapor-condenser becomes thick, the capturing efficiency of cold trap will decrease. In addition, the relationship between dimensionless number  $Nu$  and  $Kn$  is obtained, the variation of  $Nu$  is opposite to the variation of  $Kn$ .

## ACKNOWLEDGEMENTS

Funding for this research was provided by Henan Provincial Department of Education (P. R. China).

## References

1. Briley, GC. Vacuum cooling of vegetables and flowers. ASHRAE JOURNAL, 46 (4): 52-53 (2004).
2. Karl McDonald, Da-Wen Sun, Tony Kenny. The effect of injection level on the quality of a rapid vacuum cooled cooked beef product. Journal of Food Engineering . 47, 139~147 (2001).
3. Burfoot, D., Self, K. P., Hudson, W. R., Wilkins, T. J., & James, S. J. Effect of cooking and cooling method on the processing times, mass losses and bacterial condition of large meat joints. International Journal of Food Science and Technology. 25, 657~667 (1990).

4. E.M. Desmond, T.A. Kenny, P. Ward, Da-Wen Sun. Effect of rapid and conventional cooling methods on the quality of cooked ham joints. *Meat Science*. 56, 271~277 (2000).
5. Lijun Wang, Da-Wen Sun. Modelling vacuum cooling process of cooked meat—part 1: analysis of vacuum cooling system. *International Journal of Refrigeration*. 25, 854~861 (2002).
6. Lijun Wang, Da-Wen Sun. Modelling vacuum cooling process of cooked meat—part 2: mass and heat transfer of cooked meat under vacuum pressure. *International Journal of Refrigeration*. 25, 862 - 871 (2002).
7. Lijun Wang, Da-Wen Sun. Effect of operating conditions of a vacuum cooler on cooling performance for large cooked meat joints. *Journal of Food Engineering*. 61, 231 - 240 (2004).
8. Hong Chen, Leena Thomas, and Robert W. Besant, Modeling frost characteristics on heat exchanger fins: Parts I, Numerical Model. *ASHRAE Transactions*. 357~367 (2000).
9. Byeongchul Na, Ralph L. Webb. New model for frost growth rate. *International Journal of Heat and Mass Transfer*. 47, 925 - 936 (2004).
10. Kondepudi S N, O'Neal D L. Performance of finned tube heat exchangers under frosting conditions. *International Journal of Refrigeration*. 16 (3), 175~180 (1993).
11. Yonko J D, Sepsy C F. An investigation of the thermal conductivity of frost while forming on a flat horizontal plate. In: *ASHRAE Trans*. 73 (2) , 111~117 (1967).
12. Barron R. F, Wang X. M, Ameel T. A., et a, The graetz problem extended to slip - flow, *Int J . Heat Mass Transfer*. 40(8) , 1817 ~ 1823 (1997).
13. Sweat, V. E.. Thermal properties of foods. In M. A. Rao & S.H. Rizvi (Eds.), *Engineering properties of foods* (pp. 49 - 87). New York: Marcel Dekker (1986).
14. Scully, M. M.. The influence of compositional changes in beef burgers and mashed potatoes on their temperatures following microwave heating and their thermal and dielectric properties. MSc Thesis, University College Dublin, Ireland (1998).