



HAL
open science

THE COVERING OF ANCHORED RECTANGLES UP TO FIVE POINTS

Antoine Mhanna

► **To cite this version:**

Antoine Mhanna. THE COVERING OF ANCHORED RECTANGLES UP TO FIVE POINTS. 2016.
hal-01528188

HAL Id: hal-01528188

<https://inria.hal.science/hal-01528188>

Preprint submitted on 27 May 2017

HAL is a multi-disciplinary open access archive for the deposit and dissemination of scientific research documents, whether they are published or not. The documents may come from teaching and research institutions in France or abroad, or from public or private research centers.

L'archive ouverte pluridisciplinaire **HAL**, est destinée au dépôt et à la diffusion de documents scientifiques de niveau recherche, publiés ou non, émanant des établissements d'enseignement et de recherche français ou étrangers, des laboratoires publics ou privés.

THE COVERING OF ANCHORED RECTANGLES UP TO FIVE POINTS

ANTOINE MHANNA

ABSTRACT. Given a fixed rectangle S for any set of points P in S with $|P| \leq 5$; if one of the points is the lower left corner of S we prove the existence of a family of disjoint rectangles such that the lower left corner of each rectangle is a distinct point of P and the rectangles in such a packing jointly cover an area that is bigger strictly than the half of that of S .

1. INTRODUCTION

The result i present is linked to the unsolved problem which has been firstly proposed by Allen Freedman in [5] p. 345 (see also [2] p. 113 or [3]) which is: Given n points in the unit square $0 \leq x, y \leq 1$, one of which is the origin, can n disjoint rectangles be found inside the square and with sides parallel to those of the square, each rectangle having one of the points as its lower left corner so that their total area is greater than $\frac{1}{2}$, the only explicit known result is due to Adrian Dumitrescu and Csaba D. Tòth (see [1]) and states that a total area of at least 0.09 (approximately) can be found by the so called Greedy-Packing algorithm. Another analysis of such rectangle covering -also known as anchored rectangles packing- was done by T. Christ et al in [4], generally speaking they showed that the total area covered by the anchored rectangles depends on the number of points inside the unit square.

In the sequel we don't restrict S to be a unit square but all the rectangles constructed inside S are assumed to be anchored *i.e.* having their sides parallel to the initial rectangle sides. The points inside rectangles are represented by a_i , $i \in \mathbb{N}$, x_i denotes the abscissa and y_i denotes the ordinate of a_i (see Figure 1 for clarification) and we have $i \leq j$ if and only if $y_i \leq y_j$, for other points say b_i we consider x_{b_i} as

Date: 2016.

2010 Mathematics Subject Classification. Primary: 52C15.

Key words and phrases. Covering of anchored rectangles, Allen Freedman's problem.

the abscissa and y_{b_i} as the ordinate of b_i . In this section a rectangle S of area k is denoted by $S_{(k)}$.

Lemma 1.1. *Let $S_{(k)}$ be a fixed rectangle and let a_1, \dots, a_n be any set of points chosen arbitrarily in S , then there exist disjoint anchored rectangles F_1, \dots, F_n that can cover at least half the area of S under the condition that either each point a_i is at the lower left corner of the rectangle F_i (the left version) or each point a_i is in the lower right corner of F_i (the right version).*

Proof. Suppose first that for any i , $d_i := y_{i+1} - y_i$ is constant, we shall duplicate our rectangle $S_{(k)}$ by another one right next to him (to the right) to obtain $R_{(2k)}$ and from each point we construct a rectangle whose area is $\frac{k}{n}$, this way we have half of $R_{(2k)}$ covered by rectangles, now when d_i is not constant we deploy a proportionality argument to see that the area covered remains unchanged. Dividing $R_{(2k)}$ by two, one of the two rectangles (the original or the duplicated one) must have at least half of its area covered by our rectangles; if it is the left one we are in the left version and in the right version otherwise, (see Figure 1 for a particular case where $n = 6$). \square

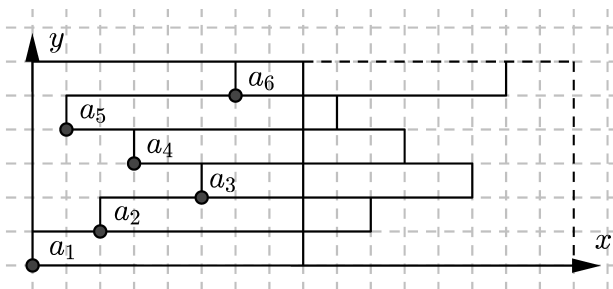

FIGURE 1. A completed rectangle with 6 points.

The previous lemma is very important to prove the result, seeking the validity of the left version for any set of points will need extra condition(s) and that what the problem statement has to offer; it deletes the right versions but adds an extra condition which is: a point is in the lower left corner of S . An area covered by rectangles is called the rectangles area whereas the remaining area is called the blank area.

Lemma 1.2. *Let G_1 respectively G_2 be an area covering at least half of G_3 respectively G_4 . If $G_3 \cap G_4 = \phi$ then $G_1 \cup G_2$ covers at least half of $G_3 \cup G_4$.*

Proof. This follows from the proportion equality

$$\frac{b_1}{b_3} = \frac{c}{d} = \frac{b_1 + c}{b_3 + d},$$

where b_i is the area of G_i and $\frac{c}{d} \leq \frac{b_2}{b_4}$. □

2. THE STAIR DIVISIONS

A line passing throughout a point a_i will be denoted D_{a_i} .

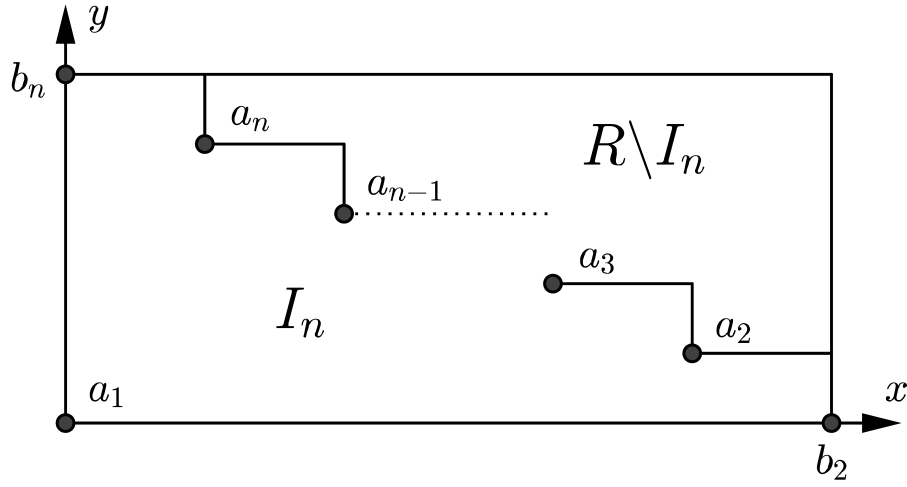

FIGURE 2. An n stair division in R .

Proposition 2.1. *Given a set of n points as in Figure 2; if for all $i \geq 2$ we have $y_i - y_{i-1} = y_{b_n} - y_n = a$, $x_i - x_{i+1} = x_n = x_{b_2} - x_2 = c$, where a and c are constants, then there is a rectangle with lower left corner a_1 such that the area of this rectangle is at least half the area of stair I_n .*

Proof. First it should be clear that for n points in such positions, the stair I_n is of area $\mathcal{A} := ac \frac{n(n+1)}{2}$ and $\frac{\mathcal{A}}{2} = ac \frac{n}{2} \frac{(n+1)}{2}$. The rectangle having the lower left corner a_1 and formed by the intersection of horizontal line $D_{a_{\frac{n}{2}+1}}$ and vertical line $D_{a_{\frac{n}{2}}}$ (if n is even) respectively by the intersection of horizontal line $D_{a_{\frac{n+1}{2}+1}}$ and vertical line $D_{a_{\frac{n+1}{2}}}$ (if n is odd) will have an area of $ac \frac{n}{2} \left(\frac{n}{2} + 1 \right)$ respectively of $ac \frac{n+1}{2} \frac{(n+1)}{2}$. □

It is easy to verify that the rectangle in Proposition 2.1 will still cover half of the stair even when adding a blank area of at most $ac\frac{n}{2}$ if n is pair or a blank area of at most $ac\frac{n+1}{2}$ if n is odd.

Remark 1. *If R is a rectangle, a stair $\subset R$ that verifies the hypothesis of Proposition 2.1 is called a symmetric stair, the problem arises when the horizontal jumps $(x_i - x_{i+1})$ or the vertical jumps $(y_i - y_{i-1})$ are not constant; i.e when we have any sort of stair. In all cases i assume that no two points say a_i and a_j will be on a same horizontal or vertical line. Now if Proposition 2.1 is true for any type of stairs then by Lemma 1.2 we are done because every rectangle is just an assembling of some number of stairs but unfortunately this is not the case as we will see in the proof of Proposition 3.1.*

What we will do is just verify the left version for rectangles with a given number of points $|P|$, but before that let us introduce some terminology and preliminary results: A symmetric stair with n points is denoted by I_n and a deformed stair of I_n will be denoted by \mathfrak{T}_n . For a given stair \mathfrak{T}_n with lower left corner a_1 the points a_2, \dots, a_n are called the corners of \mathfrak{T}_n . By convention for a rectangle S with a stair \mathfrak{T}_n , no points will be strictly inside \mathfrak{T}_n . A rectangle which has the lower left corner a_i and upper right corner b_j is denoted by $R_{a_i b_j}$ and for a given polygon D we denote by $\mathcal{A}(D)$ the area of D in the plan.

For a rectangle as in Figure 3 we denote by A respectively B the upper respectively lower left quadrant and by C respectively M we denote the upper respectively lower right quadrant of the rectangle. Finally in a rectangle $R_{a_i b_j}$, the point $c_{a_i b_j}$ is the point of intersection of the lines determining the four rectangle quadrants A, B, C and M . The initial rectangle S will be identified to $R_{a_1 b_1}$.

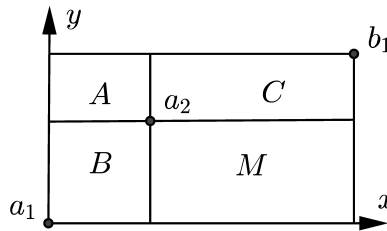

FIGURE 3. A rectangle $R_{a_1 b_1}$ and its four quadrants.

Proposition 2.2. *Let S be any rectangle and let a_1, a_2 be two points of S such that a_1 is the lower left corner of S , then there is two rectangles F_1, F_2 in the left version covering at least $\frac{3}{4}\mathcal{A}(S)$.*

Proof. This follows from Figure 3, if $a_2 \equiv c_{a_1b_1}$ in $R_{a_1b_1}$, it is easily seen that at least one of the quadrants A or M has an area less or equal to $\frac{\mathcal{A}(R_{a_1b_1})}{4}$ and this is sufficient to prove the result. \square

Definition 2.1. *Given a rectangle $R_{a_1b_1}$ and a stair \mathfrak{T}_n inside it; assume that the index ordering is applied only on corners $a_2, a_3, \dots, a_{n-1}, a_n$ of \mathfrak{T}_n and independently from other points i.e. we have $i \leq j$ with a_i and a_j are corners and $y_i \leq y_j$:*

- *For $1 \leq i \leq n - 1$, the i^{th} horizontal stage is the rectangle in $R_{a_1b_1}$ formed by opposite sides of $R_{a_1b_1}$ and the two horizontals lines passing through a_i and a_{i+1} .*
- *The n^{th} horizontal (or last) stage is the rectangle formed by the opposite sides of $R_{a_1b_1}$ and the two horizontals lines passing through a_n and b_1 .*
- *For $2 \leq i \leq n - 1$, the i^{th} vertical stage is the rectangle in $R_{a_1b_1}$ formed by opposite sides of $R_{a_1b_1}$ and the two vertical lines passing through a_i and a_{i+1} .*
- *The n^{th} vertical stage is the rectangle formed by the opposite sides of $R_{a_1b_1}$ and the two verticals lines passing through a_n and a_1 .*
- *The first vertical stage is the rectangle formed by the opposite sides of $R_{a_1b_1}$ and the two verticals lines passing through a_2 and b_1 .*

The area covered by F_1 , the rectangle which has a_1 as its lower left corner is called the principle area. The reader can see that in some cases the principle area is sufficient to cover half of the area of the initial rectangle S , this is considered among trivial cases, next are other trivial cases that follow from Lemma 1.2:

Proposition 2.3. *Let S be any rectangle which has a_1 as its lower left corner. Suppose that no stair of points exists inside S ; i.e we have $i \leq j$ if and only if $x_i \leq x_j$ and $y_i \leq y_j$, then the left version result is true.*

Remark 2. *The previous proposition can be reformulated in a different way and a better bound exists for the rectangle area's proportion. For example take a rectangle S and any number n of points equally distributed along the diagonal, which means that: for all $i \leq n - 1$ we*

have $|a_i a_{i+1}| = |a_n b_1| = c$ with c constant. With this repartition the rectangles area is precisely $\frac{\mathcal{A}(S)}{2} + \frac{\mathcal{A}(S)}{2n}$, under Proposition 2.3 conditions (with Proposition 2.2 in mind) this bound will still be attained even if no such c exists nor the points are on the diagonal $a_1 b_1$.

If $y_2 \geq \frac{y_{b_1}}{2}$ then the principle area can cover half of S , so we will consider that $y_2 \leq \frac{y_{b_1}}{2}$. Similarly if for example a_h is the first point to the right of a_1 and $x_h \geq \frac{x_{b_1}}{2}$ then the principle area can cover half of S , so we will consider that $x_h \leq \frac{x_{b_1}}{2}$.

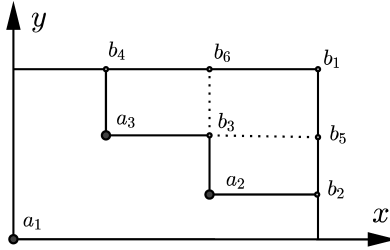

FIGURE 4. A rectangle S with three points.

Lemma 2.1. *The left version statement is true for rectangles such as in Figure 4.*

Proof. We know that for the two first horizontal stages the left version is true, since $x_3 \leq \frac{x_{b_1}}{2}$ the third horizontal stage verifies the left version and by Lemma 1.2 this completes the proof. \square

An easy induction yields to:

Proposition 2.4. *For a given rectangle R partitioned into \mathfrak{T}_n and $R \setminus \mathfrak{T}_n$, if there is no points strictly inside $R \setminus \mathfrak{T}_n$ then the left version statement is verified for R .*

3. THE MAIN RESULTS

Hereafter the only points that will keep our initial ordering are the corner of the stair, the other points on figures have no particular order, the discussion is built on their possible positions inside the initial rectangle denoted by S . We denote by $X_{i,j}$ the intersection of the i^{th} horizontal stage and j^{th} vertical stage.

The case $|P| \leq 2$ is settled in Proposition 2.2, the case $|P| = 3$ will follow from Lemma 2.1 and Proposition 2.3. Adding two points (a_4 & a_5) to Figure 4 we can be in this situation:

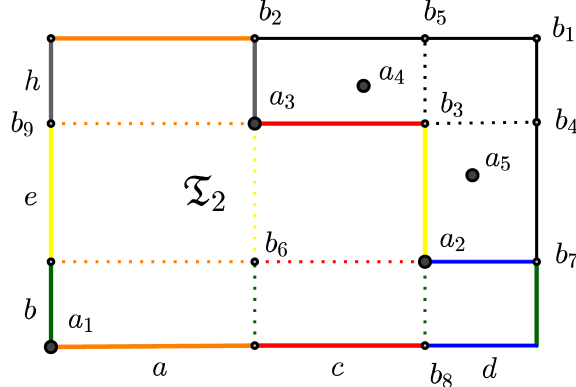

FIGURE 5. A rectangle S with five points.

Lemma 3.1. *The left version statement is true for rectangles such as in Figure 5.*

Proof. Let us start saying that if one of the rectangles $R_{a_1b_2}$, $R_{a_1b_3}$ or $R_{a_1b_7}$ covers at least half of $\mathcal{A}(\mathfrak{T}_2)$ then the proposition is obviously true, as a consequence we only discuss the converse situation: stuck situation (this happens for example if $b + e + h = a + c + d = 5$, $a = 1$, $b = 1$, $c = 1$ and $e = 1.5$).

Keeping that a side we shall take the area average of two rectangles chosen from $(R_{a_1b_2}, R_{a_1b_3}$ or $R_{a_1b_7})$ we must have all of the three averages strictly less than $\frac{\mathcal{A}(\mathfrak{T}_2)}{2}$ so in numbers we have:

$$(1) \quad \begin{cases} ec > ab \\ bd > a(b + e) \\ ah > b(a + c) \end{cases} \Rightarrow \begin{cases} h > b \\ d > a \\ bd > ea \\ ah > bc \\ \text{If } e < b \text{ then } c > a \\ \text{If } c < a \text{ then } e > b. \end{cases}$$

Suppose that a_4 and a_5 are in the second horizontal stage then take area $R_{a_1b_4} \setminus R_{a_2b_4}$ it is easy to cover half of it, also at least $\frac{\mathcal{A}(R_{a_2b_4})}{2}$ can be covered by rectangles since it is a rectangle with three points, the

last horizontal stage verifies the left version thus we are done. If a_4 and a_5 are both in the third horizontal stage and in the second vertical stage, then we can split the figure by covering at least half the area of $R_{a_3b_5}$ and by deleting the first vertical stage the remaining object verifies easily the left version argument.

If a_4 and a_5 are in $R_{b_3b_1}$ then by (1) we are sure that at least one of the two next facts is true:

$$\bullet \mathcal{A}(R_{b_9b_2}) < \mathcal{A}(R_{a_2b_4}) \quad \bullet \mathcal{A}(R_{b_8b_7}) < \mathcal{A}(R_{a_3b_5}),$$

with this and from Lemma 1.2 the reader can see (by properly partitioning S) that at least half of S can be covered by rectangles.

The last possibility is when a_4 is in the third horizontal stage and a_5 is in second horizontal stage, at least $\frac{3\mathcal{A}(S \setminus \mathfrak{T}_2)}{4}$ can be covered by rectangles, from the above discussion we can ensure that at least one of the two following facts is true:

$$\bullet 2\mathcal{A}(R_{b_9b_2}) < \mathcal{A}(S \setminus \mathfrak{T}_2) \quad \bullet 2\mathcal{A}(R_{b_8b_7}) < \mathcal{A}(S \setminus \mathfrak{T}_2).$$

Suppose that $2\mathcal{A}(R_{b_9b_2}) < \mathcal{A}(S \setminus \mathfrak{T}_2)$ then $(S \setminus \mathfrak{T}_2) \cup (R_{b_9b_2})$ as well as $S \setminus ((S \setminus \mathfrak{T}_2) \cup (R_{b_9b_2}))$ verify the left version result. The other case is similar and with that the proof is completed. \square

As one may have noticed there is no obvious reason why the previous lemma remains true if in $R_{a_1b_1} \setminus \mathfrak{T}_2$ we had three or more points; indeed there are examples of stuck situation (whether R is taken to be a square or a rectangle) with sufficiently large number of points in $R \setminus \mathfrak{T}_2$ and the percentage of the rectangle area in $R \setminus \mathfrak{T}_2$ is strictly less than 75%.

The previous results will entail the following:

Corollary 3.1. *Let S be any rectangle and a_1, \dots, a_4 be a set of four points chosen arbitrarily in S except that a_1 is in the lower left corner of S then there is a set of rectangles F_1, \dots, F_4 in the left version covering at least $\frac{1}{2}\mathcal{A}(S)$.*

Theorem 3.1. *Let S be any rectangle and a_1, \dots, a_5 be a set of five points chosen arbitrarily in S except that a_1 is in the lower left corner of S then there is a set of rectangles F_1, \dots, F_5 in the left version covering at least $\frac{1}{2}\mathcal{A}(S)$.*

Proof. With five points the only case we didn't discuss is when S contains an \mathfrak{T}_3 and thus $S \setminus \mathfrak{T}_3$ contains one single point a_5 . If a_5 is not in the fourth horizontal stage or is not in the first vertical stage then the result is true since in each case, at least one of the two former stages

will satisfy the left version statement and deleting this stage will put us in the situation of Lemma 3.1.

Suppose a_5 is in the fourth horizontal stage and in the first vertical stage. Now consider in S the four quadrants A, B, C and M all of equal area and take $(X_{4,3} \cup X_{4,2} \cup X_{2,1} \cup X_{3,1})$ as a whole rectangle area with area $(X_{4,3} \cup X_{4,2} \cup X_{2,1} \cup X_{3,1} \cup X_{4,1})$ covered to at least its $\frac{3}{4}$ proportion (which is possible), here also there are different situations:

- (1) If a_3 is in A , or in B we delete the third horizontal stage (which verifies the left version) thus without loss of generality, the two remaining parts can be joint together and we will be in the Lemma 3.1 situation.
- (2) If a_3 is in M we delete the second vertical stage (which verifies the left version) without loss of generality, the two remaining parts can be joint together and we will be in the Lemma 3.1 situation.
- (3) If a_3 is in C (see Figure 7): Assume that $a < b$ then we have

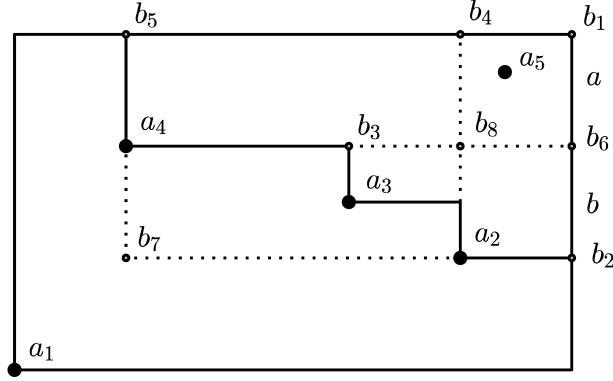

FIGURE 6. A rectangle with five points.

$\mathcal{A}(R_{b_8 b_1}) < \mathcal{A}(R_{a_2 b_6})$. $R_{a_2 b_6}$ is considered to be a whole rectangle area, since at least half of $R_{a_1 b_6}$ is covered by the principle area filling the last stage will make the whole rectangle verify the theorem. If $a > b$ we shall split the rectangle $R_{b_7 b_4}$ from the initial rectangle. The left version is true for $R_{b_7 b_4}$, $R_{a_2 b_1}$ and $R_{a_1 b_5} \cup R_{a_1 b_2}$ which completes the proof.

□

A direct generalization of the two last results is this one:

Lemma 3.2. *Let S be any rectangle with stair \mathfrak{T}_2 , let a_1 be the lower left corner of S and a_2, a_3 its stair corners. If a_4, \dots, a_7 are four points*

inside the intersection of the last horizontal stage and the first vertical stage then the left version is true for S . Moreover for any n , a given rectangle S having only one point in $S \setminus \mathfrak{F}_n$ will verify the statement of the left version.

Proof. The first part is implicitly presented in the proof of Lemma 3.1. The case $n = 3$ of the second statement is Theorem 3.1. If a_{n+1} isn't in the first vertical stage or in the last horizontal stage then we are done so we assume without loss of generality that for a given n , a_{n+1} is in $X_{n+1,1}$, before further discussion we point out again that in this case we can consider $(X_{n+1,n} \cup X_{n+1,n-1} \cup \dots \cup X_{n+1,2}) \cup (X_{2,1} \cup X_{3,1} \cup \dots \cup X_{n,1})$ as a whole rectangle area with area $(X_{n+1,n} \cup X_{n+1,n-1} \cup \dots \cup X_{n+1,2} \cup X_{2,1} \cup X_{3,1} \cup \dots \cup X_{n+1,1})$ covered to at least its $\frac{3}{4}$ proportion. Now like we did in Theorem 3.1, depending on the position of first a_n (then the remaining corners) we may delete vertical or horizontal stages satisfying the left version and then join together the remaining parts. If at a certain stage of iteration the second corner from above is in quarter C adopting the previous proof we split our rectangle properly and the argument is straight forward. \square

Remark 3. In the last proof we could replace the only point in $X_{n+1,1}$ by any number of points under the conditions that all of them are in $X_{n+1,1}$, half of $X_{n+1,1}$ is covered and $(X_{n+1,n} \cup X_{n+1,n-1} \cup \dots \cup X_{n+1,2}) \cup (X_{2,1} \cup X_{3,1} \cup \dots \cup X_{n,1})$ is a whole rectangle area. The next example exposes this situation with its extensions:

Example 3.1. Identifying points on a same horizontal or vertical line to a single point (wherever is necessary!), the first (bigger) highlighted rectangle of the figure is $X_{6,1}$

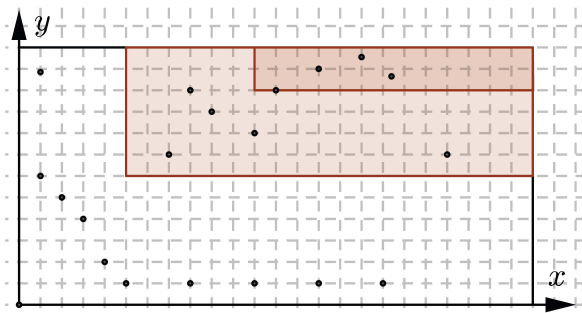

FIGURE 7. A left version verified rectangle with 20 points.

Acknowledgment. I want to thank the active mathematicians on the online phorum for posting the problem at <http://www.les-mathematiques.net/phorum/read.php?43,801824>.

REFERENCES

- [1] A. Dumitrescu, C. D. Tòth, *Packing anchored rectangles*, *Proceedings of the 23rd ACM-SIAM Symposium on Discrete Algorithms*, (SODA 2012), Kyoto, Japan, January 2012. Available from <http://arxiv.org/pdf/1107.5102.pdf>.
- [2] H. T. Croft, K. J. Falconer, and R. K. Guy, *Unsolved Problems in Geometry*, volume II of *Unsolved Problems in Intuitive Mathematics*, Springer, New York, 1991.
- [3] P. Winkler, *Puzzled*, *Commun. ACM*, **53**(11):112, 2010.
- [4] T. Christ, A. Francke, H. Gebauer, J. Matousek and T. Uno, *A doubly exponentially crumbled cake*, *Electronic Notes in Discrete Mathematics*, **38**, 265-271, 2011.
- [5] W. Tutte, *Recent Progress in Combinatorics: Proceedings of the 3rd Waterloo Conference on Combinatorics*, May 1968, Academic Press, New York, 1969.

KFARDEBIAN, LEBANON

E-mail address: tmhanat@yahoo.com