



**HAL**  
open science

## Collaborative Business Scenarios in a Service-Enhanced Products Ecosystem

Luis M. Camarinha-Matos, Patricia Macedo, Filipa Ferrada, Ana Inês Oliveira

► **To cite this version:**

Luis M. Camarinha-Matos, Patricia Macedo, Filipa Ferrada, Ana Inês Oliveira. Collaborative Business Scenarios in a Service-Enhanced Products Ecosystem. 13th Working Conference on Virtual Enterprises (PROVE), Oct 2012, Bournemouth, United Kingdom. pp.13-25, 10.1007/978-3-642-32775-9\_2 . hal-01520443

**HAL Id: hal-01520443**

**<https://inria.hal.science/hal-01520443>**

Submitted on 10 May 2017

**HAL** is a multi-disciplinary open access archive for the deposit and dissemination of scientific research documents, whether they are published or not. The documents may come from teaching and research institutions in France or abroad, or from public or private research centers.

L'archive ouverte pluridisciplinaire **HAL**, est destinée au dépôt et à la diffusion de documents scientifiques de niveau recherche, publiés ou non, émanant des établissements d'enseignement et de recherche français ou étrangers, des laboratoires publics ou privés.



Distributed under a Creative Commons Attribution 4.0 International License

# Collaborative Business Scenarios in a Service-enhanced Products Ecosystem

Luis M. Camarinha-Matos <sup>1</sup>, Patricia Macedo <sup>1,2</sup>, Filipa Ferrada <sup>1</sup> and Ana Inês Oliveira <sup>1</sup>

<sup>1</sup> Universidade Nova de Lisboa, Faculty of Sciences and Technology and  
UNINOVA Institute  
Campus de Caparica, 2829-516 Monte Caparica, Portugal  
cam@uninova.pt

<sup>2</sup> EST Setúbal, Instituto Politécnico de Setúbal, Setúbal, Portugal

**Abstract.** Effective support to highly customized and service-enhanced products along their life cycle requires new organizational structures, involving the manufacturers, customers and local suppliers in a process of co-creation and co-innovation. In order to properly develop supporting infrastructures, tools and governance models, it is necessary to first identify representative business scenarios which enable individual requirements to be viewed in relation to one another in the context of the overall use case / target domain. In this context, a set of relevant business scenarios derived from the requirements of the solar energy domain are identified and discussed.

**Keywords:** Collaborative networks, Services ecosystem, Business scenarios

## 1 Introduction

The notion of service-enhanced product and the associated idea of service-enhanced manufacturing represent a growing trend, particularly in the context of complex products. The motivation is that buyers of manufactured products increasingly want more than the physical product itself, they might want finance options to buy it, insurance to protect it, expertise to install it, support to maintain it fully operational during its life cycle, advice on how to maximize returns from it, expertise to manage it, etc. [1], [2].

This has led to the idea of bundling products and services together in customized packages for clients. For the case of complex products, e.g. solar energy plants or intelligent buildings, services are increasingly necessary to ensure that sophisticated component sub-systems can be designed, integrated, operated and maintained as final complex products. In this context, the distinction between delivery of products and services has become less distinct or blurred. As a result, the term “servitization” is also used when referring to provision of services to clients of manufacturing firms [3].

ICT and particularly Internet technologies developments also led to putting greater focus on knowledge and high value added when it comes to design such services. This

requires not only a shift from ‘goods dominant logic’ to ‘service dominant logic’, but also associated changes in the organizational structures and business models. Provision of integrated services along the life cycle of complex products requires collaboration among multiple stakeholders. More than a shift from product-oriented enterprise to customer-oriented enterprise, a shift to a ‘community or ecosystem oriented’ model is needed.

On the other hand, despite the developments in ICT and the globalization of the economy, proximity is becoming increasingly important for innovation and growth. In fact, easy interconnectivity is now just a pre-requisite rather than a differentiator in achieving competitive advantage. Therefore, the notion of *glocal* enterprise emerged to represent the idea of thinking and acting globally, while being aware and responding adequately to local specificities, namely in collaboration with local stakeholders and customers.

This paper presents preliminary results of the GloNet project in this direction.

## 2 The GloNet Project

GloNet aims at designing, developing, and deploying an agile virtual enterprise environment for networks of SMEs involved in highly customized and service-enhanced products through end-to-end collaboration with customers and local suppliers (co-creation) [4]. The notion of *glocal* enterprise is implemented in GloNet with value creation from global networked operations and involving global supply chain management, product-service linkage, and management of distributed production units.

Further to service-based enhancement, there is a growing trend in manufacturing to move towards highly customized products, ultimately one-of-a-kind, which is reflected in the term *mass customization*. In fact, mass customization refers to a customer co-design process of products and services which meet the needs/choices of each individual customer with regard to the variety of different product features. Important challenges in such manufacturing contexts can be elicited from the requirements of complex technical infrastructures, solar energy parks, intelligent buildings, etc.

The guiding use case in GloNet is focused on the production and life cycle support of **solar energy parks**. The norm of operation in this industry is that of one-of-a-kind production. The results (products and services) are typically delivered through complementary competences shared between different project participants. A key challenge is the design and delivery of multi-stakeholder complex services along the product life cycle (typically 20 years). Focused issues: (i) Information / knowledge representation (product catalogue, processes descriptions, best practices, company profiles, brochures, etc.); (ii) User-customized interfaces, dynamically adjusted to assist different stakeholders (smart enterprise approach); (iii) Services provision through cloud; (iv) Broker-customer interaction support: from order to (product/service) design (open innovation approach); (v) Negotiation support; (vi) Workflow for negotiated order solution & its monitoring; and (vii) Forecast risks & suggest prevention measures.

The GloNet project started in Sep 2011 with a planned duration of 3 years, and involves the following partners: CAS (Germany), UNINOVA (Portugal), University of Amsterdam (Netherlands), iPLON (Germany), SKILL (Spain), Steinbeis (Germany), KOMIX (Czech Republic), and PROLON (Denmark).

### 3 Use Case Characteristics

The development of business scenarios is an important technique that helps in better characterizing requirements, identifying and understanding business needs, and thus provides important inputs for the next phase of GloNet when a system's architecture has to be designed.

Although the concept is not precisely defined in the literature, the adopted notion here is that a **business scenario** represents a **significant business need or problem** in the target domain. In other words, it provides a reasonably extensive description of a business problem, which enables individual requirements to be viewed in relation to one another in the context of the overall use case / target domain [5].

In order to identify the set of relevant business scenarios for GloNet the following **method** is adopted (as illustrated in Fig. 1):

- 1) Start with the guiding use case of GloNet (solar energy plants) and identify its main abstract characteristics, leading to an abstract use case.
- 2) Analyze the needs of the abstract use case and suggest a set of relevant business scenarios.
- 3) Confirm the relevance of the scenarios in the context of other use cases. Possible iterations with phase 2 are included here.
- 4) Develop detailed descriptions of the selected business scenarios.
- 5) Confirm the details and refine descriptions in consultation with end-users representative of the use cases / application domains.

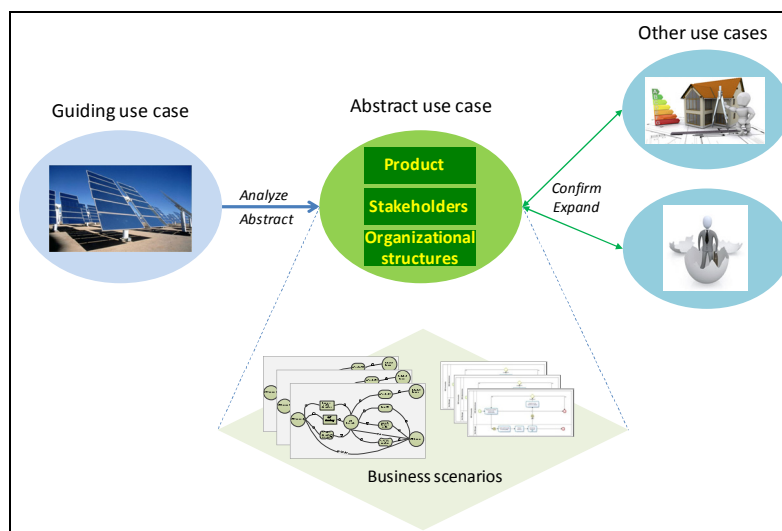

**Fig. 1** - Identification of relevant business scenarios

As mentioned before, the guiding use case is the solar plants domain, with particular emphasis on the maintenance and operation of the power plants. The other two use cases, which share similar abstract characteristics, are the building automation and the physical incubator facilities for enterprises.

The main characteristics of the target business cases can be summarized by:

a. *Product characteristics*

- Complex (physical) product, involving several sub-systems
- Long life-cycle, but having components with different life-cycles
- Need for business services provision along the life-cycle (service-enhanced product); new services are likely to be demanded
- Integrated business services typically combine contributions from multiple stakeholders
- Mass customization, nearly one-of-a-kind product (and properly adapted services).

b. *Stakeholders characteristics*. The manufacturing and service provision for such products involve a large diversity of stakeholders performing a number of roles:

- Product / project designers
- Product manufacturers, including sub-systems / components providers
- Service providers
- Support entities, including financial, insurance, training, cloud infrastructure provision, regulator entities, etc.
- Customers and users differentiation.

c. *Organizational structures*. Stakeholders can appear organized in a number of networked structures that reflect a variety of relationships, some sense of community, and different levels of collaboration maturity. These include:

- Long-term strategic alliances - which typically involve product / project designers, manufacturers, service providers, and some support entities, configuring a kind of virtual organizations breeding environment (VBE) [6], [7]. A VBE represents an association of organizations and a number of related supporting institutions, adhering to a base long term (formal or informal) cooperation agreement, and adopting common operating principles and infrastructures, with the main goal of increasing their preparedness towards rapid configuration of goal-oriented networks (Virtual Organizations/Virtual Enterprises - VO/VE).
- Customer related communities - involving, besides the customer, local non-critical components suppliers, services providers, and a variety of support entities. Although this group might not be well organized and structured, it shares some minimal bonds like geographical vicinity, culture, business environment, legal regulations, etc.
- Goal-oriented networks - in which intense and well focused cooperation and/or collaboration (towards a common goal or a set of compatible goals) is practiced among their partners. Two inter-related cases are foreseen:
  - Product development network - a dynamic (temporary) VE involved in the development of the physical product and design of associated services.

- Product servicing network - a long-term VE organized to provide integrated (multi-stakeholder) business services along the product life-cycle.

A product servicing VE might have (a few) members in common with the product development VE, but typically corresponds to a different organizational structure. A mechanism of inheritance between the product development VE and product servicing VE needs to be established. The recruitment base (constituency) for these networks include, preferentially, the manufacturers VBE and the customer related community, but it might also include outside entities (see Fig. 2).

These networked structures need to cope with a variety of membership levels. Instead of a binary "member / not member" situation, multiple degrees of membership have to be considered (e.g. core members, regular members, associated members, etc.) with different levels of rights and responsibilities. The degree of membership might not even be a constant parameter for each entity but rather vary with the context or perspective of analysis, which leads to different geometries of the networks. These networks need to interact and may span over a wide geographical distribution.

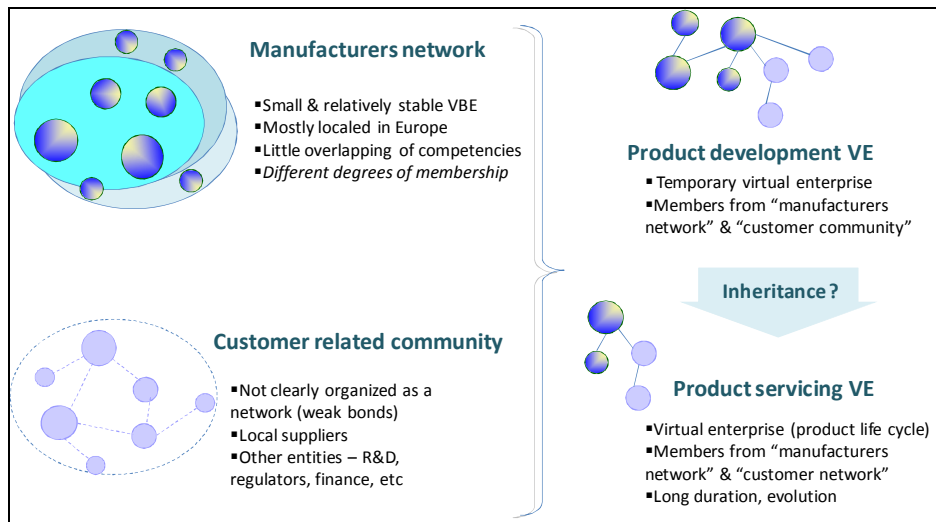

Fig. 2 - Main organizational structures in GloNet

Table 1. Mapping to the solar plant use case

Abstract elements		Solar plant use case
Product	Complex (physical) product	Power plant itself.
	Long life-cycle	Typically 20~25 years for the power plant; many components / subsystems have shorter lives and need to be periodically replaced.
	Business services	Examples include: Plant operation & management, Panel cleaning & preventive maintenance, Training, Diagnosis, Performance improvement support, etc.
	Mass	Although sharing some general characteristics, each

	customization	solar plant is a distinct case (one-of-a-kind product) depending on power requirements, geographical and environmental characteristics, local regulations, etc.
Stakeholders	Product/project designers	Project development companies, Procurement & Construction (EPC) companies, Consultants
	Product manufacturers	Photo Voltaic (PV) equipment manufacturers, EPC, Construction & Commissioning companies, Monitoring & Control companies
	Service providers	Operation & maintenance companies, Monitoring & Control companies, etc.
	Support entities	Lending organizations (banks), Insurance companies, Government agencies
	Customers and users	Customer (owner), Utility companies
Organizational structures	Strategic alliance / Manufacturers VBE	Project development firms, Engineering, Procurement & Construction (EPC) companies, PV equipment manufacturers, Monitoring & Control companies, Construction & Commissioning companies
	Customer related community	Customer (owner), Utility company, Lending organization, Government agencies, Insurance companies, Operation & maintenance companies, other suppliers, etc.
	Product development VE	Project development companies, EPC, PV equipment manufacturers, Construction & Commissioning companies, Monitoring & Control companies, Lending organization, Insurance company, ...
	Product servicing VE	Operation & maintenance companies, Monitoring & Control companies, Utility company, etc.

#### 4 Relevant Business Scenarios

*Identification of relevant business scenarios.* When addressing the issue of identifying and selecting relevant business scenarios in GloNet it is important to consider the specificities of a research project and its defined goals. As such, the relevance of business scenarios cannot be determined by the current operational business practices of single companies, but rather by their contribution to identify the “backbone” (models, infrastructure, tools, and processes) for a new way of doing business in a collaborative networked environment. In other words, the selected scenarios should help in creating the conditions to get prepared to effectively doing business in a different way.

Under this perspective, it is also important to consider the need for some base or “enabling” scenarios, which just create the proper conditions for the development of other scenarios that are more directly appealing to an end-user. For instance, while for end-user companies it might be relevant to have a scenario focused on the formation of goal-oriented networks (in response to a business opportunity), it is also clear that the agility of the consortium formation process very much depends on the existence of a long-term strategic network that promotes the preparedness of its members for collaboration. Therefore, the effectiveness of the mentioned scenario depends on the

consideration of an “enabler” scenario focused on the management of long-term networks or business ecosystems.

In this context, and after extensive consultation with end-users and system developers, the following business scenarios are considered in the GloNet environment:

1. *Management of Long-term Collaborative Network* - Management of the strategic long-term alliance of product designers & manufacturers
2. *Formation of Goal-oriented Collaborative Network* - Consortia formation for virtual enterprises: product development VE, Product servicing VE
3. *Co-design and Co-innovation* - Environment and processes to support collaboration with customers and local suppliers (co-creation)
4. *Base Operation and Management of Product Servicing* - Handling the “trivial” processes of operation and maintenance of the product
5. *Advanced Supervision Services for the Collaborative Network* - Handling advanced processes / functionalities of operation and maintenance and network coordination
6. *Shared Resources Repository Management* - Management of the shared repository of community resources: general sharable information / knowledge (e.g. processes), software tools, lessons learned, etc.
7. *Product Portfolio Management* - Management of all information related to products: product catalog, product model, historic data on the product (sensorial data, product updates / changes, etc.) ... single ‘access point’ along the product life-cycle.
8. *Semi-automated Learning-based Decision Support* - to assess the feasibility of building semi-automated learning-based decision making support system for complex products.

In terms of *representation of business scenarios*, the following main elements are considered: (i) Description and purpose, (ii) Goals, outcomes and main features, (iii) Environment and actors, (iv) Details on actors, roles and responsibilities, (v) Business processes, and (vi) Required software services.

In addition to tables and textual descriptions, the following formalisms are adopted to help characterizing the business scenarios: i\* (i-star) - to describe actors, individual and common goals, tasks, and their inter-relationships; and BPMN – to represent business processes.

**Examples.** As an illustration, let us consider the following scenarios:

**E1. Management of Long-term Collaborative Network.** A Long-term Collaborative Network is a strategic alliance of organizations adhering to a base long term cooperation agreement while also adopting common operating principles and infrastructure, thus a kind of VBE (Virtual Organizations Breeding Environment). In this case the Solar Plants VBE alliance brings together and supports collaboration among otherwise independent and mostly small organizations which are currently involved in solar plants industry. As such, through the formation of energy-related VBE alliances for instance, collaboration among their stakeholders increase, since they can join their efforts, capabilities, and capacities, to better fulfill the emerged opportunities in the market. A system to support the management of this kind of



network provides services to manage member's profiles and VBE's ontology, to support performance management and to manage trust among VBE member.

Strategic goals for this scenario include: Manage admission and withdrawal of members in the VBE; Ensure that complete information about member's profile and competencies are available; Ensure secure access to VBE members; Promote trust among VBE's members; Promote the adoption of a common ontology

Fig.3 (in i\* notation) shows the main actors as well as their inter-dependencies in terms of (hard) goals (e.g. Join VBE), soft goals (e.g. Members trust), and resources (e.g. VBE ontology).

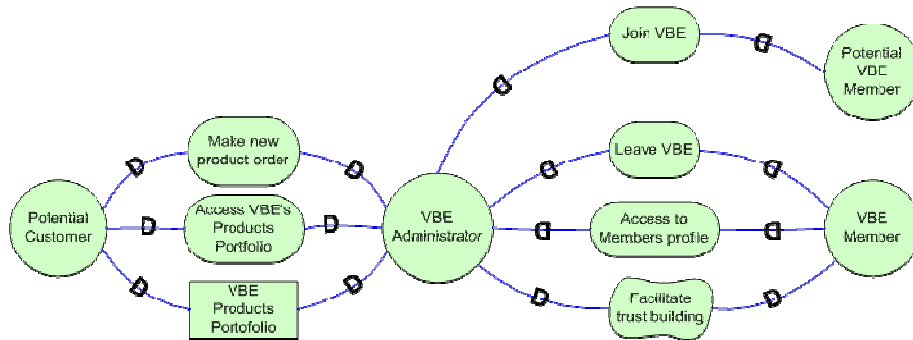

Fig. 3 - i\* Strategic Dependency model for Long-term Collaborative Network

A more detailed description is shown in Fig. 4, where a zoom in is made on the VBE Coordinator actor.

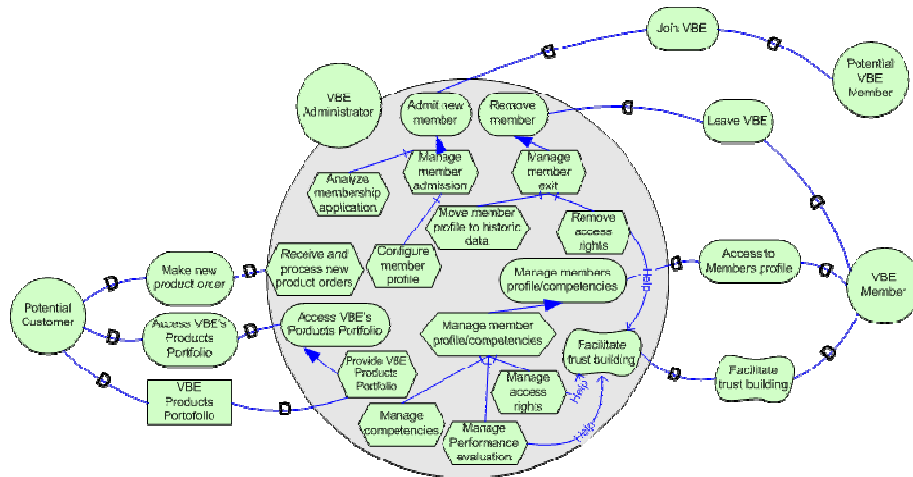

Fig. 4 - i\* Partial Strategic Rational Model for Long-term Collaborative Network scenario

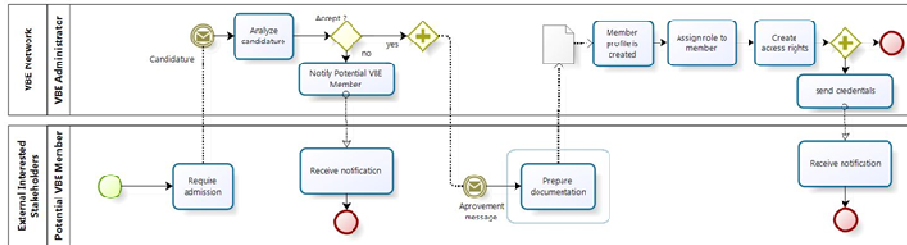

Fig. 5 - Partial BPMN process for admission of new VBE member

Examples of required software services: VBE Member Admission Service, VBE Member Withdrawal Service, Membership Level Access Management Service, Ontology Management Service.

**E2. Co-design and Co-innovation.** This scenario aims at providing an environment that supports and promotes the collaborative design and development of products and services as well as the emergence of innovative solutions. It thus includes the aspects of mass customization as well as the emergence of new products / new solutions to identified needs, through collaboration between manufacturers and the customer and members of the customer’s community.

Strategic goals for this scenario include: Co-design and co-development of products, Provide co-innovation support, and Guarantee customer satisfaction & VO partners satisfaction. Fig. 6 shows the main actors and their inter-dependencies for this scenario.

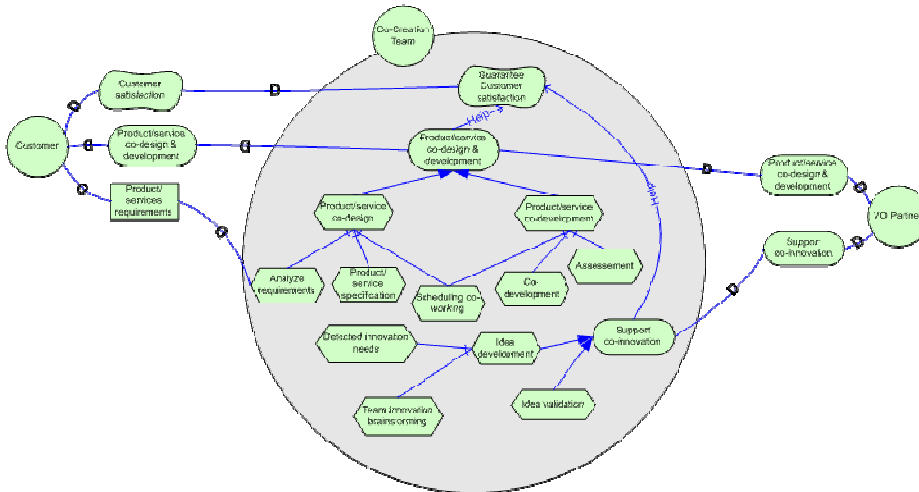

Fig. 6 - i\* Strategic Rational model for Co-design and Co-innovation

Fig. 7 shows an example of business process for the case of co-innovation.

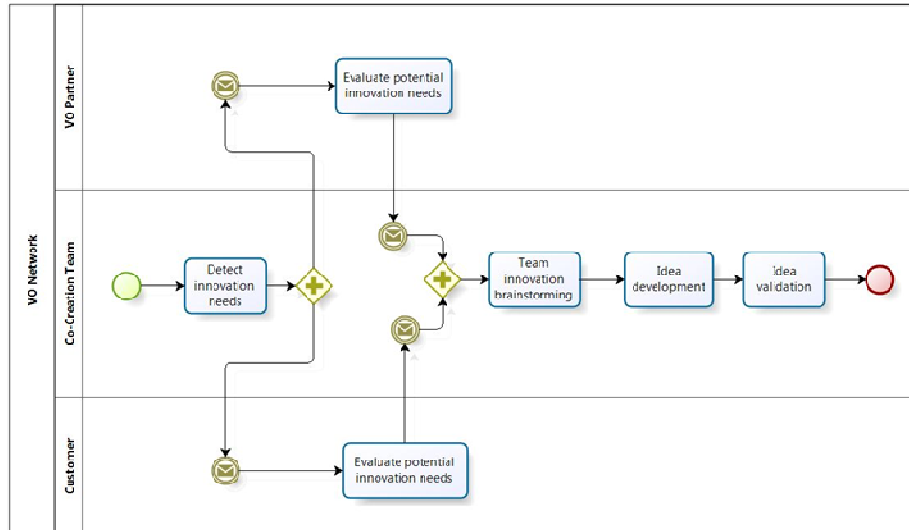

Fig. 7 - BPMN diagram of the Co-innovation Process

## 5 Implementation Issues

GloNet adopts a cloud-based approach [4] for the development of its ICT environment so that its supporting services can dynamically upgrade without influencing the nodes and stakeholders in the environment. Regarding the base platform the following main characteristics are planned:

- Cloud-based infrastructure, based on open-source technologies, adopting relevant standards and based on OSGi.
- Incremental pool of services, knowledge, and other resources (scalability characteristic).
- Supporting the notion of extended or service-enhanced product - combination of physical product with a set of linked support services (e.g. maintenance, remote diagnosis, remote user assistance, training, insurance services, etc.). A product model will become available in a *Business Services Provision Space* as a single entry point for product-related information and services along its life cycle. The product servicing virtual enterprise (see Fig. 2) will naturally be linked to this product model.
- Besides the cloud-based platform, the environment includes two main (virtual) spaces: (i) *Collaborative solution space* - where new products and services are designed, developed / customized (co-creation/mass customization) through the interplay of the various stakeholders (product development virtual enterprise); (ii) *Business services provision space* - where models of products and associated services are kept along the product life cycle, supported by the product support virtual enterprise.

The GloNet platform being developed is aimed to provide not only the mechanisms to compose software services via business processes, but also to model business services and bundle them together with the product.

Since the term ‘service’ is used by both the business and software communities, it is important to clarify the corresponding meanings and inter-relationships. Fig. 8 summarizes the adopted interpretation. As illustrated, the concept of *business service* corresponds to an external (i.e. client-oriented) view while the *software service* is one of the mechanisms to materialize a business service.

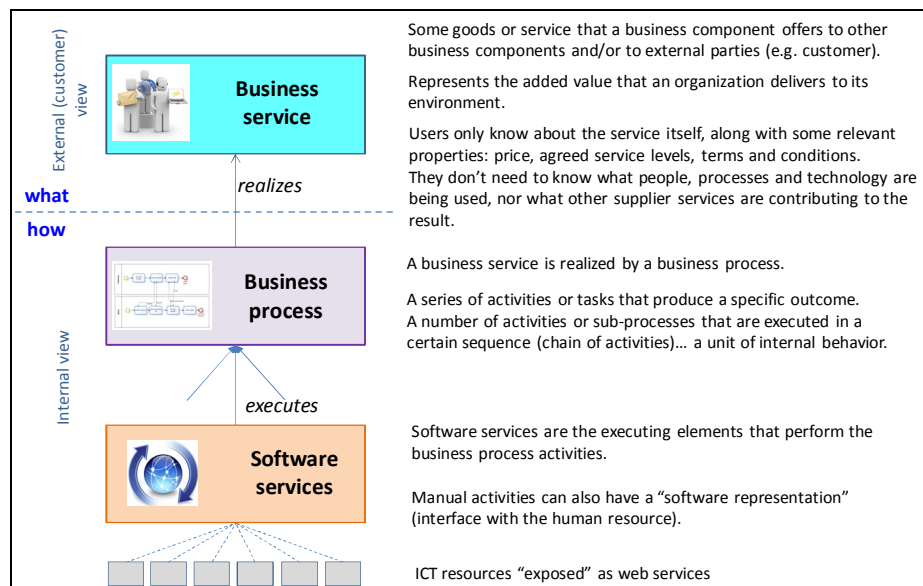

Fig. 8 - Relationship between business service and software service

## 6 Conclusions

Effective development and exploitation of complex products require that the physical product is enhanced with a number of associated (business) services. These services are likely to integrate contributions from multiple stakeholders and thus require a collaboration environment. Furthermore, the involvement of the customer, and other local stakeholders associated to the customer, in the process of design, development and delivery are important in a context of mass customization and to leverage the ‘proximity’ factor.

GloNet is developing an environment to support such co-design and co-innovation processes for complex and long-life cycle service-enhanced products.

One of the open issues is to assess the adequacy of a cloud computing implementation approach and determine which business models are needed for that approach. Although the advantages of cloud computing for SMEs have been

extensively discussed, there are a number of critical issues that remain, namely the lack of interoperability among cloud providers, which raises the issue of risk of business continuity, particularly acute when we address products with a long life cycle, such as the solar energy plants. The business models prevalent in current cloud computing solutions also seem limited when it comes to supporting collaborative networks environments.

**Acknowledgments.** This work was funded in part by the European Commission through the GloNet project (FP7 programme). The authors also thank the contributions from their partners in this project.

## References

1. Marceau, Jane & Manley, Karen (1999). Service enhanced manufacturing in the building and construction product system. Department of Industry, Science and Resources, Canberra. <http://eprints.qut.edu.au/41286/>
2. Shen, Q. (2010). Research on Organization Mode Selection of Service-enhanced Manufacturing Enterprise. In *Proceedings of 3rd International Conference on Information Management, Innovation Management and Industrial Engineering*, 26-28 Nov, 2010, Kunming, China, pp 358-361, IEEE Computer Society.
3. Tether, B.; Bascavusoglu-Moreau, E. (2012). Servitization: The extent and motivations for service provision amongst UK manufacturers. Proceedings of DRUID 2012 - Innovation and Competitiveness: Dynamics of Organizations, Industries, Systems and Regions, 19-21 Jun 2012, Copenhagen, Denmark.
4. Camarinha-Matos, L. M.; Hamideh Afsarmanesh, H.; Koelmel, B. (2011). Collaborative Networks in Support of Service-enhanced Products. In *Adaptation and Value Creating Collaborative Networks*, IFIP AICT Series 362/2011, Springer, pp. 95-104.
5. OpenGroup (2001). Business Scenarios. [http://www.opengroup.org/architecture/togaf7-doc/arch/p4/bus\\_scen/bus\\_scen.htm](http://www.opengroup.org/architecture/togaf7-doc/arch/p4/bus_scen/bus_scen.htm) (accessed 5 Apr 2012).
6. Afsarmanesh, H.; Camarinha-Matos, L. M.; Msanjila, S. S. (2011). Models, Methodologies, and Tools Supporting Establishment and Management of Second-Generation VBEs, *IEEE Transactions on Systems, Man and Cybernetics – C*, Vol. 41, Issue 5, Sept 2011, pp 692-710.
7. Camarinha-Matos, L. M.; Afsarmanesh, H. (2008). Collaborative Networks: Reference Modeling. Springer: New York, 2008. ISBN 978-0-387-79425-9.