



**HAL**  
open science

# Methodological Issues in Support of Selected Tasks of the Virtual Manufacturing Planning

Marius Essers, Martin Erler, Andreas Nestler, Alexander Brosius

► **To cite this version:**

Marius Essers, Martin Erler, Andreas Nestler, Alexander Brosius. Methodological Issues in Support of Selected Tasks of the Virtual Manufacturing Planning. 6th Programming Languages for Manufacturing (PROLAMAT), Oct 2013, Dresden, Germany. pp.401-412, 10.1007/978-3-642-41329-2\_39 . hal-01485834

**HAL Id: hal-01485834**

**<https://inria.hal.science/hal-01485834v1>**

Submitted on 9 Mar 2017

**HAL** is a multi-disciplinary open access archive for the deposit and dissemination of scientific research documents, whether they are published or not. The documents may come from teaching and research institutions in France or abroad, or from public or private research centers.

L'archive ouverte pluridisciplinaire **HAL**, est destinée au dépôt et à la diffusion de documents scientifiques de niveau recherche, publiés ou non, émanant des établissements d'enseignement et de recherche français ou étrangers, des laboratoires publics ou privés.



Distributed under a Creative Commons Attribution 4.0 International License

# Methodological Issues in Support of Selected Tasks of the Virtual Manufacturing Planning

Dipl.-Ing Marius Eßers<sup>1</sup>, Dipl.-Ing Martin Erler<sup>1</sup>, Priv.-Doz.Dr.-Ing Andreas Nestler<sup>1</sup>

<sup>1</sup>Dresden Technical University, Faculty of Mechanical Science and Engineering,  
Institute of Manufacturing Technology, Chair of Forming Processes,  
Workgroup of Production Automatization, Cutting and Erosion Manufacturing Engineering.  
{marius.essers, martin.erler,  
andreas.nestler}@tu-dresden.de

**Abstract.** For virtual production planning a wide variety of tools are already in use. These tools mainly focus at just one methodological aspect. To increase the scope and utility value for process planning, several methodological aspects need to be combined in one single tool. The technological representation of the different aspects usually requires the application of various simulation models beside common data models. In particular, the combination of discrete and continuous time and spatial variables is elaborated.

It opens up new fields for increased productivity and cost forecast, by using e. g. universal kinematics, control access, material removal simulation and finite element model.

**Keywords:** Virtual Machining, Virtual Manufacturing, Virtual Machine Tooling, Virtual Machine

## 1 INTRODUCTION

In the area of production planning there are many points of application for the supporting use of simulation models due to the multitude of influencing variables to be taken into account. In principle all unique activities to be implemented for the design of a manufacturing system and the manufacturing processes to be planned can be simulated. The challenge is in developing models with suitable representations and visualisations as well as furnishing them with additional, growing physical characteristics. This affects all activities to be planned for drafting, design and optimisation of manufacturing processes in component production [01]. With the inclusion of physical characteristics from models, increasingly realistic statements for technological matters in particular can be attained. Realistic, in the sense of the planning of target stipulations, means attaining sufficient accuracy for the results relating to a relevant point of observation. Thus with the knowledge of sufficiently accurate machining forces for planned operations, the power and energy considerations can also be incorporated into the simulation, e.g. for the reduction of the energy expended through the evaluation for the design of operations based on low energy requirements [02]. For

the best possible process design, conditions typical to the planning must be selected, whereby the various different display options incorporated for an increase in process planning quality can be tested and which can be linked to a comprehensive procedure [03]. Proving techniques, which will analyse the processes already designed as a follow-up, must also be integrated for verification purposes. The functionality existing at present for commercial and non-commercial machining simulation systems amounts primarily to the classical collision avoidance [04], the predominantly geometry-based visualisation of the overall system Machine-Tool-Workpiece [05] and selected optimisation on the basis of the NC code [06].

For the best possible process design and verification, the machining process must take account of the working process of the mechanical processing and its effect on the physical complete system Machine-Tool-Workpiece. In addition, further processes, e.g. the setting up of the machine, must also be taken into account in order to avoid potential fault sources.

The objective is the combination of a long term process simulation and a point-in-time-specific system simulation with a high degree of detailing (Figure 1).

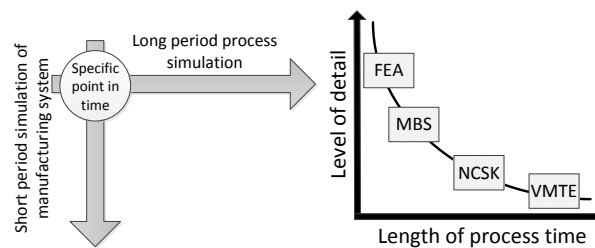

**Fig. 1.** Trends of process simulation

The high degree of detailing enables the planner to use additional functions of the process simulation for substantiated forecasting for special problem cases for a defined assessment period. These types of functions are not available in commercially available planning systems or are only available in rudimentary forms. This approach also counteracts transient performance problems occurring when working with a high degree of detail, which severely restrict the assessment period, in order to economically facilitate the overall process simulation with physical characteristics. The following investigations into methodical aspects are performed as examples of the virtual design of a milling machining centre and the milling process to be planned.

## 2 METHODOLOGICAL ASPECT OF SHORT PERIOD SIMULATION OF MANUFACTURING SYSTEMS<sup>1</sup>

Here the degree of detailing can be considered as an alternative illustration for a given process section. That means that for an assessment period alternative illustrations are possible, whereby each one can depict another degree of abstraction. That applies both to the representations and the characteristics of the models.

For the illustration of the most comprehensive range of characteristics in the models of the mechanical machining, a multitude of application domains must be combined [07]. So that various different methods can be used, logically a universal user interface must be created for the design and implementation of the simulation.

The SimulationX development environment was selected for these requirements. SimulationX can be used for interdisciplinary drafting, the modelling and analysis of physical-technical systems on a common platform [08]. In standard form it offers domains in the fields of drive technology and electrical engineering, flexible multi-body mechanics and others. Additional models can be coupled to expand the functional scope. In principle the models can communicate via a locally shared memory or via a network. The basis for the coupling is an interface definition. Alongside a propriety interface, an example functional mock-up interface (FMI) of the MODELISAR project [09] can also be used. This enables a modular approach, whereby the computing resources will also have an influence on the costs of the degree of detail. The object-oriented implementation of the manufacturing system is sub-divided into important sub-systems with bidirectional interfaces, whereby clamping systems are currently not considered (Figure 2).

The virtual workpiece, virtual tool and virtual machine tool sub-systems are dealt with in more detail below. The working point for the process will be explained in the process simulation section.



Fig. 2. - Object-oriented illustration of a manufacturing system

### 2.1 Virtual Workpiece

The real workpiece undergoes continuous change during the machining. This affects both the external form as well as the stiffness and the mass which are changing due to the removal of material. Where large volumes are to be machined, the mass has a greater effect on the complete system and for example on the expected energy con-

<sup>1</sup> Acknowledgement: This work is kindly supported by the AiF ZIM Project SimCAP (KF 2693604GC1)

sumption. For smaller components with thin-walled structures the smallest amount of material removal has a substantial effect on the stiffness.

There are well-proven techniques existing for the representation of workpiece geometry. Alternatively the mapping of a coupled NC simulation core (NCSK) [11] can be applied via a Z-map [10] or via a 3-dexel model. The widely-used data format STL is used as a basis. With this, the starting geometry is imported and the virtual finished geometry exported. Volumetric and dimensional calculations, for example, can be carried out based on this.

In principle, modelling is available as an ideally stiff workpiece. Firstly a check is carried out to ascertain whether a modular replacement system can be used to illustrate the changing stiffness. However, this does not enable the complex geometry to be completely illustrated. Therefore a freely available FEA software module is incorporated by means of Co-Simulation [12] to show the structural mechanics of the workpiece (Figure 3). With this model representation forces, which can be used for deformation, can be applied to the node points.

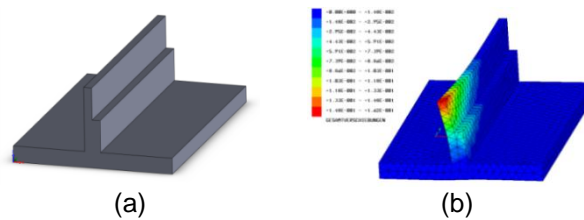

Fig. 3. - Geometric (a) and structural-mechanical representation (b) workpiece

## 2.2 Virtual Tool

If rough calculations are to be carried out then the tool can be adopted initially as ideally stiff (Figure 4a). There are various different illustrative models available for further detailing. If one ignores the wear on the cutting edge of the tool then it undergoes no geometric change in the process. An approximated representation of the tool with two flexible multi-bodies represents the shaft and the cutting part (Figure 4b). For a more exact implementation of the tool stiffness the FEM software module is available again (Figure 4c).

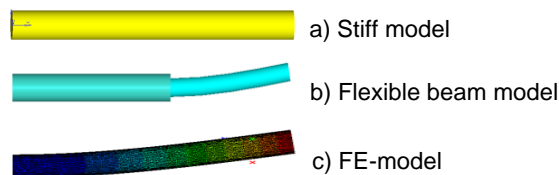
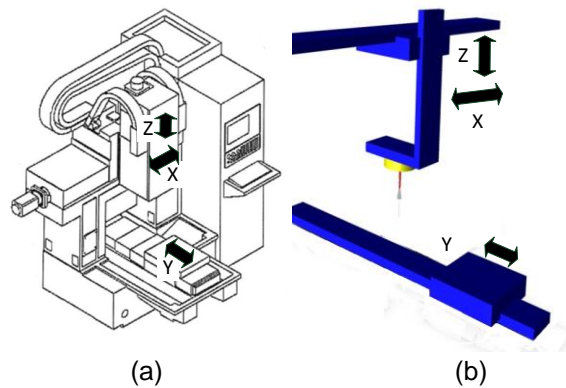

Fig. 4. - Tool representation models

This enables step-by-step expandable accuracy in the illustration of the tool characteristics. End mills are modelled as examples.

### 2.3 Virtual Machine Tool

As a minimum requirement on a virtual machine tool the kinematics must be implemented in order to be able to realise detailed movement information. The existing objects of the ITI mechanics library from the CAx development platform SimulationX are utilised for this. As an example a 3-axis portal-design vertical milling machine is modelled (Figure 5).



**Fig. 5.** Kinematics of the Mikromat 4V HSC (a) machine and a simplified visualisation (b)

Information from the machine documentation is sufficient to illustrate further characteristics. This is critical for the illustration of masses and centres of gravity for the machine components. The stiffnesses of the guides are modelled through spring-damper systems. The machine components are primarily adopted as ideally stiff, so that all simulated machine deformations are created by the guides. The illustration of the cascade controller and the electrical illustration of the translational drive components is implemented through the "controller" components. An electrical drive motor ("driveMotor") and a ball screw drive ("ballScrewDrive") from the ITI mechanics library are used in these components.

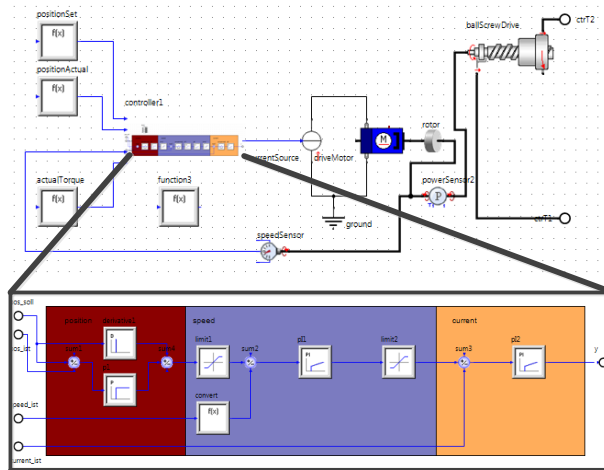

Fig. 6. - Control-related and electrical implementation of an axis

## 2.4 Process Simulation

Figure 7 shows the principle design and progression of the process simulation including the various different models for the respective sub-system. The closed simulation progression will run through each calculation time-point. The stages indicate two options for the implementation of various models as examples. Here stage 1 means a platform-internal simulation without the incorporation of an external Co-Simulation. To increase the calculation accuracy there are additional modules in stage 2 available for selection.

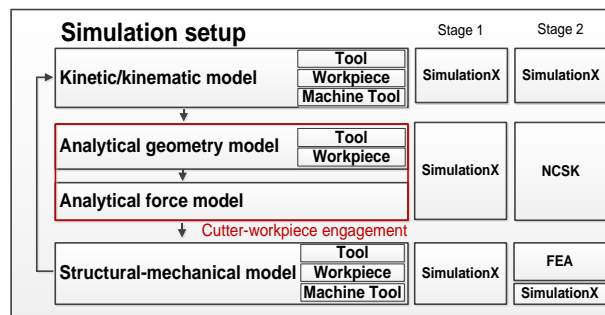
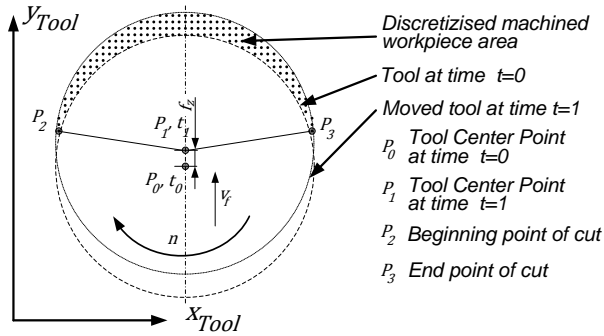

Fig. 7. - Simulation development in stages

With stage one the representation of a Z-map is applied, built upon the kinematics of the penetration between tool and workpiece. In addition, an analytical geometry model calculates geometric intervention points within the XY-level of the tool in the time range of a tooth feed  $f_z$  without taking vibrations into account (Figure 8)



**Fig. 8.** - View XY-level of the geometric cover of two tool positions

The intervention points determined are used for the calculation of an average cutting depth  $h_m$  (Formula 1).

$$P_1 - P_0$$

**Formula 1.** - Berechnung der averaged cutting thickness auf geometrischer Grundlage

Furthermore, the average cutting depth  $a_{pm}$  (Formula 2 and Figure 9) can be shown via a calculated value through the penetrated heights  $z_{i,j}$  and their number  $n_z$  in Z-direction.

$$a_{pm} = \frac{\sum \Delta z_{i,j}}{n_z}$$

**Formula 2.** - Averaged cutting depth

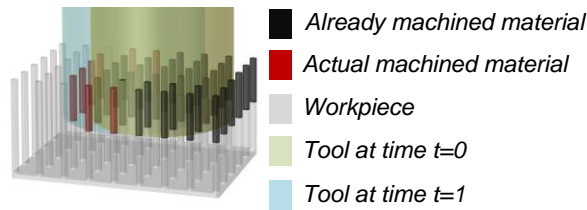

**Fig. 9.** - Geometrical cutter-workpiece engagement

On the basis of the two values calculated,  $h_m$  and  $a_{pm}$ , the Victor/Kienzle [13] force model for calculating a determined machining force can be applied. Because this procedure only permits 3-axis machining and only a rough determination of the machining forces, the considerably more accurate NCSK has been coupled via an FMI for Co-Simulation as a further alternative. The NCSK works with a three-dexel model for



the workpiece, a swept-volume model for the workpiece and a defined cutting edge for the determination of the machining forces.

A force model, which delivers the machining forces which can be arbitrary in terms of magnitude, direction and application can in turn be applied to the geometric sizes determined. These are applied to the workpiece and tool in the vicinity of the working point for the process and will result in the deflection of the sub-system involved. This deflection in turn has a direct influence on the common penetration and the resultant geometric machining parameters.

### **3    METHODICAL ASPECTS OF THE SIMULATION OVER A LONG PERIOD OF TIME**

The simulation over a long period of time should be considered here to be a complete simulation process for an existing NC program. To do so systems are employed here, which are closer to the real machine/controller combination than is possible with the classical post-processor CAD/CAM or NC programming systems. Alongside the verification - so, the assurance of freedom from errors in the sense of collision avoidance and guaranteed achievement of the required surface qualities and dimensional accuracy - the objective of a simulation process is also increasingly the reduction of unutilised safety reserves, which lie in the technical process parameters and which finally lead to a non-optimum primary processing time or secondary processing time. In order to be able to utilise these reserves and thus to be able to reduce machining times and tool costs, the consideration of further influences is required in the simulation. With BC code based verification systems this is not normally possible, as the constraint that the NC code is dealt with as a whole significantly increases the difficulty of a more detailed evaluation. Influences of the machine tool control system for example remain almost completely disregarded.

Coupled with a real CNC controller a simulation on the other hand can provide significantly more statements about an NC program and the resultant machining [15], as it evaluates the control signals generated for the individual axes directly, for example.

#### **3.1   Virtual Machine Tool Environment (VMTE)**

Alongside the transfer and processing of the data, the incorporation of information generated on the CNC control system side (e.g. corner rounding, reduced approach torques or feed limitations) also requires a simulation model, where this can be illustrated. One such model has been developed - the Virtual Machine Tool Environment (VMTE). It provides a basic model in the sense of a Co-Simulation, which enables the processing of CNC control system control signals to machine model transformation information. Two important requirements arise from the application conditions described:

- The VMTE shall be quick and simple to create, as well as
- realtime-capable and modular,

in order to achieve many iterations, a broad application spectrum and a high utility value.

### **3.2 The rapid path to VMTE**

The process developed for creating the simulation models allows the use of generally available information and data for a machine tool and thus very quick creation of a VMTE, so that this can be economically used in many new areas of application.

#### **3.2.1 Prerequisites.**

In order to be able to use the VMTE as a planning and development tool, it must be able to be quickly adapted to the specific tasks for which it is required. Frequent changes to the machine configuration are normal in the early phase of development and planning as part of the process development and process checking. A wide range of different machines with differing configurations is also necessary for basic training and advanced training purposes. The consideration of established machine design variations in conjunction with the final operational sequence is an important point of the operational fine planning for the utilisation of VMTE in the manufacturing phase.

Machine tools are generally based on serial kinematics. The most important tasks in the development of a model for illustrating these serial kinematics are the development of the kinematics on the basis of the machine configuration and the linking of the graphical data with each axis. The basic mechanism for the transformation of the original CAD data and the transfer into graphical data as well as its population with machine functions can be largely generalised such that a VMTE can be created in less than 30 minutes.

#### **3.2.2 Generalised virtual machine.**

In order to achieve this the emphasis is not on the linking, in order to illustrate the kinematics, but rather the axes which represent the real components. This approach is closer to reality and results in the position of the axes being directly adjustable with respect to one another. There is also no need for additional parameters such as in the DH convention [16]. The mobility of the model (and thus the movement of its axes) is achieved through the decomposition of one axis into two axis modules and their displacement or rotation with respect to one another.

In doing so an axis module has a zero point and a connection point, whose position and orientation with respect to one another will be described through a transformation matrix and which define the interior of the module (Figure 10). The combination of two modules (basic part and mobile part) describes the configuration of an axis. The mobile part will be moved relative to the basic part (likewise through a transformation matrix), whereby the typical axis characteristics will be realized.

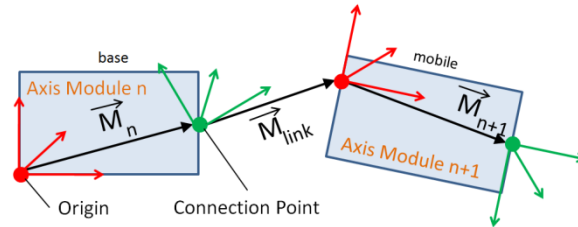

**Fig. 10.** - Generalized axis pattern for serial kinematics

Any arbitrary machine tool with serial kinematics can be prepared as a fully mobile virtual machine model through the use of multiple axes and axis chains (Figure 11).

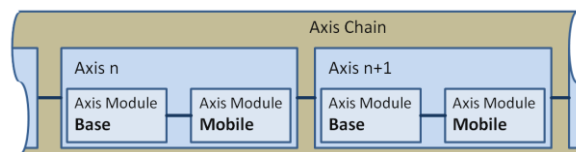

**Fig. 11.** - Configuration scheme for axis chains

The set-up interface which is thus finally fully parameterized can also be considered an interface and can be supplied with information provided from outside. The CNC control system provides one such interface for example.

### 3.3 VMTE for simulation of a long period of time

Many intrinsic controller characteristics can also be considered with large time spans during the verification of the analysis through the coupling of the machine model and a real or virtual CNC control system, and these would otherwise have to have been modelled. Due to its

- very short creation time,
- ability to be fully parameterised and
- intrinsic consideration of CNC controller influences

the kinematic base model provided offers itself as a basis for a virtual machine environment (Figure 12). The fully parameterised interface enables changes to be made to the configuration whilst the simulation is running, so that various different configurations can be used as the subject-matter of the simulation or so that the simulation can take account of the configuration changes.

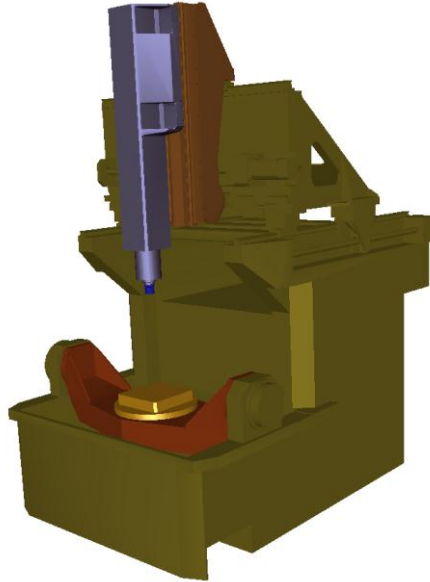

Fig. 12. - Sample VMT Ops Ingersoll Funkenerosion GmbH SH 650

#### **4 OUTLOOK - THE COMPREHENSIVE MANUFACTURING SIMULATION**

The sub-processes detected in the VMTE, but which cannot be simulated there in sufficient detail, can be considered and evaluated downstream or in the meantime through the increased degree of detail in an enlargement of arbitrary resolution. In doing so not only can the time steps be reduced - thus increasing the slow-motion - but also the resolution of the model (e.g. FE meshes) in question can be increased.

The combination of a simulation for a large time period and detailed process simulation enables the comprehensive evaluation of the complete manufacturing process as well as the parameters and influencing variables involved in it, both in a holistic context and in detail.

In order to achieve this, the two simulations must interact with one another. This is achieved through the parametrisation of the two simulations. Thus the VMTE can transfer a parameterised machine tool model to the process simulation and can detect and specify the periods of time to be considered. The highly accurate analyses in small time periods received from the process simulation can be returned and used for consideration or correction of the VMTE in large time periods, where small changes have a significant impact.

The approach presented unites geometrical/kinematic simulation methods for a large time period and restricted degree of detail, with highly detailed methods such as MKS and FEA analysis for small time periods. In this way the advantages of both methods can be utilised and their disadvantages reduced.

## 5 REFERENCES

1. JACOBS, H.-J.; DÜRR, H.: „Entwurf und Gestaltung von Fertigungsprozessen : Planung und Steuerung der spanenden Teilefertigung“. München : Fachbuchverl. Leipzig im Carl-Hanser-Verl/2002. – ISBN 3446217487
2. DENKENA, B.; KÖHLER, J.: „Energieeffiziente Zerspanung“, In: VDI-Z, Special Werkzeuge August 2010, II/2010, S. 20-22.
3. SCHINDLER, Jens.: „Quelle zur Produktivitätssteigerung und Kostensenkung in der Produktion“. In: Nestler, A. (Hrsg.): Intelligente Fertigungsprozesse – Quelle zur Produktivitätssteigerung und Kostensenkung in der Produktion. Vortragsband zum Fachkolloquium am 24. September 2010. Dresden: Selbstverlag TU Dresden, ISBN 978-3-86780-185-0
4. SUN, S.; LUO, L.; LI, G.; ZOU, X.; YANG, J.: “The virtual simulation system of numerical control machining. Proceedings of the 2008 international workshop on modelling, simulation and optimization”, WMSO 2008. 2009. p.289–293
5. ZHU, L.; WANG, J.; CHEN, E.; YANG, J.; WANG, W.: “Applications of virtual reality in turn-milling centre.” In: Proceedings of the IEEE international conference on automation and logistics, ICAL 2008, 2008. p.2302–2305
6. LEE, S.W.; NESTLER, A.: “Modeling of Cutting Force for Cylindrical Milling Cutter and Feed Rate Optimization Using Five-Axis Milling Simulation.” In: Proceedings of 8th International Conference on High Speed Machining (HSM), pp. 64-70, Metz, France, 08-10 December 2010, ISBN 978-2-9534170-2-9
7. VORMANN, K.; MARSOLEK, J.; PIENDL, S.; SCHERMAN, T.; STEINICKE, M.; FIDERER, Michael; KLOCKE, F.; FRANK, P.; SELLMER, D.: „Abschlussbericht des Verbundforschungsprojektes Simulation industrieller Bearbeitungsprozesse (SindBap)“. Tagungsband zum Abschlusskolloquium
8. N. N.: “SimulationX - Multi-domain System Simulation and Modeling”, ITI GmbH, [Online]. Available: <http://www.itisim.com>
9. Modelica Association: “Functional Mock-up Interface” [Online]. Available: <http://modelisar.com>
10. M. Inui und R. Kakio, „Fast Visualization of NC-Milling Result using graphics Acceleration Hardware,“ Proceedings of the IEEE International Conference on Robotics & Automation, 2000.
11. LEE, S.W.; NESTLER, A.: “Tool load balancing at simultaneous five-axis ball-end milling via the NC simulation kernel.” 1st CIRP Conference on Virtual Machining Process Technology (CIRP VMPT), Paper 33, 28th May -1st June 2012, Montréal, Canada
12. Calculix, „A Free Software Three-Dimensional Structural Finite Element Program,“ [Online]. Available: <http://www.calculix.de/>
13. O. Kienzle und H. Victor, „Spezifische Schnittkräfte bei der Metallbearbeitung,“ Werkstatttechnik und Maschinenbau, Nr. 47, 1957
14. Kao, Y. C. ; Cheng, H. Y. ; Chen, Y. C.: Development of a virtual controller integrating virtual and physical CNC. In: PROGRESS ON ADVANCED MANUFACTURE FOR MICRO/NANO TECHNOLOGY 2005, PT 1 AND 2 505-507 (2006), S. 631–636
15. Kadir, A. vA., Xu, X., Hämmerle, E.: Virtual machine tools and virtual machining—A technological review, Robotics and Computer-Integrated Manufacturing. Volume 27, Issue 3, June 2011, Pages 494-508, ISSN 0736-5845
16. Denavit, J., Hartenberg, R.S.: A kinematic notation for lower-pair mechanisms based on matrices. Trans ASME J. Appl. Mech, Vol. 23, Page 215-221, 1955