



**HAL**  
open science

## Model-Based Approach for Self-correcting Strategy Design for Manufacturing of Small Metal Parts

Mikhail Borzykh, U. Damerow, Christian Henke, Ansgar Trächtler, W.  
Homberg

► **To cite this version:**

Mikhail Borzykh, U. Damerow, Christian Henke, Ansgar Trächtler, W. Homberg. Model-Based Approach for Self-correcting Strategy Design for Manufacturing of Small Metal Parts. 6th Programming Languages for Manufacturing (PROLAMAT), Oct 2013, Dresden, Germany. pp.320-329, 10.1007/978-3-642-41329-2\_31 . hal-01485826

**HAL Id: hal-01485826**

**<https://inria.hal.science/hal-01485826>**

Submitted on 9 Mar 2017

**HAL** is a multi-disciplinary open access archive for the deposit and dissemination of scientific research documents, whether they are published or not. The documents may come from teaching and research institutions in France or abroad, or from public or private research centers.

L'archive ouverte pluridisciplinaire **HAL**, est destinée au dépôt et à la diffusion de documents scientifiques de niveau recherche, publiés ou non, émanant des établissements d'enseignement et de recherche français ou étrangers, des laboratoires publics ou privés.



Distributed under a Creative Commons Attribution 4.0 International License

# Modell-Based Approach for Self-Correcting Strategy Design for Manufacturing of Small Metal Parts

M. Borzykh<sup>1</sup>, U. Damerow<sup>2</sup>, C. Henke<sup>3</sup>, A. Trächtler<sup>4</sup>, W. Homberg<sup>5</sup>

<sup>1</sup>Project Group Mechatronic Systems Design, Fraunhofer Institute for Production Technology  
IPT, Zukunftsmeile 1, 33102 Paderborn, Germany  
Mikhail.Borzykh@ipt.fraunhofer.de

<sup>2</sup>Forming and Machining Technology (LUF),  
University of Paderborn, Warburger Str. 100, 33098 Paderborn, Germany  
ud@luf.uni-paderborn.de

<sup>3</sup>Project Group Mechatronic Systems Design, Fraunhofer Institute for Production Technology  
IPT, Zukunftsmeile 1, 33102 Paderborn, Germany  
Christian.Henke@ipt.fraunhofer.de

<sup>4</sup>Control Engineering and Mechatronics (RtM) University of Paderborn,  
Fürstenallee 11, 33102 Paderborn, Germany  
Ansgar.Traechtler@hni.uni-paderborn.de

<sup>5</sup>Forming and Machining Technology (LUF), University of Paderborn,  
Warburger Str. 100, 33098 Paderborn, Germany  
wh@luf.uni-paderborn.de

**Abstract.** The compliance of increasing requirements on the final product often constitutes a challenge in manufacturing of metal parts. The common problem represents the precise reproduction of geometrical form. The reasons for form deviation can be e.g. varying properties of the semi-finished product as well as wear of the punch-bending machine or the punch-bending tool itself. Usually the process parameters are manually adjusted on the introduction of new production scenario or after the deviation between the actual form of produced pieces and the designed form become clear. The choice of new process parameters is normally based on the experience of the machine operators. It leads to a time-consuming and expensive procedure right on the early stages of production scenarios as well as during the established production process. Furthermore, the trend of miniaturization of part sizes along with narrowing tolerances and increase in the strengths of materials drastically pushes up the requirements on the production process.

Aiming at reduction of scrap rate and setup-time of production scenarios, a model-based approach is chosen to design a self-correcting control strategy. The strategy is designed by modeling the bending process. In the first step the bending process has to be analyzed on the model by varying of process variables influencing the process significantly. It is done by corresponding simulations. After that, the correlations between significant variables and geometrical deviation were defined and different self-correcting control strategies were designed and tested. In order to identify and validate the simulation and to test the quality of the self-correcting control strategies, a special experimental tool was built up. The experimental tool is equipped with an additional measurement de-

vice and can be operated on a universal testing machine. Finally, the self-correcting control strategies were tested under real production conditions on the original tool in order to address further influences of the punch-bending machine on the manufacturing process.

**Keywords:** Metal parts, punch-bending process, control strategies, model-based design, manufacturing engineering

## 1 INTRODUCTION

The increasing international competition on the one hand and the trend toward miniaturization of components on the other hand represent the challenges for manufacturers of electrical connection technology. To meet these challenges, the new production technologies with smart tools should be developed.

Complex metal parts e.g. plug contacts being used in the electrical connection technology are currently produced on cam disc based punch-bending machines. These machines are mechanically working and use the same adjustments for all production steps. Due to the on-going trend of reduction in size of produced parts with simultaneous decreasing tolerances and use of high strength materials, geometrical deviations of the final product appear increasingly. The use of punch-bending machines with NC-controlled axis allows a more flexible set up in comparison to cam disk based machines.

The figure 1 presents the active structure of the conventional bending process using a punch-bending machine with two NC-controlled axes. Material flow runs from the feed/punch through bending and correction punch down to the chute. The advantage here is that the operator selects a product to be manufactured and the movements of the each axis are automatically generated. In this case, for the production two punches are used: bending and correction punch. The operator thereby receives the status and the information about the machine, but not about the manufacturing process.

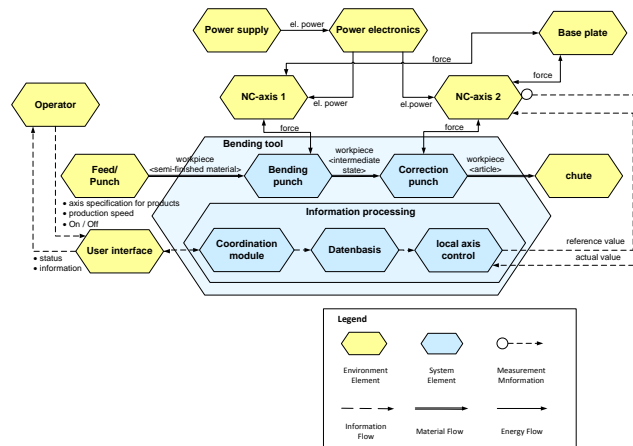
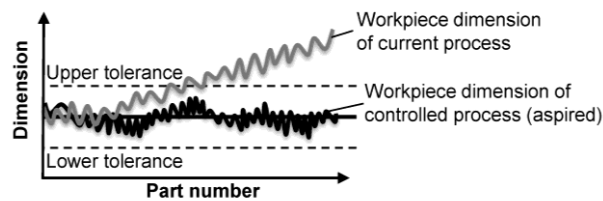

Fig. 1. - Active structure of the conventional bending process

Today, when undesirable geometrical deviations appear, the new process parameters have to be set by the operator based on his or her personal experience. These targeted interventions are only possible when the punch-bending machine is stopped. Hence, this procedure is very time consuming especially when it is necessary to perform it more than once. Besides that, frequent leaving of the tolerances leads to high scrap rate. The failure to reproduce form of the element within allowable tolerances is caused by varying shape or strength of the semi-finished material (flat wire) as well as the thermal and dynamical behavior and wears phenomena of the punch-bending machine itself or of the punch-bending tool.

## 2 OBJECTIVE

The aim of a project at the Fraunhofer Institute for Production Technology (IPT) in cooperation with the University of Paderborn is to develop a punch-bending machine being able to react adaptively on changing properties of the process as well as on variability of the flat wire properties. This aim is targeted in implementation of a self-correcting control strategy. Figure 2 shows the enhancement of a controlled process keeping the nominal dimension within the tolerances compared with the current non-controlled situation.



**Fig. 2.** - Non-controlled and controlled processes

The short-circuit bridge (Fig. 3) was employed as a basic element for the process of control strategy development. The geometrical shape is created in the first two bending steps and with the last bending step the opening dimension is adjusted.

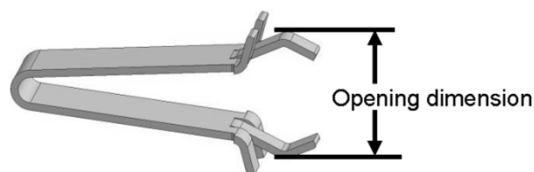

**Fig. 3.** - Short-circuit bridge

In order to keep the opening dimension of the short circuit bridge within the tolerances, it is necessary to detect a leaving of the allowable interval first and then to take appropriate corrective action by a punch in the next step. Development of a self-

correcting control strategy needs all components of the process to be taken into account. Therefore, machine behavior has to be analyzed as well as the behavior of the tool, the flat wire and workpiece shape. Additional measurement devices have to be developed in order to measure process variables such as the opening dimension of the short circuit bridge and the punch force. In a self-correcting control strategy, the measured process variables are used to calculate the corrected punch movement by an algorithm in a closed-loop mode. Furthermore, the position accuracy of the punch-bending machine axis as well as of the punches of the tool is analyzed by means of displacement transducers.

The desired approach is similar to the VDI guidelines for the design methodology for mechatronic systems [VDI-Guideline 2206 (2004)]. The objective of this guideline is to provide methodological support for the cross-domain development of mechatronic systems. In our case, these domains are bending process, modeling and control engineering.

### **3 ANALYZING THE INITIAL PROCESS**

Gaining a basic understanding of the current process flow, the process design, the tool design, the behavior of the punch bending machine as well as of the material used for the flat wire are to be analyzed. The punch-bending tool is used to produce the short circuit bridge with three bending steps. The punches used for the single bending steps are driven by the NC-axis of the punch-bending machine. It could be observed that the geometrical deviations of the workpiece occur within short time and therefore wear phenomena are unlikely to be responsible for problems with shape of the final product and their influence can be neglected. Geometrical deviations could also result from the positioning accuracy of NC-axis or from varying properties of the semi-finished material. The positioning accuracy as given by the machine manufacturer is within 0.02 mm tolerance what was proved by additional measurements with a laser interferometer. This accuracy is sufficient for the bending process. Finally, the deviations of part's geometry are most probably caused by the changes of the flat band properties. To investigate the properties of the flat band, the model-based approach with the further identification and validation on an experimental tool was chosen.

### **4 MODEL-BASED ANALYSIS OF BENDING PROCESS**

A Multi Body System (MBS)-model of the bending process was built up for analysis and design of the control strategy. There are a number of models for the simulation detailed in various literatures [Ridane, N. (2005), Schilling, R. (1993), Heller, B. (2002)], but in our case an MBS model was chosen that consists of the workpiece, the tool, and the punch-bending machine [Wittenburg, J. (2007), Heller, B. (2002), VDI-Guideline 2206 (2004)]. The model is based on the elementary bending theory by Ludwik [Lange, K. (1990)] which showed sufficiently good results despite its limited transferability to the flat wire. This model assumes a workpiece to be built of a chain whose links are connected by a spring-damping system and torsional elements repre-

senting the material properties (Fig. 4) [Damerow, U., Borzykh, M., Homberg, W. and Trächtler, A. (2012)]. Geometries of punches were imported in the MBS-model directly from CAD-construction. The movement trajectories and velocity profiles of the punch and timing of the bending process were taken from the real process and fed into the model.

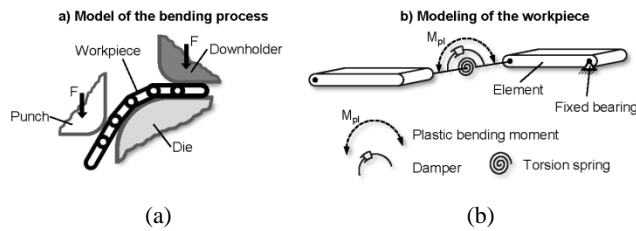

**Fig. 4.** - Setup of the MBS model: a) Modell of the bending process; b) Modelling of the workpiece

Analysis of model and simulations revealed that thickness of a workpiece exerts the greatest influence on the forming process. The figure 5 a) shows the change of the opening dimension at different thickness of workpiece with machine settings held constant. The influence of physical properties of the flat band on the bending process was also investigated. The figure 5 b) shows the change of the opening dimension at different values of the elastic modulus. The relationship between the position of the punch and the opening was determined as well.

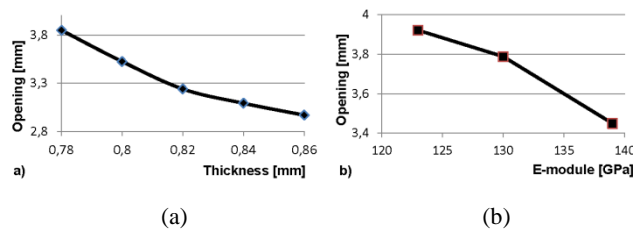
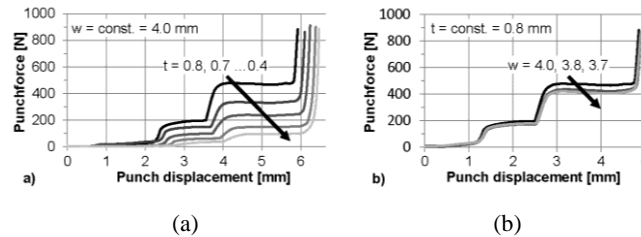

**Fig. 5.** - Simulation results: a) Influence of the material thickness on the opening, b) Influence of physical properties of the materials on the opening

## 5 TEST ON AN EXPERIMENTAL TOOL

In order to investigate the properties of real flat wire, an experimental tool representing the significant bending operations of the production was build up. The tool can be operated on a universal testing machine, allowing measurement of the punch movement and force during the whole bending process. The experimental tool is used to investigate the impact of the geometrical dimension on the flat wire when its thickness and width change. A reduction of the thickness  $t$  of the flat wire at a constant width  $w$  showed the punch force to decrease clearly (Figure 6a). But when the thick-

ness  $t$  is kept constant and the width  $w$  of the flat wire is reduced, there will be a significantly smaller decrease of the punch force (Figure 6b).



**Fig. 6.** - Influence of the thickness and width of the flat wire concerning the punch force

This behavior could also be observed during measurement of the punch force during the manufacturing of the short-circuit bridge in the production tool. There the punch is always moved on a fixed end position so by means of the punch force, the changing thickness of the flat wire can be detected indirectly. The thickness of the flat wire varies by  $\pm 0.015$  mm but remains within the admissible production tolerance set by the manufacturer. Furthermore it could be observed that the change of thickness affects the opening dimension of the flat wire significantly.

## 6 MEASUREMENT DEVICE

The opening dimension is a decisive parameter for the functioning of the short circuit bridge and has to be checked in quality assurance procedures. In order to check and to adjust the opening dimension in a defined way, it has to be measured runtime during the manufacturing process by means of contact or contactless measurement methods. Because the short circuit bridge is formed within the tool and access to it is rendered, a contactless optical measurement device has proven to be the most appropriate. For keeping the opening dimension of the short-circuit bridge within the tolerance range of 1.2 mm, a measurement accuracy of about 0.02 mm is indispensable. The measurement device has to be fast enough to detect the opening dimension of each workpiece at a production speed of 60 parts per minute. Consequently an optical measurement device has been found to be the most appropriate one.

For testing the function of the measurement method, a self-developed setup was chosen. A schematic setup of measurement device is shown below (Fig. 7). A shadow of the short circuit bridge on the level of the opening dimension is cast by a flat LED-backlight to avoid a perspective error [Hentschel, K. (1997), Demant, C. (2011)]. The shadow is received through an objective and produces dark areas on a CCD linear image sensor which detects the transition between light and dark. Knowing the size of pixels and their position in the line it is possible to calculate the opening dimension.

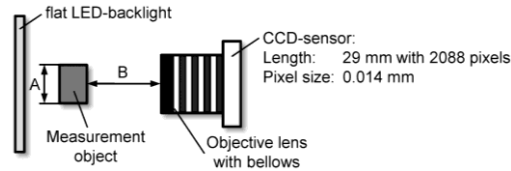

**Fig. 7.** - Setup of the optical measurement device

The information of the CCD sensor is processed via a real-time IO-system manufactured by dSpace GmbH and transferred to MatLab/Simulink, where the opening dimension is being calculated. For first investigations this self-developed setup was chosen to prove the functioning of the measurement method and to keep the costs low. The measurement result is influenced by the relative position of the measured object to the CCD sensor on one hand and by vibration or shock and contamination in the punch-bending machine on the other. First the width of the measurement object was changed in a range in which the current opening dimension varies. A very good linear connection between the width B of measurement object and dark pixels can be observed. The measure accuracy per pixel is about 0.02 mm including measurement tolerances and is accurate enough to recognize a leaving of the tolerance early. By varying the distance A at a constant width B the measurement becomes inaccurate. But observation of the real process has shown that possible movement in direction A is negligible because the short circuit bridge is fixed in the tool during the bending operations.

In order to investigate vibrations or shocks in the process an acceleration sensor was attached to the optical measurement device. When the punch-bending machine in running on 60 RPM accelerations of about 0.2 m/s<sup>2</sup> could be detected which will not affect the measurement.

Further investigations have shown that the change of thickness of the flat wire impacts the opening dimension of the short-circuit bridge. The thickness of the flat wire can be estimated indirectly by measuring the punch force in the production tool. This method showed reliable results and will keep costs low if an already existing force sensor is used.

## 7 SELF-CORRECTING STRATEGY

To build up a self-correcting strategy, it is necessary to detect the opening dimension for the each workpiece especially when it is beginning to run from the desired value to one of the tolerance limits. In the next step the punch movement has to be adapted by a defined value to correct the opening dimension. Because there is only very little time between measuring and the correcting step, a closed-loop control for the trend correction is used. Therefore the information on the current opening dimension is used for correcting the opening dimension of the next short circuit bridge. This is possible because the changes of size of the opening dimension are slight enough. After that, the punch force of the first bending step is used to determine the influence of the flat wire thickness. The information given by the punch force applied to a part



can be used for the same part because there is enough time between the measurement and the correcting bending step. So for the self-correcting strategy the opening dimension from one short circuit bridge before ( $y_{i-1}$ ) and the maximum punch force of the first bending step from the previous and current short circuit bridge ( $F_{i-1}$  and  $F_i$ ) are used together with additional constant terms ( $k_1$ ,  $k_2$ ). Figure 8 shows the schematic structure of the process control. The calculation of the control input ( $u_i$ ) for punch actuator is shown in the equation (1). Thus, the control law corresponds to the discrete I-controller [Shinners, Stanley M. (1998)].

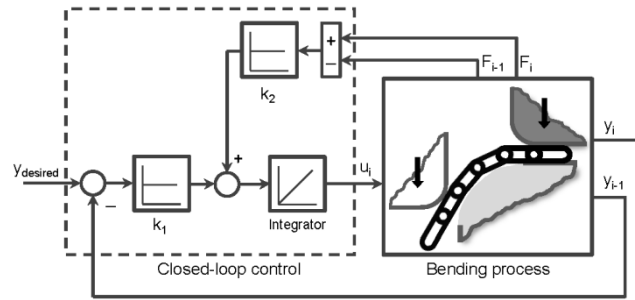

**Fig. 8.** - Schematic design of the closed-loop control for the trend correction

$$u_i = \int (k_1 \cdot (y_{desired} - y_{i-1}) + k_2 \cdot (F_i - F_{i-1})) di \quad (1)$$

where  $i$  – part number.

The coefficient  $k_1$  is calculated from the relationship between the plastic change of the opening dimension and position of the punch actuator using the bending model. The Term ( $F_i - F_{i-1}$ ) represents a discrete differentiator of the maximum punch force from the first bending step, and the coefficient  $k_2$  is calculated from the relationship between the change of the wire thickness and the maximum punch force using the bending model as well.

The figure 9 illustrates the extended active structure of the new self-correcting bending tool on the punch-bending machine with two NC-controlled axes. The conventional bending tool is extended by two components. The first new component is the integrated measuring equipment, such as camera system and force sensor. The second new component is located in the information processing. The information about the current article is collected and processed. It can be determined being the opening dimension in the tolerance or not. Furthermore, the new adjustment path for the correction punch can be calculated. Thus, the on-line process regulation is realized. Additionally, the operator must set up the tolerance and the desired value for the opening dimension.

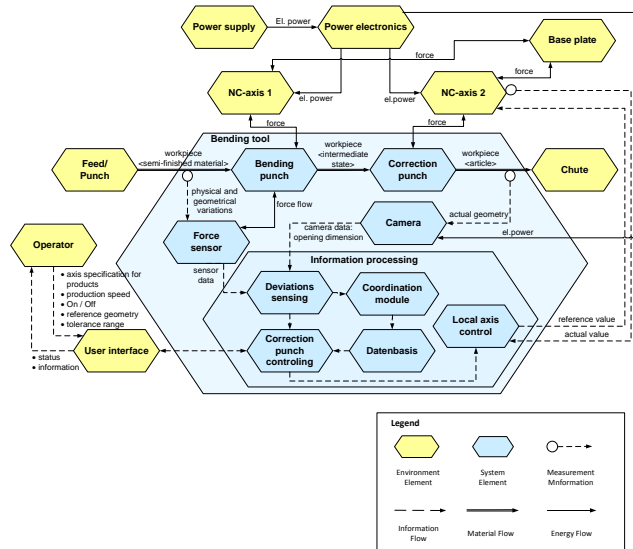

Fig. 9. - Active structure of the self-correcting bending process

A first verification of the self-correcting strategy was carried out on the real short circuit bridge by using the experimental tool. These tests showed very good results with a stable performance of the closed-loop control. Nevertheless, the experimental tool could not be used to test the self-correcting strategy under production conditions. By implementing the optical measurement device into the production tool and the algorithm of the self-correcting control strategy into the controller of the punch-bending machine, a test under production condition could be carried out. At the production speed of 60 RPM of the punch-bending machine the opening dimension as well as the punch force could be measured reliable and the closed-loop control showed a stable behavior so the opening dimension of the short circuit bridge could be held within the tolerances (Fig. 10).

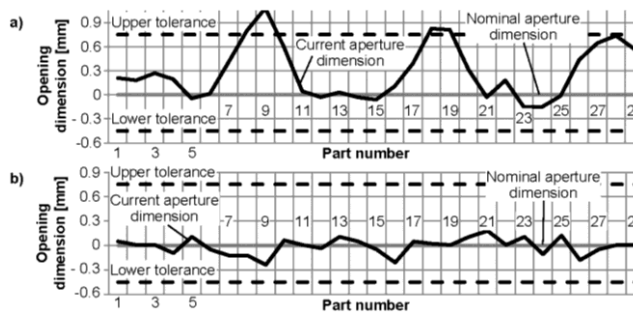

Fig. 10. - Measured trend of the opening dimension without (a) and with (b) the self-correcting strategy

## 8 CONCLUSIONS

The trend in the electrical connection technology goes to a minimization of the metal part size and narrowing of tolerances. Because of unavoidable varying properties of the high strength materials the small tolerances can be only kept under a high scrap rate and a large expenditure of time. In this case the production process of a short circuit bridge was used to reduce scrap rate and the setup time of the process. Therefore a self-correcting strategy based on a closed loop control was built up. This self-correcting strategy uses geometrical dimensions of the workpiece measured during the bending process to be able to keep the opening dimension of the short circuit bridge by a correcting bending step within the tolerances over the whole process period.

## 9 ACKNOWLEDGEMENTS

We express our deep gratitude to the AiF/ ZIM for funding this project. We would like to gratefully acknowledge the collaborative work and support by our project partners Otto Bihler Maschinenfabrik GmbH & Co. KG and Weidmüller Interface GmbH & Co. KG.

## 10 REFERENCES

1. Damerow, U., Borzykh, M., Homberg, W. and Trächtler, A.: A self-correcting approach for the bending of metal parts, 15th ESAFORM Conference, Erlangen, March 14th-16th, 2012
2. Demant, C., Streicher-Abel, B., Springhoff, A. (2011). Industrielle Bildverarbeitung, Berlin, pp. 195-225.
3. Shinnars, Stanley M. (1998). Modern Control System Theory and Design, Second Edition, John Wiley & Sons, INC.
4. Heller, B. (2002). Halbanalytische Prozess-Simulation des Freibiegens von Fein- und Grobblechen, PhD.Thesis, University of Dortmund.
5. Hentschel, K., Müller, M., F + M, (1997). Feinwerktechnik, Mikrotechnik, Mikroelektronik, Vol. 105, Issue 10, pp. 738-740.
6. Lange, K. (1990). Umformtechnik, Handbuch für Industrie und Wissenschaft, Vol. 3: Blechbearbeitung, Berlin, pp. 244-306.
7. Ridane, N., Jaksic, D., Kleiner, M., Heller, B. (2005). Enhanced semi-analytical process simulation of air bending, Advanced Materials Research, Vol. 6-8, pp. 29-736.
8. Wittenburg, J. (2007). Dynamics of Multibody Systems, Second Edition, Springer-Verlag.
9. Schilling, R. (1993). Sheet bending and determination of residual stresses by means of FEM, Steel Research Volume 64, Issue 5, pp. 255 - 261.
10. VDI-Guideline 2206 (2004). Design methodology for mechatronic systems.