



HAL
open science

A stochastic approach for optimizing green energy consumption in distributed clouds

Benjamin Camus, Fanny Dufossé, Anne-Cécile Orgerie

► **To cite this version:**

Benjamin Camus, Fanny Dufossé, Anne-Cécile Orgerie. A stochastic approach for optimizing green energy consumption in distributed clouds. SMARTGREENS 2017 - International Conference on Smart Cities and Green ICT Systems, Apr 2017, Porto, Portugal. hal-01475431

HAL Id: hal-01475431

<https://inria.hal.science/hal-01475431>

Submitted on 23 Feb 2017

HAL is a multi-disciplinary open access archive for the deposit and dissemination of scientific research documents, whether they are published or not. The documents may come from teaching and research institutions in France or abroad, or from public or private research centers.

L'archive ouverte pluridisciplinaire **HAL**, est destinée au dépôt et à la diffusion de documents scientifiques de niveau recherche, publiés ou non, émanant des établissements d'enseignement et de recherche français ou étrangers, des laboratoires publics ou privés.

A stochastic approach for optimizing green energy consumption in distributed clouds

Benjamin Camus¹, Fanny Dufossé² and Anne-Cécile Orgerie³

¹*Inria, IRISA, Rennes, France, benjamin.camus@inria.fr*

²*Inria, CRISTAL, Lille, France, fanny.dufosse@inria.fr*

³*CNRS, IRISA, Rennes, France, anne-cecile.orgerie@irisa.fr*

Keywords: Data centers, distributed clouds, energy efficiency, renewable energy, scheduling, on/off techniques.

Abstract: The energy drawn by Cloud data centers is reaching worrying levels, thus inciting providers to install on-site green energy producers, such as photovoltaic panels. Considering distributed Clouds, workload managers need to geographically allocate virtual machines according to the green production in order not to waste energy. In this paper, we propose SAGITTA: a Stochastic Approach for Green consumption In disTributed daTA centers. We show that compared to the optimal solution, SAGITTA consumes 4% more brown energy, and wastes only 3.14% of the available green energy, while a traditional round-robin solution consumes 14.4% more energy overall than optimum, and wastes 28.83% of the available green energy.

1 INTRODUCTION

The rapid increase of demand for Internet services leads Cloud providers to build more and more data centers for hosting these services. The data centers that constitute the Cloud infrastructures are usually geographically distributed for security reasons or to offer lower latency for their clients. This infrastructure increase comes with a dramatic growth of the power consumption globally drawn by data centers. As an example, in 2014, data centers in the U.S. consumed an estimated 70 billion kWh, representing about 1.8% of total U.S. electricity consumption (Shehabi et al., 2016).

To reduce this impact, Cloud providers resort to renewable energy sources which are either on-site or off-site (Tripathi et al., 2016). Such energy sources are mostly intermittent by nature (wind, sun, etc.) with high variations, and periods of time without any production (during night for instance for photovoltaic panels). Energy storage devices can help to overcome this issue. But, they constitute a costly investment and they intrinsically lose part of the energy stored (Wang et al., 2012). Thus, without storage, renewable energy has to be consumed upon production or it is wasted. In this context, optimizing renewable energy consumption requires to know local availability for the distributed cloud infrastructure, in order to adequately allocate computing resources to incoming user requests. The goal is to geographically distribute the workload among the data centers so that, it fits at

best the on-site renewable energy production, which is variable and not known in advance.

In this paper, we consider the problem of scheduling workload across multiple data centers for minimizing renewable energy loss. To solve this issue, we propose SAGITTA: a Stochastic Approach for Green consumption In disTributed daTA centers. SAGITTA uses a stochastic approach for estimating renewable energy production, and a greedy heuristic for allocating resources to the incoming user requests. Our simulation-based results show the efficiency of SAGITTA compared to classical allocation approaches. Indeed, compared to the optimal solution, SAGITTA consumes 4% more energy overall, and wastes only 3.14% of the available green energy, while a classical round-robin solution consumes 14.4% more energy overall than optimum, and wastes 28.83% of the available green energy.

The remainder of the paper is structured as follows. Related work is presented in Section 2. Section 3 details the SAGITTA approach. A simulation-based evaluation is conducted, simulation conditions are described in Section 4 and results are provided in Section 5. Future work is discussed in Section 6.

2 RELATED WORK

Cloud infrastructures consist in geographically distributed data centers which are linked through com-

munication networks (Wang et al., 2008). With the emergence of the Future Internet and the dawning of new IT models such as cloud computing, the usage of data centers, and consequently their power consumption, increases dramatically. As an example, for 2010, Google used 900,000 servers which consumed 1.9 billion kWh of electricity (Kookey, 2011). Other major Cloud companies present similar figures and similar issues (Katz, 2009).

Virtualization technology and its ability to pool resources through transparent sharing should have minimized worldwide data center consumption. But, the energy consumption of state-of-the-art servers grows inexorably as they embed more and more powerful cores and advanced features and technologies. Consequently, the global data center consumption keeps increasing rapidly (Shehabi et al., 2016). This situation raises major environmental, economic and social concerns.

The first way to save energy at a data center level consists in locating it close to where the electricity is generated, hence minimizing transmission losses. For example, Western North Carolina, USA, attracts data centers with its low electricity prices due to abundant capacity of coal and nuclear power following the departure of the region's textile and furniture manufacturing (Greenpeace, 2011). This region has three super-size data centers from Google, Apple and Facebook with respective power demands of 60 to 100 MW, 100 MW and 40 MW (Greenpeace, 2011).

Other companies opt for greener sources of energy. For example, Quincy (Washington, USA) supplies electricity to data facilities from Yahoo, Microsoft, Dell and Amazon with its low-cost hydro-electrics left behind following the shutting down of the region's aluminum industry (Greenpeace, 2011). Several renewable energy sources like wind power, solar energy, hydro-power, bio-energy, geothermal power and marine power can be considered to power up super-sized facilities.

In spite of these approaches, numerous data facilities have already been built and cannot be moved. Cloud infrastructures, on the other hand, can still take advantage of multiple locations to use green sources of energy with approaches such as follow-the-sun and follow-the-wind (Figuerola et al., 2009). As sun and wind provide renewable sources of energy whose capacity fluctuates over time, the rationale is to place computing jobs on resources using renewable energy, and migrate jobs as renewable energy becomes available on resources in other locations. However, the migration cost, in terms of both energy and performance, may be prohibitive (Callau-Zori et al., 2016).

Within the data center itself, a range of tech-

nologies can be utilized to make cloud computing infrastructures more energy efficient, including better cooling technologies, temperature-aware scheduling (Fan et al., 2007), Dynamic Voltage and Frequency Scaling (DVFS) (Snowdon et al., 2005), and resource virtualization (Talaber et al., 2009). The use of Virtual Machines (Barham et al., 2003) brings several benefits including environment and performance isolation; improved resource utilization by enabling workload consolidation; and resource provisioning on demand. Nevertheless, such technologies should be analyzed and used carefully for actually improving the energy-efficiency of computing infrastructures (Miyoshi et al., 2002).

Concerning green energy integration, Ren *et al.* have proposed an online scheduling algorithm which optimizes the energy cost and fairness among different data centers subject to queuing delay constraints (Ren et al., 2012). While their work is based on a distributed Cloud model similar to ours, they aim at minimizing the cost of the consumed electricity, instead of the wasted renewable energy in our case. Tripathi *et al.* have presented a mixed integer linear programming formulation for capacity planning while minimizing the total cost of ownership (Tripathi et al., 2016). Their model schedules demand considering the availability of green energy and its price variation to lower the total cost of ownership. Finally, a literature review of renewable energy integration in data centers can be found in (Deng et al., 2014).

3 SAGITTA

In this section, we present our approach named SAGITTA: a Stochastic Approach for Green consumption In disTributed daTA centers. First, the Cloud model and assumptions are described in Section 3.1. Then, Section 3.2 proposes the problem formulation. The details for computing the expected green and brown consumption are provided in Section 3.3. Finally, SAGITTA's algorithms are presented in Section 3.4.

3.1 Cloud model

We consider a distributed Cloud infrastructure comprising several data centers geographically distributed and powered by the regular electrical grid on one side and on-site photovoltaic panels (PV) on the other side. The user management of the Cloud is assumed to be centralized. This Cloud model is shown on Figure 1.

Incoming users requests can arrive at any time. Each request requires to be computed by a virtual ma-

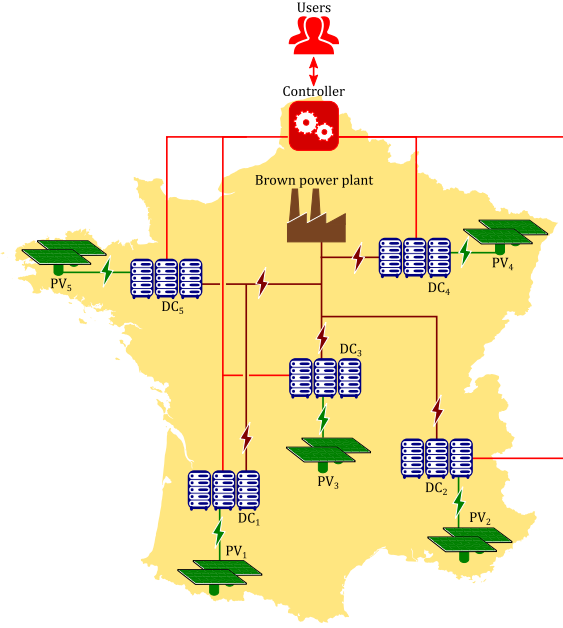

Figure 1: Considered cloud model

chine (VM) located on any of the data centers. Each data center hosts a given amount of homogeneous servers.

3.2 Problem formulation

We consider a system of M data centers spread over a large area. A data center DC_i is characterized by its number S_i of servers. Servers are considered homogeneous over the different data centers, in term of computing capabilities and energy consumption.

As for the application model, we consider identical VMs submitted at unpredictable rate. The VMs are supposed to be executable in less than one time slot. We can thus describe both computing and memory requirement of VMs by the number C of VMs that a server can complete in a single time slot. We consider that a server consumes at full capacity a power of P_s .

Finally, the energy consumption of a data center DC_i is proportional to its number of servers ON at current time slot t , $U_i(t)$. The total power consumed by the system is thus

$$\sum_{i=1}^M P_s \times U_i(t).$$

This power requirement is to be compared with the green power produced at each data center. We model the green power available at time slot t in data center DC_i as a random variable $G_i(t)$ that follows a truncated normal distribution of mean $Eg_i(t)$ and

standard deviation $p_i(t)$, with lower limit 0. Thus, the brown power consumed at time slot t in DC_i is equal to

$$\max(P_s \times U_i(t) - G_i(t), 0).$$

Our problem consists in allocating VMs to data centers, in order to minimize the consumption of brown energy. VMs are allocated by time slots. Then, our objective is to turn ON the adequate number of servers on the better locations for this criteria. We denote $N(t)$ the number of waiting VMs at time slot t . We thus need to have enough servers ON for all waiting VMs at time slot t :

$$\sum_{i=1}^M U_i(t) \geq N(t)/C.$$

All these notations are summarized in Table 1.

3.3 Expected green and brown consumption

We now evaluate the expected brown power consumption of data center DC_i at time t with n_S servers ON, $Ec_i(n_S, t)$. We first evaluate the density function of the random variable of the green power generation of DC_i at time t $G_i(t)$.

Let X be a random variable following a normal distribution of parameters $Eg_i(t)$ and $p_i(t)$, density function

$$\phi(t) = \frac{1}{p_i(t)\sqrt{2\pi}} e^{-\frac{1}{2}\left(\frac{t-Eg_i(t)}{p_i(t)}\right)^2}$$

and distributive function

$$\Phi(t) = \frac{1}{2} \left(1 + \operatorname{erf} \left(\frac{t - Eg_i(t)}{p_i(t)\sqrt{2}} \right) \right).$$

Then, for $x > 0$,

$$\begin{aligned} P(G_i(t) < x) &= P(X < x | X > 0) \\ &= \frac{P(0 < X < x)}{P(X > 0)} \end{aligned}$$

and the density function of $G_i(t)$ equals

$$\phi_i(t) = \frac{\phi(t)}{P(X > 0)}.$$

Let $B_i(t)$ be the random variable of the brown consumption of DC_i at time slot t . For the sake of simplicity, we denote $P = n_S \times P_s$ the power consumed by DC_i at time t . Then,

$$\begin{aligned} Ec_i(n_S, t) &= E(B_i(t) | G_i(t) \geq P) P(G_i(t) \geq P) \\ &\quad + E(B_i(t) | G_i(t) < P) P(G_i(t) < P) \\ &= E(B_i(t) | G_i(t) < P) \times P(G_i(t) < P) \\ &= \left(P - \frac{\int_0^P x\phi_i(x)dx}{P(G_i(t) < P)} \right) \times P(G_i(t) < P) \\ &= P \times P(G_i(t) < P) - \int_0^P x\phi_i(x)dx \\ &= P \times \frac{P(0 < X < P)}{P(X > 0)} - \frac{\int_0^P x\phi(x)dx}{P(X > 0)} \\ &= P \times \frac{\Phi(P) - \Phi(0)}{1 - \Phi(0)} - \frac{\int_0^P x\phi(x)dx}{P(X > 0)} \end{aligned}$$

Table 1: Table of Notations

| Notation | Definition |
|-------------------|--------------------------------------------------------------------------------------|
| Constants | |
| M | Number of data centers |
| DC_i | Data center number i |
| S_i | Number of servers in data center i |
| C | Maximum number of VMs in parallel on a server |
| P_s | Maximum power consumption of a server |
| Variables | |
| $N(t)$ | Number of incoming VMs for time slot t (input) |
| $U_i(t)$ | Number of machines ON at current time slot on data center i (output) |
| $G_i(t)$ | Random variable of the green power produced at time slot t |
| $Eg_i(t)$ | Expected green power generation at data center i during time slot t (input) |
| $p_i(t)$ | Standard deviation of green power generation on data center i (input) |
| w | Workload portion (number of VM): $0 < w \leq N(t)$ (input) |
| $Ec_i(n_S, t)$ | Expected brown consumption of data center i with n_S servers ON at time slot t |
| Parameters | |
| Z | Constraint for reallocation |

We now compute this integral:

$$\begin{aligned}
\int_0^P x\phi(x)dx &= \int_0^P \frac{x}{p_i(t)\sqrt{2\pi}} e^{-\frac{1}{2}\left(\frac{x-Eg_i(t)}{p_i(t)}\right)^2} dx \\
&= \int_0^P \frac{1}{p_i(t)\sqrt{2\pi}} (x-Eg_i(t)) e^{-\frac{1}{2}\left(\frac{x-Eg_i(t)}{p_i(t)}\right)^2} dx \\
&+ \int_0^P \frac{Eg_i(t)}{p_i(t)\sqrt{2\pi}} e^{-\frac{1}{2}\left(\frac{x-Eg_i(t)}{p_i(t)}\right)^2} dx \\
&= \frac{p_i(t)}{\sqrt{2\pi}} \left(- \left[e^{-\frac{1}{2}\left(\frac{x-Eg_i(t)}{p_i(t)}\right)^2} \right]_0^P \right) \\
&+ Eg_i(t)P(0 < X < P) \\
&= p_i(t)^2(\Phi(0) - \Phi(P)) + Eg_i(t)(\Phi(P) - \Phi(0))
\end{aligned}$$

Finally, we obtain:

$$Ec_i(n_S, t) = (P - Eg_i(t)) \frac{\Phi(P) - \Phi(0)}{1 - \Phi(0)} - p_i(t)^2 \frac{\Phi(0) - \Phi(P)}{1 - \Phi(0)},$$

$$\text{with } \phi(x) = \frac{1}{p_i(t)\sqrt{2\pi}} e^{-\frac{1}{2}\left(\frac{x-Eg_i(t)}{p_i(t)}\right)^2}, P = n_S \times P_s$$

$$\text{and } \Phi(x) = \frac{1}{2} \left(1 + \operatorname{erf} \left(\frac{x-Eg_i(t)}{p_i(t)\sqrt{2}} \right) \right).$$

3.4 Algorithms description

Our SAGITTA approach uses several algorithms to take decisions and allocate VMs to physical servers. These algorithms are designed to determine at any time slot on which data center to turn ON and OFF servers. At each time slot, our constraint is to turn ON the minimum number of servers that allows for executing all requested VMs, that is $\lceil N(t)/C \rceil$.

The general algorithm (Algorithm 1) is designed as follows. It first determines if the number of servers available is under or over the requested number. If there is not enough servers ON, Algorithm 2 determines the location of servers to switch on. If some servers are unnecessary, Algorithm 3 determines where servers should be shut down. These decisions are done regarding the expected green energy

Algorithm 1: General algorithm

```

if  $\sum_{1 \leq i \leq M} U_i(t) < \lceil \frac{N(t)}{C} \rceil$  then
    Switch on decision; (Algorithm 2)
else if  $\sum_{1 \leq i \leq M} U_i(t) > \lceil \frac{N(t)}{C} \rceil$  then
    Switch off decision; (Algorithm 3)
end if
Transfer decision; (Algorithm 4)
for  $1 \leq i \leq M$  do
    Let  $U_i(t)$  servers on and fill them, switch off the rest;
end for

```

production in the different data centers. More precisely, Algorithm 2 compares the expected extra cost in brown energy consumption c_i induced by an additional server ON on any datacenters, and selects the data center with minimum expected extra cost. The variable $U_i(t)$ is then incremented, but the servers are only switched on at end of Algorithm 1, when all decisions are taken on any data centers. The same way, Algorithm 3 selects one by one the servers to switch OFF to maximize the expected gain.

Finally, Algorithm 4 evaluates if the brown power consumption could be reduced by transferring the available processing power from one data center to another. More precisely, the algorithm determines some location where a fixed number of servers is turned off, and a new location where the same number of servers is turned on. One server is selected for switch OFF on the data center of maximum gain and another one to switch ON on the data center of minimum cost, if the gain on the first data center exceed the cost on the second one. However, an excessive

Algorithm 2: Switch on decision

```
for  $1 \leq i \leq M$  do
  if  $U_i(t) < S_i$  then
    Compute  $c_i = Ec_i(U_i(t) + 1) - Ec_i(U_i(t))$ ;
  else
     $c_i = C \times P_s + 1$ ;
  end if
end for
while  $\sum_{1 \leq i \leq M} U_i(t) < \lceil \frac{N(t)}{C} \rceil$  do
  Find  $j$  such that  $c_j = \min_{1 \leq i \leq M} c_i$ ;
   $U_j(t) ++$ ;
  Recompute  $c_j$ ;
end while
```

Algorithm 3: Switch off decision

```
for  $1 \leq i \leq M$  do
  if  $U_i(t) > 0$  then
    Compute  $g_i = Ec_i(U_i(t)) - Ec_i(U_i(t) - 1)$ ;
  else
     $g_i = -1$ ;
  end if
end for
while  $\sum_{1 \leq i \leq M} U_i(t) > \lceil \frac{N(t)}{C} \rceil$  do
  Find  $j$  such that  $g_j = \max_{1 \leq i \leq M} g_i$ ;
   $U_j(t) --$ ;
  Recompute  $g_j$ ;
end while
```

turnover of workload between data centers could degrade the quality of the proposed solution. To avoid this, an additional criteria Z is added. Varying cases for this criterion are tested in Section 5.3.

After running Algorithm 4, general Algorithm 1 applies all these decisions. The selected number of servers are turned ON and OFF and all VMs are allocated to available servers.

4 VALIDATION FRAMEWORK

We evaluate our algorithm through a modeling and simulation (M&S) process. In the following, we first give an overview of the whole cloud implementation model (Section 4.1). We then detail our implementation of the data centers (Section 4.2), of the green power production (Section 4.3), of the cloud workload (Section 4.4), of the algorithm implementation (Section 4.5), and the different simulations performed (Section 4.6).

Algorithm 4: Transfer decision

```
for  $1 \leq i \leq M$  do
  Compute  $g_i$ ;
  Compute  $c_i$ ;
end for
while  $Z$  and  $\max_{1 \leq i \leq M} g_i > \min_{1 \leq j \leq M} c_j$  do
  Find  $k$  such that  $g_k = \max_{1 \leq i \leq M} g_i$ ;
  Find  $l$  such that  $c_l = \min_{1 \leq j \leq M} c_j$ ;
   $U_k(t) --$ ;
   $U_l(t) ++$ ;
  Recompute  $g_k$ ;
  Recompute  $c_l$ ;
end while
```

4.1 Simulation overview

The whole cloud implementation model is described in Figure 2. We simulate data centers using the DCSim (Data Center Simulator) discrete-event M&S tool (Tighe et al., 2012). This simulator provides the power consumption of each data center as a function of time.

We implement our algorithm in an ad-hoc way using the Java language into a simulated cloud controller. This simulator receives as inputs the green power production for each data center as well as the cloud workload (i.e. the number of VMs to deploy on the cloud for each time slot). Based on these inputs and on SAGITTA's algorithms, the controller generates for each server the VM allocation and the instructions which are directly sent to the simulated data center manager.

Note that we do not explicitly model the brown power production as we assume it to be infinite (at the scale of the cloud). We also ignore the telecommunication network as we assume it to have negligible impact on the system functioning (we assume network to be oversized for our scenario), and an almost constant power consumption over time if no energy-saving technique is applied (Orgerie et al., 2014). Finally, we do not take into account here the energy consumed by the data centers' cooling systems.

In order to perform the simulations, we connect all these heterogeneous models using the MECSYCO (Multi-agent Environment for Complex-SYstem-CO-simulation) M&S platform (Camus et al., 2016a; Camus et al., 2016b) which is based on the DEVS (Discrete-Event System specification) formalism (Zeigler et al., 2000). We have defined a DEVS interface for DCSim, and implemented it in MECSYCO.

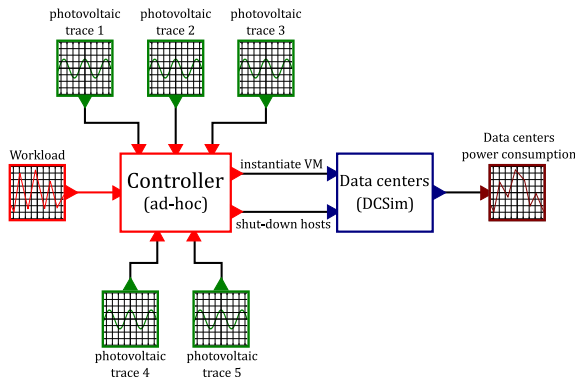

Figure 2: Bloc diagram view of the cloud model.

4.2 Data center simulation

Our cloud consists in five homogeneous data centers composed of five clusters. Each of these clusters contains 80 homogeneous nodes, so overall, the cloud comprises a total of 400 servers. The characteristics of each server are based on the Taurus servers of the French experimental testbed Grid’5000¹. These Taurus servers are equipped with 2 Intel Xeon E5-2630 CPU with 6 cores each, 32GB memory, 598GB storage and a 10 Gigabit Ethernet interface. In order to determine the power consumption of each node, we implement the power model of (Li et al., 2015), which is based on real measurements made on Taurus nodes. These measurements notably state that a Taurus server consumes 8W when powered OFF, 97W when idle, and 220W at 100% CPU load (i.e. $P_s = 220W$ for our algorithm).

Within this cloud, we deploy homogeneous VMs that are equivalent to the Amazon EC2 ”large” flavor² - i.e. each VM requires 4 CPU cores, 8GB memory and 80GB storage. Hence, three VMs can be simultaneously running on one node. For the sake of simplicity, we assume that, when deployed, a VM always works at full capacity. In the same way, we neglect the delays for the VM to start/stop. All the VMs are automatically deleted at the end of each time slot. A time slot lasts five minutes in our simulations.

4.3 Green power production

In order to feed the controller during the simulation, we use real recordings of green power production and real workload traces. We get the former from the Photovolta project³ of the University of Nantes. These recordings correspond to the power produced by a sin-

¹<https://www.grid5000.fr>

²<https://aws.amazon.com/ec2/>

³<http://photovolta2.univ-nantes.fr>

gle Sanyo HIP-240-HDE4 photovoltaic panel updated every five minutes over one week. In order to have heterogeneous trajectories between data centers (and thus to represent solar irradiance differences between sites spread across a country), we select recordings starting at different dates, namely: 4th of September 2016, 2nd of February 2014, 8th of June 2014, 22nd of June 2015 and 21st of December 2014. We consider here that 30 photovoltaic panels (for a surface of $165.6m^2$) are installed at each data center. Then we scale these photovoltaic signals accordingly.

4.4 Workload input

We use the normalized ClarkNet HTTP trace of (Tighe et al., 2012) for our cloud workload, shown in Figure 3. This workload trace spans over one week. We scale this workload to 98% of the cloud total capacity (i.e. the maximal workload peak represents 98% of the total computing capacity of the cloud). The trace peaks are synchronized with the photovoltaic signal ones to have proper day-night cycles in our simulation.

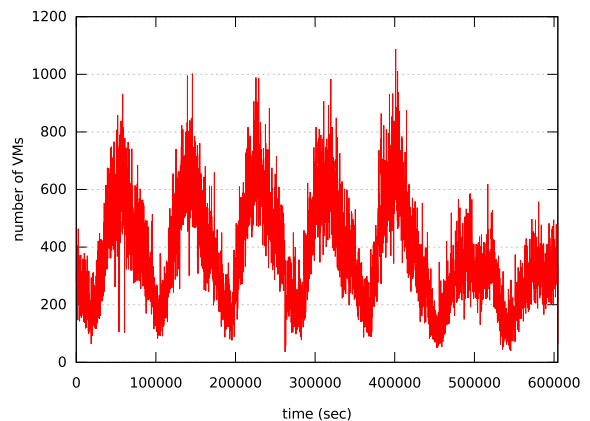

Figure 3: The input workload used in the experiments.

4.5 Algorithm implementation

The controller implementing our SAGITTA approach is run at each time slot (i.e. each five minutes). It saves all the data received from the green power sources during the current day. The controller computes at each time slot the standard deviations $p_i(t)$ using this history. It computes each expected green power production $Eg_i(t)$ by averaging a reference green power production trajectory (the Photovolta project recording of the 20th of August 2013 in our case which is the day with the best yield) scaled according to the last green power production received from i . More precisely, we denote $P_{ref}(t)$ the green

power production at corresponding hour the day of reference (see Figure 4). We obtain the following formula:

$$Eg_i(t) = \max\left(0, PV_i(t-1) + \frac{P_{ref}(t) - P_{ref}(t-1)}{2}\right).$$

Note that we consider with this formula that $Eg_i(t)$ is equal to the average between the green power production received at $t-1$ and the one estimated at t . Thus, we take into account that the green power trajectory changes *during* the time slot, and not only at its beginning.

For implementing the transfer decision algorithm, we use the reallocation constraint:

$$Z = (i < 1000) \wedge \left(\max_{1 \leq j \leq M} g_j - \min_{1 \leq k \leq M} c_k > 1 \right),$$

with i , the number of transfers (i.e. while-loop iterations) already performed for that time slot.

In order to minimize the number of ON/OFF cycles for the servers, the controller fills in priority the hosts already ON. Therefore, from a time slot to the next one, the controller keeps trace of the employed servers.

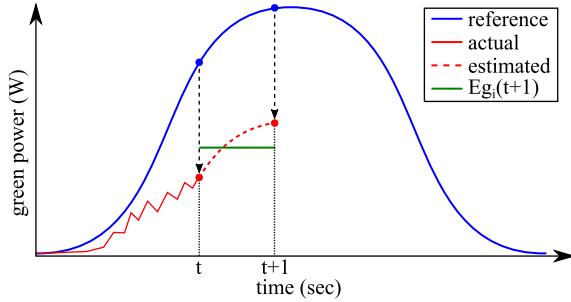

Figure 4: Expected green power production computation for a time slot from t to $t+1$.

4.6 Simulated approaches

We compare SAGITTA performance against two Round-Robin inspired algorithms:

- **Round-Robin-VM** distributes the VMs fairly between the data centers regardless their green power production.
- **Round-Robin-DC** starts filling with VMs the first data center (in an arbitrary predefined order). If this data center becomes full, the algorithm starts using the next one, and so on.

Like SAGITTA, these two algorithms employ in priority the nodes already ON.

As the performance of Round-Robin-DC strongly depends on the order of the data centers, we test two

opposite configurations corresponding to the best and the worst possible contexts. To define these contexts, we sort the photovoltaic traces according to the total amount of green energy they provide. We assign then the traces to the data centers following this order. The best context corresponds to the case where the photovoltaic traces are sorted in a decreasing order. Thus, the first data center (i.e. the one filled in priority) will be supplied by the best photovoltaic power trajectory. The worst context corresponds then to the case where the traces are sorted in an increasing order (i.e. the data center with the worst green power supply will always be filled first).

To properly evaluate the performance of the three algorithms, it is important to note that the green power available is not always sufficient to supply the cloud needs in our simulation. That is why we also compute the optimal cumulative brown energy consumption which corresponds to the best performance reachable regarding our cloud configuration. We determine this optimal performance based on the optimal brown power consumption of the cloud at time t , $P_B(t)$ given by the equation:

$$P_B(t) = \max\left(\left(P_{tot}(t) - \sum_{1 \leq i \leq M} \min(PV_i(t), P_S \times S_i)\right), 0\right),$$

with :

- $P_{tot}(t)$ the total power consumption of the cloud at time t ,
- $PV_i(t)$ the photovoltaic power production for DC_i at time t .

5 Results

Based on the simulation framework described in the previous section, several experiments were run to validate our proposed approach. First, simulations are conducted without switching ON/OFF costs (i.e. switching does not take time nor energy) to evaluate the allocation algorithms in an ideal context (Section 5.1). An optimal theoretical lower bound is determined this way. Then, new simulations are performed with switching costs in order to fairly compare SAGITTA against state-of-the-art approaches (Section 5.2). The influence of the transfer parameter Z is analyzed (Section 5.3), as well as the influence of the green energy forecast (Section 5.4). Various green production scenarios are studied to estimate the impact of green energy location on SAGITTA's performance (Section 5.5). Finally, the scalability of SAGITTA is evaluated by increasing the number of data centers (Section 5.6).

5.1 Without switching ON/OFF costs

We simulate the cloud behavior over one week. First, the power costs of switching ON/OFF the servers are not integrated in order to have a fair comparison with the ideal unreachable case (given by $P_B(t)$) which does not take into account these costs. Our simulation estimates that this cloud consumes a total of 4.96 MWh over the simulated week. Figure 5 shows the cumulative brown energy consumption of the cloud over time for the previously described scheduling algorithms. SAGITTA presents a consumption 4% above the ideal, and significantly better than Round-Robin-VM (28.8% above the optimal) and Round-Robin-DC (14.4% above the optimal in the best case, and 69.6% in the worst case).

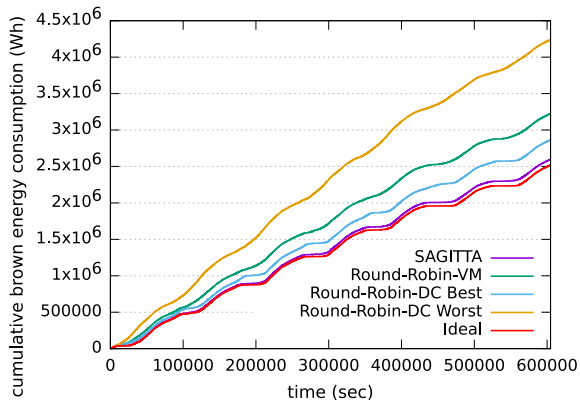

Figure 5: Cumulative brown energy consumption of the cloud generated by the different allocation approaches.

As shown in Table 2, SAGITTA stands out even more clearly from the other algorithms when considering the percentage of available green energy they waste. We compute these percentages based on the ratio of available green power wasted at time t , $W(t)$ given by the following equation:

$$W(t) = \frac{\left(\sum_{1 \leq i \leq M} \min(P_i(t) - PV_i(t), 0) \right) - P_B(t)}{P_{tot}(t) - P_B(t)}$$

With $P_i(t)$ the power consumption of DC_i .

Table 2: Percentage of total available green energy wasted.

| | SAGITTA | Round-Robin-VM | Round-Robin-DC |
|--------------|---------|----------------|----------------|
| Best | 3.14% | 28.83% | 14.15% |
| Worst | 3.14% | 28.83% | 70.27% |

It is worth noting that, due to its transfer decision (i.e. Algorithm 4), SAGITTA switches ON/OFF significantly more nodes than the other algorithms: 33,792 switches ON for SAGITTA against 29,606 switches ON for the other algorithms. This difference

on the number of switches should have an impact on the overall cloud power consumption. This effect is not visible in this first set of simulations (shown in Figure 5) as they ignore the nodes powering OFF/ON costs.

To sum up, compared to the ideal allocation, SAGITTA consumes 4% more brown energy and wastes 3.14% of green energy (while the ideal allocation does not waste any). For both criteria, green energy waste and brown energy consumption, SAGITTA outperforms traditional approaches based on round-robin allocation.

5.2 With switching ON/OFF costs

The second set of simulation integrates the switching ON/OFF costs and estimates their impact on the algorithms' energy consumption to reflect this point. Following the data collected by (Rais et al., 2016) on the Taurus cluster, we add a static energy consumption penalty of 5.28 Wh (consumed in 150 seconds) for each switch-ON command, and 0.56 Wh (consumed in 10 seconds) for each switch-OFF command sent. As shown in Table 3, even when considering these penalties, simulations show that SAGITTA performs better than the other solutions with a difference of at least 10%.

Table 3: Total cumulative brown energy consumption when including switching ON/OFF energy costs.

| | SAGITTA | Round-Robin-VM | Round-Robin-DC |
|--------------|----------|----------------|----------------|
| Best | 2.77 MWh | 3.38 MWh | 3.02 MWh |
| Worst | 2.77 MWh | 3.38 MWh | 4.4 MWh |

Figure 6 shows the power consumption over time of each data center in the simulated cloud using SAGITTA. This figure also shows the number of transfers made by Algorithm 4 – a negative (respectively positive) value meaning that the algorithm switches off (respectively on) hosts. This plot highlights the usefulness of the transfer algorithm. For instance, at time 173,700 s. which corresponds to early morning, DC 2 starts producing green energy slightly earlier than DC 0. SAGITTA takes then advantage of this situation by performing 24 transfers from DC 0 to DC 2. Transfers are highly correlated with discontinuities in the green power production trajectories. Thus, the transfer decision may enable adapting the VM allocation, and consequently the energy consumption, to unforeseen increases and decreases of the green power production. In the absence of transfer, the switch on and off decisions enable adapting the DC workload to their green power production - i.e. the data centers with higher power production are generally more used than the others.

For the sake of simplicity, in the following, we will consider the best case for the Round-Robin-DC algorithm (with data centers ranked by their overall green energy production). All the simulations in the next sections also include the switching ON/OFF costs.

5.3 Influence of the transfer parameter

Now, the influence of the transfer parameter is studied. When comparing with the previous simulations, for SAGITTA's case, the switching costs add 6.5% of the overall consumption. Concerning the difference between SAGITTA's power consumption and the other ones, the difference is reduced when taking into account the switching costs. This situation comes from the transfer decisions, and in particular from Z , the transfer decision criteria (used in Algorithm 4).

We redefine as follows the Z constraint in order for the transfer decision to take into account the switching energy costs:

$$Z = (i < 1000) \wedge \left(\left(\max_{1 \leq i \leq M} g_i - \min_{1 \leq j \leq M} c_j \right) \times \frac{300}{3600} > \alpha \right)$$

with α , the average brown energy cost of a transfer.

Figure 7 compiles the results of 74 simulations using different values of α . It shows that even when considering the switching ON/OFF penalties, SAGITTA performs better for all the α values with at least 2.77 MWh (and 2.75 MWh at best) of brown energy consumed against 3.38 MWh for Round-Robin-VM, and 3.02 MWh (respectively 4.4 MWh) for Round-Robin-DC in the best (respectively worst) context. However, one can note that, the transfer decision has a relatively small impact on SAGITTA overall performance: at best, it only saves up to 3.04 kWh of brown energy, and performs transfers only 5% of the time (in this case, it performs an average of 6 transfers per time slot). Moreover, we observe that, in the absence of a precise estimation of the green energy production, it is safer to overestimate α : then the risk is to lose the small benefit of the transfer decision. At the opposite, when α is underestimated, the transfer decision may degrade SAGITTA performance - i.e. it increases the brown power consumption (up to 19.83 kWh at worst) by inducing too many transfers. Thus α value is not inconsequential and should be properly set if transfers are considered.

5.4 Influence of the green energy forecast

One basis of the SAGITTA approach is the green energy production forecast. The value $Eg_i(t)$, namely the expected PV production in DC_i at time slot t is

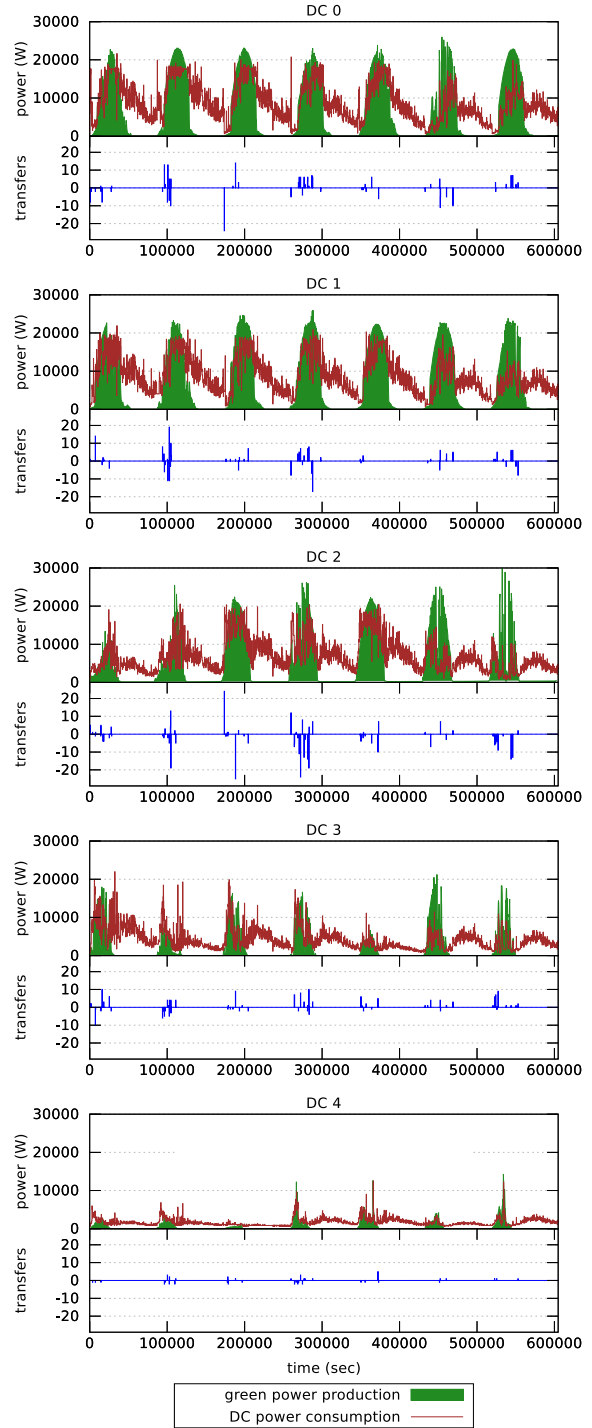

Figure 6: Power consumption per data center with SAGITTA and transfer decisions.

computed regarding the electricity production at time slot $t - 1$. This approach permits a simple computation for the value $Eg_i(t)$ to parametrize the probability law of green energy production. However, this

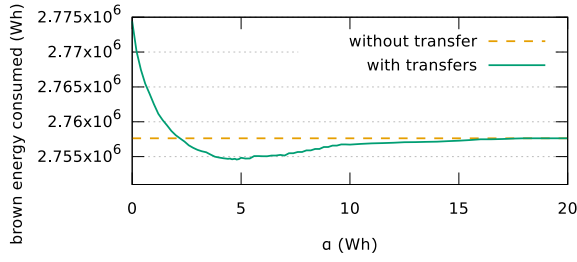

Figure 7: Impact of α estimation on SAGITTA performance.

formula estimates the electricity production regarding only the previous time slot, despite of the high volatility of solar energy. We experiment in this section an evaluation of $Eg_i(t)$ on a sliding window of PV production values. We target here the optimal size of the window, and the weight to give to the values of the different time slots of the window.

We propose several solutions to determine $Eg_i(t)$ on a sliding window of size s . For the sake of simplicity, we denote $g_i(t) = PV_i(t) - P_{ref}(t)$, with $P_{ref}(t)$ the daily production at same hour, the day of reference. We then make a weighted average value of values $g_i(t)$, with weight p_i :

$$Eg_i(t) = \max \left(0, \frac{PV_i(t-1) + \frac{\sum_{k=1}^s (g_i(t-k) \times p_{s-k})}{\sum_{k=1}^s p_k} + P_{ref}(t)}{2} \right).$$

The first variant CST1 uses constant weights $p_k = 1$ for recent and old values. In the second variant ADD1, the values of p_k increase linearly: $p_k = k + 1$. Finally, the values of p_k are multiplied by 2 at each step in PROD1: $p_k = 2^k$. In these variants, the computation includes values corresponding to the night, when $PV_i(t)$ and $P_{ref}(t)$ are both null. This impacts the estimation with useless values. Then, in variants CST2, ADD2 and PROD2, all values $g_i(t)$ corresponding to $P_{ref}(t) = 0$ are removed from the computation. Results of these computations are detailed in Figure 8. Denote that in this experiments, the optimal value of α determined in Section 5.3 is applied.

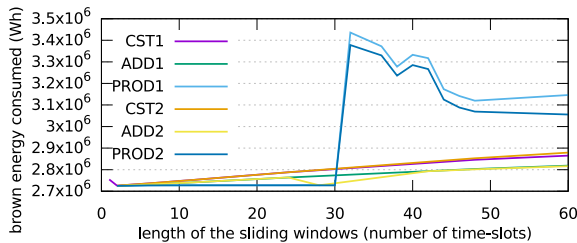

Figure 8: Influence of Eg_i estimation.

The first unexpected result is the very low values of the optimal size of the sliding window. Regardless of the variant, the best size of the window is always

2, with a slight reduction of the brown energy consumed. The good performance of algorithms PROD1 and PROD2 can be related to the large weight given to the earliest production values in the computation. The weight given to early values has indeed a large impact on the variants' performance.

5.5 Influence of green energy production

Cloud providers need to adequately dimension their on-site photovoltaic panel farms. This issue involves a trade-off between the financial cost of installing and operating photovoltaic panels, and the financial gains they are bringing in terms of green energy produced and thus, electricity that has not to be bought from the regular grid. We perform a set of experiments to determine the influence of green energy production on SAGITTA performance. As shown in Figure 9, the number of photovoltaic panels (PV) varies per data center and the total brown power consumption is recorded over one week. We can see that, as soon as green energy is available, SAGITTA consumes clearly less brown energy than the other approaches.

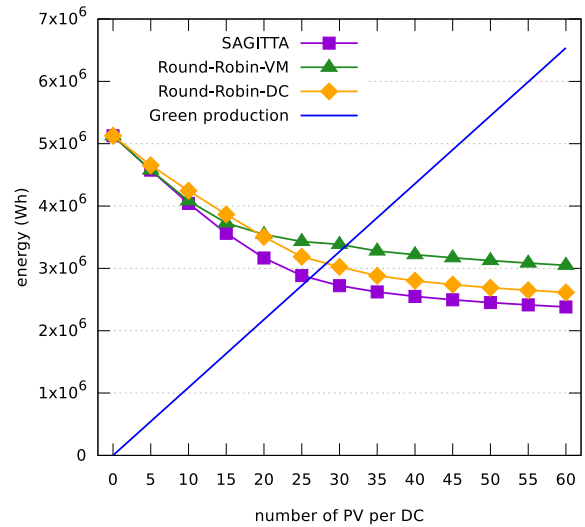

Figure 9: Influence of green energy production on brown energy consumption.

Figure 9 also shows that up to about 25 photovoltaic panels, the brown energy consumption curves have a steeper slope, leading to higher gains per photovoltaic panels. For more than 25 photovoltaic panels, the energy gains are lower per added panel. When reaching 45 panels, the green energy production exceeds the total energy consumption of the data center (represented by the case with 0 panel). However, this

Table 4: The considered cloud scenarios with increasing number of data centers.

| Number of data centers | 5 | 10 | 15 | 20 | 25 | 30 | 35 | 40 |
|------------------------------------------------|-----|-----|-----|-----|-----|-----|-----|-----|
| Total number of nodes | 400 | 400 | 400 | 400 | 400 | 400 | 400 | 400 |
| Number of photovoltaic panels per data centers | 30 | 14 | 9 | 7 | 6 | 5 | 4 | 3 |

production is concentrated during the day (as shown in Figure 6), whereas the workload, and consequently the energy consumption, spans over the day and the night. Thus, when reaching a number of photovoltaic panels whose production covers most of the Cloud energy consumption during daylight, adding panels can only save the energy consumption peaks at the beginning and the end of the day (when panels produce less energy), and their buying cost can thus exceed the monetary gains they generate.

5.6 Scalability of SAGITTA

In order to check if the SAGITTA’s energy savings scale up, we simulate the power consumption of distributed clouds with a larger number of data centers. For these different clouds, we progressively increase the number of data centers, and so the number of green power sources (still taken from the Photovolta project), while maintaining the same total number of nodes (and so an unchanged input workload). The total photovoltaic energy production is also kept as steady as possible by progressively decreasing the number of photovoltaic panels per data centers. Yet we decided not to consider fractions of panels, so the number of panels slightly varies between the scenarios to keep whole numbers. The compositions of these clouds are summed up in Table 4.

As shown in Figure 10, the simulation results disclose that SAGITTA scales up: it maintains its energy gains in larger clouds, and always consumes less brown energy than the other approaches. From a computing time point of view, in our simulation environment, it takes 9 seconds to execute SAGITTA over the whole workload trace (representing one week) for the case with 5 data centers, and 28 seconds for the case with 40 data centers. While this computing time is increased by a factor of 3 (when increasing the data center number by a factor of 8), it still remains inconsequential for the scalability of SAGITTA.

6 CONCLUSION

In this paper, we propose SAGITTA: a Stochastic Approach for Green consumption In disTributed daTA centers. It aims at allocating virtual machines in an energy-efficient way for a distributed cloud comprising several data centers that are geographically dis-

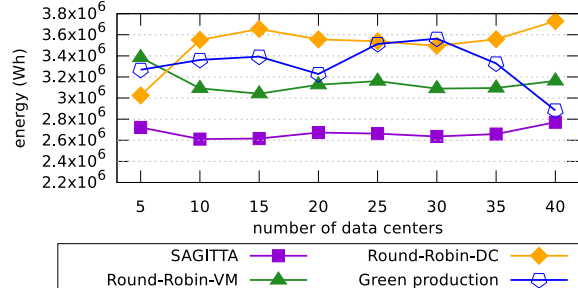

Figure 10: Brown energy consumption of SAGITTA with increasing number of data centers.

tributed and that embed on-site photovoltaic panels. To reduce brown energy consumption, SAGITTA employs a stochastic approach to estimate the expected green energy consumption and to adequately allocate virtual machines on data centers depending on their green energy production. It also switches off unused servers to save energy, while taking into account the energy cost of switching on and off servers.

We conducted a simulation-based evaluation using real workload traces, wattmeter measurements on tested servers and real production traces from photovoltaic panels. Traditional approaches do not consider the expected green energy consumption for taking virtual machine allocation decisions in distributed clouds. As a consequence, they may overestimate the green energy availability – and take non-efficient scheduling decisions – or underestimate it, and thus waste this energy. The results show that SAGITTA can allocate virtual machines in a more energy-efficient way than traditional approaches, like round-robin. In particular, it wastes only 3.14% of green energy when not considering the switching on/off energy costs. It also exhibits good results in terms of brown energy consumption with a difference of 4% with the optimal when not considering the switching on/off energy costs. When considering the switching on/off energy costs, SAGITTA consumes 10% more brown energy than the theoretical lower bound, which is the ideal allocation not taking into account the switching on/off energy costs. We study the influence of the green energy production on SAGITTA’s energy gains and show that, in all cases, it outperforms traditional approaches. The results also show that SAGITTA can smoothly scale with the number of data centers belonging to the cloud.

We plan to extend this work by considering the

impact of network devices on the energy consumption and integrating the ability to dynamically migrate virtual machines from one site to another.

ACKNOWLEDGEMENTS

The authors would like to thank Yunbo Li for the energy traces of real datacenter servers. The authors would also like to thank Matthieu Simonin and Nathalie Bertrand for their proofreading of the mathematical proofs. This work has been supported by the Inria exploratory research project COSMIC (Coordinated Optimization of SMART grids and Clouds).

REFERENCES

- Barham, P., Dragovic, B., Fraser, K., Hand, S., Harris, T., Ho, A., Neugebauer, R., Pratt, I., and Warfield, A. (2003). Xen and the Art of Virtualization. In *ACM Symposium on Operating Systems Principles (SOSP)*, pages 164–177.
- Callau-Zori, M., Samoila, L., Orgerie, A.-C., and Pierre, G. (2016). An experiment-driven energy consumption model for virtual machine management systems. Technical Report 8844, Inria.
- Camus, B., Galtier, V., Caujolle, M., Chevrier, V., Vaubourg, J., Ciarletta, L., and Bourjot, C. (2016a). Hybrid Co-simulation of FMUs using DEV&DESS in MECSYCO. In *Proceedings of the Symposium on Theory of Modeling & Simulation - DEVS Integrative M&S Symposium*.
- Camus, B., Paris, T., Vaubourg, J., Presse, Y., Bourjot, C., Ciarletta, L., and Chevrier, V. (2016b). MECSYCO: a Multi-agent DEVS Wrapping Platform for the Co-simulation of Complex Systems. Research report, LORIA, UMR 7503, Université de Lorraine, CNRS, Vandoeuvre-lès-Nancy ; Inria Nancy - Grand Est (Villers-lès-Nancy, France).
- Deng, W., Liu, F., Jin, H., Li, B., and Li, D. (2014). Harnessing renewable energy in cloud datacenters: opportunities and challenges. *IEEE Network*, 28(1):48–55.
- Fan, X., Weber, W.-D., and Barroso, L. A. (2007). Power provisioning for a warehouse-sized computer. In *ACM International symposium on Computer architecture (ISCA)*, pages 13–23.
- Figuerola, S., Lemay, M., Reijs, V., Savoie, M., and St. Arnaud, B. (2009). Converged Optical Network Infrastructures in Support of Future Internet and Grid Services Using IaaS to Reduce GHG Emissions. *Journal of Lightwave Technology*, 27(12):1941–1946.
- Greenpeace (2011). How dirty is your data? Greenpeace report.
- Katz, R. H. (2009). Tech Titans Building Boom. *IEEE Spectrum*, 46(2):40–54.
- Koomey, J. (2011). Growth in Data Center Electricity Use 2005 to 2010. Analytics Press.
- Li, Y., Orgerie, A.-C., and Menaud, J.-M. (2015). Opportunistic Scheduling in Clouds Partially Powered by Green Energy. In *IEEE International Conference on Green Computing and Communications (GreenCom)*.
- Miyoshi, A., Lefurgy, C., Van Hensbergen, E., Rajamony, R., and Rajkumar, R. (2002). Critical power slope: understanding the runtime effects of frequency scaling. In *ACM International conference on Supercomputing (ICS)*, pages 35–44.
- Orgerie, A.-C., Dias de Assunção, M., and Lefèvre, L. (2014). A Survey on Techniques for Improving the Energy Efficiency of Large-Scale Distributed Systems. *ACM Computing Surveys (CSUR)*, 46(4):47:1–47:31.
- Rais, I., Orgerie, A.-C., and Quinson, M. (2016). Impact of Shutdown Techniques for Energy-Efficient Cloud Data Centers. In *International Conference on Algorithms and Architectures for Parallel Processing (ICA3PP)*, Granada, Spain.
- Ren, S., He, Y., and Xu, F. (2012). Provably-Efficient Job Scheduling for Energy and Fairness in Geographically Distributed Data Centers. In *IEEE International Conference on Distributed Computing Systems (ICDCS)*, pages 22–31.
- Shehabi, A., Smith, S., Horner, N., Azevedo, I., Brown, R., Koomey, J., Masanet, E., Sartor, D., Herrlin, M., and Lintner, W. (2016). United States Data Center Energy Usage Report. Technical report, Lawrence Berkeley National Laboratory.
- Snowdon, D., Ruocco, S., and Heiser, G. (2005). Power Management and Dynamic Voltage Scaling: Myths and Facts. In *Workshop on Power Aware Real-time Computing*.
- Talaber, R., Brey, T., and Lamers, L. (2009). Using Virtualization to Improve Data Center Efficiency. Technical report, The Green Grid.
- Tighe, M., Keller, G., Bauer, M., and Lutfiyya, H. (2012). DCSim: A data centre simulation tool for evaluating dynamic virtualized resource management. In *Workshop on Systems Virtualization Management (colocated with CNSM)*, pages 385–392.
- Tripathi, R., Vignesh, S., and Tamarapalli, V. (2016). Optimizing Green Energy, Cost, and Availability in Distributed Data Centers. *IEEE Communications Letters*.
- Wang, D., Ren, C., Sivasubramaniam, A., Urgaonkar, B., and Fathy, H. (2012). Energy storage in datacenters: What, where, and how much? In *ACM SIGMETRICS/PERFORMANCE Joint International Conference on Measurement and Modeling of Computer Systems*, pages 187–198.
- Wang, L., Tao, J., Kunze, M., Castellanos, A., Kramer, D., and Karl, W. (2008). Scientific Cloud Computing: Early Definition and Experience. In *IEEE International Conference on High Performance Computing and Communications (HPCC)*, pages 825–830.
- Zeigler, B., Praehofer, H., and Kim, T. (2000). *Theory of Modeling and Simulation: Integrating Discrete Event and Continuous Complex Dynamic Systems*. Academic Press.